

TravelMate 7000

User's Manual

Copyright

Copyright © 1997 by Acer Incorporated. All rights reserved. No part of this publication may be reproduced, transmitted, transcribed, stored in a retrieval system, or translated into any language or computer language, in any form or by any means, electronic, mechanical, magnetic, optical, chemical, manual or otherwise, without the prior written permission of Acer Incorporated.

Disclaimer

Acer Incorporated makes no representations or warranties, either expressed or implied, with respect to the contents hereof and specifically disclaims any warranties, merchantability or fitness for any particular purpose. Any Acer Incorporated software described in this manual is sold or licensed "as is". Should the programs prove defective following their purchase, the buyer (and not Acer Incorporated, its distributor, or its dealer) assumes the entire cost of all necessary servicing, repair, and any incidental or consequential damages resulting from any defect in the software. Further, Acer Incorporated reserves the right to revise this publication and to make changes from time to time in the contents hereof without obligation of Acer Incorporated to notify any person of such revision or changes.

Acer is a registered trademark of Acer Incorporated. Microsoft, MS-DOS, Windows and Windows 95 are registered trademarks of Microsoft Corporation. IBM and OS/2 are registered trademarks of IBM Corporation. Intel and Pentium are registered trademarks of Intel Corporation. Other brand and product names are trademarks and/or registered trademarks of their respective companies.

IMPORTANT SAFETY INSTRUCTIONS

1. Read these instructions carefully. Save these instructions for future reference.
2. Follow all warnings and instructions marked on the product.
3. Unplug this product from the wall outlet before cleaning. Do not use liquid cleaners or aerosol cleaners. Use a damp cloth for cleaning.
4. Do not use this product near water.
5. Do not place this product on an unstable cart, stand, or table. The product may fall, causing serious damage to the product.
6. Slots and openings in the cabinet and the back or bottom are provided for ventilation; to ensure reliable operation of the product and to protect it from overheating, these openings must not be blocked or covered. The openings should never be blocked by placing the product on a bed, sofa, rug, or other similar surface. This product should never be placed near or over a radiator or heat register, or in a built-in installation unless proper ventilation is provided.
7. This product should be operated from the type of power indicated on the marking label. If you are not sure of the type of power available, consult your dealer or local power company.
8. Do not allow anything to rest on the power cord. Do not locate this product where persons will walk on the cord.
9. If an extension cord is used with this product, make sure that the total ampere rating of the equipment plugged into the extension cord does not exceed the extension cord ampere rating. Also, make sure that the total rating of all products plugged into the wall outlet does not exceed the fuse rating.
10. Never push objects of any kind into this product through cabinet slots as they may touch dangerous voltage points or short out parts that could result in a fire or electric shock. Never spill liquid of any kind on the product.

11. Do not attempt to service this product yourself, as opening or removing covers may expose you to dangerous voltage points or other risks. Refer all servicing to qualified service personnel.
12. Unplug this product from the wall outlet and refer servicing to qualified service personnel under the following conditions:
 - a. When the power cord or plug is damaged or frayed
 - b. If liquid has been spilled into the product
 - c. If the product has been exposed to rain or water
 - d. If the product does not operate normally when the operating instructions are followed. Adjust only those controls that are covered by the operating instructions since improper adjustment of other controls may result in damage and will often require extensive work by a qualified technician to restore the product to normal condition.
 - e. If the product has been dropped or the cabinet has been damaged
 - f. If the product exhibits a distinct change in performance, indicating a need for service
13. Replace battery with the same type as the product's battery we recommend. Use of another battery may present a risk of fire or explosion. Refer battery replacement to a qualified serviceman.
14. Warning! Battery may explode if not handled properly. Do not recharge, disassemble or dispose of in fire. Keep away from children and dispose of used battery promptly.
15. Use only the proper type of power supply cord set (provided in your accessories box) for this unit. It should be a detachable type: UL listed/CSA certified, type SPT-2, rated 7A 125V minimum, VDE approved or its equivalent. Maximum length is 15 feet (4.6 meters).

Concerning Lithium Batteries

ADVARSEL!

Lithiumbatteri - Eksplosionsfare ved fejlagtig håndtering.
Udskiftning må kun ske med batteri af samme fabrikat og type.
Léver det brugte batteri tilbage til leverandøren.

A D V A R S E L

Eksplosjonsfare ved feilaktig skifte av batteri.
Benytt samme batteritype eller en tilsvarende
type anbefalt av apparatfabrikanten.
Brukte batterier kasseres i henhold til fabrikantens instruksjoner.

VARNING

Explosionsfara vid felaktigt batteribyte.
Använd samma batterityp eller en ekvivalent typ som
rekommenderas av apparattillverkaren.
Kassera använt batteri enligt fabrikantens instruktion

VAROITUS

Päristo voi räjähtää, jos se on virheellisesti asennettu.
Vaihda paristo ainoastaan laitevalmistajan suosittelemaan tyyppiin.
Hävitä käytetty paristo valmistajan ohjeiden mukaisesti.

Canadian Department of Communications

Regulatory Statement

This digital apparatus does not exceed Class B limits for radio noise emissions from digital apparatus set out in the Radio Interference Regulations of the Canadian Department of Communications.

Le présent appareil numérique n'émet pas de bruits radio-électriques dépassant les limites applicables aux appareils numériques de la classe B prescrites dans le Règlement sur le brouillage radioélectrique édicté par le ministère des Communications du Canada.

FCC Class B Radio Frequency Interference Statement

Note:

This equipment has been tested and found to comply with the limits for a Class B digital device, pursuant to Part 15 of FCC Rules. These limits are designed to provide reasonable protection against harmful interference in a residential installation. This equipment generates, uses, and can radiate radio frequency energy and, if not installed and used in accordance with the instructions, may cause harmful interference to radio communications. However, there is no guarantee that interference will not occur in a particular installation. If this equipment does cause harmful interference to radio or television reception, which can be determined by turning the equipment off and on, the user is encouraged to try to correct the interference by one or more of the following measures:

1. Reorient or relocate the receiving antenna.
2. Increase the separation between the equipment and receiver.
3. Connect the equipment into an outlet on a circuit different from that to which the receiver is connected.
4. Consult the dealer or an experienced radio/television technician for help.

Notice 1:

The changes or modifications not expressly approved by the party responsible for compliance could void the user's authority to operate the equipment.

Notice 2:

Shielded interface cables, if any, must be used in order to comply with the emission limits.

About This Manual

Purpose

This manual discusses the features of the notebook and tells how to use and configure it.

Manual Structure

This manual consists of eight chapters and two appendices:

Chapter 1, *Getting Started*, tells you how to get started with the notebook.

Chapter 2, *System Tour*, gives a guided and in-depth “tour” of the notebook and its features.

Chapter 3, *Power*, discusses issues on battery use and includes information on the unique power management system.

Chapter 4, *Options*, tells how to connect and install hardware options.

Chapter 5, *Software*, describes how to configure certain utilities and applications.

Chapter 6, *Setup*, explains how to configure the system with the BIOS Setup utility.

Chapter 7, *Traveling with the Notebook*, includes informative and useful tips on travel.

Chapter 8, *Troubleshooting*, lists the steps you can take to resolve problems in an easy Q&A format.

Appendix A, *Specifications*, lists the specifications of the notebook.

Appendix B, *Address and Interrupt Tables*, shows the address and interrupt tables.

Conventions

The following conventions are used in this manual:





<code>C:\setup, [Enabled], etc.</code>	Represent text input by the user, default settings and recommended selections
<code>message displayed</code>	Denotes actual messages that appear on screen
<code>b,e,r, etc</code>	Represent the actual keys that you have to press on the keyboard
	NOTE Gives bits and pieces of additional information related to the current topic
	WARNING Alerts you if damage may result from doing or not doing specific actions
	CAUTION Gives precautionary measures to avoid possible hardware or software problems
	IMPORTANT Reminds you to take action relevant to the accomplishment of the procedure at hand
	TIP Tells how to complete a procedure with minimum steps through little shortcuts

Table of Contents

1 Getting Started

1.1	Item Checklist	1-2
1.2	Taking Care of Your Computer.....	1-3
1.2.1	Notebook.....	1-3
1.2.2	AC Adapter.....	1-6
1.2.3	Battery Pack.....	1-6
1.2.4	Cleaning and Servicing.....	1-7
1.2.5	Diskettes.....	1-7
1.3	Connecting the Notebook.....	1-9
1.4	Getting Help Online.....	1-10

2 System Tour

2.1	Features.....	2-2
2.2	Display.....	2-4
2.3	Indicator Lights.....	2-7
2.4	Keyboard	2-8
2.4.1	Keyboard Layout.....	2-8
2.4.2	Special Keys.....	2-9
2.4.3	Automatic Tilt Feature	2-16
2.4.4	Palm Rest.....	2-17
2.5	Touchpad.....	2-18

2.6	Storage	2-20
2.6.1	Hard Disk.....	2-20
2.6.2	Module Bay	2-20
2.7	Ports	2-23
2.7.1	Left Panel Ports.....	2-23
2.7.2	Rear Panel Ports	2-26
2.8	Audio	2-28
2.8.1	Built-in Speakers and Microphone	2-28
2.8.2	Controlling the Audio	2-29
2.9	Communications	2-30
2.9.1	Serial Infrared.....	2-30
2.9.2	Fax/Data Modem.....	2-31
2.10	Securing your Notebook.....	2-32
2.10.1	Security Notch	2-32
2.10.2	System Resource Lock	2-32

3 Power

3.1	Battery Power	3-2
3.1.1	Battery Pack Characteristics	3-2
3.1.2	Removing and Installing the Battery Pack.....	3-3
3.1.3	Charging the Battery.....	3-4
3.1.4	Checking the Battery Level.....	3-5
3.1.5	Optimizing Battery Life	3-7
3.1.6	Battery Low Condition.....	3-8

3.2	Power Management	3-10
3.2.1	The Concept of Heuristics.....	3-10
3.2.2	Suspend Modes.....	3-11
3.2.3	Advanced Power Management (APM)	3-14

4 Options

4.1	External Monitor.....	4-2
4.2	External Keyboard.....	4-3
4.3	External Keypad.....	4-4
4.4	External Pointing Device.....	4-5
4.5	Printer.....	4-7
4.6	Audio Devices.....	4-8
4.7	Mini Dock.....	4-9
4.8	PC Cards	4-9
4.9	Miscellaneous Options	4-10
4.9.1	Additional Power Packs	4-10
4.9.2	Cables	4-12
4.10	Key Component Upgrades	4-14
4.10.1	Additional Memory.....	4-14
4.10.2	Hard Disk.....	4-16

5 Software

5.1	System Software	5-2
5.2	Sleep Manager	5-3
5.2.1	Accessing the Sleep Manager	5-3
5.2.2	Sleep Manager Functions	5-5
5.2.3	Running Sleep Manager	5-8
5.2.4	Sleep Manager Troubleshooting Tips	5-9
5.2.5	Uninstalling Sleep Manager	5-10
5.3	Touchpad Driver	5-12
5.3.1	Configuring the Touchpad	5-12

6 Setup

6.1	When to Use Setup	6-2
6.2	Entering Setup	6-3
6.3	About My Computer	6-4
6.4	System Configuration	6-7
6.4.1	Date and Time	6-7
6.4.2	Diskette Drives	6-8
6.4.3	Hard Disks	6-8
6.4.4	Num Lock After Boot	6-8
6.4.5	LCD Expansion Mode	6-8
6.4.6	Internal Cache	6-10
6.4.7	External Cache	6-11
6.4.8	Enhanced IDE Features	6-11
6.4.9	Onboard Communication Ports	6-12

6.4.10	Onboard Audio	6-15
6.4.11	Reset PnP Resources.....	6-16
6.5	Power Saving Options.....	6-17
6.5.1	When Lid is Closed.....	6-18
6.5.2	Suspend to Disk on Critical Battery.....	6-19
6.5.3	Display Always On.....	6-19
6.5.4	Internal Speaker	6-19
6.5.5	External Mouse Location	6-19
6.5.6	Internal Modem	6-20
6.5.7	Resume On Modem Ring	6-20
6.5.8	Resume On Schedule.....	6-20
6.5.9	Resume Date / Resume Time.....	6-20
6.6	System Security	6-21
6.6.1	Supervisor and User Passwords	6-22
6.6.2	Diskette Drive Control.....	6-23
6.6.3	Hard Disk Drive Control.....	6-24
6.6.4	Start Up Sequences.....	6-24
6.6.5	Flash New BIOS.....	6-25
6.7	Reset to Default Settings.....	6-26

7 Traveling with the Notebook

7.1	Travel Preparations.....	7-2
7.2	International Traveler's Warranty	7-3
7.3	Worldwide Support.....	7-6

8 Troubleshooting

8.1	Q & A.....	8-2
8.2	POST Error Messages	8-7

A Specifications

B Address and Interrupt Tables

B.1	System Memory Map	B-1
B.2	I/O Address Map	B-2
B.3	Interrupt Levels	B-3
B.4	DMA Channels.....	B-3

List of Figures

1-1	Write-protecting a 3.5-inch Diskette	1-8
2-1	Display	2-5
2-2	Indicator Lights.....	2-7
2-3	Keyboard Layout	2-8
2-4	Palm Rest	2-17
2-5	Touchpad.....	2-18
2-6	Module Bay	2-20
2-7	Left Panel Ports	2-23
2-8	Rear Panel Ports.....	2-26
2-9	Built-in Speakers and Microphone	2-28
4-1	Connecting an External Monitor	4-2
4-2	Connecting an External Keyboard	4-3
4-3	Connecting an External Keypad	4-4
4-4	Connecting an External Pointing Device	4-5
4-5	Connecting a Parallel Printer.....	4-7
4-6	Connecting Audio Devices	4-8
4-7	Mini Dock.....	4-9
4-8	Using the File Transfer Cable.....	4-13

List of Tables

2-1	Indicator Status Descriptions	2-7
2-2	Lock Key Descriptions	2-9
2-3	Using the Embedded Keypad	2-10
2-4	Windows 95 Key Descriptions	2-11
2-5	Hot Key List	2-12
2-6	Eject Menu Descriptions.....	2-15
2-7	Touchpad Functions.....	2-19
2-8	Left Panel Port Descriptions	2-24
2-9	Rear Panel Port Descriptions	2-27
2-10	Audio Control Hot Keys	2-29
3-1	Battery-level Chart	3-6
3-2	Course of Action for Battery-low Condition	3-9
4-1	Memory Configurations	4-14
4-2	Hard Disk List.....	4-16
5-1	Sleep Manager Window Items.....	5-4
5-2	Sleep Manager Error Messages and Solutions	5-9
6-1	About My Computer Item Descriptions	6-5
6-2	Diskette Drive Control Settings.....	6-23
6-3	Hard Disk Drive Control Settings.....	6-24
6-4	Start Up Sequences Settings.....	6-24

8-1 POST Error Messages 8-7

Getting Started

Congratulations on your purchase of the award-winning TravelMate 7000 notebook computer. Guaranteed and backed by Acer's world-class support, you can be sure of top-notch performance with your new AcerNote. This chapter guides you through the first few steps on setting up your notebook computer.

1.1 Item Checklist

Carefully unpack the carton and remove the contents. If any of the following items is missing or damaged, contact your dealer immediately.

- Notebook computer
- Accessory box
 - AC adapter
 - Battery pack
 - Floppy drive module
 - External floppy drive cable
 - User's manual and other documentation

Check for optional items, if any.

1.2 Taking Care of Your Computer

Your computer will serve you well if you take care of it. This section tells you how to care for the notebook. Also, re-read the important safety instructions at the beginning of this manual.

1.2.1 Notebook

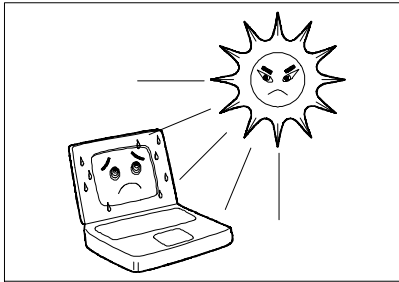

- Do not expose the notebook to direct sunlight. Do not place near sources of heat, such as a radiator.

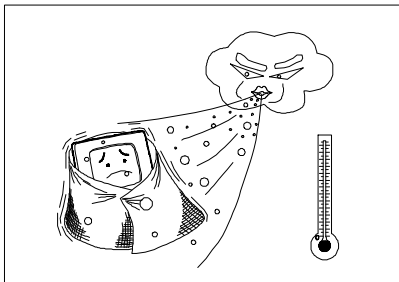

- Do not expose to temperatures below 0°C (32°F)

or

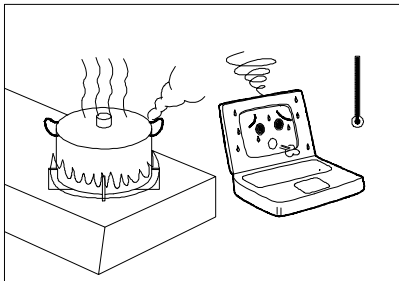

above 50°C (122°F).

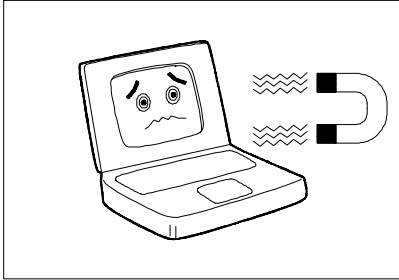

- Do not subject the notebook to magnetic fields.

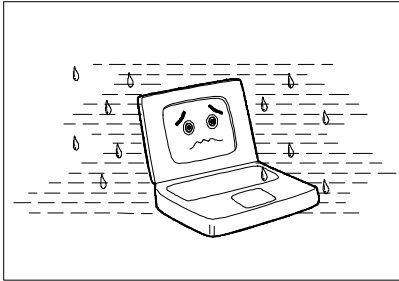

- Do not expose the notebook to rain or moisture.

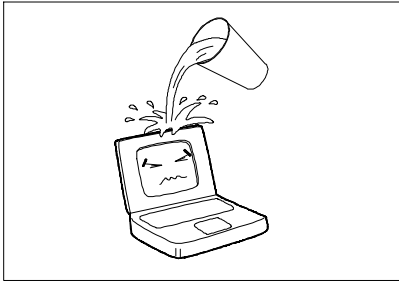

- Do not spill water on the notebook.

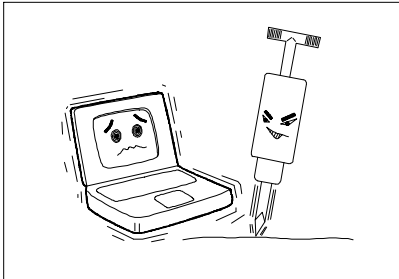

- Do not subject the computer to heavy shock and vibration.

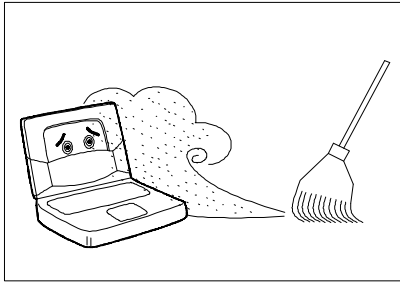

- Do not expose the notebook to dust and dirt.

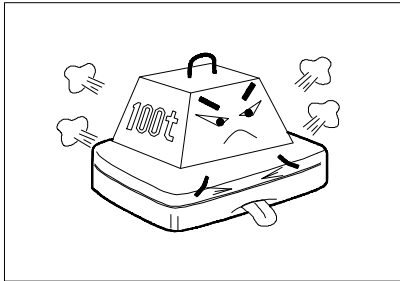

- Never place objects on top of the notebook to avoid damaging the notebook.

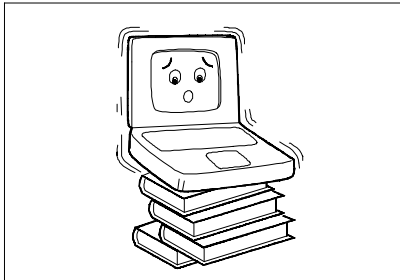

- Never place the notebook on uneven surfaces.

1.2.2 AC Adapter

The AC adapter provides uninterrupted power to your notebook and charges your battery pack. Here are some ways of taking care of your AC adapter.

- Do not connect the adapter to any other device.
- Do not step on the power cord or place heavy objects on top of it. Carefully route the power cord and any cables away from personal traffic.
- When unplugging the power cord, pull on the plug and not on the cord itself.

1.2.3 Battery Pack

The long-lasting Lithium-Ion (Li-Ion) rechargeable battery pack gives you power on-the-go. Here are some things to keep in mind regarding your battery pack.

Caution:

- Replace the battery pack with the same type (Model Name: BTP-S31)
- Battery pack is suitable for use only with this notebook model
- Burn hazard. Do not disassemble. Handle damaged or leaking lithium-ion battery with extreme care. If the battery is damaged, electrolyte may leak from the cells and may cause personal injury.
- There may be local restrictions on the disposal or recycling of batteries; consult your local regulations or waste disposal provider.
- Do not expose to high temperatures (50°C / 122°F)

1.2.4 Cleaning and Servicing

When cleaning the notebook, follow these steps:

1. Close the display lid to turn the notebook off.
2. Disconnect the AC adapter.
3. Remove the battery pack.
4. Use a soft cloth moistened with water. Do not use liquid or aerosol cleaners.

Contact your dealer or see your service technician if any of the following occurs:

- Notebook has been dropped or damaged.
- Liquid has been spilled into the product.
- The notebook does not operate normally.

See section 7.3 for contact information.

1.2.5 Diskettes

Following are some tips on diskette management:

- Always make backup copies of diskettes that contain important data or program files.
- Keep diskettes away from magnetic fields and sources of heat.
- Avoid removing a diskette from a drive when the floppy drive activity light is on.

- Write-protect your diskettes to prevent accidental erasure. To do this, slide the write-protect tab to the write-protect position.

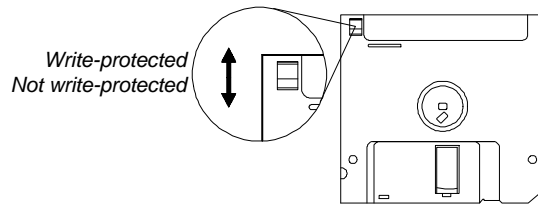
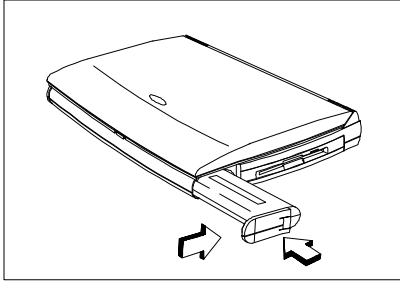

Figure 1-1 Write-protecting a 3.5-inch Diskette

- When you put a label on a 3.5-inch diskette, make sure that the label is properly attached (flat on the surface) and within the labelling area (area with slight surface depression) on the diskette. An improperly attached label may cause a diskette to get stuck in the drive when you are inserting or removing it.

1.3 Connecting the Notebook

After reading through the previous section, you are now ready to experience your new notebook. Connecting the notebook is as easy as 1-2-3.



Inserting the Battery Pack

Insert the battery pack into the battery compartment and slide the battery compartment cover in place.

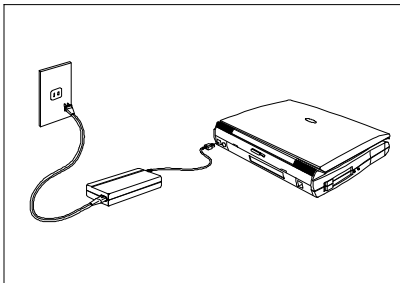

Connecting the AC Adapter

Connect one end of the AC adapter to the DC-in port on the notebook's rear panel and the other end to a properly grounded power outlet.

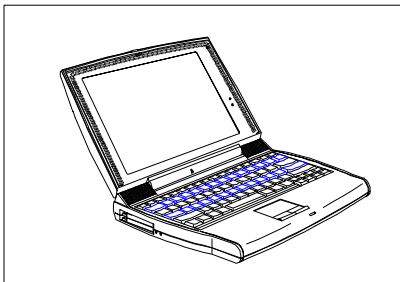

Turning on the Power

Slide the display cover latch to the right and open the display to turn on the power.

1.4 Getting Help Online

This user's manual provides clear and concise information about the notebook, so read it thoroughly. To provide you with help when traveling, the notebook has a comprehensive online help.

Accessing Online Help

Follow these steps to access the online documentation:

1. Press the Windows logo button or Click on the Start button.
2. Select Programs.
3. Click on TravelMate 7000.
4. Select Online Manual.

The online help is easy to navigate with hypertext and hypergraphics. Clear illustrations help describe notebook operation as well.

Getting Online

If you are connected to the Internet and have World Wide Web access, visit our home page (<http://www.acer.com/>) and get the latest information about our products, as well as updates on software drivers and utilities.

System Tour

This notebook combines high-performance, versatility, multimedia capabilities and a truly advanced power management system in a unique human-centric and stylish design case. Work with unmatched productivity and reliability with your new power computing partner.

This chapter gives an in-depth “tour” of the notebook’s many features.

2.1 Features

The notebook looks as good inside as it is outside, definitely designed with the user in mind. Here are just a few of the notebook's many features:

Performance

- High-end mobile Pentium microprocessor
- 64-bit main memory and 256KB external (L2) cache memory
- Large display in DualScan STN or active-matrix TFT
- PCI local bus video with 128-bit graphics accelerator
- Flexible module bay (3.5-inch floppy drive or CD-ROM drive)
- High-capacity, Enhanced-IDE hard disk
- Heuristic power management with suspend-to-memory and zero-volt suspend-to-disk power-saving modes
- Lithium-Ion smart battery pack
- High speed connectivity
- 16-bit stereo audio with built-in FM synthesizer
- Built-in microphone and dual angled stereo speakers
- 30fps (frames per second) full-screen, true-color MPEG video playback
- Infrared wireless communication
- Internal 28.8Kbps modem¹ with DSVD (digital simultaneous voice over data) support; with speakerphone and telephone answering device features

¹ This feature is available only in the U.S.

Human-Centric Design and Ergonomics

- Intuitive FlashStart automatic power-on
- Sleek, smooth and stylish design
- Automatic tilt-up, full-sized, full-function keyboard
- Wide and comfortable palm rest
- Ergonomically-centered touchpad pointing device

Expansion

- PC Card (formerly PCMCIA) slots (two type II/I or one type III)
- Mini dock option with built-in Ethernet
- User-upgradeable memory

2.2 Display

The large graphics display offers excellent viewing, display quality and desktop performance graphics. The notebook supports two different displays — DualScan STN or active-matrix TFT LCD.

Video Performance

PCI local bus video with 128-bit graphics acceleration boost your video to desktop-performance level, and allows you to run 30fps full-screen, true-color video playback via software MPEG.

Simultaneous Display

The notebook's large display and multimedia capabilities are great for giving presentations. If you prefer, you can connect an external monitor when giving presentations as the notebook supports simultaneous display on the LCD and external CRT. Simultaneous display allows you to control the presentation from your notebook and at the same time face your audience. For large-audience presentations, you can connect an LCD projection panel.

Power Management

The heuristic or "self-learning" power management system automatically decides the best settings for your display while providing maximum performance and power conservation. See section 3.2 for more information on power management.

Opening and Closing the Display

To open the display, slide the display lid latch to the right and lift up the display. Then tilt it to a comfortable viewing position. To close the display, fold it down gently until the display lid latch clicks into place.



To avoid damaging the display, do not slam it when closing the lid. Do not place any object on top of the notebook when the

display is closed.

FlashStart Automatic Power-On

A noticeably unique feature about this notebook is that it has no on/off switch. Instead it employs a lid switch, located near the center of the display hinge, that tells the notebook when it should wake up or go to sleep.

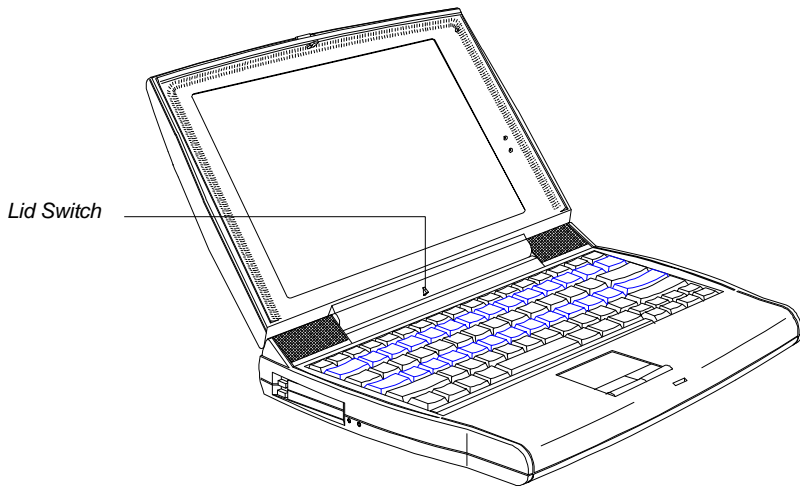

Figure 2-1 Display

When you close the display lid, the notebook enters suspend-to-memory or suspend-to-disk mode before turning off the power, depending on the When Lid is Closed parameter setting in Setup (see section 6.5.1). When you open the lid, the notebook resumes from where you left off before closing the lid.

Suspend-to-memory, suspend-to-disk and other power management issues are discussed in detail in section 3.2.

The “Lid Closed” State

When the lid is closed (i.e., the “lid closed” state), the notebook suspends its normally busy tasks to make itself electronically and mechanically more stable. When the lid is opened, the notebook briefly checks its environment and always re-initializes devices newly added in or removed from the notebook.

Though the notebook allows for various hot insertion of peripherals, the “lid closed” state provides the most stable and practical means to attach and detach peripheral components.



As a simple rule of thumb, close the lid when adding or removing peripheral components.

2.3 Indicator Lights

Two indicator lights are found on the display panel.

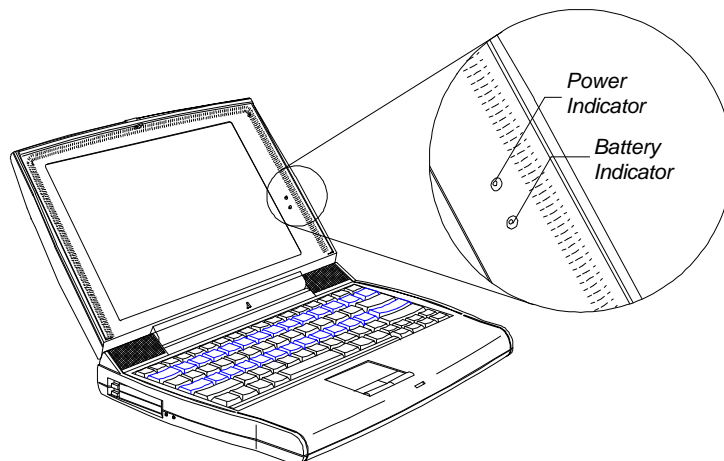



Figure 2-2 Indicator Lights

These indicators and their descriptions are shown in Table 2-1.

Table 2-1 Indicator Status Descriptions

Icon	Indicator Light	Description
	Power Indicator	<ul style="list-style-type: none">• Lights when power is on• Flashes when the notebook is in suspend-to-memory mode
	Battery Indicator	<ul style="list-style-type: none">• Lights when battery pack is charging• Flashes when battery power is low

To know more about batteries and power management, see Chapter 3.

2.4 Keyboard

The full-sized keyboard includes an embedded keypad, separate cursor keys, two Windows 95 keys and twelve function keys. Special keys are highlighted in different colors.

2.4.1 Keyboard Layout

US

UK

Figure 2-3 Keyboard Layout

2.4.2 Special Keys

Lock Keys

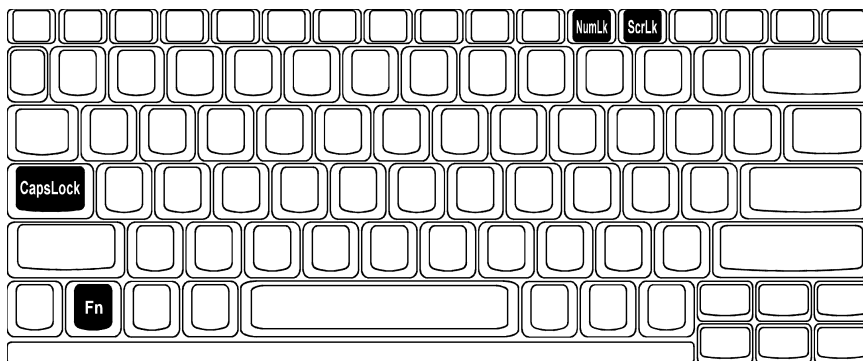





The notebook has the three basic lock keys which you can toggle on and off. Some keys may require using  as part of a key combination.

Table 2-2 Lock Key Descriptions



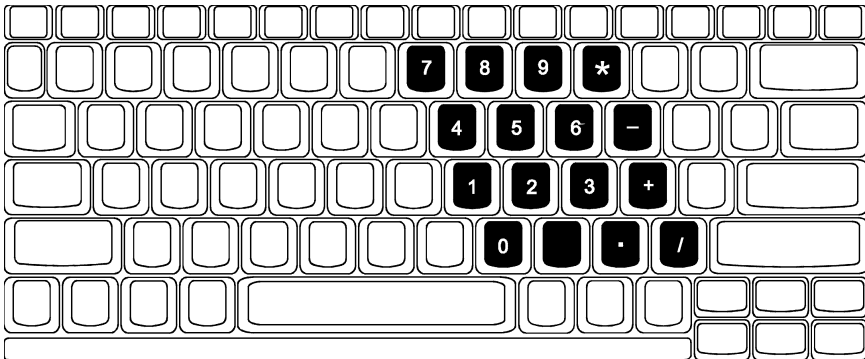

Key	Description
@	When Caps Lock is on, all alphabetical characters typed appear in uppercase.
 - 	When Num Lock is on, the embedded keypad is in numeric mode. The keys function as a numeric keypad like the one found on standard PC keyboards (complete with arithmetic operators +, -, *, and /). Use this mode when you need to do a lot of numeric data entry. A better solution would be an external keypad. See section 4.3.
 - 	When Scroll Lock is on, the screen moves one line up or down when you press W or Y respectively. Scroll lock does not work with some applications.

Embedded Keypad



The embedded keypad functions like a desktop numeric keypad. It is indicated by small characters located on the upper right corner of the keycaps. To simplify the keyboard legend, the cursor-control key symbols are not printed. Table 2-3 tells how to use the embedded keypad.

Table 2-3 Using the Embedded Keypad

Desired Access	Num Lock On	Num Lock Off
Number keys on embedded keypad	Type numbers in a normal manner	Hold  while using keypad keys
Cursor-control keys on embedded keypad	Hold  while using cursor-control keys	Hold  and  while using cursor-control keys
Main keyboard keys	Hold  while typing letters on embedded keypad	Type the letters in a normal manner

Windows 95 Keys

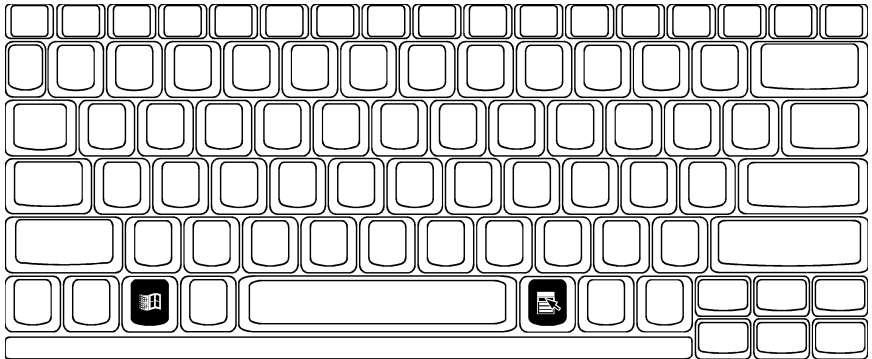

The keyboard has two keys that perform Windows 95-specific functions.

Table 2-4 Windows 95 Key Descriptions

Key	Description
Windows logo key	Start button. Combinations with this key performs special functions. Below are a few examples: <ul style="list-style-type: none">• <i>Windows + Tab</i> Activate next Taskbar button• <i>Windows + E</i> Explore My Computer• <i>Windows + F</i> Find Document• <i>Windows + M</i> Minimize All• <i>Shift + Windows + M</i> Undo Minimize All• <i>Windows + R</i> Display Run dialog box
Application Key	Opens the application's context menu (same as right-click).

Hot Keys

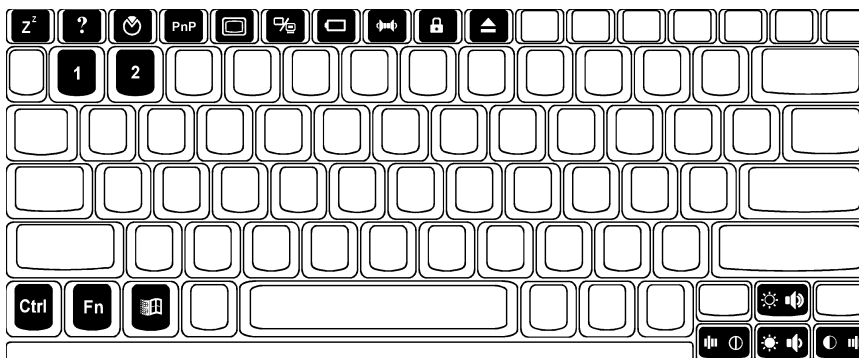

The notebook uses hot keys (key combinations) to access most of the notebook's controls like screen contrast and brightness, volume output and the BIOS setup utility. Some hot keys will pop-up a corresponding icon onscreen for better visuals.



When activating hot keys, press and hold the first key  before pressing the other keys in the combination.

Table 2-5 Hot Key List







Hot Key	Icon	Function	Description
 -	Z^Z	Suspend-to-memory	Enters suspend-to-memory mode
 -	?	Help	Displays the hotkey list
 -m		Setup	Enters the BIOS setup utility
 -n	PnP	Plug and Play Configuration	Allows the system to re-configure itself and do self-diagnostics
 -o		Screen Blackout	Blanks the screen to save power. To wake up the screen, press any key.

Table 2-5 Hot Key List (continued)



























Hot Key	Icon	Function	Description
 -p		Display Toggle	Switches display from LCD to CRT to both LCD and CRT
 -q		Fuel Gauge On/Off	Toggles battery gauge display on/off. Also shows the following: <ul style="list-style-type: none"> • “plug” icon if a powered AC adapter is connected to the notebook. • “speaker” icon if speaker output is on (toggled by  -r). • “T” icon if turbo mode is on (toggled by  -2).
 -r		Speaker On/Off	Toggles speaker output on and off
 -s		Lock System Resources	Provides notebook security by locking system from access. Requires password input to unlock system. See section 6.6.1.
 -t		Eject	Accesses the Eject menu. See the following subsection.
 -b-w		Volume Up	Increases audio volume
 -b-y		Volume Down	Decreases audio volume
 -b-z		Balance Left	Shifts speaker balance to the left
 -b-x		Balance Right	Shifts speaker balance to the right
 -  -w		Brightness Up	Increases screen brightness
 -  -y		Brightness Down	Decreases screen brightness to save power

Table 2-5 Hot Key List (continued)

Hot Key	Icon	Function	Description
- -X		Contrast Up	Increases screen contrast (DSTN only)
- -Z		Contrast Down	Decreases screen contrast (DSTN only)
-W		Fuel Gauge Up	With the fuel gauge onscreen, moves the fuel gauge up
-Y		Fuel Gauge Down	With the fuel gauge onscreen, moves the fuel gauge down
-Z		Fuel Gauge Left	With the fuel gauge onscreen, moves the fuel gauge left
-X		Fuel Gauge Right	With the fuel gauge onscreen, moves the fuel gauge right
-1		CD Eject	Ejects the CD-ROM drive
-2		Turbo Mode On/Off	Toggles turbo mode on and off.

Using the Eject Menu

Pressing -t brings up the Eject Menu.

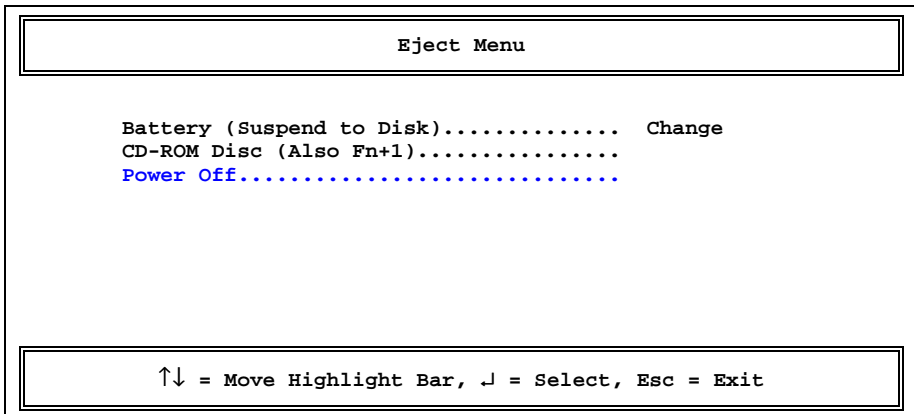

The eject menu commands allow you to perform various eject-related functions for the notebook. See the following table for details

Table 2-6 Eject Menu Descriptions

Select...	To...
Battery	<p>Change the battery.</p> <p>This option forces the notebook to enter suspend-to-disk mode, so that you can replace the battery with a charged one, and then return to where you left off.</p> <p>To resume, close the display lid and open the display lid again.</p>
CD-ROM Disc	<p>Open the CD-ROM drive.</p> <p>There are many ways to open the CD-ROM disc tray:</p> <ul style="list-style-type: none">• selecting this option• pressing Fn-1• pressing the CD-ROM eject button• using software controls <p>It is best to wait for the CD-ROM light (found on the CD-ROM eject button) to go off before ejecting the CD-ROM drive.</p>
Power Off	<p>Turn the system off (without entering suspend mode).</p> <p>When you choose this option, a “cold boot” occurs after re-starting the system (closing and opening the display). You can choose this option when you want to swap modules, or when you want to turn off the notebook without entering any of the suspend modes. Note however that the proper way to power off the system in Windows 95 is to use the Shutdown command.</p> <p>To turn the notebook back on, close the display lid and open the display lid again.</p>

2.4.3 Automatic Tilt Feature

The keyboard has the option of automatically tilting to a six-degree angle whenever you open the lid. This automatic tilt feature brings to the notebook the comfortable typing angle provided in standard PC desktop keyboards.

Together with the palm rest (discussed in the following section), these two ergonomic features help prevent repetitive strain injury to your wrists and fingers.

Enabling and Disabling the Automatic Tilt Feature

A tilt switch, found right above the port cover on the rear of the notebook, allows you to enable or disable this feature. Follow these steps:

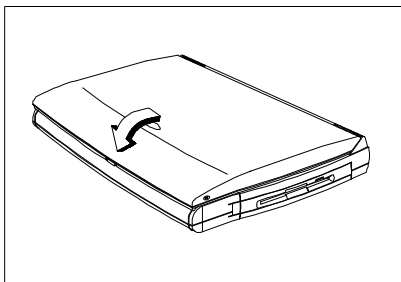

1. Close the lid.

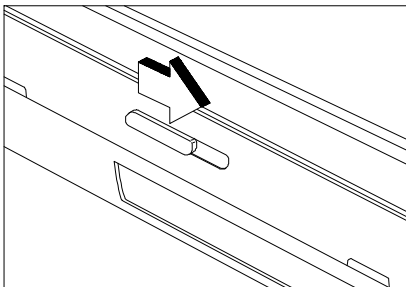

2. To **enable** the automatic tilt feature, slide the tilt switch to the right ()

To **disable** the automatic tilt feature, slide the tilt switch to the left ()

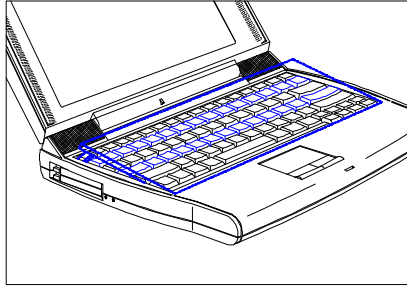

3. Open the lid.

2.4.4 Palm Rest

Located below the keyboard, the wide and curved palm rest gives you a comfortable place to rest your hands while you type.

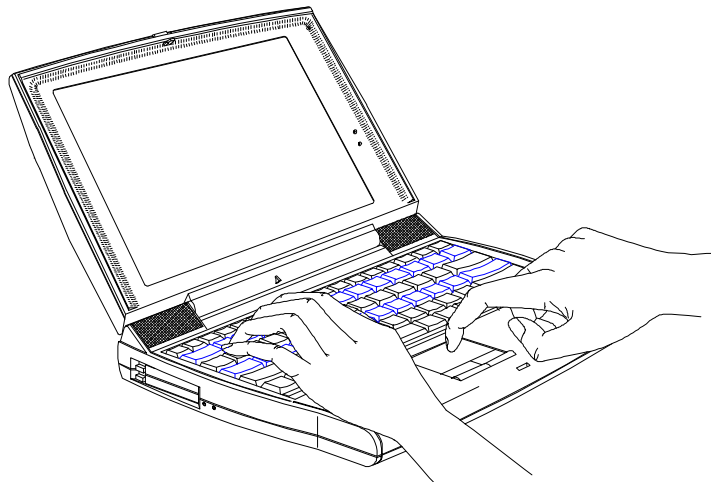

Figure 2-4 Palm Rest

2.5 Touchpad

The ergonomically-centered touchpad is a pointing device that senses movement on its surface. This means the cursor responds as you move your finger on the surface of the touchpad.

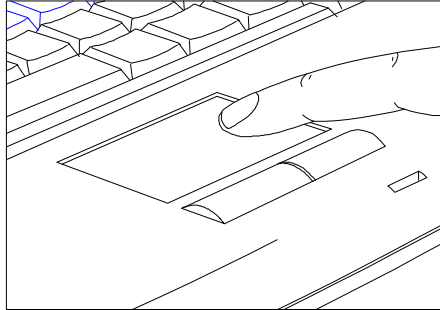

Figure 2-5 Touchpad



The touchpad works with most mouse drivers. However, the touchpad driver supports special functions that work uniquely with the touchpad. We recommend you use the touchpad driver instead of any other mouse driver.

Touchpad Basics

The following two items teach you how to use the touchpad:

- Move your finger across the touchpad to move the cursor.
- Press the left and right buttons located on the lower edge of the touchpad to do selection and execution functions. These two buttons are similar to the left and right buttons on a mouse. Tapping on the touchpad produces similar results. See Table 2-7.

Table 2-7 Touchpad Functions

Function	Left Button	Right Button	Tapping on the Touchpad
Execution	Click twice quickly		Tap twice (at the same speed as double-clicking the mouse button)
Selection	Click once		Tap once
Drag	Click and hold to drag the cursor		Tap twice (at the same speed as double-clicking the mouse button) and hold finger to the touchpad on the second tap to drag the cursor
Access Context Menu		Click once	When Corner Taps is enabled, tap on the upper right corner of the touchpad. See section 5.3 on how to configure the touchpad.



Keep your fingers dry and clean when using the touchpad. Also keep the touchpad dry and clean.

The touchpad is sensitive to finger movements. Hence, the lighter the touch, the better the response. Tapping too hard will not increase the touchpad's responsiveness.

2.6 Storage

2.6.1 Hard Disk

High-capacity storage comes in the form of a 2.5-inch Enhanced-IDE hard disk. The hard disk can be upgraded when you need more storage space. See section 4.9.2 for related information.

2.6.2 Module Bay

The notebook's flexible module bay accommodates either a high-speed CD-ROM drive module or a 3.5-inch, 1.44MB floppy drive.

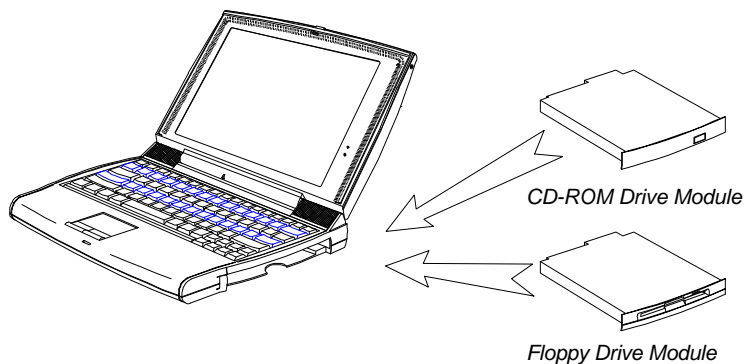

Figure 2-6 Module Bay

The modules are designed to give you flexibility in the fast-moving portable platform. The CD-ROM drive module gives you portable multimedia access. The floppy drive module serves both as an internal and external unit.

Swapping Modules

The proper way to cleanly swap or interchange modules is to power off the notebook without the help of any suspend modes. The notebook needs to perform a “cold boot” (Windows 95 shutdown or via the Eject menu) or “warm boot” (Ctrl-Alt-Del) to correctly detect and identify the module currently installed in the module bay. Simply closing the display lid will only put the notebook in either suspend-to-disk or suspend-to-memory.

Follow these steps to swap modules:

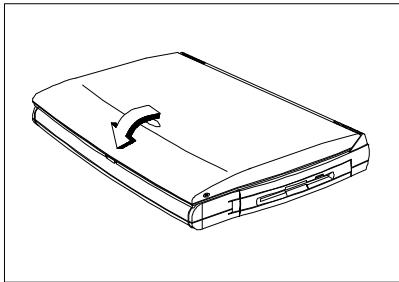

1. Do a Windows 95 shutdown.

If you are not using the notebook under Windows 95, you can use the Power-Off option by accessing the Eject Menu (Fn-F9).

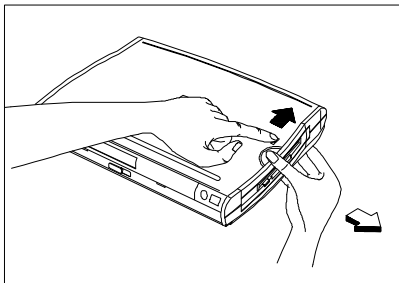

2. Close the display lid.
3. Slide the module release lock and press the module release latch and pull out the module.

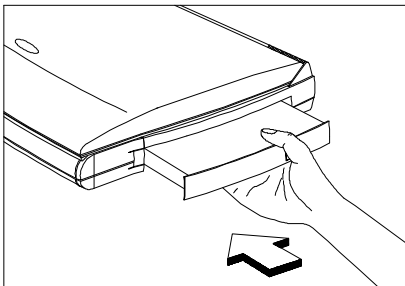

4. Insert the new module securely into the module bay.
5. Open the display lid. After opening the display, the notebook automatically senses the new module.

Ejecting a CD

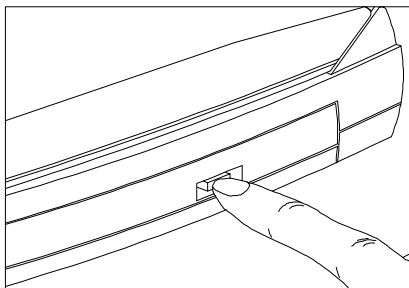

To eject a CD, press the eject button on the CD-ROM drive, press **Fn** -1, or use your software to eject the CD-ROM drive.

In Windows 95, you can right-click on the CD-ROM drive icon and select the Eject command.

Using the Floppy Drive Module Externally

You can use the floppy drive module externally when a CD-ROM drive module is installed in the module bay.



You cannot use the CD-ROM drive module externally.
Only the floppy drive module can be used externally.

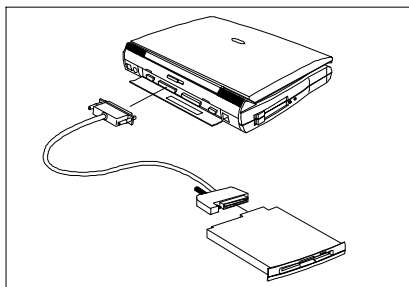

If the floppy drive module is installed in the module bay, remove it by following the steps described in the previous section.

Open the port cover and connect the 25-pin connector end of the floppy drive cable to the parallel port. Connect the other end of the cable to the floppy drive module.

2.7 Ports

Ports allow you to connect peripheral devices to your notebook computer as you would with a desktop PC. The ports are found on the left and rear panel. The following sections discuss these ports and their functions.



See Chapter 4 on how to connect external devices to the notebook.

2.7.1 Left Panel Ports

Multimedia ports and the PC card slots are found on the left panel. See Figure 2-7.

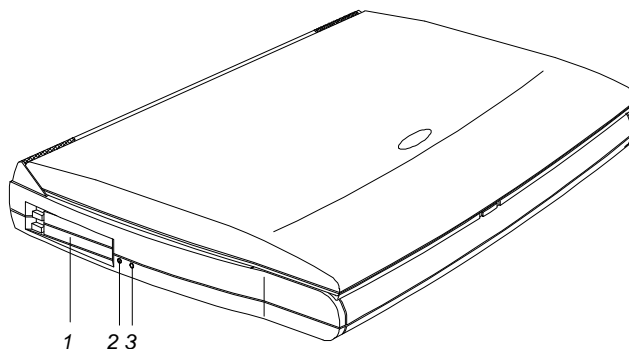



- 1 PC Card Slots
- 2 Microphone-in/Line-in Port
- 3 Speaker-out/Line-out Port

Figure 2-7 Left Panel Ports

Table 2-8 describes these ports.

Table 2-8 Left Panel Port Descriptions

#	Icon	Port	Connects to...
1		PC Card slots	One Type III or two Type I/II PC cards
2		Microphone-in/Line-in	External microphone or line input device
3		Speaker-out/Line-out	Amplified speakers or headphones

PC Card Slots

There are two type II/I or one type III PC Card slots found on the left panel of the notebook. These slots accept credit-card-sized cards that enhance the usability and expandability of the notebook.

PC Cards (formerly PCMCIA) are add-on cards for portable computers, giving you expansion possibilities long afforded by desktop PCs. Common type II cards include flash memory, SRAM, fax/data modem, LAN and SCSI cards. Type III cards most often used are 1.8-inch ATA drives and cellular modems.

Inserting a Card

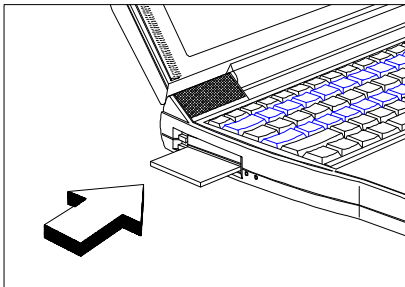

Insert the card into the desired slot and make the proper connections (e.g., network cable), if necessary. See your card manual for details.

For type III cards, insert the card into the lower (bottom) slot.

Ejecting a Card

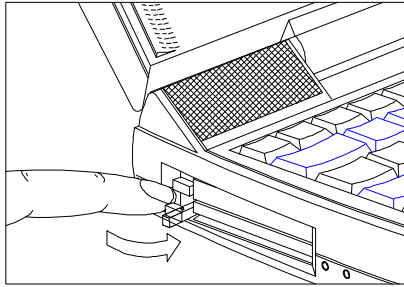

1. Exit the application using the card.
2. Flip out the slot eject button of the slot where the card is inserted.

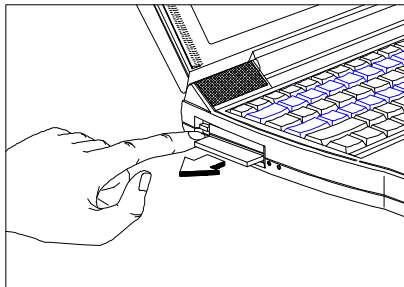

3. Press the slot eject button to eject the card.

If you want to install a card, refer to your card's user's manual for details on how to install and use the card.

Multimedia Ports

Connecting external audio devices to these ports automatically shuts off the corresponding internal audio device. For example, if you connect external speakers, the internal speakers automatically shut off.



To use Mic-in or Line in, insert the plug of the desired device and make sure to turn off the appropriate input from the mixer. See the multimedia section of your Windows 95 manual.

2.7.2 Rear Panel Ports

The rear panel includes the notebook's main ports and connectors. See Figure 2-8.

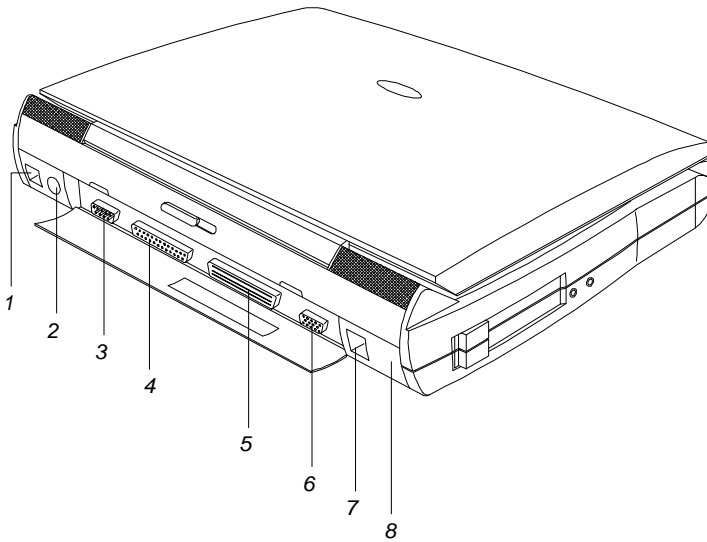







- 1 DC-in Port
- 2 PS/2 Port
- 3 Serial Port
- 4 Parallel Port

- 5 Mini Dock Connector
- 6 External CRT Port
- 7 RJ-11 Phone Jack
- 8 Infrared Port

Figure 2-8 Rear Panel Ports

Table 2-9 describes these ports.

Table 2-9 Rear Panel Port Descriptions

#	Icon	Port	Connects to...
1		DC-in port	AC adapter and power outlet
2		PS/2 port	PS/2-compatible device (e.g., PS/2 keyboard, keypad, mouse)
3		Serial port (UART16650-compatible)	Serial device (e.g., serial mouse)
4		Parallel port (EPP/ECP-compliant)	Parallel device (e.g., parallel printer, external floppy drive)
5		Mini dock connector	Mini dock
6		External CRT port	External monitor (up to 1024x768, 256 colors)
7		Modem jack (RJ-11)	Phone line
8		Infrared port	Infrared-aware device (e.g., notebook with IR port, desktop with IR adapter, IR-capable printer)

2.8 Audio

Standard notebook configuration includes 16-bit stereo audio with built-in FM synthesizer. Combined with the dual, angled speaker system and built-in sensitive microphone, this notebook redefines portable audio.

2.8.1 Built-in Speakers and Microphone

The dual, angled speakers found on both sides of the display hinge directs sound towards you, and its unique audio chamber design allows for better acoustics and sound reverberation resulting in excellent sound quality.

The built-in sensitive microphone provides good quality audio recording with its echo-cancellation design via the front-and-side mic pocket.

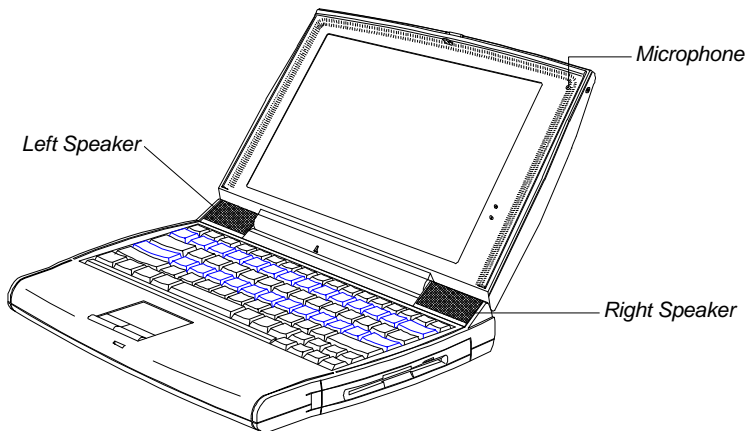











Figure 2-9 Built-in Speakers and Microphone

Besides the built-in speakers and microphone, there are two audio ports on the left panel of the notebook. See section 4.6 for details on how to connect external audio devices.

2.8.2 Controlling the Audio

There are hot keys that allow you to control various aspects of the audio output. The following table lists the audio-specific hot keys:

Table 2-10 Audio Control Hot Keys

Hot Key	Icon	Function	Description
 -r		Speaker On/Off	Toggles speaker output on and off
 -b-w		Volume Up	Increases audio volume
 -b-y		Volume Down	Decreases audio volume
 -b-z		Balance Left	Shifts speaker balance to the left
 -b-x		Balance Right	Shifts speaker balance to the right



These settings are only in effect for a single session (e.g., up to a power off). To let it stay in the same settings for the next power on, you need to adjust the audio volume control in Windows 95 or other operating systems.

2.9 Communications

2.9.1 Serial Infrared

This notebook has an SIR (serial infrared) port located on the rear panel.

Wireless communication support allows you to transfer data to SIR-"aware" machines without the aid of cables. Not only can you transfer data between two SIR-capable computers, you can also send data to SIR-"aware" peripherals like infrared printers without the need to connect cables.

The infrared port is IrDA-compliant, allowing it to transfer data with speeds of up to 115.2 kilobits per second (kbps) at a distance of up to one meter.

Using the Infrared Port

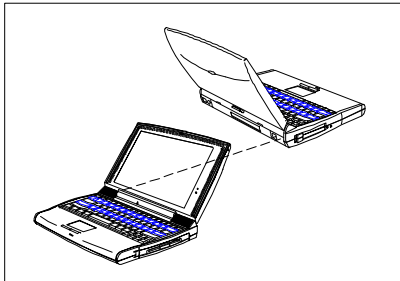

Line up the SIR ports of the two SIR-"aware" devices no more than one meter apart and no greater than ± 15 degrees.

Begin the file transfer program on both machines and you're ready to go. See your file transfer software manual for details.

2.9.2 Fax/Data Modem¹

The notebook has an optional state-of-the-art, 28.8Kbps V.34 fax/data modem that supports V.42bis hardware compression (115.2 kilobits per second). The modem also supports DSVD (simultaneous voice over data) technology which allows you to send data and talk at the same time.

Using the Modem

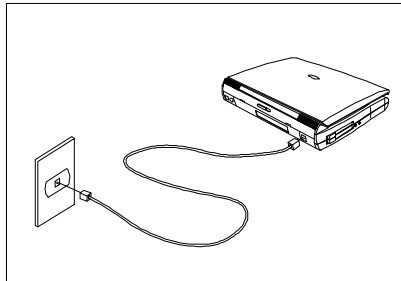

Connect the phone line cable from the RJ11 modem port on the notebook's rear panel to the telephone line jack.

Begin your communications software program. See your software manual for instructions. The software also supports speakerphone and telephone answering device features.

The advantage of a built-in modem is that it frees up your PC card slots for other functions.

¹ This feature is available only in the U.S.

2.10 Securing your Notebook

Security features include hardware and software locks — a security notch and a two-level password scheme.

2.10.1 Security Notch

A security notch located on the left panel of the notebook lets you connect a standard key-based computer security lock.

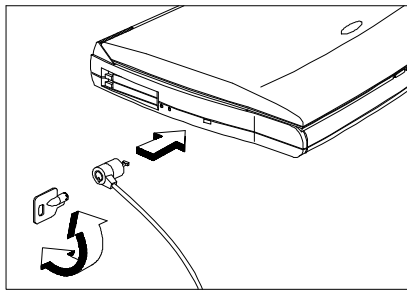

Circle or wrap a computer security lock cable around an immovable object such as a table or locked drawer handle. Then insert the lock into the notch and turn the key to secure the lock.

2.10.2 System Resource Lock

A two-level password scheme protects your notebook from unauthorized access. When set, just press **Fn** -s to lock all system resources. In this situation, no one can access the notebook without entering the correct password.

For information on how to set passwords, see section 6.6.1.

Power

The notebook operates on AC or battery power. This chapter contains the information you need to know to operate the notebook on battery power. The chapter also includes information about the unique power management system.

3.1 Battery Power

The notebook uses a single high-capacity Lithium-Ion smart battery pack that gives you longer use between charges.

3.1.1 Battery Pack Characteristics

The battery pack has the following characteristics:

- *Lithium-Ion Technology* Lithium-Ion technology does not have the memory effect problem of Nickel Cadmium (NiCd) nor the temperature problem of Nickel Metal-Hydrate (NiMH) battery types. Li-Ion batteries consistently provide the longest battery life best-suited for road warriors.
- *Battery Gauge* Built into the battery pack is a battery gauge that allows you to check the battery charge level even when the battery is not installed inside the notebook.
- *Battery-low Warning* When the battery charge level becomes low, the battery indicator flashes at regular intervals. This tells the user that the battery power is very low. You can correct this situation by recharging the battery pack.

Whenever possible, use the AC adapter. The battery will come in handy when you travel or during a power failure. It is advisable to have an extra fully-charged battery pack available for backup.

Currently, there is no defined standard for measuring battery life. Several factors have made it almost impossible to compare the battery life of different notebooks based on specifications alone. These factors include different implementations of power saving/management systems, applications in use, the user's "usage pattern", hard disk capacity and access frequency, LCD size and brightness, system form factor and weight.



If the notebook is to be stored for more than two weeks, we suggest that you remove the battery pack. Battery power from a fully charged battery pack depletes in roughly a week with the

notebook in suspend-to-memory mode.



Do not expose battery packs to temperatures below 0°C (32°F) or above 60°C (140°F). This may adversely affect the battery pack.

3.1.2 Removing and Installing the Battery Pack

Removing the Battery Pack

Before removing the battery pack, make sure that you have an AC adapter connected to the notebook; otherwise turn off the notebook. The following figure illustrates how to remove the battery pack.

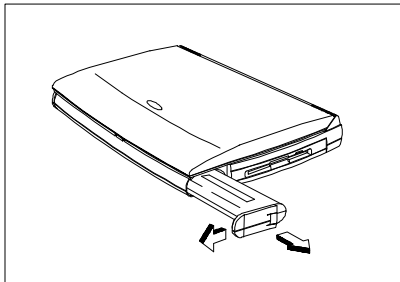

1. Press the battery compartment cover latch and slide it out.
2. Pull out the battery pack.

Installing the Battery Pack

Follow these steps to install the battery pack.

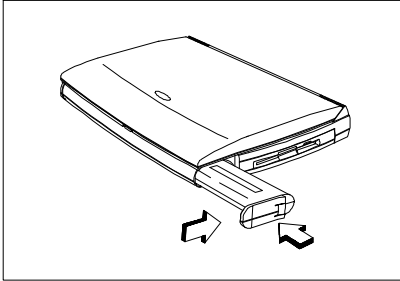

Insert the battery pack into the battery compartment and slide in the battery compartment cover.

3.1.3 Charging the Battery

To charge the battery, place the battery pack inside the battery compartment and plug the AC adapter into the notebook and an electrical outlet.

Charging Modes

The adapter has three charging modes:

- Rapid charge mode

The notebook uses rapid charging when the notebook is in suspend mode and a powered AC adapter is connected to it. In rapid mode, a fully depleted battery gets fully charged in approximately two hours.

- Charge-in-use mode

When the notebook is in use with the AC adapter plugged in, the notebook also charges the battery pack if installed. This mode will take longer to fully charge a battery than rapid mode. In charge-in-use mode, a fully depleted battery gets fully charged in approximately four hours.

- Trickle charge mode

When the battery is fully charged, the adapter changes to trickle charge mode to maintain the battery charge level. This prevents the battery from draining while the notebook is in use.



We suggest that you charge the battery pack before you go to sleep, letting it charge overnight before traveling. This ensures a fully charged battery for use the next day.

3.1.4 Checking the Battery Level

There are three ways to check the battery charge level:

- Onscreen fuel gauge
- Windows 95 battery indicator
- Battery pack gauge

The fuel gauge shows the minimum guaranteed capacity to provide assurance that the system will be operational for the minimum battery life indicated.

Using the Onscreen Fuel Gauge

To access the onscreen fuel gauge, press -q. If a powered AC adapter is connected to the notebook, a plug icon also shows in the onscreen fuel gauge.

Press and hold  and the cursor keys to move the fuel gauge around the screen. The onscreen fuel gauge indicates the present battery level. Press the hot key again to hide the fuel gauge.

Using the Windows 95 Battery Indicator

Rest your cursor on the battery icon on the taskbar to display the current power left. Double-clicking on the battery icon on the taskbar displays the Power dialog box. You can also access this dialog box via the Power icon from the Control Panel.



When the notebook is running on AC power, a plug icon replaces the battery icon on the taskbar.

Using the Battery Pack Gauge

The battery pack gauge allows you to check your battery charge level even when it is not installed in the notebook.

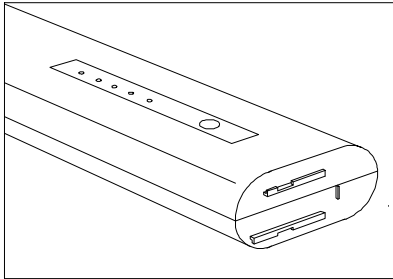

Press the fuel gauge button on the battery pack to check the battery charge level.

Table 3-1 is a battery-level chart.

Table 3-1 Battery-level Chart

Battery LEDs	LEDs Lit	Charge Level
●●●●●	five	100%
●●●●○	four	≈80%
●●●○○	three	≈60%
●●○○○	two	≈40%
●○○○○	one	≈20%
*○○○○	one blinking	<20%

3.1.5 Optimizing Battery Life



Optimizing battery life prolongs the charge/recharge cycle and improves recharge efficiency. Follow these suggestions to optimize and maximize battery power:

- Purchase an extra battery pack.
- Set the When Lid is Closed parameter in Setup to [Suspend to Disk]. See section 6.5.1.
- Use the AC adapter whenever possible so that the battery is reserved for on-the-go computing.
- Keep the battery pack in the notebook powered by the AC adapter. The constant trickle charge maintains the battery level to eliminate the battery self-discharge effect. The charge-in-use function also charges the battery pack.
- Set the Internal Modem parameter to [Power-Off] to conserve power when not using the internal modem. See section 6.5.6.
- Set the Display Always On parameter to [Disabled] to save power. See section 6.5.3.
- Eject the PCMCIA card from the card slot when not in use, since the PCMCIA card draws extra power.
- Store the battery pack in a cool, dry place. The recommended storage temperature for battery packs ranges from 10 to 30 degrees C. The higher the storage temperature, the faster the battery pack self-discharges.
- The batteries can be recharged about 500 times when used as directed.
- Take care of your battery pack. See section 1.2.3 for details.

3.1.6 Battery Low Condition

You never have to worry about battery power as long as you are using the AC adapter. However, when you operate the notebook on battery power, pay extra attention to the battery indicator () .

Generally speaking, a battery-low condition occurs when less than twenty percent charge left is in the battery. The following signals a battery-low condition:

- The battery indicator () flashes until battery power is depleted or until AC power is applied
- The fuel gauge (accessed via -q) turns red

When you receive a battery-low warning, you have about fifteen minutes to save your work. If you do not connect the AC adapter or install a backup battery pack within fifteen minutes, the notebook enters suspend-to-disk mode if the following conditions exist:

- There is enough battery power left to save system information onto the hard disk.
- The suspend-to-disk file created by the Sleep Manager is present and valid
- All suspend-to-disk conditions are matched. See section 3.2.2.

Otherwise, the notebook enters suspend-to-memory mode.



Connect the AC adapter or insert a charged battery pack into the notebook as soon as possible to prevent data loss.

Table 3-2 lists the recommended course of action when you encounter a battery-low condition.

Table 3-2 Course of Action for Battery-low Condition

Situation	Recommended Action
AC adapter and power outlet available	<ol style="list-style-type: none"> 1. Connect the AC adapter to the notebook to begin charging the battery. 2. Resume work. <p>If you want the battery to recharge faster, close the display or press Fn - (Z) to enter suspend mode.</p>
An extra fully-charged battery pack available	<ol style="list-style-type: none"> 1. Press Fn - (Z) or close the display to enter suspend mode. 2. Open the battery compartment cover. 3. Remove the used up battery pack. 4. Install the new battery pack. 5. Press any key or open the display to resume work. <p>Remember to recharge the old battery pack.</p>
AC adapter, power outlet and extra battery pack not available	Close the display to enter suspend mode.

3.2 Power Management

At the very heart of this notebook is a new way of power management called Heuristic Power Management (HPM). Part of the notebook's overall design, this power management method allows the notebook to provide maximum power conservation **and** maximum performance.

3.2.1 The Concept of Heuristics

Current power management schemes or methods used by notebooks are timer-based. You have to set various time-out values for the display, the hard disk and other devices. Then based on these fixed time-outs, the system puts itself to sleep when it detects inactivity within this time frame. The problem with this is — no two users are alike. Each individual user has his or her own habits when using the computer. In short, timer-based power management is not an effective way to power-manage a system.

Heuristics suggests an idea of “self-learning”. HPM allows the system to power-manage itself depending on how you use the machine. In effect, the notebook delivers maximum power when you need it and saves power when you don't need as much power, without requiring user intervention. There are no timers to set, nothing to enable or disable, because the system figures out everything for you.

Analogy on Heuristics

You normally walk to a grocery store. If you cross the street, you might have to walk a bit faster, or even run. Whether you walk or run depends upon situations that are not fixed.

The same should be true for computers. A computer should know when to operate at full power and when to operate at anything less than full power. Timer-based power management operates by a fixed set of rules which cannot adapt to dynamic situations. Heuristic power management allows the computer to adapt to dynamic situations.

3.2.2 Suspend Modes

The heuristic power management system performs automatic suspend, hot-key suspend and all suspend actions resulting from various events and conditions. You only need to set the suspend mode type the notebook enters when a suspend condition occurs.

The two suspend modes are:

- Suspend-to-memory mode
- Suspend-to-disk mode

The suspend mode that the notebook enters into is specified in the When Lid is Closed parameter in Setup. See section 6.5.1.



The When Lid is Closed parameter can also be set to Sleep Mode. Sleep Mode maintains active modem and network connections when the display lid is closed. This power saving mode saves the least power.



If an external monitor is connected to the notebook, the notebook will not enter the desired suspend mode if you close the display. To enter suspend mode, disconnect the monitor plug, open the display and close the display again.

Suspend-to-Memory Mode

The notebook consumes very low power in suspend-to-memory mode. Data remains intact in memory. The notebook restores this information from the memory and resumes from where you left off upon leaving suspend mode.



When battery runs out of power and the AC adapter is not connected, the notebook automatically does a suspend-to-disk operation and ignores the When Lid is Closed parameter setting in Setup. The suspend-to-disk file should be present and valid.

Suspend-to-Memory Mode Conditions

For the notebook to enter suspend-to-memory mode, any of the following conditions should exist:

- When Lid is Closed parameter is set to [Suspend To Memory]
- The suspend-to-disk file is either absent or invalid

Entering Suspend-to-Memory Mode

With the suspend-to-memory conditions satisfied, there are many ways to enter suspend mode:

- Closing the display
- Pressing the suspend hot key  -| (Z²)
- Sustained inactivity
- Battery fail condition occurs without a powered AC adapter connected
- Any suspend condition where suspend-to-disk fails

When the system enters suspend-to-memory mode, the power indicator () flashes.

Leaving Suspend-to-Memory Mode

There are four ways to leave suspend-to-memory mode and return to normal mode:

- If the display is closed, open the display
- If the display is open, press any key.
- The Resume on Modem Ring: parameter is set to [Enabled] and the internal modem rings.
- The Resume on Schedule parameter is set to [Enabled] and the Resume Date and Time parameters have been met.

Suspend-to-Disk Mode

In suspend-to-disk mode, power shuts off. The notebook saves all system status information onto the hard disk (in a file created by Sleep Manager) before entering suspend-to-disk mode. The next time you open the notebook, it restores this information from the hard disk and resumes from where you last left off.

Suspend-to-Disk Mode Conditions

For the notebook to enter suspend-to-disk mode, all of the following conditions should exist:

- When Lid is Closed parameter is set to [Suspend To Disk]
- The suspend-to-disk file created by Sleep Manager is present and valid
- The Resume on Modem Ring and Resume on Schedule parameters are disabled. See sections 6.5.5 and 6.5.6.

Entering and Leaving Suspend-to-Disk Mode

With the suspend-to-disk conditions satisfied, there are four ways to enter suspend-to-disk mode:

- Closing the display
- Battery fail condition occurs without a powered AC adapter connected and Suspend to Disk on Critical Battery is set to [Enabled].
- When battery is low while the notebook is in suspend-to-memory mode, the notebook wakes up and performs a suspend-to-disk operation to prevent data loss.

To leave suspend-to-disk mode, open the display. Make sure a charged battery pack is installed and/or a powered AC adapter is connected before you open the display.

Validating the Suspend-to-Disk File

To check if the suspend-to-disk file is present and valid, rest your cursor on the Sleep Manager icon on the taskbar to show the status. See section 5.2

3.2.3 Advanced Power Management (APM)

This notebook supports the APM standard designed to further reduce power consumption. APM is a power-management approach defined jointly by Microsoft® and Intel®. The notebook's heuristic power management scheme works hand-in-hand with APM to take advantage of power saving features and allows greater system availability without degrading performance.



*Advanced Power Management greatly prolongs battery life.
Use APM whenever possible.*

Setting the Optimum Power Management Level

Follow these steps:

1. Select the Start button, click on Settings... and select Control Panel.
2. Double-click on the Power icon in the Control Panel window.
3. Set the power management mode to Advanced for optimum power management.

Enabling APM

If APM under Windows 95 is not enabled, follow these steps to enable it:

1. Select the Start button, click on Settings... and select Control Panel.
2. Double-click on the System icon in the Control Panel window.
3. Select the Device Manager tab and double-click on System devices.
4. Double-click on Advanced Power Management support to display its properties. Select the Settings tab and make sure the check box for enabling power management support is selected.

Refer to the Windows 95 user's guide for details.

Options

This notebook offers excellent connectivity and expansion capabilities with its built-in ports and connectors. This chapter describes how to connect peripherals and hardware options¹ to the notebook. When connecting peripherals, read the manual included with the peripheral for operating instructions.

This chapter also includes information on the key components that you can upgrade. Key component upgradeability gives you the room to enhance the notebook to meet your future needs.

¹ For complete options available, consult your dealer.

4.1 External Monitor

To show graphical effects on a larger display, you can connect an external monitor to the CRT port () on the rear panel. Read the monitor manual for additional instructions.

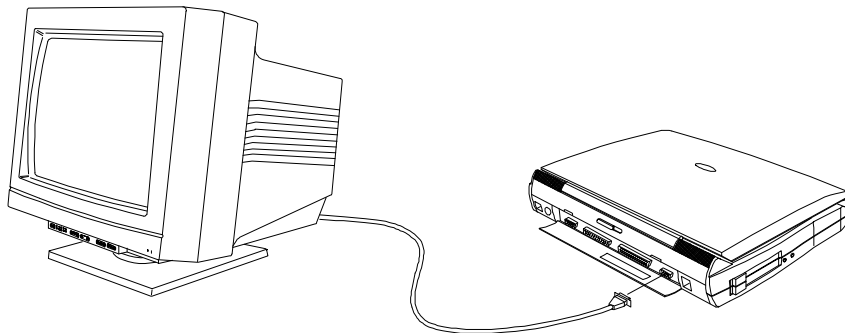

Figure 4-1 Connecting an External Monitor



You can press **Fn**-**p** to toggle the display output to the external CRT and back to the notebook display or simultaneously on both displays.



If an external monitor is connected to the notebook, the notebook will not enter the desired suspend mode if you close the display. To enter suspend mode, disconnect the monitor plug, open the display and close the display again.

4.2 External Keyboard

This notebook has a keyboard with full-sized keys and an embedded keypad. If you feel more comfortable using a desktop keyboard, you can install a PS/2-compatible external keyboard.

To connect an external keyboard, plug the external keyboard into the PS/2 connector ().

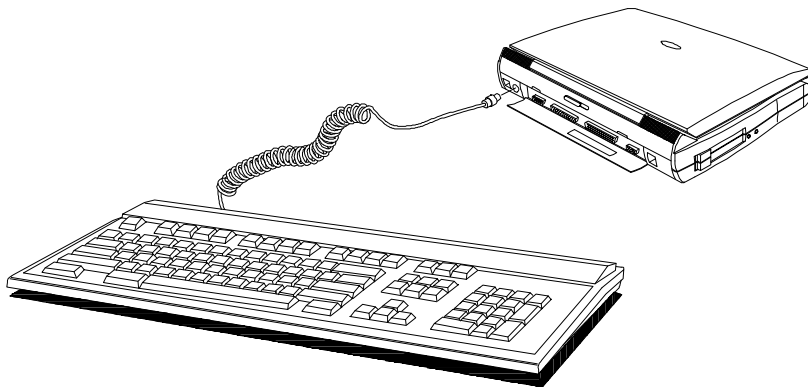



Figure 4-2 Connecting an External Keyboard



If you need to connect both external keyboard and PS/2 mouse simultaneously, you can purchase a PS/2 Y-cable from your dealer. See section 4.9.2.

4.3 External Keypad

You can also use a 17-key numeric keypad for number-intensive data entry applications. To connect the keypad, plug in the keypad connector to the PS/2 port ( ) at the rear of the notebook.

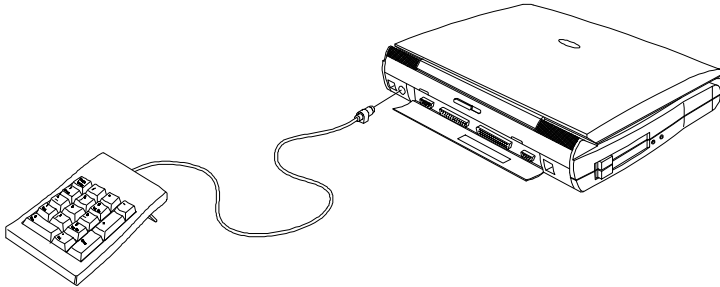

Figure 4-3 Connecting an External Keypad

4.4 External Pointing Device

This notebook accepts either a serial mouse or PS/2-compatible mouse or similar pointing device.

Connecting an External Pointing Device

Plug a serial mouse into the serial port () on the rear panel; plug a PS/2-compatible mouse into the PS/2 port ( ) on the rear panel.



To enable a serial mouse, you need to use the Add New Hardware tool in the Windows 95 Control Panel to detect and install the necessary drivers.

If you connect an external PS/2 mouse to the notebook, press  -| to enter suspend-to-memory mode. Then press any key to return to enable the external mouse. Installing an external PS/2 mouse disables the built-in touchpad.

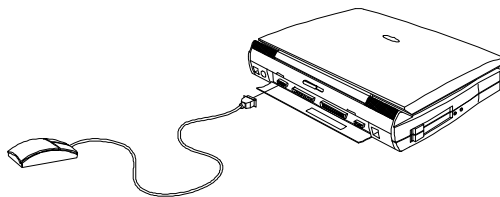

(a) Serial Mouse

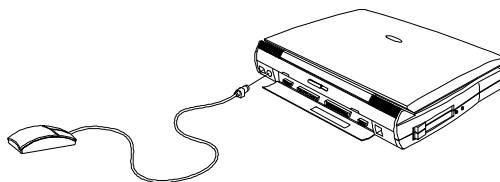

(b) PS/2 Mouse

Figure 4-4 Connecting an External Pointing Device

Setting the External Mouse Location Parameter

After connecting the external mouse or similar pointing device, press **Fn-m** to enter Setup and verify the location of the external pointing device. Select Power Saving Options to display the following screen:

Power Saving Options		Page 1/1
When Lid is Closed -----	[Suspend to Disk]	
Suspend to Disk on Critical Battery -	[Enabled]	
Display Always On -----	[Disabled]	
Internal Speaker -----	[Enabled]	
External Mouse Location -----	[PS/2]	
Internal Modem -----	[Power-Off]	
Resume On Modem Ring -----	[OFF]	
Resume On Schedule -----	[OFF]	
Resume Date -----	[12/31/99]	
Resume Time -----	[23:59:00]	

↑ ↓ = Move Highlight Bar, → ← = Change Setting
PgDn/PgUp = Move Screen, F1 = Help, Esc = Exit

Go to the External Mouse Location parameter and select COM1 if you connected your mouse to the serial port, and PS/2 if you connected your mouse to the PS/2 port.



The External Mouse Location parameter setting allows the notebook's power management system to detect activity from the external pointing device. If you are using an external pointing device, make sure this parameter is set correctly.

4.5 Printer

This notebook supports both serial and parallel printers. For a serial printer, plug the printer cable into a serial port (ⓁⓁⓁⓁⓁ). For a parallel printer, plug the printer cable into the parallel port (ⓁⓁⓁⓁⓁ). See your printer manual for operating instructions.

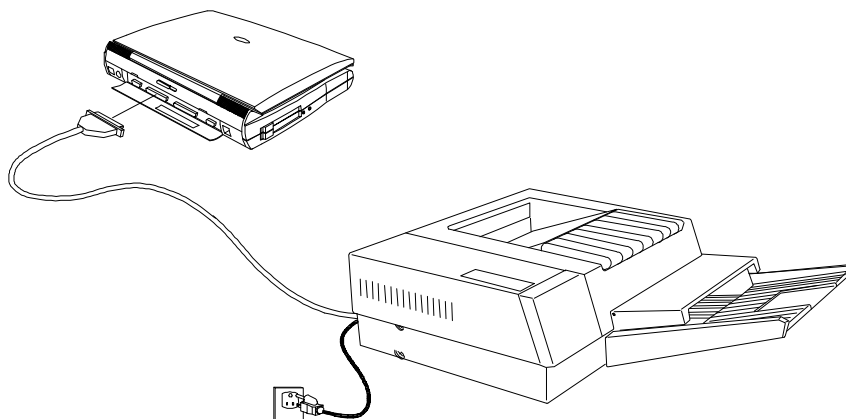

Figure 4-5 Connecting a Parallel Printer

4.6 Audio Devices

You can connect audio devices to the line-in and line-out ports on the notebook. The line-in audio port doubles as a microphone-in port as well.

The line-in port accepts an external 3.5mm mini-jack microphone or other line-in devices. The line-out port accommodates external amplified speakers or headphones.

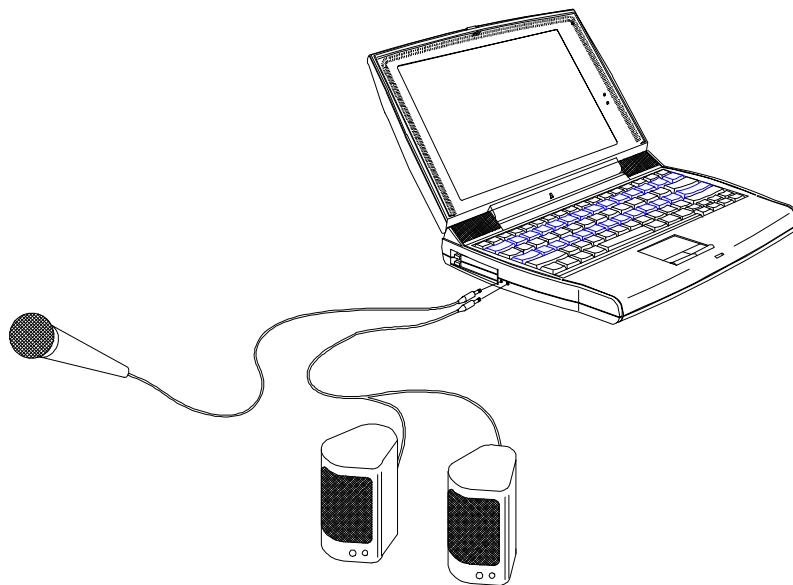

Figure 4-6 Connecting Audio Devices



To use Mic-in or Line in, insert the plug of the desired device and make sure to turn off the appropriate input from the mixer. See the multimedia section of your Windows 95 manual.

4.7 Mini Dock

The mini dock serves as a docking base that allows you to connect your notebook to all the peripherals you need, even network connections with its built-in Ethernet support. Consult your dealer for details. A quick guide is included with the mini dock for easy and quick connection instructions.

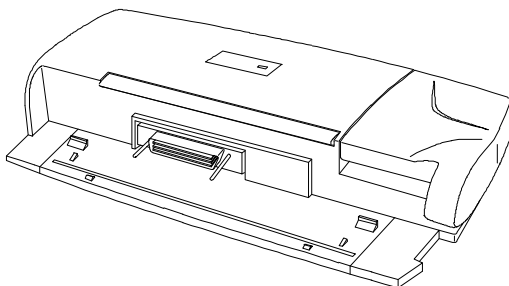

Figure 4-7 Mini Dock

4.8 PC Cards

The notebook has two PC card slots that accommodate two type I/II or one type III PC card(s). Please consult your dealer for PC card options available that you can purchase for your notebook.

4.9 Miscellaneous Options

4.9.1 Additional Power Packs

Lithium-Ion Battery Pack

It is good practice to have a spare battery pack around, especially when you travel. The Li-Ion (lithium-ion) smart battery supplies more power than a conventional NiMH (nickel metal-hydride) battery. With power management, you get even more power on-the-go.

Attaching the Battery Compartment Cover

Each battery pack comes attached with a battery compartment cover. In case the cover gets detached, follow these steps to re-attach the cover to the battery.

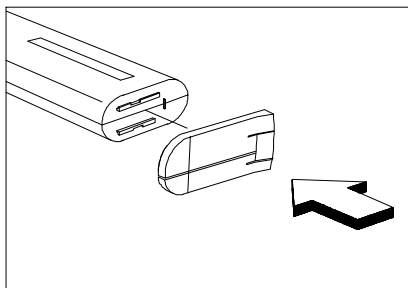

1. Position the battery compartment cover over the battery pack.

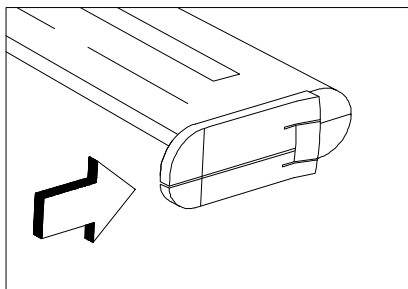

2. Using a little force, slide the battery compartment cover over the battery until both the cover and the battery are firmly attached.

Detaching the Battery Compartment Cover

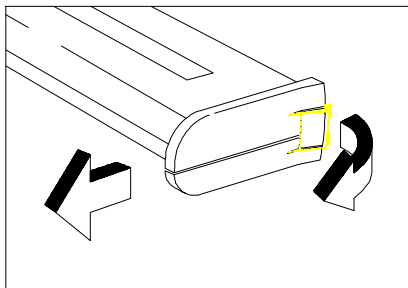

Gently pull up the battery compartment cover release latch and slide out the cover.

AC Adapter

You can purchase an additional AC adapter for your notebook or mini docking station.

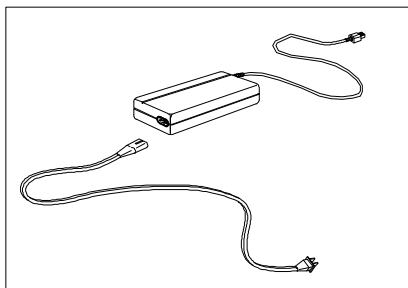

The compact AC adapter charges your battery pack and supplies power to your notebook.

4.9.2 Cables

Floppy Drive Cable

The floppy drive cable allows you to use your floppy drive module externally.

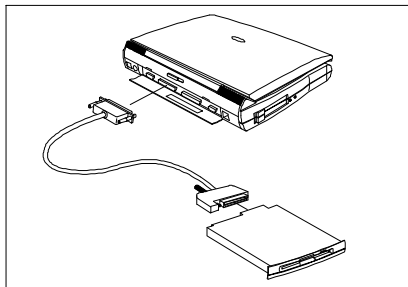

Open the port cover of the notebook and connect the 25-pin connector end of the floppy drive cable to the parallel port. Then connect the other end to the floppy drive module.

PS/2 Y-Bridge Cable

The PS/2 Y-bridge cable allows you to connect two PS/2 devices, mouse and keyboard, to your notebook simultaneously.

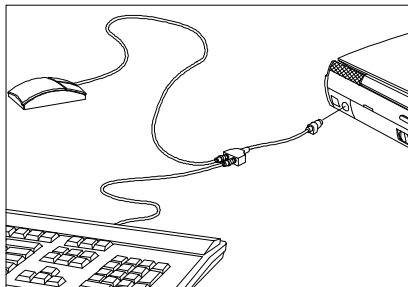

Connect the single connector end of the Y-bridge cable to the notebook's PS/2 port and the double connector ends to the two PS/2 devices.

Take note of the icons on the double connector before connecting the devices.

File Transfer Cable

For non SIR- (serial infrared) capable connections, you can use the file transfer cable to transfer data between the notebook and other computers. Connect the file transfer cable between the two computers and use your file transfer utility to perform the transfer.

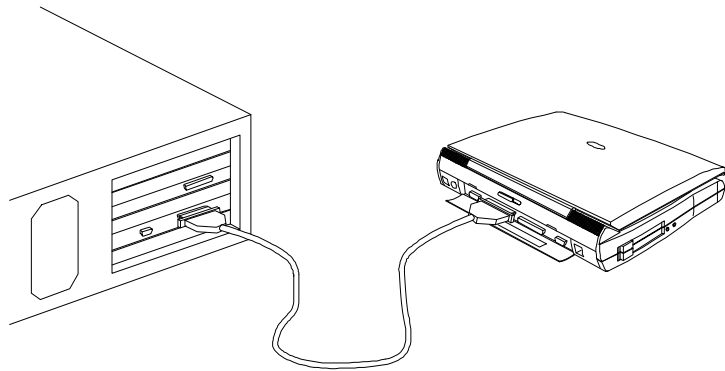

Figure 4-8 Using the File Transfer Cable

4.10 Key Component Upgrades

This notebook delivers the power and performance you need. However, some users and the applications they use may demand more. This notebook allows you to upgrade key components when you need increased performance.



Contact your authorized dealer if you decide to perform an upgrade.

4.10.1 Additional Memory

Memory is upgradeable from 8 to 64 MB, employing 64-bit soDIMMs (small outline Dual Inline Memory Modules) in 8, 16 and 32 MB configurations. The following table lists all possible memory configurations.

Table 4-1 Memory Configurations

Slot 1	Slot 2	Total Memory
0 MB	8 MB	8 MB
8 MB	0 MB	8 MB
8 MB	8 MB	16 MB
0 MB	16 MB	16 MB
16 MB	0 MB	16 MB
8 MB	16 MB	24 MB
16 MB	8 MB	24 MB
16 MB	16 MB	32 MB
0 MB	32 MB	32 MB
32 MB	0 MB	32 MB
8 MB	32 MB	40 MB
32 MB	8 MB	40 MB
16 MB	32 MB	48 MB
32 MB	16 MB	48 MB
32 MB	32 MB	64 MB

Installing Memory



When installing memory, we recommend you seek the help of a qualified service technician. Improper installation may damage the memory module or the notebook, or cause a malfunction.

One of the two memory slots (Slot 2) is accessible via a memory expansion door on the base of the notebook. Follow these steps to install an additional memory module.

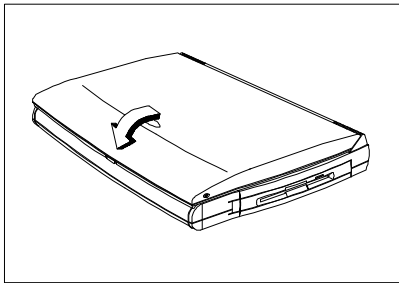

1. Do a Windows 95 shutdown.

If you are not using the notebook under Windows 95, you can use the Power-Off option by accessing the Eject Menu (Fn-t).

2. Close the display lid.

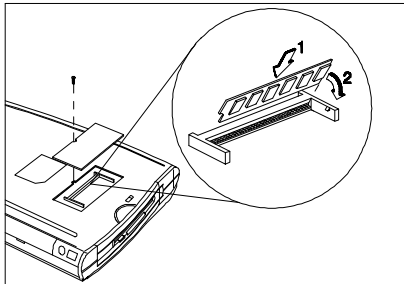

3. Turn the notebook over to access the base.
4. Remove the screw that secures the memory door and lift it up.
5. (1) Insert the memory module diagonally into the slot, then (2) gently press down the module until it clicks into place.

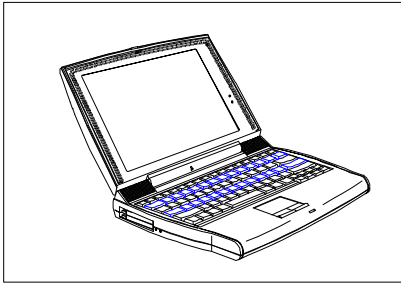

6. Replace the memory door and secure it with the screw.
7. Open the display to turn on the notebook.

After new memory modules have been installed, the system automatically detects and reconfigures the total memory size.

To upgrade memory installed in the other slot (Slot 1), contact your dealer.

4.10.2 Hard Disk

You can have your hard disk upgraded to one with a higher capacity. The notebook uses a 2.5-inch Enhanced-IDE hard disk that is auto-detected by the system. The following table shows the currently supported hard disks.

Table 4-2 Hard Disk List

Vendor	Model	Capacity	Cylinders	Heads	Sectors
IBM	DPRA-21215	1.2 GB	2358	16	63
IBM	DMCA-21440	1.44 GB	2800	16	63
IBM	DCRA-22160	2.0 GB	4200	16	63

Consult your dealer for additional hard disks that will be available in the future. You may use the empty spaces in the table to record these additional drives and their information.

Software

This notebook comes pre-loaded with application software and system utilities. This chapter discusses some of these applications and how to make use of them.

5.1 System Software

The notebook comes preloaded with the following software¹:

- Windows 95 or other operating systems
- System utilities and applications
 - Suspend-to-disk utility (Sleep Manager)
 - Touchpad driver
 - Display driver
 - Audio driver
 - Modem driver and application²
 - System core logic driver
 - File-transfer utility
 - PC Card slot driver and application
 - Other application software

The following sections discuss the software and how they work. For most of the software, make use of the online help provided by the software.

Accessing the Applications

To access most of the software applications, click on the Start button and select the application folder. Then click on the application icon to run the selected application.

¹ The pre-loaded software may differ.

² The modem driver and software are optimized for use only with the internal modem, and may not function properly with a different modem. For PCMCIA modems, use the software that came with your PC card modem. This driver is only preloaded on notebooks for the U.S. market.

5.2 Sleep Manager

Notebooks usually feature built-in power-saving functions. In addition to the normal standby mode for power-saving, our notebooks are also capable of a power management feature called 0-volt suspend to hard disk. When a suspend event occurs, this built-in function saves all the system's current status onto your hard disk in the form of a file. The system then shuts off the power. When the user resumes (e.g., opening the display), the system will restore the data from the hard disk and resume from where you left off upon leaving suspend mode.

Sleep Manager is a utility that reserves hard disk space needed to successfully perform the suspend-to-disk feature. The user can use this utility to create a contiguous area that resides on the hard disk. Once the reserved space is created, the notebook will be capable of the "0-Volt Suspend to Hard Disk" feature. User can also use this utility to remove the reserved space from the disk. In this case, the machine will not be able to enter 0-volt suspend mode.

Sleep Manager is functionally-connected with the Advanced Power Management (APM) system of Microsoft Windows. Sleep Manager uses many advanced APM functions. Sleep Manager is capable of auto-create and auto-recover features. If the system memory size was changed or the reserved space on the hard disk was corrupted, Sleep Manager will reallocate the hard disk space for you automatically.

5.2.1 Accessing the Sleep Manager

There are two ways to bring up the Sleep Manager:

- Taskbar. Double-click on the Sleep Manager status icon if enabled.
- Start menu
 1. Click on the Start button.
 2. Select Programs.
 3. Select 0V Suspend Utility.
 4. Select Sleep Manager.

The Sleep Manager displays below:

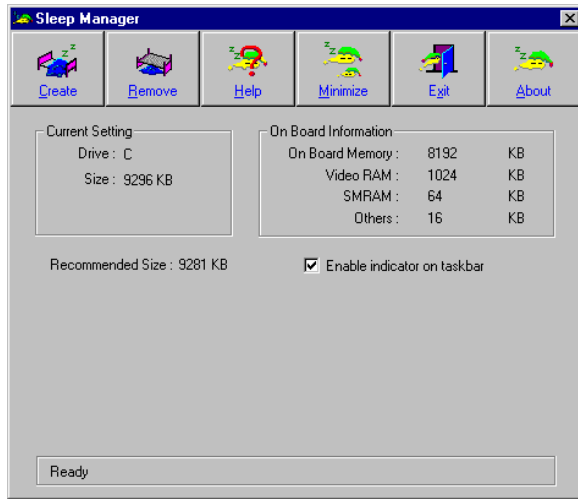

Table 5-1 Sleep Manager Window Items

Item	Description
Buttons	Click to access the Sleep Manager functions
Current Setting	Displays the drive and size of the current reserved space created by Sleep Manager.
On Board Information	<p>Displays the different areas of system memory and their respective values. These system resources need to be stored before the system can enter 0-volt suspend mode, so the system can resume to the previous state successfully.</p> <p>These system resources are the contents of:</p> <ul style="list-style-type: none"> • Onboard memory (DRAM or dynamic memory) • Video RAM (VRAM or video memory) • SMRAM (static memory) • Others <p>The total size of these system resources is displayed as the recommended size in the dialog box.</p>

Table 5-1 Sleep Manager Window Items (continued)

Item	Description
Recommended Size	Displays the minimum size of the contiguous space you need for the 0-volt suspend-to-disk feature. The actual size may be a little bit more due to file system alignment.
Enable Indicator on the Taskbar	When this checkbox is checked, the Sleep Manager status appears on the taskbar. Double-click on the Sleep Manager status icon on the taskbar to bring up the main program, or simply rest your mouse pointer on the icon to display the current status.

5.2.2 Sleep Manager Functions

Create

The main purpose of Sleep Manager is to find and reserve a contiguous area on the hard disk. The user can allocate the space themselves by using the 'Create' function on the Sleep Manager utility. Once a suspend event occurs, the system will enter the suspend mode. If the user did not create the space or the system DRAM size been changed, Sleep Manager is invoked and begins the process of creating a space for the system.

When you click on the **Create** button, a dialog box pops up:

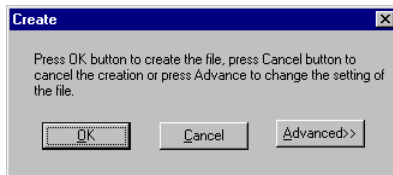

You can select **OK** to automatically create space for the 0-volt suspend feature. Sleep Manager displays the recommend size based on onboard system information. You can also choose **Advance>>>** to manually set the space settings and size. The advanced screen shows.

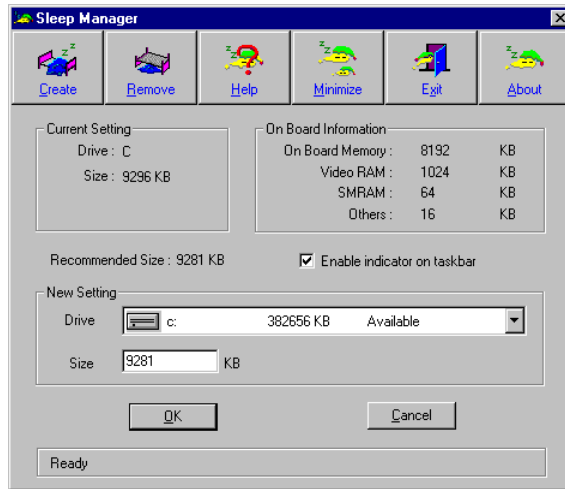

Sleep Manager automatically checks the system configuration and displays the recommended size. The drive where the space will be created is defined by the system and will be the first available logical drive which has the requested contiguous free disk space on it. The recommended size is the minimum size needed to save the current system status.

If the program cannot find the required space on the hard disk during the space creation process, it shows a message box to inform the user.

Not Enough Space for Allocation

This is a common error message that appears when Sleep Manager is creating the space on the hard disk. There are several different reasons that may cause this error. One of the reasons is that the size of the free disk space on the specific drive is less than the required size. For example, if the onboard memory is 4MB and the VGA memory is 512KB, the total free disk space required will be 4608KB. If the total free disk space is less than 4608KB, the user has to delete some unnecessary files from the hard disk.

Another possible reason is that the hard disk has enough free space, but this free space exists as small fragments. The free disk space that Sleep Manager requires needs to be contiguous. To solve this problem, the user can use tools such as SpeedDisk (Norton Utilities) or Disk Defragmenter (Windows 95) to compact these free disk spaces. The user can then run Sleep Manager utility again to reserve the space.

Another factor that causes the error is when the user employs disk compression utilities. Sleep Manager can work with most compression software. However, Sleep Manager can only create the space on a host drive. A host drive stores original file information and will not be compressed. The free space on the host drive is usually very small, so the user should use the command provide by these compression software to enlarge the size of the host (uncompressed) drive for Sleep Manager.

Remove

If you want to use or take back the reserved space, use the delete function of Sleep Manager by clicking on the Remove button. This deletion will result in the system not being able to enter 0-volt suspend mode. Instead, the system will only be able to enter standby mode.

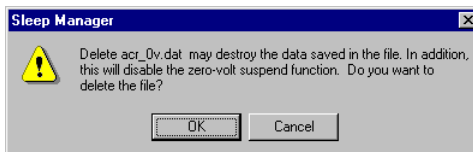

Minimize

The user can minimize Sleep Manager by selecting the Minimize button. If the Enable indicator on taskbar is checked, Sleep Manager will then switch to the background by locating itself on the taskbar. You can pop-up the main program of Sleep Manager again by double-clicking whenever needed. If the Enable indicator on the taskbar is not checked, you have to select the Sleep Manager item from 0-Volt Suspend Utilities menu of Start button.

Exit

The user can exit Sleep Manager by selecting the Exit button. Sleep Manager will then quit and disable the capability of auto-adjusting the reserved space size. Disconnecting this feature is NOT recommended.

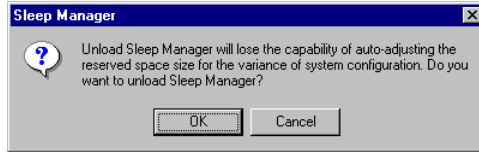

5.2.3 Running Sleep Manager

Once Sleep Manager is installed on the disk, the system automatically loads this utility every time you start Windows 95. Sleep Manager resides in the background by appearing on the taskbar.



To change the settings of Sleep Manager, simply double-click on the Sleep Manager icon (🟢🟡) on the taskbar, or run the Sleep Manager program from the 0-Volt Suspend to Disk Utilities in the Programs menu.

The Sleep Manager icon may or may not appear on the taskbar. A checkbox in the Sleep Manager main screen determines whether to enable or disable the icon on the taskbar. When Sleep Manager has not created the space to be used for 0-volt suspend or if APM is not enabled, the exclamation icon will appear. If both Sleep Manager has not created the space to be used for 0-volt suspend and APM is not enabled, the icon appears with a red crossed circle .

5.2.4 Sleep Manager Troubleshooting Tips

The following table lists the error messages you may receive with their corresponding solutions:

Table 5-2 Sleep Manager Error Messages and Solutions

Error Message	Solution
BIOS not compliant with Sleep Manager.	Sleep Manager can only run on notebooks with a BIOS compatible with this computer.
This machine does not have a power management unit. You cannot run Sleep Manager without PMU.	Sleep Manager can only work on notebooks installed with a PMU.
The APM driver for Windows is not installed. Use Windows Setup to install the APM driver before you run Sleep Manager.	See section 3.2.3 for steps on how to enable APM on your notebook.
Requested disk space is not enough / The created file is not contiguous.	If the free space is actually greater than the requested free space but not contiguous, use the Windows 95 defragment utility Disk Defragmenter to compact the hard disk drive space. Then run Sleep Manager again. If you run Sleep Manager under a DoubleSpace environment, make sure the free space on the host drive is larger than the required size for Sleep Manager.
The [directory name] directory cannot be created. Enter another directory or try another drive.	The directory name that the user specified is not valid. Note that the user can create only one subdirectory at a time.
The software has not been successfully installed. You must run Setup again.	Sleep Manager is not completely installed. Try to install again.

5.2.5 Uninstalling Sleep Manager

Uninstalling Sleep Manager will delete all files and all system information for Sleep Manager, it loses the capability of auto-adjusting the reserved space size for the system configuration changes or modifications, though the 0-volt suspend feature still functions

To uninstall Sleep Manager from the Windows, follow these steps:

1. Quit the Sleep Manager if it is still running.
2. Click on the Start button and select the Control Panels folder from Settings.
3. Open the Add/Remove Programs Icon.

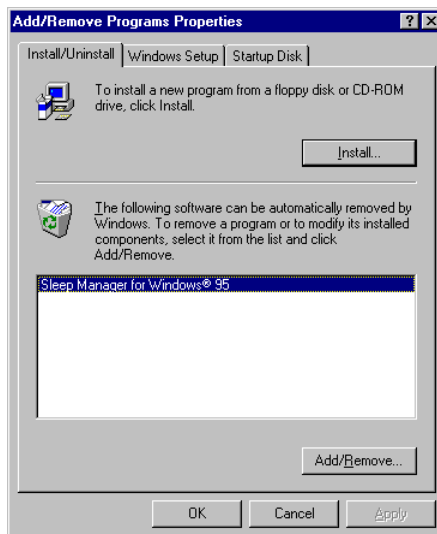

4. Select the Sleep Manager for Windows 95 and click on **Add/Remove....**
5. Follow the screen instructions to complete the uninstallation program.



With Sleep Manager installed and the When Lid is Closed parameter in Setup set to [Suspend to Disk], the notebook enters suspend-to-disk mode when you close the display. The notebook also enters this mode when battery is critically low if the Suspend to Disk on Critical Battery parameter in Setup is set to [Enabled], regardless of the When Lid is Closed setting.

Opening the display returns the notebook to its previous state prior to entering suspend-to-disk mode.

Do not deactivate or uninstall Sleep Manager and do not remove or delete the zero-volt suspend/resume file. Otherwise, the function will not work — the notebook will only enter suspend-to-memory mode and not suspend-to-disk mode.

5.3 Touchpad Driver

The touchpad works with most mouse drivers, but the touchpad driver supports special functions that work uniquely with the touchpad. The touchpad driver enhances the Mouse dialog box to include these special features.

5.3.1 Configuring the Touchpad

Follow these steps to configure the touchpad:

1. Click on the Start button, then select Settings...
2. Select Control Panel to display the Control Panel Window.
3. Double-click on the Mouse icon and select TouchPad.

You can configure different aspects of the touchpad. Refer to the online help for details.

Setup

The notebook has a BIOS (Basic Input/Output System) setup utility that allows you to configure the notebook and its hardware settings. This chapter tells how to use the Setup utility and describes each parameter item in the setup screens.

6.1 When to Use Setup

The notebook is already correctly configured for you and you do not need to run Setup. If you make any changes to the notebook or you receive an Equipment Configuration Error message after you turn on the notebook, you may need to run Setup. Run Setup also if you want to do any of the following:

- Check the system configuration
- Change the system date, time or speed
- Add or change the location of the external mouse
- Change the system startup sequence
- Set the power-saving suspend mode type
- Set or change resume options
- Set, change, or remove a system password



The system configuration values reside in the battery-powered CMOS RAM.

6.2 Entering Setup

Press -m to enter Setup. The BIOS Utility main screen displays.

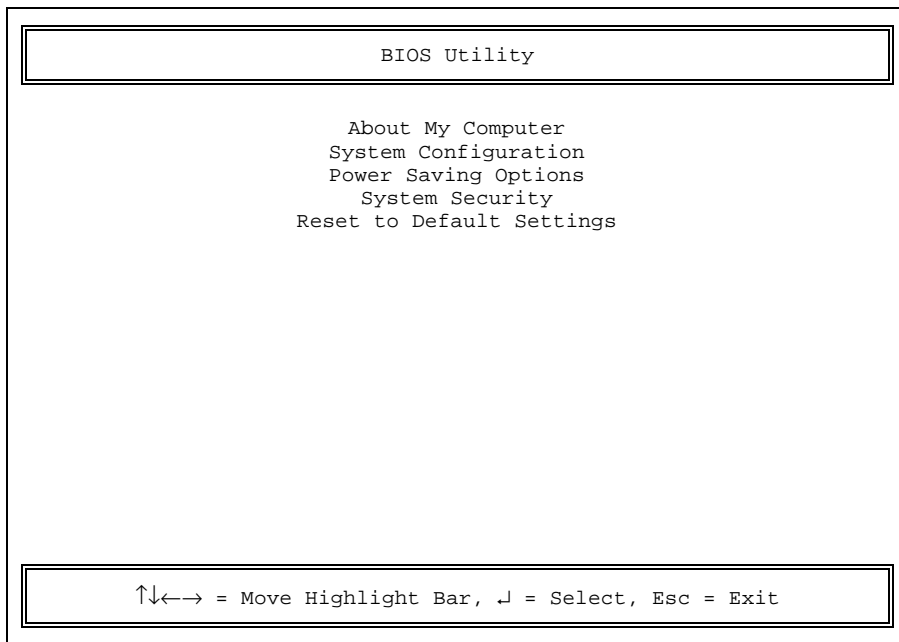

There are five main menu items:

- About My Computer
- System Configuration
- Power Saving Options
- System Security
- Reset to Default Settings

Press w, y, z or x to move from one menu item to another and press e to enter the selected menu. Press | to exit Setup.

6.3 About My Computer

About My Computer gives you clear-cut information about your notebook PC. The following screen is the first of two pages in this section.

```

About My Computer                                     Page 1/2

System Architecture : MARS 1996-1997
  System BIOS      : BIOS V2.0
  System ID       : VGA010602, KBC010607, SMC010023, SMM010210
  Processor       : Pentium MMX / 150MHz
  Coprocessor     : Integrated
Internal Cache (L1) : 16KB, Enabled
External Cache (L2) : 256KB, Enabled
  Total Memory    : 16 MB
  Bank A         : 0 MB
  Bank B         : 16 MB
Graphics Controller : 128-bit Graphics Acceleration
  Display Output  : TFT, 800x600
  Hard Drive 0   : Hard Disk, 1160MB
  Hard Drive 1   : CD-ROM
  Floppy Drive A : 1.44 MB 3.5-inch
  Floppy Drive B : None

PgDn/PgUp = Move Screen, Esc = Exit
```

Press } to view the second page.

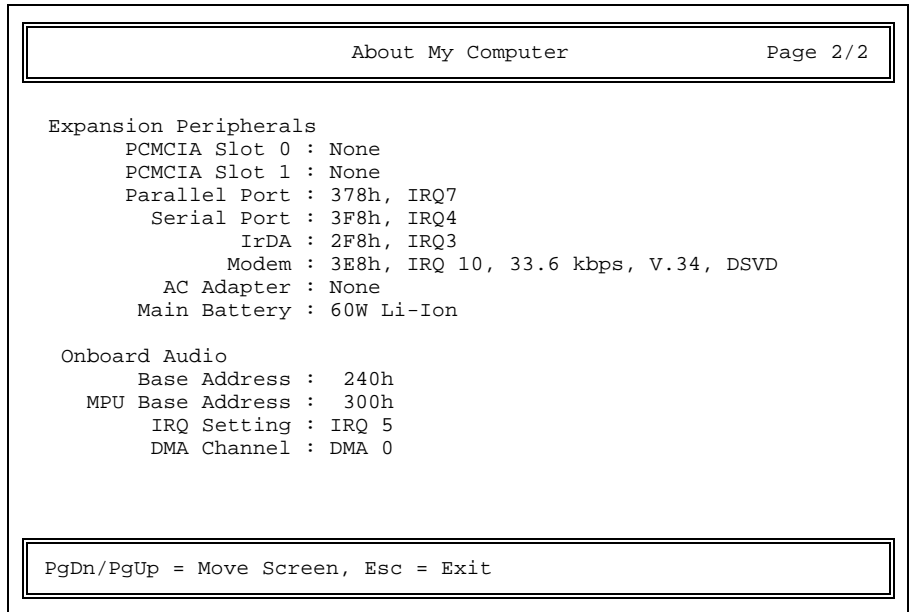

Press { to return to the first page.

About My Computer Items

These screens display the current status of the notebook and its peripherals. The items in this screen are not user-configurable.

Table 6-1 About My Computer Item Descriptions

Item	Description
System	
System Architecture	System architecture information
System BIOS	BIOS manufacturer and version
System ID	ID information on major components
Processor	Processor type and speed
Coprocessor	Coprocessor type

Table 6-1 About My Computer Item Descriptions (continued)

Item	Description
Internal Cache (L1)	Internal cache size and whether it is enabled or not
External Cache (L2)	External cache size and whether it is enabled or not
Total Memory	Total memory size
Bank A	Bank A memory module size, type and speed
Bank B	Bank B memory module size, type and speed
Graphics Controller	Graphics controller type
Display Output	Display type and resolution
Hard Drive 0	IDE 0 drive type and size (hard disk)
Hard Drive 1	IDE 1 drive type (CD-ROM or other IDE drives)
Floppy Drive A	Floppy drive A type
Floppy Drive B	Floppy drive B type
Expansion Peripherals	
PCMCIA Slot 0	Card presence in slot 0 (detected by the socket service)
PCMCIA Slot 1	Card presence in slot 1 (detected by the socket service)
Parallel Port	Parallel port base address and IRQ
Serial Port	Serial port base address and IRQ
IrDA	Infrared port base address and IRQ
Modem	Modem address and other information
AC Adapter	Connected AC adapter information
Main Battery	Installed battery type information
Onboard Audio	
Base Address	Audio base address
MPU Base Address	Audio MPU-401 base address
IRQ Setting	Audio IRQ setting
DMA Channel	Audio DMA channel

Press | to return to the main screen.

6.4 System Configuration

The following screen is the basic system configuration screen.

Basic System Configuration		Page 1/1		
Current Date -----	[09/16/96]			
Current Time -----	[16:30:35]			
Diskette Drive A -----	[1.44 MB 3.5-inch]			
Diskette Drive B -----	[None]			
		Cylinder	Head	Sector
Hard Disk 0 (1160 MB) -----	[Auto]	2358	16	63
Hard Disk 1 (0 MB) -----	[Auto]	0	0	0
Num Lock After Boot -----	[Disabled]			
LCD Expansion Mode -----	[Disabled]			

↑↓ = Move Highlight Bar, ←→ = Change Setting PgDn/PgUp = Move Screen, F1 = Help, Esc = Exit
--

Press w or y to move from one parameter to another, and z or x to change parameter settings.

Most of the parameters are self-explanatory, but you can press l to get help on the selected parameter. Press | to exit the screen and return to the main menu.

6.4.1 Date and Time

The current date is in MM/DD/YYYY format. The current time is in HH:MM:SS format. The system uses a 24-hour clock which means, for example, that 6:25:50 PM appears as 18:25:50.

6.4.2 Diskette Drives

The default setting for Diskette Drive A is [1.44 MB 3.5-inch] and refers to the floppy drive whether it is installed in the module bay or connected externally via the parallel port. Diskette Drive B by default is set to [None], and is only enabled if two floppy drives are connected to the notebook.

6.4.3 Hard Disks

The Hard Disk 0 parameter is reserved for the hard disk. With this parameter set to [Auto], the BIOS automatically detects the hard disk parameters and displays the formatted capacity in the parentheses right after the Hard Disk 0 parameter heading. It also displays the cylinder, head and sector values of the hard disk. Advanced hard disk settings are auto-configured by Setup for optimum drive performance.

You can also choose to key-in the drive parameters by setting Hard Disk 0 to [User]. To determine your drive parameters, check the data found on your hard disk or supplied in the hard disk vendor documentation. We suggest that you set this parameter to [Auto] to allow the BIOS to auto-detect the drive parameters at each boot-up.

The Hard Disk 1 parameter is used when a CD-ROM drive module or future IDE drive option is installed in the module bay. The default setting for both parameters is [Auto].

6.4.4 Num Lock After Boot

When enabled, Num Lock turns on after boot and the embedded keypad acts as a numeric keypad. The default setting is [Disabled].

6.4.5 LCD Expansion Mode

When enabled, the LCD screen shows in expanded mode. By default, this parameter is set to [Disabled].

For advanced users, the System Configuration section has two hidden pages called Advanced System Configuration that allow you to view and configure more technical aspects of the notebook.



The notebook's BIOS configuration is already tuned for optimum performance and you do not need to access these screens. If you do not fully understand the items in these special screens, do not attempt to change their values.

If you happen to change the values and decide you want to return the previous values, select the Reset to Default Settings in the main menu to restore all default values.

To access the Advanced System Configuration screens, press `s` from the main menu. Then select System Configuration to enter the System Configuration screens. Note that the pages in this section now total three. Press `}` to access the first of two hidden screens.

```
Advanced System Configuration                               Page 2/3

Internal Cache(CPU Cache) ----- [Enabled]
  Cache Scheme ----- [ Write Back ]
External Cache ----- [Enabled]

Enhanced IDE Features Hard Disk 0
  Hard Disk Size > 504MB ----- [DOS/Win3.x/Win95]
  Multiple Sectors Read/Write -- [ Auto ]
  Advanced PIO Mode ----- [ Auto ]
  Hard Disk 32-Bit Access ----- [ Auto ]

Enhanced IDE Features Hard Disk 1
  Hard Disk Size > 504MB ----- [DOS/Win3.x/Win95]
  Multiple Sectors Read/Write -- [ Auto ]
  Advanced PIO Mode ----- [ Auto ]
  Hard Disk 32-Bit Access ----- [ Auto ]

↑ ↓ = Move Highlight Bar, → ← = Change Setting
PgDn/PgUp = Move Screen, F1 = Help, Esc = Exit
```

Press } again to access the next hidden screen.

```
Advanced System Configuration                               Page 3/3

Onboard Communication Ports
  Serial Port Base Address --- [3F8h, IRQ4]
  IrDA Base Address ----- [2F8h, IRQ3]
  Modem Base Address ----- [ 3E8h ]
  IRQ Setting ----- [10]
  Parallel Port Base Address - [378h, IRQ7]
  Operation Mode ----- [ Standard and Bidirectional ]
  ECP DMA Channel ---- [-]

Onboard Audio ----- [Enabled ]
  Base Address ----- [240h]
  MPU Base Address ----- [300h]
  IRQ Setting ----- [ 5]
  DMA Channel ----- [0]

Reset PnP Resources ----- [No ]

↑ ↓ = Move Highlight Bar, → ← = Change Setting
PgDn/PgUp = Move Screen, F1 = Help, Esc = Exit
```

6.4.6 Internal Cache

Internal cache refers to cache built into the CPU. When enabled, this setting boosts system performance. It is also called CPU cache or L1 (level one) cache. The default setting is [Enabled].

The Cache Scheme parameter accepts two values:

- Write Back
- Write Through

which determines how the system uses the internal cache. The default setting is [Write Back].

6.4.7 External Cache

External cache greatly increases system performance by lessening the load of main memory. It is also called L2 (level 2) cache. The default setting is [Enabled].

6.4.8 Enhanced IDE Features

The Enhanced IDE Features section includes four parameters for optimizing hard disk performance. These performance features depend on drive support. Newer drives support most or all of these features.



As much as possible, set these parameters to [Auto] (when the option to do so is available). This allows the notebook to use the hard drive with the highest possible performance level.

Hard Disk Size > 504MB

If your hard disk size is greater than 504MB and you are operating in a DOS-based environment, this parameter should be set to [DOS/Win3.x/Win95]. If you operate in NetWare, UNIX and Windows NT environments, set this parameter to [Others]. The default setting is [DOS/Win3.x/Win95].

Multiple Sectors Read/Write

This parameter enhances hard disk performance by reading/writing more data at once. The available values include:

- Auto
- 16 sectors
- 8 sectors
- Disabled

The highest value, 16 sectors, may not give you the best performance every time, because hard disks behave differently. The default setting, [Auto], allows the system to adjust itself to the optimum read/write setting.

Advanced PIO Mode

Advanced PIO (Programmed Input/Output) Mode enhances drive performance by optimizing the hard disk timing. The available values include:

- Auto
- Mode 0

The default setting is [Auto].

Hard Disk 32-Bit Access

This parameter allows your hard disk to perform 32-bit access, an increase from the original 16-bit access. The available values include:

- Auto
- Disabled

The default setting is [Auto].

6.4.9 Onboard Communication Ports

The Onboard Communication Ports section includes settings for the serial and parallel ports on the notebook. The addresses in this screen are all expressed in hexadecimal.



Resource conflicts are prevented by not allowing you to set the same IRQ and address values for different devices.

Serial Port Base Address

This parameter accepts the following values:

- [3F8h, IRQ 4]
- [2F8h, IRQ 3]
- [3E8h, IRQ 4]
- [2E8h, IRQ 3]
- [Disabled]

The default setting is [3F8h, IRQ 4].

IrDA Base Address

This parameter accepts the following values:

- [2F8h, IRQ 3]
- [Disabled]

The default setting is [2F8h, IRQ 3].

Modem Base Address and IRQ Setting

This parameter accepts the following values:

- [3E8h]
- [2E8h]
- [Disabled]

The default setting is [3E8h].

The IRQ Setting parameter for the modem accepts 3, 4, 5, 7 or 10 as its value. The default setting is [10].

Parallel Port Base Address, Operation Mode and ECP DMA Channel

The Parallel Port Base Address parameter accepts the following values:

- [378h, IRQ 7]
- [3BCh, IRQ 7]
- [278h, IRQ 5]
- [Disabled]

The default setting is [378h, IRQ 7].

The Operation Mode parameter for the parallel port accepts the following:

- [Standard and Bi-directional]
- [Enhanced Parallel Port (EPP)]
- [Extended Capabilities Parallel Port (ECP)]

Enhanced Parallel Port (EPP) provides greater throughput by supporting faster transfer times and a mechanism that allows the host to address peripheral device registers directly. Extended Capabilities Port (ECP) supports a 16-byte FIFO (first in, first out) which can be accessed by host DMA cycles and PIO cycles.

The default setting is [Standard and Bi-directional].

The ECP DMA Channel parameter lets you set the DMA channel used for ECP mode. You are required to set a value for this parameter if you select ECP as your parallel port operation mode. It accepts 1 or 3 as its value.

6.4.10 Onboard Audio

This parameter lets you enable or disable the onboard audio functionality of the notebook. This section also includes settings for onboard audio. The default setting is [Enabled].

Base Address

This parameter accepts the following values:

- [220h]
- [230h]
- [240h]
- [250h]

The default setting is [240h].

MPU Base Address

This parameter accepts the following values:

- [300h]
- [310h]
- [320h]
- [330h]

The default setting is [300h].

IRQ Setting

This parameter accepts 10, 7, 5 or 9 as its value. The default setting is [5].

DMA Channel

This parameter accepts 0, 1 or 3 as its value. The default setting is [0].

6.4.11 Reset PnP Resources

The system resources are already properly configured. If resource conflicts should arise, set this parameter to [Yes] to reset the PnP resources and re-do allocation. The BIOS automatically sets this to [No] afterwards.

The default setting is [No].

6.5 Power Saving Options

The following screen is the power saving options screen.

```
Power Saving Options                                     Page 1/1

When Lid is Closed ----- [ Suspend to Disk ]
Suspend to Disk on Critical Battery - [Enabled ]

Display Always On ----- [Disabled]
Internal Speaker ----- [Enabled ]
External Mouse Location ----- [PS/2]
Internal Modem ----- [Power-On]

Resume On Modem Ring ----- [OFF]
Resume On Schedule ----- [OFF]
  Resume Date ----- [09/16/96]
  Resume Time ----- [16:30:35]

↑ ↓ = Move Highlight Bar, → ← = Change Setting
PgDn/PgUp = Move Screen, F1 = Help, Esc = Exit
```

Press w or y to move from one parameter to another, and z or x to change parameter settings.

Most of the parameters are self-explanatory, but you can press l to get help on the selected parameter. Press | to exit the screen and return to the main menu.

6.5.1 When Lid is Closed

The notebook's lid switch acts as its power switch. Simply put, opening the display wakes up the notebook; closing the display puts it to sleep. The When Lid is Closed parameter determines which suspend mode the notebook enters when the display is closed. There are [three](#) settings for this parameter:

- Suspend to Memory
- Suspend to Disk
- [Sleep Mode](#)

With this parameter set to [Suspend to Memory], the notebook enters suspend-to-memory mode (saving all data into memory) when you close the display or press the suspend hot key  -| (**Z**). The notebook wakes up when you open the display or press any key.

With the parameter set to [Suspend to Disk], the notebook enters suspend-to-disk mode (saving all data into the hard disk) when you close the display. The notebook wakes up when you open the display again.

[With the parameter set to \[Sleep Mode\], the notebook maintains the active network and modem connections when you close the display. The notebook wakes up when you open the display again.](#)



If an external monitor is connected to the notebook, the notebook will not enter suspend mode if you close the display. To enter suspend mode, disconnect the monitor plug, open the display and close the display again.



The Sleep Manager automatically creates a suspend-to-disk file when it is run. If the file becomes invalid, the notebook will be unable to enter suspend-to-disk mode, and enters suspend-to-memory mode.

6.5.2 Suspend to Disk on Critical Battery

With this parameter set to [Enabled], the notebook enters suspend-to-disk mode when the battery becomes critically-low. The default setting is [Enabled].

6.5.3 Display Always On

This parameter lets you specify whether the display is always on or not. When enabled, the screen will not blank. The default setting is [Disabled] to save power.

6.5.4 Internal Speaker

This parameter lets you turn the internal speaker on and off. The default setting is [Enabled].

You can also do this by pressing the speaker on/off toggle hot key  -r. Pressing this hot key changes this parameter setting in Setup.

6.5.5 External Mouse Location

This parameter lets you specify the location of your mouse or similar pointing device. Four settings are available for this parameter:

- COM 2
- COM 1
- PS/2

Since the touchpad is a PS/2-compatible device, the default setting is [PS/2]. If you connect an external PS/2 mouse or similar pointing device, you do not need to change the setting. If, however, you want to use an external serial mouse, change this parameter setting accordingly.

6.5.6 Internal Modem

For models with an internal modem, set this parameter to [Power-On] when you are using the internal modem. If you are not actively using the internal modem, you can set this parameter to [Power-Off] to conserve power. The default setting is [Power-On].

6.5.7 Resume On Modem Ring

You can set the notebook to resume from suspend-to-memory mode upon detection of a specific number of modem rings, ranging from 1 to 7.

Enabling this option overrides the suspend-to-disk function.

6.5.8 Resume On Schedule

When enabled, the notebook resumes from suspend-to-memory mode at the specified Resume Date and Resume Time settings.

Enabling this option overrides the suspend-to-disk function.

6.5.9 Resume Date / Resume Time

The Resume Date and Resume Time parameters let you set the date and time for the resume operation. The date and time fields take the same format as the System Date and Time parameters in the System Configuration screen.

If you set a date and time prior to the time of suspend, this field is automatically disabled. A successful resume occurring from a date and time match also automatically disables this field.

6.6 System Security

The following screen is the system security screen.



If a password is currently present, the system prompts you to input the password before entering the System Security screen.

System Security		Page 1/1
Supervisor Password -----	[None]	
User Password -----	[None]	
Disk Drive Control		
Diskette Drive -----	[Normal]	
Hard Disk Drive -----	[Normal]	
Start Up Sequences -----	[A: then C:]	
Flash New BIOS -----	[Disabled]	

↑↓=Move Highlight Bar, →←=Change Setting, F1=Help, Esc=Exit

Press w or y to move from one parameter to another, and z or x to change parameter settings.

Most of the parameters are self-explanatory, but you can press l to get help on the selected parameter. Press | to exit the screen and return to the main menu.

6.6.1 Supervisor and User Passwords

The supervisor and user passwords both prevent unauthorized access to the notebook. When these passwords are present, the notebook prompts for the user or supervisor password during system boot-up and resume from suspend. The supervisor password also gives full access to Setup. The user password give limited access to Setup.



Setup requires the supervisor password to be set prior to setting the user password.

If you enter Setup using the user password, you cannot modify the supervisor password and certain BIOS settings.

Setting a Password

To set a password:

1. Select the desired password (Supervisor or User) to set or edit, and press z or x. The password prompt (a key) appears:

2. Enter a password.

The password may consist of up to eight characters which do not appear on the screen when you type them. After typing your password, press e. Another password prompt appears:

3. Retype your password and press e to verify your first entry.

After setting a password, the notebook sets this parameter to [Present]. The next time you boot the notebook, resume from suspend mode, run the Setup utility or unlock system resources, the password prompt appears. Key in the appropriate password (Supervisor or User). The system asks for your password input until you enter the correct password.

If you forget your password, you must reset the configuration values stored in CMOS to defaults. Resetting CMOS requires opening up the system unit, so contact your dealer for assistance.

Removing a Password



If you enter Setup using the user password, you cannot modify or remove the supervisor password.

To remove a password, select the desired password to remove and press z or x.

6.6.2 Diskette Drive Control

This parameter allows you to enable or disable the read/write functions of the floppy drive. The following table summarizes the available options.

Table 6-2 Diskette Drive Control Settings

Setting	Description
Normal (default)	Floppy drive functions normally
Write-Protect	Disables any floppy drive write function. This function protects all sectors only under DOS mode.
Disabled	Disables the floppy drive

6.6.3 Hard Disk Drive Control

This parameter allows you to enable or disable the read/write functions of the hard disk. The following table summarizes the available options.

Table 6-3 Hard Disk Drive Control Settings

Setting	Description
Normal (default)	Hard disk functions normally
Write-Protect	Disables any hard disk write function. This function protects all sectors only under DOS mode.
Disabled	Disables the hard disk

6.6.4 Start Up Sequences

This parameter determines which drive the system boots from when you turn on the system. The following table lists the five possible settings.

Table 6-4 Start Up Sequences Settings

Setting	Description
A: then C: (default)	System boots from floppy drive A. If the diskette is a non-system disk, the system boots from hard disk C.
C: then A:	System boots from hard disk C. If the hard disk is a non-system disk, the system boots from floppy drive A.
A: only	System boots from floppy drive A. If the floppy drive is a non-system disk, an error message appears.
C: only	System boots from hard disk C. If the hard disk is a non-system disk, an error message appears.
CD-ROM then C: then A:	System boots from a CD-ROM disc if one is installed in the CD-ROM drive. If no disc is present, the system boots from the hard disk C. If the hard disk is a non-system disk, then the system boots from floppy drive A.

6.6.5 Flash New BIOS



Contact your authorized dealer if you need to upgrade your BIOS.

6.7 Reset to Default Settings

Selecting this option allows you to load all the default settings. These settings are the values initially stored in CMOS RAM intended to provide high performance. If in the future you change these settings, you can load the default settings again by selecting this option.

When you select this option, the following prompt appears:

```
Reset to Default Settings
Are you sure?

[Yes]      [No]
```

Select [Yes] to load the default settings or [No] to abort the operation.

Traveling with the Notebook

This chapter tells you what to do when traveling with the notebook. This chapter also includes a list of our worldwide offices and contact information.

7.1 Travel Preparations

Follow these steps to prepare the notebook for travel:

1. Make diskette or tape backup copies of important files on the hard disk.
2. Close the display to turn off the notebook and all peripherals.
3. Make sure the display is properly closed. The display cover latch must be secure.
4. Disconnect the AC adapter and all peripherals.
5. Place the notebook, AC adapter, extra battery pack and other accessories you may need (such as modules and user documentation) in a carrying bag.
6. Hand-carry the notebook. Do not check it in as luggage!



The notebook can pass through airport X-ray equipment, but metal detectors may damage the notebook (i.e., hard disk).

7. Check with your airline if you plan to use the notebook on the aircraft.
8. When traveling in another country, check that the local AC voltage and the AC adapter power cord specifications are compatible. If not, purchase a power cord that is compatible with the local AC voltage. Do not use converter kits sold for appliances to power the notebook.
9. If you use a PC card modem with your notebook, check if the PC card modem and connector is compatible with the telecommunications system of the country you are traveling in.

7.2 International Traveler's Warranty

Your notebook is backed by an international traveler's warranty (ITW) that gives you security and peace of mind when traveling. Our worldwide network of service centers are there to give you a helping hand. Simply fill up and return the ITW application form to avail of this unique service.

Below is a list of Acer-authorized ITW service sites.



Have your ITW card number ready when you call. For updated sites and more information on ITW, see the ITW brochure.

Acer America Corporation (AAC)

399 West Trimble
San Jose, CA 95131, USA
Tel: 1-408-922-2995 / 1-800-445-6495
Fax: 1-408-922-0773 / 1-408-922-2958
Attn: Ms. Cathy Norton / Mr. Nghia Huynh

Acer America Corp. (Canadian Branch)

5775, McLaughlin Road
Mississauga, Ontario
L5R 3P7 Canada
Tel: 1-905-712-7912 / 1-800-320-2237
Fax: 1-905-712-7902
Attn: Mr. Lam Hoang

Acer Latin America (ACLA)

1601 N.W. 84th Avenue
Miami, Florida 33126, USA
Tel: 1-305-477-8119
Fax: 1-305-477-5963
Attn: Mr. Chris Songer

Acer Argentina

Marcos Sastre 3620, Carapachay,
Buenos Aires, 1605, Argentina
Tel: 54-1-763-1111
Fax: 54-1-763-0222
Attn: Mr. Isaac Cánepa

Acer Colombia

Carretera 129 no. 29-57
Bodega 42,
Parque Industrial de Occidente
Santa Fe de Bogota, Colombia
Tel: 57-1-418-1498
Fax: 57-1-418-1510
Attn: Mr. Ezequiel Lopez.

Cientec S.A.

Antonio Varas 754,
Casilla 972, Santiago De Chile, Chile
Tel: 56-2-200-9000
Fax: 56-2-235-8481
Attn: Mr. Juan Enrique Arevalo

Acer de Venezuela

Avenida Principal de la Castellana
Torre Banco de Lara, piso 3. of 3-B,
La Castellana Caracas, Venezuela
Tel: 58-2-263-0406
Fax: 58-2-261-3058
Attn: Mr. Rafael Cabrera

CompuTec Servicio, S.A. de C.V.

Poniente 140 no. 717
Col. Industrial Vallejo
Mexico, D.F. C.P. 02300
Tel.: 52-5-729-5570 / 729-5590
Fax: 52-5-729-5596
Attn: Mr. Alicia Camacho

Acer Computer B.V. (ACH)

Europalaan 89
5232 BC's-Hertogenbosch,
The Netherlands
Tel: 31-73-645-9595
Fax: 31-73-645-9599
Attn: Mr. Martien Strauven

Acer Computer HandelsgmbH (ACE)

Hutteldorfer Strasse 299
1140 Vienna, Austria
Tel: 43-1-914-18810
Fax: 43-1-914-188110
Attn: Mr. Georg Trojan

Acer Scandinavia A/S (ACD)

Kongevejen 62A
3460 Birkerød, Denmark
Tel: 45-45-821-000
Fax: 45-45-821-072
Attn: Mr. Bo Erri

Acer Computer GmbH (ACG)

Kornkamp 4
22923 Ahrensburg, Germany
Tel: 49-4102-4880
Fax: 49-4102-488-101
Attn: Mr. Hajo Luppe

Acer Italy s.r.l. (AAI)

Via Cassanese 210
Segrate, Milan, Italy
Tel: 39-2-2692-2565
Fax: 39-2-2692-1021
Attn: Mr. Salvatore Cammarata

Acer U.K. Ltd. (AIL)

Technical Support Division
Maddison House, Thomas Road,
Wooburn Industrial Park, Wooburn Green
Buckinghamshire, HP10 OPE
United Kingdom
Tel : 44-1628-533-422
Fax: 44-1628-524-060
Attn: Mr. Dave Tanner

Acer Computer France (ACF)

ZI Paris Nord II
209, Avenue des Nations
93290 Tremblay Les Gonesse
France
Tel : 33-1-4817-4040
Fax: 33-1-4817-4048
Attn: Mr. Olivier Dugain

Acer Africa (Pty) Ltd. (AAF-1)

76 Lechwe Street
Corporate Park, Old Pretoria Road
Randjespark Ext 76,
Midrand, South Africa
Tel: 27-11-314-2807
Fax: 27-11-314-2703
Attn: Mr. Teddy Liang / Mr. Roy Grant

Acer Africa (Pty) Ltd. (AAF-2)

Acer House, 15 Aloefield Crescent,
Springfield Park, Durban, 4091
South Africa
Tel: 27-31-579-1331
Fax: 27-31-579-1712
Attn: Mr. Brian Bogaard

Acer Africa (Pty) Ltd. (AAF-3)

Unit 50, M5 Freeway Park,
Camp Road, Maitland CT.
Box 7367, Roggebaai, 8012, South Africa
Tel: 27-21-510-5960
Fax: 27-21-510-2838
Attn: Mr. Tom Simpson

Acer Computer Australia Pty Ltd. (ACA)

Tower A, Level 3, 112-118 Talavera Rd,
North Ryde, NSW 2113,
Australia
Tel: 61-2-9870-1999
Fax: 61-2-9878-6943
Attn: Ms. Jane Picker

**Acer Computer(South Asia) Pty Ltd.
(ASA)**

Block 4, Pasir Panjang Rd., #10-29
Alexandra Distripark,
Singapore 0511
Tel: 65-276-4878
Fax: 65-274-9925
Attn: Mr. Vincent Ng

Acer Sales & Service Sdn Bhd (AMA)

Tech. Supp. . No. 25, Jalan 8/91,
Taman Shamelin Perkasa,
Off Jalan Cheras,
56100 Kuala Lumpur, Malaysia
Tel: 60-3-984-2488
Fax: 60-3-981-3302
Attn: Mr. Wong Chan Poh

PT. Metrodata Electronics

Duta Merlin Block B/27
JL. Gajah Mada 3-5
Jakarta Pusat 10130
Indonesia
Tel: 62-21-633-4532/4542
Fax: 62-21-634-4516
Attn: Mr. Danny Muliana

Sahaviriya OA Co., Ltd.

279 Moo 7, Ratburana Rd.,
Ratburana, Bangkok 10140, Thailand
Tel: 66-2-462-5822 / 462-5933
Fax: 66-2-816-7536
Attn: Ms. Suchanee Tur.

Wipro Infotech

Repair Centre, Akshaya Complex,
26 Victoria Road,
Bangalore 560 047, India
Tel: 91-80-556-6420/556-9993/557-6712
Fax: 91-80-556-0144
Attn: Mr. Dinesh H S

Acer Computer (M.E) Ltd. (AME)

P.O Box 16951, Dubai,
United Arab Emirates
Tel: 971-4-836-663
Fax: 971-4-836-464
Attn: Mr. Victor Soon

Acer Market Services Ltd. (AMS-BJ)

Rm 329, 3rd Fl. 4th Area
Science & Technology Trade Center
37 Baishiqiao Road, Haidian District,
Beijing, 100081 People's Republic of China
Tel: 86-10-6847-2323
Fax: 86-10-6847-1101
Attn: Mr. David Chien

**Acer Shanghai Regional Office
(AMS-SH)**

Beijing Acer Information Co.,Ltd.
Rm 403, Jinan Lianheng Comm'l. Bldg,
394/8, Yanan Rd. West,
Shanghai, 200040,
People's Republic of China
Tel: 86-21-6247-7288 (ext. 4030)
Fax: 86-21-6247-7617
Attn: Mr. Marlin Zong

Acer Computer (F.E.) Ltd. (AFE)

Room A1, 5th Floor, Block A
Tonic Industrial Centre,
26 Kai Cheung Road, Kowloon Bay,
Kowloon, Hong Kong
Tel: 852-2755-2611
Fax: 852-2799-9998
Attn: Mr. Chiu Siu Lung

Acer Sertek Inc. (STK)

4th floor, 135 Section 2,
Chien Kuo North Road
Taipei 10449, Taiwan, R.O.C.
Tel: 886-2-501-0055 (Ext. 5126/5127)
Fax: 886-2-509-2745
Attn: Mr. Wenson Huang

7.3 Worldwide Support

If the country you are traveling in does not have an Acer-authorized ITW service site, you can still get in contact with our offices worldwide.

World Headquarters

Acer Incorporated

156 Min Sheng E. Road Sec. 3, 6F
Taipei, Taiwan 105, R.O.C.
Telephone: 886-2-545-5288
Facsimile: 886-2-545-5308
Homepage: <http://www.acer.com.tw/>

Regional Headquarters

Acer America Corporation

2641 Orchard Parkway
San Jose, CA 95134, USA
Telephone: 1 (408) 432-6200
Facsimile: 1 (408) 922-2933
Homepage: <http://www.acer.com/aac/>

Acer Computer B. V.

Europalaan 89
5232 BC's-Hertogenbosch
The Netherlands
Telephone: 31-73-6459595
Facsimile: 31-73-6459599
Homepage: <http://www.acer.nl/>

Acer Computer International Ltd.

438 Alexandra Road
#17-00, Alexandra Point
Singapore 119958
Telephone: 65-274-7778
Facsimile: 65-276-3588
Homepage: <http://www.aci.acer.com.tw/>

Acer Computec Latino America

Berruguete No.25
Col. Nonoalco Mixcoac
C.P. 03700, Mexico, D.F.
Telephone: 525-627-9400
Facsimile: 525-627-9401
Homepage: <http://www.acer.com.mx/>

Worldwide Operations

Asia

Acer Computer International, CIS

#14 Chapayevsky Pereulok, 5F
Moscow, Russia 125252
Telephone: (7-095) 258-4400
Facsimile: (7501) 258-4401

Acer Computer (Far East) Ltd.

2001 United Centre, 2F
95 Queensway, Hong Kong
Telephone: 852-25280233
Facsimile: 852-28613758

Acer Computer (M.E.) Ltd.

P.O. Box 16951
Jebel Ali Free Zone Dubai
United Arab Emirates
Telephone: 971-4-836663
Facsimile: 971-4-836464

Acer Computer Turkey

Altunizade Sitesi, Okul Sokagi
C Blok No.5, Da:4
81190 Altunizade
Istanbul, Turkey
Telephone: 90-216-3270311/2
Facsimile: 90-216-3270314

Acer Japan Corporation

5F, Sumitomo Gotanda Bldg.
7-1-1, Nishi-Gotanda, Shinagawa-ku
Tokyo 141, Japan
Telephone: 81-3-5434-7373
Facsimile: 81-3-5434-7533

Acer Korea Co. Ltd.

DaeYoung Building, #831
44-1 Yoido-Dong, YoungDeungPo-Ku
Seoul, South Korea
Telephone: 82-2-784-6898/9
Facsimile: 82-2-784-6897

Acer Market Services, Ltd.

Science & Technology Trade Center
4th Area, 3F Rm.329
37 Bai Shi Qiao Rd., Haidian District,
Beijing, People's Republic of China
Telephone: 86-1-847-2233
Facsimile: 86-1-847-1101

Acer Sales & Services Sdn. Bhd.

Level 17 Menara Lion
165 Jalan Ampang
50450 Kuala Lumpur, Malaysia
Telephone: 60-3-466-3223/262-1388
Facsimile: 60-3-466-2388/261-8113

Acer Sertek Incorporated

135 Chien Kuo N. Rd. Sec. 2
Taipei, Taiwan 104, ROC
Telephone: 886-2-501-0055
Facsimile: 886-2-501-2521

SV-Acer Co., Ltd.

900/9 SVOA Tower 18F
Rama 3 Rd., Bangpongpan
Yannawa, Bangkok 10120, Thailand
Telephone: 662-682-1111/682-6233
Facsimile: 662-6826323

Wipro Acer

6F, S.B. Towers,
88 Mahatma Gandhi Rd.,
Bangalore 560001, India
Telephone: 91-80-558-8422
Facsimile: 91-80-558-6657

Australia

Acer Computer Australia Pty Ltd.

Tower A, Level 3,
112-118 Talavera Road
North Ryde, NSW 2113, Australia
Telephone: 61-2-870 1999
Facsimile: 61-2-878 6227

Sales Offices**Acer Computer Australia Pty Ltd.**

69 Fullarton Road
Kent Town, SA 5067
Telephone: 61-8-364 3022
Facsimile: 61-8-364 1220

Acer Computer Australia Pty Ltd.

Associate House, Suite 3
1070 Hay St.
West Perth, WA 6005
Telephone: 61-9-321 9511
Facsimile: 61-9-321 9534

Acer Computer Australia Pty Ltd.

99 Northbourne Avenue, 2F
Turner, ACT 2601
Telephone: 61-6-257 2522
Facsimile: 61-6-247 0187

Acer Computer Australia Pty Ltd.

Unit 10, 2F, 150 Albert Rd.
South Melbourne, VIC 3205
Telephone: 61-3-696 4266
Facsimile: 61-3-696 4354

Acer Computer Australia Pty Ltd.

Level 3, Waterfront Place,
1 Eagle St.
Brisbane, QLD 4000
Telephone: 61-7-360 0266
Facsimile: 61-7-360 0222

New Zealand

Acer Computer New Zealand Ltd.

AcerHouse, Level 7
10-12 Scotia Pl.
Auckland, New Zealand
Telephone: 64-9-302 8500
Facsimile: 64-9-302 8501

Europe

Acer Belgium N.V.

Coremansstraat 34, 2600 Antwerpen
(Berchem) Belgium
Telephone: 32-3-2305032
Facsimile: 32-3-2813325

Acer Computer B. V.

Europalaan 89
5232 BC's-Hertogenbosch
The Netherlands
Telephone: 31-73-6459645
Facsimile: 31-73-6459699

Acer Computer France S.A.R.L.

Paris Nord II
165 avenue du Bois de la Pie
B.P. 40005
959111 Roissy Charles de Gaulle Cedex
Telephone: 33-1-4817-4040
Facsimile: 33-1-4817-4089

Acer Computer GmbH

Kornkamp 4
22923 Ahrensburg/Hamburg, Germany
Telephone: 49-4102-488-0
Facsimile: 49-4102-488-101

Acer Computer HandelsgesmbH

Jochen-Rindt-Straße 25
1230 Wien, Austria
Telephone: 43-1-615-0820
Facsimile: 43-1-615-0820-50

Acer Computer Norway A/S

Bleikerveien 17
1370 Asker, Norway
Telephone: 47-66901030
Facsimile: 47-66900240

Acer Computer Polska

ul Wiejska 12
00-490 Warszawa, Poland
Telephone: 48-22-6219866
Facsimile: 48-22-6282416

Acer Computer Representative Hungary

Dayka G.u.3. B I-1
1118 Budapest, Hungary
Telephone: 36-1-3192655
Facsimile: 36-1-3191655

Acer Computer Iberica, S.A.

Frederic Mompou 5, 3, 2B
Sant Just Desvern
08960 Barcelona, Spain
Telephone: 34-3-4990303
Facsimile: 34-3-4990483

Acer Italy s. r. l.

Via Cassanese 210
20092 Segrate, Milan, Italy
Telephone: 39-2-2692-2565
Facsimile: 39-2-2692-1021

Acer Scandinavia A/S

Kongevejen 62A
3460, Birkørød, Denmark
Telephone: 45-45-821000
Facsimile: 45-45-821072

Acer UK Limited

Maddison House, Thomas Rd.
Wooburn Green HP10 OPE,
United Kingdom
Telephone: 44-1628-533422
Facsimile: 44-1628-524071

North America

Sales Offices

Acer America/Boston

Burlington Office Park
1 Wall St.
Burlington, MA 01803, USA
Telephone: 1 (617) 272-2572
Facsimile: 1 (617) 272-5155

Acer America/Canada

9-5155 Spectrum Way
Mississauga, Ontario L4W 5A1, Canada
Telephone: 1 (905) 602-8200
Facsimile: 1 (905) 602-7799

Acer America/North Central West

Two Continental Towers
1701 Golf Rd., Suite 601
Rolling Meadows, IL 60008, USA
Telephone: 1 (708) 640-7112
Facsimile: 1 (708) 640-6865

Acer America/Midwest

Farmington Hills, MI
Telephone: 1 (810) 471-2451
Facsimile: 1 (810) 471-2451

Acer America/South Central

5025 Arapaho Rd., #250
Dallas, TX 75248, USA
Telephone: 1 (214) 661-2093
Facsimile: 1 (214) 661-9665

Acer America/Southeast

3675 Crestwood Pkwy., Suite 400
Duluth, GA 30136, USA
Telephone: 1 (404) 923-2001
Facsimile: 1 (404) 923-1306

Acer America/North Mid Atlantic

Wyckoff, NJ, USA
Telephone: 1 (201) 848-1007
Facsimile: 1 (201) 848-1086

Acer America/New York Metro

Bayville, NY, USA
Telephone: 1 (516) 628-7373
Facsimile: 1 (516) 628-1703

Acer America/Northwest

Issaquah, WA, USA
Telephone: 1 (206) 391-0717
Facsimile: 1 (206) 391-0801

Acer America/North Central East

Akron, OH, USA
Telephone: 1 (216) 867-7794
Facsimile: 1 (216) 867-1697

Acer America/Southwest

Costa Mesa, CA, USA
Telephone: 1 (714) 540-0812
Facsimile: 1 (714) 506-3826

Acer America/Government Sales

8321 Old Courthouse Rd., Ste. 250
Vienna, VA 22182, USA
Telephone: 1 (703) 442-7500
Facsimile: 1 (703) 821-1813

Latin America

Acer Latin America

1601 NW 84th Avenue
Miami, FL 33126, USA
Telephone: 1 (305) 477-8119
Facsimile: 1 (305) 477-5963

Sales Offices**Acer Argentina**

Marcos Sastre 3620, Carapachay
Buenos Aires, Argentina 1605
Telephone: 541-763-1111
Facsimile: 541-763-0222

Acer Chile

Antonio Varas 754, Casilla 972
Santiago de Chile, Chile
Telephone: 562-200-9301
Facsimile: 562-200-9310

Acer Computer Colombia

Cra 129 #29-57
Bodega No. 41-42-43
Bogota, Colombia
Telephone: 571-418-1465
Facsimile: 571-418-1510

Acer de Venezuela

Avenida principal de la Castellana
Torre Banco de Lara, piso 3, off 3-B
La Castellana, Caracas, Venezuela
Telephone: 582-266-8709
Facsimile: 582-261-3058

Africa

Acer Africa (Pty) Ltd
Fedlife Park, Unit 12A
Cnr. Pretoria Main Rd. and
Tonnetti St., Halfway House
South Africa
Telephone: 27-11-315-3335
Facsimile: 27-11-315-1032

You can also contact the local dealer or distributor in the country you are traveling for assistance.



If you are connected to the Internet and have World Wide Web access, visit our home page (<http://www.acer.com/>) and get an updated list of our worldwide offices, as well as information about our products.

Troubleshooting

This chapter tells how to deal with common system problems. Read it before calling a technician if a problem occurs. Solutions to more serious problems require opening up the system. Do not attempt to open the system by yourself. Contact your dealer or an authorized service center for assistance.

8.1 Q & A

Q & A lists possible situations that may arise during the use of your notebook, and gives easy answers and solutions to these questions.

Q: *I travel a lot and occasionally use my notebook in extreme temperature conditions. Will my notebook bend to the weather?*

A: The notebook's core design makes use of materials that dissipate heat quickly, without the need of a fan that can be noisy at times. The unique power management system also ensures that major components do not run too hot by closely monitoring thermal conditions within the unit itself.

So, whether you are using the notebook in the desert or in the arctic pole, you never need to worry about components breaking down or even a dip in the performance. If you feel the unit is a bit warm, you can always enable the automatic tilt feature of the keyboard and let the unit breathe a little. ☺ See section 2.4.2 for details.

Q: *What do I do if my notebook hangs and rebooting doesn't solve the problem?*

A: Every machine should have a fail-safe switch or a last resort, even a notebook. Desktops usually have the reset button and this notebook has one, too. This feature not only resets the machine, but it also re-synchronizes the notebook and its devices for a successful restart.

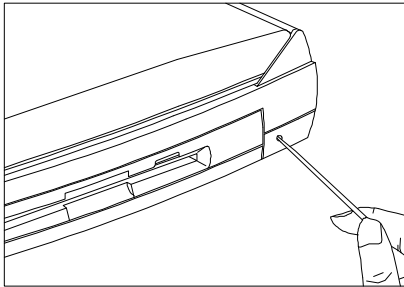

Conveniently located on the notebook's right panel, the reset notch can be accessed by a pin, paperclip or the tip of a ballpoint pen.

Refrain from using a pencil as the pencil lead may break off and lodge itself in the reset notch.

Q: *I prefer using an external keyboard and mouse, but both have PS/2 connectors and there is only one PS/2 port on the notebook. How do I connect them to the notebook at the same time?*

A: To connect two PS/2-type devices to the notebook, you need to use a PS/2 Y-bridge cable. See *PS/2 Y-Bridge Cable* in section 4.8.2 for details.

Connecting two PS/2-type devices via the mini dock is not a problem, because there are separate PS/2 connectors for an external keyboard and mouse.

Q: *I opened the display but the notebook does not start or boot-up.*

A: Look at the power indicator () on the display panel.

If the indicator is not lit, no power is being applied to the notebook. Check the following:

- If you are running on battery power, it may be low and unable to power the notebook. Connect the AC adapter to recharge the battery pack.
- Make sure the AC adapter is plugged in properly to the notebook and to the power outlet.

If the indicator is lit, check the following:

- Is a non-bootable (non-system) diskette in the floppy drive? Remove or replace it with a system diskette and press b-a-c to restart the system.
- The operating system files may be damaged or missing. Insert the startup disk you created during Windows 95 setup (see section 1.4) into the floppy drive and press b-a-c to restart the system. This will diagnose your system and make necessary fixes.

If you still cannot access your hard disk or start-up Windows 95 after the diagnosis, you may need to use the notebook backup disk to restore your hard disk to its initial state. See the backup kit for details.

Q: *I made some changes in Setup but they don't seem to take effect.*





A: If you made any changes in Setup, these will only take effect the next time the system restarts. Here are a few ways to restart your notebook:

- In Windows 95, click on the Start button and select Shutdown.... Then select the Restart option.
- In POST, execute a warm boot (pressing b-a-c).
- In POST, close the display and open the display.
- Use the reset notch. See Q&A #2.

Q: *Nothing appears on the screen.*

A: The notebook's power management system automatically blanks the screen to save power. Just press any key to turn the display back on.

If pressing a key does not turn the display back on, two things might be the cause:

- The contrast and/or brightness level might be too low. Press  -  -w (☉) to increase the brightness level; press  -  -x (☾) to increase the contrast level.
- The display device might be set to an external monitor. Press  -p (🖥️) to toggle the display back to the notebook.

Q: *The keyboard does not respond.*

A: Try attaching an external keyboard to the PS/2 connector on the notebook's rear. If it works, contact your dealer or an authorized service center as the internal keyboard cable may be loose.

Q: *The serial mouse does not work.*



A: Do the following:

- Make sure that the serial cable is plugged securely into the serial port.
- Try pressing  -n (PnP) to reconfigure Plug-and-Play devices.

Remember to set the External Mouse Location parameter in the Power Saving Options screen in Setup and select COM1 if you connected your mouse to the serial port.

Q: *The printer does not work.*

A: Do the following:









- Make sure that the printer is connected to a power outlet and it is turned on.
- Make sure the printer cable is connected securely to the notebook's parallel port and the corresponding port on the printer.
- Press  -m () to enter Setup and go to page 2 of the About My Computer section. Check if the Parallel Port is enabled.

If the parallel port is disabled, press s from the main menu, then select System Configuration. Go to page 3 and move the cursor to Parallel Port base address and change the setting. See section 6.4.9 for details.

- Try pressing  -n (PnP) to reconfigure Plug-and-Play devices.

Q: No audio comes out from the notebook.

A: Check the following:

- The volume may be muted. Press  -q (). If the pop-up does not contain a speaker icon, press  -r () to turn the speaker back on.
- The volume level may be too low. Press  -b-w () to increase the volume.
- If headphones, earphones or external speakers are connected to the headphone/speaker-out port on the notebook's left panel, the internal speakers automatically turn off.
- Onboard audio may be disabled. Press  -m () to enter Setup and go to page 2 of the About My Computer section. Check if the Onboard Audio is enabled.

If onboard audio is disabled, press s from the main menu, then select System Configuration. Go to page 3 and move the cursor to Onboard Audio and change the setting to [Auto]. See section 6.4.10 for details.

8.2 POST Error Messages

If you receive an error message during POST, note the message and take corrective action. Table 8-1 lists the error messages in alphabetical order together with the recommended course of action.

Table 8-1 POST Error Messages

Error Message	Corrective Action
CMOS Battery Bad	Contact your dealer or an authorized service center.
CMOS Checksum Error	Contact your dealer or an authorized service center.
Disk Boot Failure	Insert a system disk in drive A, then press e .
Diskette Drive Controller Error or No Controller Present	Contact your dealer or an authorized service center.
Diskette Drive Error	Contact your dealer or an authorized service center.
Diskette Drive Type Mismatch	Press F6 - m to reconfigure the notebook.
Equipment Configuration Error	Press F6 - m to reconfigure the notebook.
Hard Disk 0 Error	Contact your dealer or an authorized service center.
Hard Disk 0 Extended Type Error	Contact your dealer or an authorized service center.
I/O Parity Error	Contact your dealer or an authorized service center.
Insert system diskette and press <Enter> key to reboot	Insert a system disk in drive A, then press e .
Keyboard Error or No Keyboard Connected	Contact your dealer or an authorized service center.
Keyboard Interface Error	Contact your dealer or an authorized service center.
Memory Size Mismatch	Enter and then exit the System Configuration Setup in the Setup utility (pressing F6 - m)

Table 8-1 POST Error Messages (continued)

Error Message	Corrective Action
Missing operating system	Correct the HDD type and reboot. See the specification label pasted on the back side of the notebook or attached to hard disk drive. We suggest you set the HDD type to [Auto] for hard disk drive auto-detection.
Non-system disk or disk error. Replace and strike any key when ready	Insert a system disk in drive A, then press e.
Pointing Device Error	Contact your dealer or an authorized service center.
Pointing Device Interface Error	Contact your dealer or an authorized service center.
Protected Mode Test Fail	Contact your dealer or an authorized service center.
RAM BIOS Bad	Contact your dealer or an authorized service center.
RAM Parity Error	Contact your dealer or an authorized service center.
Real-Time Clock Error	Press  -m to reconfigure the notebook.
Video RAM BIOS Bad	Contact your dealer or an authorized service center.

In cases where you need to reconfigure the notebook by entering Setup (pressing  -m), changes made take effect the next time the system restarts.

To restart the system during POST, press b-a-c before Windows 95 begins loading. To restart from Windows 95, click on Start, then select Shutdown and choose the Restart option.

If you still encounter problems after going through the corrective measures, please contact your dealer or an authorized service center for assistance. See section 7.3.

Specifications

Item	Standard	Optional
Microprocessor	Mobile Intel Pentium™ processor with MMX	
Memory System / Main	16MB Dual 64-bit memory banks	Expandable to 64MB using 8/16/32MB soDIMMs
External cache	256KB L2 cache (synchronous SRAM)	
FLASH BIOS	256KB	
Storage system	One 2.5-inch, high-capacity Enhanced-IDE hard disk One high-speed IDE CD-ROM drive module One 3.5-inch, 1.44MB floppy drive module (internal/external use)	Higher-capacity E-IDE hard disk
Display	DualScan STN or active-matrix TFT LCD, 800x600, 64K colors (SVGA)	Up to 1024x768, 256-color ultra-VGA monitor LCD projection panel
Video system	PCI local bus video with 128-bit graphics accelerator	

Item	Standard	Optional
Audio system	16-bit stereo audio with built-in FM synthesizer Built-in microphone and dual angled speakers	
Communications system ¹	Built-in V.34 fax/data modem (28.8Kbps) with digital simultaneous voice over data (DSVD) support	PC card modem
Operating system	Windows 95	DOS and Windows 3.x, OS/2 Warp
Keyboard and pointing device	84-/85-key with Win95 keys; auto-tilt feature Touchpad (centrally-located on palm rest)	101-/102-key, PS/2-compatible keyboard or 17-key numeric keypad External serial or PS/2 mouse or similar pointing device
I/O ports	One 9-pin RS-232 serial port (UART16550-compatible) One 25-pin parallel port (EPP/ECP-compliant) One 15-pin CRT port One 6-pin PS/2 connector One 240-pin mini dock connector	Serial mouse, printer or other serial devices Parallel printer or other parallel devices; floppy drive module (when used externally) Up to a 1024x768 ultra-VGA monitor 17-key numeric keypad, PS/2 keyboard, mouse or trackball Mini dock

¹ This feature is available only in the U.S.

Item	Standard	Optional
I/O ports (continued)	<p>One type III or two type II PC Card slot(s)</p> <p>One serial infrared port (IrDA-compliant)</p> <p>One 3.5mm minijack microphone-in/line-in port</p> <p>One 3.5mm minijack speaker-out/line-out port</p> <p>RJ11 phone jack¹</p>	<p>LAN card or other PC cards</p> <p>External IR adapter</p> <p>Microphone or line-in device</p> <p>Speakers or headphones</p>
Weight with FDD with CD-ROM	<p>(includes battery)</p> <p>3.4 kg. (7.4 lbs.)</p> <p>3.5 kg. (7.7 lbs.)</p>	
Dimensions Round contour Main footprint	<p>L x W x H</p> <p>297~313 x 230~240 x 48~53 mm</p> <p>11.7 x 9.1 x 2 inches</p>	Carrying bag
Temperature Operating Non-operating	<p>10°C ~ 35°C</p> <p>-10°C ~ 60°C</p>	
Humidity Operating Non-operating	<p>(non-condensing)</p> <p>20% ~ 80% RH</p> <p>20% ~ 80% RH</p>	

¹ This option is available only in the U.S. and Japan.

Item	Standard	Optional
AC adapter	100~240Vac, 50~60Hz autosensing AC adapter	Extra AC adapter
Battery pack Type Charge time	57WH Lithium-Ion battery with intelligent charging and built-in battery gauge 2.0-hour rapid-charge 4.0-hour charge-in-use	Extra battery pack

Address and Interrupt Tables

B.1 System Memory Map

Address Range	Definition	Function
000000 - 09FFFF	640 KB memory	Base memory
0A0000 - 0BFFFF	128 KB video RAM	Reserved for graphics display buffer
0C0000 - 0CBFFF	Video BIOS	Video BIOS
0F0000 - 0FFFFFFF	64 KB system BIOS	System BIOS
10000 - 7FFFFF	Extended memory	Onboard memory
80000 - 27FFF		SIMM memory
FE0000 - FFFFFFFF	256 KB system ROM	Duplicate of code assignment at 0E0000-0FFFFFFF

B.2 I/O Address Map

Address Range	Device
000 - 00F	DMA controller-1
020 - 021	Interrupt controller-1
024, 026, B0h	PicoPower chipset registers
02E - 02F	CMD0643 IDE controller
040 - 043	Timer 1
048 - 04B	Timer 2
060 - 06E	Keyboard controller 8742 chip select
070 - 071	Real-time clock and NMI mask
080 - 08F	DMA page register
0A0 - 0A1	Interrupt controller-2
0C0 - 0DF	DMA controller-2
1F0 - 1F7	Hard disk select
3F6 - 3F7	Hard disk select
170 - 177	CD-ROM select
376 - 377	CD-ROM select
220 - 22F	Audio
240 - 24F	Audio - default
260 - 26F	Audio
280 - 28F	Audio
278 - 27F	Parallel port 3
2E8 - 2EF	COM 4
2F8 - 2FF	COM 2 - IrDA
300 - 301	MPU-401 port - default
310 - 311	MPU-401 port
320 - 321	MPU-401 port
330 - 321	MPU-401 port
34C - 34F	Docking station
378 - 37F	Parallel port 2
388 - 38B	FM synthesizer
3BC - 3BE	Parallel port 1
3B4, 3B5, 3BA	Video subsystem
3C0 - 3C5	
3C6 - 3C9	Video DAC
3C0 - 3CF	Enhanced graphics display
3D0 - 3DF	Color graphics adapter
3E8 - 3EF	COM3 - Modem
3F0 - 3F7	Floppy disk controller
3F8 - 3FF	COM 1 - Serial 1
CF8 - CFF	PCI configuration register

B.3 Interrupt Levels

Interrupt Number	Interrupt Source (Device Name)
IRQ 0	System Timer
IRQ 1	Keyboard
IRQ 2	Cascade
IRQ 3	IrDA / 2F8h
IRQ 4	Serial Port 1 / 3F8h
IRQ 5	Audio ESS1688
IRQ 6	Floppy Disk Controller (FDC)
IRQ 7	Parallel Port
IRQ 8	Real Time Clock (RTC)
IRQ 9	Ethernet on Port Replicator
IRQ 10	Internal Modem / 3E8h
IRQ 11	PCMCIA
IRQ 12	PS/2 Mouse
IRQ 13	Co-processor
IRQ 14	Hard disk
IRQ 15	CD-ROM

B.4 DMA Channels

Controller	Channel	Address	Function
1	0	0087	Audio (default)
1	1	0083	Audio (option) / ECP
1	2	0081	Diskette
1	3	0082	Audio (option)
2	4	Cascade	Cascade
2	5	008B	
2	6	0089	Spare
2	7	008A	

Free Manuals Download Website

<http://myh66.com>

<http://usermanuals.us>

<http://www.somanuals.com>

<http://www.4manuals.cc>

<http://www.manual-lib.com>

<http://www.404manual.com>

<http://www.luxmanual.com>

<http://aubethermostatmanual.com>

Golf course search by state

<http://golfingnear.com>

Email search by domain

<http://emailbydomain.com>

Auto manuals search

<http://auto.somanuals.com>

TV manuals search

<http://tv.somanuals.com>