

Acer TravelMate 370 Series

Service Guide

Service guide files and updates are available on the ACER/CSD web; for more information, please refer to <http://csd.acer.com.tw>

SERVICE CD PART NO.: VD.T39V1.001

PRINTED IN TAIWAN

Revision History

Please refer to the table below for the updates made on TravelMate 370 service guide.

Date	Chapter	Updates

Copyright

Copyright © 2003 by Acer Incorporated. All rights reserved. No part of this publication may be reproduced, transmitted, transcribed, stored in a retrieval system, or translated into any language or computer language, in any form or by any means, electronic, mechanical, magnetic, optical, chemical, manual or otherwise, without the prior written permission of Acer Incorporated.

Disclaimer

The information in this guide is subject to change without notice.

Acer Incorporated makes no representations or warranties, either expressed or implied, with respect to the contents hereof and specifically disclaims any warranties of merchantability or fitness for any particular purpose. Any Acer Incorporated software described in this manual is sold or licensed "as is". Should the programs prove defective following their purchase, the buyer (and not Acer Incorporated, its distributor, or its dealer) assumes the entire cost of all necessary servicing, repair, and any incidental or consequential damages resulting from any defect in the software.

Acer is a registered trademark of Acer Corporation.

Intel is a registered trademark of Intel Corporation.

Pentium M and Centrino are trademarks of Intel Corporation.

Other brand and product names are trademarks and/or registered trademarks of their respective holders.

Conventions

The following conventions are used in this manual:

SCREEN MESSAGES	Denotes actual messages that appear on screen.
NOTE	Gives bits and pieces of additional information related to the current topic.
WARNING	Alerts you to any damage that might result from doing or not doing specific actions.
CAUTION	Gives precautionary measures to avoid possible hardware or software problems.
IMPORTANT	Reminds you to do specific actions relevant to the accomplishment of procedures.

Preface

Before using this information and the product it supports, please read the following general information.

1. This Service Guide provides you with all technical information relating to the BASIC CONFIGURATION decided for Acer's "global" product offering. To better fit local market requirements and enhance product competitiveness, your regional office MAY have decided to extend the functionality of a machine (e.g. add-on card, modem, or extra memory capability). These LOCALIZED FEATURES will NOT be covered in this generic service guide. In such cases, please contact your regional offices or the responsible personnel/channel to provide you with further technical details.
2. Please note WHEN ORDERING FRU PARTS, that you should check the most up-to-date information available on your regional web or channel. If, for whatever reason, a part number change is made, it will not be noted in the printed Service Guide. For ACER-AUTHORIZED SERVICE PROVIDERS, your Acer office may have a DIFFERENT part number code to those given in the FRU list of this printed Service Guide. You MUST use the list provided by your regional Acer office to order FRU parts for repair and service of customer machines.

Chapter 1	System Specifications	1
	Features	1
	System Block Diagram	2
	Board Layout	3
	Top View	3
	Bottom View	4
	Outlook View	5
	Front OpenView	5
	Front View	6
	Left Panel	7
	Right Panel	8
	Rear Panel	9
	Bottom Panel	10
	Indicators	11
	Keyboard	12
	Special keys	12
	Touchpad	16
	Touchpad Basics	16
	Launch Keys	17
	Hardware Specifications and Configurations	18
Chapter 2	System Utilities	27
	BIOS Setup Utility	27
	Navigating the BIOS Setup Utility	28
	Information	29
	Main	30
	Advanced	32
	Security	33
	Boot	36
	Exit	37
	BIOS Flash Utility	38
	System Diagnostic Diskette	38
Chapter 3	Machine Disassembly and Replacement	39
	General Information	40
	Before You Begin	40
	Disassembly Procedure Flowchart	41
	Removing the Battery	43
	Removing the Memory/HDD Module	44
	Removing the Keyboard	45
	Disassembling the Main Unit	46
	Disassembling the LCD Module	52
	Disassembling the External Modules	54
	Disassembling the HDD Module	54
Chapter 4	Troubleshooting	55
	System Check Procedures	56
	External Diskette Drive Check	56
	External CD-ROM Drive Check	56
	Keyboard or Auxiliary Input Device Check	57
	Memory Check	57
	Power System Check	57
	Touchpad Check	57
	Power-On Self-Test (POST) Error Message	59

Table of Contents

Index of Error Messages	60
Index of Symptom-to-FRU Error Message	62
Intermittent Problems	66
Undetermined Problems	67
Chapter 5 Jumper and Connector Locations	69
Top View	69
Bottom View	70
Chapter 6 FRU (Field Replaceable Unit) List	71
Appendix A Model Definition and Configuration	80
TravelMate 370 series	80
Appendix B Test Compatible Components	81
Microsoft Windows XP (Home) Environment Test	82
Appendix C Online Support Information	85

System Specifications

Features

This computer was designed with the user in mind. Here are just a few of its many features:

Performance

- Intel Pentium M processor at 1.3 ~ 1.8 GHz or higher
- Intel 855GM chipset
- Memory upgradeable 2GB with 2 slots
- High capacity, Enhanced-IDE hard disk
- Li-ion main battery pack
- Power management system with ACPI (Advanced Configuration Power Interface)

Display

- Thin-Film Transistor (TFT) Liquid Crystal Display (LCD) displaying 32-bit high colour up to 1024*768 eXtended Graphics Array (XGA) resolution
- 3D graphics engine
- Supports simultaneous display between LCD and CRT display
- DualView

Multimedia

- 16-bit high-fidelity AC'97 stereo audio
- Built-in speaker

Connectivity

- Built-in 56Kbps fax/data modem port
- Integrated 10/100Mbps Ethernet/Fast Ethernet port
- Fast infrared communication
- Two Universal Serial Bus (USB 2.0) ports
- One IEEE 1394 port
- InviLink 802.11b and 802.11a/g wireless LAN (manufacturing optional)
- SD/MMC/MS memory slot (manufacturing optional)

Expansion

- One type II CardBus PC Card slot
- Upgradeable memory

System Block Diagram

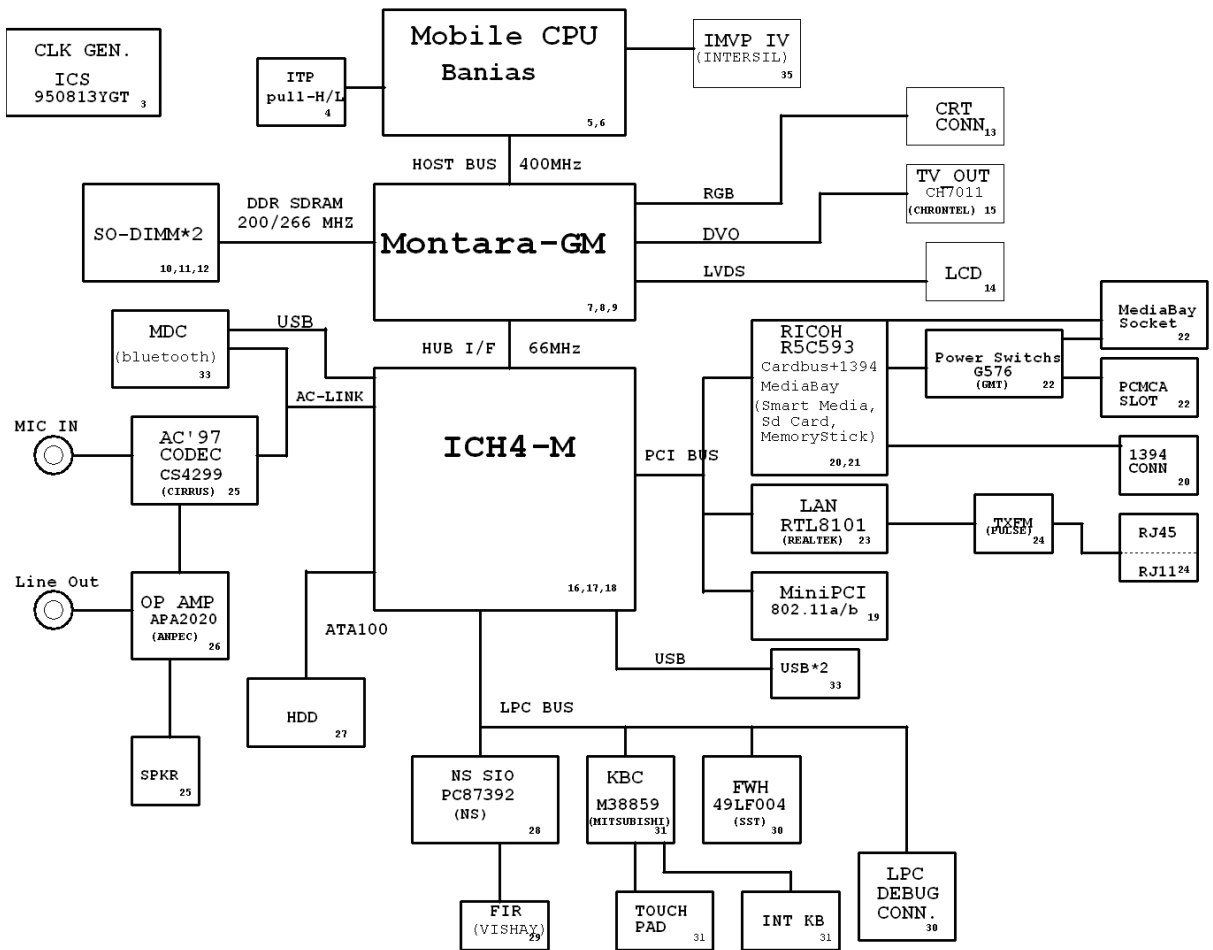

Board Layout

Top View

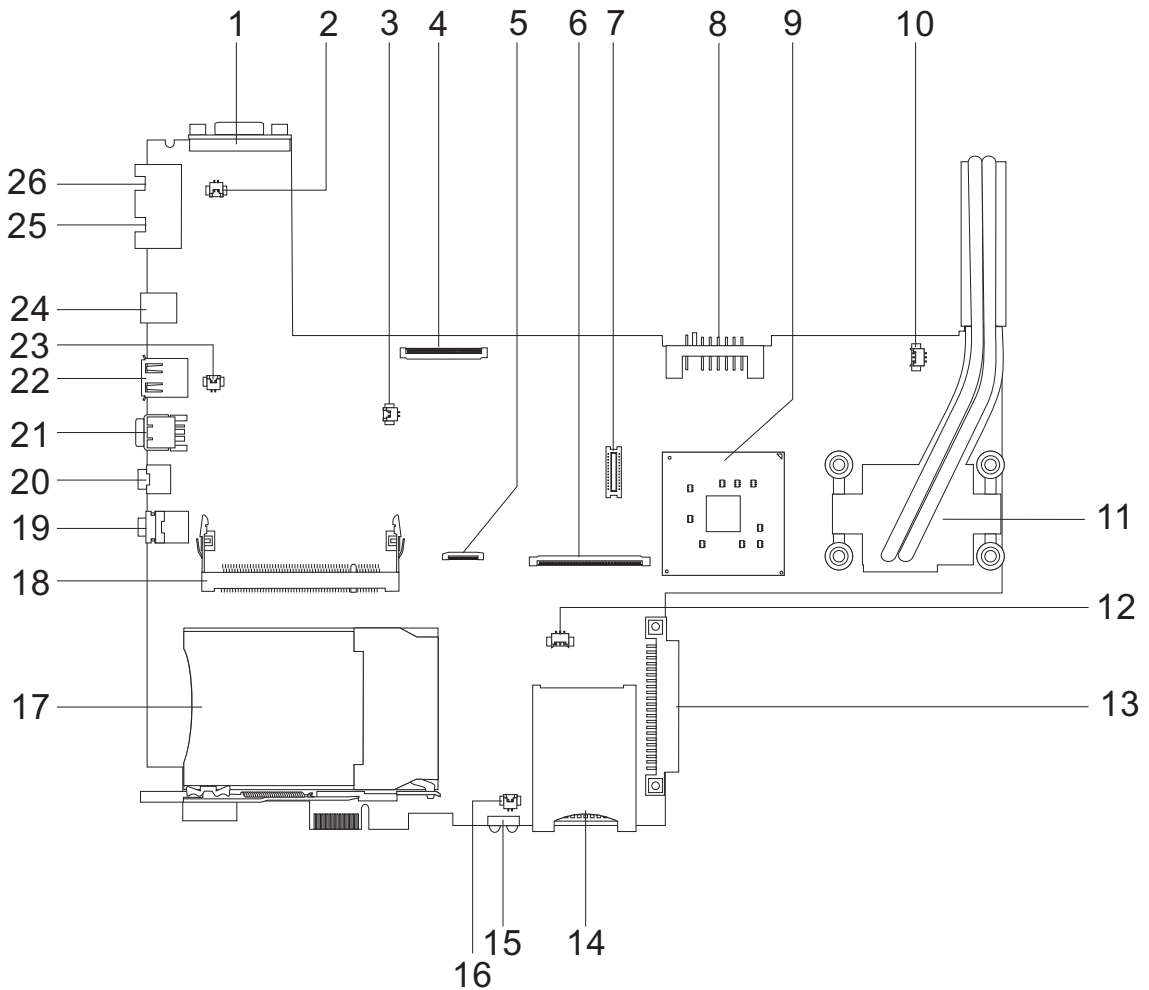

- | | | | |
|----|---------------------------|----|---------------------------------|
| 1 | External Display Port | 14 | 3-in1 Card Reader Slot |
| 2 | Modem Cable Connector | 15 | Infrared Port |
| 3 | Speaker Connector | 16 | Microphone Connector |
| 4 | LCD FPC Connectors | 17 | PCMCIA Slot |
| 5 | Touchpad Board Connectors | 18 | Mini-PCI Slot |
| 6 | Keyboard Connector | 19 | Microphone/Line-in Jack |
| 7 | Modem Board Connector | 20 | Headphone/Speaker/Line-out Jack |
| 8 | Battery Connector | 21 | IEEE 1394 Port |
| 9 | North Bridge | 22 | USB Port |
| 10 | Fan Connector | 23 | Cover Switch Connector |
| 11 | CPU | 24 | DC-In |
| 12 | RTC Battery Connector | 25 | RJ45 Ethernet Connector |
| 13 | HDD Connector | 26 | RJ11 Modem Connector |

Bottom View

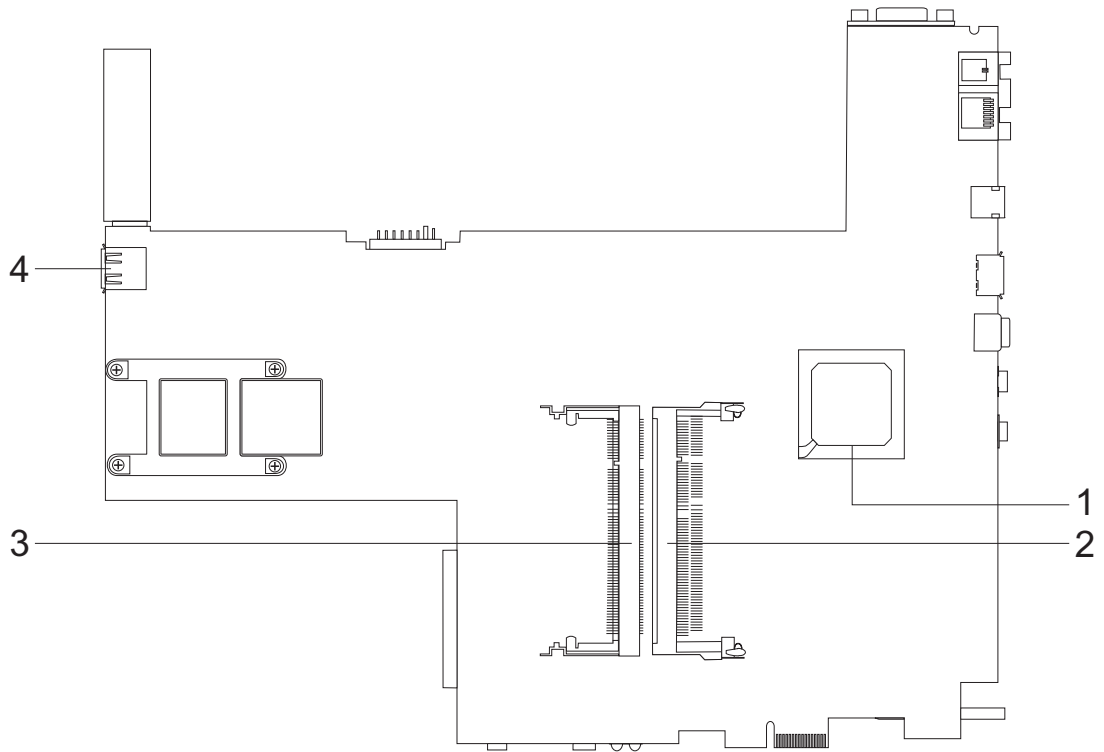

1 South Bridge
2 DIMM Slot

3 DIMM Slot
4 USB port

Outlook View

A general introduction of ports allow you to connect peripheral devices, as you would with a desktop PC.

Front Open View



#	Item	Description
1	Display screen	Also called LCD (Liquid Crystal Display), displays computer output.
2	Status indicators	LEDs (Light Emitting Diode) that turn on and off to show the status of the computer and its components.
3	Power button	Turns the computer on and off.
4	Launch keys	Two special keys for frequently used programs.
5	Palm rest	Comfortable support area for your hands when you use the computer.
6	Click buttons (left, center and right)	The left and right button functions are like the left and right mouse buttons; the center button serves as a 4-way scroll button.
7	Touchpad	Touch-sensitive pointing device which functions are like a computer mouse.
8	Keyboard	Inputs data into your computer.
9	Speaker	Outputs sound.

Front View

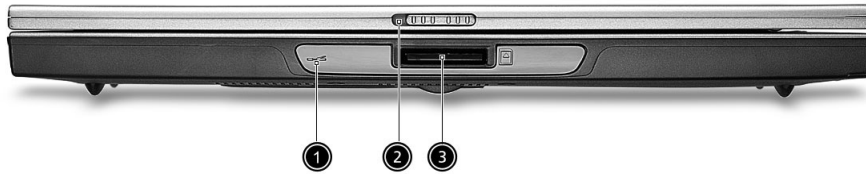

#	Item	Description
1	Infrared port	Interfaces with infrared devices (e.g., infrared printer, IR-aware computer).
2	Latch	Latch for opening and closing the computer.
3	3-in-1 card reader	Reads cards from Memory Stick, MultiMedia and Secure Digital cards.

NOTE: 3-in-1 card reader is a manufacturing option, subject to configuration. Only one card can operate at any given time.

Left Panel



#	Item	Description
1	Modem port	Connects the built-in fax/data modem to a phone line.
2	Ethernet port	Connects the computer to an Ethernet 10/100-based network.
3	DC-in jack	Connects the AC adapter.
4	USB 2.0 port	Connects to USB (Universal Serial Bus) devices (e.g., USB mouse, USB camera).
5	IEEE 1394 port	Connects to IEEE 1394 devices.
6	Headphone/ Speaker/ Line-out jack	Connects to headphones or other line-out audio devices (speakers)
7	Microphone/ Line-in jack	Accepts input from external microphones, or other audio line-in devices (e.g., audio CD player, stereo walkman and etc.)
8	PC card slot	Accepts one Type II 16-bit PC card or 32-bit CardBus PC card.
9	PC card eject button	Press the eject button to remove a PC card from the PC card slot.

Right Panel



#	Item	Description
1	HDD	Houses the computer's hard disk.
2	USB 2.0 port	Connects to USB (Universal Serial Bus) devices (e.g., USB mouse, USB camera).
3	Ventilation slot	Enable the computer to stay cool, even after prolonged use.
4	Security keylock	Connects to a Kensington-compatible computer security lock.

Rear Panel



#	Item	Description
1	External display port	Connects to a display device (e.g., external monitor, LCD projector) and displays up to 16.7 million colors with 1024*768 pixel resolution.

Bottom Panel

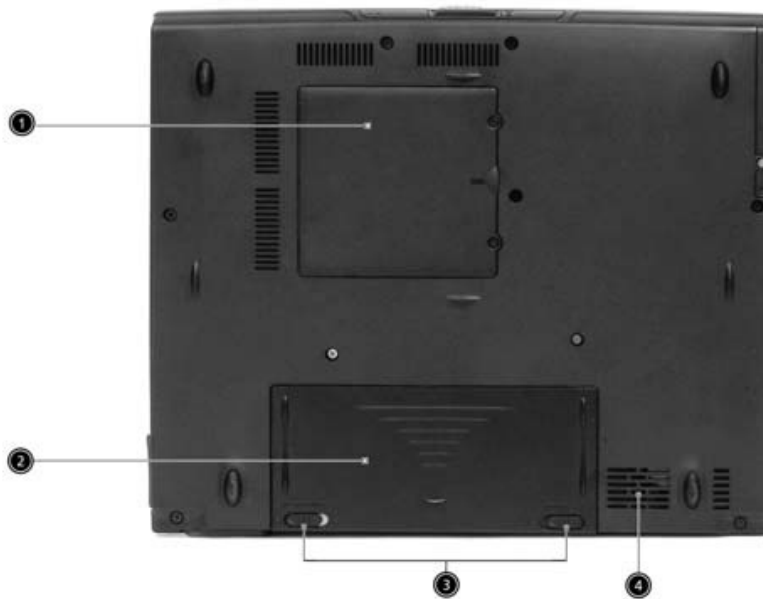







#	Item	Description
1	DIMM cover	Removable cover provides access to the memory slots for upgrading the computer's memory.
2	Battery bay	Houses the computer's removable battery pack.
3	Battery release latch	Unlatches the battery to remove the battery pack.
4	Ventilation slots	Enables the computer to stay cool, even after prolonged use.

Indicators

The computer has seven easy-to-read status indicators on the display screen and three on the LCD panel.



The Wireless, Power and Sleep status indicators are visible even when the display is closed.

Icon	Function	Description
	Wireless LAN	Orange indicates that wireless LAN is enabled.
	Power mode	Lights green when power is on and flashing when the computer is in standby mode.
	Sleep	Lights when the computer enters standby mode and blinks when it enters into or resumes from hibernation mode.
	Media activity	Lights when the floppy drive, hard disk drive or optical drive is activated.
	Battery charge	Lights when the battery is being charged.
	Caps lock	Lights when Caps Lock is activated.
	Num lock	Lights when Num Lock is activated.

Keyboard

The keyboard features full-size keys with an embedded keypad, separate cursor control keys, two Windows keys, and twelve function keys (hot keys).

Special keys

Lock keys

The keyboard has four lock keys which you can toggle on and off.

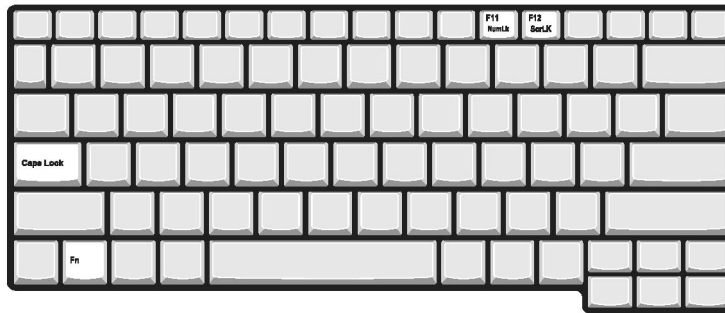

Lock Key	Description
Caps Lock	When Caps Lock is on, all alphabetic characters are typed in uppercase. Toggle on and off by pressing the Caps Lock key on the left side of the keyboard.
Num lock	When Num Lock is on, the embedded numeric keyboard can be used. Toggle on and off by pressing the Fn + F11 keys simultaneously.
Scroll lock	When Scroll Lock is on, the screen toggles up or down one line at a time when the up and down cursor control keys are pressed. Note: Scroll Lock doesn't work in some applications. Toggle on and off by pressing the Fn + F12 keys simultaneously.

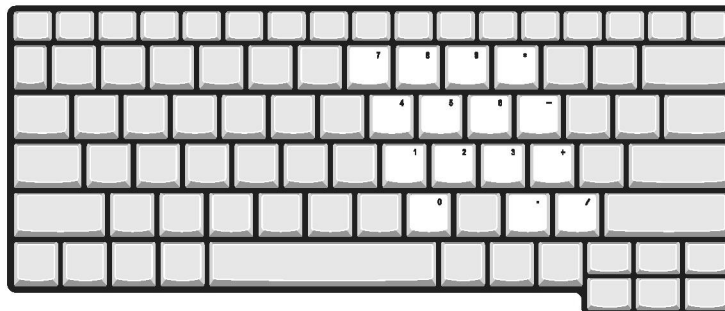

Embedded Keypad

The embedded keypad functions like a desktop numeric keypad. It is indicated by small characters located on the upper right corner of the keycaps. To simplify the keyboard legend, cursor-control key symbols are not printed on the keys.



To use the embedded numeric keys, toggle the Num Lock on by pressing the Fn + F11 keys simultaneously.

With the embedded keypad turned on, the following actions are possible:









Desired Access	Num Lock On	Num Lock On
Number keys on embedded keypad	Type numbers using embedded keypad in the normal way.	
Cursor-control keys on embedded keypad	Hold down the  key while using the cursor keys on the embedded keypad.	Hold Fn key while using cursor-control keys.
Main keyboard keys	Hold down the Fn key while typing letters using the embedded keypad keys. Simultaneously press the  key for capital letters.	Type letters in the normal way.

NOTE: If an external keyboard or keypad is connected to the computer, the Num Lock feature automatically shifts from the internal keyboard or keypad.

Windows Keys

The keyboard has two keys that perform Windows-specific functions.











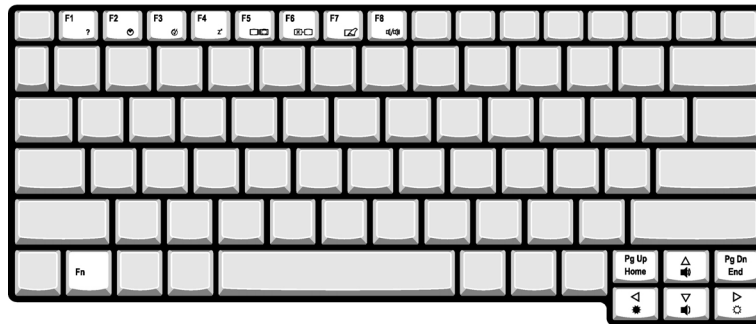



Key	Description
Windows logo key 	Pressed alone, this key has the same effect as clicking on the Windows Start button; it launches the Start menu. It can also be used with other keys to provide a variety of functions: <ul style="list-style-type: none">  + Tab (Activates the next Taskbar button)  + E (Explores the My Computer)  + F (Find Document)  + M (Minimizes all windows)  +  + M (Undoes the minimize all windows action)  + R (Displays the Run... dialog box)
Application key 	This key has the same effect as clicking the right mouse button; it opens the application's context menu.

Hotkeys

Using the Fn key with another key creates a hot key, providing a quick and convenient method for controlling various functions.

To use a hot key, first hold down the Fn key. Next, press the second key in combination. Finally, release both keys.



Hot Key	Function	Function
Fn + 	Hot key help	Displays help on hot keys.
Fn + 	Setup	Access the computer's configuration utility.
Fn + 	Power management scheme toggle	Switches the power management scheme used by the computer (function available if supported by operating system).
Fn + 	Sleep	Puts the computer in Sleep mode.
Fn + 	Display toggle	Switches display output between the display screen, external monitor (if connected) and both the display screen and external monitor.
Fn + 	Screen blank	Turns the display screen backlight off to save power. Press any key to return.
Fn + 	Touchpad toggle	Turns the internal touchpad on and off.
Fn + 	Speaker toggle	Turns the speaker on and off.
Fn + 	Volume up	Increases the speaker volume.
Fn + 	Volume down	Decreases the speaker volume.
Fn + 	Brightness up	Increases the screen brightness.
Fn + 	Brightness down	Decreases the screen brightness

NOTE: When activating hotkeys, press and hold the **Fn** key before pressing the other key in the hotkey combination.

Euro key

Your computer supports the new Euro currency character. First, hold down the Alt Gr key, and then press the Euro key.



Keyboard Ergonomics

The wide palm rest area provides a comfortable platform for your hands when typing on the keyboard. The ergonomic design enables you to adopt a relaxed, yet very efficient, typing style.

Touchpad

The built-in touchpad is a pointing device that senses movement on its surface. This means the cursor responds as you move your finger on the surface of the touchpad.

The central location on the palmrest provides optimum comfort and efficiency.



Touchpad Basics

Use the touchpad as follows:



- ❑ Move your finger across the touchpad to move the cursor.
- ❑ Press the left (1) and right (3) buttons located on the edge of the touchpad to do selection and execution functions. These two buttons are similar to the left and right buttons on a mouse. Tapping on the touchpad produces similar results.
- ❑ Use the 4-way scroll (2) button to scroll a page up, down, left or right. This button mimics your cursor pressing on the vertical and horizontal scroll bars of Windows applications.

Function	Left Button	Right Button	4-way Scroll Button	Tap
Execute	Click twice quickly			Tap twice quickly
Select	Click once			Tap once
Drag	Click and hold. Then slide your finger across the touchpad to drag the cursor over the selection.			Tap twice quickly. On the second tap, slide your finger across the touchpad to drag the cursor over the selection.
Access context menu		Click once		
Scroll			Click and hold the up/ down/ left/ right button	



NOTE: A. Keep your fingers dry and clean when using the touchpad. Also keep the touchpad dry and clean. The touchpad is sensitive to your finger movements: the lighter your touch, the better the response. Tapping harder will not increase the touchpad's responsiveness. **B.** When using an external USB mouse, you can press Fn+  to disable the touchpad.

Launch Keys

Located above the keyboard are six buttons. These buttons are special one-click buttons that perform special functions.

To see the launch keys, run the Acer Launch Manger.



Launch key	Icon	Description
Wireless		This button permits user Enable/Disable wireless LAN network.
P1		User-programmable
P2		User-programmable
P3		User-programmable
Web browser		Launches your Internet Explorer (or user-defined program).
Mail		Launches Outlook Express (or user-defined program).

Hardware Specifications and Configurations

Processor

Item	Specification
CPU type	Intel Pentium M processor at 1.3 ~ 1.8 GHz or higher FSB 400Mhz
CPU package	Micro-FCBGA
CPU core voltage	0.95V ~ 1.420V

BIOS

Item	Specification
BIOS vendor	Phoenix
BIOS Version	1.0
BIOS ROM type	Flash ROM
BIOS ROM size	512KB
BIOS package	PLCC
Supported protocols	ACPI 1.0b, APM 1.2, PC Card 95, AC97 2.1, EPP/IEEE 1284, ECP/IEEE 1284 1.7 & 1.9, PCI 2.2, PnP 1.0a, DMI 2.0, USB, DDC-2B, ODD bootable, Windows keyboard Microsoft Simple Boot Flag
BIOS password control	Set by setup manual

Second Level Cache

Item	Specification
Cache controller	Built-in CPU
Cache size	1024KB
1st level cache control	Always enabled
2st level cache control	Always enabled
Cache scheme control	Fixed in write-back

System Memory

Item	Specification
Memory controller	Intel 855GM
Onboard memory size	0MB
DIMM socket number	2 sockets (4 banks)
Supports memory size per socket	128M / 256M / 512M / 1024MB(1GB)
Supports maximum memory size	2048MB (2GB)
Supports DIMM type	DDR SDRAM (Double Data Rate-Synchronous Dynamic Random Access Memory)
Supports DIMM Speed	200/266MHz
Supports DIMM voltage	2.5V
Supports DIMM package	200-pin SODIMM
Memory module combinations	You can install memory modules in any combinations as long as they match the above specifications.

Memory Combinations

Slot 1	Slot 2	Total Memory
128 / 256 / 512 / 1024MB	0 MB	128 / 256 / 512 / 1024MB
128 / 256 / 512 / 1024MB	128MB	256 / 384 / 640 / 1152MB
128 / 256 / 512 / 1024MB	256MB	384 / 512 / 768 / 1280MB
128 / 256 / 512 / 1024MB	512MB	640 / 768 / 1024 / 1536MB
128 / 256 / 512 / 1024MB	1024MB	1152 / 1280 / 1536 / 2048MB

Above table lists some system memory configurations. You may combine DIMMs with various capacities to form other combinations.

LAN Interface

Item	Specification
Chipset	Realtek RTL8101
Supports LAN protocol	10/100 Mbps
LAN connector type	RJ45
LAN connector location	Left side

Wireless LAN Interface

Item	Specification
Chipset	Intel PRO/Wireless 2100
Supports LAN protocol	802.11b

Modem Interface

Item	Specification
Chipset	Agere
Fax modem data baud rate (bps)	14.4K
Data modem data baud rate (bps)	56K
Supports modem protocol	V.90 / V.92 MDC
Modem connector type	RJ11
Modem connector location	Left side

Hard Disk Drive Interface

Item	Specification									
Vendor & Model Name	HGST 20G(IC25 N020ATM R04), CASCADE	HGST 30G(IC25 N030ATM R04), CASCADE	HGST 40GB (IC25N040 ATMR04), CASCADE	HGST 60G(IC25 N060ATM R04), CASCADE	HGST 80GB (IC25N080 ATMR04), CASCADE	TOSHIBA 30GB(MK3 021GAS) NEPTUNE	TOSHIBA 40GB(MK4 021GAS) NEPTUNE	TOSHIBA 60GB(MK6 021GAS) NEPTUNE		
Capacity (MB)	20000	30000	40000	60000	80000	30000	40000	60000		
Bytes per sector	512	512	512	512	512	512	512	512		
Data heads	1	2	2	3	4	2	3	4		
Drive Format										
Disks	1	1	1	2	2	1	2	2		

Hard Disk Drive Interface

Item	Specification							
Spindle speed (RPM)	4200 RPM	4200RPM	4200RPM	4200RPM	4200RPM	4200RPM	4200RPM	4200RPM
Performance Specifications								
Buffer size	2048KB	2048KB	2048KB	8192KB	8192KB	2048KB	2048KB	2048KB
Interface	ATA-6	ATA-6	ATA-6	ATA-6	ATA-6	ATA-5	ATA-5	ATA-5
Max. media transfer rate (disk-buffer, Mbytes/s)	350	350	350	350	350	298	298	298
Data transfer rate (host-buffer, Mbytes/s)	100 MB/Sec. Ultra DMA mode-5	100 MB/Sec. Ultra DMA mode-5	100 MB/Sec. Ultra DMA mode-5	100 MB/Sec. Ultra DMA mode-5	100 MB/Sec. Ultra DMA mode-5	100 MB/Sec. Ultra DMA mode-5	100 MB/Sec. Ultra DMA mode-5	100 MB/Sec. Ultra DMA mode-5
DC Power Requirements								
Voltage tolerance	5V(DC) +/- 5%	5V(DC) +/- 5%	5V(DC) +/- 5%	5V(DC) +/- 5%	5V(DC) +/- 5%	5V(DC) +/- 5%	5V(DC) +/- 5%	5V(DC) +/- 5%

Audio Interface

Item	Specification
Audio Controller	Cirrus CS4299 AC'97 Codec
Audio onboard or optional	Built-in
Mono or Stereo	Mono
Resolution	20 bit stereo Digital to Analog converter 18 bit stereo Analog to Digital converter
Compatibility	Microsoft PC98/PC99, AC97 2.1
Mixed sound source	Microphone, CD, AUX
Sampling rate	48 kHz
Internal microphone	Yes
Internal speaker / Quantity	Yes
Supports PnP IRQ	IRQ10

Video Interface

Item	Specification
Chip vendor	Intel
Chip name	855GM (Integrated with Northbridge)
Supports ZV (Zoomed Video) port	No
Graph interface	Inside 855GM (Accelerated Graphics Port) Bus
Maximum resolution (LCD)	1024*768
Maximum resolution (CRT)	1600*1200

Video Memory

Item	Specification
Fixed or upgradeable	Fixed
Video memory size	32MB (Share system memory)

IEEE 1394 Port

Item	Specification
IEEE 1394 controller	Ricoh R5C593
Access location	Left side

USB Port

Item	Specification
USB Compliancy Level	2.0
EHCI	USB 2.0
Number of USB port	2
Location	Right and left side
Serial port function control	Always Enabled

PCMCIA Port

Item	Specification
PCMCIA controller	Ricoh R5C593
Supports card type	Type II
Number of slots	One
Access location	Left side
Supports ZV (Zoomed Video) port	No ZV support
Supports 32 bit CardBus	Yes (IRQ10)

System Board Major Chips

Item	Controller
System core logic	Intel 855GM
Super I/O controller	NS PC87392
Audio controller	Cirrus CS4299
Video controller	Intel 855GM
Hard disk drive controller	Intel ICH4-M
Keyboard controller	Mitsubishi M38857M8
RTC	Intel ICH4-M
IEEE 1394	Ricoh R5C593
PCMCIA	Ricoh R5C593

Keyboard

Item	Specification
Keyboard controller	Mitsubishi M38857M8
Keyboard vendor & model name	Darfon
Total number of keypads	84-key
Windows keys	Yes
Internal & external keyboard work simultaneously	Yes

Battery

Item	Specification
Vendor & model name	Sanyo / Simplo
Battery Type	Li-ion
Pack capacity	26.64W/48.84W
Cell voltage	3.7 V/cell
Number of battery cell	4/6
Package configuration	4/3 cells in series, 0/2 series in parallel
Package voltage	14.8V/4cell, 11.1V/6cell

DC/AC LCD inverter

Item	Specification		
Vendor & model name	Sumida TWS-458-018		
Input voltage (V)	-	12(typ.)	-
Input current (mA) (Vadj=1.6V)	-	70(typ.)	120(max.)
(Vadj=3.3V)	310(min.)	360(typ.)	410(max.)
Output voltage (Vrms, no load)	1600(min.)	-	-
Output voltage frequency (kHz)	47(min.)	52(typ.)	57(max.)
Output Current/Lamp (Vadj=1.6V)	1.6mA(Min.)	2.2mA(typ.)	2.8mA(max.)
(Vadj=3.3V)	5.0mA(Min.)	5.5mA(typ.)	6.0mA(max.)

NOTE: DC-AC inverter is used to generate very high AC voltage, the support to LCD CCFT backlight user, and is also responsible for the control of LCD brightness. Avoid touching the DC-AC inverter area while the system is turned on.

LCD

Item	Specification
Vendor & model name	IDT/IAXG01W IDT/IAXG02C TOSHIBA/LTM12C505D
LCD display area (diagonal, inch)	12.1
Display technology	TFT
Resolution	XGA (1024X768)
Screen Diagonal [mm]	307
Active Area [mm]	245.76(H) x 184.32(V)
Pixel Pitch [mm]	0.080(per one triad) x 0.240
Pixel Arrangement	R,G,B Vertical Stripe
Weight [grams]	290 Typ.
Physical Size [mm]	261.0(W) x 198.0(H) x 5.0(D) Typ.
Support Color	Native 262K colors(RGB 6-bit data driver)
White Luminance [cd/m ²] Design Point 1:(ICFL=3.5mA) Design Point 2:(ICFL=6.5mA)	95 Typ. (center), 90 Typ. (5 points average) 160 Typ. (center),150 Typ. (5 points average)

LCD

Item	Specification
Contrast Ratio	250 : 1 Typ.
Optical Rise Time/Fall Time [msec]	30Typ.,50 MAX.
Nominal Input Voltage VDD [Volt]	+3.3 Typ.
Power Consumption [Watt] (VDD Line) (VCFL Line)	1.2 Typ. 3.5 Typ.
Electrical Interface	4 pairs, single LVDS
Temperature Range [degree C] Operating Storage (Shipping)	0 to +50 -20 to +60

AC Adapter

Item	Specification
Vendor & model name	Lite-on 65W PA 1650-02 (WPFC) 3P
Input Requirements	
Maximum input current (A, @100Vac, full load)	1.7A max@3.5A/100Vac and 240 Vac
Nominal frequency (Hz)	50 / 60
Frequency variation range (Hz)	47 - 63
Nominal voltages (Vrms)	100 - 240
Inrush current	The maximum inrush current will be less than 220A when the adapter is connected to 100Vac(60Hz) and 240Vac(50Hz) respectively.
Efficiency	High efficiency 82% minimum, at 100~240Vac AC input, full load, warm-up condition.
Output Ratings (CV mode)	
DC output voltage	Offers constant voltage 19.0V output source with 65W max output power capacity.
Noise + Ripple	380mvp-pmax (20MHz bandwidth) for resistor load
Output current	0A (min.) 3.42A (max.)
Output Ratings (CC mode)	
DC output voltage	18.05 ~ 19.95V
Constant output	3.8A
Dynamic Output Characteristics	
Start-up time	5 sec. (@115 Vac and 230Vac full load)
Hold up time	5ms min. (@115 Vac input, full load)
Over Voltage Protection (OVP)	29V
Short circuit protection	Output can be shorted without damage, and auto recovery
Electrostatic discharge (ESD)	15kV (at air discharge) 8kV (at contact discharge)
Dielectric Withstand Voltage	
Primary to secondary	2150Vdc 10mA for 1 second
Leakage current	60uA max (240Vac, 60Hz)
Regulatory Requirements	Internal filter meets; 1. FCC class B requirements. 2. VDE 243/1991 class B requirements. 3. CISPR 22 Class B requirements. 3. VCCI class II requirements.

Power Management

Power Saving Mode	Phenomenon
<p>Standby Mode Waiting time specified by the System Standby value or the operating system elapses without any system activity. Or When the computer is about to enter Hibernation mode (e.g. during a battery-low condition), but the Hibernation file is invalid or not present.</p>	The Sleep indicator lights up
<p>Hibernation Mode When customized functions for power management are set to Hibernation and the corresponding action is taken.</p>	All power shuts off
<p>Display Standby Mode Keyboard, built-in touchpad, and an external PS/2 pointing device are idle for a specified period.</p>	The display shuts off
<p>Hard Disk Standby Mode Hard disk is idle within a specified period of time</p>	Hard disk drive is in standby mode. (spindle turned-off)

Environmental Requirements

Item	Specification
Temperature	
Operating	5 ~ +35 °C
Non-operating	-20 ~ +65 °C (unpacked)
Non-operating	Non (storage package)
Humidity	
Operating	20% to 80% RH, non-condensing
Non-operating	20% to 80% RH, non-condensing (unpacked)
Non-operating	Non (storage package)
Vibration	
Operating (unpacked)	5 ~ 500Hz: 1.0Grms (random)
Non-operating (unpacked)	5 ~ 500Hz: 2.16Grms (random)
Non-operating (packed)	5 ~ 500Hz: 2.16Grms (random)

Mechanical Specification

Item	Specification
Dimensions	273mm (W) x 231mm (D) x 24mm (H) (10.76 x 9.10 x 0.95 inches)
Weight	1.70Kg (3.7 lbs) with 6-cell battery 1.55Kg (3.4 lbs) with 4-cell battery
I/O Ports	Two USB port, one VGA (external monitor) port, Microphone/line-in jack, Headphone/external speakers/line-out jack, RJ-11 port for modem, RJ-45 port for Ethernet, one PCMCIA (Type II) slot, DC-in jack for AC adapter, one IEEE1394 port, infrared port, 3-in 1 card reader for memory cards
Drive Bays	One
Material	Plastic, aluminum-magnesium alloy
Indicators	Wireless LAN enable/disable LED, Power/Suspend Mode LED, Sleep LED, Media activity LED, Battery Charge LED, Caps Lock LED, Num Lock LED
Switch	Power

I/O Address Map

I/O Address	Function
0000-001F	DMA controller
0020-0029, 002C-002D	Programmable interrupt controller
002E-002F	PCI bus
0030-0031, 0034-0035, 0038-0039, 003C-003D	Programmable interrupt controller
0040-0043, 0050-0053	System timer
0060, 0064	Keyboard controller
0062, 0066	ACPI-Compliant Embedded Controller
0070-0077	System CMOS/real time clock
0081-0091, 0093-009F	DMA controller
00A0-00A1, 00A4-00A5, 00A8-00A9, 00AC-00AD, 00B0-00B5, 00B8-00B9, 00BC-00BD	Programmable interrupt controller
00C0-00DF	DMA controller
00F0-00F0	Numeric data processor
0170-0177, 0376	2nd EIDE device (optical drive) select
01F0-01F7, 03F6	1st EIDE device (hard drive) select
0274-0277, 0279, 0A79	ISAPNP Read Data Port
02F8-02FF	IrDA FIR
03B0-03BB, 03C0-03DF, 1800-1807	Video Controller
03F0-03F5, 03F7	Standard Floppy Disk Controller
04D0-04D1	Programmable interrupt controller
0D00-FFFF	PCI bus
1810-181F	Ultra ATA Storage Controller
1820-187F	USB Universal Host Controller
1881-189F	SMBus Controller
18C0-18FF, 1C00-1CFF	Audio Controller
2000-207F, 2400-24FF	Modem Controller
3000-30FF	Ethernet Controller
FC00-FFFF	Compatible CardBus Controller

IRQ Assignment Map

Interrupt Channel	Function (Hardware)
IRQ00	System timer
IRQ01	Keyboard
IRQ03	IrDA FIR/PCI candidate
IRQ04	COM1/PCI candidate
IRQ05	PCI candidate
IRQ06	Reserved
IRQ07	LPT (Parallel port)/PCI Candidate
IRQ08	CMOS/RTC
IRQ09	SCI IRQ used by ACPI

IRQ Assignment Map

Interrupt Channel	Function (Hardware)
IRQ10	SMBus(PIRQB#) AC'97 Audio(PIRQB#) AC'97 MODEM(PIRQB#) USB 1.1 UHCI (PIRQC#, PIRQD#) LAN(PIRQD#) CardBus(PIRQB#) IEEE1394(PIRQC#)/PCI Candidate
IRQ11	VGA(PRIQA#) FlashMemory(PIRQF#) USB 1.1 UHCI (PIRQA#) USB 2.0 EHCI(PIRQH#)/PCI Candidate
IRQ12	Touchpad (Auxiliary device)
IRQ13	Numeric data processor
IRQ14	1st EIDE device (hard disk)
IRQ15	2nd EIDE device (optical drive)

DMA Channel Assignment

DMA Channel	Function (Hardware)
DRQ0	Reserved
DRQ1	IrDA FIR
DRQ2	Floppy
DRQ3	Reserved
DRQ4	DMA controller
DRQ5	Reserved
DRQ6	Reserved
DRQ7	Reserved

System Utilities

BIOS Setup Utility

The BIOS Setup Utility is a hardware configuration program built into your computer's BIOS (Basic Input/Output System).

Your computer is already properly configured and optimized, and you do not need to run this utility. However, if you encounter configuration problems, you may need to run Setup. Please also refer to Chapter 4 Troubleshooting when problem arises.

To activate the BIOS Utility, press **F2** during POST (when "Press <F2> to enter Setup" message is prompted on the bottom of screen).

Press **F2** to enter setup. Press <F12> during POST to enter multi-boot menu. In this menu, user can change boot device without entering BIOS SETUP Utility.











PhoenixBIOS Setup Utility	
Information	Main Advanced Security Boot Exit
CPU Type:	Intel (R) Pentium (R) M processor
CPU Speed	1.70 GHz
HDD Model Name	HITACHI_DK23EA-40-(PM)
HDD Serial Number	8W5440
System BIOS Ver:	TM370 V1.00
VGA BIOS Ver:	2991
KBC Ver:	02.13.26
Serial Number:	xxxxxxxxxxxxxxxxxxxxxx
Asset Tag Number:	N/A
Product Name:	TravelMate 370
Manufacturer Name:	Acer
UUID:	xxxxxxx-xxxx-xxxx-xxxx-xxxxxxxxxxxx

F1 Help	↑↓ Select Item	F5/F6 Change Values	F9 Setup Defaults
Esc Exit	←→ Select Menu	Enter Select ▶ Sub-Menu	F10 Save and Exit

Navigating the BIOS Utility

There are six menu options: Info., Main, Advanced, Security, Boot, and Exit.

Follow these instructions:

- To choose a menu, use the cursor left/right keys ( ).
- To choose a parameter, use the cursor up/down keys ( ).
- To change the value of a parameter, press  or .
- While the item has sub-items, press  to expand this item.
- Press  while you are in any of the menu options to go to the Exit menu.
- In any menu, you can load default settings by pressing . You can also press  to save any changes made and exit the BIOS Setup Utility.

NOTE: You can change the value of a parameter if it is enclosed in square brackets. Navigation keys for a particular menu are shown on the bottom of the screen. Help for parameters are found in the Item Specific Help part of the screen. Read this carefully when making changes to parameter values.

This menu provides you the information of the system.

Information

PhoenixBIOS Setup Utility					
Information	Main	Advanced	Security	Boot	Exit

CPU Type:	Intel (R) Pentium (R) M processor
CPU Speed	1.70 GHz
HDD Model Name	HITACHI_DK23EA-40-(PM)
HDD Serial Number	8W5440
System BIOS Ver:	TM370 V1.00
VGA BIOS Ver:	2991
KBC Ver:	02.13.26
Serial Number:	xxxxxxxxxxxxxxxxxxxxxxx
Asset Tag Number:	N/A
Product Name:	TravelMate 370
Manufacturer Name:	Acer
UUID:	xxxxxxx-xxxx-xxxx-xxxx-xxxxxxxxxxxx

F1 Help	↑↓ Select Item	F5/F6 Change Values	F9 Setup Defaults
Esc Exit	←→ Select Menu	Enter Select ▶ Sub-Menu	F10 Save and Exit

Parameter	Description
CPU Type	Displays the CPU type information.
CPU Speed	Displays the CPU speed.
HDD Model Name	HDD device model name information will be retrieved automatically during system boot.
HDD Serial Number	HDD device serial number information will be retrieved automatically during system boot.
System BIOS Ver	Displays the system BIOS version.
VGA BIOS Ver	Displays the VGA BIOS version.
KBC Ver	Displays the keyboard controller firmware version.
Serial Number	Displays the system serial number.
Asset Tag Number	N/A
Product Name	Displays the product name.
Manufacturer Name	Displays the Acer company.
UUID Number	Displays the UUID (Universal Unique Identifier) string = 32 bytes.

Main

The Main screen displays a summary of your computer hardware information, and also includes basic setup parameters. It allows the user to specify standard IBM PC AT system parameters.

PhoenixBIOS Setup Utility			
Information	Main	Advanced Security Boot Exit	
System Time:	[00:00:00]	Item Specific Help <Tab>, <Shift-Tab>, or <Enter> selects field.	
System Date:	[10/01/2003]		
System Memory:	640 KB		
Extended Memory:	238 MB		
VGA Memory:	16MB		
Quiet Boot:	[Enabled]		
Power on display:	[Auto]		
LCD Auto Dim:	[Enabled]		
PXE Boot From LAN	[Enabled]		
F12 Boot Menu	[Dsiabled]		
F1 Help	↑↓ Select Item	F5/F6 Change Values	F9 Setup Defaults
Esc Exit	←→ Select Menu	Enter Select ▶ Sub-Menu	F10 Save and Exit

NOTE: The screen above is for reference only. Actual values may differ.

The table below describes the parameters in this screen. Settings in **boldface** are the default and suggested parameter settings.

Parameter	Description	Format/Option
System Time	Sets the system time.	Format: HH:MM:SS (hour:minute:second) System Time
System Date	Sets the system date.	Format: MM/DD/YYYY (month/day/year) System Date
System Memory	This field reports the memory size of the system. The user can not change the memory setting. This is display-only field. Memory size is fixed to 640 KB	
Extended Memory	This field reports the memory size of the extended memory in the system. The user can not change the memory setting. This is display-only field. Extended Memory size=Total memory size -1MB	
VGA Memory	The total amounts of memory for VGA. The user can not change the memory setting. This is display-only field.	
Quiet Boot	Determines if Logo will be displayed or not; shows diagnostic screen is disabled or enabled. Enabled: Logo is displayed, and diagnostic screen is disabled. Disabled: Logo is not displayed, and diagnostic screen is enabled.	Option: Enabled or Disabled
Power on display	Selects display device. Auto: During power process, the system will detect if any display device is connected on external video port. If any external display device is connected, the power on display will be in CRT (or projector) only mode. Otherwise it will be in LCD only mode. Both: Simultaneously enable both the integrated LCD screen and the system's external video port (for an external CRT or projector).	Option: Auto or Both
LCD Auto Dim	Determines if the system will automatically dim the LCD brightness in order to save power when AC is not present.	Option: Enabled or Disabled
PXE Boot From LAN	Selects PXE boot from LAN function.	Option: Enabled or Disabled
F12 Boot Menu	Selects the F12 boot menu function.	Option: Enabled or Disabled

NOTE: The sub-items under each device will not be shown if the device control is set to disable or auto. This is because the user is not allowed to control the settings in these cases.

Advanced

The Advanced menu screen contains parameters involving your hardware devices. It also provides advanced settings of the system.

PhoenixBIOS Setup Utility		
Information	Main	Advanced
		Security Boot Exit
Infrared Port (FIR) :	[Disabled]	Item Specific Help
Legacy USB Support :	[Disabled]	Configure Infrared Port using options:
System Boot From Hard Disk Recovery	[Disabled]	[Disable] No configuration
		[Enable] User configuration
		[Auto] BIOS or OS chooses configuration
		(OS Controlled) Displayed when controlled by OS

F1 Help	↑ ↓ Select Item	F5/F6 Change Values	F9 Setup Defaults
Esc Exit	← → Select Menu	Enter Select ▶ Sub-Menu	F10 Save and Exit

The table below describes the parameters in the screen. Settings in **boldface** are the default and suggested parameter settings.

Parameter	Description	Options
Infrared Port (FIR)	Selects serial port address and IRQ.	Disabled /Enabled/Auto
Legacy USB Support	Selects legacy USB support.	Enabled /Disabled
System Boot From Hard Disk Recovery	Selects boot from hard disk recovery	Disabled /Enabled

Security

The Security screen contains parameters that help safeguard and protect your computer from unauthorized use.

PhoenixBIOS Setup Utility					
Information	Main	Advanced	Security	Boot	Exit
				Item Specific Help	
User Password is		Clear		Supervisor Password controls accesses of the whole setup utility. It can be used to boot up when Password on boot is enabled.	
Supervisor Password is		Clear			
Set User Password		[Enter]			
Set Supervisor Password		[Enter]			
Primary HardDisk Security:		[Disabled]			
Password on Boot:		[Disabled]			

F1 Help	↑↓ Select Item	F5/F6 Change Values	F9 Setup Defaults
Esc Exit	←→ Select Menu	Enter Select ▶ Sub-Menu	F10 Save and Exit



The table below describes the parameters in this screen. Settings in **boldface** are the default and suggested parameter settings.

Parameter	Description	Option
User Password is	Shows the setting of the user password.	Clear or Set
Supervisor Password is	Shows the setting of the supervisor password.	Clear or Set
Set User Password	Press Enter to set the user password. When set, this password protects the BIOS Setup Utility from unauthorized access.	
Set Supervisor Password	Press Enter to set the supervisor password. When set, this password protects the BIOS Setup Utility from unauthorized access.	
Primary HardDisk Security	Shows the setting of the primary hard disk Security.	Disabled or Enabled
Password on Boot	Defines whether a password is required or not while the events defined in this group happened. The following sub-options are all requires the Supervisor password for changes and should be grayed out if the user password was used to enter setup.	Disabled or Enabled

NOTE: When you are prompted to enter a password, you have three tries before the system halts. Don't forget your password. If you forget your password, you may have to return your notebook computer to your dealer to reset it.

Setting a Password



Follow these steps as you set the user or the supervisor password:

1. Use the  and  keys to highlight the Set Supervisor Password parameter and press the  key. The Set Supervisor Password box appears:

Set Supervisor Password		
Enter New Password	[]
Confirm New Password	[]



2. Type a password in the “Enter New Password” field. The password length can not exceeds 8 alphanumeric characters (A-Z, a-z, 0-9, not case sensitive). Retype the password in the “Confirm New Password” field.

IMPORTANT: Be very careful when typing your password because the characters do not appear on the screen.



3. Press  .
After setting the password, the computer sets the User Password parameter to “Set”.
4. If desired, you can opt to enable the Password on boot parameter.
5. When you are done, press  to save the changes and exit the BIOS Setup Utility.

Removing a Password



Follow these steps:

1. Use the  and  keys to highlight the Set Supervisor Password parameter and press the  key. The Set Password box appears:

Set Supervisor Password		
Enter current password	[]
Enter New Password	[]
Confirm New Password	[]

2. Type the current password in the Enter Current Password field and press  .
3. Press  twice **without** typing anything in the Enter New Password and Confirm New Password fields. The computer then sets the Supervisor Password parameter to “Clear”.
4. When you have changed the settings, press  to save the changes and exit the BIOS Setup Utility.

Changing a Password

1. Use the  and  keys to highlight the Set Supervisor Password parameter and press the  key. The Set Password box appears:

Set Supervisor Password		
Enter current password	[]
Enter New Password	[]
Confirm New Password	[]

2. Type the current password in the Enter Current Password field and press  .

-
3. Type a password in the Enter New Password field. Retype the password in the Confirm New Password field.
 4. Press **ENTER**. After setting the password, the computer sets the User Password parameter to "Set".
 5. If desired, you can enable the Password on boot parameter.
 6. When you are done, press **F10** to save the changes and exit the BIOS Setup Utility.

If the verification is OK, the screen will display as following.

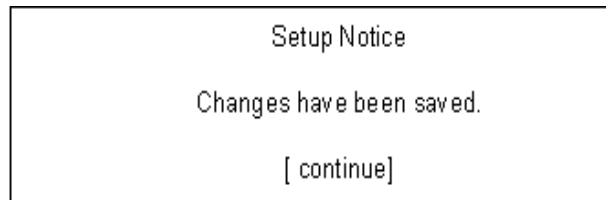

Setup Notice
Changes have been saved.
[continue]

The password setting is complete after the user presses **F10**.

If the current password entered does not match the actual current password, the screen will show you the Setup Warning.

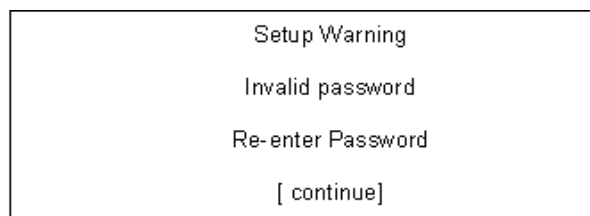

Setup Warning
Invalid password
Re-enter Password
[continue]

If the new password and confirm new password strings do not match, the screen will display the following message.

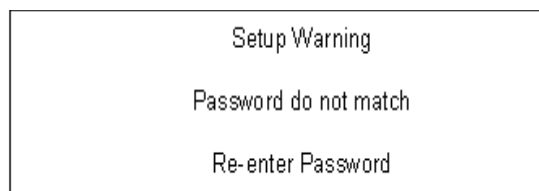

Setup Warning
Password do not match
Re-enter Password

Boot

This menu allows the user to decide the order of boot devices to load the operating system. Bootable devices includes the diskette drive in module bay, the onboard hard disk drive and the CD-ROM/DVD-ROM in module bay.

PhoenixBIOS Setup Utility					
Information	Main	Advanced	Security	Boot	Exit
<ul style="list-style-type: none">+Hard Drive+Removable Devices<ul style="list-style-type: none">CD-ROM DriveNetwork Boot				Item Specific Help	
				Use <↑> or <↓> to select a device, then press <F6> to move it up the list, or <F5> move it down the list. Press <Esc> to escape the menu	
F1 Help	↑↓ Select Item	F5/F6 Change Values	F9 Setup Defaults		
Esc Exit	←→ Select Menu	Enter Select ▶ Sub-Menu	F10 Save and Exit		

Exit

The Exit screen contains parameters that help safeguard and protect your computer from unauthorized use.

PhoenixBIOS Setup Utility					
Information	Main	Advanced	Security	Boot	Exit
Exit Saving Changes Exit Discarding Changes Load Setup Defaults Discard Changes Save Changes					Item Specific Help Exit System Setup and save your changes to CMOS.
F1 Help	↑↓ Select Item	F5/F6 Change Values	F9 Setup Defaults		
Esc Exit	←→ Select Menu	Enter Select	▶ Sub-Menu	F10 Save and Exit	

The table below describes the parameters in this screen.

Parameter	Description
Exit Saving Changes	Exit System Setup and save your changes to CMOS.
Exit Discarding Changes	Exit utility without saving setup data to CMOS.
Load Setup Default	Load default values for all SETUP item.
Discard Changes	Load previous values from CMOS for all SETUP items.
Save Changes	Save Setup Data to CMOS.

BIOS Flash Utility

The BIOS flash memory update is required for the following conditions:

- New versions of system programs
- New features or options
- Restore a BIOS when it becomes corrupted.

Use the Phlash utility to update the system BIOS flash ROM.

NOTE: If you do not have a crisis recovery diskette at hand, then you should create a **Crisis Recovery Diskette** before you use the Phlash utility.

NOTE: Do not install memory-related drivers (XMS, EMS, DPMS) when you use the Phlash.

NOTE: Please use the AC adaptor power supply when you run the Phlash utility. If the battery pack does not contain enough power to finish BIOS flash, you may not boot the system because the BIOS is not completely loaded.

Follow the steps below to run the Phlash.

1. Prepare a bootable diskette.
2. Copy the Phlash utilities to the bootable diskette.
3. Then boot the system from the bootable diskette. The Phlash utility has auto-execution function.

System Diagnostic Diskette

This diagnostic diskette is for the Acer TravelMate 370 series notebook machine. However, system diagnostic utility is not ready as service CD released. Acer HQ CSD will upload the utility to CSD website as soon as it is ready.

Machine Disassembly and Replacement

This chapter contains step-by-step procedures on how to disassemble the notebook computer for maintenance and troubleshooting.

To disassemble the computer, you need the following tools:

- Wrist grounding strap and conductive mat for preventing electrostatic discharge
- small Philips screwdriver
- flat head screwdriver
- Philips screwdriver
- tweezers

NOTE: The screws for the different components vary in size. During the disassembly process, group the screws with the corresponding components to avoid mismatch when putting back the components. When you remove the stripe cover, please be careful not to scrape the cover.

General Information

Before You Begin

Before proceeding with the disassembly procedure, make sure that you do the following:

1. Turn off the power to the system and all peripherals.
2. Unplug the AC adapter and all power and signal cables from the system.
3. Remove the battery pack.

Disassembly Procedure Flowchart

The flowchart on the succeeding page gives you a graphic representation on the entire disassembly sequence and instructs you on the components that need to be removed during servicing. For example, if you want to remove the system board, you must first remove the keyboard, then disassemble the inside assembly frame in that order.

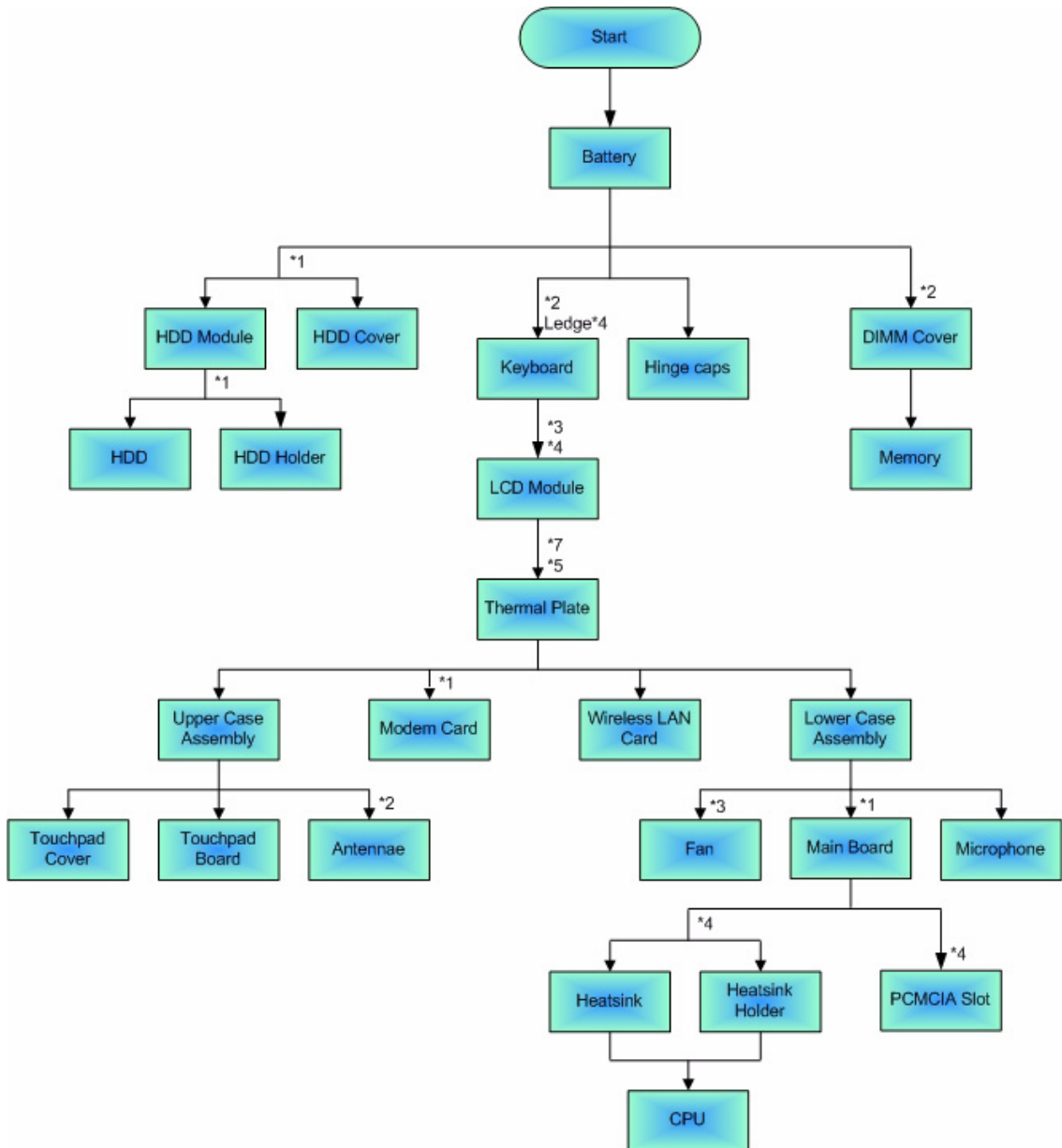

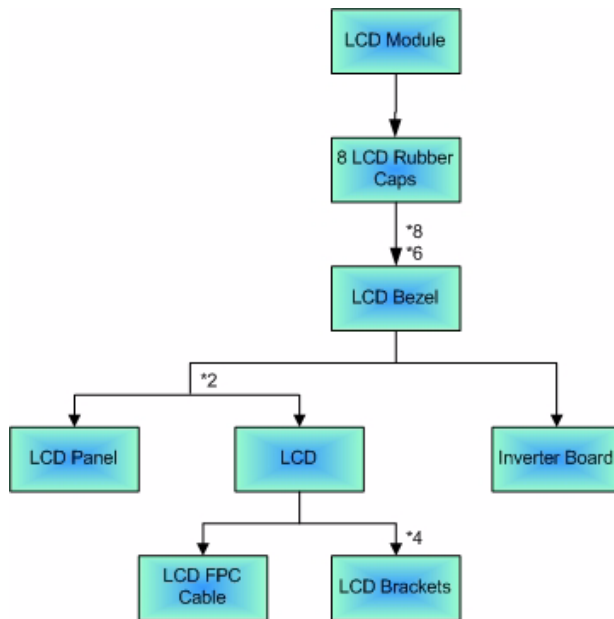

Removing the Battery

1. Slide the two battery latches.
2. Then remove the battery.



Removing the Memory/HDD Module

1. Remove the two screws holding the DIMM cover.
2. Then remove the DIMM cover.

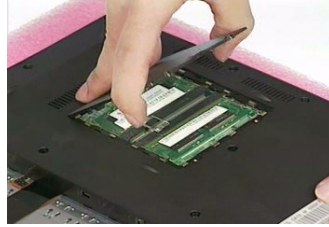

3. Pop out the memory.
4. Then remove the memory.

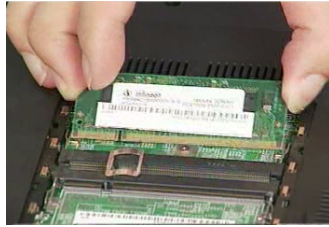
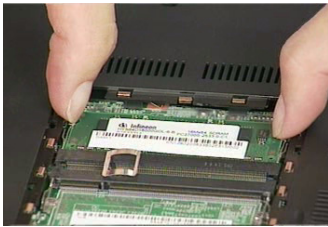

5. Remove one screw that secures the HDD cover.
6. Then remove the HDD cover.
7. Pull out the HDD module carefully.

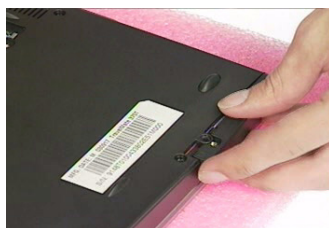

Removing the Keyboard

1. Remove the two screws holding the keyboard on the bottom.
2. Use a small Philips screwdriver and your finger to unlock four ledges as the picture shows.



3. Turn over the keyboard as the picture shows.
4. Disconnect the keyboard cable.
5. Then remove the keyboard.

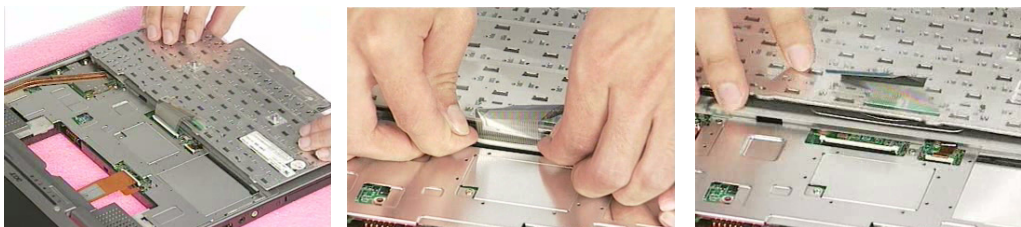

Disassembling the Main Unit

1. Remove one screw that secures the LCD FPC cable as the picture shows.
2. Then disconnect the LCD FPC cable from the main board.

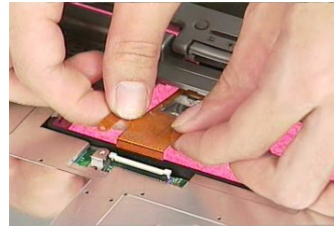
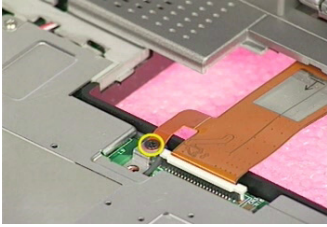

3. Remove the two screws holding the LCD FPC cable on the bottom.

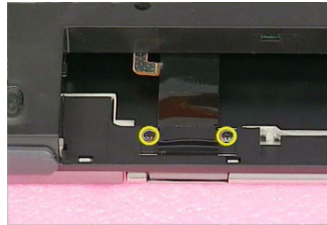

4. Push the left and right hinge caps on the front side carefully.
5. Then hold the left and right hinge caps on the rear side as the picture shows.
6. Remove the left and right hinge caps.

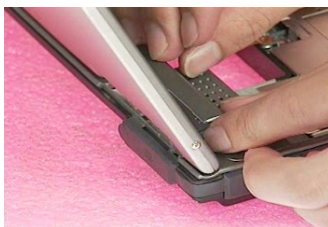
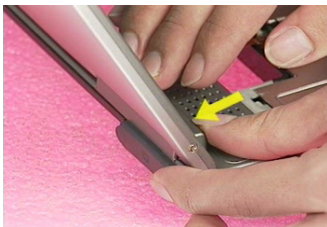

7. Remove the two screws holding the LCD module on one side.
8. Then remove another two screws on the other side.



9. Slide the LCD latch.

10. Then turn over the LCD module as the picture shows.



11. Pull out the LCD FPC cable carefully.

12. Then detach the entire LCD module.

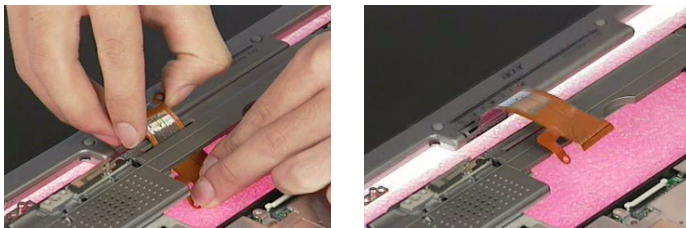

13. Remove the seven screws on the bottom.

14. Remove the five screws holding the thermal plate.

15. Then take out the thermal plate.



16. Disconnect the touchpad cable as the picture shows.

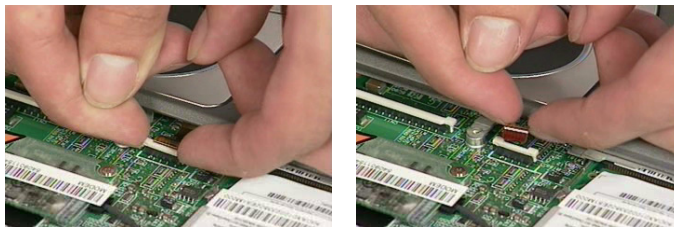

17. Disconnect the speaker cable from the main board.

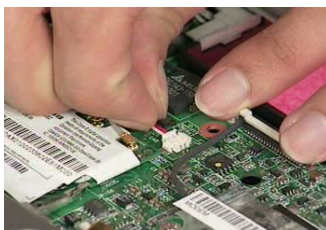

18. Disconnect the main and aux wireless LAN antennae. (main: left/black, aux: right/gray)

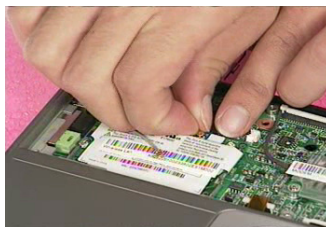
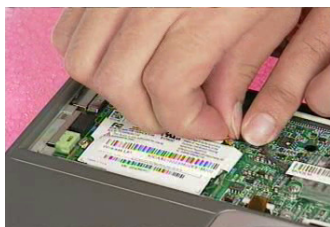

19. Pop out the wireless LAN card.

20. Then take out the wireless LAN card.

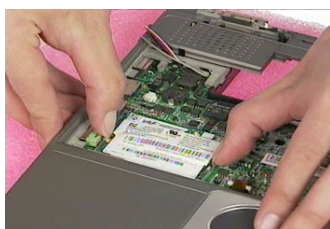

21. Disconnect the cover switch cable from the main board.

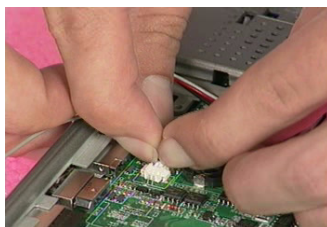

22. Use a flat screwdriver as the picture shows to detach the upper case assembly.

23. Then detach the upper case carefully.

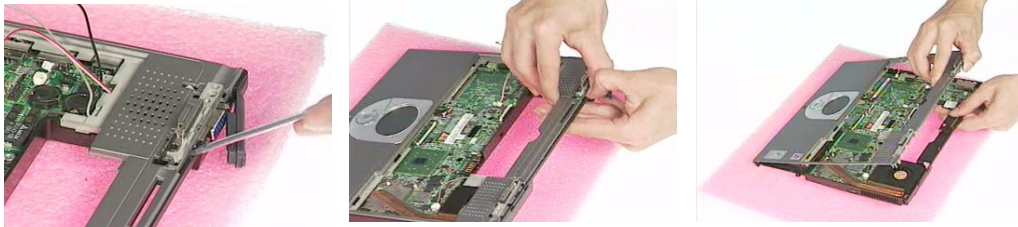

24. Remove the touchpad cover from the upper case as the picture shows.

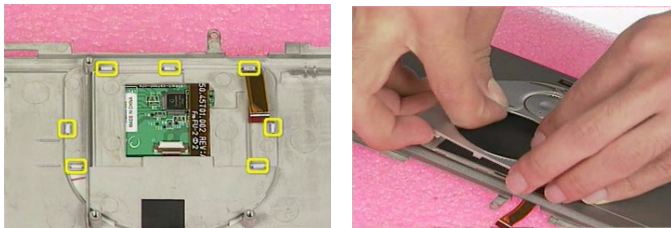

25. Disconnect the touchpad cable from the touchpad board.

26. Then take out the touchpad board carefully.



27. Tear off the tape fastening the wireless LAN antennae as picture shows.

28. Take out the wireless LAN antennae from the fastening fillisters.

29. Pull out the main and aux wireless LAN antennae carefully.

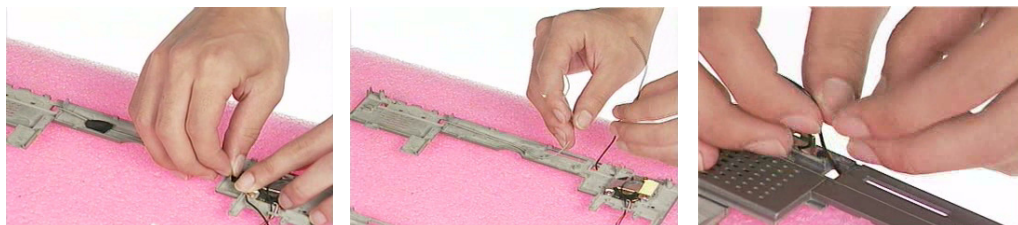

30. Remove one screw holding the main wireless LAN antenna.

31. Then take out the main wireless LAN antenna.

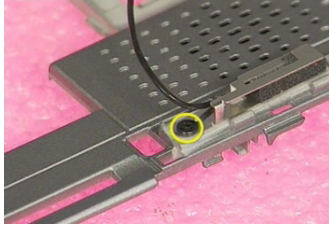

32. Remove one screw holding the aux wireless LAN antenna.
33. Then take out the aux wireless LAN antenna.

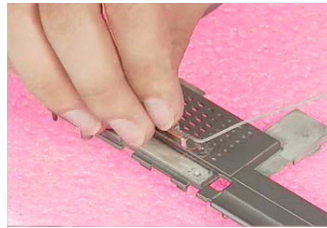
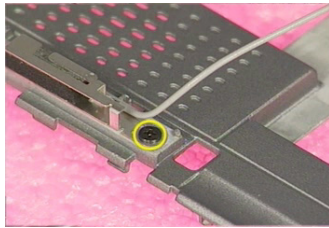

34. Remove one screw that secures the modem card.
35. Remove the modem card.
36. Then disconnect the modem card cable from the modem card.

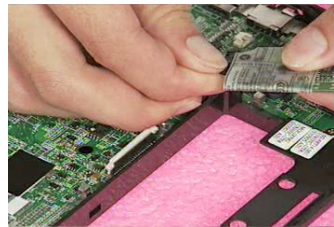
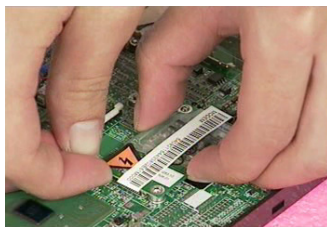
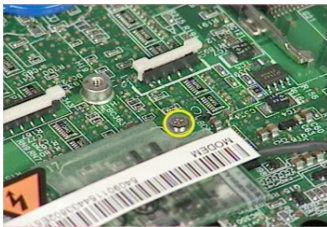

37. Disconnect the fan cable from the main board.

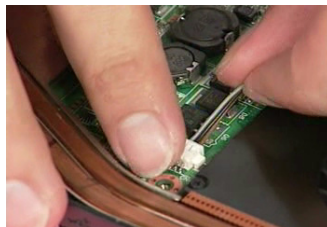

38. Tear off the tape fastening the microphone cable as picture shows.
39. Then disconnect the microphone cable from the main board.

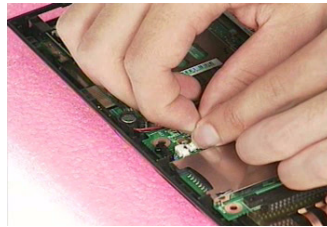
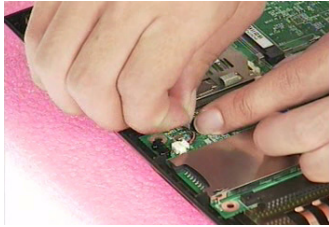

- 40. Remove one screw that secure the main board.
- 41. Then take out the main board from the lower case.

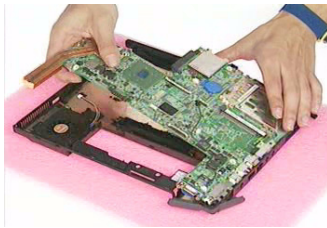
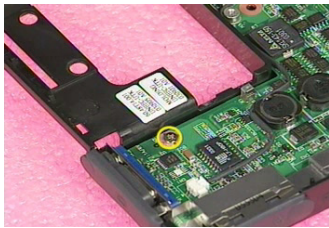

- 42. Remove the three screws that secure the fan.
- 43. Then remove the fan from the lower case.

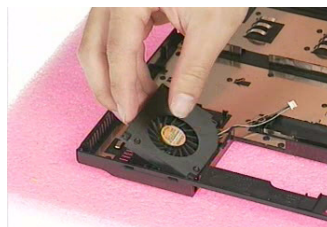
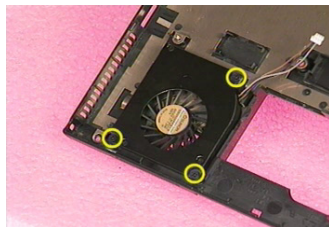

Disassembling the LCD Module

1. Remove the eight LCD rubber caps as the picture shows.
2. Then remove the eight screws holding the LCD bezel.

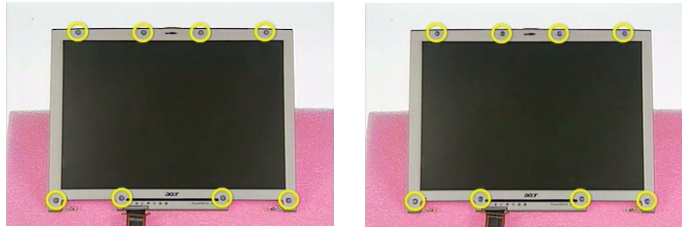

3. Remove the three screws on one side.
4. Remove another three screws on the other side.
5. Then detach the LCD bezel carefully.

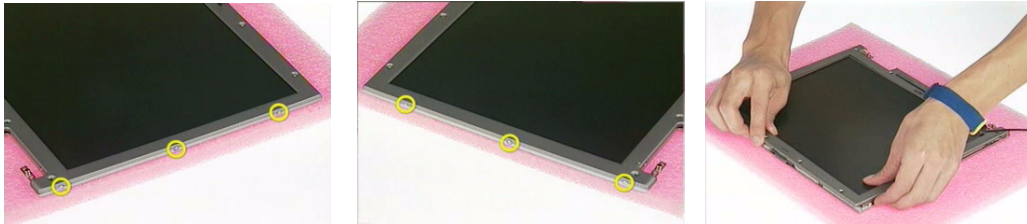

6. Remove one screw holding the LCD bracket on one side.
7. Remove another screw holding the LCD bracket on the other side.
8. Then remove the entire LCD from the LCD panel.

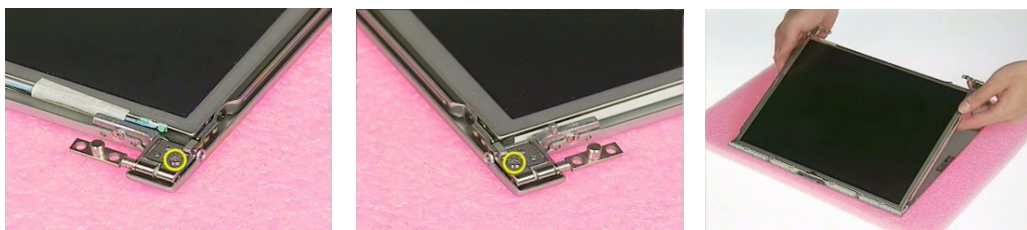

9. Disconnect the LCD FPC cable from the inverter board.
10. Disconnect the high voltage cable from the inverter board.
11. Then take out the inverter board.



- 12. Tear off the tape that fastens the LCD FPC cable.
- 13. Disconnect the LCD FPC cable.

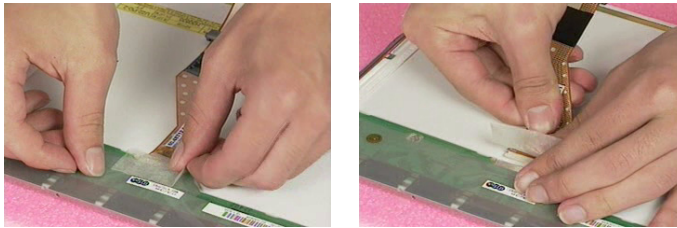

- 14. Remove the two screws holding the left LCD bracket.
- 15. Remove the left LCD bracket.

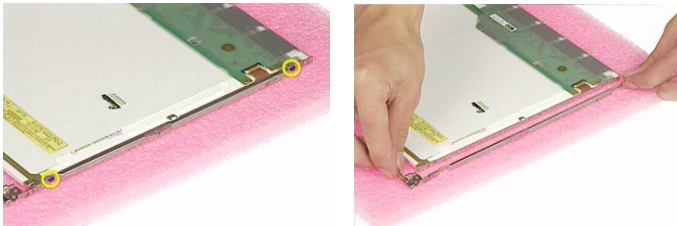

- 16. Remove the two screws holding the right LCD bracket.
- 17. Remove the right LCD bracket.

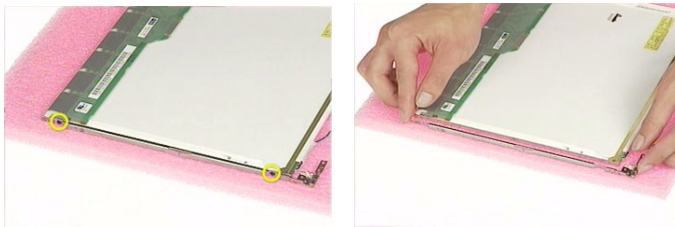

Disassembling the External Modules

Disassembling the HDD Module

1. Remove one screws holding the HDD holder.
2. Then remove the HDD carefully.



Troubleshooting

Use the following procedure as a guide for computer problems.

NOTE: The diagnostic tests are intended to test this model. Non-Acer products, prototype cards, or modified options can give false errors and invalid system responses.

1. Duplicate symptom and obtain the failing symptoms in as much detail as possible.
2. Distinguish symptom. Verify the symptoms by attempting to re-create the failure by running the diagnostic test or by repeating the same operation.
3. Disassemble and assemble the unit without any power sources.
4. If any problem occurs, you can perform visual inspection before you follow this chapter's instructions. You can check the following:
 - power cords are properly connected and secured;
 - there are no obvious shorts or opens;
 - there are no obviously burned or heated components;
 - all components appear normal.
5. Use the following table with the verified symptom to determine which page to go to.

Symptoms (Verified)	Go To
Power failure. (The power indicator does not go on or stay on.)	"Power System Check" on page 57
POST does not complete. No beep or error codes are indicated.	"Power-On Self-Test (POST) Error Message" on page 59 "Undetermined Problems" on page 67
POST detects an error and displayed messages on screen.	"Error Message List" on page 60
The diagnostic test detected an error and displayed a FRU code.	"System Diagnostic Diskette" on page 38
Other symptoms (i.e. LCD display problems or others).	"Power-On Self-Test (POST) Error Message" on page 59
Symptoms cannot be re-created (intermittent problems).	Use the customer-reported symptoms and go to "Power-On Self-Test (POST) Error Message" on page 59 "Intermittent Problems" on page 66 "Undetermined Problems" on page 67

System Check Procedures

External Diskette Drive Check

Do the following to isolate the problem to a controller, driver, or diskette. A write-enabled, diagnostic diskette is required.

NOTE: Make sure that the diskette does not have more than one label attached to it. Multiple labels can cause damage to the drive or cause the drive to fail.

Do the following to select the test device. See “System Diagnostic Diskette” on page 38 for details.

1. Boot from the diagnostics diskette and start the diagnostics program (see “System Diagnostic Diskette” on page 38).
2. See if FDD Test is passed as the program runs to FDD Test.
3. Follow the instructions in the message window.

If an error occurs with the internal diskette drive, reconnect the diskette connector on the system board.

If the error still remains:

1. Reconnect the external diskette drive/DVD-ROM module.
2. Replace the external diskette drive/CD-ROM module.
3. Replace the main board.

External CD-ROM Drive Check

Do the following to isolate the problem to a controller, drive, or CD-ROM. Make sure that the CD-ROM does not have any label attached to it. The label can cause damage to the drive or can cause the drive to fail.

Do the following to select the test device:

1. Boot from the diagnostics diskette and start the diagnostics program (refer to “System Diagnostic Diskette” on page 38).
2. See if CD-ROM Test is passed when the program runs to CD-ROM Test.
3. Follow the instructions in the message window.

If an error occurs, reconnect the connector on the System board. If the error still remains:

1. Reconnect the external diskette drive/CD-ROM module.
2. Replace the external diskette drive/CD-ROM module.
3. Replace the main board.

Keyboard or Auxiliary Input Device Check

Remove the external keyboard if the internal keyboard is to be tested.

If the internal keyboard does not work or an unexpected character appears, make sure that the flexible cable extending from the keyboard is correctly seated in the connector on the system board.

If the keyboard cable connection is correct, run the Keyboard Test. See "System Diagnostic Diskette" on page 30 for details.

If the tests detect a keyboard problem, do the following one at a time to correct the problem. Do not replace a non-defective FRU:

1. Reconnect the keyboard cables.
2. Replace the keyboard.
3. Replace the main board.

The following auxiliary input devices are supported by this computer:

- Numeric keypad
- External keyboard

If any of these devices do not work, reconnect the cable connector and repeat the failing operation.

Memory Check

Memory errors might stop system operations, show error messages on the screen, or hang the system.

1. Boot from the diagnostics diskette and start the diagnostics program (please refer to main board).
2. Go to the diagnostic memory in the test items.
3. Press F2 in the test items.
4. Follow the instructions in the message window.

NOTE: Make sure that the DIMM is fully installed into the connector. A loose connection can cause an error.

Power System Check

To verify the symptom of the problem, power on the computer using each of the following power sources:

1. Remove the battery pack.
2. Connect the power adapter and check that power is supplied.
3. Disconnect the power adapter and install the charged battery pack; then check that power is supplied by the battery pack.

If you suspect a power problem, see the appropriate power supply check in the following list:

- "Check the Battery Pack" on page 58

Check the Battery Pack

To check the battery pack, do the following:

From Software:

1. Check out the Power Management in control Panel
2. In Power Meter, confirm that if the parameters shown in the screen for Current Power Source and Total Battery Power Remaining are correct.
3. Repeat the steps 1 and 2, for both battery and adapter.
4. This helps you identify first the problem is on recharging or discharging.

From Hardware:

1. Power off the computer.
2. Remove the battery pack and measure the voltage between battery terminals 1(+) and 6(ground). See the following figure
3. If the voltage is still less than 7.5 Vdc after recharging, replace the battery.

To check the battery charge operation, use a discharged battery pack or a battery pack that has less than 50% of the total power remaining when installed in the computer.

If the battery status indicator does not light up, remove the battery pack and let it return to room temperature. Re-install the battery pack.

If the charge indicator still does not light up, replace the battery pack. If the charge indicator still does not light up, replace the DC/DC charger board.

Touchpad Check

If the touchpad doesn't work, do the following actions one at a time to correct the problem. Do not replace a non-defective FRU:

1. After rebooting, run Tracking Pad PS2 Mode Driver. For example, run Syn touch driver.
2. Run utility with the PS/2 mouse function and check if the mouse is working.
3. If the PS/2 mouse does not work, then check if the main board to switch board FPC is connected O.K.
4. If the main board to switch board FPC is connected well, then check if the FCC on touch pad PCB connects properly.
5. If the FCC on touch pad PCB connects properly, then check if LS851 JP1 Pin6=5V are pulsed. If yes, then replace switch board. If no, then go to next step.
6. Replace touch pad PCB.
7. If the touch pad still does not work, then replace FPC on Track Pad PCB.

After you use the touchpad, the pointer drifts on the screen for a short time. This self-acting pointer movement can occur when a slight, steady pressure is applied to the touchpad pointer. This symptom is not a hardware problem. No service actions are necessary if the pointer movement stops in a short period of time.

Power-On Self-Test (POST) Error Message

The POST error message index lists the error message and their possible causes. The most likely cause is listed first.

NOTE: Perform the FRU replacement or actions in the sequence shown in FRU/Action column, if the FRU replacement does not solve the problem, put the original part back in the computer. Do not replace a non-defective FRU.

This index can also help you determine the next possible FRU to be replaced when servicing a computer.

If the symptom is not listed, see “Undetermined Problems” on page 67.

The following lists the error messages that the BIOS displays on the screen and the error symptoms classified by function.

NOTE: Most of the error messages occur during POST. Some of them display information about a hardware device, e.g., the amount of memory installed. Others may indicate a problem with a device, such as the way it has been configured.

NOTE: If the system fails after you make changes in the BIOS Setup Utility menus, reset the computer, enter Setup and install Setup defaults or correct the error.

Index of Error Messages

Error Message List

Error Messages	FRU/Action in Sequence
Struck Key	See "Keyboard or Auxiliary Input Device Check" on page 57
System CMOS checksum bad - Default configuration used	RTC battery Run BIOS Setup Utility to reconfigure system, then reboot system.
Real time clock error	RTC battery Run BIOS Setup Utility to reconfigure system time, then reboot system. Main board
Previous boot incomplete - Default configuration used	"Load Default Settings" in BIOS Setup Utility. RTC batter Main board.
Invalid System Configuration Data	"Load Default Settings" in BIOS Setup Utility. Main board.
Operating system not found	Enter Setup and see if fixed disk and drive A are properly identified. Diskette drive Hard disk drive Main board.

Error Message List

No beep Error Messages	FRU/Action in Sequence
Power-on indicator turns off and LCD is blank.	Power source (battery pack and power adapter.) See "Power System Check" on page 57 Ensure every connector is connected tightly and correctly. Reconnect the DIMM. Main board.
Power-on indicator turns on and LCD is blank.	Power source (battery pack and power adapter.) See "Power System Check" on page 57 Reconnect the LCD connector Hard disk drive LCD cable LCD inverter LCD Main board
Power-on indicator turns on and LCD is blank. But you can see POST on an external CRT.	Reconnect the LCD connectors. LCD cable LCD inverter LCD Main board
Power-on indicator turns on and a blinking cursor shown on LCD during POST.	Ensure every connector is connected tightly and correctly. Main board

Index of Symptom-to-FRU Error Message

LCD-Related Symptoms

Symptom / Error	Action in Sequence
LCD backlight doesn't work	First, plug a monitor to CRT port. Next, enter BIOS utility to running "Load Default Settings" then reboot the system. Reconnect the LCD connectors. Keyboard (if the brightness function key doesn't work). LCD cable LCD inverter LCD Main board
LCD is too dark LCD brightness cannot be adjusted	Enter BIOS Utility to execute "Load Setup Default Settings", then reboot system. Reconnect the LCD connectors. Keyboard (if the brightness function key doesn't work). LCD cable LCD inverter LCD Main board
Unreadable LCD screen Missing pels in characters Abnormal screen Wrong color displayed LCD has extra horizontal or vertical lines displayed.	Reconnect the LCD cable LCD cable LCD Main board

Indicator-Related Symptoms

Symptom / Error	Action in Sequence
Indicator incorrectly remains off or on, but system runs correctly	Main board
HDD/CD-ROM active indicators cannot work	HDD/CD-ROM drive Device driver Main board

Power-Related Symptoms

Symptom / Error	Action in Sequence
Power shuts down during operation	Power source (battery pack and power adapter). See "Power System Check" on page 57. Battery pack AC adapter See if the thermal module is overheat (Heat sink or fan). Main board
The system cannot power-on.	Power source (battery pack and power adapter). See "Power System Check" on page 57. Battery pack Power adapter CPU Main board
The system cannot power-off.	In Windows XP operating system, hold and press the power switch for more than 4 seconds. If the system can power off, then the main board is OK. Verify OS in the HDD. Main board

Power-Related Symptoms

Symptom / Error	Action in Sequence
Battery can't be charged or discharged	See "Check the Battery Pack" on page 58. Battery pack Main board
System hang during POST	ODD/HDD/FDD/RAM module Main board

PCMCIA-Related Symptoms

Symptom / Error	Action in Sequence
System cannot detect the PC Card (PCMCIA)	PCMCIA slot assembly Main board
PCMCIA slot pin is damaged.	PCMCIA slot assembly
PC Card cannot be inserted or ejected	Check if the PCMCIA slot is blocked Main board

Memory-Related Symptoms

Symptom / Error	Action in Sequence
Memory count (size) appears different from actual size.	Enter BIOS Setup Utility to execute "Load Default Settings" then reboot system. RAM module Main board Check BIOS revision
System can power on, but you hear two long beeps: "B--, B--" and the LCD is blank.	Reinsert DIMM DIMM Main board

Speaker-Related Symptoms

Symptom / Error	Action in Sequence
In Windows, multimedia programs, no sound comes from the computer.	OS volume control Audio driver Speaker Main board
Internal speakers make noise or emit no sound.	Speaker Main board
Microphone cannot work	Audio driver Volume control in Windows XP Main board

Power Management-Related Symptoms

Symptom / Error	Action in Sequence
The system will not enter hibernation mode	Power option in Windows XP Hard disk drive Main board
The system doesn't enter standby mode after closing the lid of the portable computer.	Driver of Power Option Properties Lid close switch in upper case Main board

Power Management-Related Symptoms

Symptom / Error	Action in Sequence
The system doesn't resume from hibernation/standby mode.	Connect AC adapter then check if the system resumes from Standby/Hibernation mode. Check if the battery is low. Hard disk drive Main board
The system doesn't resume from standby mode after opening the lid of the portable computer.	LCD cover switch Main board
Battery fuel gauge in Windows doesn't go higher than 90%.	Refresh battery (continue use battery until power off, then charge battery). Battery pack Main board
System hangs intermittently.	Reconnect hard disk/CD-ROM drives. Main board

Peripheral-Related Symptoms

Symptom / Error	Action in Sequence
System configuration does not match the installed devices.	Enter BIOS Setup Utility to execute "Load Setup defaults", then reboot system. Reconnect hard disk/CD-ROM drives/FDD or other peripherals. Main board
External display does not work correctly.	Press Fn+F5, LCD/CRT/Both display switching Keyboard Main board
USB does not work correctly	See "System Diagnostic Diskette" on page 38 Main board
Print problems.	Enter BIOS Setup Utility to execute "Load Default Settings" then reboot the system. Run printer self-test. Printer driver Printer cable Printer Main board
Parallel port device problems	Enter BIOS Setup Utility to execute "Load Default Settings" then reboot the system. Device driver Device cable Device Main board

Keyboard/Touchpad-Related Symptoms

Symptom / Error	Action in Sequence
Keyboard (one or more keys) does not work.	Reconnect the keyboard cable. Keyboard Main board
Touchpad does not work.	Reconnect touchpad cable. Touchpad board Main board

Modem/LAN-Related Symptoms

Symptom / Error	Action in Sequence
Internal modem does not work correctly.	See "System Diagnostic Diskette" on page 38. Phone cable Driver Reconnect the Internal modem cable to the main board tightly. Main board
Internal LAN does not work correctly	Lan cable Driver Main board

NOTE: If you cannot find a symptom or an error in this list and the problem remains, see "Undetermined Problems" on page 57.

Intermittent Problems

Intermittent system hang problems can be caused by a variety of reasons that have nothing to do with a hardware defect, such as: cosmic radiation, electrostatic discharge, or software errors. FRU replacement should be considered only when a recurring problem exists.

When analyzing an intermittent problem, do the following:

1. Run the diagnostic test for the system board in loop mode at least 10 times.
2. If no error is detected, do not replace any FRU.
3. If any error is detected, replace the FRU. Rerun the test to verify that there are no more errors.

Undetermined Problems

The diagnostic problems does not identify which adapter or device failed, which installed devices are incorrect, whether a short circuit is suspected, or whether the system is inoperative.

Follow these procedures to isolate the failing FRU (do not isolate non-defective FRU).

NOTE: Verify that all attached devices are supported by the computer.

NOTE: Verify that the power supply being used at the time of the failure is operating correctly. (See "Power System Check" on page 57):

1. Power-off the computer.
2. Visually check them for damage. If any problems are found, replace the FRU.
3. Remove or disconnect all of the following devices:
 - Non-Acer devices
 - Printer, mouse, and other external devices
 - Battery pack
 - Hard disk drive
 - DIMM
 - PC Cards
4. Power-on the computer.
5. Determine if the problem has changed.
6. If the problem does not recur, reconnect the removed devices one at a time until you find the failing FRU.
7. If the problem remains, replace the following FRU one at a time. Do not replace a non-defective FRU:
 - System board
 - LCD assembly

Jumper and Connector Locations

Top View

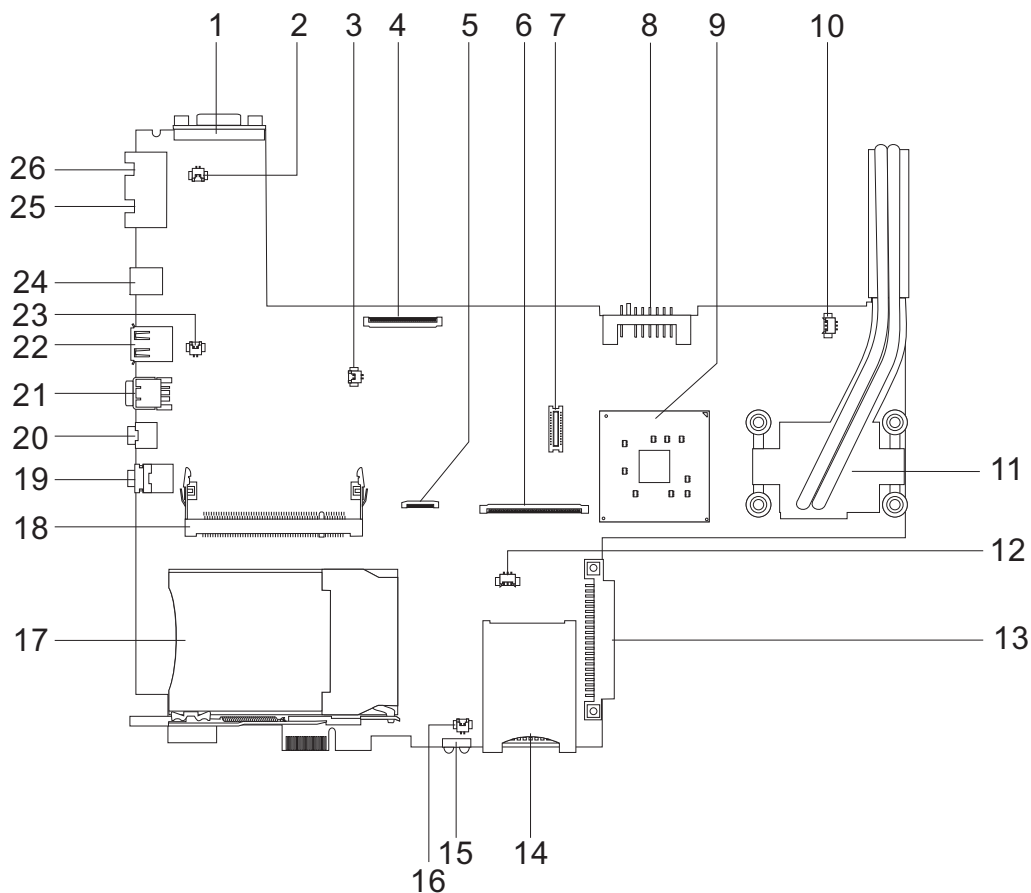

1	External Display Port	14	3-in1 Card Reader Slot
2	Modem Cable Connector	15	Infrared Port
3	Speaker Connector	16	Microphone Connector
4	LCD FPC Connectors	17	PCMCIA Slot
5	Touchpad Board Connectors	18	Mini-PCI Slot
6	Keyboard Connector	19	Microphone/Line-in Jack
7	Modem Board Connector	20	Headphone/Speaker/Line-out Jack
8	Battery Connector	21	IEEE 1394 Port
9	North Bridge	22	USB Port
10	Fan Connector	23	Cover Switch Connector
11	CPU	24	DC-In
12	RTC Battery Connector	25	RJ45 Ethernet Connector
13	HDD Connector	26	RJ11 Modem Connector

Bottom View

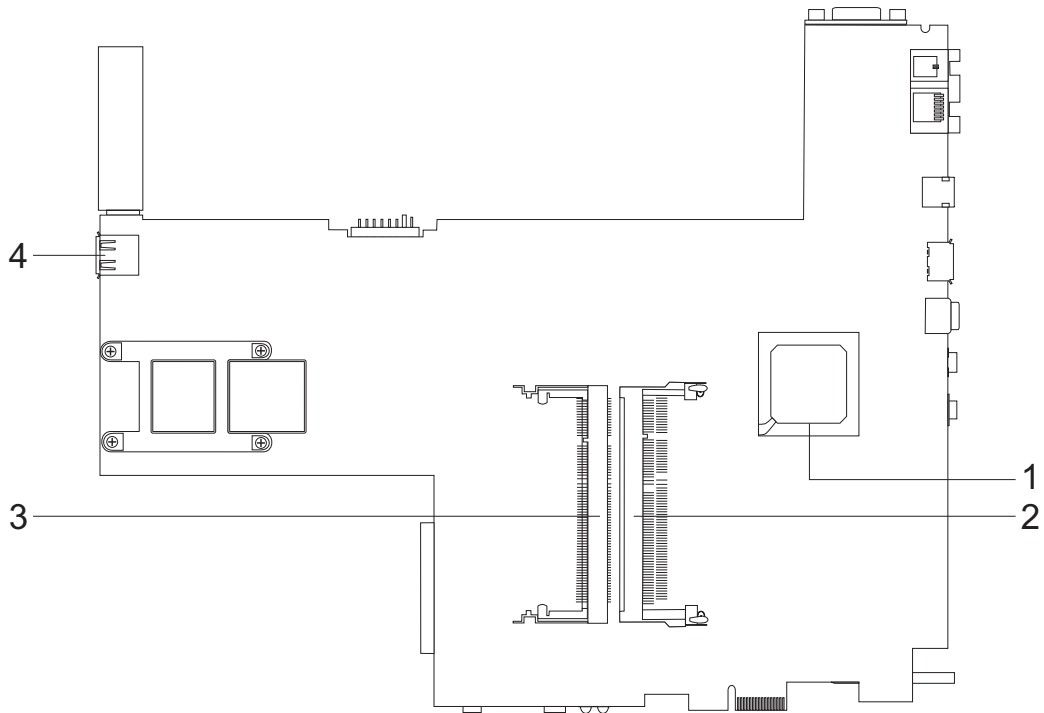

1 South Bridge
2 DIMM Slot

3 DIMM Slot
4 USB port

FRU (Field Replaceable Unit) List

This chapter gives you the FRU (Field Replaceable Unit) listing in global configurations of TravelMate 370. Refer to this chapter whenever ordering for parts to repair or for RMA (Return Merchandise Authorization). Please also note that there are some common parts for TravelMate 370, yet the LCD modules are different in two model.

Please note that WHEN ORDERING FRU PARTS, you should check the most up-to-date information available on your regional web or channel. For whatever reasons a part number change is made, it will not be noted on the printed Service Guide. For ACER AUTHORIZED SERVICE PROVIDERS, your Acer office may have a DIFFERENT part number code from those given in the FRU list of this printed Service Guide. You MUST use the local FRU list provided by your regional Acer office to order FRU parts for repair and service of customer machines.

NOTE: To scrap or to return the defective parts, you should follow the local government ordinance or regulations on how to dispose it properly, or follow the rules set by your regional Acer office on how to return it.

Exploded Diagram

THE Unit

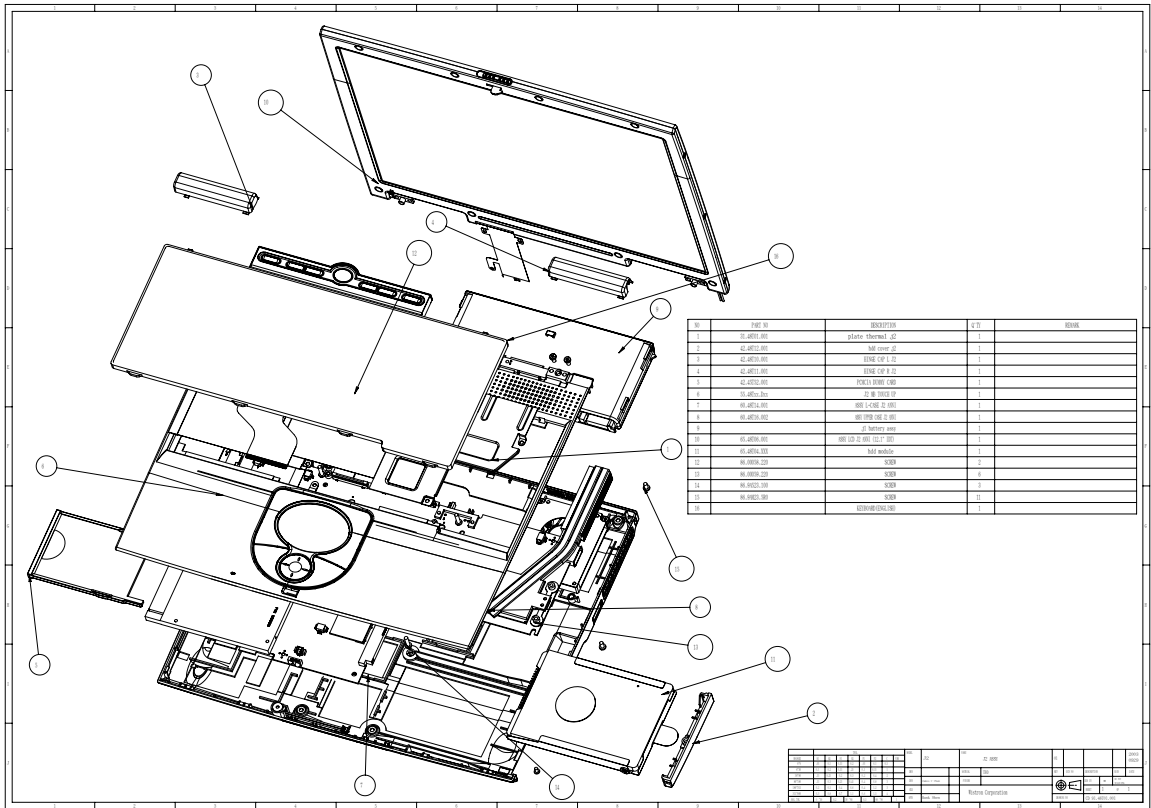

LCD 12.1"

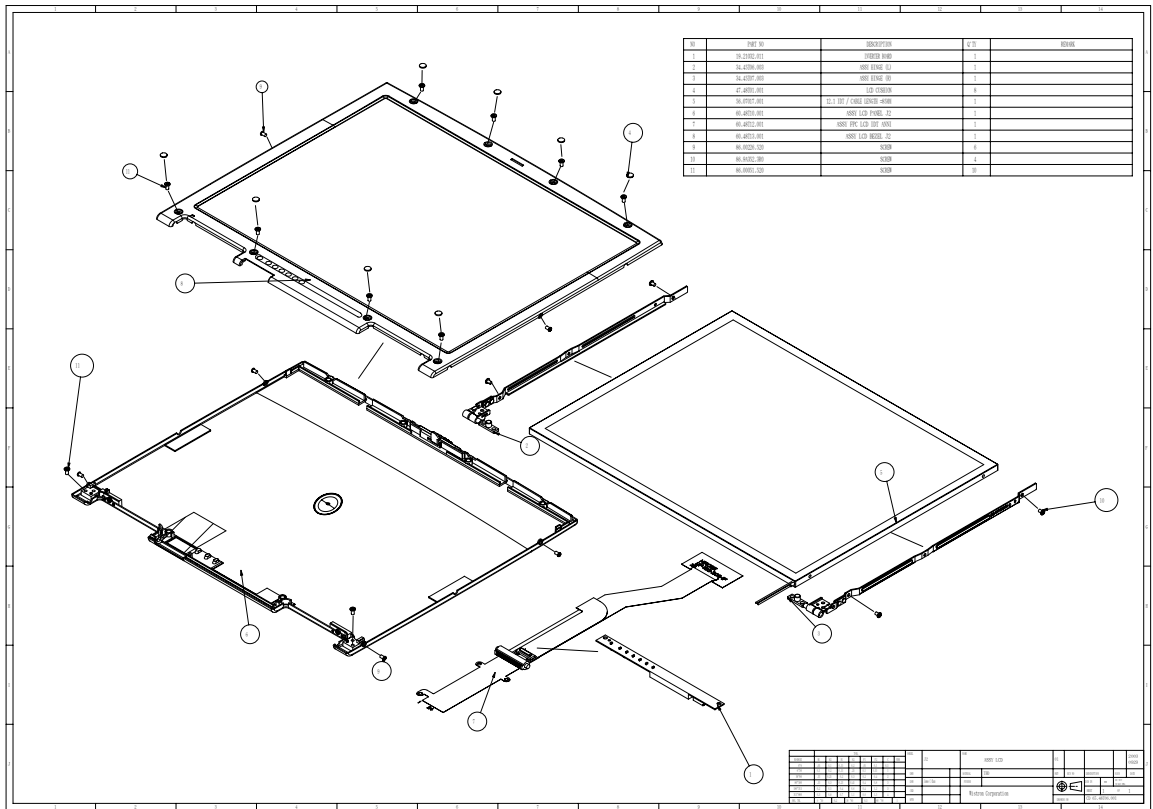



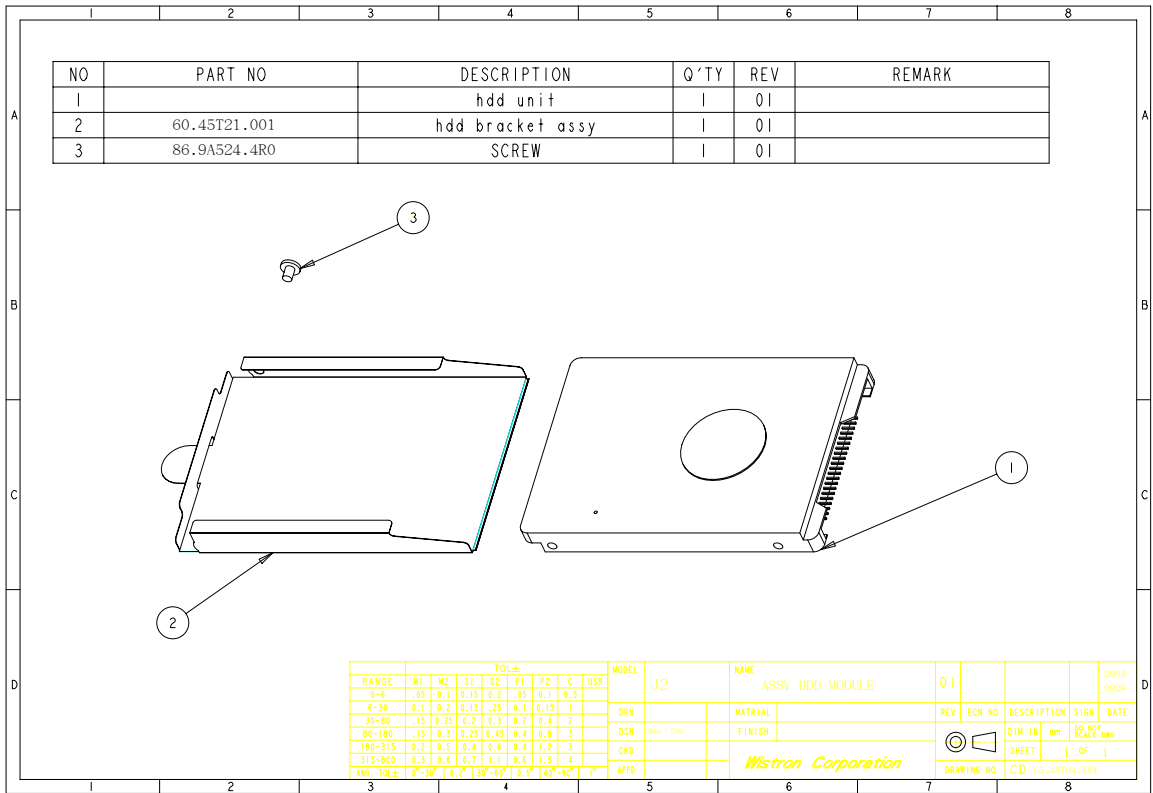



HDD

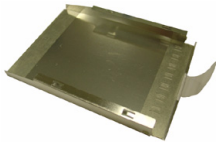

NOTE: Some part numbers appear on the exploded diagram are vendor's part number. Please refer to the FRU list for Acer part number.

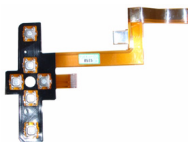
Picture	Partname And Description	Part Number
Main board		
	MAINBOARD TM370-J2 W/ 1.4G CPU W/ CPU HEATSINK & HOLDER & MODEM CABLE & PCMCIA SLOT & RTC BATTERY	MB.T3901.002
Memory		
	IMEMORY DDR333 128MB INFINEON HYS64D16000GDL-6-B MEMORY DDR333 128MB NANYA NT128D64SH4BBGM-6K MEMORY DDR333 256MB INFINEON HYS64D32020GDL-6-B MEMORY DDR333 256MB NANYA NT256D64SH8BAGM-6K MEMORY DDR333 256MB MICRON MT8VDDT3264HDG-335C3 MEMORY DDR333 512MB INFINEON HYS64D64020GBDL-6-B MEMORY DDR333 512MB ELPIDA EBD52UC8AARA-6B	KN.12802.006 KN.12803.008 KN.25602.009 KN.25603.009 KN.25604.009 KN.51202.007 KN.51209.002
LCD		
	LCD 12.1" TFT XGA IDT IAXG01W	LK.1210B.003
	INVERTER BOARD SUMIDA TWS-458-018	19.T39V1.001
	HINGE PACK 12.1" LEFT/RIGHT	6K.T39V1.001
	LCD PANEL W/HINGE SUPPORT & LOGO	60.T39V1.005
	LCD BEZEL 12.1" W/ICON LABEL	60.T39V1.004

Picture	Partname And Description	Part Number
	LCD FPC CABLE ASSEMBLY W/TUBE	50.T39V1.005
HDD/ Hard Disk Drive		
	30GB 2.5 IN. 4200RPM HGST MORAGA IC25N030ATMR04-0 60GB 2.5 IN. 4200RPM HGST MORAGA IC25N060ATMR04-0 08K0634 20GB 2.5 IN. 4200RPM HGST MORAGA IC25N020ATMR04-0 08K0632 40GB 2.5 IN. 4200RPM HGST MORAGA IC25N040ATMR04-0 08K0633 80GB 2.5 IN. 4200RPM HGST MORAGA IC25N080ATMR04-0 08K0635 30GB/2.5 IN. 4200RPM/TOSHIBA NEPTUNE MK3021GAS 40GB/2.5 IN. 4200RPM/TOSHIBA NEPTUNE MK4021GAS 60GB/2.5 IN. 4200RPM/TOSHIBA NEPTUNE MK6021GAS	KH.03007.002 KH.06007.002 KH.02007.002 KH.04007.004 KH.08007.002 KH.33004.001 KH.34004.001 KH.36004.001
	HDD COVER	42.T39V1.005
	HDD HOLDER	33.T39V1.001
Optical Drive/Combo Drive		
	CDRW/DVD COMBO MODULE 24X 1394 AOPEN ESV-189I/6P DVD-ROM MODULE 8X 1394 AOPEN ESV-178I/6P	KO.0240E.001 KV.00802.004
Cables		
	POWER CORD 10A 125V US	27.T30V1.001
	TOUCHPAD CABLE	50.T39V1.001
	MODEM CABLE	50.T39V1.006
Antenna		

Picture	Partname And Description	Part Number
	WIRELESS ANTENNA LEFT BLACK WIRELESS ANTENNA RIGHT GRAY	50.T39V1.003 50.T39V1.004
Boards		
	WIRELESS LAN BOARD 802.11B INTEL CALEXICO WM3B2100	KI.CAX01.002
	MODEM BOARD AMBIT T60M283.10	54.09011.542
	TOUCHPAD SYNAPTICS TM41P-341	56.T39V1.001
PCMCIA slot/PC card slot		
	PCMCIA SLOT	22.T39V1.001
Adapter		
	ADAPTER 65W 19V 3PIN LITEON PA-1650-02CR	AP.T3503.001
Battery		
	BATTERY 6CELL 2200MAH LI-ION SIMPLO BTT-73E1 RTC BATTERY 3V 210MAH	BT.T3907.002 23.T39V1.001
Case/Cover/Bracket Assembly		
	DIMM COVER	42.T39V1.006

Picture	Partname And Description	Part Number
	LOWER CASE W/DIMM COVER & FAN & MICROPHONE & RUBBER FOOT	60.T39V1.002
	UPPER CASE W/O TOUCHPAD MODULE W/COVER SWITCH CABLE & SPEAKER	60.T39V1.003
	HINGE CAP RIGHT	42.T39V1.001
	HINGE CAP LEFT	42.T39V1.002
Speaker		
	SPEAKER	23.T39V1.004
Keyboard		
	KEYBOARD 84KEYS CHINESE DARFON NSK-A9602 KEYBOARD 84KEY US-INTERNATIONAL DARFON NSK-A961D KEYBOARD THAI DARFON NSK-A9603	KB.T3907.001 KB.T3907.002 KB.T3907.003
Heatsink		
	THERMAL PLATE	34.T39V1.001
Rubber		
	LCD SCREW RUBBER	47.T39V1.003
	RUBBER FOOT FRONT	47.T39V1.001
	RUBBER FOOT	47.T39V1.002
Screws		

Picture	Partname And Description	Part Number
	SCR. HEX NUT W/WASHER&NYLOK #4	34.00015.221
	SCRW MACH WAFER M2*L4 NI NYLOK	86.T39V1.001
	SCREW MACH WAFER M2*L4 NI	86.T39V1.002
	SCRW MAC FLAT M2*L4 NI NYL-GRN	86.T39V1.003
	SCREW MAC FLAT M2L4.5NI NYL-BL	86.T39V1.004
	SCREW M2*3 NYLON 1JMCPC-420325	86.9A352.3R0
	SCREW	86.9A352.4R0
	SCREW M2.5*4L(NYLOCK)BLACK ZN	86.9A353.4R0
	SCREW M3x4(86.9A524.4R0)	86.9A524.4R0
	SCREW NYLOK M2.5-5	86.9A553.5R0
	SCREW M2.5X6	86.9A353.6R0

Model Definition and Configuration

TravelMate 370 series

Model Number	CPU	LCD	ODD	Memory	HDD	Battery	Wireless LAN	Card Reader
371Ti	Intel Pentium M 1.4G	12.1" XGA	N/A	256M	30G/ 40G	4-cell Li-Ion/ 6-cell Li-Ion	802.11b	3-in-1
371TCi	Intel Pentium M 1.4G	12.1" XGA	IEEE 1394 DVD-CDRW	256M/ 2*256M	40G/ 60G	4-cell Li-Ion/ 6-cell Li-Ion	802.11b	3-in1

Test Compatible Components

This computer's compatibility is tested and verified by Acer's internal testing department. All of its system functions are tested under Windows XP Home environment.

Refer to the following lists for components, adapter cards, and peripherals which have passed these tests. Regarding configuration, combination and test procedures, please refer to the TravelMate 370 Compatibility Test Report released by the Acer Mobile System Testing Department.

Microsoft Windows XP (Home) Environment Test

Item	Specifications
PCMCIA/PC Card	3Com EtherLink III IBM EtherJet CardBus Adapter 10/100 Intel EtherExpress Pro/100 Mobile Adapter 3Com Megahertz 56K Modem PC Card Xircom CreditCard Modem 56 IBM 56K Double Jack Modem 3Com Megahertz 10/100 LAN + 56K Modem PC Card Xircom RealPort CardBus Ethernet 10/100 + Modem 56 IBM Microdrive 340MB IBM Microdrive 1G Iomega Click! 40MB Sandisk Flash Card 20MB IBM Community Bluetooth PC Card Toshiba Bluetooth PC Card IBM Token Ring 16/4 Adapter II
USB Device	Chicony USB Keyboard Microsoft Natural Keyboard Pro Acer Aspire USB Mouse Logicool USB Mouse Logitech Coreless MouseMan Wheel USB interface Logitech USB Wheel Mouse Microsoft IntelliMouse Optical USB interface Epson Stylus Color 740 USB interface HP DeskJet 880C USB interface Canon CanonScan D1250 (usb 2.0)(JP OS only) HP ScanJet 3300C Color Scanner JS USB Digital Speaker Panasonic USB Speaker EAB-MPC57USB Aiwa Multimedia Digital Speaker Intel Easy PC Camera Logitech QuickCam Express Internet Logitech QuickCam Home PC Video Camera Orange Micro Usb 2.0 Web Cam Logitec CDRW + DVDROM combo USB interface Iomega USB Zip 250MB IBM 32MB USB Memory Key Apacer USB Handy Drive 32MB Apacer USB Handy Driver 256MB Belkin 4 Port USB Hub Eizo I Station USB Hub Elecom USB Hub 4 Port Sanwa USB Hub 4 Port 4 Port Hub (usb 2.0)
Printer (using Infrared)	HP LaserJet 6MP use IR HP LaserJet 2200 use IR
IEEE 1394 ODD	Sony 830 Sony DW-U50A Mitsumi SR244W1 Matsushita SR-8177

Item	Specifications
CRT/Projector Display	Acer 211c 21" ViewSonic PF790 19" Acer FP751 17" TFT LCD IBM Color TFT LCD 14" Compaq Color Monitor V70 ?" NET Color Monitor 20" Mozo 17" TFT LCD NEC MultiSync MT-1040
Wireless LAN Card	Hitachi DC-CN3300 (802.11b) Lucent RG-1000 (802.11b) Lucent WavePoint-II (802.11b) Cisco Aironet 350 (802.11b) Orinoco AP-500 (802.11b) Intel Dual Pro/Wireless 5000 (802.11a+b) Intel Pro/Wireless 5000 (802.11a) Linksys Dual-Band Wireless AP (802.11a+g)
Memory Card	Sony Memory Stick 64MB Transcedn SD Card 32MB Apacer SD Flash Card 64MB Apacer SD Flash Card 128MB

Online Support Information

This section describes online technical support services available to help you repair your Acer Systems.

If you are a distributor, dealer, ASP or TPM, please refer your technical queries to your local Acer branch office. Acer Branch Offices and Regional Business Units may access our website. However some information sources will require a user i.d. and password. These can be obtained directly from Acer CSD Taiwan.

Acer's Website offers you convenient and valuable support resources whenever you need them.

In the Technical Information section you can download information on all of Acer's Notebook, Desktop and Server models including:

- Service guides for all models
- User's manuals
- Training materials
- Bios updates
- Software utilities
- Spare parts lists
- TABs (Technical Announcement Bulletin)

For these purposes, we have included an Acrobat File to facilitate the problem-free downloading of our technical material.

Also contained on this website are:

- Detailed information on Acer's International Traveler's Warranty (ITW)
- An overview of all the support services we offer, accompanied by a list of telephone, fax and email contacts for all your technical queries.

We are always looking for ways to optimize and improve our services, so if you have any suggestions or comments, please do not hesitate to communicate these to us.

Free Manuals Download Website

<http://myh66.com>

<http://usermanuals.us>

<http://www.somanuals.com>

<http://www.4manuals.cc>

<http://www.manual-lib.com>

<http://www.404manual.com>

<http://www.luxmanual.com>

<http://aubethermostatmanual.com>

Golf course search by state

<http://golfingnear.com>

Email search by domain

<http://emailbydomain.com>

Auto manuals search

<http://auto.somanuals.com>

TV manuals search

<http://tv.somanuals.com>