

Acer WT 300

User's Guide

Copyright 1999 Acer Incorporated
All Rights Reserved. Printed in Taiwan

Acer WT 300 User's Guide
Part No.: 49.32B01.001
Draft Version: July, 1999

Changes may be made periodically to the information in this publication without obligation to notify any person of such revision or changes. Such changes will be incorporated in new editions of this manual or supplementary documents and publications. This company makes no representations or warranties, either expressed or implied, with respect to the contents hereof and specifically disclaims the implied warranties of merchantability or fitness for a particular purpose.

Record the model number, serial number, purchase date, and place of purchase information in the space provided below. The serial number and model number are recorded on the label affixed to your computer. All correspondence concerning your unit should include the serial number, model number, and purchase information.

No part of this publication may be reproduced, stored in a retrieval system, or transmitted, in any form or by any means, electronic, mechanical, photocopy, recording, or otherwise, without the prior written permission of Acer Incorporated.

Acer WT 300 User's Guide

Model Number : _____

Serial Number : _____

Purchase Date : _____

Place of Purchase : _____

All trademarks, registered trademarks and/or service marks are the properties of their respective owners.

Notices

FCC Notice

This device has been tested and found to comply with the limits for a Class B digital device pursuant to Part 15 of the FCC Rules. These limits are designed to provide reasonable protection against harmful interference in a residential installation. This device generates, uses, and can radiate radio frequency energy and, if not installed and used in accordance with the instructions, may cause harmful interference to radio communications.

However, there is no guarantee that interference will not occur in a particular installation. If this device does cause harmful interference to radio or television reception, which can be determined by turning the device off and on, the user is encouraged to try to correct the interference by one or more of the following measures:

- Reorient or relocate the receiving antenna
- Increase the separation between the device and receiver
- Connect the device into an outlet on a circuit different from that to which the receiver is connected
- Consult the dealer or an experienced radio/television technician for help

Notice: Shield Cables

All connections to other computing devices must be made using shielded cables to maintain compliance with FCC regulations.

Notice: Peripheral Devices

Only peripherals (input/output devices, terminals, printers, etc.) certified to comply with the Class B limits may be attached to this equipment. Operation with non certified peripherals is likely to result in interference to radio and TV reception.

Caution

Changes or modifications not expressly approved by the manufacturer could void the user's authority, which is granted by the Federal Communications Commission, to operate this computer.

Use Conditions

This part complies with Part 15 of the FCC Rules. Operation is subject to the following two conditions: (1) this device may not cause harmful interference, and (2) this device must accept any interference received, including interference that may cause undesired operation.

Notice: Canadian Users

This Class B digital apparatus meets all requirements of the Canadian Interference-Causing Equipment Regulations.

Remarque à l'intention des utilisateurs canadiens

Cet appareil numérique de la classe B respecte toutes les exigences du Règlement sur le matériel brouilleur du Canada.

Important Safety Instructions

Read these instructions carefully. Save these instructions for future reference.

- 1.** Follow all warnings and instructions marked on the product.
- 2.** Unplug this product from the wall outlet before cleaning. Do not use liquid cleaners or aerosol cleaners. Use a damp cloth for cleaning.
- 3.** Do not use this product near water.
- 4.** Do not place this product on an unstable cart, stand, or table. The product may fall, causing serious damage to the product.
- 5.** Slots and openings in the cabinet and the back or bottom are provided for ventilation; to ensure reliable operation of the product and to protect it from overheating, these openings must not be blocked or covered. The openings should never be blocked by placing the product on a bed, sofa, rug, or other similar surface. This product should never be placed near or over a radiator or heat register, or in a built-in installation unless proper ventilation is provided.
- 6.** This product should be operated from the type of power indicated on the marking label. If you are not sure of the type of power available, consult your dealer or local power company.
- 7.** Do not allow anything to rest on the power cord. Do not locate this product where persons will walk on the cord.
- 8.** If an extension cord is used with this product, make sure that the total ampere rating of the equipment plugged into the extension

cord does not exceed the extension cord ampere rating. Also, make sure that the total rating of all products plugged into the wall outlet does not exceed the fuse rating.

- 9.** Never push objects of any kind into this product through cabinet slots as they may touch dangerous voltage points or short out parts that could result in a fire or electric shock. Never spill liquid of any kind on the product.
- 10.** Do not attempt to service this product yourself, as opening or removing covers may expose you to dangerous voltage points or other risks. Refer all servicing to qualified service personnel.
- 11.** Unplug this product from the wall outlet and refer servicing to qualified service personnel under the following conditions:
 - a.** When the power cord or plug is damaged or frayed
 - b.** If liquid has been spilled into the product
 - c.** If the product has been exposed to rain or water
 - d.** If the product does not operate normally when the operating instructions are followed. Adjust only those controls that are covered by the operating instructions since improper adjustment of other controls may result in damage and will often require extensive work by a qualified technician to restore the product to normal condition.
 - e.** If the product has been dropped or the cabinet has been damaged
 - f.** If the product exhibits a distinct change in performance, indicating a need for service.
- 12.** Use only the proper type of power supply cord set (provided in your accessories box) for this unit. It should be a detachable type: UL listed/CSA certified, type SPT-2, rated 10A 250V minimum, VDE approved or its equivalent. Maximum length is 15 feet (4.6 meters).

Year 2000 Compliance Statement

This product is Year 2000-compliant and carries the “NSTL Hardware Tested Year 2000 Compliant” logo. This product has been tested both by Acer’s internal test labs and NSTL using NSTL’s YMARK2000 certification test. These tests certify that this product will successfully make the year 2000 transition.



For more details, check the Acer Year 2000 Resource Center at <http://www.acer.com.tw/service/y2k/>

Table of Contents

Chapter 1 Getting Started	1
Introduction	2
Overview	2
Preinstallation	3
Selecting a Site	3
Unpacking Components	3
Features	4
Front Panel	4
Rear Panel	5
Connecting System Components	7
Connecting the Keyboard	7
Connecting the Monitor	8
Connecting the Mouse	8
Connecting the Printer	9
Connecting to the Network	10
Connecting the Power Adapter	10
Connecting the Speaker	11
Using the Base Holder	12
Turning On Your System	13
Turning Off Your System	14
Setup	15
Setup Wizard	15
Terminal Connection Manager	21
Microsoft Remote Desktop Client	22
Citrix ICA Client	25
Ericom Power Term Terminal Emulator (Optional)	31
Multiple Sessions	32
Terminal Properties	33
Chapter 2 Hardware Specifications	39
Major Components	40
Memory	40
VGA Controller	41
Serial Port	41
Parallel Port	41
Software Specification	42
Bootloader	42
Operating System	42

Drivers.....	42
Application.....	43
Troubleshooting Your Terminal.....	44

Getting Started

Chapter 1

Introduction

Acer has been on the leading edge of microcomputer systems development for both corporate and home computing needs for 20 years, as the OEM of choice for many of the world's leading computer companies. Acer is committed to meeting the world's demand for state-of-the-art computers at the best prices.

Your Window Based Terminal (WBT) configuration provides flexible feature in a small footprint making it perfect for general business or commercial use.

Overview

The Acer WT 300 system is a combination of one Cyrix MediaGX microprocessor, a Cyrix's Virtual system architecture enabling XpressGRAPHICS and XpressAUDIO, an Ethernet Controller (AMD 79C973), one PCI connector for upgrading to TYPE II PCMCIA daughter card, and one DIMM socket (which supports up to 256 MB RAM). The Acer WT 300 system is based on Intel® x86 architecture with audio capability and 100 BaseT support.

The Acer WT 300 system is one of Acer's Window Based Terminal numerous product line. It's advantages are high performance, low TCO (Total Cost of Ownership), low administration cost, good security and seamless integration into networking environment.

Preinstallation

The preinstallation process involves the following activities:

- Selecting a site
- Unpacking components

Selecting a Site

Consider the following when selecting a site for your computer:

- Determine the best site for your system. Cable paths should not run near equipment that might cause electromagnetic or radio frequency interference such as radio transmitters, television sets, copy machines, or heating and air conditioning equipment.
- Route cables away from personnel and equipment traffic.
- Avoid dusty areas and extremes of temperature and humidity.

Unpacking Components

Unpack the contents of each box carefully. Save all packing materials in case you need to move or ship the system in the future.

Check that all items are present and in good condition. Contact your dealer immediately if anything is missing or damaged.

Features

The basic configuration consists of a system unit, a base holder, power adapter and it may also come with an optional SmartCard.

Front Panel

The figure below shows the system unit front panel.

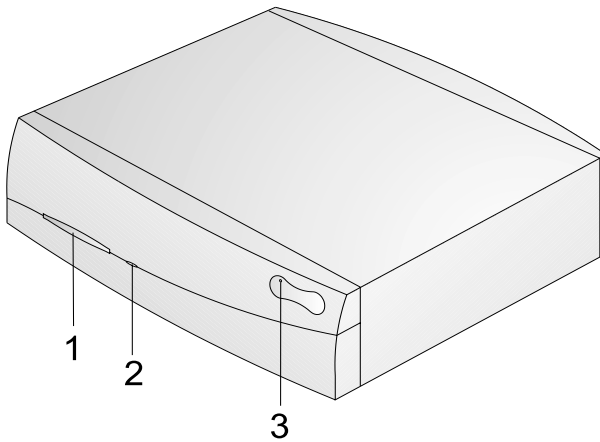

#	Description
1	SmartCard slot
2	Power indicator
3	Manufacturer's logo

Rear Panel

The figure shows the system unit rear panel.

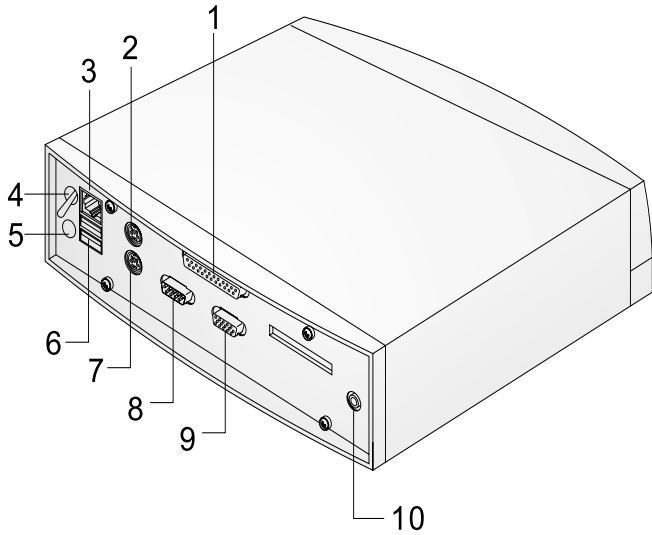

#	Description
1	Paralle/Printer connector
2	Mouse connector
3	Ethernet connector
4	Main power switch
5	Power adapter jack

#	Description
6	USB ports
7	Keyboard connector
8	Serial connector
9	Monitor/VGA connector
10	Line-out/Speaker port



.....
Note : As of now, Windows CE does not support the USB port, it will be available in the future.

Connecting System Components

Do not turn on the power until you finish connecting the system components.

The following sections show how to connect each component to the system.

Connecting the Keyboard

Plug the keyboard cable into the keyboard connector on the rear panel. See the figure below.

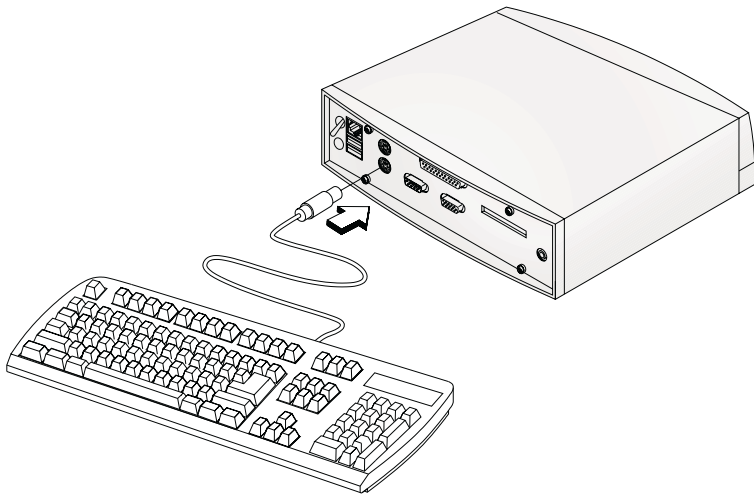

Connecting the Monitor

Plug the monitor signal cable into the VGA connector on the rear panel.

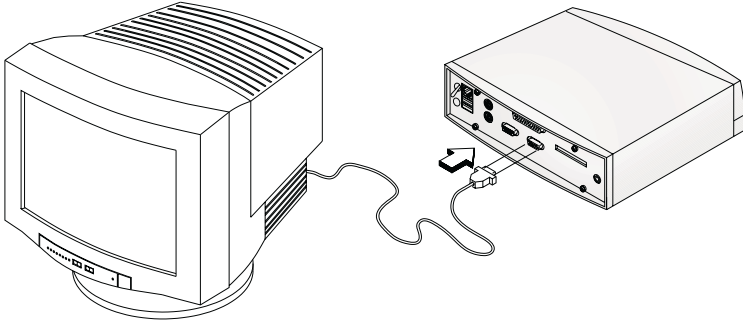

Connecting the Mouse

Plug the mouse cable into the mouse connector on the rear panel.

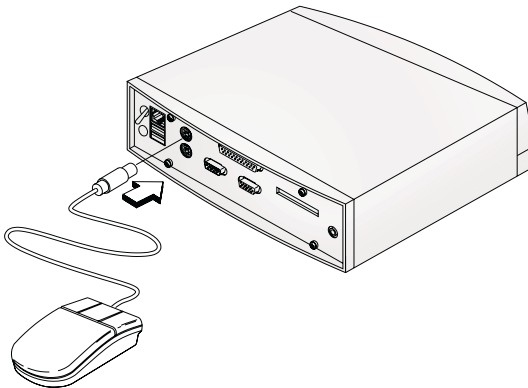

Connecting the Printer

If you have a parallel printer, connect it to the parallel connector on the rear panel. See figure below.

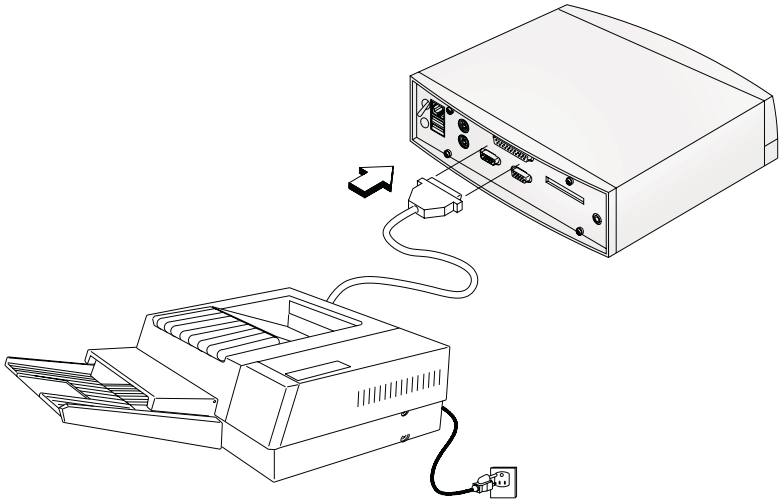

Connecting to the Network

Plug into the network via the Ethernet connector to the hub. See figure below.

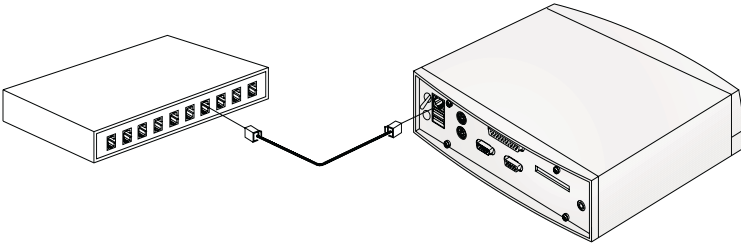

Connecting the Power Adapter

Plug one end of the power adapter to the power adapter jack, and then one end to the power cord, then plug the other end of the power cord into the wall outlet.

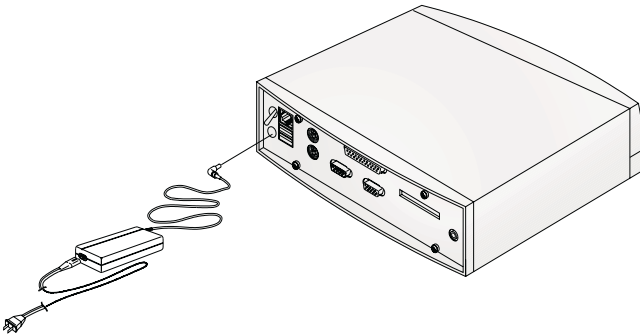

Connecting the Speaker

The figure below shows the connection of the speaker to the system.

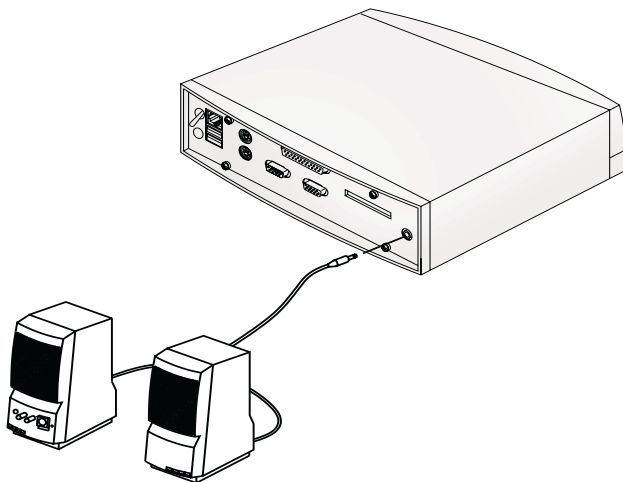

Using the Base Holder

Your system also includes a base holder to save precious table space. See figure below for the assembly.

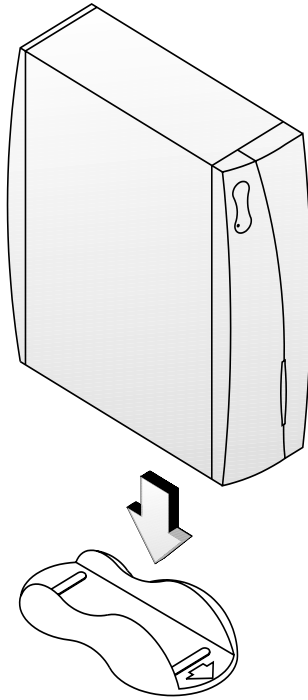

Turning On Your System

After you have connected all peripherals and cables, follow these steps to turn on your computer:

1. Turn on all peripherals connected to the system such as monitor, printer, etc.
2. Turn on the main power switch located at the back of the system.



Note: If your system needs a SmartCard to power on, then insert the SmartCard into the slot in front of the system. See your SmartCard manual for more detail.



Caution: The SmartCard should be inserted correctly, the circuit chip should be facing down and in front as shown below, for the system to power up properly. See your SmartCard manual for more detail.

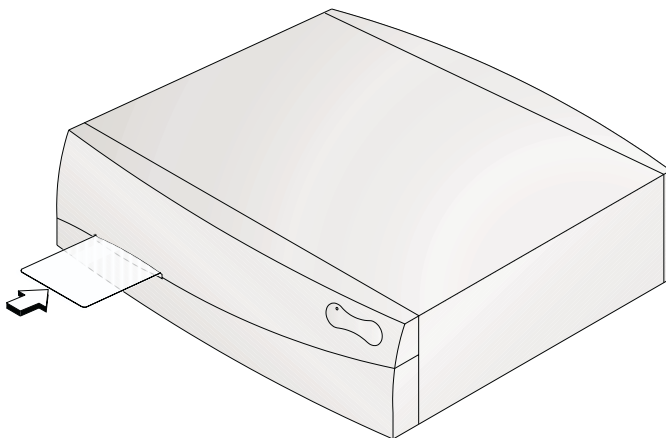

3. After inserting the SmartCard, the system will boot up and the Acer logon screen will be displayed.

Turning Off Your System

1. Log off from the server and then turn off the power of the system.
2. Turn off all peripherals connected to the system such as the monitor, printer, etc.
3. Turn off the main power switch and unplug the system if you are going to do any of the following
 - not use the system for a long period of time
 - install system component(s)



.....
Note: *If your system is equipped with a SmartCard, remove the SmartCard first before turning off the system.*



.....
Warning! *Installing components without unplugging the system may result in serious damage both to the system and the component. Unplugging the system ensures that there is no standby current on the system board. Not doing so may damage your system.*

Setup

The setup refers to the Setup Wizard and the Terminal Properties. The Setup Wizard is used when the Acer WT 300 is installed for the first time. The Terminal Properties is used after the Setup Wizard is set.

Setup Wizard

The Setup Wizard lets you set terminal network configuration and terminal display parameters. Any future changes can be made using the Terminal Properties dialog box. You can launch this dialog box anywhere in the program at any time by pressing the [F2] key, see Terminal Properties on page 33.

There are several dialog boxes that display in succession during the process. Each dialog box is self-explanatory. Some dialog boxes are informational and require no user input. Other dialog boxes will prompt you for network and display information.

Click on the “Next” or “Accept” buttons to display the next dialog box in the sequence. Click on the Back command button to return to the previous dialog box. Click on Cancel to quit and display the Terminal Connections Manager. Following are the dialog boxes of the Setup Wizard.



Press next to go to the next screen.



Read the end user's license agreement carefully, press "Accept" to go to the next screen.

If you choose the “Yes, use the IP information supplied by DHCP” you will go directly to the dialog box where you provide the IP information.

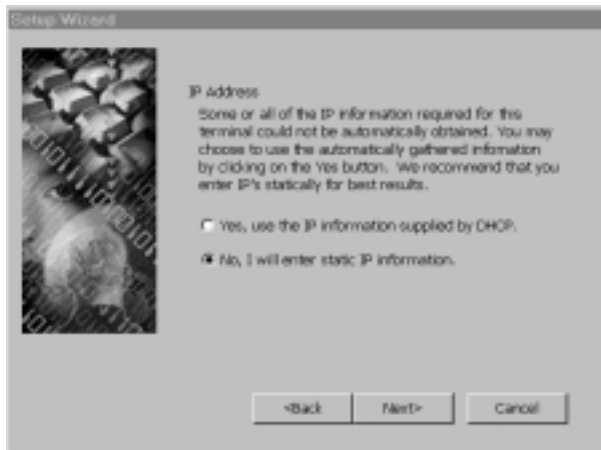

Choosing the “No, I will enter status IP information” option, press next and you will be asked to supply IP address, Subnet Mask and Gateway. If you do not know the information, you can ask your network administrator for the necessary information.

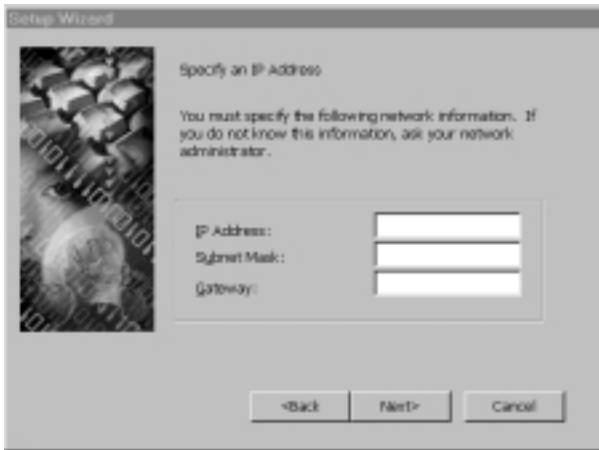

After supplying the necessary information, press “Next”, and you will have to supply additional information as shown below.

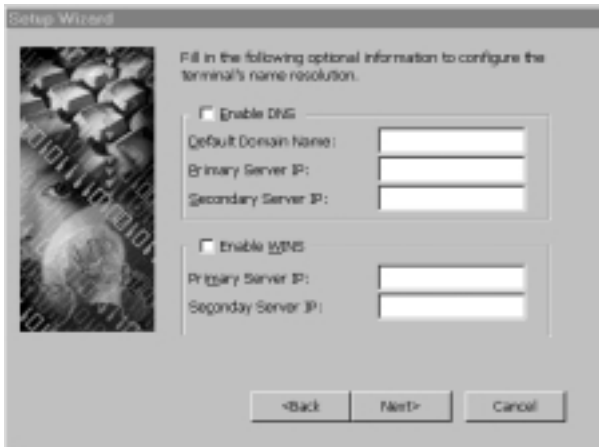

When the necessary information is supplied, choose “Next” to set your video display resolution. The screen below shows the current setting of the video display resolution.

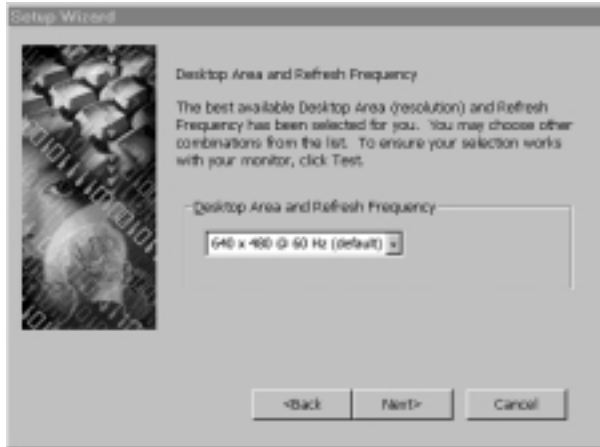

Note: Make sure the resolution you select is supported by your monitor, otherwise your monitor will only display a blank screen.

After choosing your video display resolution, choose next and click on “Finish” to finish the setup. A dialog box will be displayed asking you if you want to keep the selection. Choose “OK” to keep the selection or “Cancel” to pick another one.

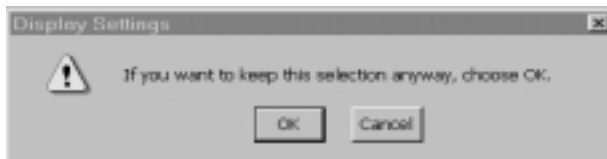

If you choose “OK” the following screen will be displayed saying that you have successfully completed the Setup Wizard. Click “Finish” to apply the settings that you have chosen.

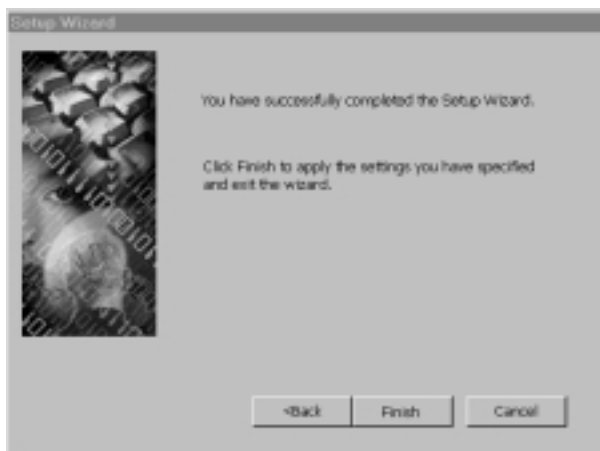

After clicking the “Finish”, you will be asked to restart the system in order for the settings to take effect. Click on “Yes” to restart the system, otherwise, click “No”.

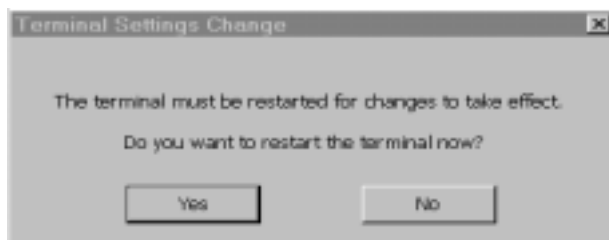

Terminal Connection Manager

Terminal Connection Manager dialog box is designed to help you manage your terminal's network connections. The dialog box displays after you are finish with the Setup Wizard. This is the screen that is displayed everytime you start your terminal and want to log onto a server. It can support up to seven different server connections. This section guide you through the steps on some of the features of the Terminal Connection Manager.

1. The Connection and the Configure are the two main options in the Terminal Connection Manager.

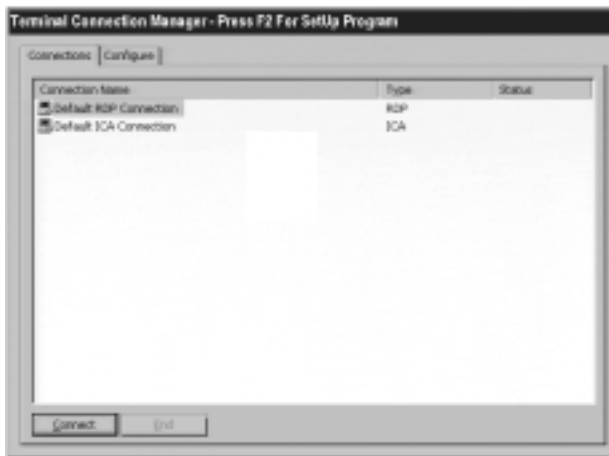

2. In order to connect to a server for the very first time, you should go the the “Configure” option. Click on the “Configure” option and click on “Add”.

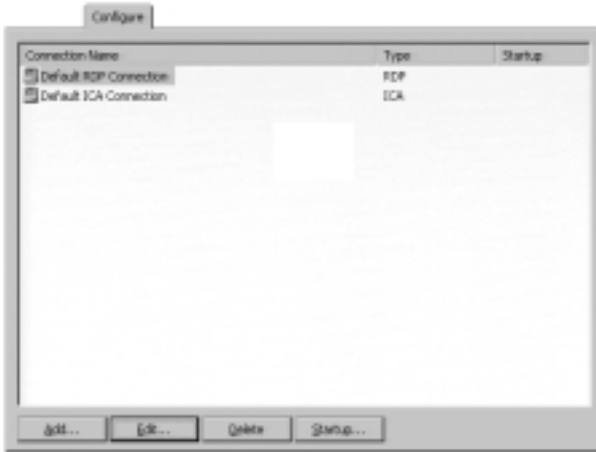

3. On the “New Connection” dialog box, you can choose a “Citrix ICA Client”, “Ericom Power Term Terminal Emulator” or “Microsoft Remote Desktop Client” type of connection to create.



.....

Note: “Citrix ICA Client” and “Microsoft Remote Desktop Client” is a Windows NT based type of operating system, while “Ericom Power Term Terminal Emulator” is a Unix system.

Microsoft Remote Desktop Client

To create a new “Microsoft Remote Desktop Client”, use the WTS Connection Wizard. Make selections and enter data in each dialog box. Click on the Next command button to move to the next dialog box. When you are finished, the new connection will

be added to the Connection Name list in the Terminal Connection Manager.

Use the Back command button to go to the previous dialog box. Click on the Cancel command button to quit this dialog box at any time.

The following figures show the sequence of the WTS Connection Wizard.



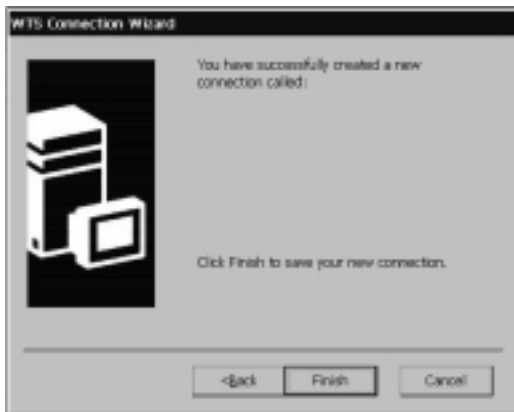

After you are finished with the configuration, you can get connected to a server by going to the connection option and double-clicking on a connection name or you can also highlight a connection name and click on "Connect".

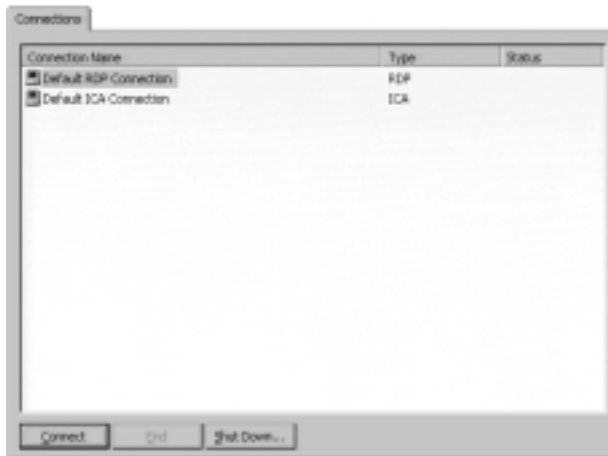

Citrix ICA Client

The following procedure describes how to create a network connection to a Citrix server.

Creating a Network Connection

1. In the Connection Manager dialog box click the Configure tab and then click "Add".
2. In the New Connection dialog box, click Citrix ICA Client in the type of connection list. Click "OK".
3. In the Specify Connection Type dialog box, click "Network Connection". Make sure your client device is connected to the network through a NIC or by a serial PPP connection to a Windows 95 or Windows NT RAS server. Click "Next" to continue.



4. The Select a Citrix Server or Published Application screen will appear and If your Windows CE device is not on the same network as the Citrix server you want to connect to (for example, if you are on the other side of a router, across the Internet, or using RAS to connect to a remote network containing Citrix servers), the server and published application list will not contain that server. In this case, click “Server Location” and go to Step 5. Otherwise, scroll through the list and select the Citrix server or published application or type the name of the Citrix server or published application in the edit field. Click “Next” to continue, and go to Step 6.



5. In the Server Location screen, the ICA Windows CE Client uses the information entered in the Server Location dialog to help locate available Citrix servers and published applications. The default value entered in the Address field is Auto-Locate. To use Auto-Locate, your Windows CE device and the Citrix server you want to connect to must be on the same local network. If you are on another network (for example, if you are on the other side of a router, across the Internet, or connected by RAS) you must enter the IP address or DNS name of a Citrix server on the network that contains the Citrix server you want to connect to. Click “Add” and enter the IP address or DNS name of any Citrix

server on the remote network. Click “OK”. The Select a Citrix Server or Published Application screen reappears. Scroll through the list and select the name of the Citrix server or published application you want to connect to. Click “Next” to continue.



6. The Specify an Application screen will appear and in the Command Line field, enter the path and name of an application to run on the server once the logon to the Citrix server is successful. Leave this field blank to run a Windows NT desktop on the Citrix server. Working Directory lets you associate a directory with the application specified in the Command Line field. Enter the drive and path of the working directory in the Working Directory field. For example, if the application Notepad.exe is in the C:\WTSRV directory on the Citrix server, type C:\WTSRV\notepad.exe in the Command Line field. If you use Notepad to work on documents in the C:\My Documents directory, type C:\My Documents in the Working Directory field. When you log on to the Citrix server, Notepad begins. In Notepad, if you click the File menu, the directory C:\My Documents is displayed. Click “Next” to continue.



7. In the Specify Logon Information screen, type a valid username, domain, and password. If you leave these fields blank, you are prompted for your username, domain, and

password when the ICA Windows CE Client connects to the Citrix server. Click “Next” to continue.



8. In the Select Window Option screen, select 16 or 256 colors from the Window Colors field. Click “Next” to continue.



9. In the Compression, Cache, and Sound screen, click Compress Data Stream to reduce the amount of data transferred between the ICA Windows CE Client and the Citrix server hosting the session. (If your connection is bandwidth-limited, enabling compression may increase performance. If your client device is on a high-speed LAN, you may not need compression.) The Cache feature is not supported in this release. Click “Enable Sound” to enable sound support. Remote applications will be able to play sounds on your client. From the pull-down list, select a sound presentation quality level. High provides the greatest audio quality but should only be used when bandwidth consumption is not a concern. Medium results in less bandwidth consumption than when using High. Compression of sound data provides greater bandwidth efficiency but reduces sound quality somewhat. This value is recommended for most LAN-based connections. Low offers the most efficient use of bandwidth but also decreases sound quality severely. This value is

recommended for low-bandwidth connections, including most modem connections. Click “Next” to continue.



10. By default, the Citrix server or published application name appears in the edit field. You can accept this name or enter another. The name you choose will be the name of the entry in the Current Client Connections list and will appear in the title bar of the ICA session window. Click Finish. Click OK to the confirmation message.



Creating a Dial-In Connection

1. In the Connection Manager dialog box click the Configure tab and then click “Add”.
2. In the New Connection dialog box, click Citrix ICA Client in the type of connection list. Click “OK”.
3. In the Specify Connection Type dialog box, click “Dial-In Connection”. Make sure your client device is connected to the network through a NIC or by a serial PPP connection to

a Windows 95 or Windows NT RAS server. Click "Next" to continue.



4. From the pull-down list in the Dial-In Devices screen, select your modem. In the Area, Phone Number, and Country fields, type the area code, phone number, and country code of the Citrix server. Click Next to continue.



5. From here on follow the Step 6 of the "Network Connection" on page 27.

Connecting to a Citrix Server.

1. In the Connection Manager dialog box.
2. Click the Connections tab.
3. Select the desired connection description and click Connect. If the remote application entry contains a valid user name and password, the ICA Client logs in as that user name. If no user name and password are present in the entry, the server logon dialog box appears. Enter a valid user name and password for the Citrix server and click OK to begin the session.

Ericom Power Term Terminal Emulator (Optional)

1. Select “Ericom Power Term Terminal Emulator” and click on “OK” to go to the next dialog box.
2. On this dialog box, you will be asked to supply some information in order to connect to the server. Click on “OK” to add that to the Terminal Connection Manager’s Connection Name.



Multiple Sessions

To start a multiple sessions:

- 1.** From one of the active session:
 - a.** Press “Ctrl+Alt+End” (“End” key on the editing keypad) to call up the Terminal Connection Manager.
 - b.** Click on another connection to connect and start another session.
- 2.** From the Terminal Connection Manager:
 - a.** Click on another connection to connect and start another session.

To toggle between sessions:

- Press “Ctrl+Alt+ ▼ “ (arrow down) to proceed to the next session.
- Press “Ctrl+Alt+ ▲ “ (arrow up) to proceed to the previous session.

Terminal Properties

Terminal Properties is used to change the setting of the terminal. This sections guide you through the steps on some of the features of Terminal Properties.

1. Everytime you press the F2 function key, the following screen will be displayed:

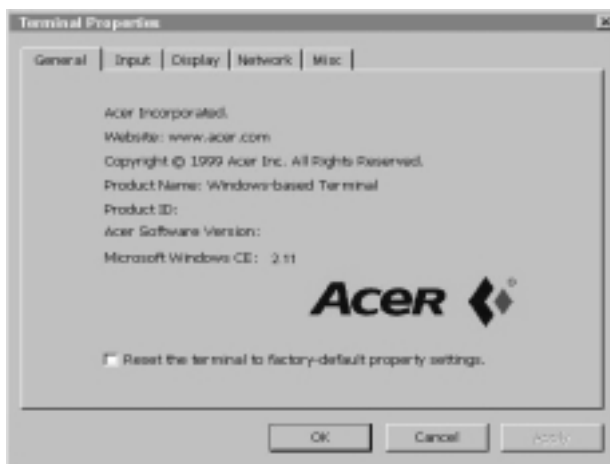

- a. You can either click on okay to start your system or you can pick one of the options on top of the dialog box.
2. Click on the "Input" option to choose the input devices for your system. The following screen shows the information of the input devices that you can set.

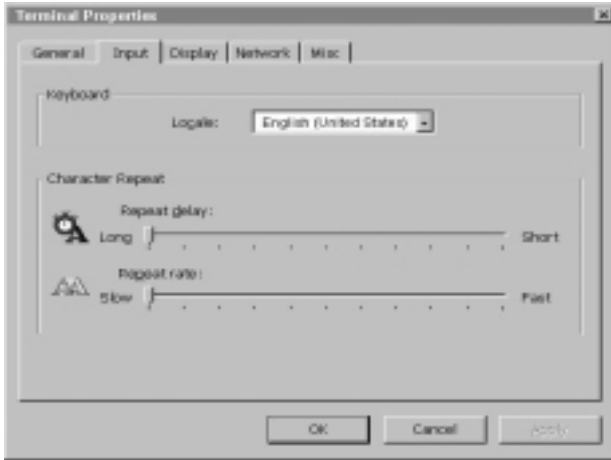

3. You can also choose the display option to set the video display resolution and to enable the screen saver.

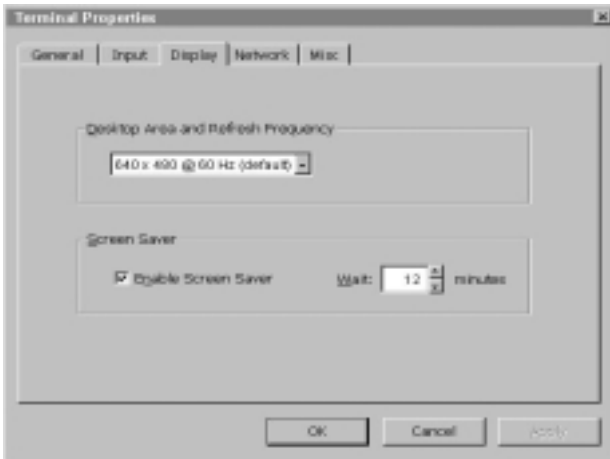

Note: Make sure the resolution you select is supported by your monitor, otherwise your monitor will only display a blank screen.

4. Click on the “Network” option to specify another network settings. You can choose to “Obtain an IP address from a DHCP server” or “Specify an IP address”. The following screen shows the informations that needs to be supplied by the users.

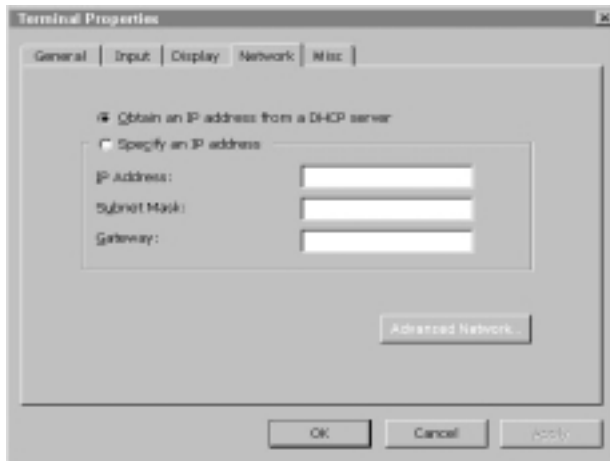

5. Choosing the “Specify an IP address” will require you to supply the IP address, Subnet Mask and Gateway. And you can go to the Advanced option to supply additional information. The following screen shows the Advanced option dialog box.

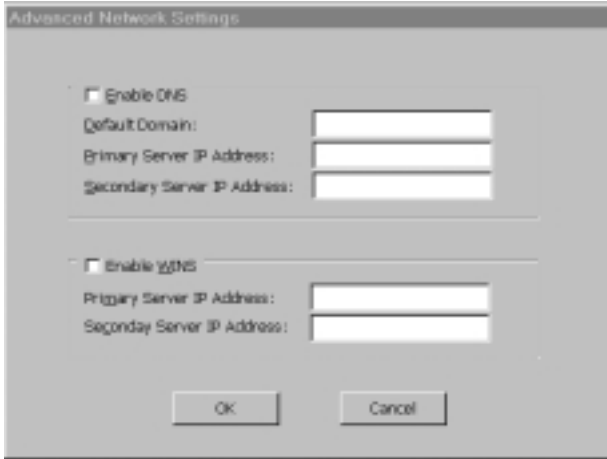

6. Choosing the "Misc" will enables you to put identification on your computer, enable remote upgrade function, control the sound volume and set the global ICA Client Setting.



7. Below are the three screen shots of the Global ICA Client Settings.

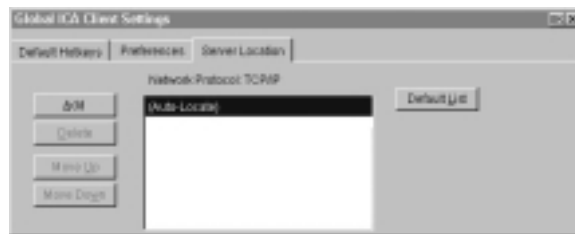

Hardware Specifications

Chapter 2

This chapter describes the hardware specification and all its major components.

Major Components

The system board has the following major components:

- CPU: Cyrix MediaGX LV 200 MHz internal speed
- Up to 256 MB Ram supported
- Ethernet Controller: AMD AM79C973 which supports 100BaseT and 10BaseT
- External connectors
 - PS/2 keyboard and mouse connectors
 - One serial connector
 - One parallel/printer connector
 - One standard VGA port
 - One Ethernet connector
 - One power adapter jack
 - Two USB ports
 - One speaker port

Memory

- Flash
 - Boot Loader data bus : 8-bit
 - Boot Loader type : EEPROM
 - Boot Loader size: 256KB
 - Storage size : 8M DOC
- System Memory
 - Memory data bus : 64-bit

- DIMM type : 100 MHz SDRAM
- Max DIMM module size : 256 MB

VGA Controller

- Built in MediaGX with Virtual system architecture
- VGA memory size is shared with system memory

Resolution	Colors	Frequency
640 x 480	256	60
800 x 600	256	60
1024 x 768	256	60

Serial Port

- One high speed Ns 16c550 compatible UART built-in NS super I/O PC97317
- Onboard 9-pin D type connector

Parallel Port

- Standard Mode/ECP/EPP mode
 - IBM PC/AT and PS/2 compatible bidirectional parallel port
 - Onboard 25-pin D type connector

Software Specification

Bootloader

- Boot ROM - contains basic system initialization code and OS loader for Disk On Chip
- OS and application image stored in Disk On Chip

Operating System

- Client side: Microsoft Windows CE 2.11
 - Microsoft RDP Client
 - Citrix ICA Client
 - Ericom Power Term Terminal Emulator
- Server side: Microsoft Windows NT Server (Terminal Server Edition)
- Citrix Metra Frame Server

Drivers

- SVGA driver MediaGX (2D acceleration enabled)
 - 640 x 480 x 256 at 60, 72, 75 Hz
 - 800 x 600 x 256 at 60, 72, 75 Hz
 - 1024 x 768 x 256 at 60, 72, 75 Hz
 - 1280 x 1024 x 256 at 60, 72, 75 Hz
- PS/2 keyboard and mouse driver
- LAN driver for AMD AM79C972
- Permanent storage driver for Disk On Chip 2000
- SmartCard driver
 - ISO 7816-3 (T=1) Compliant
 - ISO 7816-4 Compliant

- Serial and parallel port driver

Application

- Acer customized logon screen
- Terminal configuration setup program
- Windows Terminal Client

Troubleshooting Your Terminal

The following table lists some possible situations that may arise during the use of your terminal and provides easy answers and solutions. If you still encounter problems which you cannot resolve, please call any authorized dealer or distributor for assistance.

Problem	Solution
When the terminal is turned on, nothing happens.	<p>Check the power cord. It should be plugged into an AC outlet and should be properly connected to the AC power connector on the terminal's back panel.</p> <p>If the terminal needs a SmartCard to power-on, make sure that the SmartCard is inserted properly. See "Turning On Your System" on page 13 for more detail.</p>
When the terminal is turned on, the Terminal Connection Manager or the Setup Wizard appears, but the mouse is not working.	<p>Make sure that the mouse is plugged properly into the PS/2 mouse port on the terminal's back panel. See "Connecting the Mouse" on page 8 for more detail.</p>
During the terminal's Power-On Self-Test (POST), a message is displayed: "Keyboard not detected".	<p>Make sure that the keyboard is properly connected to the terminal's PS/2 keyboard port on the terminal's back panel. See "Connecting the Keyboard" on page 7 for more detail.</p>

Problem	Solution
<p>The parallel printer connected to my terminal does not respond when I try to print to it.</p>	<ol style="list-style-type: none">1. Make sure that the printer is plugged into the proper outlet and is turned on.2. Check the cable connection from the printer to the terminal. See "Connecting the Printer" on page 9 for more detail.3. Make sure that the printer is on-line.4. Make sure that the printer is properly configured in the application server's Print Manager, and that the printer has not been paused.
<p>You are not able to make a network connection using the Terminal Connection Manager.</p>	<ol style="list-style-type: none">1. Press the "F2" key to call up the Terminal Properties dialog box. Select the Network tab and verify that the proper method for specifying the IP address is selected, DHCP or static IP. If a static IP address is selected, verify that the IP, the subnet mask, and the gateway IP address are correct for the subnet that the terminal is connected to.2. Make sure that the cable is connected to the network connector on the back panel of the terminal. Check to make sure that the other end of the cable is connected to a hub or other network outlet.3. If DHCP addressing is selected, check with your network administrator to make sure that the DHCP server for your subnet is functioning properly.

Problem	Solution
<p>When a user improperly disconnects from the server, the user is not able to log on to the server again and the sound device does not work properly.</p>	<p>If a user improperly disconnects from the server (i.e., suddenly turns off the power of the terminal without logging off), there will be an un-log off session in the terminal server, which causes the terminal to be unable to log on to the server again, and since it occupies some system resources like the sound device, the sound device will probably not work. When this problem occurs, please ask the administrator to clear the idle session from the server so that you can log on again.</p>

Free Manuals Download Website

<http://myh66.com>

<http://usermanuals.us>

<http://www.somanuals.com>

<http://www.4manuals.cc>

<http://www.manual-lib.com>

<http://www.404manual.com>

<http://www.luxmanual.com>

<http://aubethermostatmanual.com>

Golf course search by state

<http://golfingnear.com>

Email search by domain

<http://emailbydomain.com>

Auto manuals search

<http://auto.somanuals.com>

TV manuals search

<http://tv.somanuals.com>