

# USER'S REFERENCE



**ADAPTEC SCSI CARD 39160**  
**ULTRA160 SCSI CONTROLLER**



Adaptec, Inc.  
691 South Milpitas Boulevard  
Milpitas, CA 95035

© 1999 Adaptec, Inc.  
All rights reserved. Adaptec, and the Adaptec logo  
are trademarks of Adaptec, Inc. which may be  
registered in some jurisdictions.

Printed in Singapore  
STOCK NO.: 512478-03, Rev. A KGL 11/99  
(SRC: 512478-00, Ver. AA)

▼▼▼▼ **Adaptec SCSI Card 39160**  
Ultra160 SCSI Controller

**User's Reference**





# ▼▼▼▼ Contents

## **Overview 1**

Ultra160 SCSI on the Adaptec SCSI Card 39160 1

Understanding SCSI 2

SCSI IDs 3

Terminating the SCSI Bus 4

## **Troubleshooting 5**

Troubleshooting Checklist 5

Troubleshooting in Windows 95/98 6

Common Error Messages 10

## **Using the Adaptec SCSI Card 39160 and SCSI Devices 11**

Using SCSI Devices 11

    Using SCSI Hard Disk Drives 11

    Using Ultra160 Hard Disk Drives 12

    Using Scanners 12

Combining SCSI and Non-SCSI Devices 13

Installing Multiple SCSI Cards 14

Connecting the LED Connector 14

Overriding SCSI Termination Settings 15

## **Configuring the Adaptec SCSI Card 39160 with SCSISelect 16**

Starting SCSISelect 18

    Exiting SCSISelect 18

Using SCSISelect Settings 19

    SCSI Bus Interface Definitions 19

    Boot Device Options 19

    SCSI Device Configuration Options 20

*Adaptec SCSI Card 39160 User's Reference*

Advanced Configuration Options 21

Using SCSI Disk Utilities 24

**Connecting SCSI Devices 25**

Maximum Cable Lengths 26

# Overview

## Ultra160 SCSI on the Adaptec SCSI Card 39160

The Adaptec SCSI Card 39160 enables you to connect up to 30 SCSI devices—such as very large arrays of high-performance HDDs, external storage subsystems, clustered configurations, Ultra160 hard disk drives, scanners, and CD-ROM drives—to any Intel-based computer with 64- or 32-bit PCI expansion slots. Ultra160 is a new generation of SCSI technology that increases SCSI performance from 80 MBytes/sec to 160 MBytes/sec. In addition to providing much greater performance, Ultra160 SCSI enables a maximum allowable cable length of 12 meters for optimal connectivity and flexibility.<sup>1</sup>

The Adaptec SCSI Card 39160 has two independent SCSI channels, each with a maximum throughput of 160 MBytes/sec.

- **SCSI Channel A** (marked “CH 1/A” on the card) has two internal connectors and one external connector.
- **SCSI Channel B** (marked “CH 2/B” on the card) has one internal connector and one external connector.

For the best data I/O performance, connect only LVD (Low Voltage Differential) devices and LVD cables to the Adaptec SCSI Card 39160. (*LVD devices* means Ultra160 and Ultra2 SCSI devices.) If you connect non-LVD devices (for example, Fast SCSI or Ultra SCSI devices), we recommend that you connect them to SCSI Channel A. This allows you to operate Ultra160 and Ultra2 devices at their max-

---

<sup>1</sup> When only one Ultra2 or Ultra160 SCSI device is connected, the cable length can be up to 25 meters (82 feet).

### *Adaptec SCSI Card 39160 User's Reference*

imum speed on Channel B while at the same time using non-LVD SCSI devices on Channel A.

Although the Adaptec SCSI Card 39160 is a 64-bit PCI card, it also works in a 32-bit PCI slot. When installed in a 32-bit PCI slot, the card automatically runs in the slower 32-bit mode.

This *User's Reference* provides information about troubleshooting, SCSI termination, and other important topics. It also explains how to use the built-in *SCSISelect* utility if you need to change the Adaptec SCSI Card 39160 settings.



---

**Note:** Read the *Adaptec SCSI Card 39160 Installation Guide* if you need instructions on installing the SCSI Card and connecting SCSI devices to it.

---

## Understanding SCSI

SCSI (pronounced “scuzzy”) stands for Small Computer Systems Interface. SCSI is an industry standard computer interface for connecting SCSI devices (such as a hard disk drive, CD-ROM drive, or scanner) to a common SCSI bus.

A SCSI bus is an electrical pathway that consists of a SCSI adapter card (such as the Adaptec SCSI Card 39160) installed in a computer and one or more SCSI devices. SCSI cables are used to connect the devices to the SCSI adapter card. The Adaptec SCSI Card 39160 has two independent SCSI buses (channels).

For the SCSI bus to function properly, a unique SCSI ID must be assigned to the SCSI card and each SCSI device connected to it, and the SCSI bus must be properly terminated.



## SCSI IDs

Each device attached to the Adaptec SCSI Card 39160, as well as the Adaptec SCSI Card 39160 itself, must be assigned a unique SCSI ID number from 0 to 15 for each of the two SCSI buses. A SCSI ID uniquely identifies each SCSI device on the SCSI bus and determines priority when two or more devices are trying to use the SCSI bus at the same time.

Refer to the device's documentation to set the SCSI ID. Here are some general guidelines for SCSI IDs:

- For internal SCSI devices, the SCSI ID usually is set by configuring a jumper on the device.
- For external SCSI devices, the SCSI ID usually is set with a switch on the back of the device.
- SCSI ID numbers do not need to be sequential, as long as the Adaptec SCSI Card 39160 and each device has a different number. For example, on each of the two SCSI buses you can have an internal SCSI device with ID 0, and an external SCSI device with ID 6.
- SCSI ID 7 has the highest priority on the SCSI bus. The priority of the remaining IDs, in descending order, is 6 to 0, then 15 to 8.
- On both SCSI buses (channels) the Adaptec SCSI Card 39160 is preset to SCSI ID 7 and should not be changed. This gives the card the highest priority on the SCSI bus.
- Most internal SCSI hard disk drives come from the factory preset to SCSI ID 0.
- If you have 8-bit (or Narrow) SCSI devices, they must use SCSI IDs 0, 1, 2, 3, 4, 5, or 6. SCSI ID 0 is recommended for the first SCSI hard disk drive.
- If you are booting your computer from a SCSI hard disk drive connected to the Adaptec SCSI Card 39160, the Boot SCSI ID setting in the *SCSISelect* utility must correspond to the SCSI ID of the device from which you are booting. By default, the Boot SCSI ID is set to 0. We recommend that you do not change this setting.
- In Windows<sup>®</sup> 95/98, you can use the Device Manager to determine which SCSI ID is assigned to each installed SCSI device.

## Terminating the SCSI Bus

To ensure reliable communication on the SCSI bus, the ends of the SCSI bus must be properly terminated. This is accomplished when the device at the end of each cable, or the end of the cable itself, has a terminator installed (or enabled). Terminators must be removed, or termination must be disabled, on devices between the ends of each cable.

Since the method for terminating a SCSI device can vary widely, refer to the device's documentation for instructions on how to enable or disable termination. Here are some general guidelines for termination:

- Internal Ultra160 and Ultra2 SCSI devices come from the factory with termination disabled and cannot be changed. Proper termination for these internal devices is provided by the built-in terminator at the end of the 68-pin internal LVD SCSI cable.
- Termination on Wide SCSI, Narrow SCSI, and Ultra SCSI devices usually is controlled by manually setting a jumper or a switch on the device, or by physically removing or installing one or more resistor modules on the device.
- Termination on most external SCSI devices is controlled by installing or removing a SCSI terminator. However, termination on some external SCSI devices is enabled or disabled by setting a switch on the back of the SCSI device.
- By default, termination on the Adaptec SCSI Card 39160 itself is set to *Automatic* (the preferred method). We recommend that you do not change this default setting.

# Troubleshooting

Most problems can be resolved by following the recommendations in the Troubleshooting Checklist below. If you still experience problems after following the recommendations, continue with the rest of this section.

## Troubleshooting Checklist

Most problems with using the Adaptec SCSI Card 39160 result from errors in preparing and connecting devices on the SCSI bus. If you have problems, check these items first.



---

**Note:** If you have problems with a specific SCSI device when other connected SCSI devices are working correctly, please contact the manufacturer of the problem device for troubleshooting information.

---

- Are all SCSI cables and power cables properly connected?
- Are all SCSI devices turned on?
- Have you connected SCSI devices to *no more than two* of the three SCSI Channel A connectors? If you connected devices to all three connectors, *disconnect* devices from one connector!
- Is the Adaptec SCSI Card 39160 firmly seated and secured in the PCI expansion slot?
- Is the PCI expansion slot compliant with PCI Rev. 2.1 or higher, and does it support Bus Mastering?
- Are all SCSI devices on each SCSI bus assigned unique SCSI IDs?
- Are all SCSI devices terminated properly?

## Troubleshooting in Windows 95/98

When I start Windows 95/98, the system locks up when the Windows logo is displayed. How can I get the system to start so that I can verify that the SCSI card is functioning normally?

- 1 Start or restart your computer.
- 2 (For Windows 95:) When the message "Starting Windows 95" appears, press and release the **F8** function key while the text is on your screen.  
(For Windows 98:) When the message "Starting Windows 98" appears, press and release the **Ctrl** key while the text is on your screen.
- 3 From the menu that is displayed, select **Safe Mode**. (It may take several minutes for Windows 95/98 to load.)
- 4 If the system completes the boot to the desktop, the core software is functional; resources, software conflicts, and/or hardware need to be checked.
- 5 If the system still fails to boot, and the boot drive is connected to an EIDE controller, shut down the system, remove the Adaptec SCSI Card 39160, and restart the computer.
- 6 Verify that an IRQ is available by viewing resources in System Properties.
- 7 Under the Control Panel, verify that the operating system is set to **Optimal Performance** by checking the Performance tab under System Properties. (Make sure you are not in Safe Mode.)

How can I tell if the Adaptec SCSI Card 39160 driver is loading properly?

- 1 Right click on the **My Computer** icon on the Windows desktop.
- 2 Select **Properties** from the menu.
- 3 Click the **Device Manager** tab.

- 4 Double-click the **SCSI Controller** icon. The software driver for the Adaptec SCSI Card 39160 is listed as 29160(N), 39160, AHA-3960D, AIC-7892/7899 Ultra160 PCI SCSI Controller.
  - If the driver is listed, the Adaptec SCSI Card 39160 driver is loading properly.
  - If the driver is listed but has an exclamation mark inside a yellow circle the software driver may conflict with other hardware using the same resources. Double-click the icon to see the device status and possible solutions.
  - If the driver is listed but has an “X” inside a red circle, the Adaptec SCSI Card 39160 software driver is disabled and isn’t loading.
  - If the SCSI Controller icon or the Adaptec SCSI Card 39160 software driver is not listed, reinstall the driver. (For instructions on how to do this, refer to the *Ultra160 Family Manager Set User’s Guide*.)

**An “X” inside a red circle appears with the Adaptec SCSI Card 39160 software driver in Device Manager. What does this mean?**

It means that the Adaptec SCSI Card 39160 software driver is disabled and isn’t loading.

To enable the driver

- 1 Double-click the Adaptec SCSI Card 39160 software driver in Device Manager.
- 2 Under the General tab, click the **Original Configuration (current)** box.

**What if there is no SCSI Controller icon under Device Manager, or the software driver for the Adaptec SCSI Card 39160 does not appear under Device Manager?**

If the SCSI Controller icon or the software driver do not appear

- 1 Double-click the **Add New Hardware** icon in Control Panel.
- 2 Click **Next** to begin installing your new hardware.
- 3 Select **Yes (recommended)** and click **Next** to have Windows search for the Adaptec SCSI Card 39160.
- 4 Follow the on-screen instructions.

*Adaptec SCSI Card 39160 User's Reference*

If Windows 95/98 does not detect the Adaptec SCSI Card 39160, get the driver disk or CD included with the SCSI card and run the Add New Hardware wizard again:

- 1 Double-click the **Add New Hardware** icon in Control Panel.
- 2 Click **Next** to begin installing your new hardware.
- 3 Select **No** and click **Next** to select the type of hardware you want to install.
- 4 Select **SCSI controllers** and click **Next**.



---

**Note:** The 39160 will not appear on the Models list when **Adaptec** is selected from the Manufacturers list.

---

- 5 Click **Have Disk...** and follow the directions that appear on the screen to install the driver software.
- 6 Select **29160(N), 39160, AHA-3960D, AIC-7892/7899 Ultra160 PCI SCSI Controller**.

**How can I check the status of a resource such as IRQ, Memory, or I/O?**

- 1 Right click on **My Computer**.
- 2 Select **Properties** from the menu.
- 3 Click the **Device Manager** tab.
- 4 Double-click the **Computer** icon.
- 5 On the View Resources tab, click the option button for the type of resource you want to check:
  - Interrupt Request (IRQ)
  - Input/Output Address (I/O)
  - Direct Memory Access (DMA)
  - Memory
- 6 The setting and the hardware using the setting are displayed.
  - If a specific resource is not listed, the resource is not used by a device.

## *Troubleshooting*

- If a resource is listed more than once, the resource is used by more than one device.
- If a resource is used by an unknown device, the resource is used but the device using the resource cannot be detected. (This condition is most common.)

**7** Click **Cancel** to close the windows, then close Control Panel.

### **How do I use the Hardware Conflict Troubleshooter in Windows 95/98?**

- 1** Click the **Start** button, then click **Help**.
- 2** From the Contents tab, double-click **Troubleshooting**. (In Windows 98, click **Troubleshooting** and then click **Windows 98 Troubleshooting**.)
- 3** Double-click **if you have a hardware conflict**.
- 4** Follow the step-by-step instructions in Windows Help.

## **Common Error Messages**

Here is what you should do if the following messages appear on the screen at bootup:

**“Device connected, but not ready”**

The host computer received no answer when it requested data from an installed SCSI device.

- 1** Run *SCSISelect*<sup>®</sup> and set the Send Start Unit Command to **Yes** for the particular SCSI device ID. See *Starting SCSISelect* on page 18.
- 2** Ensure that the device is set to spin up when the power is switched on. The spin up option is typically set by a jumper. (See the documentation for the device.)

**“Start unit request failed”**

The SCSI card BIOS was unable to send a Start Unit Command to one of the installed SCSI devices. Run *SCSISelect* and disable the Send Start Unit Command for the device.

**“Time-out failure during...”**

An unexpected time-out occurred.

- 1** Verify that the SCSI bus is properly terminated.
- 2** Verify that all cables are properly connected.

Try disconnecting the SCSI device cables from the SCSI card and then starting the computer. If the computer successfully restarts, one of the SCSI devices may be defective.



# Using the Adaptec SCSI Card 39160 and SCSI Devices

This section provides useful information on using the Adaptec SCSI Card 39160 and your SCSI devices. For more information about a specific SCSI device, refer to the documentation for that device.

## Using SCSI Devices



---

**Caution:** *Do not* connect SCSI devices to more than two of the three SCSI Channel A connectors at the same time.

---

## Using SCSI Hard Disk Drives

- If you connect a SCSI hard disk drive to the Adaptec SCSI Card 39160 that was previously connected to a different SCSI card, you must low-level format the drive before you can use it. Back up the data on the drive before you move it! (See *Using SCSI Disk Utilities* on page 24 for information on using the *SCSISelect* format utility.)



---

**Caution:** A low-level format destroys all data on the drive. Be sure to back up the data before performing a low-level format.

---

- Every SCSI hard disk drive must be physically low-level formatted, partitioned, and logically formatted before it can be used to store data. Most SCSI drives are pre-formatted at the factory. If your SCSI hard disk drive has *not* been pre-formatted at the factory, and if your computer is running under DOS, Windows® 3.x, or Windows 95/98, you can format the disk with the DOS Fdisk and Format commands. (See the DOS and Windows documentation for more information.) To format

SCSI hard disk drives running under other operating systems, see the operating system documentation.

## Using Ultra160 Hard Disk Drives

- We recommend that you connect your LVD (Ultra160 and Ultra2) SCSI devices to SCSI Channel B and your non-LVD SCSI devices (if any) to SCSI Channel A. This allows the LVD SCSI devices to run at their maximum performance levels of 160 MBytes/sec or 80 MBytes/sec. Or you can connect LVD SCSI devices to both SCSI channels. If you combine LVD and non-LVD SCSI devices on the same SCSI channel, the data transfer rate of the LVD SCSI devices will drop down to non-LVD SCSI performance levels of up to 40 MBytes/sec.

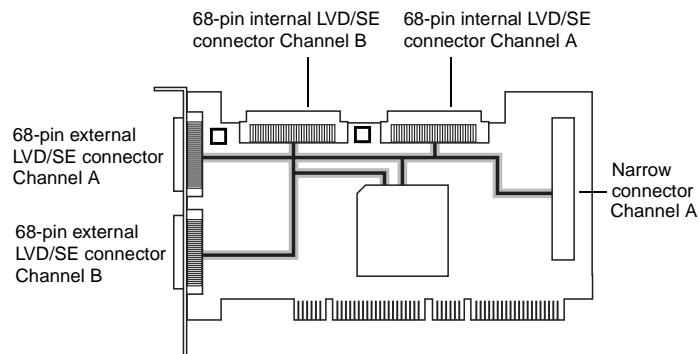

- Internal Ultra2 and Ultra160 SCSI devices come from the factory with termination disabled and cannot be changed. Proper termination is provided by the terminator at the end of the internal LVD SCSI cable.

## Using Scanners

If you connect a scanner to the Adaptec SCSI Card 39160, you must install the scanner manufacturer's proprietary software drivers. See your scanner's documentation for details.

## Combining SCSI and Non-SCSI Devices

You can install the Adaptec SCSI Card 39160 in a computer that already has a non-SCSI controller, such as an EIDE controller. However, you cannot cross-connect the disk drives and other devices: SCSI devices must be connected to the Adaptec SCSI Card 39160, EIDE devices must be connected to the EIDE controller, and so on.

When you install the Adaptec SCSI Card 39160 and SCSI disk drives in a computer that boots from a non-SCSI disk drive, the computer will continue to boot from the non-SCSI disk drive unless you change the computer's CMOS configuration. You do not need to change the configuration if you just want to use the SCSI drives for additional file storage space.

If your computer's motherboard BIOS supports the BIOS Boot Specification (BBS) feature, you can select a different boot device without much difficulty. (To determine if the motherboard BIOS supports BBS, read the computer documentation or contact your motherboard manufacturer.)

The following table shows what to do, after you physically install the SCSI card and SCSI devices, to use different kinds of disk drives in the same computer:

Does computer BIOS support BBS?	Want computer to boot from SCSI drive?	Then do this:
No	No	No action required. SCSI drives and non-SCSI drives can be used together.
No	Yes	Run CMOS Setup program. Change primary Hard Disk setting to <b>None</b> or <b>No Drives Installed</b> (see computer documentation). <i>You will not be able to use the non-SCSI drive(s) at all</i> when you boot from the SCSI drive.
Yes	No	No action required. SCSI drives and non-SCSI drives can be used together.
Yes	Yes	Run CMOS Setup program and select SCSI drive as boot device. SCSI drives and non-SCSI drives can be used together.

## Installing Multiple SCSI Cards

- You can install multiple SCSI cards in your computer; you are limited only by the available system resources (for example, IRQ settings, I/O port addresses, BIOS addresses, and so forth).
- Each SCSI card you install forms a separate SCSI bus with a different set of SCSI devices. SCSI IDs can be reused as long as the ID is assigned to a device on a different SCSI card (for example, each SCSI card can have a device with SCSI ID 2).
- If you have two or more SCSI cards and your computer boots from a SCSI disk drive, leave the host adapter BIOS enabled on the SCSI card to which the boot disk drive is connected. Use *SCSISelect* to disable the host adapter BIOS on the other SCSI cards.

## Connecting the LED Connector

*(Optional feature)* Most computers have an LED disk activity light on the front panel of the system case. If you choose to disconnect the cable from the LED connector on the motherboard and connect it to the LED connector on the SCSI card as shown in the diagram below, the LED on the front panel of the computer will light whenever there is activity on the SCSI bus.



**Note:** If you connect the LED cable to the SCSI card, the LED disk activity light will no longer indicate disk activity on the non-SCSI disk drives.

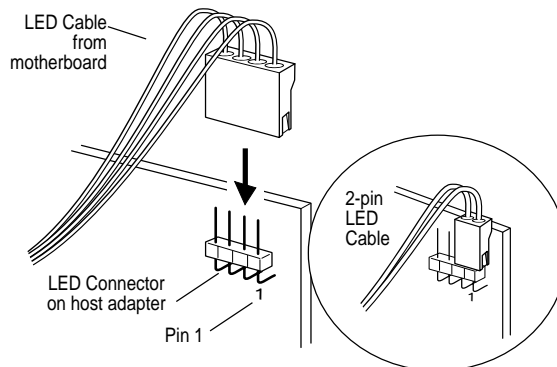

## Overriding SCSI Termination Settings

You use *SCSISelect* to control the termination of the two SCSI channels on the Adaptec SCSI Card 39160. The default termination setting for both channels is *Automatic*. This setting allows the SCSI card to adjust SCSI termination automatically, depending on which connectors have SCSI devices attached to them.

Regardless of the *SCSISelect* termination setting, the SCSI card termination is always disabled when the power is turned off. If you want SCSI card termination to be enabled when the power is turned off, you must terminate the SCSI channels manually.

To manually terminate Channel A, place a shunt on jumper J5. To manually terminate Channel B, place a shunt on jumper J3. The following diagram shows where the jumpers are located on the SCSI card:

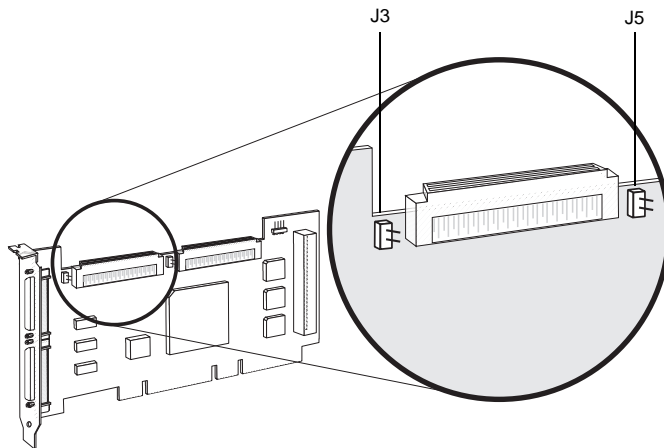

You might want to manually terminate the SCSI card if the Adaptec SCSI Card 39160 is connected to one or more external SCSI devices that are also connected to a SCSI card in another computer. The devices can be shared between the two computers if one SCSI card is terminated when it is powered off, while the computer with the other SCSI card is using the SCSI devices.

# Configuring the Adaptec SCSI Card 39160 with SCSISelect

SCSISelect, which is included with the Adaptec SCSI Card 39160, enables you to change SCSI settings without opening the computer or handling the card. SCSISelect also enables you to low-level format or verify the disk media of your SCSI hard disk drives. The following table lists the available and default settings for each SCSISelect option. The settings marked as "Auto-sync" are automatically synchronized for both SCSI channels—for example, if you change the Boot Channel option to **B First** on Channel A, the change will apply to Channel B as well. All other options can be set separately for each of the two SCSI channels.

The default settings are appropriate for most systems and should not be changed. Run SCSISelect if you need to change or view current settings, or if you need to use the SCSI disk utilities. See the descriptions of each option, starting on page 19.

SCSISelect Options	Available Settings	Default Setting
<b>SCSI Bus Interface Definitions:</b>		
Host Adapter SCSI ID	0-15	7
SCSI Parity Checking	Enabled Disabled	Enabled
Host Adapter SCSI Termination:		
Ch. A	Automatic Low On/High On Low Off/High Off Low Off/High On	Automatic
Ch. B	Automatic, Enabled, Disabled	Automatic
<b>Boot Device Options:</b>		
Boot Channel [Auto-sync]	A First, B First	A First
Boot SCSI ID [Auto-sync]	0-15	0
Boot LUN Number <sup>1</sup> [Auto-sync]	0-7	0

**Configuring the Adaptec SCSI Card 39160 with SCSISelect**

<b>SCSISelect Options</b>	<b>Available Settings</b>	<b>Default Setting</b>
<b>SCSI Device Configuration:</b>		
Sync Transfer Rate (MBytes/sec)	160, 80.0, 53.4, 40.0, 32.0, 26.8, 20.0, 16.0, 13.4, 10.0, ASYN	160
Initiate Wide Negotiation	Yes, No	Yes (Enabled)
Enable Disconnection	Yes, No	Yes (Enabled)
Send Start Unit Command	Yes, No	Yes (Enabled)
Enable Write Back Cache <sup>2</sup>	Yes, No, N/C (No Change)	N/C (No Change)
BIOS Multiple LUN Support <sup>2</sup>	Yes, No	No (Disabled)
Include in BIOS Scan <sup>2</sup>	Yes, No	Yes (Enabled)
<b>Advanced Configuration Options:</b>		
Reset SCSI Bus at IC Initialization	Enabled, Disabled	Enabled
Display <Ctrl> <A> Messages during BIOS Initialization [ <i>Auto-sync</i> ]	Enabled, Disabled	Enabled
Extended BIOS Translation for DOS Drives > 1 GByte	Enabled, Disabled	Enabled
Verbose/Silent Mode [ <i>Auto-sync</i> ]	Verbose, Silent	Verbose
Host Adapter BIOS [ <i>Auto-sync</i> ]	Enabled Disabled: Scan Bus Disabled: Not Scan	Enabled
Domain Validation <sup>2</sup> [ <i>Auto-sync</i> ]	Enabled, Disabled	Enabled
Support Removable Disks Under BIOS as Fixed Disks <sup>2</sup>	Disabled, Boot Only, All Disks	Disabled
BIOS Support for Bootable CD-ROM <sup>2</sup>	Enabled, Disabled	Enabled
BIOS Support for Int 13 Extensions <sup>2</sup>	Enabled, Disabled	Enabled

<sup>1</sup> Setting is valid only if Multiple LUN Support is enabled.

<sup>2</sup> Settings are valid only if host adapter BIOS is enabled.

## Starting SCSISelect

Follow these steps to start SCSISelect:

- 1 Turn on or restart your system.  
During the startup process, pay careful attention to the messages that appear on your screen.
- 2 When the following message appears on your screen, press the **Ctrl-A** keys simultaneously (this message appears for only a few seconds):  
Press <Ctrl><A> for SCSISelect (TM) Utility!
- 3 Select SCSI Channel **A** or **B**. Most SCSISelect options can be set separately for each SCSI channel.
- 4 From the menu that appears, use the arrow keys to move the cursor to the option you want to select, then press **Enter**.



---

**Note:** If you have difficulty viewing the display, press **F5** to toggle between color and monochrome modes. (This feature may not work on some monitors.)

---

## Exiting SCSISelect

Follow these steps to exit SCSISelect:

- 1 Press **Esc** until a message prompts you to exit (if you changed any settings, you are prompted to save the changes before you exit).
- 2 At the prompt, select **Yes** to exit, then press any key to reboot the computer. Any changes you made in SCSISelect take effect after the computer boots.



## Using SCSISelect Settings

To select an option, use the arrow keys to move the cursor to the option, then press **Enter**. In some cases, selecting an option displays another menu. You can return to the previous menu at any time by pressing **Esc**.

To restore the original SCSISelect default values, press **F6** from the main SCSISelect screen.

### SCSI Bus Interface Definitions

- **Host Adapter SCSI ID**—(Default: 7) Sets the SCSI ID for the SCSI card. The Adaptec SCSI Card 39160 is set at 7, which gives it the highest priority on the SCSI bus. We recommend that you do not change this setting.
- **SCSI Parity Checking**—(Default: *Enabled*) When set to **Enabled**, verifies the accuracy of data transfer on the SCSI bus. Leave this setting enabled unless any SCSI device connected to the Adaptec SCSI Card 39160 does not support SCSI parity.
- **Host Adapter SCSI Termination**—(Default: *Automatic*) Determines the termination setting for the SCSI card. The default setting is *Automatic*, which allows the SCSI card to adjust the termination as needed. We recommend that you do not change this setting.

### Boot Device Options

- **Boot Channel**—(Default: *A First*) Specifies which of the two SCSI channels the boot device is connected to (if the computer boots from a SCSI device). If you change this setting, the change automatically applies to both SCSI channels.
- **Boot SCSI ID**—(Default: 0) Specifies the SCSI ID of your boot device. We recommend that you do not change the default setting. If you change this setting, the change automatically applies to both SCSI channels.
- **Boot LUN Number**—(Default: 0) Specifies which LUN (Logical Unit Number) to boot from on your boot device. This setting is not valid unless Multiple LUN Support is enabled (see *Advanced Configuration Options* on page 21). If you change this setting, the change automatically applies to both SCSI channels.

## SCSI Device Configuration Options

SCSI Device Configuration options can be set individually for each connected SCSI device.



---

**Note:** To configure settings for a SCSI device, you must know its SCSI ID (see *Using SCSI Disk Utilities* on page 24).

---

- **Sync Transfer Rate**—(Default: 160) Determines the maximum synchronous data transfer rate that the SCSI card supports. We recommend that you leave the maximum (default) value of 160 MBytes/sec.
- **Initiate Wide Negotiation**—(Default: Yes) When set to **Yes**, the SCSI card attempts 16-bit data transfer (wide negotiation). When set to **No**, the SCSI card uses 8-bit data transfer unless the SCSI device requests wide negotiation.



---

**Note:** Set Initiate Wide Negotiation to **No** if you are using an 8-bit SCSI device that hangs or exhibits other performance problems with 16-bit data transfer rate enabled.

---

- **Enable Disconnection**—(Default: Yes) When set to **Yes**, allows the SCSI device to disconnect from the SCSI bus. Leave the setting at **Yes** if two or more SCSI devices are connected to the SCSI card. If only one SCSI device is connected, changing the setting to **No** results in slightly better performance.
- **Send Start Unit Command**—(Default: Yes) When set to **Yes**, sends the Start Unit Command to the SCSI device at bootup.

The following three options have no effect if the SCSI Card BIOS is disabled. (The SCSI Card BIOS is normally enabled by default.)

- **Enable Write Back Cache**—(Default: N/C) Can be used to enable or disable the write-back cache on SCSI disk drives connected to the host adapter. Leave this option at its default setting of N/C (no change), which usually allows for optimum drive performance.

- **BIOS Multiple LUN Support**—(Default: *No*) Leave this setting at **No** if the device does not have multiple Logical Unit Numbers (LUNs). When set to **Yes**, the SCSI card BIOS provides boot support for a SCSI device with multiple LUNs (for example, a CD “juke box” device in which multiple CDs can be accessed simultaneously).
- **Include in BIOS Scan**—(Default: *Yes*) When set to **Yes**, the SCSI card BIOS includes the device as part of its BIOS scan at bootup.

## Advanced Configuration Options



---

**Note:** *Do not* change the Advanced Configuration Options unless absolutely necessary.

---

- **Reset SCSI Bus at IC Initialization**—(Default: *Enabled*) When set to **Enabled**, the SCSI card generates a SCSI bus reset during its power-on initialization and after a hard reset.
- **Display <Ctrl> <A> Messages during BIOS Initialization**—(Default: *Enabled*) When set to **Enabled**, the SCSI card BIOS displays the Press <Ctrl> <A> for SCSISelect (TM) Utility! message on your screen during system bootup. If this setting is disabled, you can still invoke the SCSISelect Utility by pressing <Ctrl> <A> after the SCSI card BIOS banner appears. If you change this setting, the change automatically applies to both SCSI channels.
- **Extended BIOS Translation for DOS Drives > 1 GByte**—(Default: *Enabled*) When set to **Enabled**, provides an extended translation scheme for SCSI hard disks with capacities greater than 1 GByte. This setting is necessary only for MS-DOS 5.0 or above; it is not required for other operating systems, such as NetWare or UNIX.



---

**Caution:** Changing the translation scheme destroys all data on the drive. Be sure to back up your disk drives before changing the translation scheme.

---

Use the MS-DOS Fdisk command to partition a disk larger than 1 GByte controlled by the SCSI card BIOS, when using DOS, Windows 3.1.x, or Windows 95/98.

- **Verbose/Silent Mode**—(Default: *Verbose*) When set to **Verbose**, the SCSI card BIOS displays the host adapter model on the screen during system buildup. When set to **Silent**, the message will not be displayed during bootup. If you change this setting, the change automatically applies to both SCSI channels.
- **Host Adapter BIOS (Configuration Utility Reserves BIOS Space)**—(Default: *Enabled*) Enables or disables the SCSI card BIOS. If you change this setting, the change automatically applies to both SCSI channels.
  - Leave at **Enabled** to enable the SCSI card BIOS and allow it to scan and initialize all SCSI devices.
  - Set to **Disabled: Not scan** if the devices on the SCSI bus (for example, CD-ROM drives) are controlled by software drivers and do not need the BIOS, and you do not want the BIOS to scan the SCSI bus.
  - Set to **Disabled: Scan Bus** if you do not need the BIOS, but you want it to scan the SCSI devices on the bus and you need to spin up the device.

The following four options have no effect if the SCSI Card BIOS is disabled. (The SCSI Card BIOS is normally enabled by default.)

- **Domain Validation**—(Default: *Enabled*) Determines the optimal transfer rate for each device on the SCSI bus and sets transfer rates accordingly. Displays the resulting data transfer rate. If you change this setting, the change automatically applies to both SCSI channels.
- **Support Removable Disks Under BIOS as Fixed Disks**—(Default: *Disabled*) Determines which removable-media drives are supported by the SCSI card BIOS. The options are as follows:
  - **Disabled**— No removable-media drives are treated as hard disk drives. Software drivers are required because the drives are not controlled by the BIOS.



**Caution:** *You may lose data* if you remove a removable-media cartridge from a SCSI drive controlled by the SCSI card BIOS while the drive is on. If you want to be able to remove the media while the drive is on, install the removable-media software driver and set Support Removable Disks Under BIOS as Fixed Disks to **Disabled**.

- **Boot Only**—Only the removable-media drive designated as the boot device is treated as a hard disk drive.
- **All Disks**—All removable-media drives supported by the BIOS are treated as hard disk drives.
- **BIOS Support for Bootable CD-ROM**—(Default: *Enabled*)  
When set to **Enabled**, the SCSI card BIOS allows the computer to boot from a CD-ROM drive.
- **BIOS Support for Int 13 Extensions**—(Default: *Enabled*)  
When set to **Enabled**, the SCSI card BIOS supports Int 13h extensions as required by Plug-and-Play. The setting can be either enabled or disabled if your system is not Plug-and-Play.

## Using SCSI Disk Utilities

To access the SCSI disk utilities, follow these steps:

- 1 Select the **SCSI Disk Utilities** option from the menu that appears after starting *SCSISelect*. *SCSISelect* scans the SCSI bus (to determine the devices installed) and displays a list of all SCSI IDs and the devices assigned to each ID.
- 2 Use the ↑ and ↓ keys to move the cursor to a specific ID and device, then press **Enter**.
- 3 A small menu appears, displaying the options **Format Disk** and **Verify Disk Media**.
  - **Format Disk**—Allows you to perform a low-level format on a hard disk drive. *Most SCSI disk devices are preformatted at the factory and do not need to be formatted again.*



**Caution:** A low-level format destroys all data on the drive. Be sure to back up your data before performing this operation. You *cannot* abort a low-level format once it is started.

---

- **Verify Disk Media**—Allows you to scan the media of a hard disk drive for defects. If the utility finds bad blocks on the media, it prompts you to reassign them; if you select **yes**, those blocks are no longer used. You can press **Esc** at any time to abort the utility.

# Connecting SCSI Devices

Here are some examples of how you can connect internal and external SCSI devices to the Adaptec SCSI Card 39160. To achieve maximum performance, attach the first device to the end connector of the cable (furthest from the SCSI card); attach other devices to the connectors that are closer to the SCSI card.

The first example shows Ultra160 and Ultra2 SCSI devices connected to internal and external SCSI connectors of both SCSI channels. Note the built-in terminators at the end of the internal LVD SCSI cables. The last external SCSI device on each SCSI channel must be terminated with an LVD/SE terminator plug to ensure that all devices will operate at their maximum speed.

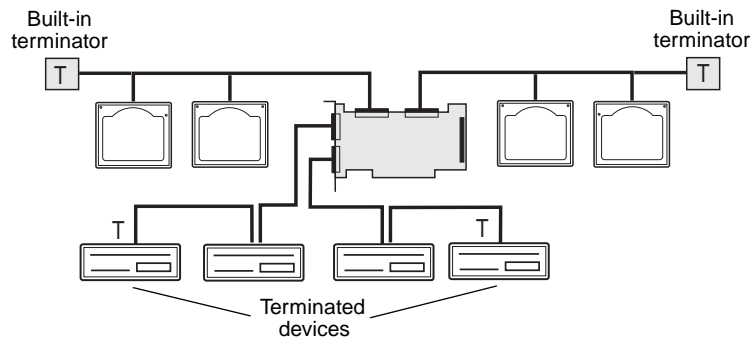

**Caution:** Do not connect SCSI devices to more than two of the three SCSI Channel A connectors at the same time.

The following example shows Ultra160 and Ultra2 SCSI devices connected to the internal connectors of both SCSI channels.

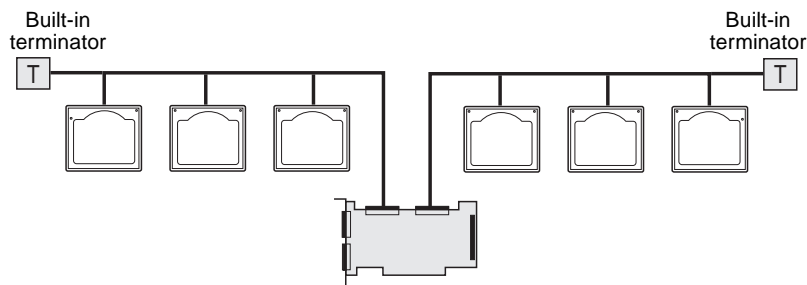

The following example shows LVD (Ultra160 and Ultra2) SCSI devices on Channel B and non-LVD SCSI devices on Channel A.

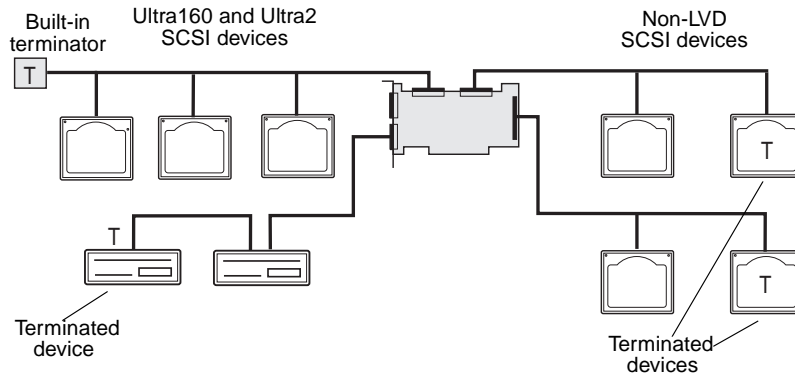

## Maximum Cable Lengths

The total length of cabling (internal and external) on the SCSI bus cannot exceed the maximum lengths listed in the following table. The third column lists the maximum number of SCSI devices you can connect to the SCSI card.

Maximum Cable Length	Data Transfer Rate	Maximum Devices Supported
25 m (82.0 ft)	Ultra160 SCSI (160 MBytes/sec) and Ultra2 SCSI (80 MBytes/sec)	1
12 m (39.4 ft)	Ultra160 SCSI (160 MBytes/sec) <sup>1</sup> and Ultra2 SCSI (80 MBytes/sec)	15
3 m (9.8 ft)	Fast Wide SCSI (20 MBytes/sec)	15
3 m (9.8 ft)	Fast SCSI (10 MBytes/sec)	7
3 m (9.8 ft)	Ultra SCSI (40 MBytes/sec for 16-bit, 20 MBytes/sec for 8-bit)	4
1.5 m (4.9 ft)	Ultra SCSI (40 MBytes/sec for 16-bit, 20 MBytes/sec for 8-bit)	5-7 <sup>2</sup>

<sup>1</sup> Mixing Fast/Ultra devices with Ultra160 and Ultra2 SCSI devices causes the entire SCSI bus to default to Ultra SCSI speeds and cable length requirements.

<sup>2</sup> Ultra SCSI data transfer rates do not currently support more than seven devices connected to the SCSI card.





**Copyright**

© 1999 Adaptec, Inc. All rights reserved. No part of this publication may be reproduced, stored in a retrieval system, or transmitted in any form or by any means, electronic, mechanical, photocopying, recording or otherwise, without the prior written consent of Adaptec, Inc., 691 South Milpitas Blvd., Milpitas, CA 95035.

**Trademarks**

Adaptec, the Adaptec logo, AHA, SpeedFlex, and SCSI*Select* are trademarks of Adaptec, Inc. which may be registered in some jurisdictions. Window and Windows 95/98 are registered trademarks of Microsoft Corporation in the U.S. and other countries used under license. All other trademarks are owned by their respective owners.

**Changes**

The material in this document is for information only and is subject to change without notice. While reasonable efforts have been made in the preparation of this document to assure its accuracy, Adaptec, Inc. assumes no liability resulting from errors or omissions in this document, or from the use of the information contained herein.

Adaptec reserves the right to make changes in the product design without reservation and without notification to its users.

**Disclaimer**

IF THIS PRODUCT DIRECTS YOU TO COPY MATERIALS, YOU MUST HAVE PERMISSION FROM THE COPYRIGHT OWNER OF THE MATERIALS TO AVOID VIOLATING THE LAW WHICH COULD RESULT IN DAMAGES OR OTHER REMEDIES.

## Adaptec Customer Support

If you have questions about installing or using your Adaptec product, check this User's Reference first—you will find answers to most of your questions here. If you need further assistance, please contact us. We offer the following support and information services.

### *Technical Support Identification (TSID) Number*

- The TSID is a 12-digit number that can be found on the white label included in the box with your product. It helps to provide more efficient service to you by accurately identifying your product and support status. The TSID is required when you contact Technical Support.
- Affix your TSID label here:



### *Contacting Support*

Technical information including product literature, answers to commonly asked questions, and information on software upgrades is available through the following:

- For information about Adaptec's support options, call 408-945-2550, 24 hours a day, 7 days a week.
- Search the Adaptec Support Knowledgebase (A.S.K.) at <http://ask.adaptec.com> for articles, troubleshooting tips, and frequently asked questions for your product.
- Connect to the File Transfer Protocol (FTP) server at <ftp://ftp.adaptec.com>.
- For email support, send technical questions to Adaptec's Technical Support Specialists via WebMail at <http://www.adaptec.com/support/webmail.html>.
- To speak with a Technical Support Specialist, call 408-934-7274, Monday–Friday, 6:00 A.M. to 5:00 P.M., Pacific Time.
- After-hours, weekend, and holiday support is available for a fee at 800-416-8066.

### *Sales and Ordering Information*

- For pre-sales assistance with Adaptec products; to place an order for software, hardware, or cables; or to request additional documentation for Adaptec products, call 800-442-7274 or 408-957-7274, Monday–Friday, 6:00 A.M. to 5:00 P.M., Pacific Time.
- For sales information in Europe, call
  - France: +33 1 34 523434
  - Germany: +49 89 4564060
  - UK: +44 1276 854500

## Regulatory Compliance Statements

### Federal Communications Commission Radio Frequency Interference Statement

WARNING: Changes or modifications to this unit not expressly approved by the party responsible for compliance could void the user's authority to operate the equipment.

This equipment has been tested and found to comply with the limits for a Class B digital device, pursuant to Part 15 of the FCC rules. These limits are designed to provide reasonable protection against harmful interference in a residential installation. This equipment generates, uses, and can radiate radio frequency energy, and if not installed and used in accordance with the instruction manual, may cause harmful interference to radio communications. However, there is no guarantee that interference will not occur in a particular installation. However, if this equipment does cause interference to radio or television equipment reception, which can be determined by turning the equipment off and on, the user is encouraged to try to correct the interference by one or more of the following measures:

- Reorient or relocate the receiving antenna.
- Increase the separation between equipment and receiver.
- Connect the equipment to an outlet on a circuit different from that to which the receiver is connected.
- Consult the dealer or an experienced radio/television technician for help.
- Use a shielded and properly grounded I/O cable and power cable to ensure compliance of this unit to the specified limits of the rules.

This device complies with part 15 of the FCC rules. Operation is subject to the following two conditions: (1) this device may not cause harmful interference and (2) this device must accept any interference received, including interference that may cause undesired operation.

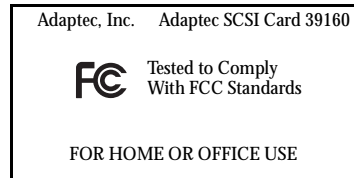

### European Union Compliance Statement

This Information Technology Equipment has been tested and found to comply with the following European directives:

EMC Directive 89/336/EEC

EN 50081-1 (1992):  
EN55022 (1994) Class B

EN 50082-1 (1992):  
EN61000-4-2 (1998)  
EN61000-4-3 (1998)  
EN61000-4-4 (1995)



### Australian/New Zealand Compliance Statement

This device has been tested and found to comply with the limits for a Class B digital device, pursuant to the Australian/New Zealand standard AS/NZS 3548 set out by the Spectrum Management Agency.

**Canadian Compliance Statement**

This Class B digital apparatus meets all requirements of the Canadian Interference-Causing Equipment Regulations.

Cet appareil numérique de la classe B respecte toutes les exigences du Règlement sur le matériel brouilleur du Canada.

**Japanese Compliance**

## Adaptec Software License Agreement

In return for acquiring a license to use the software ("Software") and related documentation, you agree to the following terms and conditions:

- 1 License: This Agreement grants you, the Licensee, a license to:
  - a use the Software on a single computer system which incorporates an Adaptec SCSI Card, or in the case of a multi-user or networked system which permits access to the Software by more than one user at the same time, at a single working location.
  - b make one copy of the Software in machine readable form solely for back-up purposes provided you reproduce Adaptec's copyright notice and any proprietary legends.
- 2 Restrictions: You may not distribute copies of the Software to others or electronically transfer the Software from one computer to another over a network. You may not use the Software from multiple locations of a multi-user or networked system at any one time. The Software contains trade secrets and in order to protect them you may not decompile, reverse engineer, disassemble, or otherwise reduce the Software to a human-perceivable form. YOU MAY NOT MODIFY, ADAPT, TRANSLATE, RENT, LEASE, LOAN, RESELL FOR PROFIT, DISTRIBUTE, NETWORK OR CREATE DERIVATIVE WORKS BASED UPON THE SOFTWARE OR ANY PART THEREOF.
- 3 Ownership of Software: As Licensee, you own the media upon which the software is fixed, but Adaptec retains title and ownership of the Software recorded on the original media and all subsequent copies of the Software regardless of the form or media in which or on which the original and other copies may exist. This license is not a sale of the Software or any copy.
- 4 Confidentiality: You agree to maintain the Software in confidence and to not disclose the Software to any third party without the express written consent of Adaptec. You further agree to take all reasonable precautions to preclude access of unauthorized persons to the Software.
- 5 Term: This license is effective until January 1, 2042, unless terminated earlier. You may terminate the license at any time by destroying the Software (including the related documentation) together with all copies or modifications in any form. Adaptec will have the right to terminate your license immediately if you fail to comply with any term or condition of this Agreement. Upon any termination, including termination by you, you must destroy the Software (including the related documentation) together with all copies or modifications in any form.
- 6 Limited Warranty: Adaptec warrants only that the media upon which the Software is furnished will be free from defects in material or workmanship under normal use and service for a period of thirty (30) days from the date of delivery to you. ADAPTEC DOES NOT AND CANNOT WARRANT THE PERFORMANCE OR RESULTS YOU MAY OBTAIN BY USING THE SOFTWARE OR DOCUMENTATION. THE FOREGOING STATES THE SOLE AND EXCLUSIVE REMEDIES ADAPTEC WILL PROVIDE FOR BREACH OF WARRANTY. EXCEPT FOR THE FOREGOING LIMITED WARRANTY, ADAPTEC MAKES NO WARRANTIES, EXPRESS OR IMPLIED, AS TO NONINFRINGEMENT OF THIRD PARTY RIGHTS, MERCHANTABILITY OR FITNESS FOR A PARTICULAR PURPOSE. Some states do not allow the exclusion of implied warranties or limitations on how long an implied warranty may last, so the above limitations may not apply to you. This warranty gives you specific legal rights and you may also have other rights which vary from state to state.
- 7 Limitation of Liability: IN NO EVENT WILL ADAPTEC BE LIABLE TO YOU FOR ANY SPECIAL DAMAGES, INCLUDING ANY LOST PROFITS, LOST SAVINGS OR OTHER INCIDENTAL OR CONSEQUENTIAL DAMAGES, EVEN IF ADAPTEC HAS BEEN ADVISED OF THE POSSIBILITY OF SUCH DAMAGES, OR FOR ANY CLAIM BY ANY OTHER PARTY. Some states do not allow the exclusion or limitation of special, incidental, or consequential damages, so the above limitation or exclusion may not apply to you.
- 8 Limitation of Remedies: Adaptec's entire liability and your exclusive remedy shall be:
  - a the replacement of any media not meeting Adaptec's limited warranty which is returned to Adaptec; or
  - b if Adaptec or its distributor is unable to deliver replacement media which is free of defects in materials or workmanship, you may terminate this Agreement by returning the Software and your money will be refunded.

- 9 Export: You acknowledge that the laws and regulations of the United States restrict the export and re-export of the Software. You agree that you will not export or re-export the Software or media in any form without the appropriate United States and foreign government approval.
- 10 U.S. Government Restricted Rights Legend for Units of the DoD: Use, duplication or disclosure by the Government is subject to restrictions as set forth in subparagraph (c)(1)(ii) of the Rights in Technical Data and Computer Software clause at 252.227-7013. Adaptec, Inc., 691 South Milpitas Boulevard, Milpitas, California 95035.
- 11 U.S. Government Restricted Rights Legend for Civilian Agencies: Use, reproduction or disclosure is subject to restrictions as set forth in subparagraphs (a) through (d) of the Commercial Computer Software - Restricted Rights clause at 52.227-19 and the limitations set forth in Adaptec, Inc.'s standard commercial agreement for this software. Unpublished - rights reserved under the copyright laws of the United States.
- 12 General: You acknowledge that you have read this Agreement, understand it, and that by opening the package you agree to be bound by its terms and conditions. You further agree that it is the complete and exclusive statement of the agreement between Adaptec and you which supersedes any proposal or prior agreement, oral or written, and any terms of this Agreement or any different terms will be enforceable against Adaptec unless Adaptec gives its express consent, including an express waiver of the terms of this Agreement, in a writing signed by an officer of Adaptec. You assume full responsibility for the use of the Software and agree to use the Software legally and responsibly. This Agreement shall be governed by California law except as to copyright matters which are covered by Federal law. This Agreement is deemed entered into at Milpitas, California by both parties. Should any provision of this Agreement be declared unenforceable in any jurisdiction, then such provision shall be deemed to be severable from this Agreement and shall not affect the remainder hereof. All rights in the Software not specifically granted in this Agreement are reserved by Adaptec.

Should you have any questions concerning this Agreement, you may contact Adaptec by writing to: Adaptec, Inc., Legal Department, 691 South Milpitas Boulevard, Milpitas, California 95035.

## Free Manuals Download Website

<http://myh66.com>

<http://usermanuals.us>

<http://www.somanuals.com>

<http://www.4manuals.cc>

<http://www.manual-lib.com>

<http://www.404manual.com>

<http://www.luxmanual.com>

<http://aubethermostatmanual.com>

Golf course search by state

<http://golfingnear.com>

Email search by domain

<http://emailbydomain.com>

Auto manuals search

<http://auto.somanuals.com>

TV manuals search

<http://tv.somanuals.com>