

ADDER Link



INSTALLATION & USE

AL Extender pair

ALTX/ALRX



AL Silver pair

ALSTX/ALSRX



AL Gold pair

ALGTX/ALGRX



The AdderLink contains fine video compensation amplifiers to maximise the video quality for any given length of twisted pair cable. To adjust the compensation and sharpen the video picture refer to section 2.8

ADDER Link



www.addertec.com

About this manual

AdderLink - Installation and Use

www.addertec.com

Third edition (May 2000)

Part No. ADD0035/3

(c) 2000 Adder Technology Ltd.

All rights reserved. Whilst every precaution has been taken in the preparation of this manual, Adder Technology Ltd assumes no responsibility for errors or omissions. Neither is any liability assumed for damages resulting from the use of the information contained herein. We reserve the right to change the specifications, functions and circuitry of the product without notice.

Safety information

- For use in dry, oil free indoor environments only.
- Warning - live parts contained within power adapter.
- No user serviceable parts within power adapter - do not dismantle.
- Plug the power adapter into a socket outlet close to the AdderLink unit that it is powering.
- Replace the power adapter with a manufacturer approved type only.
- Do not use the power adapter if the power adapter case becomes damaged, cracked or broken or if you suspect that it is not operating properly.
- If you use a power extension cord with the AdderLink, make sure the total ampere rating of the devices plugged into the extension cord do not exceed the cord's ampere rating. Also, make sure that the total ampere rating of all the devices plugged into the wall outlet does not exceed the wall outlet's ampere rating.
- Do not attempt to service the AdderLink yourself.

Warranty

Adder Technology Ltd warrants that this product shall be free from defects in workmanship and materials for a period of one year from the date of original purchase. If the product should fail to operate correctly in normal use during the warranty period, Adder will replace or repair it free of charge. No liability can be accepted for damage due to misuse or circumstances outside Adder's control. Also Adder will not be responsible for any loss, damage or injury arising directly or indirectly from the use of this product. Adder's total liability under the terms of this warranty shall in all circumstances be limited to the replacement value of this product.

If any difficulty is experienced in the installation or use of this product that you are unable to resolve, please contact your supplier.

Trademarks

All trademarks mentioned in this manual are acknowledged to be the property of the respective trademark owners.

Adder is a registered trademark of Adder Technology Limited.

Compaq is a registered trademark of Compaq Computer Corporation.

Hewlett-Packard is a registered trademark of Hewlett-Packard.

IBM, PC/AT, PS/2, RS/6000 and ThinkPad are registered trademarks of International Business Machines Corporation.

Logitech, MouseMan+ and Pilot Mouse+ are trademarks of Logitech Inc.

Microsoft and Windows are registered trademarks, and IntelliMouse is a trademark of Microsoft Corporation.

Velcro is a trademark of Velcro USA Inc.

Radio Frequency Energy

A Category 5 (or better) twisted pair cable must be used to connect the AdderLink units in order to maintain compliance with radio frequency energy emission regulations and ensure a suitably high level of immunity to electromagnetic disturbances.

All other interface cables used with this equipment must be shielded in order to maintain compliance with radio frequency energy emission regulations and ensure a suitably high level of immunity to electromagnetic disturbances.

European EMC directive 89/336/EEC

This equipment has been tested and found to comply with the limits for a class A computing device in accordance with the specifications in the European standard EN55022. These limits are designed to provide reasonable protection against harmful interference. This equipment generates, uses and can radiate radio frequency energy and if not installed and used in accordance with the instructions may cause harmful interference to radio or television reception. However, there is no guarantee that harmful interference will not occur in a particular installation. If this equipment does cause interference to radio or television reception, which can be determined by turning the equipment on and off, the user is encouraged to correct the interference with one or more of the following measures: (a) Reorient or relocate the receiving antenna. (b) Increase the separation between the equipment and the receiver. (c) Connect the equipment to an outlet on a circuit different from that to which the receiver is connected. (d) Consult the supplier or an experienced radio / TV technician for help.

FCC Compliance Statement (United States)

This equipment generates, uses and can radiate radio frequency energy and if not installed and used properly, that is, in strict accordance with the manufacturer's instructions, may cause interference to radio communication. It has been tested and found to comply with the limits for a class A computing device in accordance with the specifications in Subpart J of part 15 of FCC rules, which are designed to provide reasonable protection against such interference when the equipment is operated in a commercial environment. Operation of this equipment in a residential area may cause interference, in which case the user at his own expense will be required to take whatever measures may be necessary to correct the interference. Changes or modifications not expressly approved by the manufacturer could void the user's authority to operate the equipment.

Canadian Department of Communications RFI statement

This equipment does not exceed the class A limits for radio noise emissions from digital apparatus set out in the radio interference regulations of the Canadian Department of Communications.

Le présent appareil numérique n'émet pas de bruits radioélectriques dépassant les limites applicables aux appareils numériques de la classe A prescrites dans le règlement sur le brouillage radioélectriques publié par le ministère des Communications du Canada.

Contents

1. Introduction.....	6
1.1 AdderLink features.....	6
1.2 Additional AdderLink Gold features	7
1.3 Product information.....	8
1.4 Package contents	11
2. Installation.....	14
2.1 What you will need	14
2.2 Mounting the AdderLink	16
2.3 Connecting your devices	16
2.4 Configuring your PC(s)	19
2.6 Configuring the AdderLink	19
2.7 Setting the option switches	20
2.8 Setting the video compensation	24
2.9 Configuring the user-selectable options	26
2.10 Summary of AdderLink configuration options	27
2.11 Other useful installation information	29
2.12 Hot plugging the AdderLink into running systems and re-enabling disconnected PS/2 CPU mouse connections	29

3. Using the AdderLink	31
3.1 Power on status	31
3.2 AdderLink indicator lights.....	32
3.3 Keyboard NUM,CAPS and SCROLL lock indicators.....	34
3.4 Keyboard hotkey control	35
3.5 Contending for control of the XL unit's computer (AdderLink Gold)	37
3.6 Entering an exiting video compensation / configuration mode	37
3.7 Mouse control	38
3.8 Stereo audio support on the AdderLink Gold.....	38
3.9 Microphone support on the AdderLink Gold	39
3.10 Setting and using the security password	39
3.11 Querying the AdderLink's firmware version	41

4. AdderLink configuration options	42
4.1 RS232 protocol options	42
4.2 Mouse mode and mouse switching of channels	43
4.3 Resetting all configuration options to their default state	44

Appendices

A - Cable and connector specifications	45
B - Problem solving	50

1. Introduction

Thank you for purchasing the AdderLink extender. Your AdderLink is designed to transfer keyboard, video, mouse and RS232 signals up to 200 metres over Category 5 twisted pair cable. The AdderLink system consists of a transmitter (XL) and a receiver (XR) unit that are connected together by a twisted pair cable. The XR unit connects to your keyboard, monitor and mouse and the XL unit connects to the computer system that is to be controlled.

The AdderLink extender is supplied in both standard (AdderLink) and enhanced (AdderLink Gold) formats. In addition to the features supported by the AdderLink, the AdderLink Gold system supports stereo audio and microphone signals and extra connectivity options. This additional connectivity enables a second keyboard/monitor/mouse set to be connected to the XL unit and an additional computer system to be connected to the XR unit.

1.1 AdderLink features

- Enables a keyboard, monitor, mouse and RS232 device to be located up to 200 metres from a computer.
- Uses a single Category 5 (or better) unshielded twisted pair cable to carry all the keyboard, video, mouse and RS232 signals.
- Fine user-adjustable video compensation enables the video quality to be maximised for any given length of cable.
- The video compensation only needs to be adjusted once during setup. The chosen compensation setting is retained in EEPROM memory even when the AdderLink is powered off.
- Mixed AT/PS2 keyboards and PS2/RS232 mice supported as standard.
- Supports Microsoft IntelliMouse and other common wheel mice.
- Password security prevents unauthorised use.
- Supports high bandwidth monitors at resolutions up to 1600 x 1280.
- Supports keyboard modes 1,2 and 3 and mouse prompt and stream modes for maximum compatibility.

- Power and activity indication confirm correct operation.
- Standard cable connections make installation easy and inexpensive.
- Robust metal case ensures good shielding and video quality.
- 19 inch rack mount kit available.
- Supports IBM PC compatibles and RS6000 computers.

1.2 Additional AdderLink Gold features

- Supports stereo audio and microphone signals.
- Provides an additional user port (keyboard/monitor/mouse/speaker/microphone) on the XL transmitter unit enabling the computer to be controlled from a location close to the XL transmitter as well as a location close to the XR receiver.
- Provides an additional computer port (keyboard/monitor/mouse/speaker/microphone) on the XR receiver unit enabling the user to control a local computer in addition to the remote computer that is connected via the twisted pair cable.
- Front panel indicators show the currently active user port and the currently selected computer.

1.3 Product information

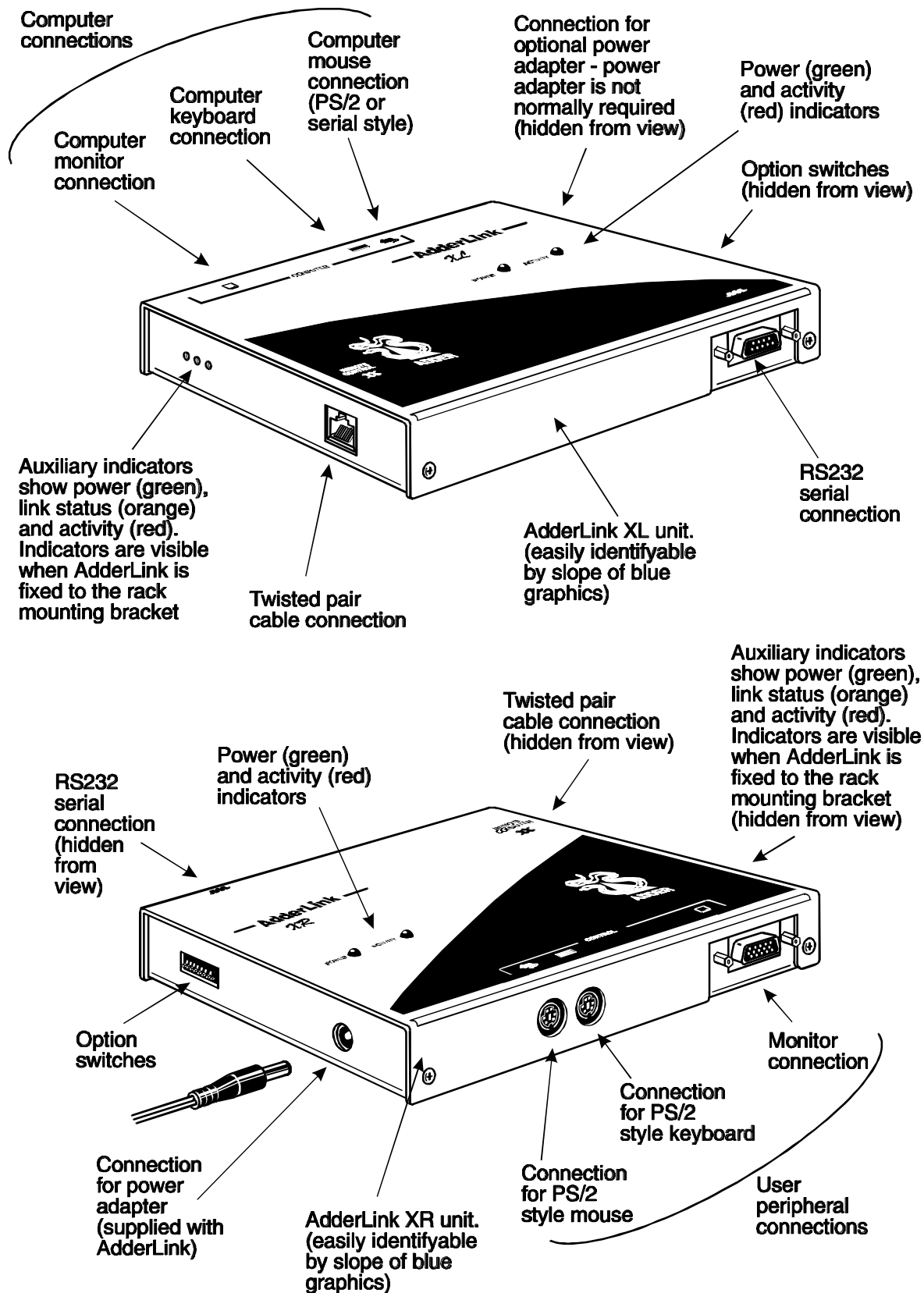

Figure 1 – AdderLink XL transmitter and XR receiver

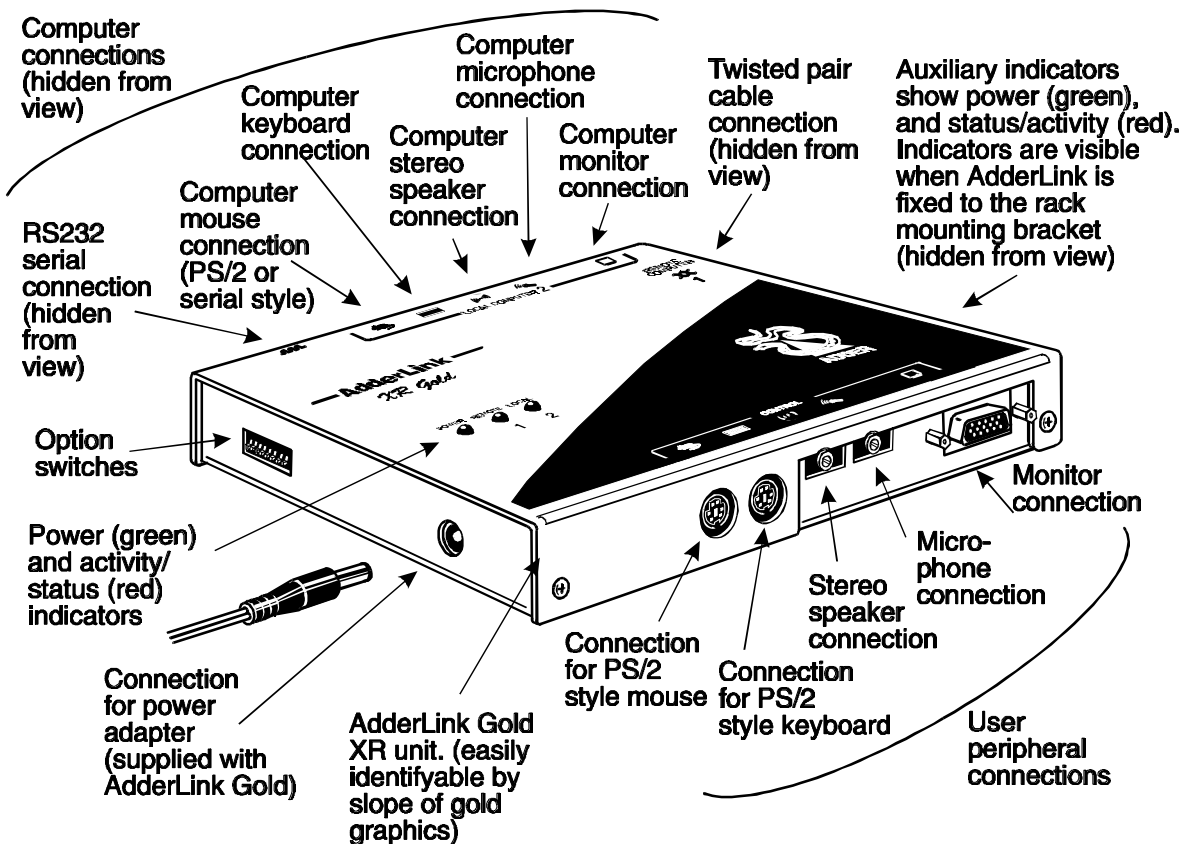
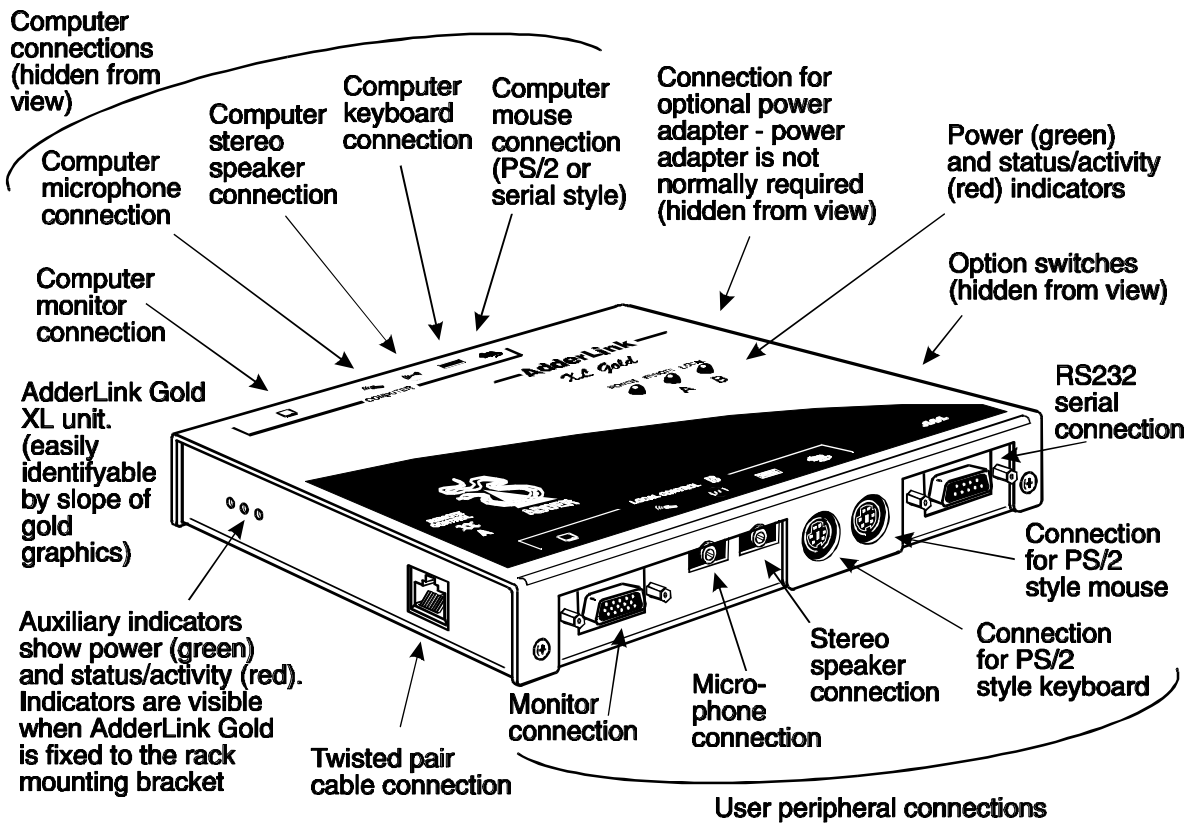

Figure 2 – AdderLink Gold XL transmitter and XR receiver

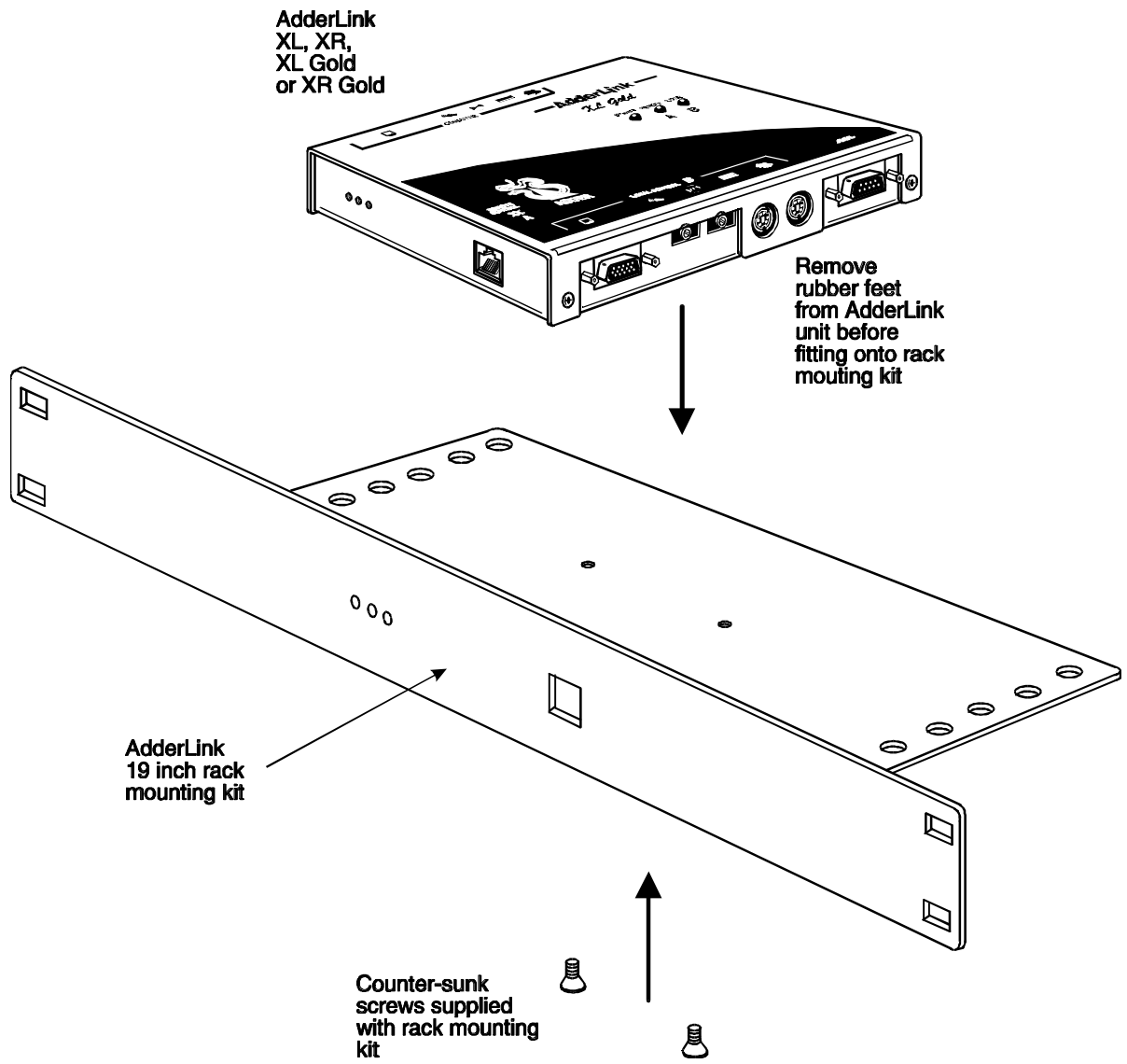

Figure 3 – Mounting the AdderLink in the optional 19 inch rack mounting kit

1.4 Package contents

AdderLink package contents (part code: ALTX/ALRX)

Quantity	Description
1	AdderLink XL transmitter unit
1	AdderLink XR receiver unit
1	Instruction manual
1	Power adapter for the XR receiver unit

(Please note that the XL transmitter unit does not normally require a power adapter because it draws its power from the computer via the keyboard interface cable. A second power adapter is therefore NOT SUPPLIED but may be purchased separately for video only applications.)

AdderLink Gold package contents (part code: ALGTX/ALGRX)

Quantity	Description
1	AdderLink Gold XL transmitter unit
1	AdderLink Gold XR receiver unit
1	Instruction manual
1	Power adapter for the XR receiver unit

(Please note that the XL transmitter unit does not normally require a power adapter because it draws its power from the computer via the keyboard interface cable. A second power adapter is therefore NOT SUPPLIED but may be purchased separately for video only applications.)

AdderLink 19 inch rack-mount kit (part code: RMK-AL)

Quantity	Description
1	Mounting assembly for 19 inch racks
2	Counter-sunk screws for fixing AdderLink to mounting assembly

The rack-mount kit is suitable to mount the XL or XR unit into a 19 inch rack. If you required to mount both the XR and the XL units in 19 inch racks then you will need two rack-mount kits. The kit is suitable for the AdderLink and the AdderLink Gold.

AdderLink cable pack (part code: VSCP5)

This cable pack is suitable for connecting your computer to the AdderLink XL unit. It is also suitable for connecting your computer to the AdderLink Gold XL unit or the AdderLink Gold XR unit if you do not wish to use speakers or microphones. Your PS/2 keyboard, PS/2 mouse and monitor may be plugged into the AdderLink directly.

Quantity	Description
1	High resolution tri-coax video cable - 2 metres long
2	PS/2 keyboard/mouse cables - 2 metres long
1	Serial mouse adapter (plugs onto end of PS/2 cable)
1	AT keyboard adapter (plugs onto end of PS/2 cable)
1	UTP patch cable

AdderLink Gold cable pack (part code: VSCP5-GOLD)

This cable pack is suitable for connecting your computer to the AdderLink Gold XL unit or the AdderLink Gold XR unit. Your PS/2 keyboard, PS/2 mouse, monitor, stereo speakers and microphone may be plugged into the AdderLink Gold directly.

Quantity	Description
1	High resolution tri-coax video cable - 2 metres long
2	PS/2 keyboard/mouse cables - 2 metres long
2	Stereo speaker/microphone audio cables – 2 metres long
1	Serial mouse adapter (plugs onto end of PS/2 cable)
1	AT keyboard adapter (plugs onto end of PS/2 cable)
2	UTP patch cable - 3 metres long

AdderLink Gold cable pack (part code: VSCP6)

This cable pack is suitable for connecting a computer to the AdderLink Gold XL unit and a second computer to the AdderLink Gold XR unit. Your PS/2 keyboard, PS/2 mouse, monitor, stereo speakers and microphone may be plugged into the AdderLink Gold directly.

Quantity	Description
2	High resolution tri-coax video cables - 2 metres long
4	PS/2 keyboard/mouse cables - 2 metres long
4	Stereo speaker/microphone audio cables – 2 metres long
2	Serial mouse adapters (plug onto end of PS/2 cable)
3	AT keyboard adapter (plug onto end of PS/2 cable)
1	UTP patch cable - 3 metres long

2. Installation

2.1 What you will need

- A category 5 (or better) twisted pair cable of the required length to connect the AdderLink XL and XR units together. These cables contain 4 pairs of twisted wires. Specifications and recommended cable types are given in appendix A. AdderLink supports cable lengths up to 200 metres. Structured wiring within buildings may also be used together with suitable patch cables but the number of cable connections should be kept to a minimum to maximise signal quality.
- Cables to connect the AdderLink XL unit to your computer. Cable specifications are given in appendix A. Cable packs are available for the AdderLink if you do not wish to purchase individual cables. You do not need to connect cables for devices that you do not wish to use with the exception of the keyboard cable which the AdderLink XL unit uses to draw power from the computer. If you do not wish to connect a keyboard then you may alternatively purchase an optional power adapter (part code: PSU-IEC-5V DC)
- A monitor with a standard VGA/SVGA (15 pin) connector that will work when connected directly to your computer. If you are connecting an additional computer to the AdderLink Gold XR unit then the monitor must also work when connected directly to this computer. AdderLink supports low and high resolution monitors.
- A standard AT or PS/2 style keyboard. If you are using an AT keyboard with a 5 pin connector you may connect this to the AdderLink using a standard AT to PS/2 keyboard adapter.
- A PS/2 style two or three button Microsoft or Logitech compatible mouse or a Microsoft IntelliMouse compatible mouse. If you have an AdderLink Gold and you wish to use the mouse to switch the XR unit's channel then you will need a three button mouse or an IntelliMouse.

(The AdderLink supports 'Internet Mice' that are compatible with the Microsoft IntelliMouse. These are fitted with a wheel or other scroll control and sometimes have additional buttons. Examples are: Microsoft IntelliMouse, Logitech Pilot Mouse+, Logitech MouseMan+, Genius NetMouse and Genius NetMouse Pro.)

- A suitable mouse driver for your PC(s). Supported types are:
 - PS/2 or RS232 two button mouse driver (any manufacturer).
 - Microsoft mouse driver (including IntelliMouse).
 - Logitech mouse driver (including two button, three button and wheel mouse)

If you have the AdderLink Gold then you may also require:

- An additional set of computer cables to connect your additional computer to the AdderLink Gold XR unit.
- An additional keyboard, mouse and monitor of the type described above to connect to the AdderLink XL unit.
- One or two sets of stereo speakers.
- One or two microphones.

If you require to connect serial devices you may also require:

- Suitable conversion cables to connect your particular type of RS232 device. Refer to appendix A for more details.

Use of PS/2 and RS232 style mice with the AdderLink - The mouse connections from AdderLink to PCs support either a PS/2 or an RS232 mouse. AdderLink automatically converts from the PS/2 mouse commands to RS232 serial mouse commands. Serial mice types are selected by using an adapter as described in Appendix A. The 9-pin D-type serial ports on the AdderLink may also be configured to support serial mice but this setup is less ideal and is therefore not generally recommended. The AdderLink will operate without a mouse connected if you do not wish to use one.

2.2 Mounting the AdderLink

The AdderLink has been designed to be used either on a desktop or mounted in a 19 inch rack. If the AdderLink is to be mounted in a 19 inch rack then you will need the optional rack mounting kit (part code: RMK-AL). The AdderLink may also be mounted on a suitable vertical surface, such as the side of a desk, with the use of strong Velcro strips.

2.3 Connecting your devices

Ensure that the power adapter is disconnected from the AdderLink and that all the devices which are to be attached are switched off. Connect your devices to the AdderLink or AdderLink Gold as shown in figures 4 and 5. Ensure that the cables are no longer than the maximum cable lengths specified in appendix A. Any unused computer or peripheral connections can be left unconnected. To connect computers with serial mouse connections and AT style keyboard connections use the adapters supplied in the cabling pack as shown below. Alternatively, if you have chosen not to purchase the cable pack, refer to appendix A for cable specifications.

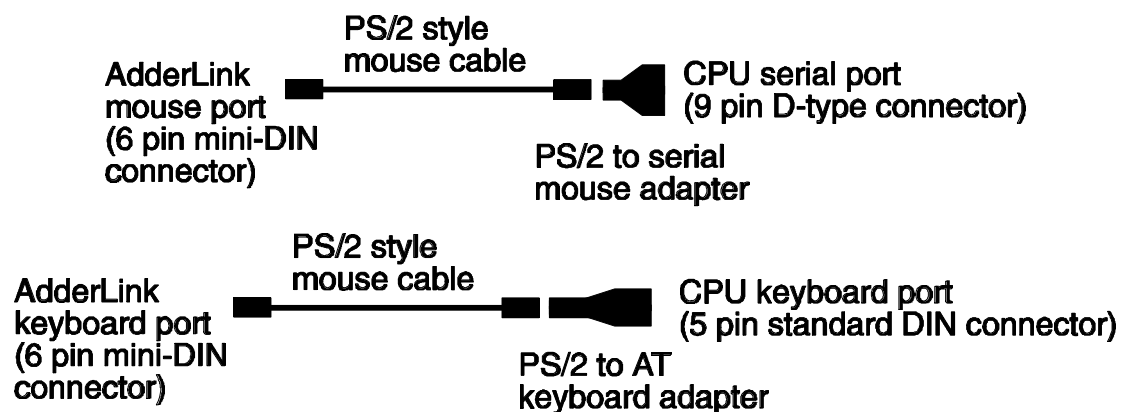

The AdderLink is now ready for use and will start to operate as soon the XL and XR units are both powered on. There is no requirement to switch the AdderLink units on in any defined order. The AdderLink XL unit normally draws its power from the connected computer via the keyboard cable. However, if you are connecting to a computer using cables that are longer than 3 metres or are connecting to a lower powered device, such as some types of keyboard/video/mouse switch, the optional power adapter may be required. When using the optional power adapter, ensure that it is connected to the mains and powering the AdderLink before you switch on the connected computers. Under these circumstances, failure to switch the AdderLink and computers on in the correct order can lead to the mouse and/or keyboard not being recognised by the computers when they are switched on.

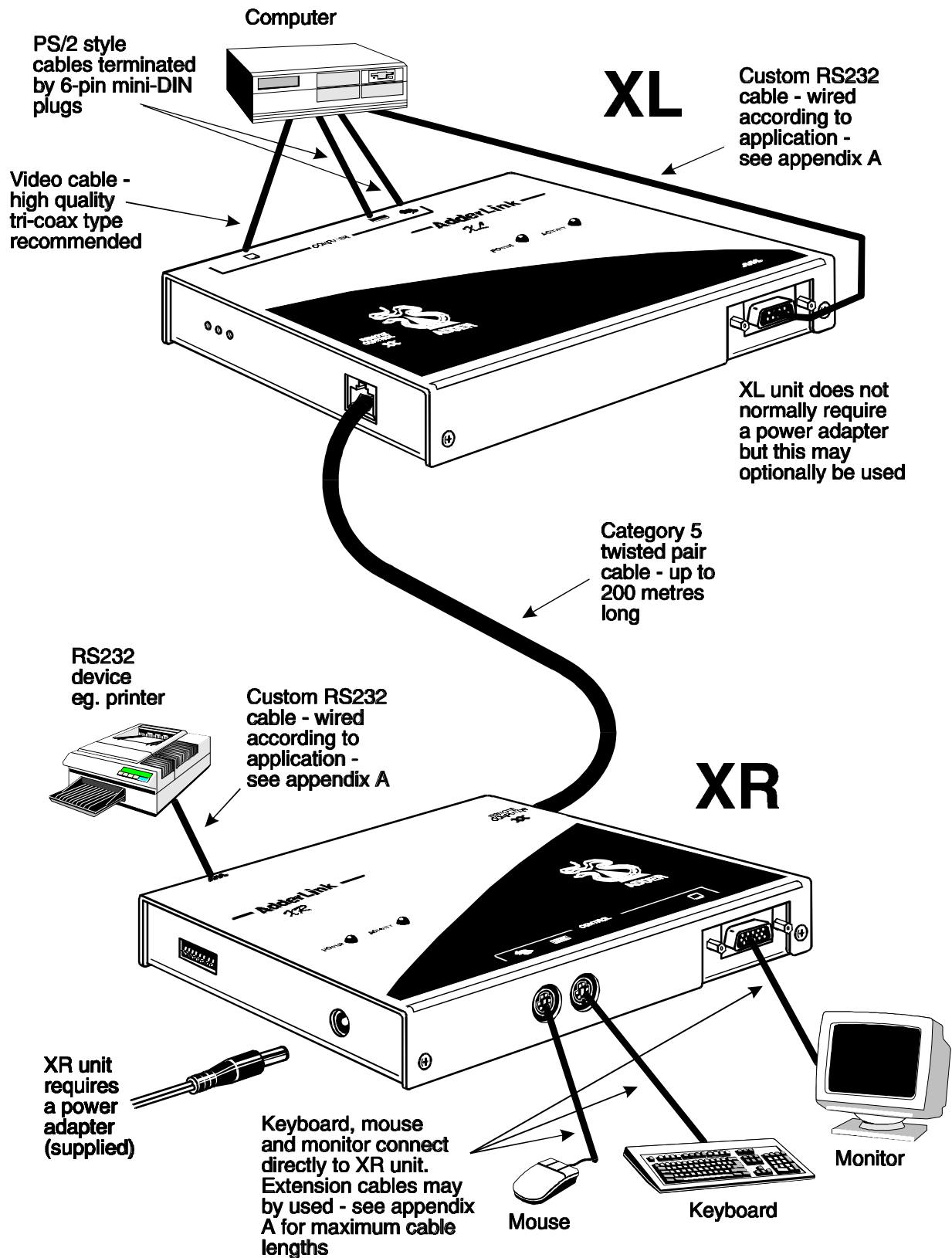

Figure 4 – A typical AdderLink installation

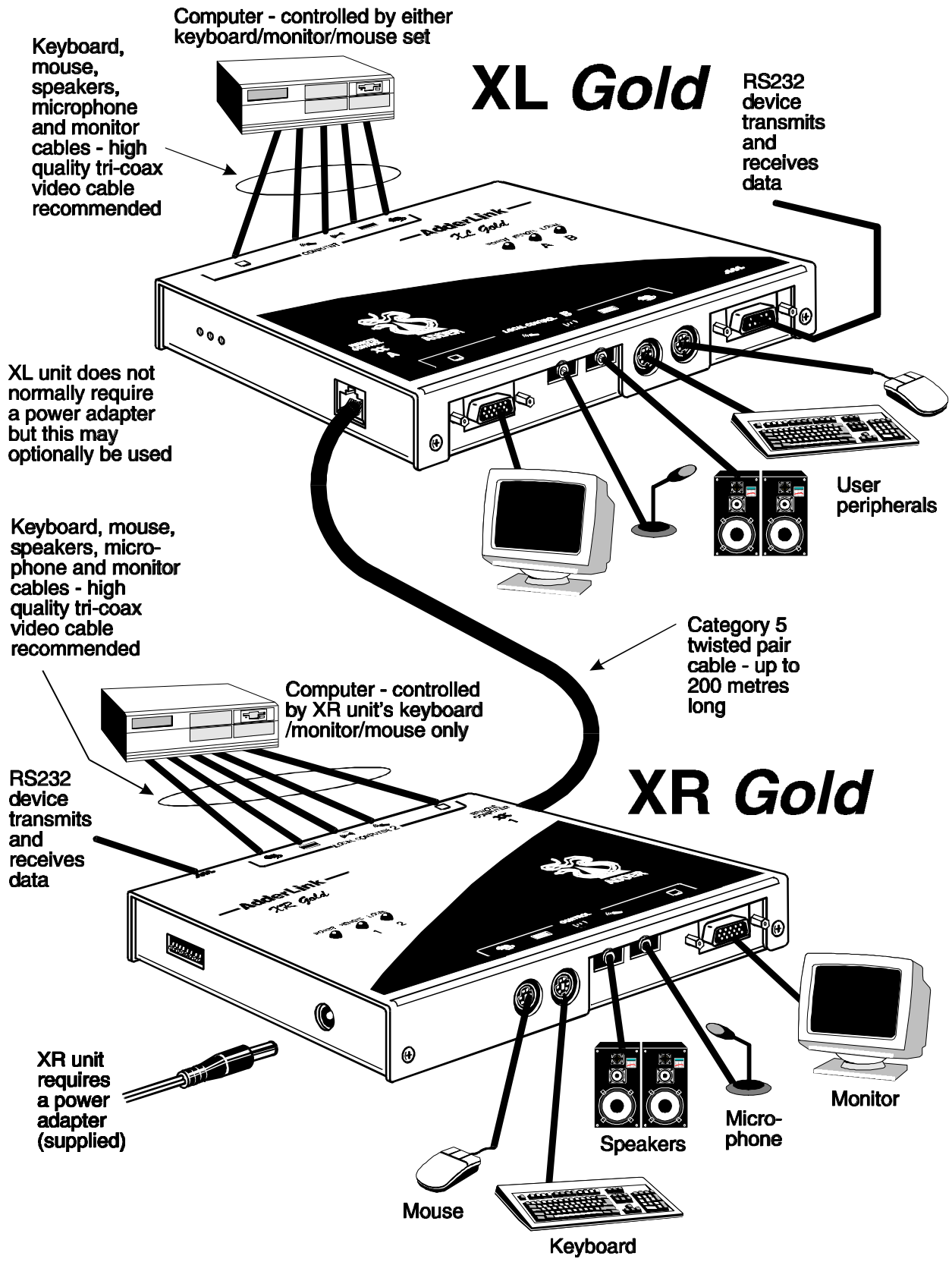

Figure 5 – A typical AdderLink Gold installation

2.4 Configuring your PC(s)

Configure your PC in the same way that you would if your keyboard, mouse, speakers, microphone and monitor were all connected directly to your PC, but bearing in mind the following points:

- AdderLink emulates Microsoft compatible serial, IntelliMouse and PS/2 mice, so ensure that your PC software is configured for a Microsoft mouse of the correct type. Refer to the list of supported drivers in section 2.1.
- AdderLink supports VGA/SVGA/XGA/XGA2 type monitors, but does not support the automatic detection features available with some 'plug and play' monitors and video cards. If you have this type of video card and monitor, you should select the video mode manually instead of relying upon the automatic detection feature.
- The sound quality of the AdderLink Gold's audio speaker channels is maximised by setting the maximum possible audio output level from your PC. You can then adjust the speaker volume to suit.
- The sound quality of the AdderLink Gold's audio microphone channels is maximised by setting the minimum possible audio input level to your PC.

2.5 Configuring the AdderLink

The AdderLink is supplied in a default state that is suitable for most applications except that the video compensation needs to be adjusted to match the characteristics of the twisted pair cable. The video only needs to be compensated once during setup as the compensation value is stored by the AdderLink and retained even when the power is off.

The AdderLink is configured using the following:

1. Option switches (see section 2.7)

The option switches on the side of the AdderLink select the keyboard hotkey combination that is used to access video compensation / configuration mode. They also control some other hardware related functions.

2. Video compensation / configuration mode (see section 2.8)

This mode is entered by typing the hotkey combination (selected using the option switches) on the keyboard attached to the XR receiver. Once within video compensation / configuration mode you can adjust the video compensation and select other options using the keyboard. The selected options are saved and stored in the XR unit when you exit compensation / configuration mode.

2.6 Setting the option switches

The option switches on the side of the AdderLink XR and XL units are used to select operating options. The switches are continuously read by the AdderLink and may be changed whilst the AdderLink is powered on. The default setting (all switches OFF) is suitable for most installations. The switches are shown in figures 6 and 7 and have the following functions.

XR unit - Switches 1 to 5

Reserved – set to OFF position

XR unit - Switches 6 to 8

These switches select the hotkey combinations that are recognised by the AdderLink. The chosen hotkey combinations are used to enter compensation / configuration mode, lock the AdderLink, disable the AdderLink's video and select between local and remote computers on the AdderLink Gold.

XL unit – Switch 1

This switch may be used to reset the XL unit without disconnecting the power. In the OFF position the AdderLink will operate normally. In the ON position the AdderLink will suspend all operation and reset itself to the power off condition. Cycling the switch from the OFF position to the ON position and back to the OFF position again will perform a reset without having to disconnect the keyboard lead and power lead.

XL unit - Switches 2 and 3

Reserved – set to OFF position

XL unit - Switch 4

This switch should normally be set in the OFF position and should only be set ON if you are connecting a laptop computer using a 'Y' cable or adapter. These 'Y' cables and adapters are used to connect a PS/2 mouse and keyboard to the single 6-way

keyboard/mouse port commonly found on the back of laptops. The wiring scheme used on a few of these 'Y' cables confuses the AdderLink into thinking that it is being connected to the computer's serial port and consequently prevents correct operation. When option switch 4 is set to the ON position, RS232 mouse detection is disabled. This enables a computer connected via a 'Y' cable or adapter to be used with the AdderLink without problems.

XL unit – Switch 5

If this switch is set to the ON position then the remote unit will go directly into compensation / configuration mode at power on. This enables a password locked XR unit to be reset. See section 3.10 for further details.

XL unit - Switch 6

This switch controls the video mode on the AdderLink Gold and has no function on the AdderLink. The video picture from the computer connected to the XL unit may be broadcast to the monitor connected to the XL unit and the monitor connected to the XR unit. Alternatively the video picture may be displayed on only one of these monitors at a time. The video picture is directed to the monitor whose keyboard and mouse most recently had control of the computer that is connected to the XL unit. If this switch is set to the OFF position then the video will be broadcast to both monitors. When set to the ON position, video will be sent to the monitor whose associated keyboard and mouse last had control of the XL end's computer.

XL unit - Switches 7 and 8

These switches have no function on the AdderLink. On the AdderLink Gold, the switches select the timeout period for switchover of computer control between the local (XL) and remote (XR) units. The timeout period is the duration of keyboard and mouse inactivity that must be detected before the AdderLink Gold will switch control between the local (XL) and remote (XR) user console. The AdderLink Gold allocates control of the computer to the first keyboard / mouse set (local XL or remote XR) that sends keyboard or mouse data. The other keyboard / mouse set is then prevented from accessing the computer until no keyboard or mouse data has been received for the timeout period. Once a timeout has occurred either keyboard / mouse set may access the computer on a first come first served basis.

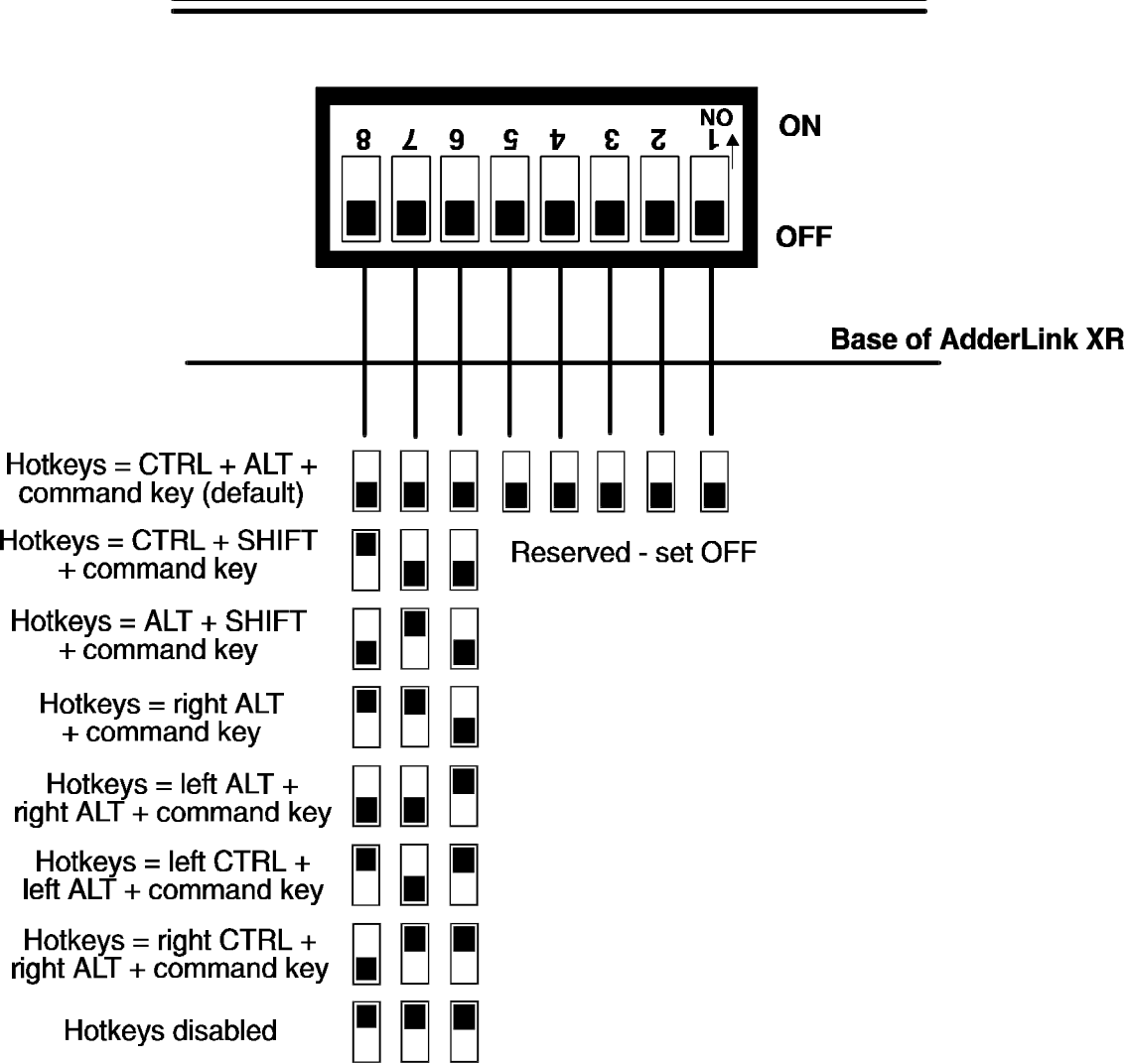

Figure 6 – AdderLink XR option switches (normal and Gold models)

Top of AdderLink XL

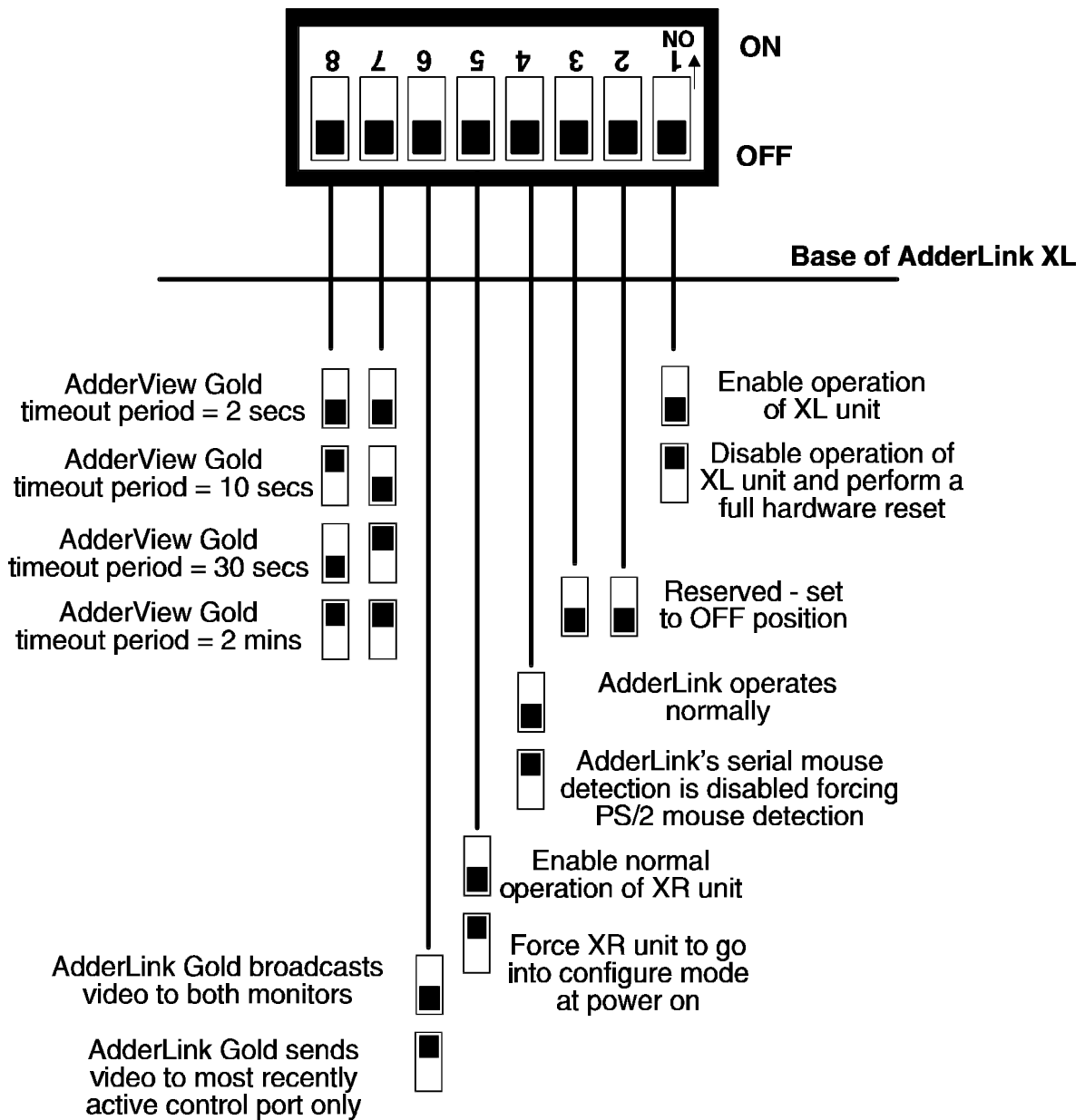



Figure 7 – AdderLink XL option switches (normal and Gold models)

2.8 Setting the video compensation

The AdderLink incorporates fine video compensation amplifiers to maximise the picture quality for any given length of twisted pair cable. When you first plug in your AdderLink you will probably notice that the picture appears blurred or distorted or does not appear at all. The picture quality is maximised by adjusting the video compensation setting. To do this use the following procedure.

STEP 1

Enter video compensation mode by pressing the HOTKEYS together with  on the keyboard connected to the XR receiver unit. The HOTKEYS are those that were set using the option switches (CTRL + ALT by default).

For example, assuming the default hotkeys, press these keys together :



STEP 2

The AdderLink will now be in compensation adjustment mode. This is indicated by the NUM, CAPS and SCROLL lock lights on your keyboard. These will flash in sequence at a rate that indicates the level of compensation: a slow rate of flash indicates a compensation setting suitable for short lengths of twisted pair cable and a fast rate of flash indicates a compensation setting that is suitable for long lengths of twisted pair cable.

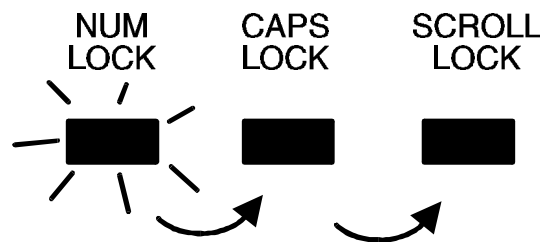

Active light cycles from num to caps to scroll and back to num again - rate of cycling indicates increases with greater levels of video compensation

Press  to select no video compensation.

You should now see a 'fuzzy' video picture on your monitor connected to the XR receiver unit.

STEP 3

You may now use the following keys to select the required video compensation.



Selects no video compensation.



Increases the video compensation (coarse adjustment).



Increases the video compensation (fine adjustment).



Decreases the video compensation (coarse adjustment).



Decreases the video compensation (fine adjustment).

Various other keys may also be used to select operating options (see section 2.10)

As you change the video compensation setting you will see the sharpness of the picture change. The AdderLink calculates the required brightness automatically. You will need more video compensation for longer twisted pair cable distances. Adjust the video compensation until you achieve the best picture. If you add too much compensation then the picture may be lost. If this happens reduce the compensation to restore the picture.

The best compensation setting may be set using the following technique.

- Press  until you observe white trailing edges on the right hand side of black text or graphics.

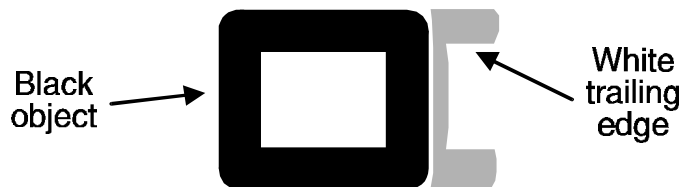

- Press and release  several times until the white trailing edges just disappear.

STEP 4

Press  to exit from compensation mode.

The AdderLink saves the selected video compensation setting when you exit from compensation mode. This setting is retained within the AdderLink even when the power is off and so unless you change the twisted pair cable you will not need to re-adjust the compensation setting again.

2.9 Configuring user-selectable options



The AdderLink supports a number of user-configurable options that change the detailed operation of the AdderLink to match the required application. These may be selected whilst the AdderLink is in video compensation / configuration mode. Whilst within configuration mode the version number of the AdderLink's firmware may also be queried.

To enter configuration mode press the HOTKEYS together with  on the keyboard connected to the XR receiver unit. The HOTKEYS are those that were set using the option switches (CTRL + ALT by default).

For example, assuming the default hotkeys, press these keys together :



Options are then set by pressing a letter key followed by a number key followed by the RETURN key. For example to select an RS232 baud rate of 1200 use the following:

Whilst within configuration mode press   

The num, caps and scroll lock lights will indicate correct acceptance of the command as follows:



- In compensation / configuration the num, caps and scroll lock lights will flash in sequence.
- After pressing the first key of a command sequence the num, caps and scroll lock lights will all be illuminated.
- After pressing the second key of a command sequence the num and caps lock lights will be on and the scroll lock light will be off.
- After pressing RETURN the command will have been accepted and the num, caps and scroll lock lights will go back to flashing in sequence.

When you have finished selecting options, return to normal operation by pressing





2.10 Summary of AdderLink configuration options









Full details of each of the configuration options and their uses are given in section 4.







   - Set RS232 baud rate to 1200 (default) (see section 4.1)







   - Set RS232 baud rate to 9600







   - Query AdderLink firmware version (see section 3.11)















   - Resets all user-configurable options to the default state (see 4.3)







-    - Mouse compatible RS232 protocol (default) – overrides all other RS232 settings (see section 4.1)
-    - RS232 protocol uses hardware handshaking
-    - RS232 protocol uses no handshaking (1200 baud max.)

-    - AdderLink Gold channels are not switchable by a 3-button mouse or IntelliMouse (default) (see section 4.2)
-    - AdderLink Gold channels are switchable by a 3-button mouse or IntelliMouse (see section 4.2)

-    - Reset mouse function (see section 2.12)
-    - Reset IntelliMouse function (see section 2.12)

-   {PASSWORD}  – Sets a security password (see section 3.10)
-    – Clears the security password (see section 3.10)

-    - RS232 protocol uses 1 stop bit (see section 4.1)
-    - RS232 protocol uses 2 stop bits (default)
-    - RS232 protocol uses no parity (default) (see section 4.1)
-    - RS232 protocol uses even parity
-    - RS232 protocol uses odd parity

-    - RS232 protocol uses 7 bits per character (default) (see 4.1)
-    - RS232 protocol uses 8 bits per character

2.11 Other useful installation information

PC boot up sequence - When your PCs are powered on they communicate with any attached keyboards and mice and setup parameters required by the particular operating system. It is necessary for the AdderLink to be attached and powered on during this sequence so that it can give the required responses and keep track of all the modes and settings requested by each of the connected PCs.

Mouse characteristics - do not unplug a PS/2 mouse connection from a PC whilst the PC is on. Due to the design of PS/2 mice communications the mouse function on the PC will be lost and you will have to re-boot the PC to regain normal operation. Unplugging the mouse from the AdderLink will also cause it to stop operating when it is plugged back in. RS232 mice can usually be unplugged and plugged back in provided that a mouse was connected when the operating system initially booted.

Keyboard and mouse mode switching - The AdderLink keeps a log of the keyboard and mouse mode and resolution settings requested by the connected PC(s). These settings are automatically communicated to the keyboard and mouse as required to ensure maximum software compatibility. The keyboard num, caps and scroll lock states are an obvious example of this process.

2.12 Hot plugging the AdderLink into running systems and re-enabling disconnected CPU PS/2 mouse connections

It is advisable to switch off the systems that are going to be connected to the AdderLink before installation. However if this is not possible then most systems can be hot plugged by using the AdderLink's mouse restoration functions. The keyboard connection will normally restore itself automatically.

On many PCs, mouse movement will be lost if the PS/2 mouse is unplugged and plugged back in whilst the PC is running. Mouse movement can then only be restored by rebooting the PC. This is because the mouse drivers only setup and enable the mouse when the PC is initially booted.

If you have switched off your AdderLink or you are attempting to 'hot plug' it into a system that is already running, you may be able to restore lost mouse movement using the AdderLink's mouse restoration functions.

Mouse restoration functions should be used with care as unpredictable results may occur if the wrong mouse type is selected. If in doubt restore the mouse by powering down the PC normally.

Standard PS/2 mouse data uses a different data format to IntelliMouse data and so two reset functions are provided on the AdderLink. The type of data format expected by the PC depends upon the driver and the type of mouse that was connected when the driver was booted. The following table may be used as a guide.

Note that the mouse reset functions predict the likely mouse resolution settings but may not restore the speed or sensitivity of the mouse exactly as they were when the PC originally booted.

Type of mouse / system Connected at bootup	Driver type	Likely expected data format	Suggested restoration
PS/2	PS/2 only	PS/2	F5
PS/2	IntelliMouse	PS/2	F5
IntelliMouse / ADDERview	PS/2 only	PS/2	F5
IntelliMouse / ADDERview	IntelliMouse	IntelliMouse	F6

To restore lost mouse movement on a CPU connected to the AdderLink:

- 1) Ensure that the video picture of the CPU that has lost its mouse movement is displayed on the monitor connected to the XR unit.
- 2) Enter the configuration mode by pressing 'HOTKEYS' and RETURN on the keyboard connected to the XR unit. For example:



- 3) To restore a PS/2 mouse connection press



Or, to restore an IntelliMouse connection press



- 4) Exit from configure mode by typing



- 5) Test the mouse movement by moving the mouse a short distance.

3. Using the AdderLink

This section explains the general operation of the AdderLink. We recommend that you read this section before starting to use the product.

3.1 Power on status

The AdderLink is ready for use as soon as the XR receiver and XL transmitter have been powered on. Remember that the XL transmitter usually draws its power from the computer via the keyboard cable and the XR unit draws its power from the supplied power adapter.

If a security password has not been set then the AdderLink XR unit will power on and immediately establish a link to the remote computer attached to the XL unit. On the AdderLink this is indicated by the activity light illuminating and on the AdderLink Gold this is indicated by the remote (1) light illuminating.

If a security password has been set then the AdderLink XR unit will only illuminate the power light on the XR unit and will not display any video. The AdderLink will indicate that it is waiting for a password to be entered by alternately illuminating the num and scroll lock lights and then the caps lock light on the keyboard attached to the XR receiver unit.

The AdderLink XL unit draws its power from the attached CPU via the keyboard cable. The green power light confirms that there is sufficient power available. If the power light flashes or is off continuously then there is not sufficient power available.

3.2 AdderLink indicator lights

The AdderLink indicator lights have the following meaning

AdderLink XL

Indicator	Colour	Status	Meaning
POWER	Green	ON	AdderLink is on and there is sufficient power available
		OFF	AdderLink is off and sufficient power is not available
		FLASHING	Insufficient power is available (marginal power)
ACTIVITY	Red	ON	Keyboard or mouse data is being received from the XR unit
		OFF	No keyboard or mouse data is being Received from the XR unit
LINK	Orange	ON	The XL unit is connected to an XR unit
		OFF	The XL unit is not connected to an XR unit

AdderLink XR

Indicator	Colour	Status	Meaning
POWER	Green	ON	AdderLink is on
		OFF	AdderLink is off
ACTIVITY	Red	ON	The AdderLink is not locked and no keyboard or mouse data is being received
		FLASHING	The AdderLink is not locked and keyboard or Mouse data is being received
		OFF	The AdderLink is locked or disabled
LINK	Orange	ON	The XR unit is connected to an XL unit
		OFF	The XR unit is not connected to an XL unit

AdderLink Gold XL

Indicator	Colour	Status	Meaning
POWER	Green	ON	AdderLink is on and there is sufficient power available
		OFF	AdderLink is off and sufficient power is not available
		FLASHING	Insufficient power is available (marginal power)
REMOTE A	Red	ON	Keyboard or mouse data has been received from the XR unit and the keyboard and mouse attached to the XR unit have control of the PC
		OFF	The keyboard and mouse attached to the XR unit do not have control of the PC
LOCAL B	Red	ON	Keyboard or mouse data has been received from the keyboard and mouse attached to the XL unit which currently have control of the PC
		OFF	The keyboard and mouse attached to the XL unit do not have control of the PC

AdderLink Gold XR

Indicator	Colour	Status	Meaning
POWER	Green	ON	AdderLink is on
		OFF	AdderLink is off
REMOTE 1	Red	ON	Remote PC attached to XL unit is selected
		OFF	Remote PC attached to XL unit is not selected
		FLASHING	Remote PC is selected and keyboard / mouse data if being received
LOCAL 2	Red	ON	Local PC attached to XR unit is selected
		OFF	Local PC attached to XR unit is not selected
		FLASHING	Local PC is selected and keyboard / mouse data if being received

3.3 Keyboard NUM, CAPS and SCROLL lock indicators

The AdderLink uses the keyboard NUM, CAPS and SCROLL lock lights to indicate various operating conditions as follows:

NUM, CAPS and SCROLL lock lights flash in sequence

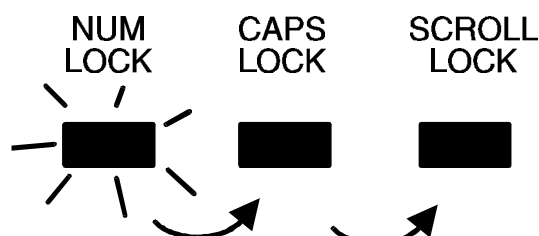

The AdderLink flashes the NUM, CAPS and SCROLL lock lights in sequence on the keyboard connected to the XR unit to indicate that the AdderLink is in video compensation / configuration mode. The NUM lock light comes on first with CAPS and SCROLL off. Then the CAPS lock comes on with NUM and SCROLL off and finally the SCROLL lock comes on with NUM and CAPS off. The rate of flashing indicates the level of video compensation applied by the video compensation amplifiers. A slow flash rate indicates a small amount of compensation (short twisted pair cable distance). A fast flash rate indicates a greater level of video compensation for longer cables.

NUM, CAPS and SCROLL lock lights flash together

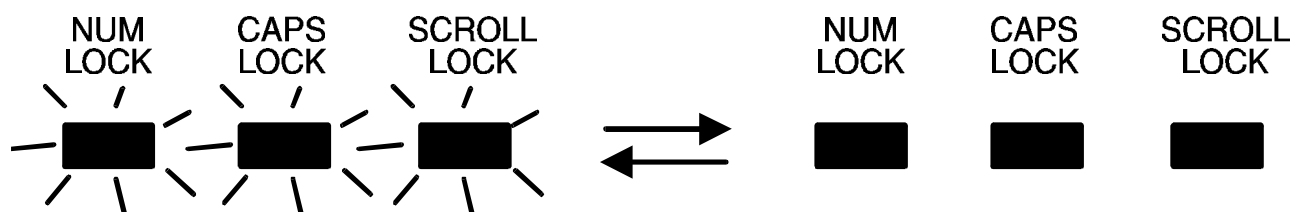

The AdderLink Gold flashes the NUM, CAPS and SCROLL lock light together on the keyboard attached to the XL unit or the keyboard attached to the XR unit to indicate that the other keyboard currently has control of the computer connected to the XL unit. These lights will stop flashing when a timeout has occurred and the computer connected to the XL unit is free for use by either keyboard/mouse set.

NUM and SCROLL lock flash alternately with CAPS lock

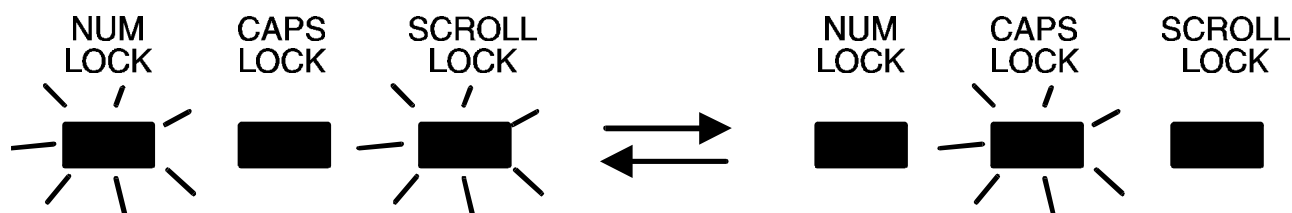

The AdderLink alternately flashes NUM and SCROLL lock and then CAPS lock on the keyboard attached to the XR unit to indicate that the AdderLink is currently locked and is awaiting a password to be entered by the user to unlock the AdderLink.

3.4 Keyboard hotkey control

AdderLink XR unit may be set to respond to various keyboard hotkey combinations. These keyboard hotkeys are selected using the option switches on the side of the AdderLink XR unit (see section 2.7). Keyboard hotkeys may be used to switch off the video, lock the AdderLink and enter video compensation / configuration mode. On the AdderLink Gold the keyboard hotkeys are also used to select between the remote (1) and local (2) computers.

All of the hotkey control commands are invoked by holding down the two hotkeys and then pressing a command key. By default, the two hotkeys are 'CTRL' and 'ALT', although other combinations can be selected by reconfiguring the hotkeys (see section 2.7). Once the hotkey command has been activated you will need to release the hotkeys and the command key before a new hotkey command is accepted by the AdderLink. HOTKEYS + TAB is an exception and this allows you to 'tab through' the ports by holding down the hotkeys and repeatedly pressing TAB.

The hotkey commands are summarised below (**IMPORTANT NOTE: the numbers on the numeric keypad do not form part of a valid hotkey**) :

'HOTKEYS' and '0' – switches off the video signal and all the associated red status lights on the XR unit and disconnects the keyboard and mouse from the computer that they are currently controlling. This will cause some monitors to go into standby mode or switch off. The video signal can be re-enabled by selecting a computer using 'HOTKEYS' and 'TAB' or 'HOTKEYS' and '1' (or 'HOTKEYS' and '2' on the AdderLink Gold) .

'HOTKEYs' and 'L' - Disconnects the AdderLink XR's keyboard and mouse from the computer that they are controlling and switches off all the red status lights. The video signal is switched off. If a password has not been set then the AdderLink can be re-enabled by selecting a computer using 'HOTKEYs' and 'TAB' or 'HOTKEYs' and '1' (or 'HOTKEYs' and '2' on the AdderLink Gold). If a password has been set then the AdderLink will alternately flash the NUM and SCROLL and then the CAPS lock lights on the keyboard connected to the XR unit. This indicates that a valid password must be entered to unlock the AdderLink. Simply type the same key combination as was set during configuration (see section 3.10) followed by the RETURN key. Note - if anyone has typed at the keyboard whilst in secure mode, it will be necessary to type RETURN first to clear the invalid password, then type the valid password followed by RETURN again.

'HOTKEYs' and '1' - selects the remote computer attached to the XL unit

'HOTKEYs' and '2' - selects the local computer attached to the XR unit (AdderLink Gold only)

'HOTKEYs' and 'TAB' – Selects the next computer (remote or local)

'HOTKEYs' and RETURN – Enters video compensation / configuration mode

Examples of common hotkey sequences (assuming CTRL + ALT hotkey option):

To lock the AdderLink

press    release   

To 'tab through' computers (AdderLink Gold):

press    release  press 

release  press  release   

3.5 Contending for control of the XL unit's computer (AdderLink Gold)

Timeout mode

On the AdderLink Gold, the computer attached to the XL unit may be accessed by the control port (Keyboard/Monitor/Mouse/Speakers/Microphone) on the XL unit or the control port on the XR unit. Only one control port may be active at any one time. As soon as keyboard or mouse activity is detected on a control port then this becomes the active control port. Keyboard, mouse or microphone activity on the inactive control port will have no effect on the XL's computer until no keyboard or mouse activity has been detected on the active control port for the timeout period. The timeout period is selected using option switches 7 and 8 on the XL unit (see section 2.6). The video is broadcast to both monitors if option switch 6 is in the OFF position or just to the active control port's monitor if option switch 6 is in the ON position (see section 2.6).

Exclusive use mode

The control port on the XL unit may obtain exclusive use of the XL unit's computer upon demand. To gain exclusive use, the operator uses the following hotkey combinations. Note that these hotkeys are only applicable to the keyboard connected to the XL unit. When exclusive use has been set the video picture from the XL unit's computer will not be sent to the XR unit even if broadcast mode has been selected.

'HOTKEYs' and '1' - Gains exclusive use of the computer attached to the XL unit

'HOTKEYs' and '0' - Relinquishes exclusive use of the computer attached to the XL unit.

3.6 Entering and exiting video compensation / configuration mode

The AdderLink's video compensation and user selectable options and functions are accessed in compensation / configuration mode. To enter this mode press the selected hotkey combination together with the RETURN key and to exit this mode press the RETURN key again. For example:

To enter compensation / configuration mode:



To exit compensation / configuration mode:



3.7 Mouse control

On the AdderLink Gold XR unit, the computers can conveniently be selected using a three button mouse or IntelliMouse. In order to switch to the other computer simply hold down the central mouse button or wheel button and click on the left hand mouse button. The other computer will then be selected. In order to use this feature you must enable it using the M2 option in configuration mode (see section 4.2).

3.8 Stereo audio support on the AdderLink Gold

You may connect stereo speakers to both the AdderLink Gold XL unit and the AdderLink Gold XR unit. Audio from the computer connected to the XL unit is broadcasted to the speakers attached to the XL unit and to the XR unit. The speakers on the XR unit will output the audio signal from the XL unit if the remote computer (1) is selected or the audio from the computer connected to the XR unit if the local computer (2) is selected.

The AdderLink transfers the audio speaker signals between the XL and XR units by multiplexing the audio signals onto the video signals. A small degree of audio noise is introduced by this process. The effect of this noise may be reduced by the following actions:

- Set the speaker output volume on the PC connected to the XL unit to the highest setting available.
- Adjust speaker volume control knob away from the maximum setting.
- Do not boost the audio BASS signal if this can be avoided.

The AdderLink is designed to carry audio signals with a maximum peak-to-peak voltage of 5 volts. This is suitable for most PC audio outputs. If you are sending

audio with a higher peak-to-peak value than 5 volts this may affect the video picture causing temporary loss of the picture during peak audio output. If you are transferring such an audio signal then reduce the PC's maximum output volume setting until the picture remains fully stable.

3.9 Microphone support on the AdderLink Gold

You may connect a microphone to both the AdderLink Gold XL unit and the AdderLink Gold XR unit. The computer attached to the XL unit will take its microphone input from the last active user port. So, if the keyboard and mouse on the XR unit were last used to control the computer then the microphone signal will be taken from the XR unit. Alternatively if the keyboard and mouse connected to the XL unit were the last to control the computer then the microphone signal will come from the microphone attached to the XL unit.

If the local computer (2) is selected on the XR unit then, as expected, its microphone signal will be taken from the microphone attached to the XR unit.

The AdderLink transfers the audio microphone signals between the XR and XL units by multiplexing the audio signals onto the video signals. A degree of audio noise is introduced by this process. The effect of this noise may be reduced by setting the microphone audio input volume on the PC connected to the XL unit to the lowest practical setting.

3.10 Setting and using the security password

There are many situations where unrestricted access to computers or sensitive information needs to be controlled. In such circumstances, the AdderLink XL unit may be locked away in a room or secure cabinet and the computer may be controlled remotely from the XR unit.

The AdderLink incorporates a security password system that enables the XR unit to be locked so that the secure computer cannot be controlled. Once a password has been set the AdderLink XR unit may be disabled by pressing the hotkeys together with the L (lock) key. The XR unit may only then be unlocked by entering the password. For example if the hotkeys are set to CTRL and ALT then pressing the following key combination would cause the AdderLink XR unit to lock.



When the XR unit is locked the video is switched off and the keyboard and mouse are disconnected from the computer. Locking the XR unit does not affect the operation of the XL unit.

To unlock the AdderLink XR unit enter the password followed by the RETURN key eg:

[P] [A] [S] [S] [W] [O] [R] [D] [Enter]

NOTE - The password consists of a combination of key strokes rather like the code to a safe. The key strokes are not case sensitive and can include all the keys on the keyboard (except ctrl, alt, shift and enter). Consequently the following 'password' would be valid:

[F4] [F] [R] [E] [D] [Home]

To set the password, enter configuration mode by typing 'HOTKEYS' and RETURN on the keyboard attached to the XR unit (see section 3.6). When in configure mode type 'P' then RETURN. Now enter the password which may be up to 40 characters. The password is not case sensitive and can be any combination of key strokes, including the function keys, but excluding the CTRL, ALT, SHIFT and RETURN keys. When you have typed in your password type RETURN to register it in the stored memory. Do not worry if you type the password incorrectly, you can always re-enter configure mode and set the password again.

For example, to enter OPENUP as the password type the following whilst in configuration mode:

[P] [Enter] [O] [P] [E] [N] [U] [P] [Enter]

What to do if your AdderLink is locked and you have lost or forgotten the password

If your AdderLink is locked and you have lost or forgotten the password then you may clear the password if you have access to the XL unit. To clear the password power down the XR unit and switch option switch 5 on the XL unit to the on position (see section 2.7). When you next power on the XR unit it will go straight into configuration mode allowing you to clear or change the password. You will then need to set option switch 5 on the XL unit back to its default (off) position or the XR unit will go into configuration mode every time that you switch it on.

3.11 Querying the AdderLink's firmware version

For technical support purposes it is sometimes useful to know the firmware version of the AdderLink. The AdderLink can report its firmware version using a configuration mode function.

To find the firmware version of your AdderLink, connect to a computer that is showing the DOS prompt or is running a text editor or word processor package. On the AdderLink this will be the computer connected to the XL unit. On the AdderLink Gold this may be the computer connected to the XL unit or the computer connected to the XR unit.

It doesn't matter what package this is provided that the characters typed in at the keyboard are displayed on the screen. Enter configuration mode by pressing 'HOTKEYS' and RETURN together (see section 3.6). Now type the following on the keyboard connected to the XR unit:



The version number will be reported on the computer screen as the letter V followed by three numbers. For example, if the AdderLink reports V118 then the firmware version is 1.18.

4. AdderLink configuration options

All the options described in this section are entered in AdderLink's configuration mode - see section 3.6 for instructions on entering configuration mode.

4.1 RS232 protocol options

RS232 serial ports are used for a wide variety of purposes and are typically operated in a number of different modes. A mode that is suitable for one type of device may not be suitable for other devices and so the RS232 protocol supported by the AdderLink may be changed to suit different applications.

Refer to appendix A for suitable cabling for various RS232 applications. Appendix A also shows the signal pinouts for the RS232 ports.

If you are using an RS232 serial mouse connection to any of the CPUs that are connected to the AdderLink then you will need to set the AdderLink into RS232 mouse compatible mode. Setting this mode **overrides all other RS232 protocol settings** and forces 1200 baud, 8 bits per character, 1 stop bit and no handshaking. The AdderLink performs an automatic conversion to convert PS/2 mouse signals to RS232 mouse signals if you use a suitable wiring adapter. If you wish to use an RS232 mouse connection to your PC then we recommend that you use a controlling PS/2 mouse and the RS232 adapter rather than attempting to connect the mouse to the serial ports on the AdderLink. The reason for this is that in the recommended setup the XL unit will continuously emulate the presence of a serial mouse regardless of whether the XR unit is connected and currently powered on . This ensures that PC will reliably bootup regardless of the power and connection state of the AdderLink.

The various RS232 protocol modes may be set using the following options within configuration mode:





- Mouse compatible RS232 protocol (default) – overrides all other RS232 settings





- RS232 protocol uses hardware handshaking





- RS232 protocol uses no handshaking (1200 baud max.)



   - Set RS232 baud rate to 1200 (default)



   - Set RS232 baud rate to 9600



   - RS232 protocol uses 1 stop bit

   - RS232 protocol uses 2 stop bits (default)

   - RS232 protocol uses no parity (default)

   - RS232 protocol uses even parity

   - RS232 protocol uses odd parity

   - RS232 protocol uses 7 bits per character (default)

   - RS232 protocol uses 8 bits per character

4.2 Mouse mode and mouse switching of channels

Mouse switching is only relevant on the AdderLink Gold product where the user connected to the XR unit requires to switch between the remote computer (1) connected to the XL unit and the local computer (2) connected to the XR unit. This may be done by a keyboard hotkey combination or by using a three button PS/2 mouse or an IntelliMouse.

To switch between the remote (1) and local (2) computers, the user simply holds down the central button or wheel button and presses the left hand button to change channel. To use this feature it must first be enabled using the M2 option. To disable this feature use the M1 option.

If the third button is being used to switch the AdderLink XR then it is not available for use with PC software although the function of an IntelliMouse wheel is not affected. Consequently in M2 mode the AdderLink reports to the PCs that a 2 button mouse is connected. If you wish to use the full function of a 3 button mouse or IntelliMouse for your PC software then you should select the M1 option.

The AdderLink supports 'Internet Mice' that are compatible with the Microsoft IntelliMouse. These are fitted with a wheel or other scroll control and sometimes have additional buttons. Examples are:

Microsoft IntelliMouse
Logitech Pilot Mouse +
Logitech MouseMan+
Genius NetMouse
Genius NetMouse Pro

Standard PS/2 and IntelliMouse compatible mice may be connected to the AdderLink. You may configure your CPUs using Microsoft PS/2 or IntelliMouse drivers in any combination as required. The IntelliMouse features are supported on both PS/2 and RS232 CPU connections. When using PS/2 CPU connections, the AdderLink will automatically configure itself to the type of mouse requested by the driver.



- AdderLink Gold XR channels are not switchable by a 3-button Mouse or IntelliMouse (default)



- AdderLink Gold XR channels are switchable by a 3-button mouse or IntelliMouse

4.3 Resetting all configuration options to their default state

To reset all the AdderLink's configuration options to the default state and return all the AdderLink settings to their default state press the following whilst within configuration mode. By resetting all the configuration options to their default state you will also clear the password but you will not change the video compensation setting.



Appendix A. Cable and connector specifications

IMPORTANT NOTE

The maximum cable lengths supported vary widely between devices and cables. It may be possible to use cables that are longer than those specified below with certain PCs and peripherals but this cannot be guaranteed. If you experience problems try using shorter cables.

A1. Keyboard, monitor, mouse, microphone and speakers connections

All of these devices plug directly into the relevant ports of the AdderLink. If you use an AT style keyboard you will need an AT (5 pin DIN female) to PS/2 (6 pin mini-DIN male) converter.

Cable specification for connections to XL unit when used without the optional power adapter

Keyboard, monitor, mouse, speaker and microphone cables should not be longer than 2 metres.

Cable specification for connections to XR unit or to XL unit when used with the optional power adapter

Keyboard, monitor, mouse, speaker and microphone extension cables can be used to increase the distance from the AdderLink up to 10metres. Most keyboards and mice will also operate at distances of 20 metres. If you are using a monitor extension cable then you should ensure that this is a high quality tri-coax type.

A2. Computer connections

Cable specifications:

Video - 15 pin high density male D connector to 15 pin high density male D connector wired as a standard VGA PC to monitor cable. There are two types commonly available. The best type cables which will give excellent quality are

A3. Twisted pair cable

Many types of twisted pair cables are available. You may use unshielded twisted pair (UTP) or shielded twisted pair (STP) cable with the AdderLink. Ensure that the cable you use is of Category 5 or better specification.

The AdderLink uses the following pairs on the twisted pair RJ45 jack connector. If your cable is terminated for networking use then it will probably be wired correctly for the AdderLink. All four twisted pairs within the cable are used by the AdderLink. Electrically, the cables should be wired with pin 1 to pin 1, pin 2 to pin 2, 3 to 3, 4 to 4, 5 to 5, 6 to 6, 7 to 7 and 8 to 8.

BICC Brand - Rex cables are particularly recommended for use with the AdderLink

The usage of the various twisted pairs is shown below:

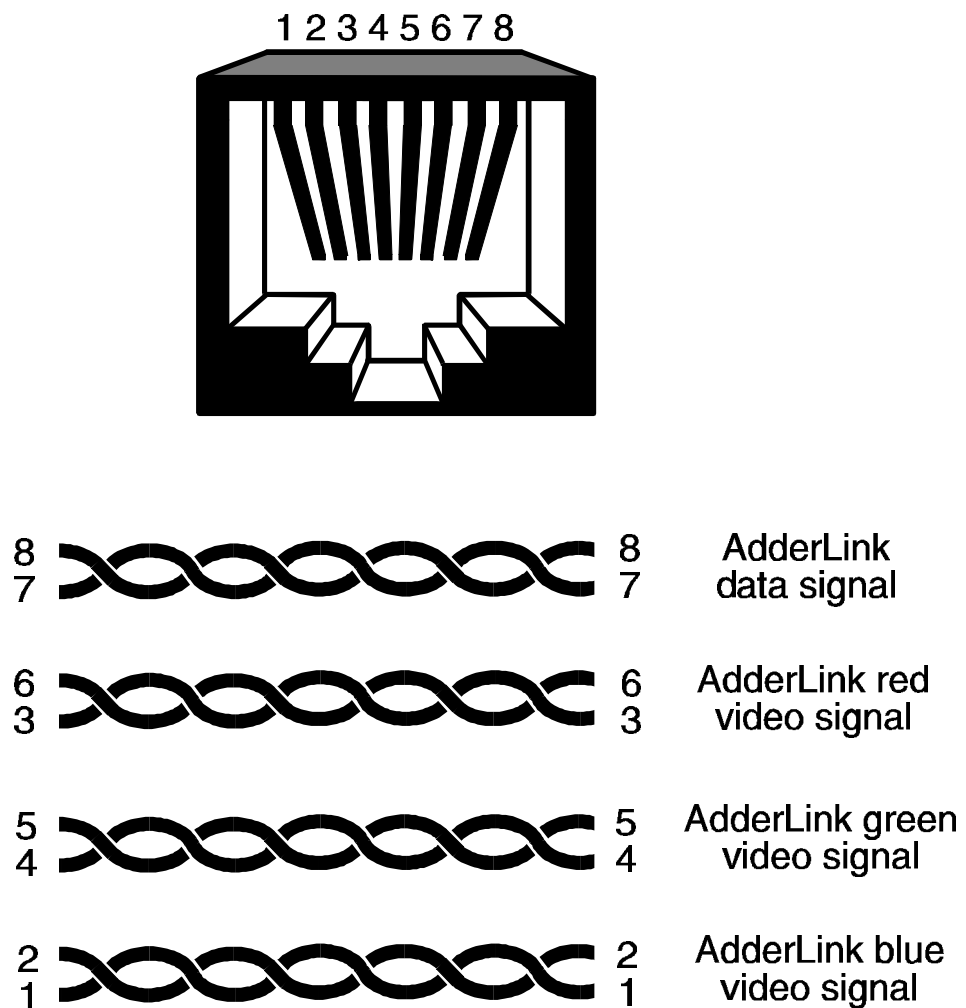

Maximising the video quality for long cable lengths

All twisted pair cables are constructed so that each of the twisted pairs has a slightly different twist rate. This is to reduce the electrical cross-talk between signals travelling on adjacent pairs. This difference in twist frequency effectively means that the wire distance that an electrical signal has to traverse is different for the different pairs. This does not normally cause a noticeable problem but for higher screen resolutions at longer cable lengths a colour separation effect may start to be observed.

In practice most networking cables have one pair of conductors that are significantly more tightly twisted than the other three. Unfortunately this varies between cable types and manufacturers. If you do observe a colour separation effect at high screen resolutions and longer cable lengths then this may be improved by swapping the twisted pairs that are used within the cable. To gain the best results the red, green and blue AdderLink colour signals should be sent over the three pairs that have the closest twist frequency. This normally means that the pair with the tightest twist frequency should be avoided.

If you do not already have a cable and you wish to purchase a suitable cable then this may be purchased from Adder Technology via your supplier. High quality cables are also available that remove this colour separation effect completely.

A4. RS232 port pin assignments

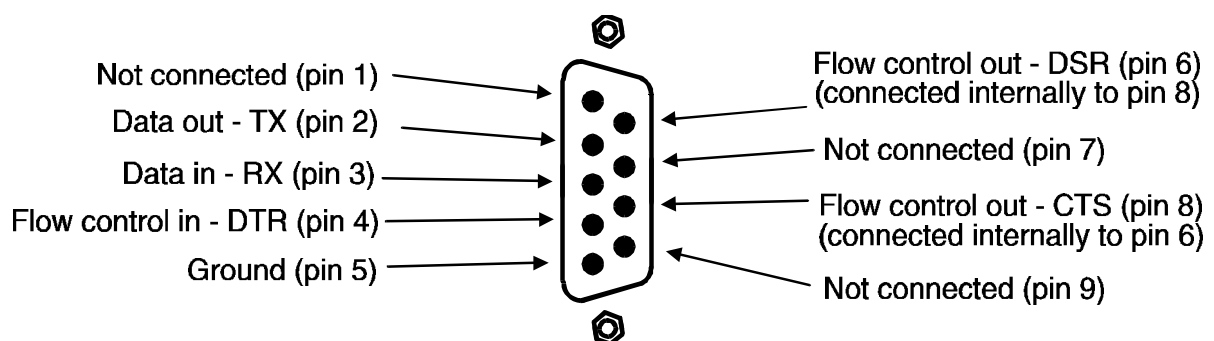

View of AdderLink 9-way D-type female socket

RS232 cables for mouse applications

Computer to AdderLink RS232 cable for RS232 mouse applications	
Computer-end 9-pin female connector	AdderLink-end 9-pin male connector
2	2
3	3
5	5
7	4

Mouse to AdderLink cable / adapter	
Mouse-end 9-pin male connector	AdderLink-end 9-pin male connector
2	3
3	2
4	6
5	5
7	8
6	4
8	7

RS232 cables for printer applications

Computer to AdderLink RS232 cable for RS232 printer applications	
Computer-end 9-pin female connector	AdderLink-end 9-pin male connector
All lines connected straight through 1-1,2-2,3-3 etc.	

AdderLink to printer with 25-way connector	
AdderLink-end 9-pin male connector	Printer-end 25-pin male connector
2	3
3	2
4	20
5	7
6	6
8	5

Appendix B. Problem Solving

Problem:

Video picture is lost during very high audio output.

Action:

Reduce the maximum audio output level

Notes

Notes

ADDER *Link*

INSTALLATION & USE

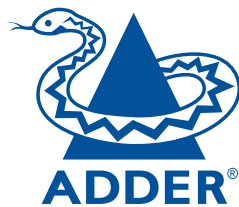

ADDER Technology Limited

Technology House
Trafalgar Way
Bar Hill
Cambridge
CB3 8SQ • England

T: +44 (0) 1954 780044
F: +44 (0) 1954 780081
sales@addertec.com
www.addertec.com

AL-10.02/V2

Download from www.Somanuals.com. All Manuals Search And Download.

Free Manuals Download Website

<http://myh66.com>

<http://usermanuals.us>

<http://www.somanuals.com>

<http://www.4manuals.cc>

<http://www.manual-lib.com>

<http://www.404manual.com>

<http://www.luxmanual.com>

<http://aubethermostatmanual.com>

Golf course search by state

<http://golfingnear.com>

Email search by domain

<http://emailbydomain.com>

Auto manuals search

<http://auto.somanuals.com>

TV manuals search

<http://tv.somanuals.com>