

**Toshiba Personal Computer**  
**Satellite T110/Satellite ProT110/PORTEGE T110**  
**Maintenance Manual**

**TOSHIBA CORPORATION**

File Number 960-Q08

## **Copyright**

© 2009 by Toshiba Corporation. All rights reserved. Under the copyright laws, this manual cannot be reproduced in any form without the prior written permission of Toshiba. No patent liability is assumed with respect to the use of the information contained herein.

Toshiba Personal Computer Satellite T110, Satellite Pro T110, PORTEGE T110  
Maintenance Manual

First edition Sept. 2009

## **Disclaimer**

The information presented in this manual has been reviewed and validated for accuracy. The included set of instructions and descriptions are accurate for the Satellite T110, Satellite Pro T110, and PORTEGE T110 Series at the time of this manual's production. However, succeeding computers and manuals are subject to change without notice. Therefore, Toshiba assumes no liability for damages incurred directly or indirectly from errors, omissions, or discrepancies between any succeeding product and this manual.

## **Trademarks**

Intel, Intel SpeedStep, Intel Core, Pentium and Celeron are trademarks or registered trademarks of Intel Corporation or its subsidiaries in the United States and other countries/regions.

Windows and Microsoft are registered trademarks of Microsoft Corporation.

Other trademarks and registered trademarks not listed above may be used in this manual.

---

## Preface

---

This maintenance manual describes how to perform hardware service maintenance for the Toshiba Personal Computer Satellite T110, Satellite Pro T110, and PORTEGE T110 Series.

The procedures described in this manual are intended to help service technicians isolate faulty Field Replaceable Units (FRUs) and replace them in the field.

### SAFETY PRECAUTIONS

Four types of messages are used in this manual to bring important information to your attention. Each of these messages will be italicized and identified as shown below.

***DANGER:*** “Danger” indicates the existence of a hazard that could result in death or serious bodily injury, if the safety instruction is not observed.

***WARNING:*** “Warning” indicates the existence of a hazard that could result in bodily injury, if the safety instruction is not observed.

***CAUTION:*** “Caution” indicates the existence of a hazard that could result in property damage, if the safety instruction is not observed.

***NOTE:*** “Note” contains general information that relates to your safe maintenance service.

Improper repair of the computer may result in safety hazards. Toshiba requires service technicians and authorized dealers or service providers to ensure the following safety precautions are adhered to strictly.

- Be sure to fasten screws securely with the right screwdriver. If a screw is not fully fastened, it could come loose, creating a danger of a short circuit, which could cause overheating, smoke or fire.
- If you replace the battery pack or RTC battery, be sure to use only the same model battery or an equivalent battery recommended by Toshiba. Installation of the wrong battery can cause the battery to explode.

The manual is divided into the following parts:

- Chapter 1     Hardware Overview describes the Satellite T110, Satellite Pro T110, PORTEGE T110 system unit and each FRU.
- Chapter 2     Troubleshooting Procedures explains how to diagnose and resolve FRU problems.
- Chapter 3     Test and Diagnostics describes how to perform test and diagnostic operations for maintenance service.
- Chapter 4     Replacement Procedures describes the removal and replacement of the FRUs.
- Appendices   The appendices describe the following:
- Handling the LCD Module
  - Board layout
  - Pin assignments
  - Keyboard scan/character codes
  - Key layout
  - Wiring diagrams

## Conventions

This manual uses the following formats to describe, identify, and highlight terms and operating procedures.

### *Acronyms*

On the first appearance and whenever necessary for clarification acronyms are enclosed in parentheses following their definition. For example:

Read Only Memory (ROM)

### *Keys*

Keys are used in the text to describe many operations. The key top symbol as it appears on the keyboard is printed in **boldface** type.

### *Key operation*

Some operations require you to simultaneously use two or more keys. We identify such operations by the key top symbols separated by a plus (+) sign. For example, **Ctrl + Pause (Break)** means you must hold down **Ctrl** and at the same time press **Pause (Break)**. If three keys are used, hold down the first two and at the same time press the third.

### *User input*

Text that you are instructed to type in is shown in the boldface type below:

**DISKCOPY A: B:**

### *The display*

Text generated by the computer that appears on its display is presented in the typeface below:

Format complete  
System transferred

---

# Table of Contents

---

## Chapter 1 Hardware Overview

1.1	Features .....	1
1.2	System Block Diagram .....	6
1.3	2.5-inch Hard Disk Drive.....	9
1.4	Keyboard.....	12
1.5	TFT Color Display .....	13
	1.5.1 LCD Module with CCFL Backlight .....	13
1.6	Power Rails .....	14
1.7	Batteries .....	15
	1.7.1 Main Battery .....	15
	1.7.2 Battery Charging Control.....	15
	1.7.3 RTC battery.....	17
1.8	AC Adapter .....	18

## Chapter 2 Troubleshooting Procedures

2.1	Troubleshooting .....	1
2.2	Troubleshooting Flowchart.....	2
2.3	Power Supply Troubleshooting.....	6
	Procedure 1 Power Status Check .....	6
	Procedure 2 Connection Check.....	8
	Procedure 3 Charging Check .....	8
	Procedure 4 Replacement Check .....	10
2.4	System Board Troubleshooting.....	11
	Procedure 1 Message Check .....	12
	Procedure 2 Debugging Port Check.....	13
	Procedure 3 Replacement Check .....	13
2.5	Hard Disk Drive Troubleshooting .....	14
	Procedure 1 Partition Check .....	14
	Procedure 2 Message Check .....	15
	Procedure 3 Diagnostic Test Program Execution Check .....	16
	Procedure 4 Connector Check and Replacement Check.....	17
2.6	Keyboard Troubleshooting .....	18
	Procedure 1 Diagnostic Test Program Execution Check .....	18
	Procedure 2 Connector Check and Replacement Check.....	19
2.7	Touch pad Troubleshooting .....	20
	Procedure 1 Diagnostic Test Program Execution Check .....	20
	Procedure 2 Connector Check and Replacement Check.....	21
2.8	Display Troubleshooting.....	22
	Procedure 1 External Monitor Check.....	22
	Procedure 2 Diagnostic Test Program Execution Check .....	22
	Procedure 3 Connector and Cable Check .....	23
	Procedure 4 Replacement Check .....	24
2.9	LAN Troubleshooting.....	25
	Procedure 1 Diagnostic Test Program Execution Check .....	25

	Procedure 2 Connector Check and Replacement Check.....	25
2.10	Wireless LAN Troubleshooting.....	26
	Procedure 1 Transmitting-Receiving Check.....	26
	Procedure 2 Antennas' Connection Check.....	27
	Procedure 3 Replacement Check.....	28
2.11	Sound Troubleshooting.....	29
	Procedure 1 Connector Check.....	29
	Procedure 2 Replacement Check.....	30
2.12	Bluetooth Troubleshooting.....	31
	Procedure 1 Connector Check and Replacement Check.....	31
2.13	HDMI Troubleshooting.....	32
	Procedure 1 Connector Check and Replacement Check.....	32
	Procedure 2 External Monitor Check.....	32
	Procedure 3 Connector and Cable Check.....	33
	Procedure 4 Replacement Check.....	34
2.14	Memory Troubleshooting.....	35
	Procedure 1 Diagnostic Test Program Execution Check.....	35
	Procedure 2 Connect Check and Replacement Check.....	35
2.15	3G Troubleshooting.....	36
	Procedure 1 Connect Check and Replacement Check.....	36
2.16	Camera Troubleshooting.....	37
	Procedure 1 Camera Execution Check.....	37
	Procedure 2 Connect Check and Replacement Check.....	37
2.17	Microphone Troubleshooting.....	38
	Procedure 1 Sound Recorder Execution Check.....	38
	Procedure 2 Connect Check and Replacement Check.....	38
2.18	CRT Troubleshooting.....	39
	Procedure 1 External Monitor Check.....	39
	Procedure 2 Connector and Cable Check.....	39
	Procedure 3 Replacement Check.....	39
2.19	USB Troubleshooting.....	40



	Procedure 1 Diagnostic Test Program Execution Check .....	40
	Procedure 2 Connect Check and Replacement Check .....	40
2.20	LED Troubleshooting .....	41
	Procedure 1 Each function Execution Check.....	41
	Procedure 2 Connect Check and Replacement Check .....	41

## Chapter 3 Diagnostic Programs

3.1	Tests and Diagnostics Software Overview .....	2
3.2	Executing the Diagnostic Test .....	3
3.3	Subtest names.....	7
3.4	System Test.....	10
3.5	Memory Test.....	17
3.6	Keyboard Test.....	21
3.7	Display Test .....	24
3.8	Hard Disk Test .....	39
3.9	Real Time Clock Test .....	42
3.10	Cache Memory Test.....	44
3.11	High Resolution Display Test.....	46
3.12	Multimedia Test .....	52
3.13	MEMORY2 Test.....	53
3.14	Error Codes and Error Status Names .....	55
3.15	Running Test.....	57
3.16	DMI INFOEMATION .....	58
	3.16.1 Check DMI Information .....	58
	3.16.2 Write DMI Information.....	58
3.17	Log Utilities .....	60
	3.17.1 Operations .....	60
3.18	System Configuration .....	62
3.19	Running Test Edit Item.....	63
	3.19.1 Function Description.....	63
	3.19.2 Operation Description.....	63
3.20	Common Tests and Operation .....	65
	3.20.1 How to operate a window .....	65
	3.20.2 How to Stop the Test Program.....	65
	3.20.3 Test Status Screen .....	65
	3.20.4 Test Stop Display.....	66
	3.20.5 How to enter data.....	66

## Chapter 4 Replacement Procedures

4.1	Overview.....	1
	Safety Precautions.....	2
	Before You Begin .....	3
	Disassembly Procedure.....	4
	Assembly Procedure.....	5
	Tools and Equipment .....	5
	Screw Tightening Torque.....	6
	Screw Notation .....	7
4.2	Battery pack .....	8
4.3	HDD .....	11
4.4	Memory Module .....	14
4.5	Keyboard.....	17
4.6	Wireless LAN card and BT Module.....	20
4.7	3G Module card .....	22
4.8	Display Assembly .....	23
4.9	Top Cover Assembly .....	31
4.10	Touch pad.....	35
4.11	I/O boards.....	38
4.12	System Board .....	39
4.13	CPU .....	45
4.14	LCD unit .....	47
4.15	Web Camera Module .....	51
4.16	Application for Thermal grease on CPU and North Bridge .....	53
4.17	Speaker Box .....	55
4.18	HDD cable .....	57

## **Appendix**

Appendix A	Handling the LCD Module .....	1
Appendix B	Board Layout .....	1
Appendix C	Pin Assignments.....	1
Appendix D	Keyboard Scan/Character Codes .....	1
Appendix E	Key Layout.....	1
Appendix F	Wiring Diagrams.....	1

---

# Chapter 1

## Hardware Overview

---

---

## **Chapter 1      Contents**

---

1.1	Features .....	1
1.2	System Block Diagram .....	5
1.3	2.5-inch Hard Disk Drive.....	8
1.4	Keyboard.....	11
1.5	TFT Color Display .....	12
1.6	Power Rails .....	13
1.7	Batteries .....	14
	1.7.1   Main Battery .....	14
	1.7.2   Battery Charging Control .....	15
	1.7.3   RTC battery .....	16
1.8	AC Adapter .....	17

**Figures**

Figure 1-1-1	Left of the computer.....	3
Figure 1-1-2	Right of the computer .....	4
Figure 1-2-1	System Block Diagram for Intel Platform .....	5
Figure 1-3-1	2.5-inch HDD .....	9
Figure 1-4-1	Keyboard for US Style.....	12
Figure 1-5-1	LCD Module.....	13

**Tables**

Table 1-3-2	2.5-inch HDD dimensions .....	9
Table 1-3-3	2.5-inch HDD Specification.....	10
Table 1-5-2	LCD module specifications.....	12
Table 1-6-1	CULV Power supply output rating .....	13
Table 1-7-1	Battery specifications .....	14
Table 1-7-2	Time required for charges of main battery .....	15
Table 1-7-3	Data preservation time .....	15
Table 1-7-4	Time required for charges of RTC battery.....	16
Table 1-8-1	AC adapter specifications .....	17

## **1.1 Features**

The Satellite T110/Satellite Pro T110/PROTÉGÉ T100 (Intel Platform) features are listed below.

### Microprocessor

Microprocessor that is used will be different by the model.

It supports processors as follows

Intel® Core™2 Duo ULV CPU

SU2700 1.30GHz

CPU(956P)743 1.3G

### Memory

Two DDRIII SO-DIMM (800MHz specification compliant) used and be up to 4GB which can be upgraded through Memory Module Slot. Maximum upgradeable system memory may depend on the model

### VRAM

Shared with System RAM for Intel GS40.

### HDD

5400RPM: 250GB, 320GB, 500GB, internal drives. 2.5 inch x 9.5mm height.

### Display

#### LCD

11-inch, 256.125(H) X 144.0(V) WXGA+ 262,144 colors + LED, High-brightness, amorphous silicon TFT color display.

#### CRT

Supported via a RGB connector.



### Keyboard

Keyboard module has 85 or 86 keys and support optional Windows and application Keys

### Battery

The RTC battery is equipped inside the computer.

The main battery is a detachable lithium ion battery.

6 cell Li-Ion 10.8v/4800mAh

### USB (Universal Serial Bus)

3 USB ports are provided. The ports comply with the USB2.0 standard. USB Sleep and Charge function can be supported by only one port of the left side. (Mode 1-4).If USB Sleep and Charge function is enabled, the computer's battery will discharge during hibernation or when the computer is turned off. It is recommended that user connect the AC adaptor to the computer when enabling the USB Sleep and Charge function.

### Sound system

Internal stereo speaker, Internal MIC (Option) external monaural microphone connector, stereo headphone connector.

### Wireless LAN

Some computers in this series are equipped with a Wireless LAN card.

### LAN

The computer has built-in support for Ethernet LAN (10 megabits per second, 10BASE-T) and Fast Ethernet LAN (100 megabits per second, 100 BASE-TX)

### Bridge Media Slot

SD/SDHC/MS/MS pro/xD/MMC are supported.

### Bluetooth

Some computers in this series offer Bluetooth wireless communication functionality. This module is Version 2.1+EDR.

Security

Kensington Lock,

Hard Disk Drive Password

3D Accelerometer for Hard Disk Drive



- 1. Extend Monitor connector
- 2. FAN HOLE
- 3. Bridge Media Slot
- 4. HDMI out port
- 5. USB port (USB Sleep and Charge function is supported by this port only.)
- 6. Web Camera
- 7. Microphone
- 8. Display Screen
- 9. Keyboard
- 10. Touch Pad
- 11. Touch Pad Control Right Buttons
- 12. Touch Pad Control Light Buttons
- 13. LED light indicator
- 14. Power Button

*Figure 1-1-1 Left of the computer*



- 1. Headphone Jack
- 2. Microphone jack
- 3. USB port
- 4. LAN jack
- 5. DC-IN jack

Figure 1-1-2 Right of the computer

## 1.2 System Block Diagram

Figure 1-2-1 shows the system block diagram.

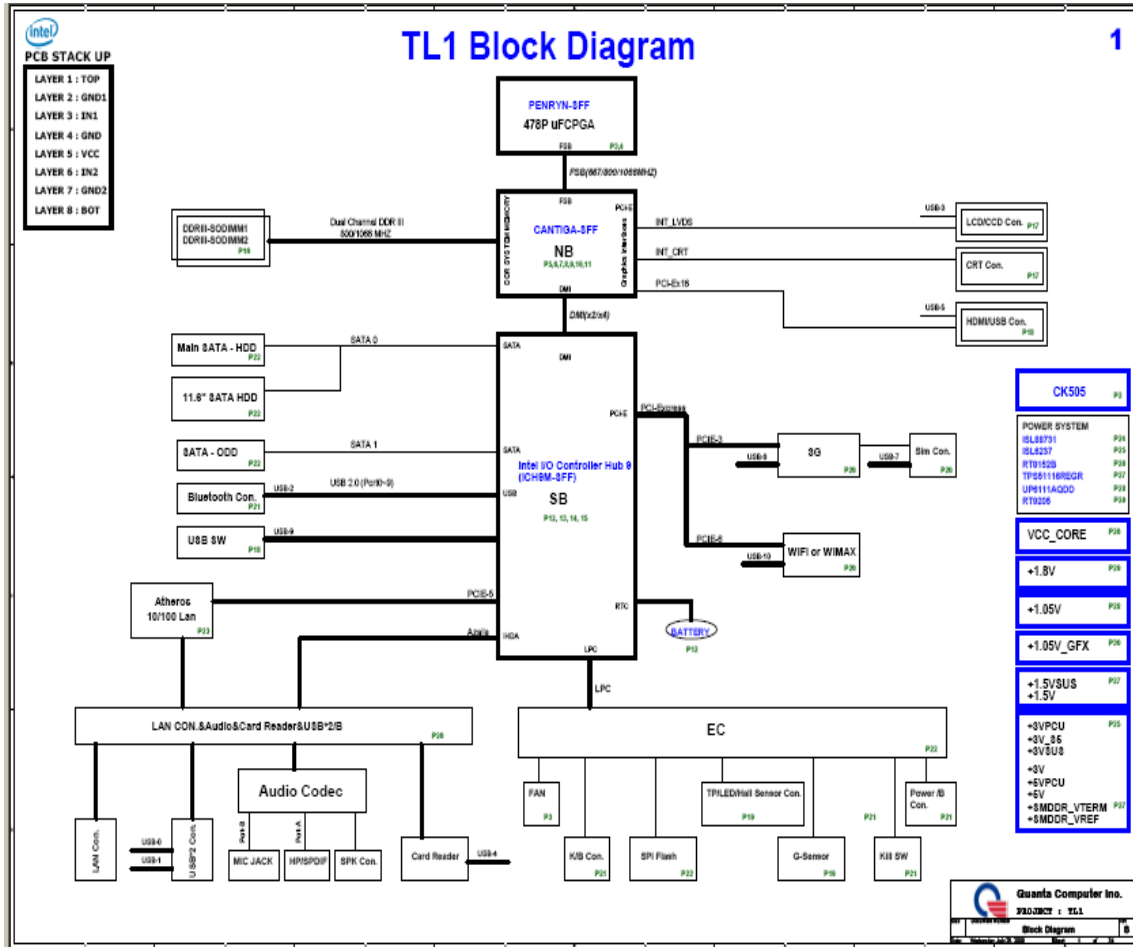

Figure 1-2-1 System block diagram for Intel Platform

The PC contains the following components.

### CPU

Intel® Core™2 Duo ULV CPU

SU2700 1.30GHz

CPU(956P)743 1.3G

### Memory

Two memory slots capable of accepting DDRIII-SDRAM 1GB, 2GB or 4GB memory modules for a maximum of 4GB.

- 204-pin SO-DIMM
- 1.5V operation

BIOS ROM (Flash memory)

- 16Mbit

### Chipset

This gate array has the following elements and functions.

- North Bridge (Intel GS40)
  - Penryn processor System Bus support
  - DRAM Controller: DDR3-1333/1066/800 support
    - \* 1333/1066 memory module runs at 800MHz
  - DMI
  - 1365-ball 27 x 25mm Micro FC-BGA Package
- South Bridge (ICH9M-E SFF)
  - Direct Media Interface (DMI)
  - PCI Express
  - Serial ATA (SATA) Controller
  - PCI Interface
  - Low Pin count (LPC) interface
  - Serial Peripheral Interface (SPI)
  - DMA controller
  - Advanced Programmable Interrupt Controller (APIC)
  - USB Controllers

- USB Controllers
- RTC
- GPIO
- Enhanced Power Management
- SMBus 2.0
- High Definition Audio Controller
- 569-pin 16mmx16mm mBGA Package

Other main system chips

- Clock Generator (CULV Platform: ICS9LPRS365BKLFT)
- EC/KBC –[W/CIR(Winbond WPCE775CA0DG)]
- HD Audio (CONEXANT CX20582-11Z)
- Card Reader controller (REALTEAK RTS5159 )
- 10/100 LAN controller (Atheros AR8132M)

Mini Card

Wireless LAN (BTO)

IEEE802.11b/g or IEEE802.11b/g/n

Wireless WAN (BTO)

HSPA

Blue tooth

Bluetooth V2.1+EDR. (BTO)

### 1.3 2.5-inch Hard Disk Drive

A compact, high-capacity HDD with a height of 9.5mm contains 2.5-inch magnetic disks and magnetic heads.

Figure 1-3-1 shows a view of the 2.5-inch HDD and Tables 1-3-2 and 1-3-3 list the specifications.

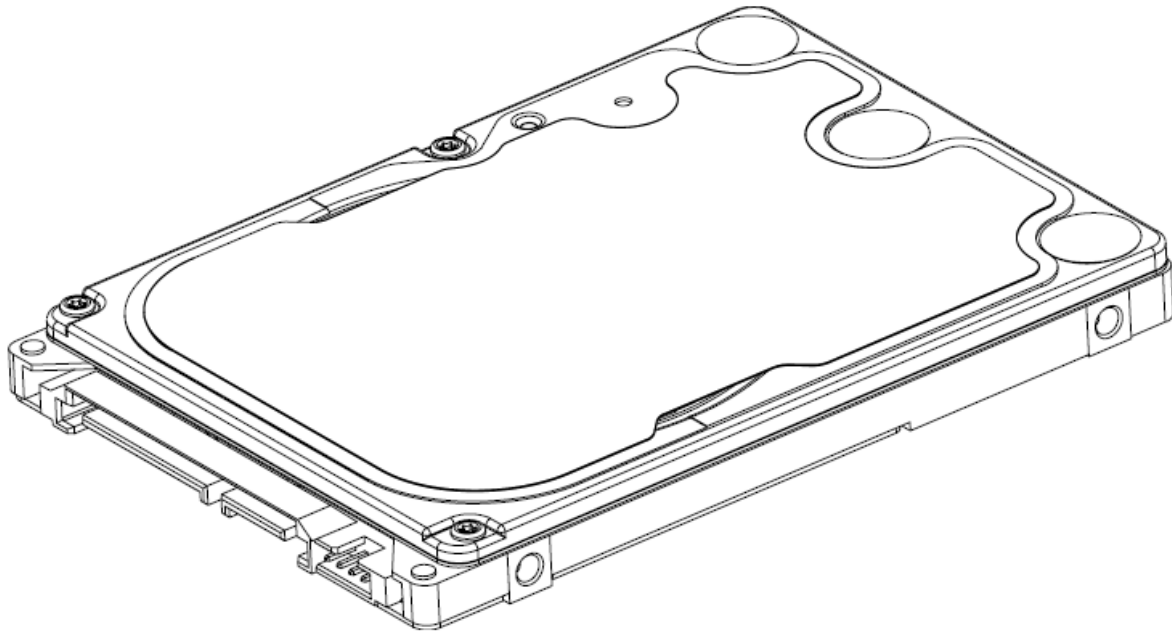

Figure 1-3-1 2.5-inch HDD

Parameter		Standard value		
		TOS MK2555GSX	TOS MK3255GSX	TOS MK5055GSX
Outline dimensions	Width (mm)	69.85		
	Height (mm)	9.5		
	Depth (mm)	100		
	Weight (g)	97/98/101/102		

Parameter		Standard value		
		HTS545025B9A300	HTS545032B9A300	HTS545050B9A300
Outline dimensions	Width (mm)	69.85		
	Height(mm)	9.5		
	Depth (mm)	100		
	Weight (g)	101(Max)		

Parameter		Standard value	
		WD2500BEVT-26ZCT0	WD3200BEVT-26ZCT0
Outline dimensions	Width (mm)	69.85	
	Height (mm)	9.5	
	Length (mm)	100.0	
	Weight (g)	99(Max)	

Table 1-3-2 2.5-inch HDD dimensions

Parameter	Specification		
	TOS MK2555GSX	TOS MK3255GSX	TOS MK5055GSX
Storage size (formatted)	250GB	320GB	500GB
Speed (RPM)	5400		
Data transfer Rate - To/From Media - To/From Host	363~952MB/S 3GB/S		
Bus Transfer Rate	3GB/S		
Average random seek time (read) (ms)	12		
Power-on-to-ready (sec)	3.5(typ)/9.5(Max)		

Parameter	Specification		
	HTS545025B9A300	HTS545032B9A300	HTS545050B9A300
Storage size (formatted)	250GB	320GB	500GB
Speed (RPM)	5400		
Data transfer Rate - To/From Media - T0/From Host	363~952MB/S 3GB/S		
Bus Transfer Rate	3GB/S		
Average random seek time (read) (ms)	12		
Power-on-to-ready (sec)	3.5		



Parameter	Specification	
	WD2500BEVT-26ZCT0	WD3200BEVT-26ZCT0
Storage size (formatted)	250GB	320GB
Speed (RPM)	5,400	
Data transfer Rate - To/From Media - T0/From Host	933MB/s Max. 3Gb/s	
bus transfer rate	3Gb/s	
Average random seek time (read) (ms)	12.0ms/13.0ms	
Power-on-to-ready (sec)	4.0 (typ)	

Table 1-3-3 2.5-inch HDD Specification

## 1.4 Keyboard

The Satellite T110, Satellite Pro T110, and PORTEGE T110 keyboard is for US style

Figure 1-4-1 is a view of the keyboard for US style

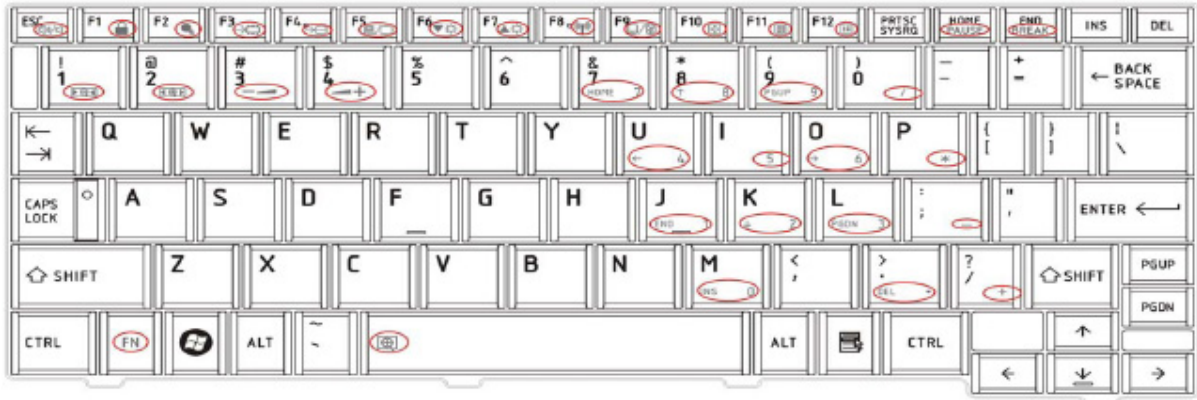

Figure 1-4-1 Keyboard for US style

See Appendix E for details of the keyboard layout

## 1.5 TFT Color Display

The Satellite T110 use LED to control backlight.

### LCD Module

Figure 1-5-1 shows a view of the LCD module and Table 1-5-2 lists the specifications.

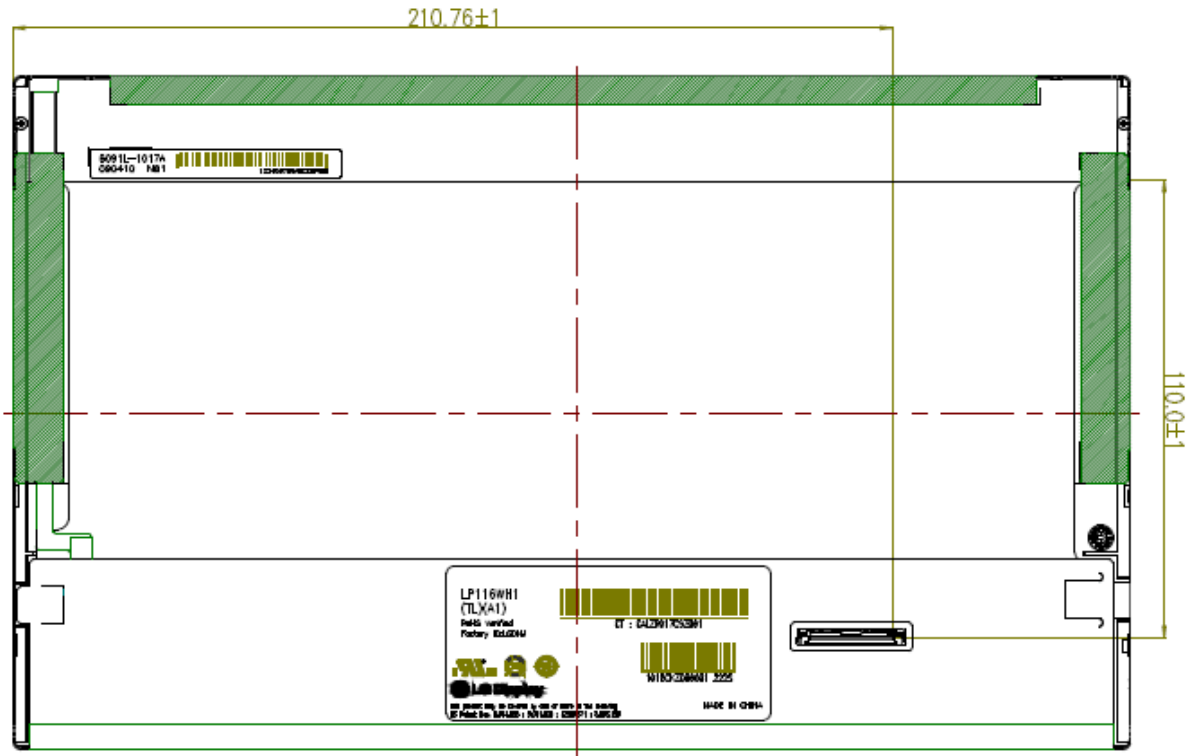

Figure 1-5-1 LCD Module

Item	Specifications(WXGA+)			
	SAMSUNGA LTN116AT01-T01	CHI MEI N116B6-L02	LG LP116WH1-TLA1	AUO B116XW02 V0
Number of Dots	1,366 x 3(R,G,B) x 768	1,366 x 3(R,G,B) x 768	1,366 x 3(R,G,B) x 768	1,366 x 3(R,G,B) x 768
Dot spacing (mm)	0.2265(H)× 0.2265(V)	0.1875(H)× 0.1875(V)	0.1875(H)× 0.1875(V)	0.1875(H)× 0.1875(V)
Display Colors	262,144 colors	262,144 colors	262,144 colors	262,144 colors

Table 1-5-2 LCD module specifications

## 1.6 Power Rails

Table 1-6-1 lists the power rail output specifications of CULV platform.

Name	Power supply (Yes/No)			
	Voltage [V]	Power OFF Suspend mode	Power OFF Boot mode	No Battery
+5VPCU	5	Yes	Yes	No
+5V	5	No	No	No
+3VPCU	3.3	Yes	Yes	No
+3V_S5	3.3	Yes	No	No
+3VSUS	3.3	Yes	No	No
+3V	3.3	No	No	No
+1.8VSUS	1.8	Yes	No	No
+SMDDR_VTERM	1.8	Yes	No	No
+SMDDR_VREF	1.8	Yes	No	No
+1.8V	1.8	No	No	No
+1.5V	1.5	No	No	No
+1.2V	1.25	No	No	No
+1.05v	1.05	No	No	No
+NB_CORE	1.0~1.2	No	No	No
VCC_CORE	0.7~1.2	No	No	No

Table 1-6-1 CULV Power supply output rating

## 1.7 Batteries

The PC has the following two batteries.

- Main battery
- Real time clock (RTC) battery

Table 1-7-1 lists the specifications for these two batteries.

Battery Name		Battery Element	Output Voltage
Main battery	6 Cells	Lithium ion	10.8 V
Real time clock (RTC) battery	COIN Type	Lithium ion	3V

*Table 1-7-1 Battery specifications*

### 1.7.1 Main Battery

The main battery is the primary power supply for the computer when the AC adapter is not connected. In Standby, the main battery maintains the current status of the computer.

### 1.7.2 Battery Charging Control

Battery charging is controlled by a power supply microprocessor. The power supply microprocessor controls power supply and detects a full charge when the AC adaptor and battery are connected to the computer.

#### Battery Charge

When the AC adapter is connected, normal charging is used while the system is turned on and quick charge is used while the system is turned off. Refer to the following Table 1-7-2.

	Power ON	Power OFF
6 cell	5 ~ 10 hours	about 5 hours

*Table 1-7-2 Time required for charges of main battery*

Charge is stopped in the following cases.

1. The main battery is fully charged
2. The main battery is removed
3. Main battery or AC adapter voltage is abnormal
4. Charging current is abnormal

#### Data preservation time

When turning off the power in being charged fully, the preservation time is as following Table 1-7-3.

	Sleep	Shut down
6 cell	About 3 days	About 30 days

*Table 1-7-3 Data preservation time*

### **1.7.3 RTC Battery**

The RTC battery provides the power supply to maintain the date, time, and other system information in memory.

Table 1-7-4 lists the Time required for charges of RTC battery and data preservation time.

<b>Condition</b>	<b>Time</b>
Charging time	About 24 hours
Data retaining time	About 30 days

*Table 1-7-4 Time required for charges of RTC battery*

## 1.8 AC Adapter

The AC adapter is used to charge the battery.

Table 1-8-1 lists the AC adapter specifications.

Parameter	Specification	
	DELTA/ LITE-ON 3pin	DELTA/ LITE-ON 2pin
With Led		
Power	65W	65W
Input voltage	AC 100V/240V	
Input frequency	50Hz/60Hz	
Input current	$\leq 1.5A$	
Output voltage	DC 19V	
Output current	3.42A	3.42A

*Table 1-8-1 AC adapter specifications*



---

# **Chapter 2**

# **Troubleshooting Procedures**

---

---

## **Chapter 2      Contents**

---

2.1	Troubleshooting .....	1
2.2	Troubleshooting Flowchart.....	2
2.3	Power Supply Troubleshooting.....	6
	Procedure 1      Power Status Check .....	6
	Procedure 2      Connection Check.....	8
	Procedure 3      Charging Check .....	8
	Procedure 4      Replacement Check .....	10
2.4	System Board Troubleshooting.....	11
	Procedure 1      Message Check .....	12
	Procedure 2      Debugging Port Check.....	13
	Procedure 3      Replacement Check .....	13
2.5	Hard Disk Drive Troubleshooting .....	14
	Procedure 1      Partition Check.....	14
	Procedure 2      Message Check .....	15
	Procedure 3      Diagnostic Test Program Execution Check .....	16
	Procedure 4      Connector Check and Replacement Check.....	17
2.6	Keyboard Troubleshooting .....	18
	Procedure 1      Diagnostic Test Program Execution Check .....	18
	Procedure 2      Connector Check and Replacement Check.....	19
2.7	Touch pad Troubleshooting .....	20
	Procedure 1      Diagnostic Test Program Execution Check .....	20
	Procedure 2      Connector Check and Replacement Check.....	21
2.8	Display Troubleshooting.....	22
	Procedure 1      External Monitor Check.....	22
	Procedure 2      Diagnostic Test Program Execution Check .....	22
	Procedure 3      Connector and Cable Check.....	23

## ***Chapter 2 Troubleshooting Procedures***

---

	Procedure 4	Replacement Check .....	24
2.9	LAN Troubleshooting .....		25
	Procedure 1	Diagnostic Test Program Execution Check .....	25
	Procedure 2	Connector Check and Replacement Check.....	25
2.10	Wireless LAN Troubleshooting.....		26
	Procedure 1	Transmitting-Receiving Check .....	26
	Procedure 2	Antennas' Connection Check .....	27
	Procedure 3	Replacement Check .....	28
2.11	Sound Troubleshooting.....		29
	Procedure 1	Connector Check.....	29
	Procedure 2	Replacement Check .....	30
2.12	Bluetooth Troubleshooting .....		31
	Procedure 1	Connector Check and Replacement Check.....	31
2.13	HDMI Troubleshooting .....		32
	Procedure 1	Connector Check and Replacement Check.....	32
	Procedure 2	External Monitor Check.....	32
	Procedure 3	Connector and Cable Check.....	33
	Procedure 4	Replacement Check .....	34
2.14	Memory Troubleshooting .....		35
	Procedure 1	Diagnostic Test Program Execution Check .....	35
	Procedure 2	Connect Check and Replacement Check .....	35
2.15	3G Troubleshooting .....		36
	Procedure 1	Connect Check and Replacement Check .....	36
2.16	Camera Troubleshooting.....		37
	Procedure 1	Camera Execution Check.....	37
	Procedure 2	Connect Check and Replacement Check .....	37
2.17	Microphone Troubleshooting.....		38
	Procedure 1	Sound Recorder Execution Check .....	38
	Procedure 2	Connect Check and Replacement Check .....	38
2.18	CRT Troubleshooting .....		39
	Procedure 1	External Monitor Check.....	39
	Procedure 2	Connector and Cable Check.....	39

## ***Chapter 2 Troubleshooting Procedures***

---

	Procedure 3	Replacement Check .....	39
2.19	USB Troubleshooting .....		40
	Procedure 1	Diagnostic Test Program Execution Check .....	40
	Procedure 2	Connect Check and Replacement Check .....	40
2.20	LED Troubleshooting .....		41
	Procedure 1	Each function Execution Check.....	41
	Procedure 2	Connect Check and Replacement Check .....	41

## **2.1 Trouble shooting**

Chapter 2 describes how to determine which Field Replaceable Unit (FRU) in the computer is causing the computer to malfunction.

The FRUs covered are:

- |                 |                 |                |
|-----------------|-----------------|----------------|
| 1. Power supply | 7. LAN          | 13. 3G         |
| 2. System Board | 8. Wireless LAN | 14. Camera     |
| 3. SATA HDD     | 9. Sound        | 15. Microphone |
| 4. Keyboard     | 10. Bluetooth   | 16. Ext CRT    |
| 5. Touch pad    | 11. HDMI        | 17. USB        |
| 6. Display      | 12. Memory      | 18. LED        |

The Test Program operations are described in Chapter 3. Detailed replacement procedures are described in Chapter 4.

**NOTE:** *After replacing the system board, it is necessary to execute the subtest 01 initial configuration of the 3.3 Setting of the hardware configuration in Chapter 3.*

The implement for the Diagnostics procedures is referred to Chapter 3. Also, following implements are necessary:

1. Phillips screwdrivers (For replacement procedures)
2. Implements for debugging port check
  - Toshiba Free-DOS system

## **2.2 Troubleshooting Flowchart**

Use the flowchart in Figure 2-2-1 as a guide for determining which troubleshooting procedures to execute. Before going through the flowchart steps, verify the following:

- Ask customer to enter the password if a password is registered.
- Verify with the customer that Toshiba Windows is installed on the hard disk. Non-Windows operating systems can cause the computer to malfunction.
- Make sure all optional equipment is removed from the computer.

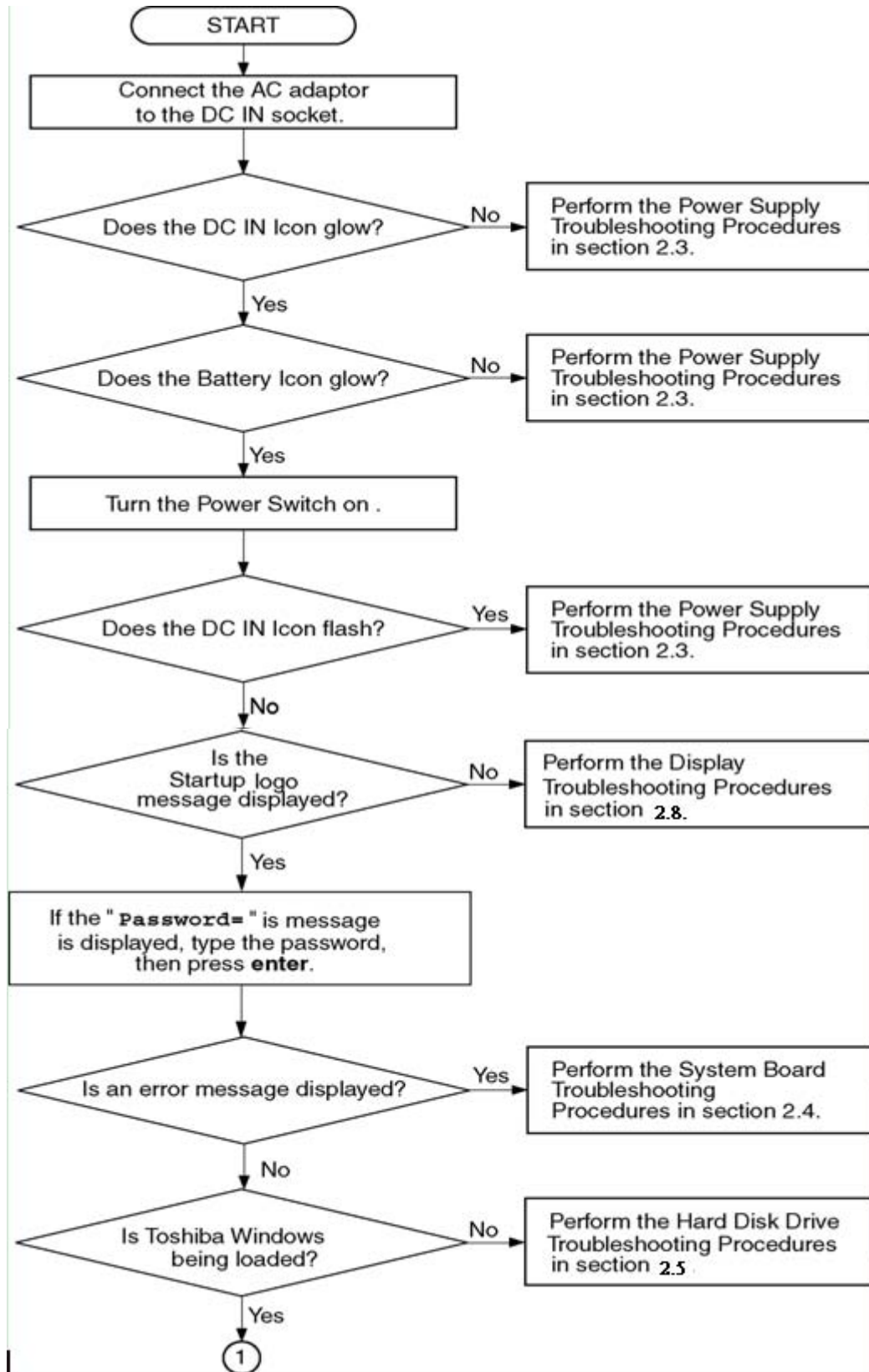

Figure 2-2-1 Troubleshooting flowchart (1/2)

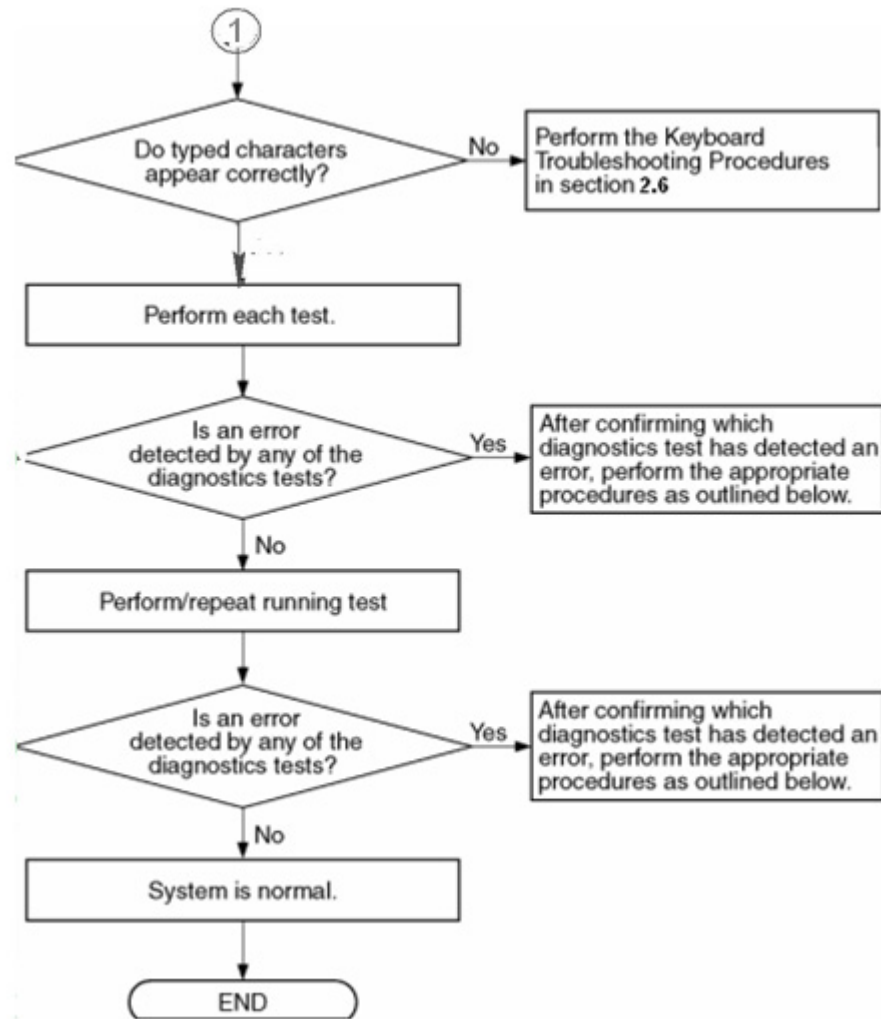

Figure 2-2-1 Troubleshooting flowchart (2/2)

If the diagnostics program cannot detect an error, the problem may be intermittent. The Test program should be executed several times to isolate the problem. Check the Log Utilities function to confirm which diagnostic test detected an error(s), and then perform the appropriate troubleshooting procedures as follows:

1. If an error is detected on the system test, memory test, display test, expansion test, real timer test, sound test or LAN/Bluetooth test, perform the System Board Troubleshooting Procedures in Section 2.4.
2. If an error is detected on the hard disk test, perform the HDD Troubleshooting Procedures in Section 2.5.
3. If an error is found on the keyboard test (DIAGNOSTICS TEST) and pressed key display test, perform the Keyboard Troubleshooting Procedures in Section 2.6.



4. If an error is found on the touch pad test, perform the Touch pad Troubleshooting Procedures in Section 2.7.
5. If an error is detected on the display test, perform the Display Troubleshooting Procedures in Section 2.8.
6. If an error is detected on the LAN test, perform the LAN Troubleshooting Procedures in Section 2.9.
7. If an error is detected on the Wireless LAN test, perform the Wireless LAN Troubleshooting Procedures in Section 2.10.
8. If an error is detected on the sound test, perform the Sound Troubleshooting Procedures in Section 2.11.
9. If an error is detected on the Bluetooth test, perform the Bluetooth Troubleshooting Procedures in Section 2.12.
10. If an error is detected on the HDMI test, perform the HDMI Troubleshooting Procedures in Section 2.13

## 2.3 Power Supply Troubleshooting

The power supply controller controls many functions and components. To determine if the power supply is functioning properly, start with Procedure 1 and continue with the other Procedures as instructed. The procedures described in this section are:

Procedure 1: Power Status Check

Procedure 2: Connection Check

Procedure 3: Charging Check

Procedure 4: Replacement Check

### Procedure 1 Power Status Check

The following LED indicates the power supply status:

Battery LED

DC IN LED

The Power Supply control displays the power supply status with the Battery LED and the DC IN LED as listed in the tables below.

Battery icon	Power supply status
Lights Orange	Battery is charged and the AC adapter is connected. It has no relation with ON/OFF of the system power.
Lights Green	Battery is fully charged and the AC adapter is connected. It has no relation with ON/OFF of the system power.
Blinks Orange (even intervals)	The battery level is low while the system power is ON.
Doesn't light	Any condition other than those above.

Table 2-3-1 Battery icon

DC IN icon	Power supply status
Lights Green	DC power is being supplied from the AC adapter.
Blinks Orange	Power supply malfunction <sup>*1</sup>
Doesn't light	Any condition other than those above.

Table 2-3-2 DC IN icon

\*1 When the power supply controller detects a malfunction, the DC IN icon blinks orange and perform the following procedure.

When the icon is blinking, perform the following procedure.

1. Remove the battery pack and the AC adapter.
2. Re-attach the battery pack and the AC adapter.

If the icon is still blinking after the operation above, check the followings:

Check 1 If the DC IN icon blinks orange, go to Procedure 2.

Check 2 If the DC IN icon does not light, go to Procedure 3.

Check 3 If the battery icon does not light orange or green, go to Procedure 4.

<p><b>NOTE:</b> Use a supplied AC adapter.</p>
--

## **Procedure 2 Connection Check**

The wiring diagram related to the power supply is shown below:

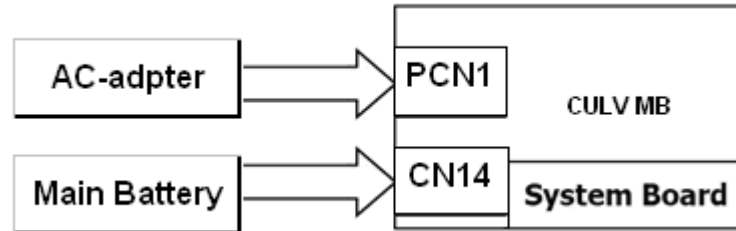

Any of the connectors may be disconnected. Perform Check 1.

- Check 1 Make sure the AC adapter and the AC power cord is firmly plugged into the PCN1 connector and wall outlet. If these cables are connected firmly, go to Check 2.
- Check 2 Replace the AC adapter and the AC power cord with new ones.
- If the DC IN icon does not light, go to Procedure 4.
  - If the battery icon does not light, go to Check 3.
- Check 3 Make sure the main battery pack is installed in the computer correctly. If the battery is properly installed and the battery icon still does not light, go to Procedure 4.

## **Procedure 3 Charging Check**

Check if the power supply controller charges the battery pack properly. Perform the following procedures:

- Check 1 Make sure the AC adapter is firmly plugged into the DC IN socket.
- Check 2 Make sure the battery pack is properly installed. If it is properly installed, go to Check 3.
- Check 3 The battery pack may be completely discharged. Wait a few minutes to charge the battery pack while connecting the battery pack and the AC adapter. If the battery pack is still not charged, go to Check 4.
- Check 4 The battery's temperature is too high or low. Leave the battery for a while to adjust it in the right temperature. If the battery pack is still not charged, go to Check 5.
- Check 5 Replace the battery pack with a new one. If the battery pack is still not charged,

go to Procedure 4.

#### **Procedure 4 Replacement Check**

The power is supplied to the system board by the AC adapter. If either the AC adapter or the system board was damaged, perform the following Checks.

To disassemble the computer, follow the steps described in Chapter 4, *Replacement Procedures*.

When AC adapter is connected;

Check 1 AC adapter may be faulty. Replace the AC adapter with a new one. If the problem still occurs, perform Check 2.

Check 2 System board may be faulty. Replace the system board with a new one.

When AC adapter is not connected ;  
(When driving with battery pack)

Check 1 Battery pack may be faulty. Replace it with a new one. If the problem still occurs, perform Check 2.

Check 2 System board may be faulty. Replace it with a new one.

## **2.4 System Board Troubleshooting**

This section describes how to determine if the system board is malfunctioning or not. Start with Procedure 1 and continue with the other procedures as instructed. The procedures described in this section are:

Procedure 1: Message Check

Procedure 2 Diagnostic Test Program Execution Check

Procedure 3: Replacement Check

### **Procedure 1    Message Check**

When the power is turned on, the system performs the Power on Self Test (POST) installed in the BIOS ROM. The POST tests each IC on the system board and initializes it.

- If an error message is shown on the display, perform Check 1.
- If there is no error message, go to Procedure 2.
- If Free-DOS or Windows is properly loaded, go to Procedure 4.

**Check 1**    If one of the following error messages is displayed on the screen, press the **F2** key as the message instructs. These errors occur when the system configuration preserved in the RTC memory (CMOS type memory) is not the same as the actual configuration or when the data is lost.

If you press the **F2** key as the message instructs, the SETUP screen appears to set the system configuration.



## **Procedure 2 Diagnostic Test Program Execution Check**

Execute the following tests from the Diagnostic Test Menu. These tests check the system board. Refer to Chapter 3, *Tests and Diagnostic*, for more information on how to perform these tests.

1. System test
2. Memory test
3. Keyboard test
4. Display test
5. Hard Disk test
6. CPU Temperature test
7. Main Battery test
8. BIOS test
9. System Status LED test
10. Wireless LAN test
11. LAN/Sound test
12. UUID test-DMI Information (Write DMI)

If an error is detected during these tests, go to Procedure 3.

## **Procedure 3 Replacement Check**

System board may be faulty. Disassemble the computer following the steps described in Chapter 4, *Replacement Procedures* and replace system board with a new one.

## 2.5 SATA Hard Disk Drive Troubleshooting

To check if HDD is malfunctioning or not, follow the troubleshooting procedures below as instructed.

Procedure 1: Partition Check

Procedure 2: Message Check

Procedure 3: Format Check

Procedure 4: Diagnostic Test Program Execution Check

Procedure 5: Connector Check and Replacement Check

**CAUTION:** *The contents of the hard disk will be erased when the HDD troubleshooting procedures are executed. Transfer the contents of the hard disk to other storage drive(s). For the backup, refer to the User's Manual.*

### Procedure 1 Partition Check

Insert the Toshiba USB memory and start the computer. Perform the following checks:

- Check 1 Input **C:** and press **Enter**. If you cannot change to drive C, go to Check 2. If you can change to drive C, go to Procedure 2.
- Check 2 input USB memories and press **Enter**. Choose Display Partition Information from the menu. If drive C is listed in the Display Partition Information, go to Check 3. If drive C is not listed, return to the menu and choose the option to create a DOS partition or a logical DOS drive on drive C. If the problem still occurs, go to Procedure 2.
- Check 3 If drive C is listed as active in the menu, go to Check 4. If drive C is not listed as active, return to the menu and choose the option to set the active partition for drive C. Then go to Procedure 2.
- Check 4 Remove the USB memory and reboot the computer. If the problem still occurs, go to Procedure 2. Otherwise, the 2.5" HDD is operating normally.

## **Procedure 2 Message Check**

When the power is turned on, the system performs the Initial Reliability Test (IRT) installed in the BIOS ROM. When the test detects an error, an error message is displayed on the screen.

Turn on the computer and check the message on the screen. When an OS starts from the 2.5" HDD, go to Procedure 3. Otherwise, start with Check 1 below and perform the other checks as instructed.

Check 1 If either of the following messages appears, go to Check 2. If the following messages do not appear, perform Check 3.

```
Insert system disk in drive  
Press any key when ready .....
```

or

```
Non-System disk or disk error  
Replace and press any key when ready
```

Check 2 Using the SYS command of the Free-DOS; transfer the system to the 2.5" HDD. If the system is not transferred, go to Procedure 3. Refer to the Free-DOS Manual for detailed operation.

If the following message appears on the display, the system program has been transferred to the HDD.

```
System Transferred
```

If an error message appears on the display, perform Check 3.

Check 3 2.5" HDD(s) and the connector(s) of system board may be defective (Refer to the steps described in Chapter 4, *Replacement Procedures* for disassembling.). Insert HDD(s) to the connector(s) firmly. If it is (or they are) firmly connected, go to Procedure 3.

### **Procedure 3 Diagnostic Test Program Execution Check**

The HDD test program is stored in the Diagnostics Disk. Perform all of the HDD tests in the Hard Disk Drive Test. Refer to Chapter 3, *Tests and Diagnostics*, for more information about the HDD test program.

If an error is detected during the HDD test, an error code and status will be displayed. The error codes and statuses are described in Table 2-5-1. If an error code is not displayed but the problem still occurs, go to Procedure 5.

<b>Code</b>	<b>Status</b>
<b>01</b>	<b>Bad Command Error</b>
<b>02</b>	<b>Bad Address Mark Error</b>
<b>04</b>	<b>Record Not Found</b>
<b>05</b>	<b>HDC Not Reset Error</b>
<b>07</b>	<b>Drive Not Initialized</b>
<b>09</b>	<b>DMA Boundary Error</b>
<b>0A</b>	<b>Bad Sector</b>
<b>0B</b>	<b>Bad Track Error</b>
<b>10</b>	<b>ECC Error</b>
<b>11</b>	<b>ECC Recover Enabled</b>
<b>20</b>	<b>HDC Error</b>
<b>40</b>	<b>Seek Error</b>
<b>80</b>	<b>Time Out Error</b>
<b>AA</b>	<b>Drive Not Ready</b>
<b>BB</b>	<b>Undefined Error</b>
<b>CC</b>	<b>Write Fault</b>
<b>E0</b>	<b>Status Error</b>
<b>F0</b>	<b>No Sense Error</b>
<b>??</b>	<b>Other Error</b>

*Table 2-5-1 HDD error code & status*

#### **Procedure 4 Connector Check and Replacement Check**

HDD(s) is/are connected to the connector(s) on the system board. The connection of HDD(s) and board may be defective. Otherwise, they may be faulty. Disassemble the computer following instructions in Chapter 4, *Replacement Procedures* and perform the following checks.

- Check 1 Make sure HDD(s) is/are firmly connected to the connector(s) on the system board.

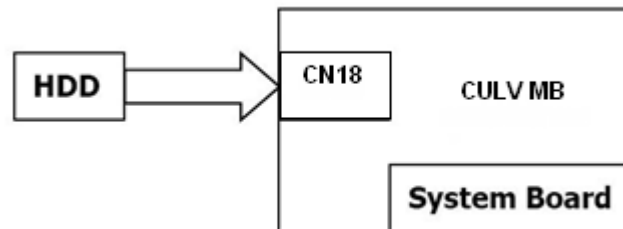

If any of the connections are loose, reconnect firmly and repeat Procedure 1. If the problem still occurs, go to Check 2.

- Check 2 (One of) HDD(s) may be faulty. Replace it with a new one following the instructions in Chapter 4, *Replacement Procedures* and check the operation. If the problem still occurs, perform Check 3.
- Check 3 System board may be faulty. Replace it with a new one following the instructions in Chapter 4, *Replacement Procedures*.

## **2.6 Keyboard Troubleshooting**

To check if the computer's keyboard is malfunctioning or not, follow the troubleshooting procedures below as instructed.

Procedure 1: Diagnostic Test Program Execution Check

Procedure 2: Connector and Replacement Check

### **Procedure 1 Diagnostic Test Program Execution Check**

Execute the Keyboard Test (DIAGNOSTIC TEST) and Pressed key display test in the Diagnostic Program. Refer to Chapter 3, *Tests and Diagnostics*, for more information on how to perform the test program.

If an error occurs, go to Procedure 2. If an error does not occur, keyboard is functioning properly.

## **Procedure 2 Connector and Replacement Check**

The connection of cable and board may be defective. Otherwise, they may be faulty. Disassemble the computer following the steps described in Chapter 4, *Replacement Procedures*, and perform the following checks:

Check 1 Make sure keyboard cable is firmly connected to system board.

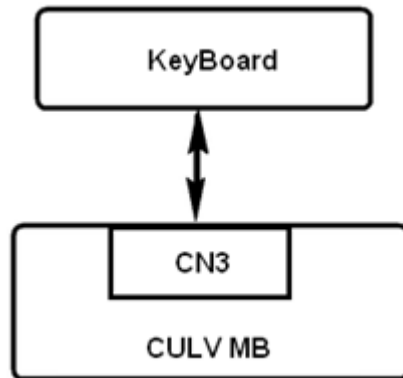

If the connection is loose, reconnect firmly and repeat Procedure 1. If the problem still occurs, go to Check 2.

Check 2 Keyboard may be faulty. Replace it with a new one following the instructions in Chapter 4, *Replacement Procedures*. If the problem still occurs, perform Check 3.

Check 3 System board may be faulty. Replace it with a new one following the instructions in Chapter 4, *Replacement Procedures*.

## **2.7 Touch pad Troubleshooting**

To check if the computer's touch pad is malfunctioning or not, follow the troubleshooting procedures below as instructed.

Procedure 1: Diagnostic Test Program Execution Check

Procedure 2: Connector and Replacement Check

### **Procedure 1 Diagnostic Test Program Execution Check**

Execute the Touch pad test in the Diagnostic Program. Refer to Chapter 3, *Tests and Diagnostics*, for more information on how to perform the test program.

If an error occurs, go to Procedure 2. If an error does not occur, touch pad is functioning properly.



## **Procedure 2 Connector and Replacement Check**

The connection of cable and board may be defective. Otherwise, they may be faulty. Disassemble the computer following the steps described in Chapter 4, *Replacement Procedures*, and perform the following checks:

Check 1 Make sure the cable is firmly connected to system board.

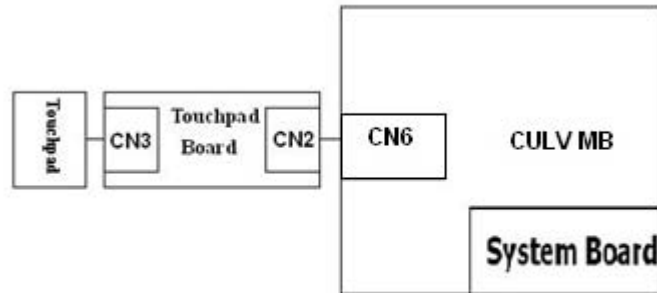

---

If the connection is loose, reconnect firmly and repeat Procedure 1. If the problem still occurs, go to Check 2.

Check 2 Touch Pad or the cable may be faulty. Replace it with a new one following the instructions in Chapter 4, *Replacement Procedures*. If the problem still occurs, perform Check 3.

Check 3 System board may be faulty. Replace it with a new one following the instructions in Chapter 4, *Replacement Procedures*

## **2.8 Display Troubleshooting**

To check if the computer's display is malfunctioning or not, follow the troubleshooting procedures below as instructed.

Procedure 1: External Monitor Check

Procedure 2: Diagnostic Test Program Execution Check

Procedure 3: Connector and Cable Check

Procedure 4: Replacement Check

### **Procedure 1 External Monitor Check**

Connect an external monitor to the computer's external monitor port, and then boot the computer. The computer automatically detects the external monitor.

When "Power on Display" setting is "Auto-Selected" (Default) in BIOS Setup Menu.

If this setting is "System LCD only", external monitor cannot be displayed. The computer automatically detects the external monitor.

If the external monitor works correctly, the internal LCD may be faulty. Go to Procedure 3.

If the external monitor appears to have the same problem as the internal monitor, system board may be faulty. Go to Procedure 2.

### **Procedure 2 Diagnostic Test Program Execution Check**

The Display Test program is stored in Diagnostics disk. This program checks the display controller on system board. Insert the Diagnostics disk, turn on the computer and run the test. Refer to Chapter 3, *Tests and Diagnostics* for details. If an error is detected, go to Procedure 3.

### **Procedure 3 Connector and Cable Check**

LCD Module is connected to system board by an LCD cable. Their cables may be disconnected from system board. Disassemble the computer following the steps described in Chapter 4, *Replacement Procedures*.

If the connection is loose, reconnect firmly and restart the computer. If the problem still occurs, go to Procedure 4.

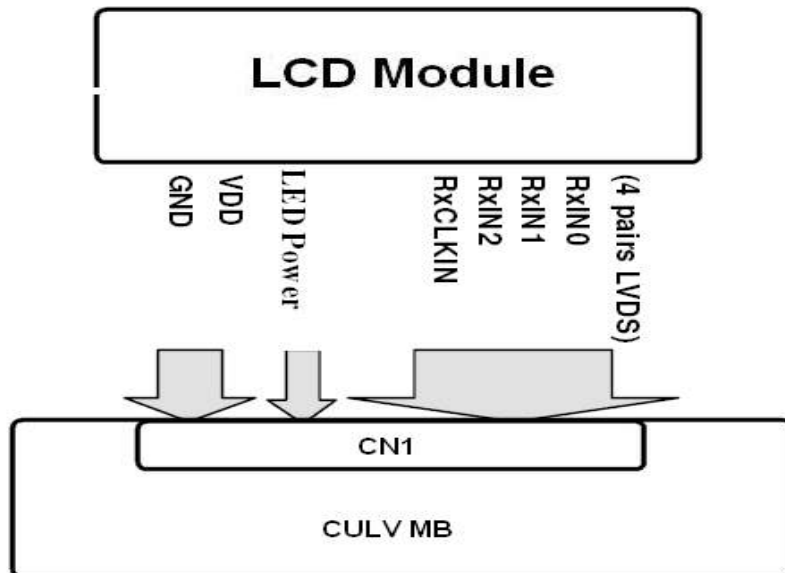

#### **Procedure 4 Replacement Check**

LCD module, LCD cable are connected to display circuits. Any of these components may be faulty. Refer to Chapter 4, *Replacement Procedures*, for instructions on how to disassemble the computer and then perform the following checks:

If characters or graphics on the internal display are not displayed clearly, perform Check 1.

If some screen functions do not operate properly, perform Check 2.

If LED backlight remains lit when the display is closed, perform Check 3.

- Check 1 LCD cable may be faulty. Replace LCD cable with a new one following the instructions in Chapter 4, *Replacement Procedure* and test the display again. If the problem still occurs, perform Check 2.
- Check 2 LCD module may be faulty. Replace LCD module with a new one following the instructions in Chapter 4, *Replacement Procedure* and test the display again. If the problem still occurs, perform Check 3.
- Check 3 System board may be faulty. Replace it with a new one following the instructions in Chapter 4, *Replacement Procedure*.

## 2.9 LAN Troubleshooting

To check if the computer's LAN is malfunctioning or not, follow the troubleshooting procedures below as instructed.

Procedure 1: Diagnostic Test Program Execution Check

Procedure 2: Connector Check and Replacement Check

### Procedure 1 Diagnostic Test Program Execution Check

Execute LAN test in the LAN test program. Refer to Chapter 3, *Tests and Diagnostics* for more information on how to perform the test program.

If any error is detected by the test, go to Procedure 2.

### Procedure 2 Connector Check and Replacement Check

The LAN function is embedded on system board. If LAN malfunctions, its connection is defective or LAN cable and system board may be faulty.

Check 1 Make sure LAN cable is firmly connected to the connector CN1. If the problem still occurs, perform Check 2.

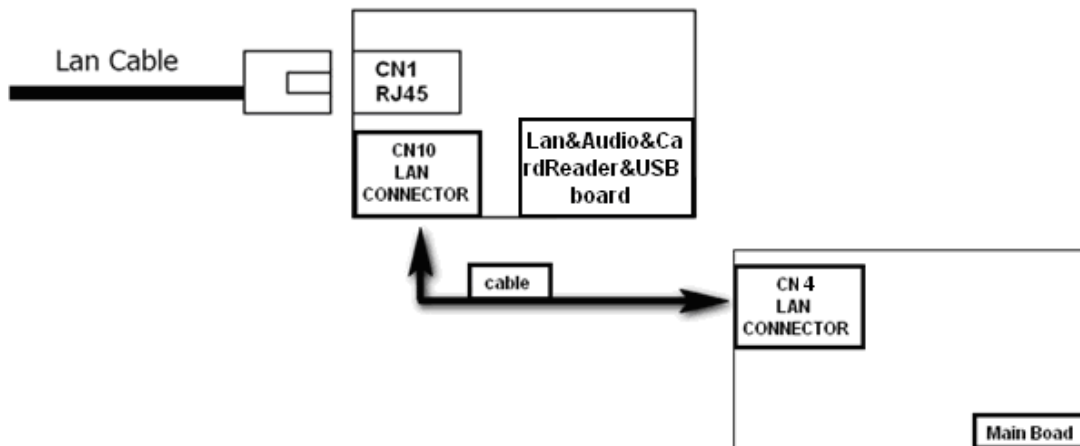

No Separated LAN BOARD , it's assembled.

Check 2 LAN cable may be faulty. Replace it with a new one. If the problem still occurs, perform Check 3.

Check 3 System board may be faulty. Replace it with a new one following the instruction in Chapter 4.

## **2.10 Wireless LAN Troubleshooting**

To check if the computer's Wireless LAN is malfunctioning or not, follow the troubleshooting procedures below as instructed.

Procedure 1: Transmitting-Receiving Check

Procedure 2: Antennas' Connection Check

Procedure 3: Replacement Check

### **Procedure 1      Transmitting-Receiving Check**

Before starting the test, make sure wireless communication is enabled in BIOS setup

Check 1    Execute Wireless LAN test program to check the transmitting-receiving function of wireless LAN. You will need a second computer that can communicate by wireless LAN. Perform the test following the instructions described in Chapter 3.

If the computer passes the test, the function is correctly working. If the computer does not pass the test, perform Procedure 2.

## **Procedure 2      Antennas' Connection Check**

The wireless LAN function-wiring diagram is shown below:

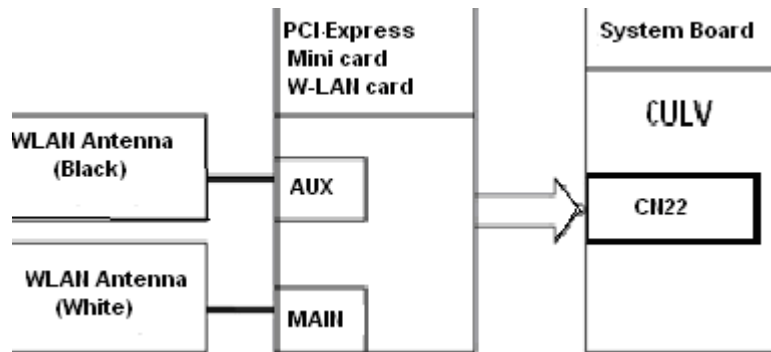

Any of the connections may be defective. Disassemble the computer following the steps described in Chapter 4, *Replacement Procedures*, and perform the following checks:

**Check 1**    Make sure the wireless communication is Enabled in BIOS setup.

If the Wireless communication is "Disabled", change it to "Enabled". If the problem still occurs, perform Check 2.

**Check 2**    Make sure wireless LAN card is firmly connected to the CN22 on system board. If the connector is defective, connect it firmly and perform Procedure 1. If the problem still occurs, perform Check 3.

**Check 3**    Make sure that wireless LAN antenna cables (black and white) are firmly connected to the connectors on Wireless LAN card. If wireless LAN antenna cables are not connected properly, connect them firmly and perform Procedure 1. If the problem still occurs, go to the procedure 3.

**Procedure 3      Replacement Check**

Wireless LAN card, wireless LAN antenna or system board may be faulty. Refer to Chapter 4, *Replacement Procedures*, for instructions on how to disassemble the computer and then perform the following checks:

- Check 1    Wireless LAN antenna may be faulty. Replace it with a new one following the instructions in Chapter 4, *Replacement Procedures*. If the problem still occurs, perform Check 2.
  
- Check 2    Wireless LAN card may be faulty. Replace it with a new one following the instructions in Chapter 4, *Replacement Procedures*. If the problem still occurs, perform Check 3.
  
- Check3    System board may be faulty. Replace it with a new one following the instructions in Chapter 4, *Replacement Procedures*.



## 2.11 Sound Troubleshooting

To check if the sound function is malfunctioning or not, follow the troubleshooting procedures below as instructed.

Procedure 1: Connector Check

Procedure 2: Replacement Check

### Procedure 1 Connector Check

The connection of sound system is shown in the following figure.

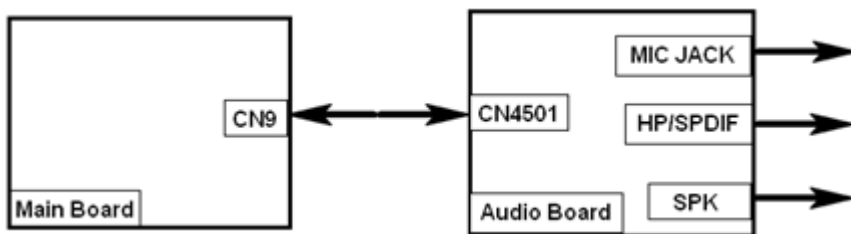

As the connection may be defective, disassemble the PC and check each connection.

If the problem still occurs, go to Procedure 2.

## **Procedure 2 Replacement Check**

- If External microphone/Headphone does not work properly, perform check 1.
- If internal microphone /Speaker do not work properly, perform check 2.
- If HP out does not work properly, perform check 3.
- If Volume control does not work properly, perform check 4.

Check 1 External microphone/Headphone may be faulty. Replace it with a new one following the steps in Chapter 4. If the problem still occurs, perform Check 5.

Check 2 Internal microphone /Speaker may be faulty. Replace it with a new one following the steps in Chapter 4. If the problem still occurs, perform Check 5.

Check 3 HP out may be faulty. Replace it with a new one following the steps in Chapter 4. If the problem still occurs, perform Check 5.

Check 4 Volume control may be faulty. Replace it with a new one following the steps in Chapter 4. If the problem still occurs, perform Check 6.

Check 5 Flat cables between AD board/Speaker and system board may be faulty. Replace it with new cable following the instructions in Chapter 4. If the problem still occurs, perform Check 6.

Check 6 Audio board/System board may be faulty. Replace it with a new one following the instructions in Chapter 4.

## **2.12 Bluetooth Troubleshooting**

To check if the computer's Bluetooth is malfunctioning or not, follow the troubleshooting procedure below as instructed.

### **Procedure 1 Connector Check and Replacement Check**

The Bluetooth module is connected to system board. If Bluetooth malfunctions, its connection is defective or Bluetooth cable and system board may be faulty.

Check 1 Make sure Bluetooth cable is firmly connected to the connector CN12 (system board). If the problem still occurs, perform Check 2.

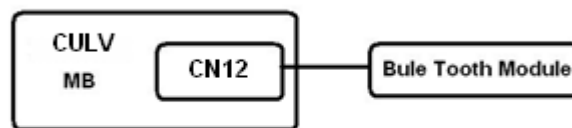

Check 2 Bluetooth cable may be faulty. Replace it with a new one. If the problem s till occurs, perform Check 3.

Check 3 Bluetooth may be faulty. Replace it with a new one following the steps in Chapter 4. If the problem still occurs, perform Check 4.

Check 4 System board may be faulty. Replace it with a new one following the instruction in Chapter 4.

## 2.13 HDMI Troubleshooting

To check if the computer's HDMI is malfunctioning or not, follow the troubleshooting procedures below as instructed.

Procedure 1: External HDMI Monitor Check

Procedure 2: Connector and Cable Check

Procedure 3: Replacement Check

### Procedure 1 Connector Check and Replacement Check

The HDMI port is connected to system board. If HDMI malfunctions, its connection is defective or HDMI cable and system board may be faulty.

Check 1 Make sure HDMI cable is firmly connected to the connector CN11 (system board). If the problem still occurs, perform Procedure 2.

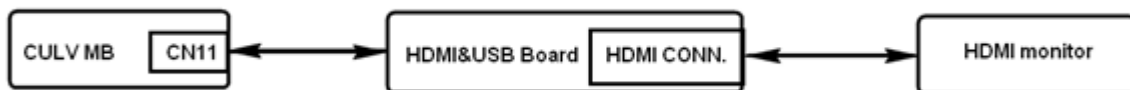

### Procedure 2 External Monitor Check

Connect an external monitor to the computer's HDMI port, and then boot the computer. The computer automatically detects the external monitor.

If the external monitor works correctly, the internal LCD may be faulty. Go to Procedure 3.

If the external monitor appears to have the same problem as the internal monitor, system board may be faulty. Go to Procedure 2.

### **Procedure 3 Connector and Cable Check**

HDMI monitor connected to HDMI&USB board by an HDMI cable.

If the connection is loose, reconnect firmly and restart the computer. If the problem still occurs, go to Procedure 4.

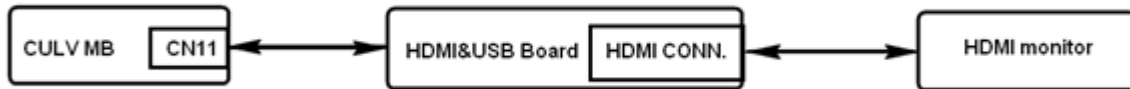

#### **Procedure 4 Replacement Check**

HDMI signals are connected to display circuits via HDMI cable and HDMI&USB board. Any of these components may be faulty. Refer to Chapter 4, *Replacement Procedures*, for instructions on how to disassemble the computer and then perform the following checks:

If characters or graphics on the internal display are not displayed clearly, perform Check 1.

If some screen functions do not operate properly, perform Check 4.

- Check 1 HDMI cable may be faulty. Replace HDMI cable with a new one following the instructions in Chapter 1, *Replacement Procedure* and test the display again. If the problem still occurs, perform Check 2.
- Check 2 HDMI monitor may be faulty. Replace HDMI monitor with a new one following the instructions in Chapter 2, *Replacement Procedure* and test the display again. If the problem still occurs, perform Check 3
- Check 3 HDMI&USB board may be faulty. Replace it with a new one following the instructions in Chapter 3, *Replacement Procedure*.
- Check 4 System board may be faulty. Replace it with a new one following the instructions in Chapter 4, *Replacement Procedure*.

## 2.14 Memory Troubleshooting

Memory troubleshooting can following below procedures as instructed.

Procedure 1: Diagnostic Test Program Execution Check

Procedure 2: Connect Check and Replacement Check

### Procedure 1 Diagnostic Test Program Execution Check

Execute Memory test in the Memory test program. Refer to Chapter 3, *Tests and Diagnostics* for more information on how to perform the test program.

If any error is detected by the test, go to Procedure 2.

### Procedure 2 Connect Check and Replacement Check

Memory function abnormal always accompany NB run abnormal, the RAM may be not insert correctly or slot is defective or RAM and system board may be faulty.

Check 1 Make sure RAM is correctly and firmly inserted to the slots. If the problem still occurs, perform Check 2.

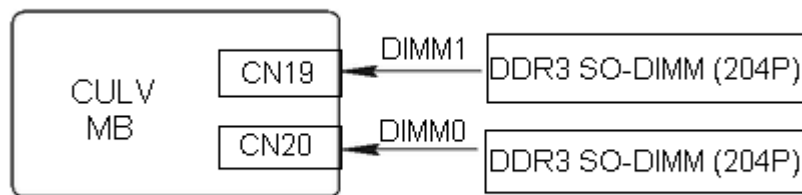

Check 2 RAM may be faulty. Replace it with a new one. If the problem still occurs, perform Check 3.

Check 3 The slot and MB may be faulty. Replace it with a new one following the instruction in Chapter 4.

## 2.15 3G Troubleshooting

To check if the computer's 3G is malfunctioning or not, follow the troubleshooting procedure below as instructed.

### Procedure 1 Connector Check and Replacement Check

The 3G module is connected to system board. If 3G malfunctions, its connection is defective or Antenna and system board may be faulty.

Check 1 Make sure 3G is firmly connected to the connector CN21 (system board). If the problem still occurs, perform Check 2.

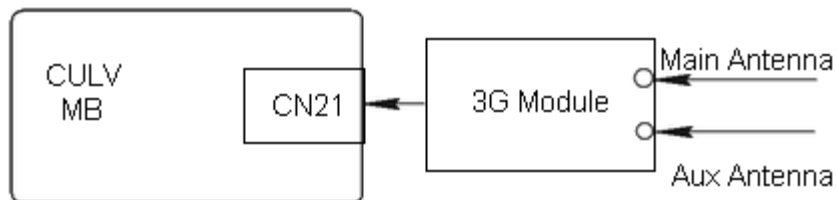

Check 2 Antenna may be faulty. Replace it with new one. If the problem still occurs, perform Check 3.

Check 3 3G card may be faulty. Replace it with a new one following the steps in Chapter 4. If the problem still occurs, perform Check 4.

Check 4 System board may be faulty. Replace it with a new one following the instruction in Chapter 4.





## 2.16 Camera Troubleshooting

To check if the computer's Camera is malfunctioning or not, follow the troubleshooting procedure below as instructed.

Procedure 1: Camera Execution Check

Procedure 2: Connect Check and Replacement Check

### Procedure 1 Camera Execution Check

Open photo/video tool to look if there is an image. If not, go to Procedure 2.

### Procedure 2 Connect Check and Replacement Check

The CCD cable is connected to system board. If camera malfunctions, its connection may be defective or CCD cable and system board may be faulty.

Check 1 Make sure the other side of CCD cable is correctly and firmly inserted to the CN1 in MB. If the problem still occurs, perform Check 2.

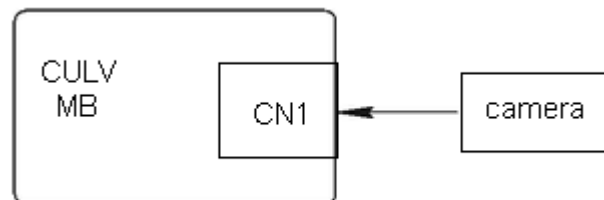

Check 2 CCD cable may be faulty. Replace it with a new one. If the problem still occurs, perform Check 3.

Check 3 Camera may be faulty. Replace it with a new one following the instruction in Chapter 4.

Check 4 System board may be faulty. Replace it with a new one following the instruction in Chapter 4.

## 2.17 Microphone Troubleshooting

Microphone troubleshooting can following below procedures as instructed.

Procedure 1: Sound Recorder Execution Check

Procedure 2: Connect Check and Replacement Check

### Procedure 1 Sound Recorder Execution Check

Open accessory to find sound recorder tool, try to record a length of sound, and then replay it to see if microphone is working normal. If not, go to Procedure 2.

### Procedure 2 Connect Check and Replacement Check

The Microphone is combined with CCD cable which is connected to system board. If microphone malfunctions, its connection may be defective or CCD cable and system board may be faulty.

Check 1 Make sure the other side of CCD cable is correctly and firmly inserted to the CN1 in MB. If the problem still occurs, perform Check 2.

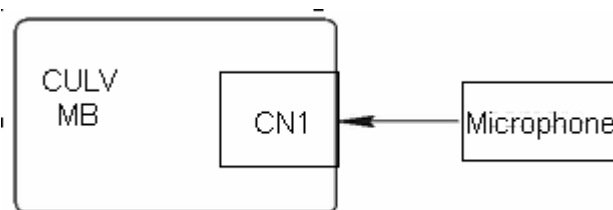

Check 2 CCD cable or Microphone may be faulty. Replace it with a new one. If the problem still occurs, perform Check 3.

Check 3 System board may be faulty. Replace it with a new one following the instruction in Chapter 4.

## 2.18 CRT Troubleshooting

To check if the computer's CRT is malfunctioning or not, follow the troubleshooting procedures below as instructed.

Procedure 1: External Monitor Check

Procedure 2: Connector and Cable Check

Procedure 3: Replacement Check

### Procedure 1 External Monitor Check

Connect an external monitor to the computer's external CRT port, and then to see if you can transfer video image to external monitor. If not, go procedure2.

### Procedure 2 Connector and Cable Check

CRT board is connected to system board by a CRT cable. Their cables may be disconnected from system board. Disassemble the computer following the steps described in Chapter 4, *Replacement Procedures*.

If the connection is loose, reconnect firmly and restart the computer. If the problem still occurs, go to Procedure 3.

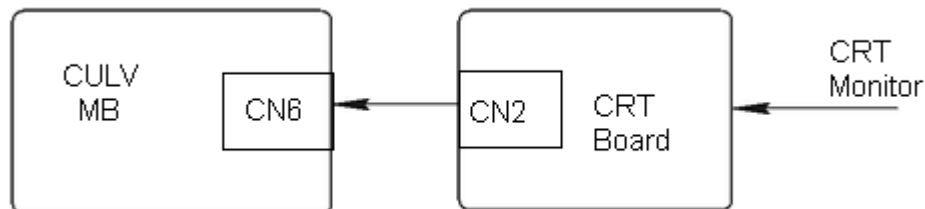

### Procedure 3 Replacement Check

Check 1 CRT cable may be faulty. Replace CRT cable with a new one following the instructions in Chapter 4--*Replacement Procedure*, and then test again. If the problem still occurs, perform Check 2.

Check 2 CRT board may be faulty. Replace CRT board with a new one following the instructions in Chapter 4, *Replacement Procedure*, and then test again. If the problem still occurs, perform Check 3.

Check 3 System board may be faulty. Replace it with a new one following the instructions in Chapter 4, *Replacement Procedure*.

## 2.19 USB Troubleshooting

Flatiron Mini carries 3 USB port. To check if the computer's USB port is malfunctioning or not, follow the troubleshooting procedures below as instructed.

Procedure 1: Diagnostic Test Program Execution Check

Procedure 2: Connect Check and Replacement Check

### Procedure 1 Diagnostic Test Program Execution Check

Execute USB test in the USB test program.

If any error is detected by the test, go to Procedure 2.

### Procedure 2 Connect Check and Replacement Check

USB is connected to system board by a HDMI cable and an Audio cable. These cables may be disconnected from system board. Disassemble the computer following the steps described in Chapter 4, *Replacement Procedures*.

Check 1 Make sure HDMI cable and Audio cable are correctly and firmly inserted. If the problem still occurs, perform Check 2.

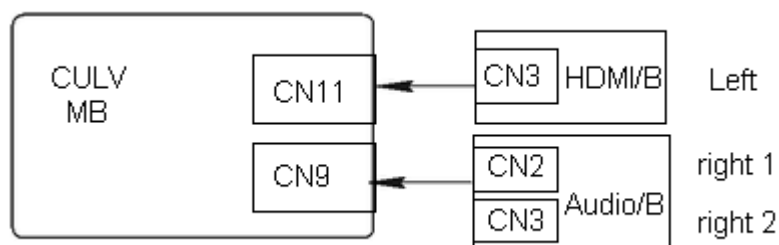

Check 2 HDMI/B or Audio/B may be faulty. Replace it with a new one. If the problem still occurs, perform Check 3.

Check 3 The system board may be faulty. Replace it with a new one following the instruction in Chapter 4.

## 2.20 LED Troubleshooting

These are 9 LED lights at Top assy. From left to right, the Open statuses of them represent functions as below.

- |               |          |            |              |               |
|---------------|----------|------------|--------------|---------------|
| 1. AC-IN      | 2. Power | 3. Battery | 4.HDD        |               |
| 5. Cardreader | 6.W-Lan  | 7.3G       | 8.Arrow Lock | 9.Number Lock |

To check if the computer's LED is malfunctioning or not, follow the troubleshooting procedures below as instructed.

Procedure 1: Each function Execution Check

Procedure 2: Connect Check and Replacement Check

### Procedure 1 Each function Execution Check

In this procedure, you must first make sure all components except LED are working right. Then you can execute the related function to check if the corresponding LED is on or not. If not, please go to Procedure2.

### Procedure 2 Connect Check and Replacement Check

LED light is combined with Touchpad/B which is connected to system board by a TP-MB cable. This cable may be disconnected from system board. Disassemble the computer following the steps described in Chapter 4, *Replacement Procedures*.

Check 1 Make sure TP-MB is correctly and firmly inserted. If the problem still occurs, perform Check 2.

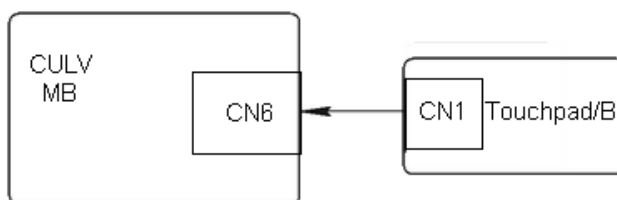

Check 2 Touchpad/B may be faulty. Replace it with a new one. If the problem still occurs, perform Check 3.

Check 3 The system board may be faulty. Replace it with a new one following the instruction in Chapter 4.

---

# **Chapter 3**

## **Diagnostic Programs**

---

---

## **Chapter 3 Contents**

---

3.1	Tests and Diagnostics Software Overview .....	3-3
3.2	Executing the Diagnostic Test .....	3-4
3.3	Subtest names.....	3-8
3.4	System Test.....	3-11
3.5	Memory Test.....	3-18
3.6	Keyboard Test.....	3-22
3.7	Display Test .....	3-24
3.8	Floppy Disk Test.....	3-39
3.9	Hard Disk Test .....	3-41
3.10	Real Time Clock Test .....	3-44
3.11	Cache Memory Test.....	3-46
3.12	High Resolution Display Test.....	3-48
3.13	Multimedia Test.....	3-54
3.14	MEMORY2 Test.....	3-55
3.15	Error Codes and Error Status Names .....	3-57
3.16	Running Test.....	3-59
3.17	DMI INFOEMATION .....	3-60
3.17.1	Check DMI Information .....	3-60
3.17.2	Write DMI Information.....	3-60
3.18	Log Utilities .....	3-63
3.18.1	Operations .....	3-63
3.19	System Configuration .....	3-65
3.20	OPTION.....	3-66
3.20.1	Function Description.....	3-66
3.20.2	Operation Description.....	3-66
3.21	Common Tests and Operation .....	3-68
3.21.1	How to operate a window .....	3-68
3.21.2	How to Stop the Test Program.....	3-68
3.21.3	Test Status Screen .....	3-68
3.21.4	Test Stop Display .....	3-70
3.21.5	How to enter data.....	3-70



### **3.1 Tests and Diagnostics Software Overview**

This chapter explains how to use the Tests and Diagnostics Software for the Satellite T110 and Satellite Pro T110 computer systems.

**NOTES:** *Before starting the Tests and Diagnostics software:*

- 1. Check all cables for loose connections.*
- 2. Exit any application and close Windows.*

The Diagnostics Menu consists of the following options:

- Diagnostic Test
- Running Test
- DMI Information
- Log Utilities
- System Configuration
- Option

The Diagnostic Test Menu consists of the following functional tests:

- System Test
- Memory Test
- Keyboard Test
- Display Test
- Floppy Disk Test
- Hard Disk Test
- Real Time Clock Test
- Cache Memory Test
- High Resolution Display Test
- Multimedia Test
- Memory2 Test
- FDD & HDD Error Retry Count Set

The following equipment is required to perform some of the diagnostic test programs:

- The Diagnostics Disk (all tests)
- A formatted working disk for the floppy disk drive test (all tests)
- A CD test media (Toshiba Backup CD ROM for the CD-ROM test)

The following sections detail the tests contained within the Diagnostic Test Menu. Refer to Sections 3.18, 3.19, 3.20 and, 3.21 for detailed information on the remaining functions of the Tests and Diagnostics software.

## 3.2 Executing the Diagnostic Test

Free-DOS is required to run the Diagnostics Program. To start the programs follow these steps:

1. Create a Free-DOS bootable disk and copy all the files from the Tests and Diagnostics software to the disk.
2. Insert the boot disk into the computer's floppy disk drive and turn on the computer.

**NOTES:** *If error message display "Sorry. This Model Type Not Match This Machine":*

**Please Check :**

1. *You test disk is match this model , ex. disk is 14" but machine is 13" .*
2. *The M/B EEPROM project type is math your test disk , if not , please use WDMI3.EXE to modify with right LCD size .*

The following screen displays:

```
TOSHIBA Satellite(Pro) T110 Diagnostics
Version v1.00

[ DIAGNOSTICS MENU ]
01.DIAGNOSTIC TEST
02.RUNNING TEST
03.DMI INFORMATION
04.LOG UTILITIES
05.SYSTEM CONFIGURATION
06.OPTION
99.EXIT

↑ ↓ → ← : Select item
ESC      : Escape
```

3. To select the Diagnostic Test from the Diagnostics Menu use the arrow keys to set the highlight bar to **01** and press **Enter**.

The following menu displays:

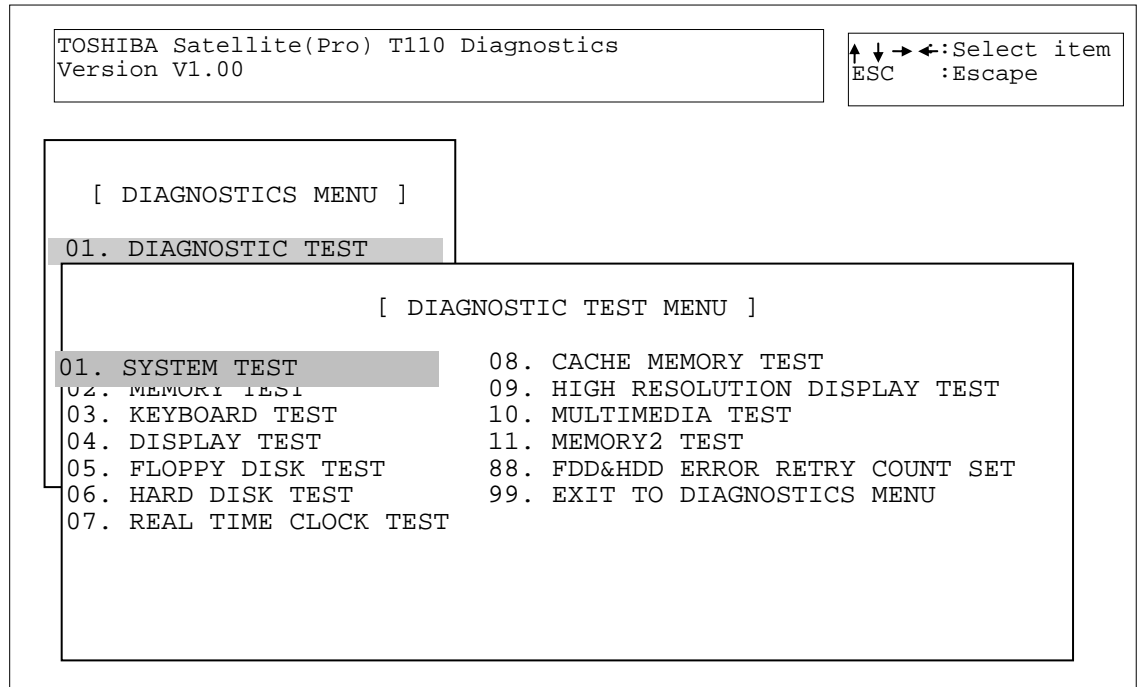

Refer to Sections 3.4 through 3.14 for detailed descriptions of Diagnostics Tests 1 through 11. Item 88 sets the floppy disk drive and hard disk drive error retry count. Item 99 exits the submenu of the Diagnostic Test and returns to the Diagnostics Menu.

4. Select the subtest you want to execute and press **Enter**. The following menu displays:

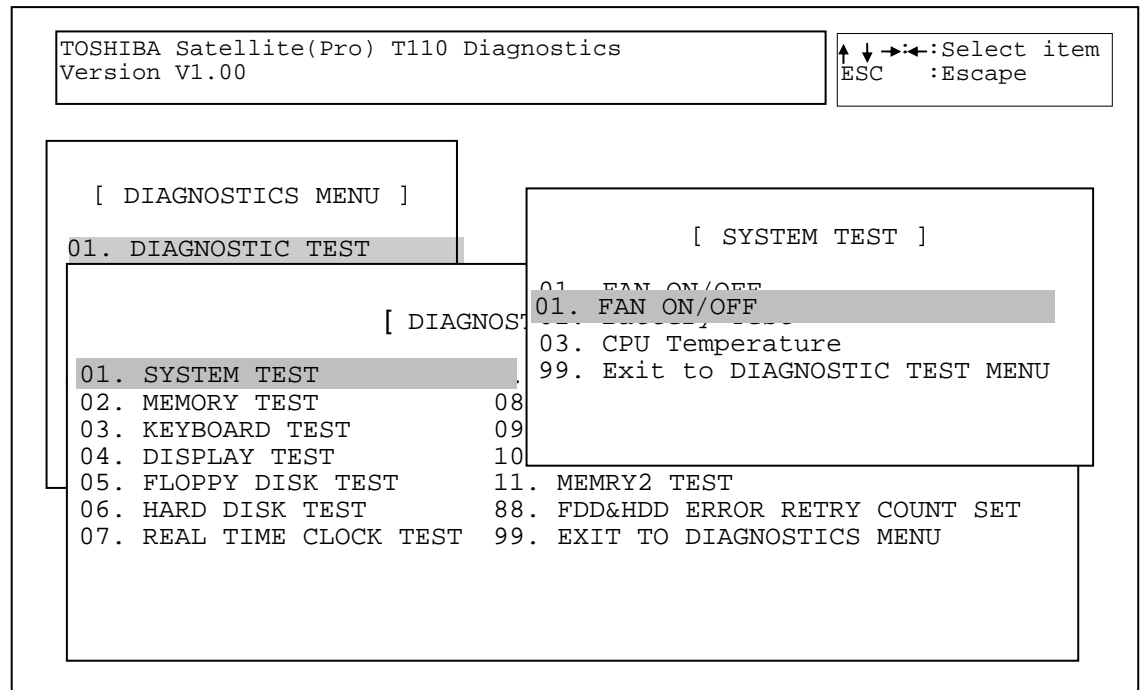

5. Select the desired test from the subtest menu and press **Enter**. The following Test Parameter menu displays:

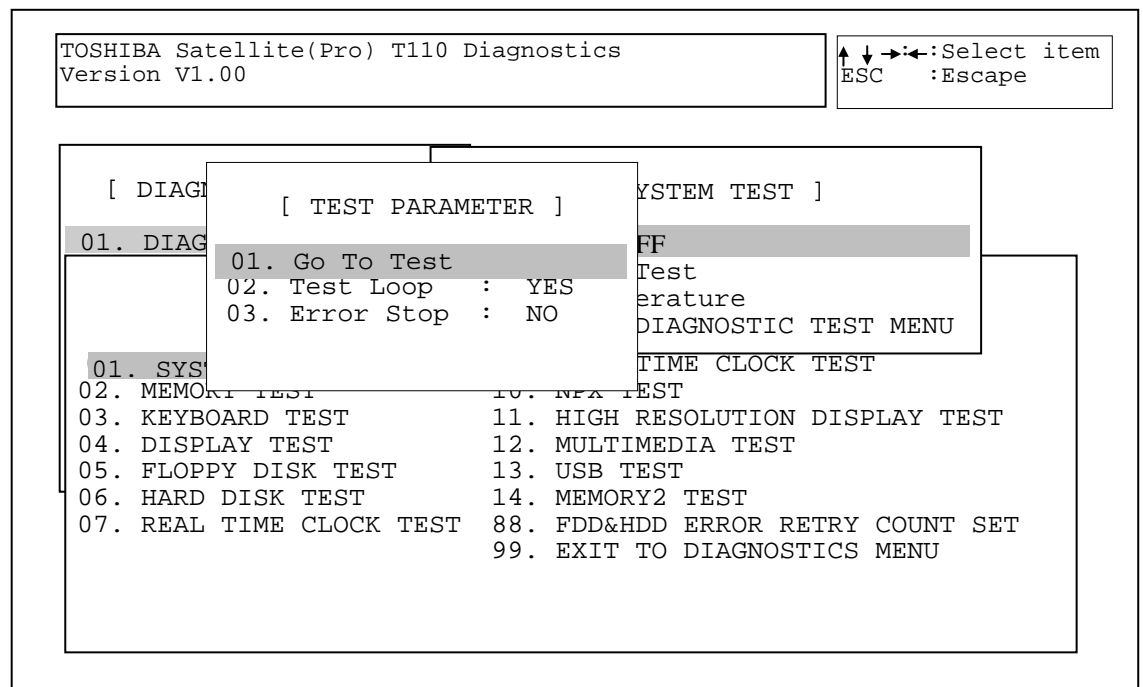

Use the arrow keys to highlight the desired option and press **Enter**.

**NOTES:** *The Item2 and 3 of Test Parameter are not used by some tests.*

**Go To Test**

Move the highlight bar to *Go To Test* and press **Enter** to start executing the test.

**Test Loop**

Select **NO** to return the screen to the subtest menu after the test is complete.

Select **YES** to set the test to run continuously until it is halted by the user.

**Error Stop**

Select **NO** to keep the test running even if an error is found.

Select **YES** to stop the test program when an error is found and display the HALT OPERATION screen as shown below:

```
[[ HALT OPERATION ]]  
1: Test end  
2: Continue  
3: Retry
```

These three selections have the following functions:

- 1: Terminates the test program and exits to the subtest menu.
- 2: Continues the test from the error.
- 3: Restarts the test from the beginning.

Use the arrow keys to move the cursor to the desired option and press **Enter**.

Table 3-1 in Section 3.3 lists the function of each test on the subtest menu. Table 3-2 in Section 3.15 lists the error codes and error status for each error.

### 3.3 Subtest names

Table 3-1 lists the subtest names for each test program in the Diagnostic Test menu.

*Table 3-1 Subtest Names(1/3)*

No.	Test Name	No.	Subtest Name
01	SYSTEM TEST	01	FAN ON/OFF check
		02	Battery TEST
		03	CPU Temperature
		04	3D HDD Protection Test (90d)
02	MEMORY TEST	01	Conventional Memory
		02	Protected Mode
		03	Protected Mode (32MB-MAX)
		04	RAM Refresh
		05	Stress Test
03	KEYBOARD TEST	01	Pressed Key Display [85J KBD]
		02	Pressed Key Display [86 KBD]
		03	Pressed Key Display [85 KBD]
		04	PS/2 Mouse (Pointing 2Button)
04	DISPLAY TEST	01	Character Attributes
		02	Character Set
		03	80* 25 Character Display
		04	320* 200 Graphics Display
		05	640* 200 Graphics Display
		06	640* 480 Graphics Display
		07	Display Page
		08	"H" Pattern Display
		09	Video DAC Register W/R/C
		10	Color Graphics Display
		11	Color Attributes Display
		12	Color Tiling

*Table 3-1 Subtest Names(2/3)*

<b>No.</b>	<b>Test Name</b>	<b>No.</b>	<b>Subtest Name</b>
05	FLOPPY DISK TEST	01	Sequential Read
		02	Sequential W/R/C
		03	Random Address/Data
		04	Write Specified Address
		05	Read Specified Address
06	HARD DISK TEST	01	Sequential Read
		02	Address Uniqueness
		03	Random Address Data
		04	Cross Talk and Peek Shift
		05	Write Specified Address
		06	Read Specified Address
		07	Sequential Write
		08	W-R-C Specified Address
07	REAL TIME CLOCK TEST	01	Real Time Test
		02	Backup Memory Test
		03	Real Time Carry Test
08	CACHE MEMORY TEST	01	Constant Data Test
		02	Address Pattern Test
		03	Increment/Decrement Test
		04	Bit Shift Pattern Test
		05	*Write Disturb Test
		06	Checker Board Test
		07	Marching Test
		08	Working Data Test
09	HIGH RESOLUTION DISPLAY TEST	01	VRAM W/R/C Test
		02	640* 480 Mode Display
		03	800* 600 Mode Display
		04	1024* 768 Mode Display
		05	"H" Pattern Display
		06	Focus Test ("E" Pattern)

*Table 3-1 Subtest Names(3/3)*

<b>No.</b>	<b>Test Name</b>	<b>No.</b>	<b>Subtest Name</b>
10	MULTIMEDIA TEST	01	Sequential Read Test
		02	Random Read Test
		03	Read Specified Address Test
		04	1 point W/R/C Test
11	MEMORY2	01	All one/zero Test
		02	Walking 1/Walking 0 Test(Left)
		03	Walking 1/Walking 0 Test(Right)
		04	Walking 1/Walking 0 Test(Left /Right)

*\*This test cannot support.*



### 3.4 System Test

To execute the System Test select **01** from the Diagnostic Test Menu, press **Enter** and follow the directions on the screen. The System Test contains three subtests. Move the highlight bar to the subtest you want to execute and press **Enter**.

Subtest 01 FAN ON/OFF Checking

Select 1,2,3 to control FAN on/off , 1=Fan on , 2=Fan off , 3=Exit .

[BOIFAN2.EXE] Program Version : 1.0

1: Fan On 2: Fan Off 3: Exit

Fan1 Status On Fan1RPM : 5000 or Fan1 Status OFF Fan1RPM : 0

Fan2 Status On Fan2RPM : 2500 or Fan2 Status OFF Fan2RPM : 0

Subtest 02 Battery Test

This will display battery information for check , press [ESC] to exit .

[BOIPCU.EXE] Program Version : 1.0 03-27-2007

voltage	: 12522 mV	Remaining capacity alarm	: 400 mAh
temperature	: 24.4 'C	Remaining time alarm	: 10 min
current	: 1330 mA	Battery mode	: 0
average current	: 1327 mA	AtRate	: 0 mA
relative state of charge	: 93 %	At rate time to full	: 65535 min
absolute state of charge	: 89 %	At rate time to empty	: 65535 min
remaining capacity	: 3546 mAh	At rate O. K.	: FFFF
full charge capacity	: 3800 mAh	Maximun error	: 2 %
run time to empty	: -1 min.	Charging current	: 2800 mA
average time to empty	: -1 min.	Charging voltage	: 12600 mA
average time to full	: 101 min.	Manufacturer name	: SANYO
cycle count	: 10 times	Device name	: NS2P3SZDQVWR
design capacity	: 4000 mAh	Device chemistry	: LION
design voltage	: 11100 mV	Manufacturer data	: 0
specification information	: 2.1	Manufacture date	: 9/13/2005
serial no.	: 32009		
STATUS	: INIT		

Press [ESC] KEY to exit

Subtest 03 CPU Temperature

This will display CPU Temperature for check , press [ESC] to exit .

[CPU\_TEMP.EXE] Program Version : 1.3 03-09-2009

CPU Temperature : XX

GPU Temperature : XX

**NOTES:** *If no external Graphics , GPU not report temperature . when read data is 255 mean no external Graphics .*

Subtest 04 3D HDD Protection Test (90d)

1. For Field inspection T&D.

This program judges by sampling five kinds of data shown below.

No	Item	Contents
1	Access platform.	An access platform is leveling.
2	Test Fixture	The Fixture which fixes PC by 90 degree inclination is used. Vibration/shock doesn't take a PCB at the time of T&D inspection.

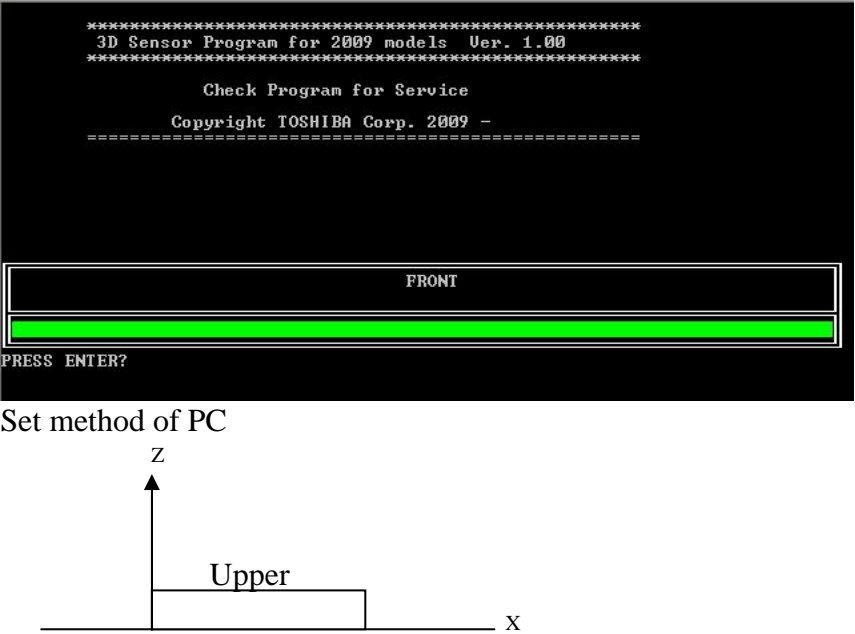
3	Test1	<p>The display of a test program and the set method of PC are shown below.</p> <p>Display of a Test Program The portion which PC and Test-Fixture contact is green.</p>  <p>Set method of PC</p> <p>Judgment If all data is less than ranges, it will be OK.</p>
---	-------	---

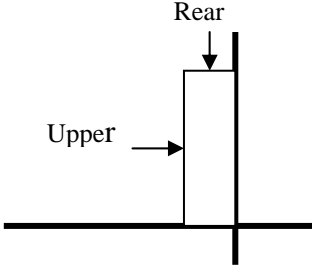
4	Test2	<p>The display of a test program and the set method of PC are shown below.</p> <p>Display of a Test Program</p>  <p>Set method of PC</p>  <p>Judgment If all data is less than ranges, it will be OK.</p>
---	-------	--

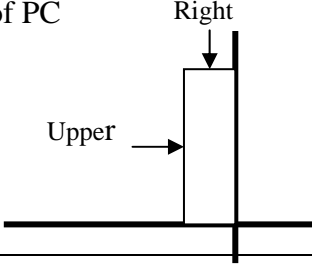
5	Test3	<p>The display of a test program and the set method of PC are shown below.</p> <p>Display of a Test Program</p>  <p>Set method of PC</p>  <p>Judgment If all data is less than ranges, it will be OK.</p>
---	-------	--

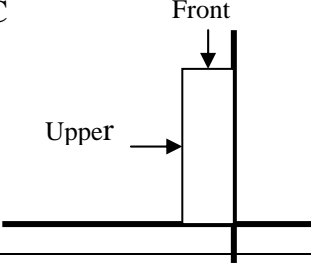
6	Test4	<p>The display of a test program and the set method of PC are shown below.</p> <p>Display of a Test Program</p>  <p>Set method of PC</p>  <p>Judgment If all data is less than ranges, it will be OK.</p>
---	-------	--

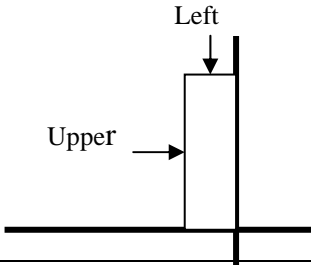
7	Test5	<p>The display of a test program and the set method of PC are shown below.</p> <p>Display of a Test Program</p>  <p>Set method of PC</p> 
		<p>Judgment If all data is less than ranges, it will be OK.</p>
8	Inspection	<p>Judgment If all data is less than ranges, it will be OK.</p>
9	Setting Calibration data	<p>When an inspection result is O.K., calibration at HPC.</p>

2. Test Result

A test result is displayed when a test is completed. A display of result is O.K. or NG.  
 And an error flag is returned at the end of a program.  
 OK is 0.  
 NG is 1.

### 3.5 Memory Test

To execute the Memory Test select **02** from the Diagnostic Test Menu, press **Enter** and follow the directions on the screen. The Memory Test contains five subtests that test the computer's memory. Move the highlight bar to the subtest you want to execute and press **Enter**.

***NOTE:** If **NO** is selected for Test Loop on the Test Parameter menu, the Test Status screen displays while the test is executing. When the test is complete the Memory Test menu displays.*

*If **YES** is selected for Test Loop on the Test Parameter menu, the Test Status screen displays while the test is executing. Press **Ctrl + break** to return to the Memory Test menu.*

#### Subtest 01 Conventional Memory

This subtest first writes test data patterns to conventional memory (0 to 640 KB), then reads the new data and compares the result with the original data patterns.

If a compare error occurs, the write data, read data, and test address display on the screen. Addresses are displayed in 4KB increments during the test.

#### **Test Process:**

1. Byte Enable Test  
"One bit write/ 8 bit read" is executed and the new data is compared with the original data.  
Test data = CCAA5533H, 80000000H
2. Byte Enable Test  
"One bit write/16 bit read" is executed and the new data is compared with the original data.  
Test data = CCAA5533H, 80000000H
3. Data bus test  
"One bit write/16 bit read" is executed and the new data is compared with the original data.  
Test data = 1H, 2H, 4H, 8H, 10H, through 80000000H.
4. Fixed data test  
"16 bit write/ 16 bit read" is executed and the new data is compared to the original data.  
Test data = FFFFFFFFH, 00000000H, 80018001H



5. Address pattern test  
“16 bit write and 16 bit read” of address pattern data is executed and the new data is compared with the original data.  
Test data = 0000H, 0004H, 0008H, 000CH,...8000H, 8004H, through FFECH

Subtest 02      Protected Mode

This subtest first writes data patterns and address data from 1 to 32 MB, then reads the new data and compares the result with the original data patterns. Addresses are displayed in 64KB increments during the test.

**Test Process:**

1. Byte Enable Test  
“One bit write/ 8 bit read” is executed and the new data is compared with the original data.  
Test data = CCAA5533H, 80000000H
2. Byte Enable Test  
“One bit write/16 bit read” is executed and the new data is compared with the original data.  
Test data = CCAA5533H, 80000000H
3. Data bus test  
“One bit write/16 bit read” is executed and the new data is compared with the original data.  
Test data = 1H, 2H, 4H, 8H, 10H, through 80000000H.
4. Fixed data test  
“16 bit write/ 16 bit read” is executed and the new data is compared to the original data.  
Test data = FFFFFFFFH, 00000000H, 80018001H
5. Address pattern test  
“16 bit write and 16 bit read” of address pattern data is executed and the new data is compared with the original data.  
Test data = 0000H, 0004H, 0008H, 000CH,...8000H, 8004H, through FFECH

Subtest 03      Protected Mode [32MB - MAX]

This subtest first writes data patterns and address data from 32MB to the maximum installed memory, reads the new data, and then compares the result

with the original data patterns. Addresses are displayed in 64KB increments during the test.

**Test Process:**

1. Byte Enable Test  
“One bit write/ 8 bit read” is executed and the new data is compared with the original data.  
Test data = CCAA5533H, 80000000H
2. Byte Enable Test  
“One bit write/16 bit read” is executed and the new data is compared with the original data.  
Test data = CCAA5533H, 80000000H
3. Data bus test  
“One bit write/16 bit read” is executed and the new data is compared with the original data.  
Test data = 1H, 2H, 4H, 8H, 10H, through 80000000H.
4. Fixed data test  
“16 bit write/ 16 bit read” is executed and the new data is compared to the original data.  
Test data = FFFFFFFFH, 00000000H, 80018001H
5. Address pattern test  
“16 bit write and 16 bit read” of address pattern data is executed and the new data is compared with the original data.  
Test data = 0000H, 0004H, 0008H, 000CH,...8000H, 8004H, through FFECH

Subtest 04      RAM Refresh

This subtest writes a data pattern (CCAA5533H ) in 4KB from 0 to the maximum installed memory, then waits for a memory refresh cycle (16 ms or more), reads the new data, and compares the result with the original data pattern.

**Test Process:**

1. Checks the memory size to determine the maximum size of installed memory.
2. Tests memory addresses 0 to the maximum installed.
3. Writes, reads, and compares test data after a memory refresh cycle (16ms or more).

***NOTE:** There may be a short delay between write and read operations, depending on the memory size.*

Subtest 05      Stress Test

This subtest writes the following 16KB data patterns to the Write/Read Buffer in conventional memory.

```
data:  FFFFFFFFFFFFFFFFFF0000000000000000
       5555555555555555AAAAAAAAAAAAAAAA
       CCCCCCCCCCCCCCCC3333333333333333
       0000000000000000FFFFFFFFFFFFFFFF
       AAAAAAAAAAAAAAAAAA55555555555555
       3333333333333333CCCCCCCCCCCCCCCC
       FFFFFFFFFFFFFFFFFF0000000000000000
       0000000000000000FFFFFFFFFFFFFFFF
       5555555555555555AAAAAAAAAAAAAAAA
       AAAAAAAAAAAAAAAAAA55555555555555
       CCCCCCCCCCCCCCCC3333333333333333
       3333333333333333CCCCCCCCCCCCCCCC
```

### 3.6 Keyboard Test

To execute the Keyboard Test select **03** from the Diagnostic Test Menu, press **Enter** and follow the directions on the screen. The Keyboard Test contains five subtests that test the computer's keyboard and mouse actions. Move the highlight bar to the subtest you want to execute and press **Enter**.

***NOTE:** The Test Loop and Error Stop parameters are not enabled for the Keyboard test. When test Fn key need press "Fn + \*", " \* " is the same "P" key .*

#### Subtest 01      Pressed Key Display [85J Keyboard]

When you execute this subtest, the keyboard layout is drawn on the display. When any key is pressed, the corresponding key on the screen changes from light to dark. Holding a key down enables the auto-repeat function which causes the key's display character to blink.

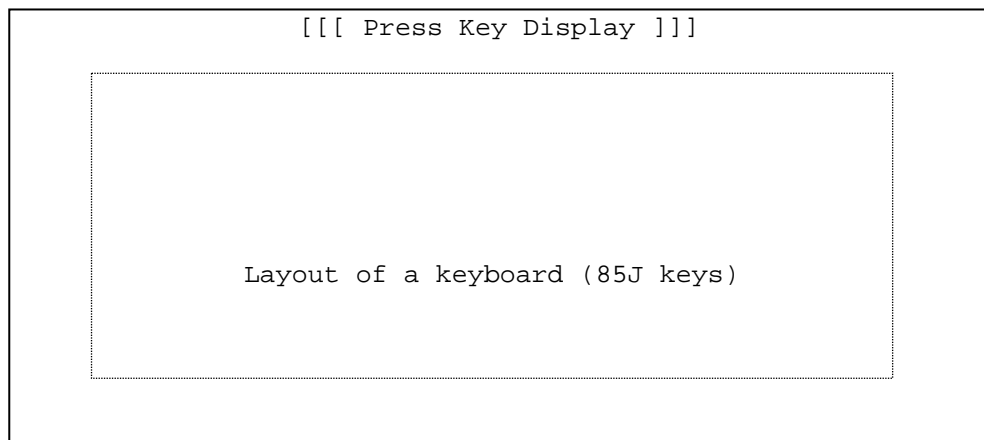

#### Subtest 02      Pressed Key Display [86 Keyboard]

This subtest is used for the 86 keyboard and functions the same as Subtest 1.

#### Subtest 03      Pressed Key Display [85 Keyboard]

This subtest is used for the 85 keyboard and functions the same as Subtest 1.

Subtest 04 PS/2 Mouse (Pointing)

This subtest checks the function of mouse as shown below.

- A) Pointing device (mouse)
- B) Mouse buttons

Please move cursor to upper left and press left button , screen will display <PRESS> in left rectangle , move cursor to lower right and press right button , screen will display <PRESS> in right rectangle , the program exit .

If left and right button short , screen will display <Left and Right Button maybe short > , the program exit .

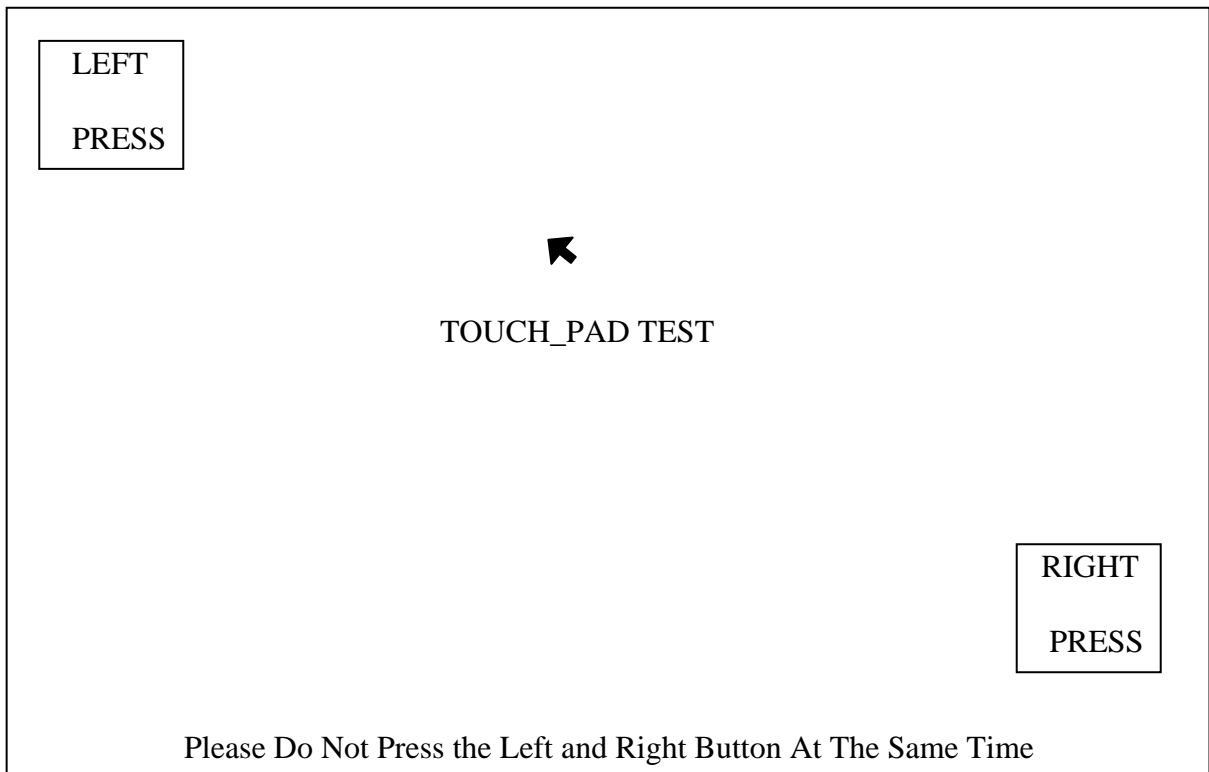



**Test Program for Field.**

---

Press **Enter** if **NO** was selected for *Test Loop* on the Test Parameter Menu.  
Press **Ctrl + break** if **YES** was selected for *Test Loop* on the Test Parameter Menu.

Subtest 02      Character Set

This subtest displays the character codes 00H - FFH, using Mode 01H (40\*25). The screen below displays when this subtest is executed.

CHARACTER SET IN 40\*25

```
  ☉ ☽ ♁ ♃ ♄ ♅ ♆ ♇ ♈ ♉ ♊ ♋ ♌ ♍ ♎ ♏ ♐ ♑ ♒ ♓ ♄ ♅ ♆ ♇ ♈ ♉ ♊ ♋ ♌ ♍ ♎ ♏ ♐ ♑ ♒ ♓
  ( ) * + , - . / 0 1 2 3 4 5 6 7 8 9 : ; < = > ? @ A B C D E F G H I J K L M N O
  P Q R S T U V W X Y Z [ \ ] ^ _ ` a b c d e f g h i j k l m n o p q r s t u v w
  x y z { | } ~ Δ Ç ü é â ã ä å ç è ë ì î ï Ì Å Ê Æ Æ ò ö ÷ ù ù ý Ò Ù ç £ ¥ Ft f
  á î ô ú ñ Ñ â ã ä å ç è ë ì î ï Ì Å Ê Æ Æ ò ö ÷ ù ù ý Ò Ù ç £ ¥ Ft f
  Æ Æ Æ Æ Æ Æ Æ Æ Æ Æ Æ Æ Æ Æ Æ Æ Æ Æ Æ Æ Æ Æ Æ Æ Æ Æ Æ Æ Æ Æ Æ Æ Æ Æ Æ Æ Æ Æ
  ≡ ± ≥ ≤ ∫ ∞ ° • - √ ° ² ■
```

Press [Enter] Key

To exit this subtest and return to the Display Test menu:

Press **Enter** if **NO** was selected for *Test Loop* on the Test Parameter Menu.  
Press **Ctrl + break** if **YES** was selected for *Test Loop* on the Test Parameter Menu.

Subtest 03      80 \* 25 Character Display

This subtest uses 80\*25 video resolution to display character codes 20H - 7EH using Mode 03H (80\*25). The data displayed is shifted 1 byte to the left for each line as shown below.

```
80*25 CHARACTER DISPLAY
0123456789012345678901234567890123456789012345678901234567890123456789
!"#$%&'()*+,-./0123456789:;<=>?@ABCDEFGHIJKLMNPOQRSTUVWXYZ[\]^_`abcdefghijklmnop
!"#$%&'()*+,-./0123456789:;<=>?@ABCDEFGHIJKLMNPOQRSTUVWXYZ[\]^_`abcdefghijklmnop
!"#$%&'()*+,-./0123456789:;<=>?@ABCDEFGHIJKLMNPOQRSTUVWXYZ[\]^_`abcdefghijklmnop
!"#$%&'()*+,-./0123456789:;<=>?@ABCDEFGHIJKLMNPOQRSTUVWXYZ[\]^_`abcdefghijklmnopqr
!"#$%&'()*+,-./0123456789:;<=>?@ABCDEFGHIJKLMNPOQRSTUVWXYZ[\]^_`abcdefghijklmnopqrs
!"#$%&'()*+,-./0123456789:;<=>?@ABCDEFGHIJKLMNPOQRSTUVWXYZ[\]^_`abcdefghijklmnopqrst
!"#$%&'()*+,-./0123456789:;<=>?@ABCDEFGHIJKLMNPOQRSTUVWXYZ[\]^_`abcdefghijklmnopqrstu
!"#$%&'()*+,-./0123456789:;<=>?@ABCDEFGHIJKLMNPOQRSTUVWXYZ[\]^_`abcdefghijklmnopqrstuv
```

Shifted to the left one letter by one letter.

```
23456789:;<=>?@ABCDEFGHIJKLMNPOQRSTUVWXYZ[\]^_`abcdefghijklmnop gh I j k l mnopqrst
3456789:;<=>?@ABCDEFGHIJKLMNPOQRSTUVWXYZ[\]^_`abcdefghijklmnop gh I j k l mnopqrst
456789:;<=>?@ABCDEFGHIJKLMNPOQRSTUVWXYZ[\]^_`abcdefghijklmnop gh I j k l mnopqrst
```

Press [Enter] KEY

To exit this subtest and return to the Display Test menu:

Press **Enter** if **NO** was selected for *Test Loop* on the Test Parameter Menu.  
Press **Ctrl + break** if **YES** was selected for *Test Loop* on the Test Parameter Menu.



*Test Program for Field.*

---

Subtest 04    320 \* 200 Character Display

This subtest uses 320\*200 video resolution to display green, red and yellow followed by cyan, magenta, and white. The screen below shows the displays when this subtest is executed.

320 \* 200 GRAPHICS DISPLAY

COLOR SET 0 : [ 4 ]

GREEN  
CYAN

RED  
MAGENTA

YELLOW  
WHITE



Press **ENTER** to display the following sixteen colors: black, blue, green, cyan, red, magenta, brown, white, dark gray, light blue, light green, light cyan, light red, light magenta, yellow, and intensified white.

320\*200 GRAPHICS DISPLAY : [ D ]

BLACK	<input type="text"/>	<input type="text"/>	D GRAY
BLUE	<input type="text"/>	<input type="text"/>	L BLUE
GREEN	<input type="text"/>	<input type="text"/>	L GREEN
CYAN	<input type="text"/>	<input type="text"/>	L CYAN
RED	<input type="text"/>	<input type="text"/>	L RED
MAGENTA	<input type="text"/>	<input type="text"/>	L MAGENTA
BROWN	<input type="text"/>	<input type="text"/>	YELLOW
WHITE	<input type="text"/>	<input type="text"/>	I WHITE

Press [Enter] KEY

<input type="text"/>	<input type="text"/>
----------------------	----------------------

Press **ENTER** to display 64 gradations of red, green, blue and white on the screen

320\*200 GRAPHICS DISPLAY : [ 13 ]

64 gradations of red are displayed.
64 gradations of green are displayed.
64 gradations of blue are displayed.
64 gradations of white are displayed.

Press [Enter] KEY

To exit this subtest and return to the Display Test menu:

Press **Enter** if **NO** was selected for *Test Loop* on the Test Parameter Menu.  
Press **Ctrl + break** if **YES** was selected for *Test Loop* on the Test Parameter Menu.

## Test Program for Field.

---

### Subtest 05 640 \* 200 Character Display

This subtest uses 640\*200 video resolution to display three windows, each window drives a different set of dots: even dots, odd dots and all dots. The screen below displays when this subtest is executed.

640 \* 200 GRAPHICS DISPLAY : [ 6 ]

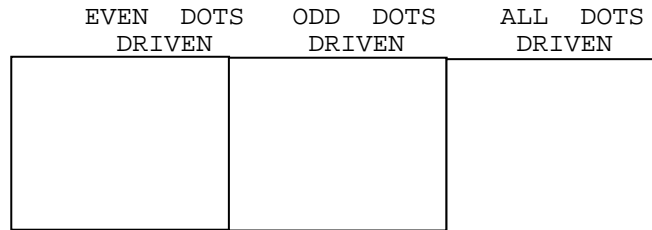

Press **ENTER** to display the following 16 colors: black, blue, green, cyan, red, magenta, brown, white, dark gray, light blue, light green, light cyan, light red, light magenta, yellow, and intensified white.

640\*200 GRAPHICS DISPLAY : [ E ]

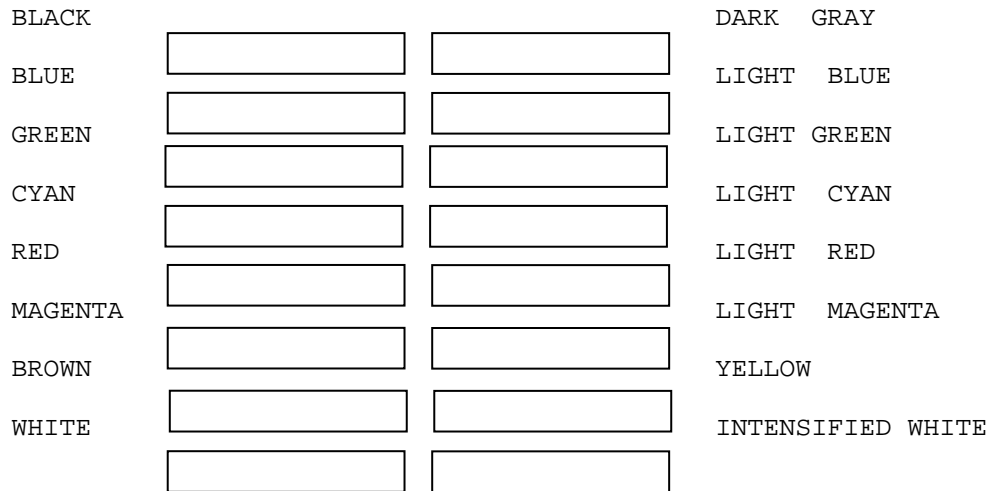

Press [Enter] KEY

To exit this subtest and return to the Display Test menu:

Press **Enter** if **NO** was selected for *Test Loop* on the Test Parameter Menu.  
Press **Ctrl + break** if **YES** was selected for *Test Loop* on the Test Parameter Menu.

Subtest 06 640 \* 480 Character Display

This subtest uses 640\*350 video resolution to display 16 colors: black, blue, green, cyan, red, magenta, brown, white, dark gray, light blue, light green, light cyan, light red, light magenta, yellow, and intensified white. The screen below displays when this subtest is executed.

640\*350 GRAPHICS DISPLAY : [ 10 ]

BLACK	<input type="text"/>	<input type="text"/>	DARK GRAY
BLUE	<input type="text"/>	<input type="text"/>	LIGHT BLUE
GREEN	<input type="text"/>	<input type="text"/>	LIGHT GREEN
CYAN	<input type="text"/>	<input type="text"/>	LIGHT CYAN
RED	<input type="text"/>	<input type="text"/>	LIGHT RED
MAGENTA	<input type="text"/>	<input type="text"/>	LIGHT MAGENTA
BROWN	<input type="text"/>	<input type="text"/>	YELLOW
WHITE	<input type="text"/>	<input type="text"/>	INTENSIFIED WHITE
Press [Enter]	<input type="text"/>	<input type="text"/>	

Press **ENTER** to display the following 16 colors: black, blue, green, cyan, red, magenta, brown, white, dark gray, light blue, light green, light cyan, light red, light magenta, yellow, and intensified white using 640\*480 video resolution.

***Test Program for Field.***

---

640\*480 GRAPHICS DISPLAY : [ 12 ]

BLACK	<input type="text"/>	<input type="text"/>	DARK GRAY
BLUE	<input type="text"/>	<input type="text"/>	LIGHT BLUE
GREEN	<input type="text"/>	<input type="text"/>	LIGHT GREEN
CYAN	<input type="text"/>	<input type="text"/>	LIGHT CYAN
RED	<input type="text"/>	<input type="text"/>	LIGHT RED
MAGENTA	<input type="text"/>	<input type="text"/>	LIGHT MAGENTA
BROWN	<input type="text"/>	<input type="text"/>	YELLOW
WHITE	<input type="text"/>	<input type="text"/>	INTENSIFIED WHITE
	<input type="text"/>	<input type="text"/>	

Press [Enter] ~~RET~~

To exit this subtest and return to the Display Test menu:

Press **Enter** if **NO** was selected for *Test Loop* on the Test Parameter Menu.  
Press **Ctrl + break** if **YES** was selected for *Test Loop* on the Test Parameter Menu.



Subtest 08 "H" Pattern Display

This subtest displays a full screen of "H" patterns.

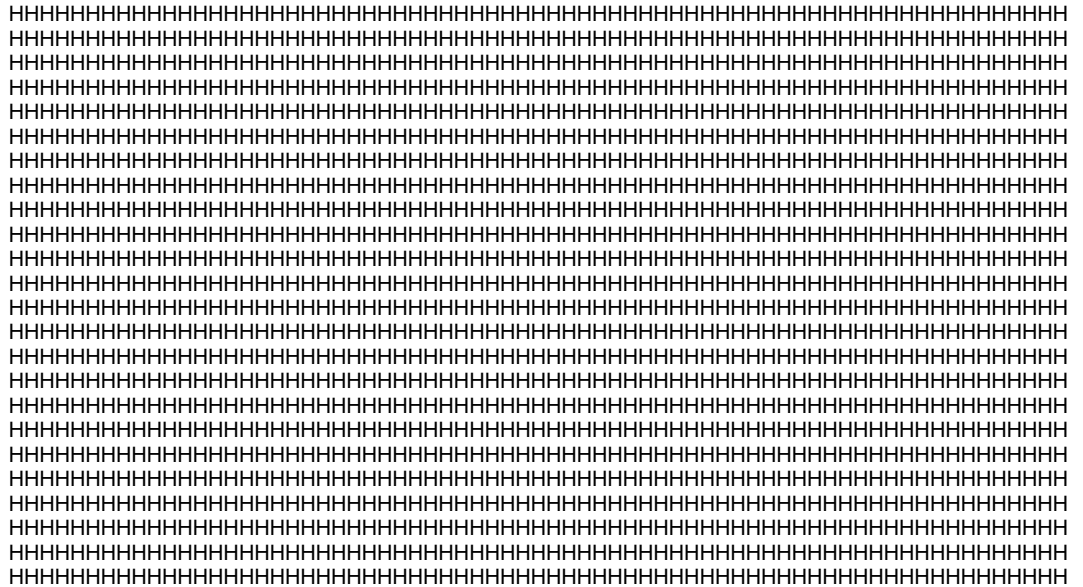

To exit this subtest and return to the Display Test menu:

Press **Enter** if **NO** was selected for *Test Loop* on the Test Parameter Menu.  
Press **Ctrl + break** if **YES** was selected for *Test Loop* on the Test Parameter Menu.

Subtest 9 Video DAC Register W/R/C

This subtest writes data patterns to the Video DAC register lookup table (PEL Address register), then reads the new data, and compares the result to the original data patterns. The original content of the Video DAC register is saved in RAM and restored after the test is completed.

The test data patterns are 00H, 15H, 2AH and 3FH.

***NOTE:** If **NO** is selected for Test Loop on the Test Parameter menu, “Screen will remain blank” displays on the screen while the test is executing. When the test is complete the Display Test menu displays.*

*If **YES** is selected for Test Loop on the Test Parameter menu, “The Screen will remain blank” displays on the screen and then the screen flickers due to the fast screen refresh while the test is executing. Press **Ctrl + break** to return to the Display Test menu.*

Subtest 10    Color Graphics Display

This subtest displays three colors, cyan, white and yellow on the screen as shown below.

640 \* 480 GRAPHICS DISPLAY

CYAN

WHITE

YELLOW

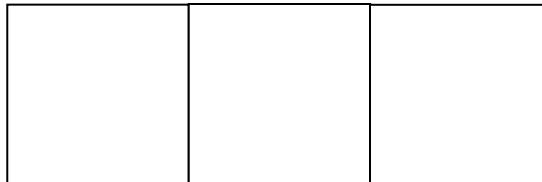

To exit this subtest and return to the Display Test menu:

Press **Enter** if **NO** was selected for *Test Loop* on the Test Parameter Menu.  
Press **Ctrl + break** if **YES** was selected for *Test Loop* on the Test Parameter Menu.



Subtest 11      Color Attributes Display

This subtest displays 16 colors: black, blue, green, cyan, red, magenta, brown, white, dark gray, light blue, light green, light cyan, light red, light magenta, yellow, and intensified white. The screen below displays when this subtest is executed.

640\*480 COLOR ATTRIBUTE DISPLAY

0	1	2	3	4	5	6	7	8	9	A	B	C	D	E	F
---	---	---	---	---	---	---	---	---	---	---	---	---	---	---	---

Press [Enter] Key

Pressing **Enter** executes VRAM mapping test which indicates vertical lines

Press **Enter** to execute the VRAM mapping test which displays a horizontal line at one dot intervals using Mode 12.

**NOTE:** *The following screen does not display correctly. It will be amended in the next version.*

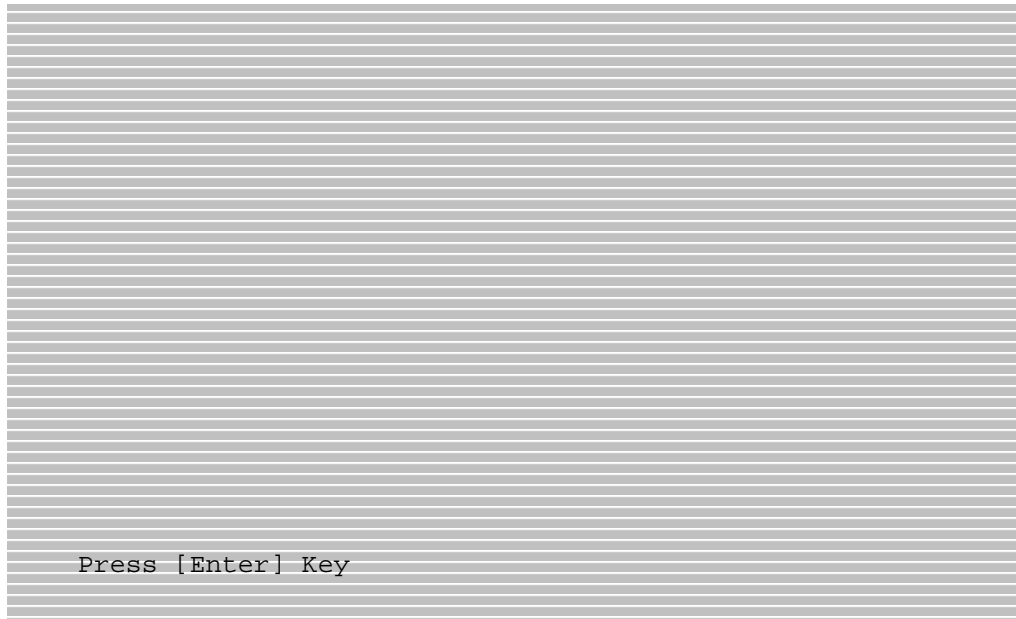

Press **Enter** to execute the VRAM mapping test which displays a vertical line at four dot intervals using Mode 12.

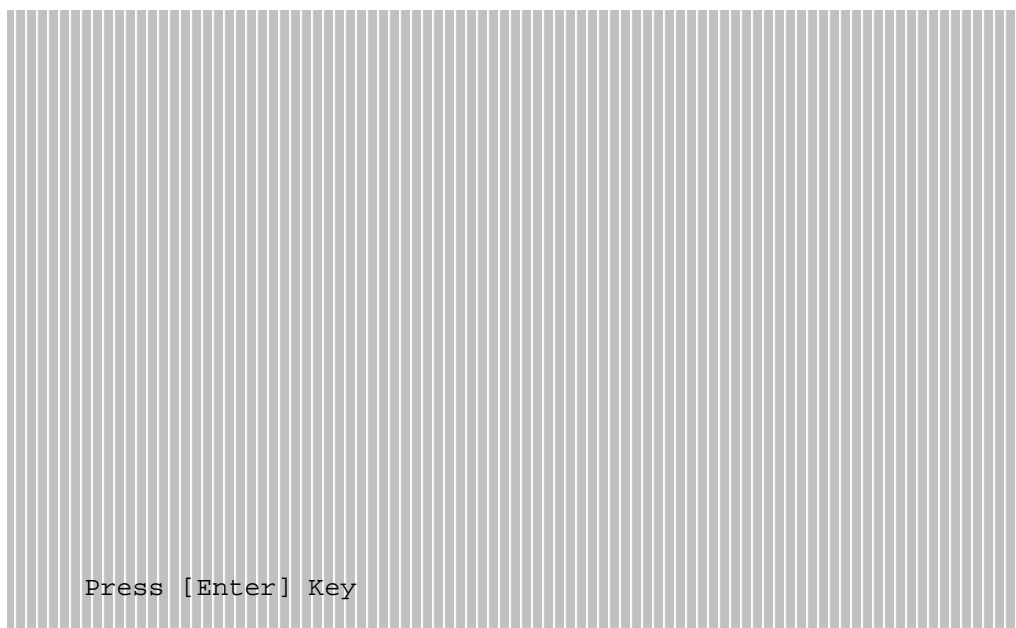

Press **Enter** to display VRAM mapping test using the all dots Mode.

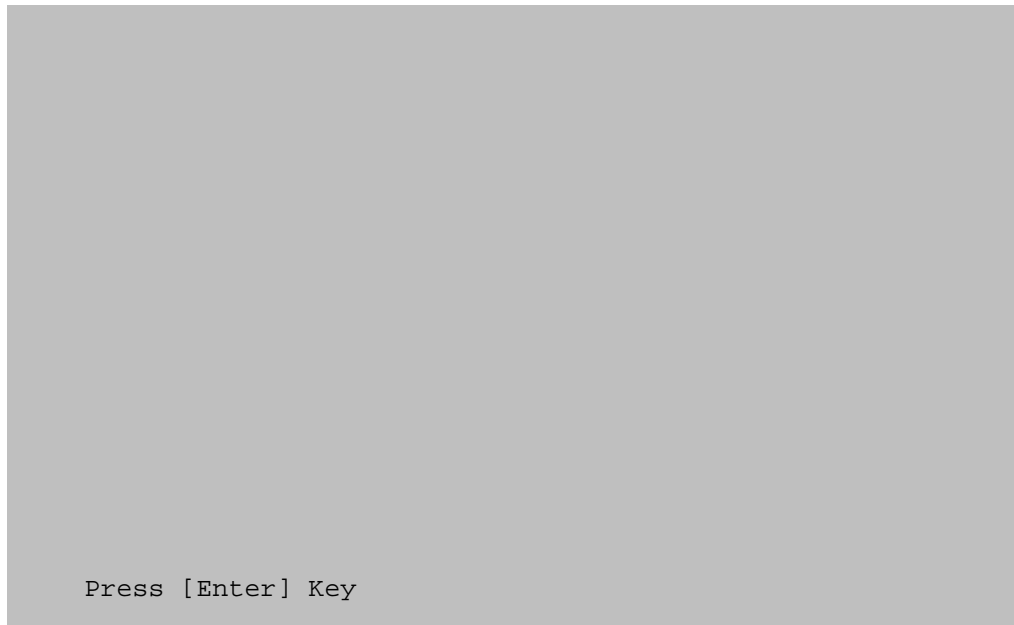

To exit this subtest and return to the Display Test menu:

Press **Enter** if **NO** was selected for *Test Loop* on the Test Parameter Menu.  
Press **Ctrl + break** if **YES** was selected for *Test Loop* on the Test Parameter Menu.

Subtest 12    Color Tiling

This subtest displays black, gray, white, and 3 gradations of red, green, and blue as shown in the following display.

Black	Red	Green	Blue
Gray	Red Gradation	Green Gradation	Blue Gradation
White	Red Gradation	Green Gradation	Blue Gradation

To exit this subtest and return to the Display Test menu:

Press **Enter** if **NO** was selected for *Test Loop* on the Test Parameter Menu.  
Press **Ctrl + break** if **YES** was selected for *Test Loop* on the Test Parameter Menu.

### **3.8 Floppy Disk Test**

***CAUTION:** Before running the floppy disk test, prepare a formatted work disk. Remove the diagnostics disk and insert the work disk into the FDD. The contents of the floppy disk will be erased.*

To execute the Floppy Disk Test select **05** from the Diagnostic Test Menu, press **Enter** and follow the directions on the screen. The Floppy Disk Test contains five subtests that test the FDD. Move the highlight bar to the subtest you want to execute and press **Enter**.

Subtest 01      Sequential Read

This subtest sequentially reads all the tracks (Tracks 0 to 79) on the floppy disk.

Subtest 02      Sequential W/R/C

This subtest continuously writes the data pattern B5ADADh to all the specified tracks selected in Subtest 01. The data pattern is then read and compared to the original data.

Subtest 03      Random Address/Data

This subtest writes random data to random addresses on all tracks defined in Subtest 01. The data is then read and compared to the original data.

Subtest 04 Write Specified Address

***NOTE:** The first two digits of the ADDRESS indicate which track is being tested, the next two digits indicates the head, and the last two digits indicate the sector.*

This subtest allows you to verify the errors from Subtest 02. It writes specified data to a specified track and head. Use the Log Utilities (see Section 3.21) to specify the track number and head number where the error(s) occurred during Subtest 02. The following message displays on the screen to enter the test data, track number, and head number.

```
TEST DATA ??  
TRACK NO (00~79) ??  
HEAD NO (0~1) ?
```

Subtest 05 Read Specified Address

This subtest reads data from a specified track and head.

The following message displays on the screen to enter the test track number and head number.

```
TRACK NO (00~79) ??  
HEAD NO (0~1) ?
```

### 3.9 Hard Disk Test

To execute the Hard Disk Test select **06** from the Diagnostic Test Menu, press **Enter** and follow the directions on the screen. The Hard Disk Test contains eight subtests that test the functions of the hard disk drive. Move the highlight bar to the subtest you want to execute and press **Enter**.

***NOTES:** The contents of the hard disk will be erased when subtest 02, 03, 04, 05, 07 or 08 is executed. Before running the test, transfer the contents of the hard disk to other disk. A password is necessary to execute the Hard Disk Test. The password is: **hard disk***

Subtest 01      Sequential Read

This subtest sequentially reads all the tracks on the HDD starting at track 0. When all tracks have been read, the test starts at the maximum track and reads sequentially back to track 0.

Subtest 02      Address Uniqueness (This subtest need very long time)

This subtest writes unique address data to each sector of the HDD track-by-track. The data written to each sector is then read and compared with the original data. There are three ways the HDD can be read:

- Forward sequential
- Reverse sequential
- Random

Subtest 03      Random Address Data

This subtest writes random data to 1000 different random addresses on the HDD. This data is then read and compared to the original data.

Subtest 04      Cross Talk and Peak Shift

This subtest writes eight of the most likely to fail data patterns (shown below) to a cylinder on the HDD, then reads the data while moving from cylinder to cylinder.

**Data Pattern**

B5ADADH  
4A5252H  
EB6DB6H  
149249H  
63B63BH  
9C49C4H  
2DB6DBH  
D24924H

Subtest 05      Write Specified Address

**NOTE:** *This subtest is designed to run with the Test Loop set to NO. This subtest is a debug tool and the operator should enter the Test Parameters each time.*

This subtest allows you to verify the errors from Subtest 01. It writes specified data to a specified LBA. Use the Log Utilities (see Section 3.18) to specify the LBA number where the error(s) occurred during Subtest 01. The following message displays on the screen to enter the test data, and Sector count.

```
TEST DATA            ??  
SECTOR COUNT (01~39) ??  
START ADDRESS (00000000~MAX Address) ?
```

Subtest 06      Read Specified Address

**NOTE:** *This subtest is designed to run with the Test Loop set to NO. This subtest is a debug tool and the operator should enter the Test Parameters each time.*

This subtest allows you to verify the errors from Subtest 01. It reads specified data (Subtest 06) from a specified LBA. Use the Log Utilities (see Section 3.18) to specify the LBA number where the error(s) occurred during Subtest 01. The following message displays on the screen to enter the test sector count.

```
SECTOR COUNT (01~39) ??  
START ADDRESS (00000000~MAX Address) ?
```



Subtest 07      Sequential Write

This subtest writes specified data to all cylinders on the HDD. The following message displays on the screen to enter the test data.

TEST DATA    ????? (=37b3H)

Subtest 08      W-R-C Specified Address

This subtest writes specified data to a specified sector count, then reads and compares the result. The following message displays on the screen to enter the test data, sector count.

TEST DATA    ????? (=37b3H)  
SECTOR COUNT (01~39) ??  
START ADDRESS (00000000~Max Address) ?

### 3.10 Real Time Clock Test

To execute the Real Time Clock Test select **07** from the Diagnostic Test Menu, press **Enter** and follow the directions on the screen. The Real Time Clock Test contains three subtests that test the computer's real time functions. Move the highlight bar to the subtest you want to execute and press **Enter**.

#### Subtest 01 Real Time

This subtest allows you to change the date and time. To execute the Real Time Subtest, follow these steps:

1. Select Subtest **01** and the following displays:

```
[ REAL TIME TEST ]  
  
Current date : mm-dd-yyyy  
Current time : hh:mm:ss  
  
Enter new date : mm-dd-yyyy  
Enter new time : hh:mm:ss  
  
Press [Enter] key to exit test
```

2. If the current date is not correct, enter the correct date at the "Enter new date" prompt and press **Enter**. The following prompt displays:  

```
Enter new time :
```
3. If the current time is not correct, enter the correct time using a 24-hour format and press **Enter**.

**NOTE:** If **NO** is selected for Test Loop on the Test Parameter menu, the Real Time Clock Test menu displays.  
If **YES** is selected for Test Loop on the Test Parameter menu, the screen above displays and the test is executed again. Press **Ctrl + break** to return to the Real Time Clock Test menu.

Subtest 02 Backup Memory

This subtest writes 50 bytes of test data (FFH, AAH, 55H, and 00H) to the CMOS 14<sup>th</sup> address, then reads the new data and compares it to the original data.

Subtest 03 Real Time Carry

<p><b>CAUTION:</b> <i>When this subtest is executed, the current date and time are reset.</i></p>
---

This subtest checks the clock's carry function.

```
                [ REAL TIME CARRY TEST ]  
  
Current date : 12-31-1999  
Current time : 23:59:55  
  
Press [Enter] key to exit test
```

The following is the display after the date carry function is executed.

```
                [ REAL TIME CARRY TEST ]  
  
Current date : 01-01-2000  
Current time : 00:00:01  
  
Press [Enter] key to exit test
```

To exit this subtest and return to the Real Time Clock menu:

Press **Enter** if **NO** was selected for *Test Loop* on the Test Parameter Menu.  
Press **Ctrl + break** if **YES** was selected for *Test Loop* on the Test Parameter Menu.

### 3.11 Cache Memory Test

To execute the Cache Memory Test select **08** from the Diagnostic Test Menu, press **Enter** and follow the directions on the screen. The Cache Memory Test contains eight subtests that test the computer's cache memory. Move the highlight bar to the subtest you want to execute and press **Enter**.

***NOTE:** If **NO** is selected for Test Loop on the Test Parameter menu, the screen will remain blank while the subtest is executing. When the test is complete the Cache Memory Test menu displays.*

*If **YES** is selected for Test Loop on the Test Parameter menu, the Test Status screen displays while the subtest is executing. Press **Ctrl + break** to return to the Cache Memory Test menu.*

#### Subtest 01 Constant Data Test

This subtest reads the contents of cache memory and saves it into RAM. The subtest then writes constant data (FFFFH, AAAAH, 5555H, 0101H, 0000H), reads the new data and compares the result with the original data pattern. The original cache memory content is then restored to the cache memory.

#### Subtest 02 Address Pattern Test

This subtest reads the contents of cache memory and saves it into RAM. The subtest then writes address data patterns (0000H, 0001H, 0002H, through 3FFDH, 3FFEH, 3FFFH), reads the new data and compares the result with the original data. The original cache memory content is then restored to the cache memory.

#### Subtest 03 Increment/Decrement Test

This subtest reads the contents of cache memory and saves it into RAM. The subtest then writes the increment data (00H, 01H, 02H, through FDH, FEH, FFH), reads the new data and compares the result with the original data. After comparing the incremental data, decrement data (FFH, FEH, FEH, through 02H, 01H, 00H) is written and the new data is read and compared with the original data. The original cache memory content is then restored to the cache memory.

Subtest 04 Bit Shift Pattern Test

This subtest reads the contents of cache memory and saves it into RAM. The subtest then writes the bit shift data patterns (1 bit shifted every 4 bytes), reads the new data and compares the result with the original data. The original cache memory content is then restored to the cache memory.

Subtest 05 Write Disturb Test (We can't support this time)

This subtest reads the contents of cache memory and saves it into RAM. The subtest then writes the "write disturb data," reads the new data and compares the result with the original data. The original cache memory content is then restored to the cache memory.

Subtest 06 Checker Board Test

This subtest reads the contents of cache memory and saves it into RAM. The subtest then writes the "checker board data," (data which is inverted front/back and left/right) reads the new data and compares the result with the original data. The original cache memory content is then restored to the cache memory.

Subtest 07 Marching Test

This subtest reads the contents of cache memory and saves it into RAM. The subtest then writes the "marching data," (00H through 01H and 01H through 00H) reads the new data and compares the result with the original data. The original cache memory content is then restored to the cache memory.

Subtest 08 Working Data Test

This subtest reads the contents of cache memory and saves it into RAM. The subtest then writes the "working data," reads the new data and compares the result with the original data. The original cache memory content is then restored to the cache memory.

### 3.12 High Resolution Display Test

To execute the High Resolution Display Test select **09** from the Diagnostic Test Menu, press **Enter** and follow the directions on the screen. The High Resolution Display Test contains six subtests that test the computer's high resolution video display. Move the highlight bar to the subtest you want to execute and press **Enter**.

#### Subtest 01 VRAM W/R/C Test

This subtest writes address and data patterns to Video RAM, then reads the values from the Video RAM and compares them to the original test patterns. During the execution of this test 13 different color screens display: black, green, green, blue, blue, red, red, red, black, white, pink, cyan, and black.

#### **Test Process:**

1. Sets the video display to 1024\*768 mode
2. Bank change test  
Writes 1 byte data in order 0, 1, through Fh, and compares the result, at every bank, to the original data patterns.
3. Bit shift data test  
Writes 01h data into addresses A000:0000h through A000:FFFFh for each bank, reads the new data and, then compares the results with the original data. Data is then shifted 1 bit to the left, and all bits (01h, 02h, 04h, 08h, through 80h) are tested again.
4. Fixed data test  
Writes test data (in order FFh, AAh, 55h, 00h) into addresses A000:0000h through A000:FFFFh for each bank by, reads the new data and, then compares the results with the original data. Data is then shifted 1 bit to the left, and all bits are tested again

**NOTE:** *If **NO** is selected for Test Loop on the Test Parameter menu, the screen displays the colors listed above and then the High Resolution Display Test menu displays.*

*If **YES** is selected for Test Loop on the Test Parameter menu, the screen displays the colors listed above. Press **Ctrl + break** to return to the High Resolution Display Test menu.*

**Test Program for Field.**

Subtest 02 640\*480 Mode Display

This subtest uses 640\*480 video resolution to display a high resolution white frame, 256 letter types (8\*16 pixels) and 64 gradations of white, red, green, and blue as shown below.

[ 640\*480 256 ]

Press [ Enter ]key

256 letter types indication

	0-----1-----2-----3-----4-----5-----6----
WHITE	64 gradations
RED	64 gradations
GREEN	64 gradations
BLUE	64 gradations

To exit this subtest and return to the High Resolution Display Test menu:

Press **Enter** if **NO** was selected for *Test Loop* on the Test Parameter Menu.  
 Press **Ctrl + break** if **YES** was selected for *Test Loop* on the Test Parameter Menu.

Subtest 03 800 \* 600 Mode Display

This subtest uses 800\*600 video resolution to display a high resolution white frame, 256 letter types (8\*16 pixels) and 256 gradations of white, red, green, and blue as shown below.

[ 800\*600 256 ]

Press [ Enter ] key

256 letter types indication

	0-----1-----2-----3-----4-----5-----6-----
WHITE	64 gradations
RED	64 gradations
GREEN	64 gradations
BLUE	64 gradations

To exit this subtest and return to the High Resolution Display Test menu:

Press **Enter** if **NO** was selected for *Test Loop* on the Test Parameter Menu.  
 Press **Ctrl + break** if **YES** was selected for *Test Loop* on the Test Parameter Menu



**Test Program for Field.**

Subtest 04 1024\* 768 Mode Display

This subtest uses 1024\*768 video resolution to display a high resolution white frame, 256 letter types (8\*16 pixels) and 64 gradations of white, red, green, and blue as shown below.

[ 1024\*768 256 ]

Press [ Enter ] key

256 letter types indication

	0-----1-----2-----3-----4-----5-----6----
WHITE	64 gradations
RED	64 gradations
GREEN	64 gradations
BLUE	64 gradations

To exit this subtest and return to the High Resolution Display Test menu:

Press **Enter** if **NO** was selected for *Test Loop* on the Test Parameter Menu.  
 Press **Ctrl + break** if **YES** was selected for *Test Loop* on the Test Parameter Menu.

Subtest 05 “H” Pattern Display

This subtest uses the 1024\*768 Mode to display a high resolution white frame, “H” letters (8\*16 pixels fonts), at 128 letters by 48 lines.

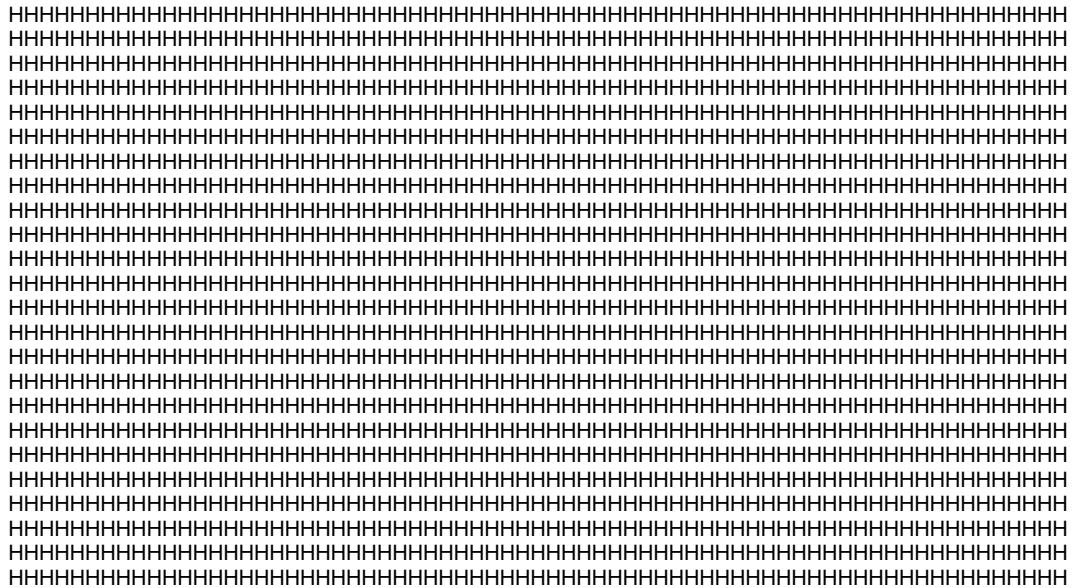

To exit this subtest and return to the High Resolution Display Test menu:

Press **Enter** if **NO** was selected for *Test Loop* on the Test Parameter Menu.  
Press **Ctrl + break** if **YES** was selected for *Test Loop* on the Test Parameter Menu.

Subtest 06      Focus Test ( “E” Pattern)

This subtest sets the 1024\*768 Mode and displays “E” patterns (18\*18 dot fonts), at 56 letters \*42 lines surrounded by a high resolution white frame.



To exit this subtest and return to the High Resolution Display Test menu:

Press **Enter** if **NO** was selected for *Test Loop* on the Test Parameter Menu.  
Press **Ctrl + break** if **YES** was selected for *Test Loop* on the Test Parameter Menu.

### 3.13 Multimedia Test

To execute the Multimedia Test select **10** from the Diagnostic Test Menu, press **Enter** and follow the directions on the screen. The Multimedia Test contains four subtests that test the computer's multimedia functions. Move the highlight bar to the subtest you want to execute and press **Enter**.

***NOTE:** Use the Toshiba Backup CD-ROM for Subtests 01, 02, and 03.  
Because CDRom driver issue , the Multimedia function can't test , this is limitation .*

#### Subtest 01 Sequential Read Test

This subtest sequentially reads one block unit (2K bytes) of all logical addresses from the test CD.

***NOTE:** If **NO** is selected for Test Loop on the Test Parameter Menu, the screen will remain blank while the subtest is executing. When the test is complete the Multimedia Test menu displays.  
If **YES** is selected for Test Loop on the Test Parameter Menu, the Test Status screen displays while the subtest is executing. Press **Ctrl + break** to return to the Multimedia Test menu.*

#### Subtest 02 Random Read Test

This subtest randomly reads all addresses.

#### Subtest 03 Read Specified Address Test

This subtest reads data from a specified block of addresses.

The following message displays on the screen to enter the start and end block addresses:

```
START BLOCK ADDRESS ?  
END BLOCK ADDRESS  ?
```

#### Subtest 04 1 Point W/R/C (R/RW Media)

***NOTE:** Use CD-R or CD-RW, the CD-ROM and DVD cannot be used for this subtest, and some DVD-dual can't support this test.*

This subtest writes specified data to a specified block count, then reads and compares the result.

### **3.14 MEMORY2 Test**

To execute the Expansion Test select **11** from the Diagnostic Test Menu, press **Enter** and follow the directions on the screen. The MEMORY2 Test contains four subtests that test the computer's. Move the highlight bar to the subtest you want to execute and press **Enter**.

***NOTE:** If **NO** is selected for Test Loop on the Test Parameter menu, the Test Status screen displays while the test is executing. When the test is complete the Memory Test menu displays.*

*If **YES** is selected for Test Loop on the Test Parameter menu, the Test Status screen displays while the test is executing. Press **Ctrl + break** to return to the Memory Test menu*

Subtest 01 All one/All zero test

This subtest performs pseudorandom data read/write. The data consists of “all ones”/“all zero” patterns produced by pseudorandom sequence generator. The test checks address error.

FFFFFFFFFFFFFFFF0000000000000000  
0000000000000000FFFFFFFFFFFFFFFF

Subtest 02 Walking 1/Walking 0 test (Left)

This subtest uses “running one”/“running zero” patterns. This test sequence allows also to checking system bus in maximum noise conditions. The following test sequence is written.

7FFF7FFF7FFF7FFF8000800080008000  
BFFFBFFFBFFFBFFF4000400040004000

After all the memory being tested is filled with the pattern, it is read in descending direction and compared with reference data. As the memory is read, the data is replaced with inverse test pattern. After all the memory is read and replaced with inverted pattern, it is read in descending direction and compare with new reference data. As the memory is read, the data is replaced with next pattern, which is like first one shifted to right.

Subtest 03 Walking 1/Walking 0 test (Right)

The test method is the same as Subtest2. However, the data to be used differs.

80008000800080007FFF7FFF7FFF7FFF  
4000400040004000BFFFBFFFBFFFBFFF

Subtest 04 Walking 1/Walking 0 test (Left/ Right)

The test method is the same as Subtest2. However, the data to be used differs.

```
7FFF7FFF7FFF7FFF8000800080008000  
BBBBBBBBBBBBBBBB4000400040004000  
DDDDDDDDDDDDDDDD2000200020002000
```

```
FFFBFFFBFFFBFFFB0004000400040004  
FFFDFFFDFFFDFFFD0002000200020002  
FFFFFFFFFFFFFFFFE0001000100010001  
80008000800080007FFF7FFF7FFF7FFF  
4000400040004000BFFFBFFFBFFFBFFFB
```

```
0004000400040004FFFBFFFBFFFBFFFB  
0002000200020002FFFDFFFDFFFDFFFD  
0001000100010001FFFFFFFFFFFFFFFFE
```

### 3.15 Error Codes and Error Status Names

The following table lists the error codes and error status names for the Diagnostic Tests.

*Table 3-2 Error codes and error status names (1/2)*

<b>Device Name</b>	<b>Error Code</b>	<b>Error Status Name</b>
(Common)	FF	Data Compare Error
Memory	02	Protected Mode Not Changed
	??	Other Error
FDD	01	Bad Command Error
	02	Address Mark Not Found
	03	Write Protected
	04	Record Not Found
	06	Media Change Line Error
	08	DMA Overrun Error
	09	DMA Boundary Error
	0C	Select Media Error
	10	CRC Error
	20	FDC Error
	40	Seek Error
	80	Time Out Error
??	Other Error	
HDD	01	Bad Command Error
	02	Bad Address Mark Error
	04	Record Not Found
	05	HDC Not Reset Error
	07	Drive Not Initialized
	09	DMA Boundary Error
	0A	Bad Sector
	0B	Bad Track Error
	10	ECC Error
	11	ECC Recover Enabled
	20	HDC Error
	40	Seek Error
	80	Time Out Error
AA	Drive Not Ready	

*Table 3-2 Error codes and error status names (2/2)*

<b>Device Name</b>	<b>Error Code</b>	<b>Error Status Name</b>
HDD	BB	Undefined Error
	CC	Write Fault
	E0	Status Error
	F0	No Sense Error
	??	Other Error
Cache Memory	02	Protect Mode Error
	03	Caching Error
	??	Other Error
Multimedia	01	Write Error
	0F	Invalid Drive
	15	Drive Not Ready
	??	Other Error

**NOTE:** If error status name is **Other Error** , please reference the **Error Code** for error information



### **3.16 Running Test**

**NOTES:**

1. *You may add or delete subtests using the Running Test Edit Item function, see Section 3.20.*
2. *Do not forget to insert a work disk in the FDD. If a work disk is not inserted an error will be generated during the Floppy Disk Test.*
3. *If the test completes successfully an “PASS” sign with blue letters displays on the screen.*
4. *If the test fails or is interrupted before completion an “FAIL” sign with red letters displays on the screen.*
5. *If running item not select an “NOITEM” sign with green letters display on the screen.*
6. *All errors which occur during execution of the Running Test are logged in the Log File.*
7. *This program is executed according to the Count Loop number selected in the Running Test Edit Item, see Section 3.20. To terminate the program, press **Ctrl + Break**.*

## 3.17 DMI INFOEMATION

Select **03** from the Diagnostics Menu and press **Enter** to Check or Write DMI Information Data:

### 3.17.1 Check DMI Information

The Check DMI Configuration program contains the following configuration information for the computer:

**NOTE:** Please set the media of DVD before starting a test.

*AHCI cannot control under the DOS*

#### System information (Type 1)

1. Manufacture : TOSHIBA
2. Product Name : Satellite XXXXXX
3. Version : (TOSHIBA Part Number)
4. Serial Number : Serial Number
5. UUID Number: xxx

#### OEM Strings (Type 11)

1. OEM String : xxx

#### On Board LAN MAC

1. MAC ADR : xxxxxxxxxxxxx

#### DVD Region Code

1. User Change Time : X
2. Region Code : X

### 3.17.2 Write DMI Information

The Write DMI Information program contains the following information for the computer :

1. Manufacture Name ( TOSHIBA )
2. Product Name ( Satellite XXXXXX )
3. Part Number ( PSP50X-XXXXXX )
4. Serial Number ( 12345678W )
5. OEM String ( PSP50X-XXXXX,SXXXXXXXXXXXX )
6. Model Select [1]Dyn-Jpn [2]Tos-Jpn [3]Tos-Eng [4]Tos-FR
7. Write UUID ( XXXXXXXXXXXXXXXXXXXX )
8. Brightness Write ( XXXXXXXX )
- a. SLP2.0 Build Sig [1]Non OS [2]OS

## ***Test Program for Field.***

---

- b. Wireless LAN ID ( 001E4CXXXXXX )
- c. AC Adapter Select [1]65W [2]75W [3]90W [4]120W

Select 1 ~ c to keyin new data , select 0 to exit program , program will compare input data length with the max length , if over will retry keyin

Note : Please Check New DMI Information After System Restart !!

V3.2

- 1. \*\*\*\* Manufacture Name ( TOSHIBA ) - (32)
- 2. \*\*\*\* Product Name ( Satellite XXXXXX ) - (32)
- 3. \*\*\*\* Part Number ( PSP50X-XXXXXX ) - (26)
- 4. \*\*\*\* Serial Number ( 12345678W ) - (32)
- 5. \*\*\*\* OEM String ( PSP50X-XXXXX,SXXXXXXXXXXXX ) - (64)
- 6. \*\*\*\* Model Select [1]Dyn-Jpn [2]Tos-Jpn [3]Tos-Eng [4]Tos-FR – (2)
- 7. \*\*\*\* Write UUID ( XXXXXXXXXXXXXXXXXXXX ) – (16)
- 8. \*\*\*\* Brightness Write ( XXXXXXXXX ) – (8)
  - a. \*\*\*\* SLP2.0 Build Sig [1]Non OS [2]OS-(2)
  - b. \*\*\*\* Wireless LAN ID ( 001E4CXXXXXX ) –(12)
  - c. \*\*\*\* AC Adapter Select [1]65W [2]75W [3]90W [4]120W –(1)
- 0. \*\*\*\* Exit

Please Select (1 ~ c) To Modify DMI String :

Current Data of EEPROM : Toshiba

1. Enter the Manufacture Name : TOSHIBA

Your Keyin is : TOSHIBA ..... This is your keyin data

EEPROM return : TOSHIBA ..... This is read from eeprom back

Press any key to continue

Note : Please Check New DMI Information After System Restart !!

*If Keyin length too long will retry :*

Current Data of EEPROM : 12345678WU

4. Enter the Serial Number : 12345678901234

Your Keyin String Length Not Correct 14 > 10 !!!

Current Data of EEPROM : 12345678WU

4. Enter the Serial Number :

***NOTE:*** The SLP2.0 is Microsoft SPEC , call “System Locked Pre-Installation” or “SLP”, It is for OEM pre install Windows and no need to Active , If you select Non OS , then you need to Active your OS before you use .

### **Function Detail :**

**6. Model Select :**

- [1]Dyn-Jpn : BIOS Logo is “dynabook” , CMOS Language is Japanese .
- [2]Tos-Jpn : BIOS Logo is “Toshiba” , CMOS Language is Japanese .
- [3]Tos-Eng : BIOS Logo is “Toshiba” , CMOS Language is English .
- [4]Tos-FR : BIOS Logo is “Toshiba” , CMOS Language is French .

**7. UUID :**

Total is 16 byte data , Front 10 byte is time random data , last 6 byte is LAN MAC .

**8. Brightness Table :**

It depend on LCD EDID to set different brightness data .

**a. SLP2.0 Build Sig :**

- [1]Non OS : EEPROM fill "MS" for non Microsoft OS , BIOS not load SLP OPROM function .
- [2]OS : EEPROM fill Others for Microsoft OS , BIOS load SLP OPROM function .

**b. Wireless LAN ID :**

If change M/B , but wireless/B not change , need fill wireless MAC into new change M/B .

**c. AC Adapter Select :**

- [1]65W : Machine need 65W AC Adapter .
- [2]75W : Machine need 75W AC Adapter .
- [3]90W : Machine need 90W AC Adapter .
- [4]120W : Machine need 120W AC Adapter .

The AC Adapter request is base on machine power request , some high performance need 120W Adapter , low cost machine maybe only 75W can meet request .  
Because AC Adapter do not had HWID for detect , so need key in data by menu .

- (1) If machine setting 75W , AC Adapter use 120W , it's OK .
- (2) If machine setting 120W , AC Adapter use 75W , because Adapter can't support enough power , it can't charge well .
- (3) If machine setting 90W , AC adapter use 90W , Adapter Select 90 W , it's OK .
- (4) If machine setting 90W , AC adapter use 90W , Adapter Select 120W , “PHM” and “ECO” utility will display wrong data , power consumption display double data more the machine actual use .



2. Error information displayed on the screen can be manipulated with the following number keys:

The **1** key scrolls the display to the next page.  
The **2** key scrolls the display to the previous page.  
The **3** key returns to the Diagnostics Menu.  
The **4** key erases all error log information in RAM.  
The **5** key reads the log information from a floppy disk.  
The **6** key writes the log information to a floppy disk.  
The **7** key save the log information to a floppy disk.

The following are the test abbreviations for each Diagnostics Test.

<b>Test Name</b>	<b>Test Abbreviations</b>
System Test	ROM
Memory Test	RAM
Keyboard Test	KBD
Display Test	CRT
Floppy Disk Test	FDD
Hard Disk Test	HDD
Real Time Clock Test	RTM
Cache Memory Test	CAH
Height Resolution Display Test	KIF
Multimedia Test	MLT
Memory2 Test	RAM

### 3.19 System Configuration

Select **05** from the Diagnostics Menu and press **Enter** to display the following system configuration:

```
SYSTEM CONFIGURATION :

* - BIOS VER = VX.XX  KBC VER = XXXX
* - MAC ADDRESS : XXXXXXXXXXXXX
* - 0 ASYNC ADAPTER
* - 1 HDD DRIVE(S):XXXXXXXXXXXXXXXXXXXXXXXXXXXX
      FW Rev.:XXXXXXXX
      CUR LBA:XXXXXXXX  ORG LBA:XXXXXXXX
* - BATTERY TYPE:XXXXXXXX
* - XXXMB MEMORY SIZE
* - XXX CPU
* - 1 Vedio Chip XXXXXXXXXXXXXXX
* - 1 ODD DRIVE(S):XXXXXXXX
      FW Rev.:XXXX
```

Press **Enter** to return to the Diagnostics Menu.

## 3.20 OPTION

### 3.20.1 Function Description

Function description lets you add or delete the subtests used to execute the Running Test. The following screen displays after pressing the **Tab** key to edit an item in the Running Test.

```

KEY OPERATION

↓      Cursor Down
↑      Cursor Up
PgDn   Page Down
PgUp   Page Up
Home   Top of ITEM
End    End of ITEM
Ins    Insert ITEM
Del    Delete ITEM
Enter  End
    
```

### 3.20.2 Operation Description

Select **05** from the Diagnostics Menu and press **Enter** to display the following:

```

                                Test Item Editor                                [RUNNING TEST]
Loop Count (1-65535, 0 = infinity)                                 Error Stop 

T-No      Test Name                S-No      Subtest Name
01        System Test              Subtest 01 ROM Checksum
02        Memory Test              Subtest 01 Conventional Memory
02        Memory Test              Subtest 02 Protect Mode
02        Memory Test              Subtest 03 Protect Mode (32MB Max)
02        Memory Test              Subtest 04 RAM Refresh
04        Display Test             Subtest 01 VRAM W/R/C
04        Display Test             Subtest 02 Character Attribute Set
04        Display Test             Subtest 03 Character Set
04        Display Test             Subtest 04 80 * 25 Character Display
04        Display Test             Subtest 05 320 * 200 Graphics Display
04        Display Test             Subtest 06 640 * 200 Graphics Display
04        Display Test             Subtest 07 640 * 480 Graphics Display
04        Display Test             Subtest 08 Display Page
05        Floppy Disk Test         Subtest 02 Sequential W/R/C
08        Hard Disk Test           Subtest 01 Sequential Read
08        Real Time Clock Test     Subtest 02 Backup Memory Test
    
```

Tab: HELP (Key Operation)



## *Test Program for Field.*

---

1. Enter a **number** or **0** for **Loop Count** and press **Enter**.

Select a number from 1 to 65535 to define the number of times the Running Test executes.

Select 0 to run the test continuously until halted by the user.

2. Select the **NO** or **YES** for **Error Stop** and press **Enter**.

Select **NO** to keep the test running even if an error is found.

Select **YES** to stop the test program when an error is found.

***NOTE:** All errors which occur during execution of the Running Test are logged in the Log File.*

3. Press **Insert** to add a subtest.
4. Press **Delete** to remove the selected subtest.
5. Press **Enter** when you have finished editing the Running Test list.
6. The following message displays:

Do you want to save the data?

Save to disk  
Do not save

7. Select the option and press **Enter**.
8. Select **03** from the Diagnostics Menu and press **Enter** to execute the Running Test.

***NOTE:** If press **Ctrl+break** in the runin process, please press more one any key to exit.*

## 3.21 Common Tests and Operation

### 3.21.1 How to operate a window

To input parameters, or open a window use the following keys.

- ↑ ↓ → ← key : to move a highlight bar
- [Enter] key : to select an item at the highlight bar
- [Esc] key : to close the current window and go back to the previous window

### 3.21.2 How to Stop the Test Program

To stop a test:

[Ctrl]+[Break] Press the Ctrl key and the Break key simultaneously.

### 3.21.3 Test Status Screen

*NOTE: The Test Status Screen does not display during all the tests. See the specific test description Sections 3.4 through 3.14.*

The following Test Status screen displays during most tests. See the description of each test Sections 3.4 through 3.14 for specific screen information.

Test Name			
Sub Test	:0101		
Pass Count	:00000	Error Count	:00000
Write Data	:00	Read Data	:00
Address	:00000000	Status	:00

Test Name Displays the name of the test being executed.

Subtest No. Displays the Subtest number in the following format:

ffgg

ff = Subtest No.

gg = Step Number (Will be blank if the test does not have a Step Number.)

### *Test Program for Field.*

---

Pass Count	Displays the number of times the test has been executed.
Error Count	Displays the number of errors which have occurred during the test.
Write Data	Displays only the test data that has failed to compare during the test while being written during the test.
Read Data	Displays test data that has failed to compare during the test while being read during the test.
Test Address	Displays the Test Address. (The format differs for each test.)
Error Status	Displays the error status.
Error Name	Displays the name of the error.

### 3.21.4 Test Stop Display

If an error occurs during a Subtest and YES is selected for Error Stop, the following message displays:

```
[HALT OPERATION]

  1. Test end
  2. Continue
  3. Retry
```

\* Select 1, 2, or 3

The three selections have the following functions:

- 1: Terminates the test program and exits to the subtest menu.
- 2: Continues the test from the error.
- 3: Restarts the test from the beginning.

Use the arrow keys to move the cursor to the desired option and press Enter.

### 3.21.5 How to enter data

Letters which must be entered are always shown in [ ]. Simultaneous entries are displayed by a “+” mark. For example:

**[a] [Enter]**

Press the “a” key, then press the [Enter] key.

**[Ctrl] + [c]**

Press the [Ctrl] key and the “c” key simultaneously.

## 4.1 Overview

This chapter describes the procedure for removing and replacing the field replaceable units (FRUs) in the PC. It may not be necessary to remove all the FRUs in order to replace one. The chart below provides a guide as to which other FRUs must be removed before a particular FRU can be removed. The numbers in the chart indicate the relevant section numbers in this manual.

In all cases when removing an FRU, the battery pack must also be removed. When repairing an FRU that is the potential cause of a computer fault, use the chart to determine the order in which FRUs need to be removed.

The tilt stand, if it is installed, can be removed without any other FRUs removed.

<b>4.2 Battery Pack</b>				
<b>4.3 HDD</b>				
<b>4.4 Memory Module</b>				
<b>4.5 Keyboard</b>				
<b>4.9 TOP Cover Assembly</b>				
<b>4.10 Touch Pad</b>	<b>4.17 Speaker Box</b>	<b>4.6 Wireless LAN Card and BT module</b>	<b>4.7 3G module card</b>	<b>4.8 Display Assembly</b>
		<b>4.11 I/O Boards</b>		<b>4.14 LCD unit</b>
		<b>4.12 System Board</b>		<b>4.15 WEB Camera module</b>
		<b>4.16 Application for Thermal pad and grease on CPU and North Bridge</b>		

- Chart Notation

The chart shows the case for the following example:

- Removing a MDC

All FRUs down to the “4.2 Battery pack” to “4.8 Cover assemblies” above USB board must be removed.

## **Safety Precautions**

Please read the following safety instructions before disassembling the computer and always follow the instructions while working on the computer.

- DANGER:**
- 1. In the case of the battery, always use authentic parts or equivalent parts approved by Toshiba. Other batteries may have different specifications that are incompatible with the computer and may result in fire or explosion.  
Due to the risk of alkali fluid leaks, never attempt to heat or disassemble the battery. Similarly, due to the risk of explosion, never expose the battery to flame.*
  - 2. Some parts including the power supply generate high voltages. If you need to turn on the power while disassembling the computer, do not touch any connectors or other components due to the risk of electric shock. Also, do not disassemble individual parts when performing routine maintenance.*

- WARNING:**
- 1. To prevent electric shock, turn off the power unplug the AC adapter from the power source.*
  - 2. As the battery installed to the computer is typically already charged, the risk of electric shock remains even when the AC adapter is unplugged from the socket. To prevent electric shock, always take off any metal jewelry or accessories such as necklaces, bracelets or rings before working on the computer. Never work with wet or moist hands.*
  - 3. Take care not to injury yourself on any edges or corners.*

- CAUTION:**
- 1. Confirm that replacement parts have compatible specifications before replacing on the computer. Never use incorrect parts as these may cause faults on the computer.*
  - 2. To prevent internal damage such as short circuits or burning, do not allow any screws, paper clips, or other metal objects to fall into the computer. When removing screws, always replace with the same size screws. Ensure that all screws are fully tightened. Loose screws may result in short circuits leading to overheating, smoke or flame.*
  - 3. To prevent electric shock, check that you have disconnected all cables from a part before removing the part.*
  - 4. When connecting to the AC power supply, use only an AC adapter and cable approved by Toshiba.*
  - 5. To prevent electric shock, ensure that all replacement parts are compatible with the computer and that all cables and connectors are securely connected.*

### **Before You Begin**

Take note of the following points before starting work. Always remove the AC adapter and battery pack before commencing any of the procedures. The procedure for removing the battery pack is described in section “4.2 Battery Pack”.

1. Do not disassemble the computer unless it is operating abnormally.
2. Use the designated tools.
3. Ensure that the environment for working on and storing parts does not contain any of the following.
  - Dust or dirt
  - Static electricity
  - Extremely hot, cold or humid conditions
4. Perform the diagnostic tests described in Chapter 2 to determine which FRU is the cause of the fault.
5. Do not perform any unnecessary work. Always work in accordance with the disassembly and reassembly procedures in this manual.
6. Keep parts removed from the computer in a safe place away from the computer where they will not be damaged or interfere with your work.
7. Disassembling requires the removal of a large number of screws. Keep removed screws in a safe place such that you can determine which screws belong to which part.
8. When reassembling, ensure that you use the correct screws and fit parts in the correct position. Screw sizes are noted in the text and figures.
9. As all parts have sharp edges and corners, take care not to cut yourself.
10. After replacing an FRU, check that the computer and replaced part operate correctly.

## **Disassembly Procedure**

Three main types of cable connector are used.

- Pressure plate connector
- Spring connector
- Normal pin connector

When disconnecting a pressure plate connector, lift up the tag on one side of the plastic pressure plate on the connector and pull the cable out from the connector. When reconnecting a cable to a pressure plate connector, lift up the pressure plate to a suitable height and insert the cable into the connector. Press down on both sides of the pressure plate such that both sides of the plate and connector are at the same height and that the cable is fixed in the correct position. Pull the cable to ensure that it is securely connected. If the cable is disconnected from the connector, reconnect it making sure that you lift the pressure plate high enough to insert fully the cable.

For spring connectors, lifting up the stopper frees the cable and allows it to be pulled out. To reconnect, hold the stopper in the up position and insert the cable, then lower the stopper to secure the cable.

Normal pin connectors are used for all other cables. Simply pull out or push in these connectors to disconnect or reconnect.

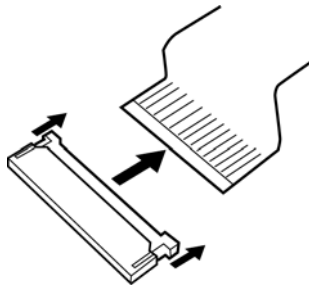

Pressure plate connector

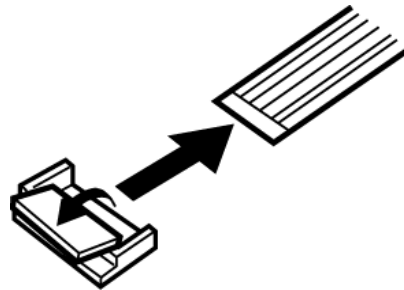

Spring connector



### **Assembly Procedure**

After the computer has been disassembled and the part that caused the fault has been repaired or replaced, the computer must be reassembled.

Take note of the following general points when assembling the computer.

- Take your time and follow the instructions carefully. Hurrying the assembly work will only introduce new problems.
- Check that all cables and connectors are securely connected;
- Before fastening FRUs or other parts in place, ensure that no cables are caught on screws or the FRU.
- Check that all latches are securely closed.
- Ensure that you have installed all FRUs correctly and do not have any screws left over. Using an incorrect screw may damage the thread or screw head and result in the FRU not being securely fastened in place.

After installing FRUs, check that the computer operates correctly.

### **Tools and Equipment**

For your safety and the safety of the people around you, it is important that you use Electrostatic Discharge (ESD) equipment. Correctly utilizing of the equipment increases the percentage of successful repairs and saves on the cost of damaged or destroyed parts. The following equipment is required for disassembly and assembly.

- One Philips screwdriver with type 0 bit (for Super THIN HEAD screws)
- One Philips screwdriver with type 1 bit (for screws other than above)
- One screwdriver with T6-bit TORX (for HDD slot cover)
- Tweezers (for lifting screws)
- ESD mats (lay on work table or floor)
- An ESD wrist strap and heel grounder
- Anti-static carpet or flooring

## **Screw Tightening Torque**

Use the following torque when tightening screws.

**CAUTION:** *Over-tightening may damage screws or parts. Under-tightening may allow screws to loosen (and possibly fall out) causing a short circuit or other damage.*

**NOTE:** *To tighten screws quickly and accurately, an electric screwdriver is recommended.*

- M2 (2mm)                    0.167 N·m (1.7 kgf·cm)
- M2.5 (2.5mm)              0.245 N·m (2.5 kgf·cm)
- M3.0 (3mm)                 0.245 N·m (2.5 kgf·cm)

**NOTE:** *To prevent damage to THIN HEAD screws, press along the axis of the screwdriver while turning the screw. This is because the contact area between the screw and driver is less than for a pan head screw (standard pan-shaped screw head).*

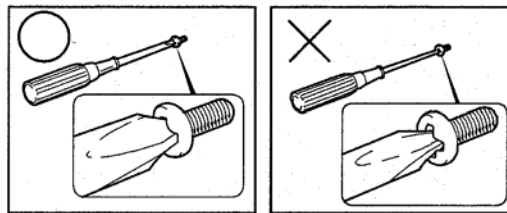

## **Screw Notation**

To make maintenance of the computer easier, markings of the kinds of the screws including the types and lengths are indicated on the computer body.

Format:

Screw shape + Screw length (mm)

Screw shape

B: Bind screw

F: Thin head screw

S: Super thin head screw

T: Tapping screw

U: Other screws (Unique screws: pan head, stud, etc.)

Example: B6 ... 6mm bind screw

## **4.2 Battery pack**

### **Removing the battery pack**

The following describes the procedure for removing the battery pack (See Figure 4-2-1).

**CAUTION:** *Take care not to short circuit the terminals when removing the battery pack. Similarly, do not drop, knock, scratch, disassemble, twist, or bend the battery pack.*

1. Turn off the power of the computer.
2. Disconnect the AC adapter and all external devices from the computer.
3. Turn the computer upside down.
4. Slide and hold the battery release latch (2) to free the battery pack after moving the battery release latch (1) into it unlock position – pick the battery pack out of the computer from fillister.

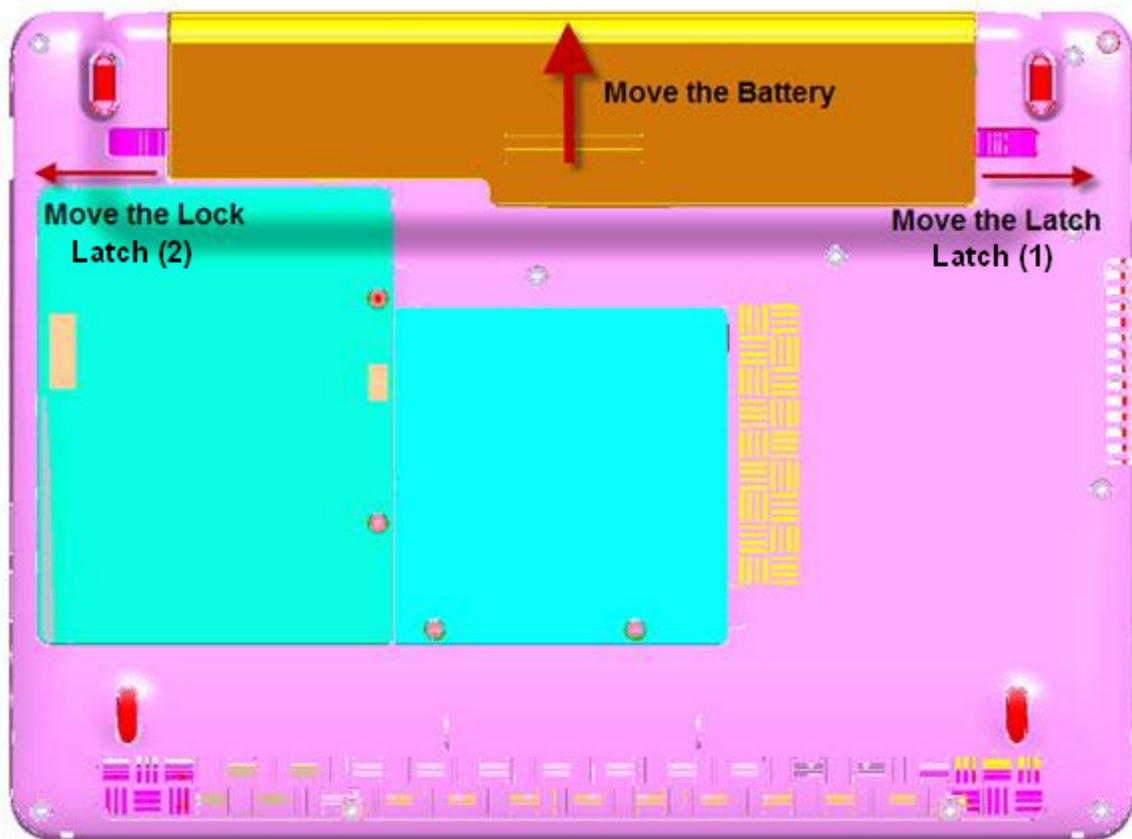

Figure 4-2-1 Remove the battery pack

**NOTE:** Dispose of the used battery pack in accordance with the laws and ordinances of your local authority.

### Installing the battery pack

The following describes the procedure for installing the battery pack (See Figure 4-2-2).

**CAUTION:** There is a danger that the lithium ion battery pack may explode if not fitted, operated, handled, or disposed correctly. Dispose always the used battery pack in accordance with the laws and ordinances of your local authority. Use only the batteries approved by Toshiba.

**NOTE:** Check visually the battery terminals and clean off any dirt with a dry cloth.

1. Turn off the power of the computer.
2. Disconnect the AC adapter and all external devices from the computer.

3. Attach the **battery cover** to the **battery pack**.
4. Insert the battery pack
5. Ensure the battery release latch (2) is moved into its locked position

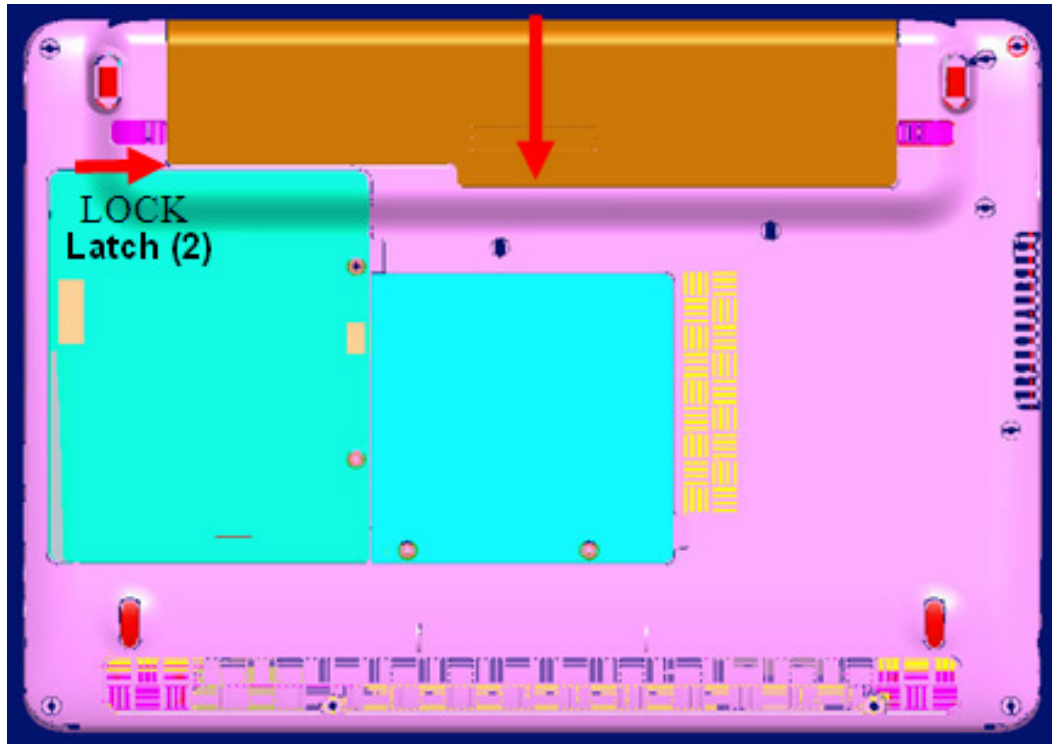

*Figure 4-2-2 Install the battery pack*

## 4.3 HDD

### Removing a HDD-H9.5mm

The following describes the procedure for removing the HDD (See Figure 4-3-1 to 4-3-3).

**CAUTION:** Take care not to press on the top or bottom of a HDD. Pressure may cause data loss or damage to the device.

1. Turn the computer upside down.
2. Remove the following **screws** with a T6-bit TORX securing HDD slot cover and remove HDD slot cover.
  - M2.0×4.0U FPH(T6) screw x2
3. Remove the following **screws** securing the **HDD assembly**.
  - M2.0×4.0F FLAT BIND screw x4
4. Disconnect the **HDD assembly** from the connector on the HDD cable

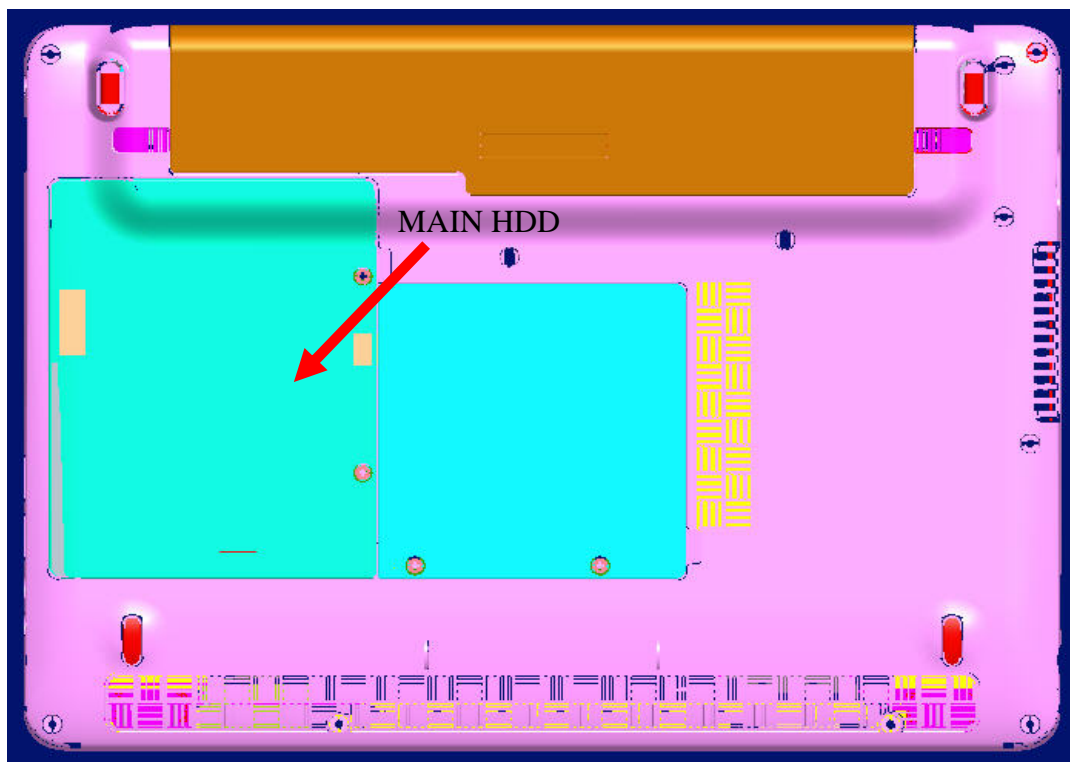
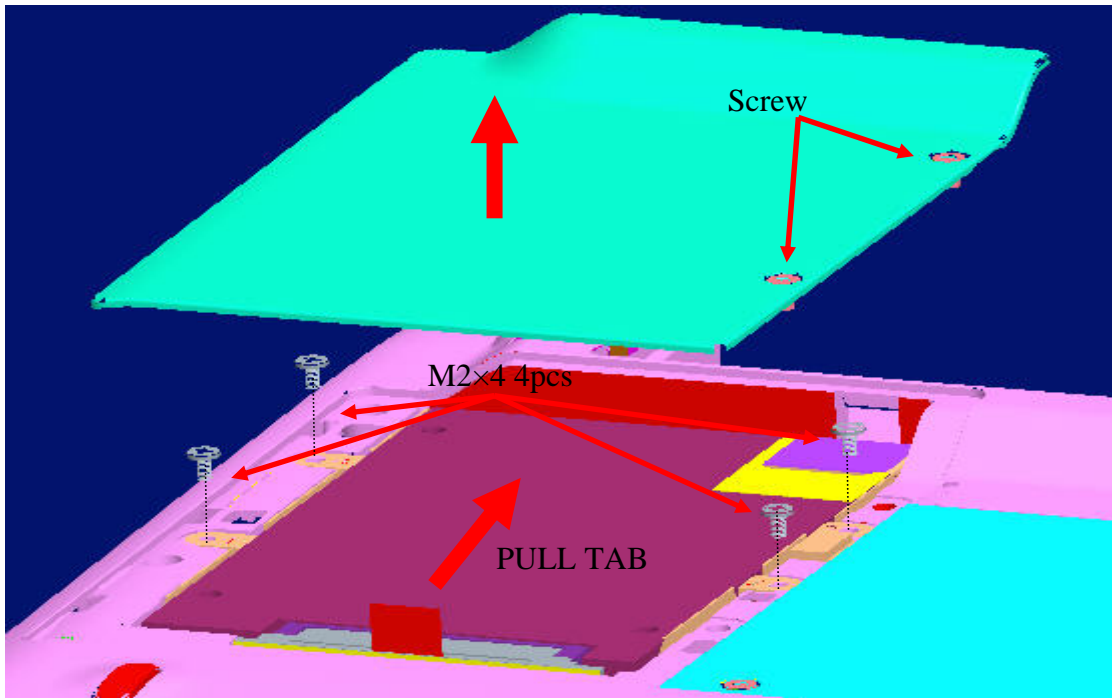

Figure 4-3-1 Turn the computer upside down

**CAUTION:** When a HDD is installed, they are installed in the position as the following figure.



*Figure 4-3-2 Remove HDD assembly*



5. Remove the following **screws** securing the HDD holder and remove the **HDD holder**.

- M3.0×3.5F FLAT BIND screw x4

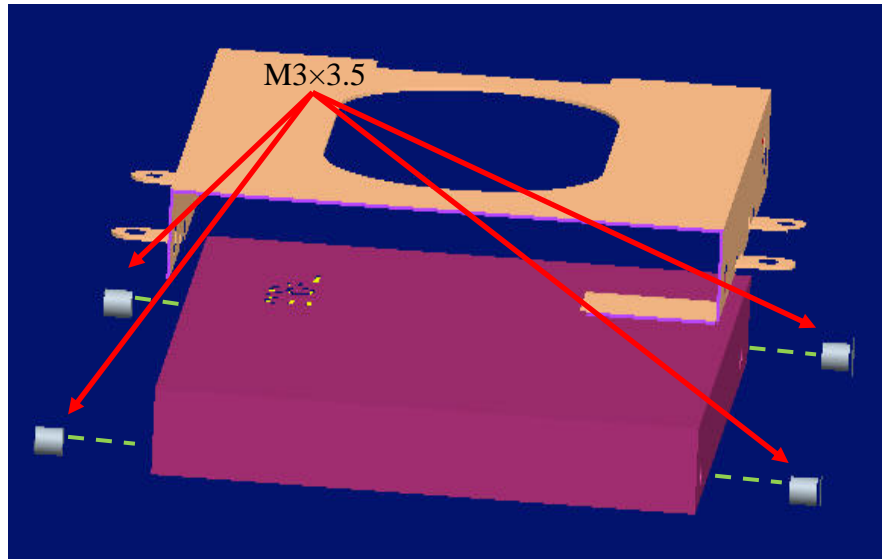

Figure 4-3-3 Remove HDD

### **Installing HDD-H9.5mm**

The following describes the procedure for installing the main HDD.

1. Install a HDD to the **HDD holder** and secure it with the following **screws**.

- M3.0×3.5F FLAT BIND screw x4

**NOTE:** Although they are 3mm head screws, screw torque must be set in 2.5kgf-cm for four screws securing the HDD holder.

2. Connect HDD carefully to the HDD cable
3. Insert the HDD assembly with HDD cable into the HDD slot.
4. Secure the **HDD assembly** with the following **screw**.

- M2.0×4.0F FLAT BIND screw x4

## **4.4 Memory Module**

**CAUTION:** *The power of the computer must be turned off when you remove a memory module. Remove a memory module with the power on risks damaging the module or the computer itself.*

*Do not touch memory module terminals. Any dirt on the terminals may cause memory access problems.*

*Never press hard or bend a memory module.*

### **Removing a memory module**

To remove a memory module, confirm that the computer is in boot mode. Then perform the following procedure (See Figure 4-4-1 to 4-4-2).

1. Loosen the **screw** securing the **memory slot cover**.
2. Remove the **memory slot cover**.
3. Open the left and right **latches** and remove a **memory module**.

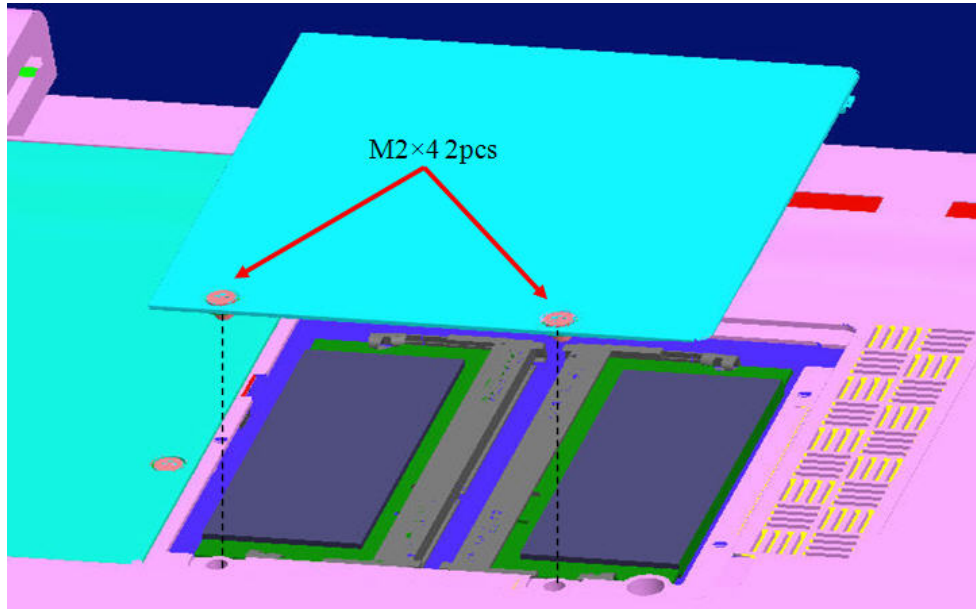

Figure 4-4-1 Remove memory slot cover

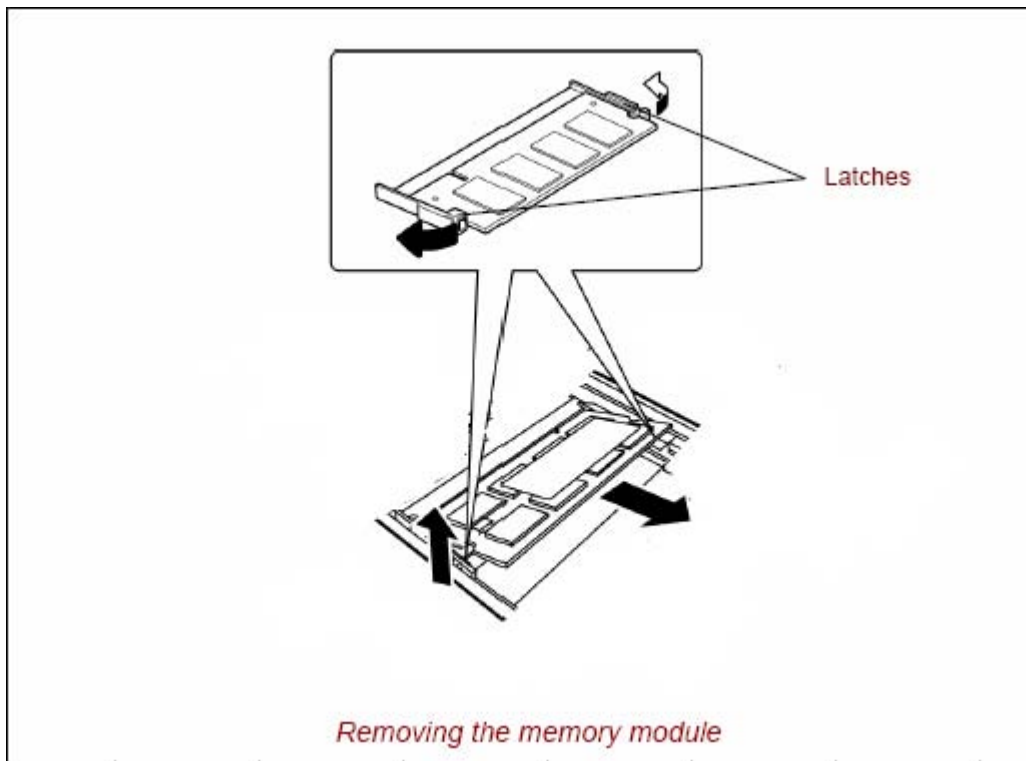

Figure 4-4-2 Remove a memory module

## **Installing a memory module**

To install a memory module, confirm that the computer is in boot mode. Then perform the following procedure (See Figure 4-4-3).

1. Insert a **memory module** into the connector of the computer slantwise (terminal side first) and press it to connect firmly.

**CAUTION:** *The power must be turned off when you insert a memory module. Inserting a memory module with the power on might damage the module or the computer itself.*

*Never press hard or bend a memory module.*

2. Install the **memory slot cover** and secure it with the **screw**.
3. When the power of the computer is turned on, the computer checks automatically the memory size. Confirm that the new memory is detected correctly.
4. If the memory is not detected, check that it is connected correctly.

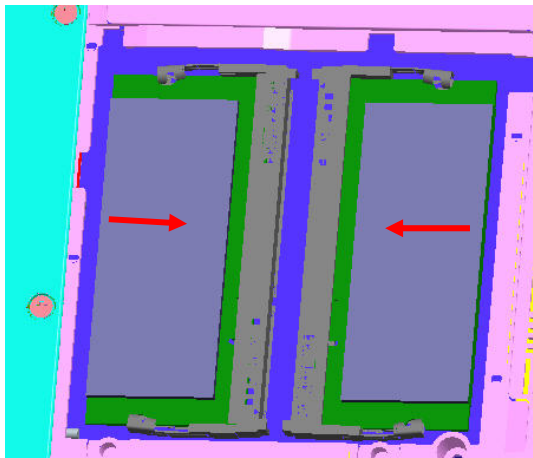

*Figure 4-4-3 Insert a memory module*

## 4.5 Keyboard

### Removing the keyboard

The following describes the procedure for removing the keyboard (See Figure 4-5-1 to 4-5-2).

**CAUTION:** *As the keycap may fall out, when handling the keyboard always hold it by the frame and do not touch the keycap.*

1. Upside down the computer and remove the battery.
2. Remove the screws on KB holder.  
M2.0x3.0F      Flat BIND screws      x2
3. Remove the **screw** securing Keyboard.  
M2.5x8.0F      Flat BIND screws      x2
4. Open the display.
5. Insert your finger into the slot between the KB holder and the keyboard. Then, lift up the **keyboard holder** to remove it.
6. Insert your finger into the slot between keyboard and top cover. Then lift up the **keyboard** to remove it.
7. Disconnect keyboard cable.

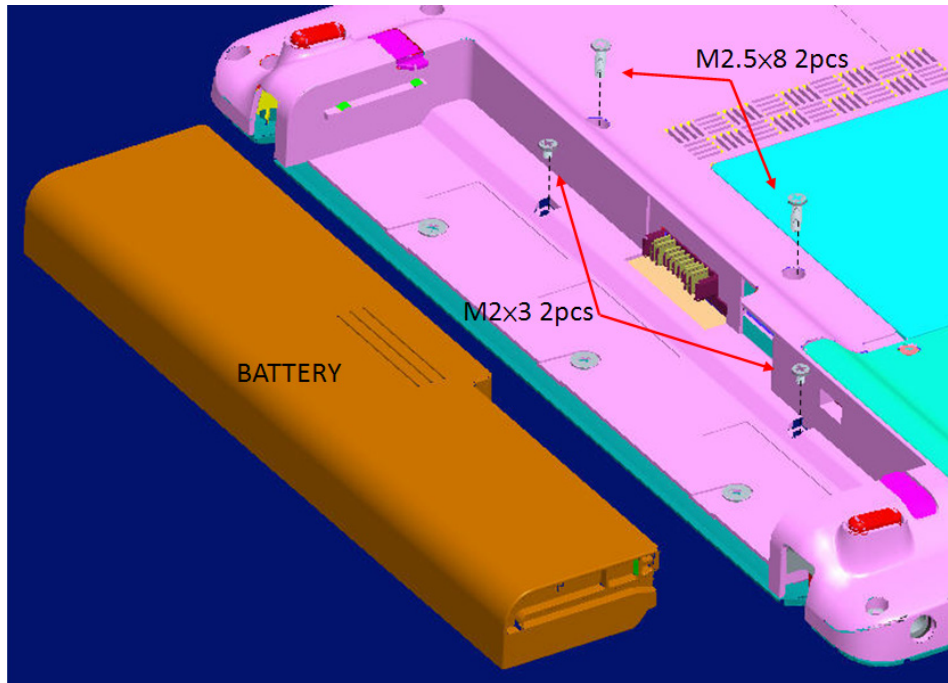

Figure 4-5-1 Remove 2 screws for KB Holder

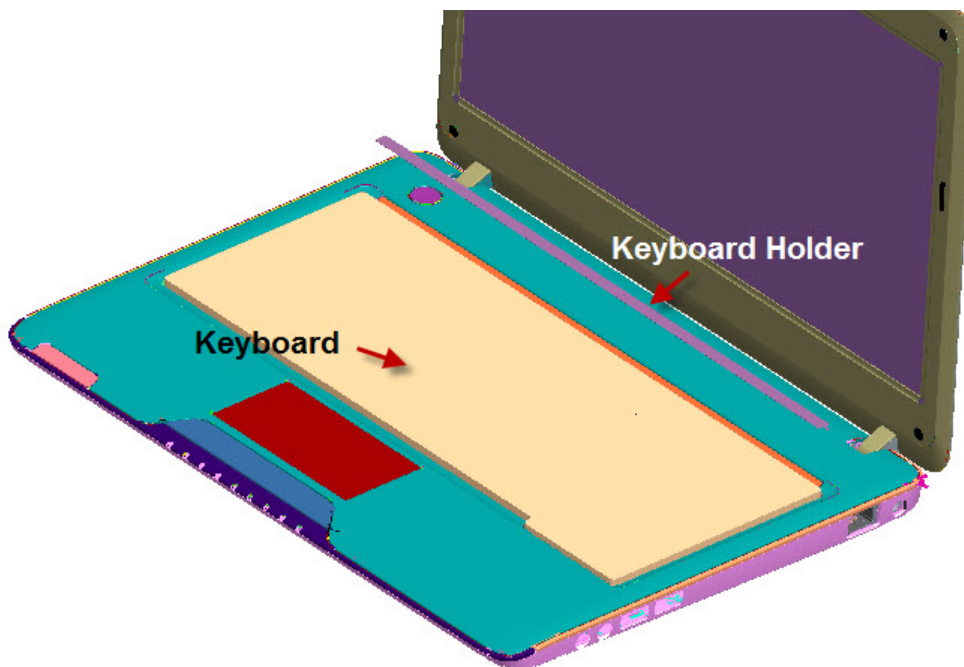

Figure 4-5-2 Remove Keyboard Holder and Keyboard

## **Installing the keyboard**

The following describes the procedure for installing the keyboard.

1. Connect the **keyboard flexible cable** to the connector on the system board.
2. Slide and set the **keyboard**.
3. Install the **K/B holder** by pressing it from the topside.
4. Upside down the computer and secure **keyboard** with the following **screw**.
  - M2.5×8.0F Flat BIND screw x2
5. Secure the **KB holder** with the following screw.
  - M2.0×3.0F Flat BIND screw x2

## 4.6 Wireless LAN card and Bluetooth Module

### Removing a Wireless LAN card

The following describes the procedure for removing a Wireless LAN card (See Figure 4-6-1).

1. Disconnect the **wireless LAN antenna cable** from the connectors on a wireless LAN card.
2. Open the left and right latches holding a wireless LAN card and remove a **wireless LAN card** from the **connector** on the system board.



Figure 4-6-1 Remove a wireless LAN card

### Installing a Wireless LAN card

The following describes the procedure for installing a Wireless LAN card.

1. Insert a **wireless LAN card** terminal slantwise into the connector on the computer and press a wireless LAN card into latches.
2. Connect the **wireless LAN antenna cable** to the terminals on a wireless LAN card.
3. Put the **wireless LAN antenna cable** on the right location from the guide.



## Removing a Bluetooth module

The following describes the procedure for removing a Bluetooth module (See Figure 4-6-2).

1. Disconnect the **Bluetooth cable** from the **connector** on the system board.
2. Remove the **Bluetooth module** from the **hook** on the Base Assembly.

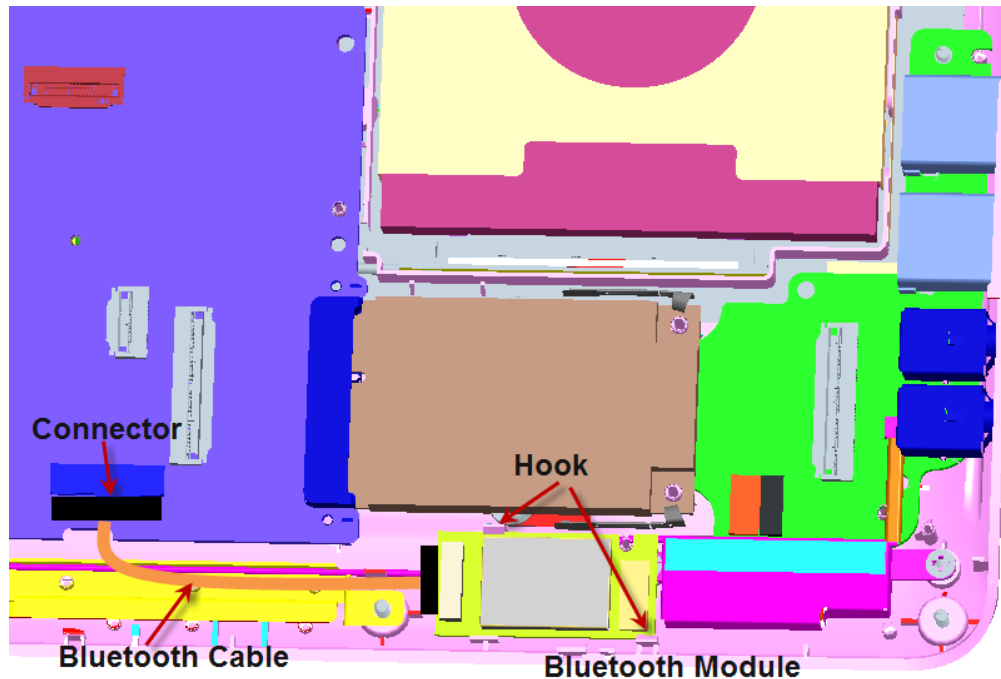

*Figure 4-6-2 Remove a Bluetooth Module*

## Installing a Bluetooth module

The following describes the procedure for installing a Bluetooth module.

1. Connect the **Bluetooth cable** to the **connector** on the system board.
2. Insert the **Bluetooth module** into the **hook** on the Base Assembly.

## 4.7 3G module card

### Removing 3G module card

The following describes the procedure for removing a 3G module card (See Figure 4-7-1).

1. Disconnect the **3G antenna cable** from the connectors on a 3G module card.
2. Open the left and right latches holding a 3G module card and remove a **3G module card** from the **connector** on the system board.

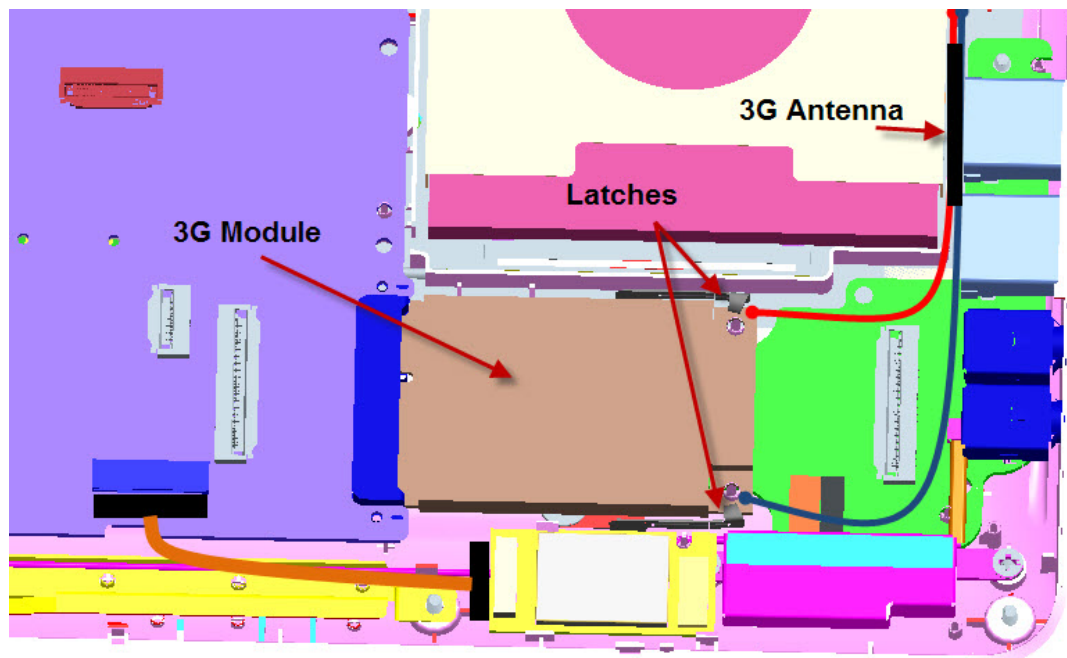

Figure 4-7-1 Remove a 3G module card

### Installing a 3G module card

The following describes the procedure for installing a 3G module card.

1. Insert the **3G module card** terminal slantwise into the connector on the computer and press the 3G module card into latches.
2. Connect the **3G antenna cable** to the terminals on a 3G module card.

## 4.8 Display Assembly

### Removing the display assembly

The following describes the procedure for removing the display assembly (See Figure 4-8-1 to 4-8-7).

1. Close the display and turn the computer upside down.
2. Remove the battery pack (See Figure 4-2-1)
3. Remove **HDD slot cover** and **memory slot cover**

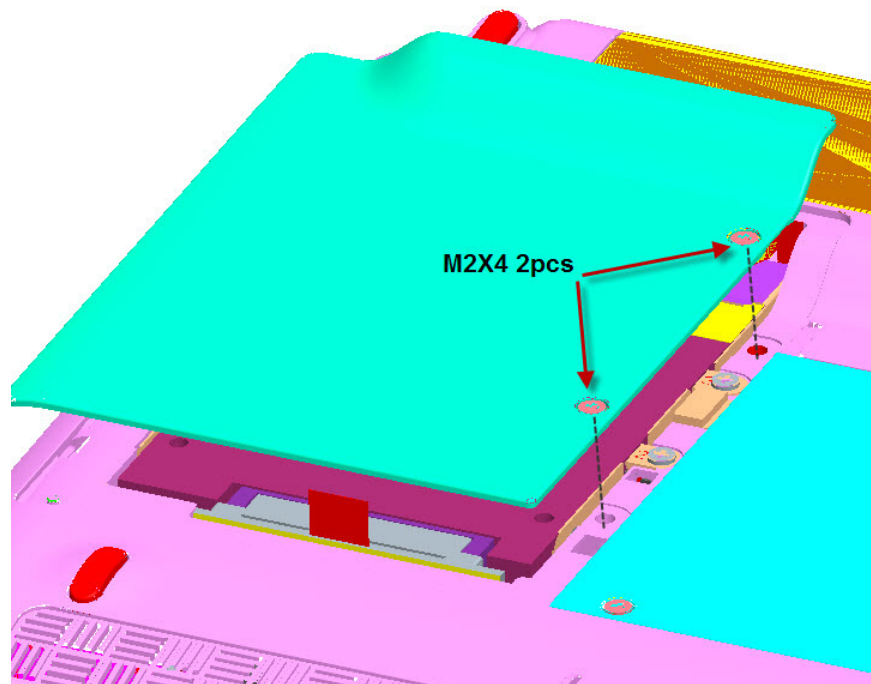

*Figure 4-8-1 Remove HDD slot cover*

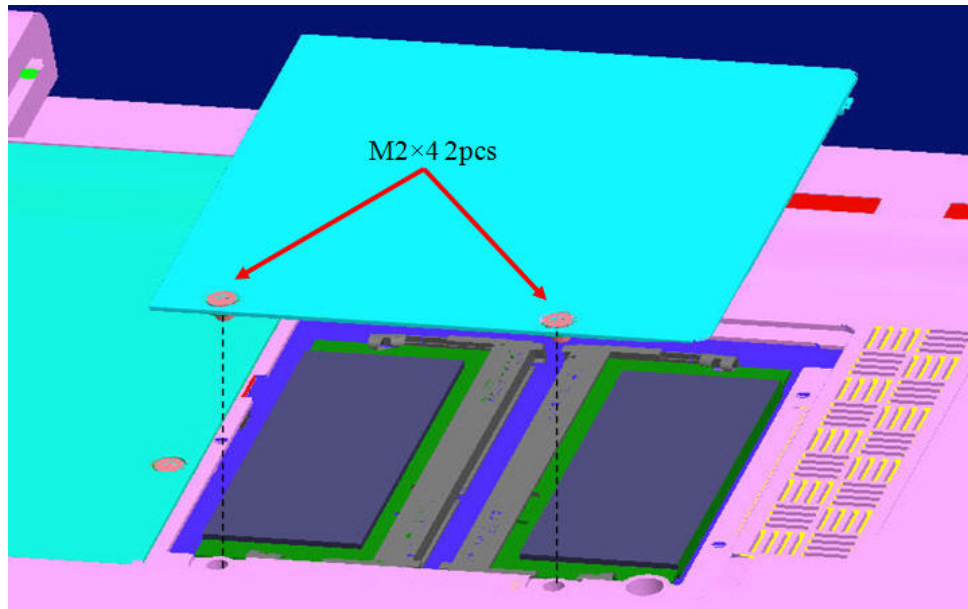

Figure 4-8-2 Remove the memory slot cover

4. Remove the screws from the bottom side.

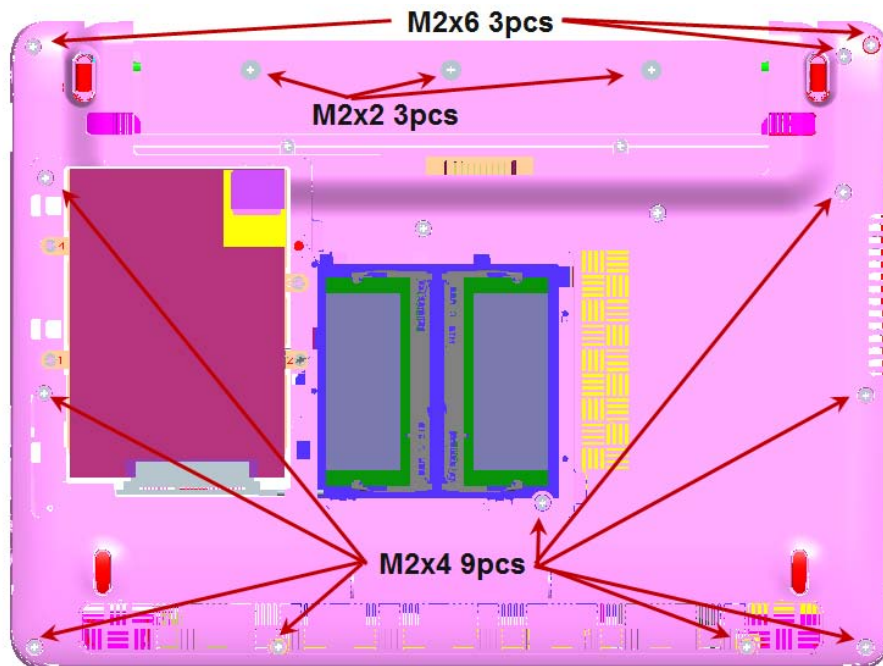

Figure 4-8-3 Remove the screws (from bottom side)

5. Disassemble **KB Holder** and **KB** (See Figure 4-5-1 to Figure 4-5-2)
6. Remove the screws from the top side and remove the cover.

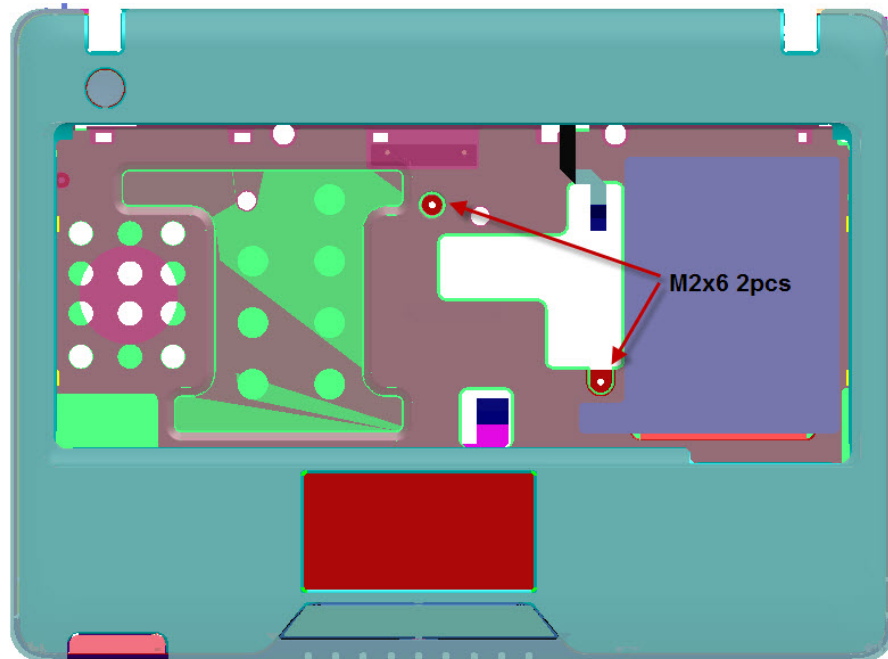

Figure 4-8-4 Remove the screws (from top side)

7. Disconnect the **touch pad FFC/LAN FFC/Power FFC** from the connector on the system board.

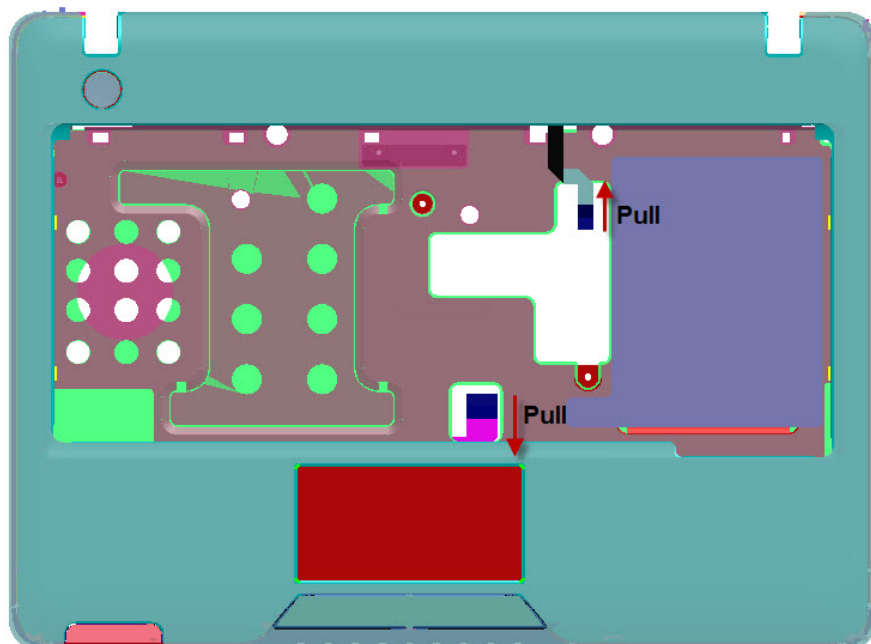
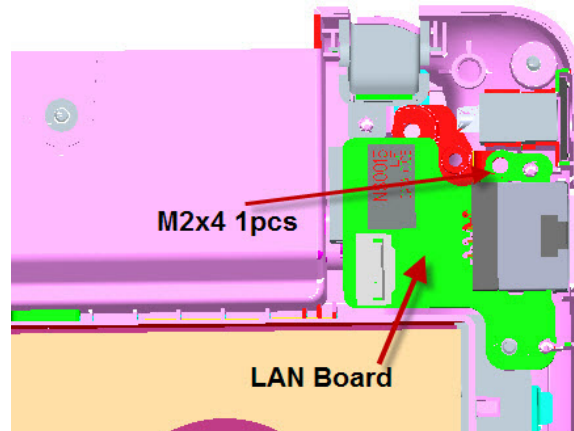

Figure 4-8-5 Disconnect the touch pad FFC/LAN FFC/Power FFC

8. Disassembly TOP Cover Assembly.

9. Disconnect the LAN FFC on LAN board and remove the LAN FFC
10. Remove the screws from the LAN board and remove the LAN board.



*Figure 4-8-6 Remove the LAN board*

11. Disconnect the **wireless LAN antenna** cable and 3G antenna cable from the connectors on the cards. (See Figure 4-6-1 and Figure 4-7-1)
12. Pull out the **LCD cables** from the guide of system board.

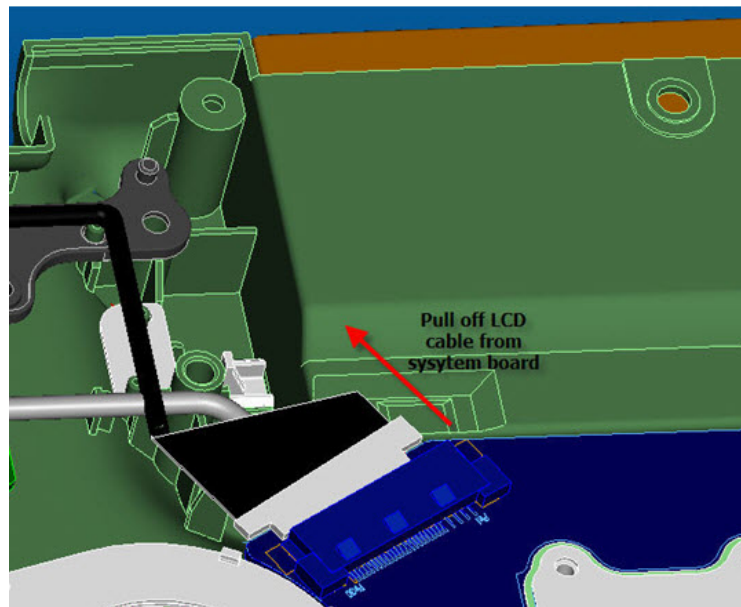

*Figure 4-8-7 Remove the LCD cable from system board*

13. Remove the DC-IN connector from the base assembly.

14. Opening the display to 120degree, keeping display side by hand and remove the hinge screw

- M2.0 ×4F FLAT BIND screw x4



*Figure 4-8-8 Remove the hinge screws*

15. Remove the **display assembly** with two hands holding from the base assembly.

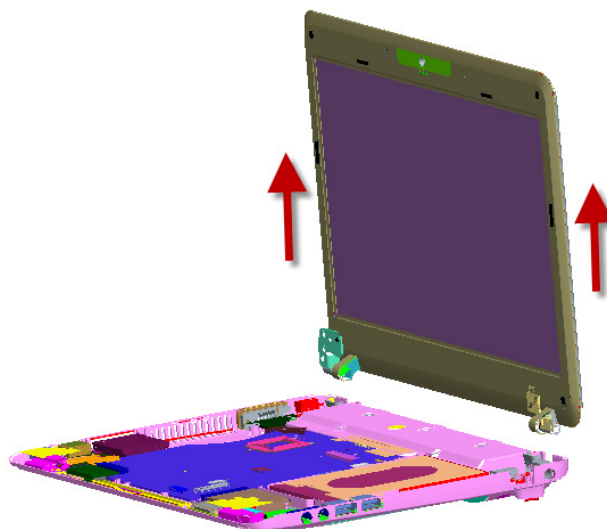

*Figure 4-8-9 Remove the display assembly*

## Installing the display assembly

The following describes the procedure for installing the display assembly.

1. Inserting the **pole of hinge** to the **hole** of hinge assembly, set the **display assembly** with hands on the base assembly.
2. Secure the **hinges** with the following **screws**.

- M2.0 ×4F FLAT BIND screw x4

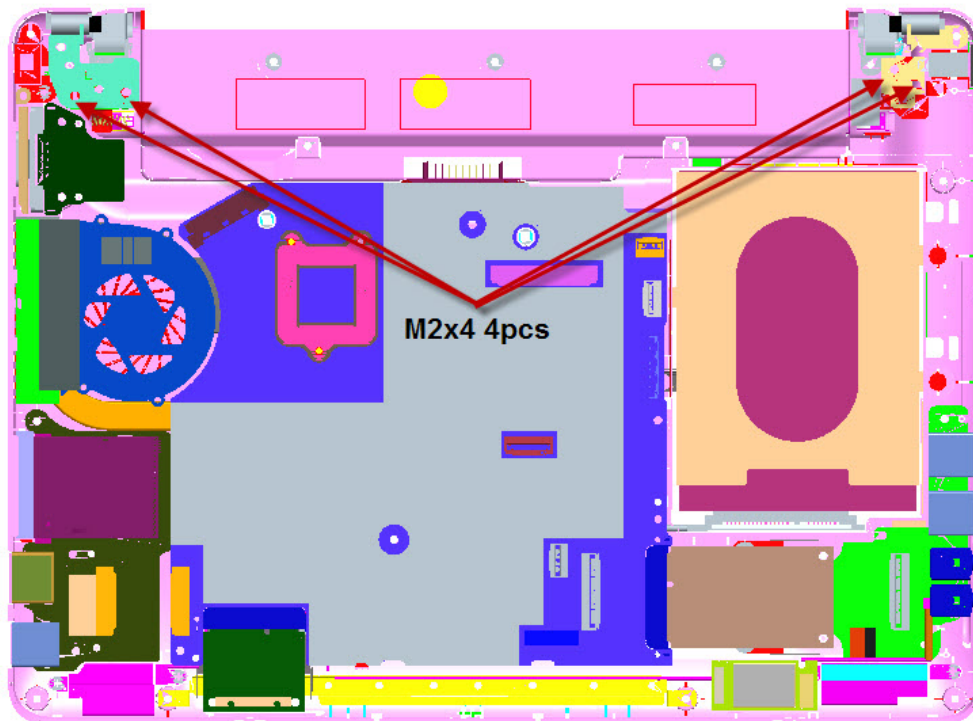

*Figure 4-8-10 Secure the hinge screws*

**NOTE:** Be sure to apply the locktight to the screws instructed in the figure above.

3. Connect the **LCD harness** to the connector on the system board.



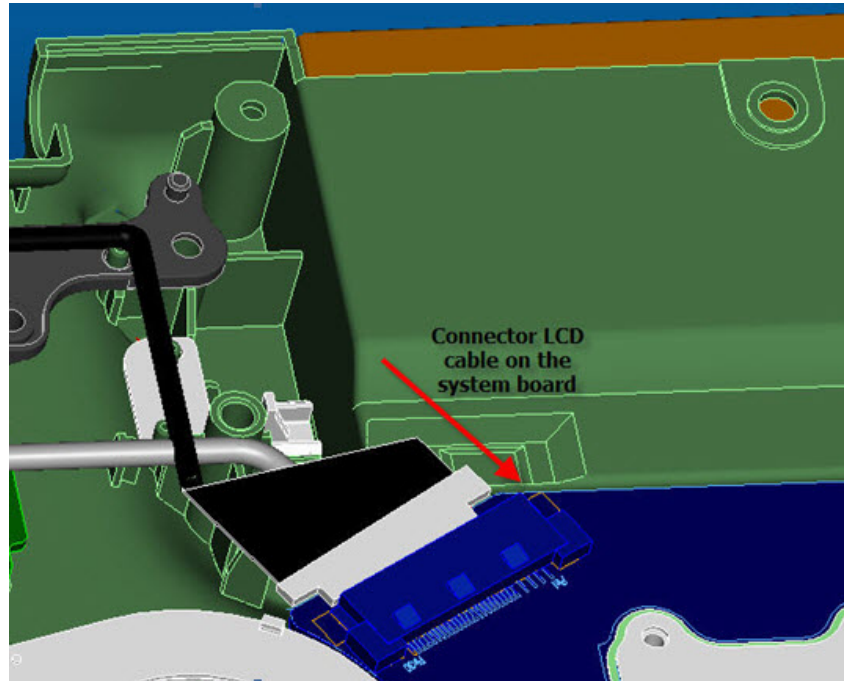

Figure 4-8-11 Connect LCD harness to the system board

4. Put the DC-IN connector to the base assembly.
5. Arrange the wireless antenna cables and 3G antenna cables along the guide



Figure 4-8-12 Arrange and connect Wireless LAN cable and 3G

6. Install the LAN board and secure the screws on the LAN board.

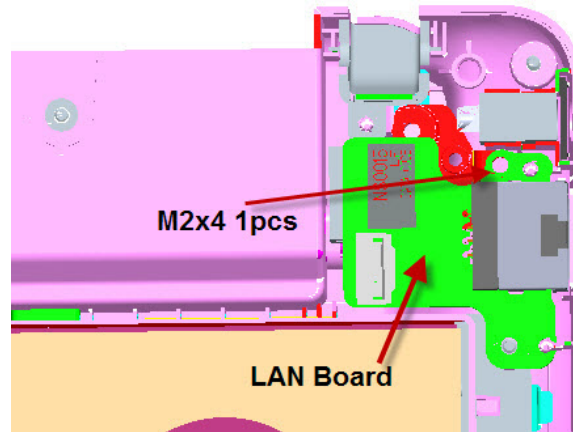

*Figure 4-8-13 Install the LAN board*

7. Connect the LAN FFC to the connector on the LAN board.
8. Arrange the **Wireless LAN antenna and 3G antenna** along the guide and contact with the connector with hands.
9. Install Top Cover Assembly of the system.

**NOTE:** *If Fingerprint or Dust left on LCD screen during disassembly and assembly LCD units, please follow Appendix A to clean it.*

## 4.9 Top Cover Assembly

### Removing the top cover assembly

The following describes the procedure for removing the top cover assembly (See Figure 4-9-1 to 4-9-4).

1. Turn over the computer.
2. Remove the following **screws** securing the cover assembly from the back and bottom of computer.

- M2.0×2F FLAT BIND screw x3
- M2.0×3F FLAT BIND screw x2
- M2.0×4F FLAT BIND screw x9
- M2.0×6F FLAT BIND screw x3
- M2.5×8F FLAT BIND screw x2

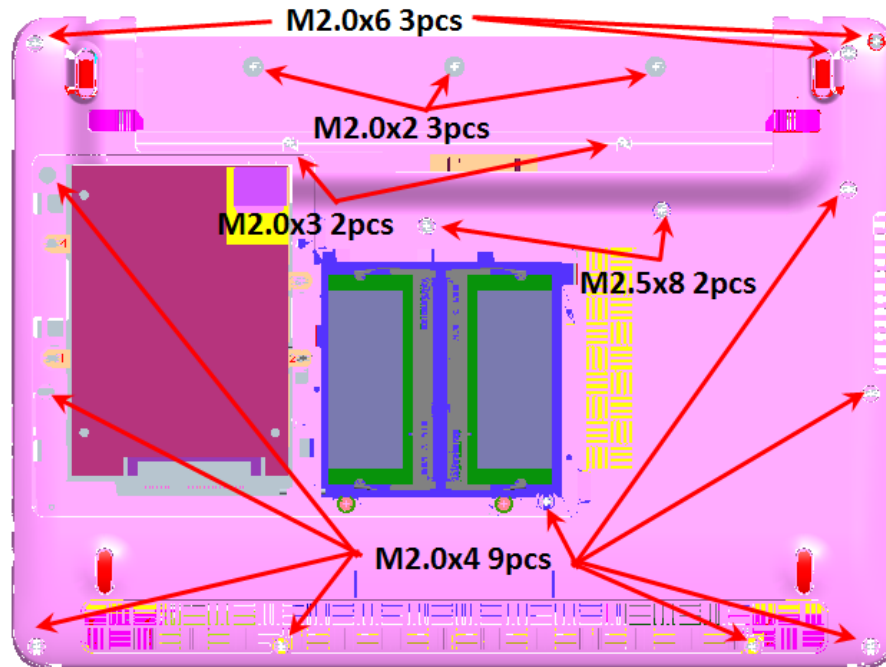

Figure 4-9-1 Remove the screws (back)

3. Disassemble **KB Holder** and **KB** (See Figure 4-5-1 to Figure 4-5-2)

4. Remove the following **screws** securing the cover assembly from the front of computer. Pull up and remove the **top cover assembly** from the **base assembly**.

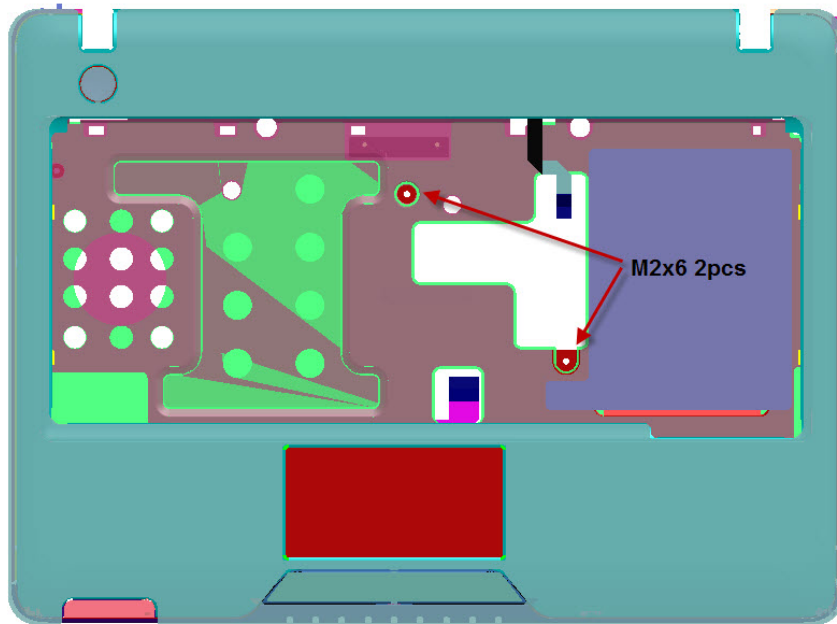

Figure 4-9-2 Remove the screws (front) and top cover assembly

5. Disconnect the **touch pad FFC/LAN FFC/Power FFC** from the connector on the system board.

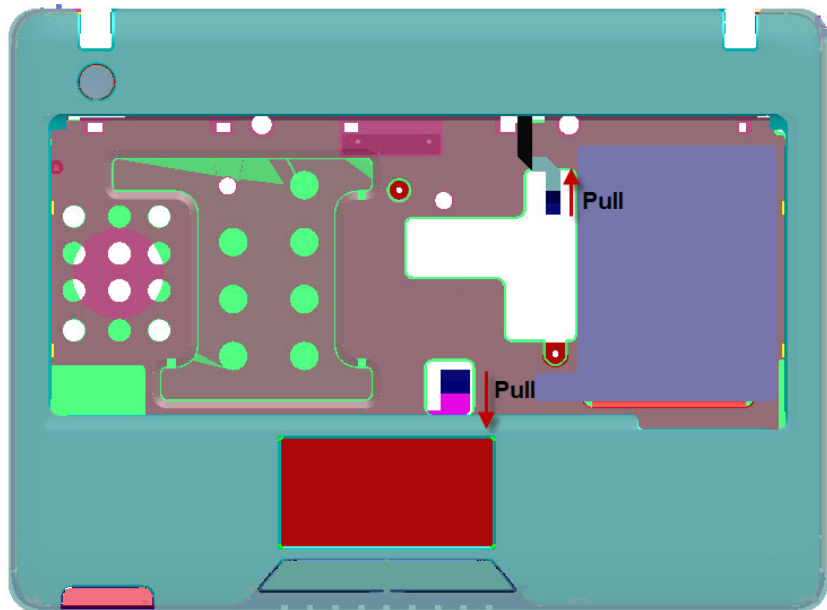
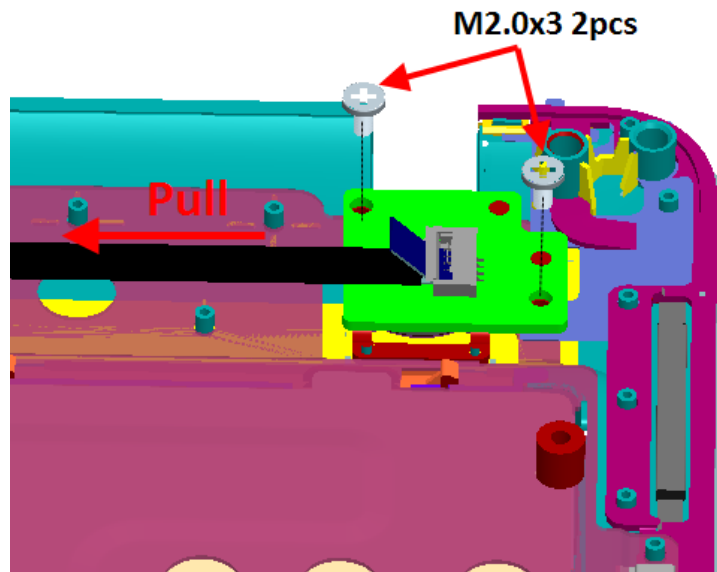

Figure 4-9-3 Disconnect the touch pad FFC/LAN FFC/Power FFC

6. Disconnect the **Power FFC** from the connector on the Power board. Remove the following screws securing the **Power Board** from the bottom of Cover Assembly.



*Figure 4-9-4 Remove the screws and Power FFC from the Power Board*

### **Installing the top cover assembly**

The following describes the procedure for installing the cover assembly.

1. Connect the **Power FFC** to the connector on the power board.
2. Secure the power board with the following **screws**.
  - M2.0×3F      FLAT BIND screw      x2
3. Install the **top cover assembly** to the base assembly.

<p><b>NOTE:</b> <i>Be careful not to catch the cables between cover assembly and base assembly.</i></p>
---

4. Connect the **touch pad FFC /LAN FFC/ Power FFC** to the connector on the system board.
5. Install the **Keyboard** and **Keyboard holder**.
6. Secure the cover assembly with the following **screws** from the back and bottom of computer.
  - M2.0×2F      FLAT BIND screw      x3
  - M2.0×3F      FLAT BIND screw      x2
  - M2.0×4F      FLAT BIND screw      x9
  - M2.0×6F      FLAT BIND screw      x3
  - M2.5×8F      FLAT BIND screw      x2

## 4.10 Touch Pad

### Removing the touch pad

The following describes the procedure for removing the touch pad (See Figure 4-10-1 to 4-10-3).

1. Disconnect the touch pad board FFC, touch pad FFC from the connector on the touch pad board.
2. Remove the following screws securing the touch pad plate.
  - M2.0x2F FLAT BIND screw x8
3. Remove the touch pad board and touch pad plate, disconnect the touch pad FFC from the connector on the touch pad.
4. Peel off and remove the touch pad from the top cover assembly.

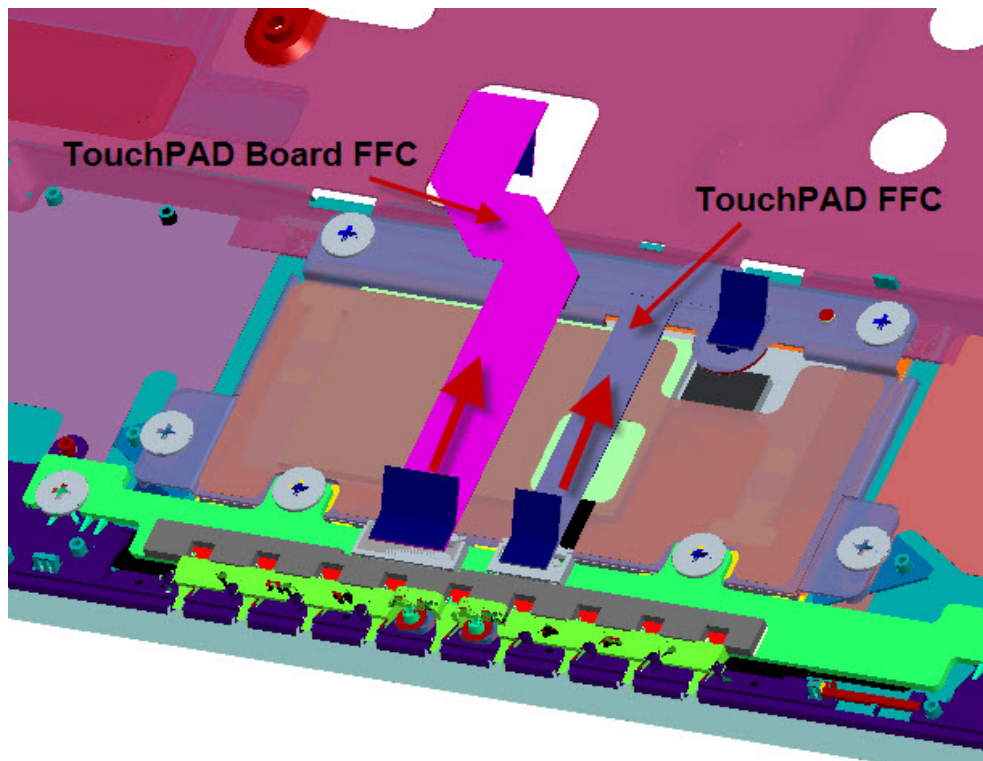

Figure 4-10-1 Remove the touch FFC cable

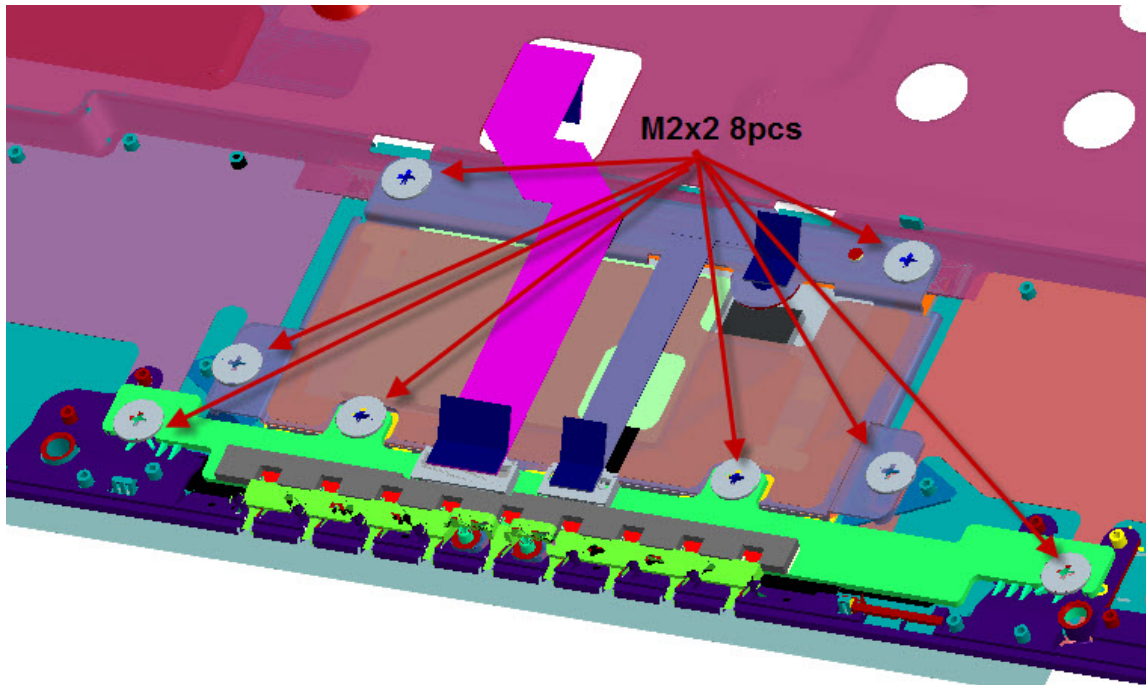

Figure 4-10-2 Remove the screws

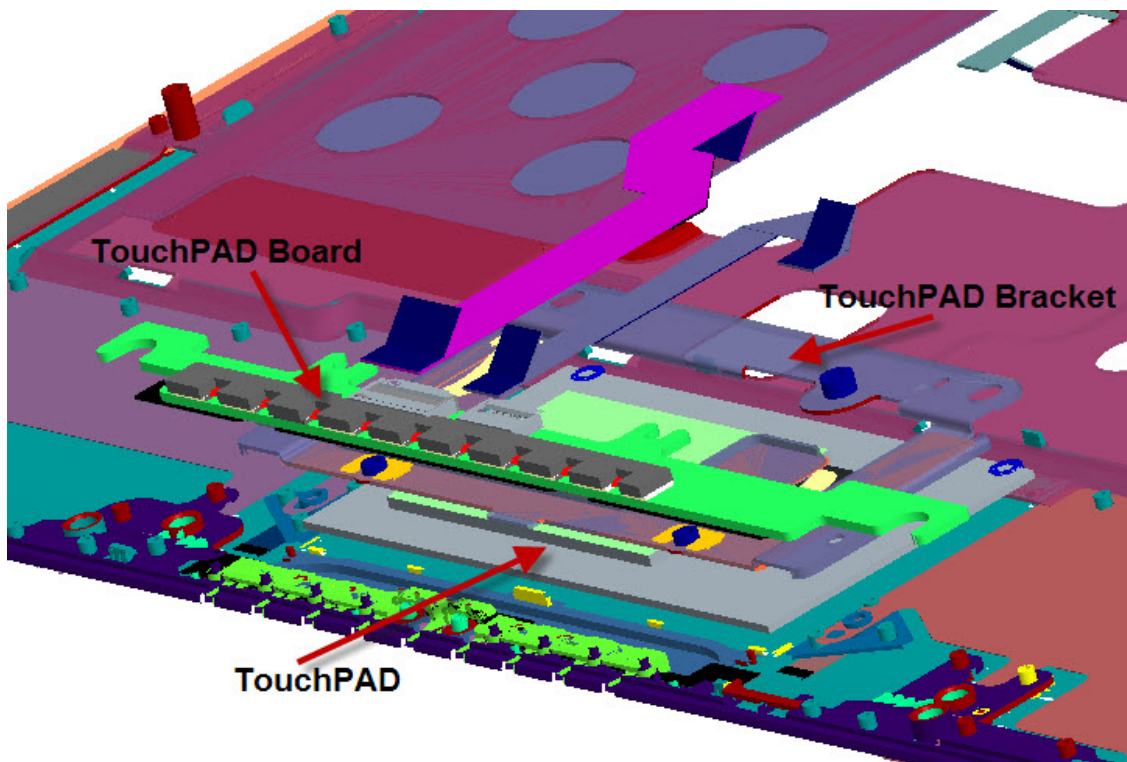

Figure 4-10-3 Remove the touchpad and touchpad board



## **Installing the touch pad**

The following describes the procedure for installing the touch pad.

1. Peel off the separator covering on the sensor portion of a new touch pad.

**NOTE:** *Do not reuse the touch pad so that it can not be used after peeling off from the computer. Be sure to stick a new touch pad.*

*When sticking the touch pad, be careful not to get the bubbles under the touch pad.*

2. Stick and install the touch pad on the top cover assembly.
3. Connect the touch pad FFC to the connector on the touch pad.
4. Install the touch pad plate and the touch pad board, secure it with the following screws.
  - M2.0x2F FLAT BIND screw                      x8
5. Connect the touch pad FFC and the touch pad board FFC to the connector on the touch pad board.

## 4.11 I/O Boards

### Removing I/O Boards

The following describes for removing the I/O boards (See Figure 4-11-1 and Figure 4-11-2).

1. Disconnect **HDMI FFC**, **Audio FFC** and **LAN FFC** from I/O boards' connectors.
2. Remove below **screws** and then incline pull out **I/O Boards** (CRT board, HDMI board, Audio board and LAN board)
3. Disconnect the CRT cable, Speaker cable from I/O boards' connectors.

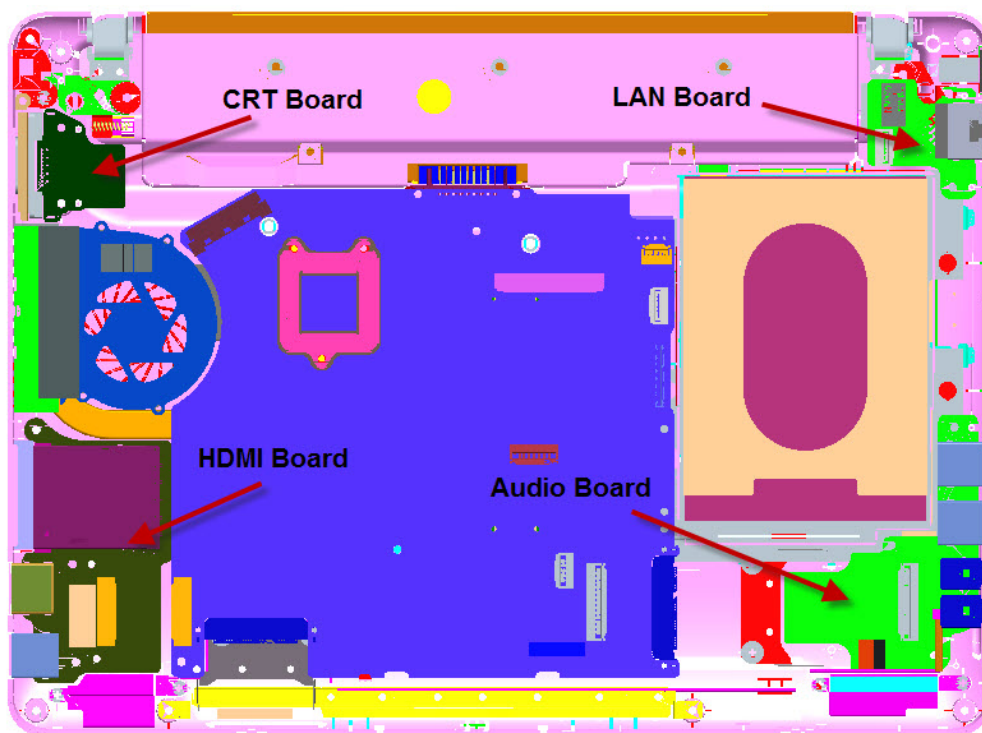

Figure 4-11-1 Positions of I/O boards

- M2.0x3F FLAT BIND screw x6
- M2.0x4F FLAT BIND screw x1

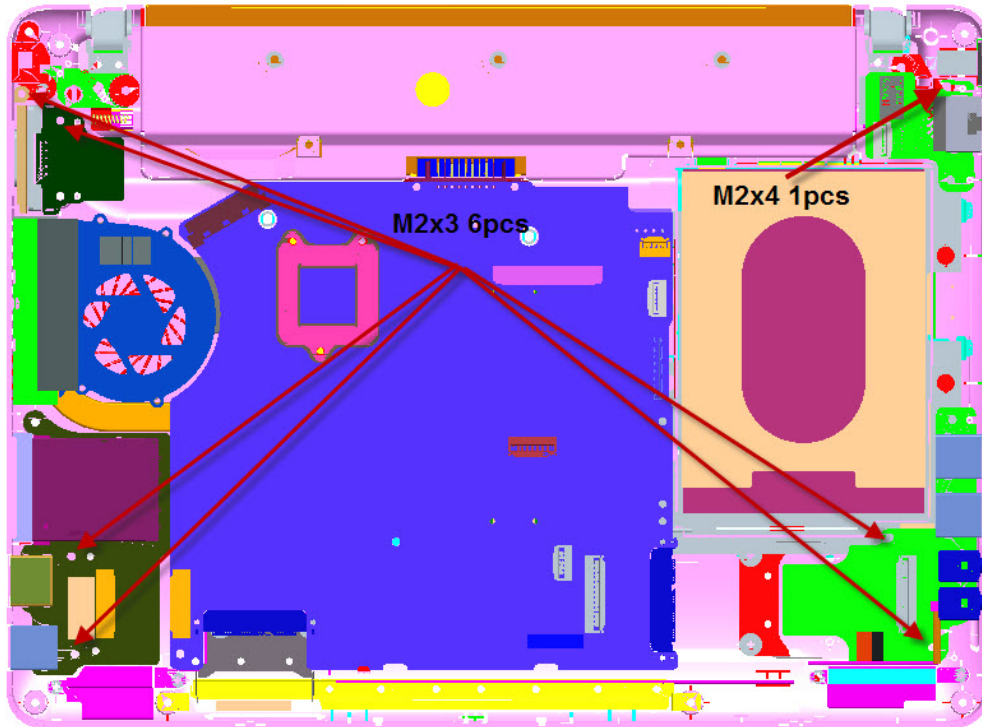

Figure 4-11-2 Remove the screws from I/O boards

### Installing I/O Boards

The following describes for removing I/O boards.

1. Connect the CRT cable, **HDMI FFC**, **Audio FFC**, **LAN FFC**, **Speaker cable** from I/O boards' connectors.
2. Fix the below **screws** then incline insert in **I/O Boards**(CRT board, HDMI board, Audio board and LAN board)

- M2.0x3F      FLAT BIND screw      x6
- M2.0x4F      FLAT BIND screw      x1

**NOTE:** Be careful not to catch the cables between cover assembly and base assembly.

## 4.12 System board

**CAUTION:** 1. when handling the system board, always hold by the edges. Do not touch the printed circuit face.  
2. if replacing with a new system board, execute the substest01 Initial configuration in section 3.3 “Setting of the hardware configuration”.

### Removing the system board

The following describes the procedure for removing the system board (See Figure 4-12-1).

1. Disconnect the **LAN BOARD FFC, LCD CABLE, Antenna cable, Audio board FFC, HDMI FFC, Bluetooth cable, SIM CARD FFC, TP board FFC, Power Board FFC, HDD cable** from the connector on the system board.
2. Remove the following **screws** securing the system board and remove the **system board**.
  - M2.0×3.0F FLAT BIND screw x2
3. Disconnect the RGB cable and DC-IN cable from the connector on the system board.

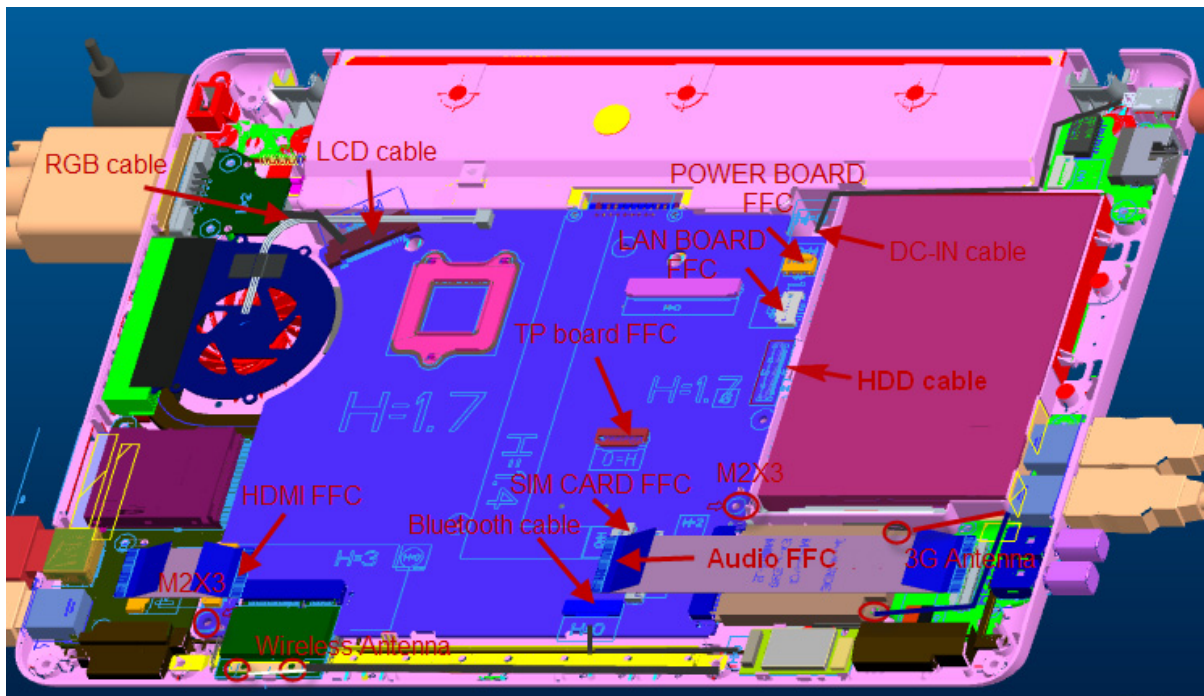

Figure 4-12-1 Remove the system board

## **Installing the system board**

The following describes the procedure for installing the system board.

1. Connect the RGB cable and DC-IN cable to the connector on the system board.
2. Secure the system board with the following **screws**.
  - M2.0×3F FLAT BIND screw x2
3. Connect the **LAN BOARD FFC, LCD CABLE, Antenna cable, Audio board FFC, HDMI FFC, Bluetooth cable, SIM CARD FFC, TP board FFC, Power Board FFC, HDD cable** to the connector on the system board.

## Removing RTC battery

The following describes the procedure for removing the RTC battery unit (See Figure 4-12-2 to 4-12-3).

1. Pull the away the socket of RTC battery and use a clamp to hold RTC battery tightly.
2. Rotate battery through the way then remove it.

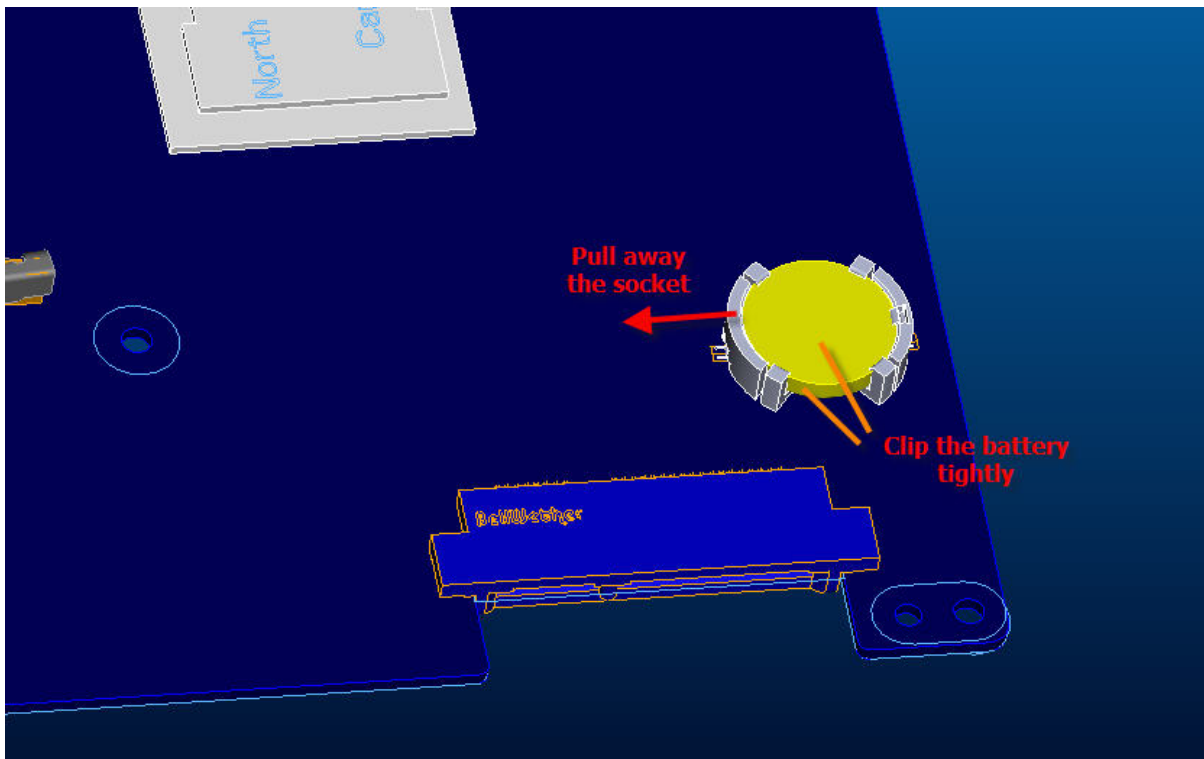

*Figure 4-12-2 Remove the RTC battery-step\_1*

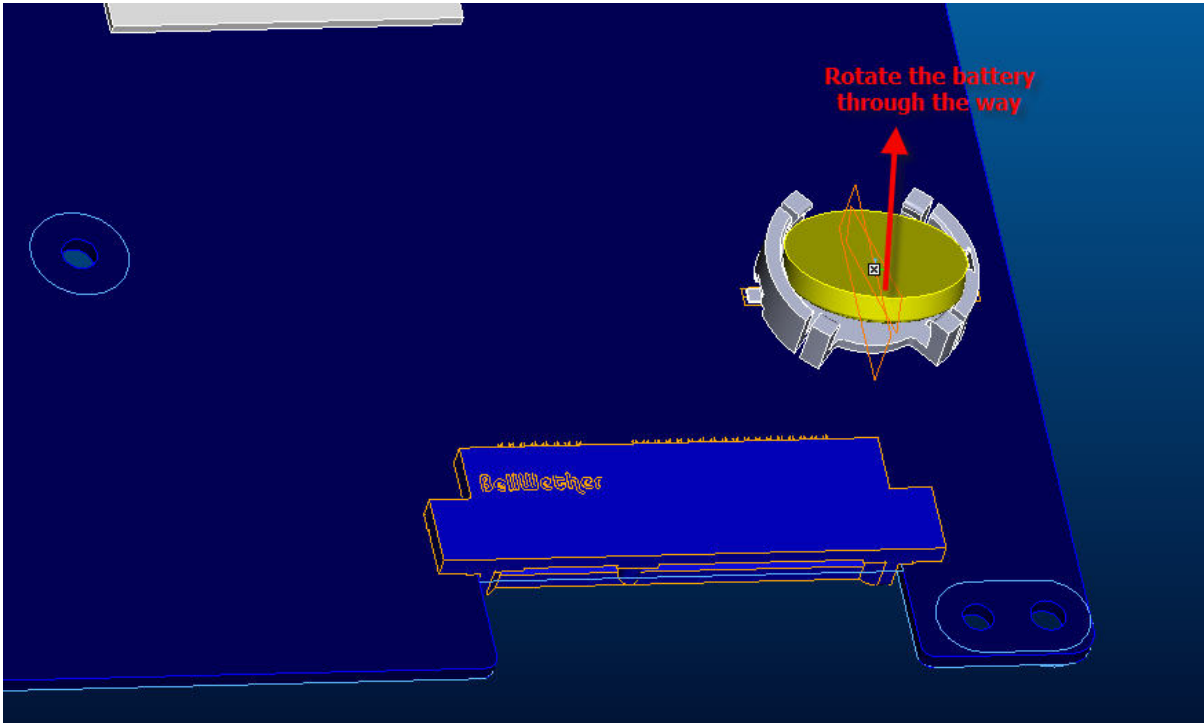

Figure 4-12-3 Remove the RTC battery-step\_2

### **Installing RTC battery**

The following describes the procedure for installing the RTC battery unit

(See Figure 4-12-4).

1. Press the force vertically then lock the RTC battery tightly.

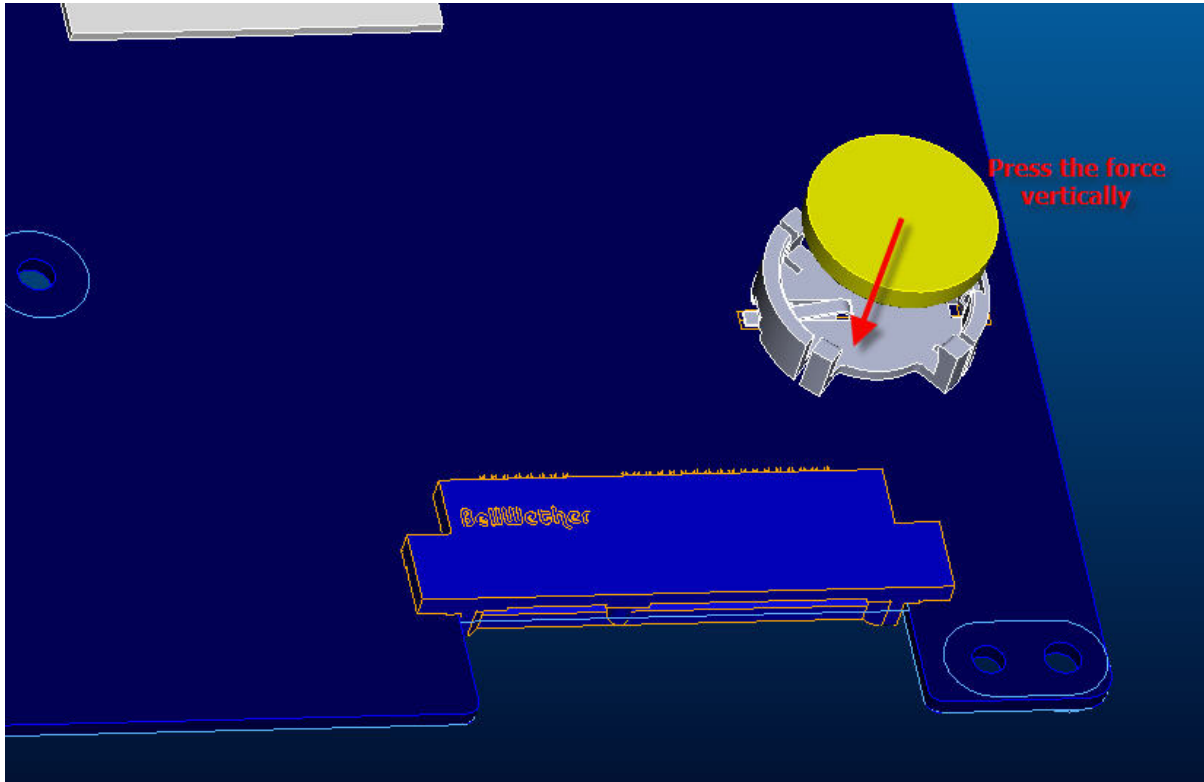

*Figure 4-12-4 Install the RTC battery*



## 4.13 CPU heat sink

### Removing the CPU heat sink

The following describes the procedure for removing the CPU heat sink (See Figure 4-13-1).

1. Disconnect the **Heat sink cable** from the connector on the system board
2. Loose the following **screws** securing the heat sink holder along 1 to 3.
  - M2.0×3.0F FLAT BIND screw x3

**NOTE:** When removing the heat sink holder, be sure to remove the screws in the reverse order of the number marked on the holder.

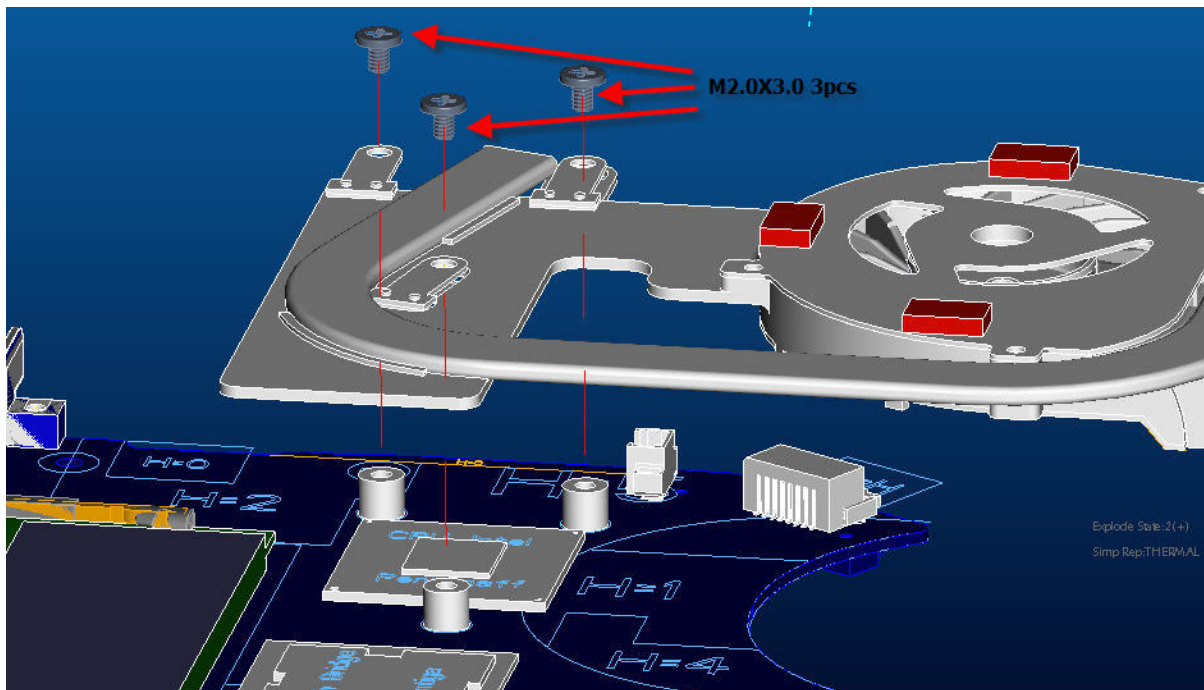

Figure 4-13-1 Remove the CPU heat sink

### **Installing the CPU heat sink**

The following describes the procedure for installing the CPU heat sink

1. Secure the following **screws** securing the heat sink holder along 1 to 3.
  - M2.0×3.0F FLAT BIND screw x3
2. Connect the **Heat sink cable** from the connector on the system board

## 4.14 LCD unit

### Removing the LCD unit

The following describes the procedure for removing the LCD unit (See Figure 4-14-1 to 4-14-4).

1. Remove Screw MYLAR cover x4
2. Remove the following **screws** securing the display mask
  - M2.0×4.0F FLAT BIND screw x4
3. Insert your finger between the edge of the display mask and the LCD, and remove the display mask while releasing the latches of display mask. (Note: when removing the display mask, please first remove from top side to the bottom in order to lessen the degree of breaking.

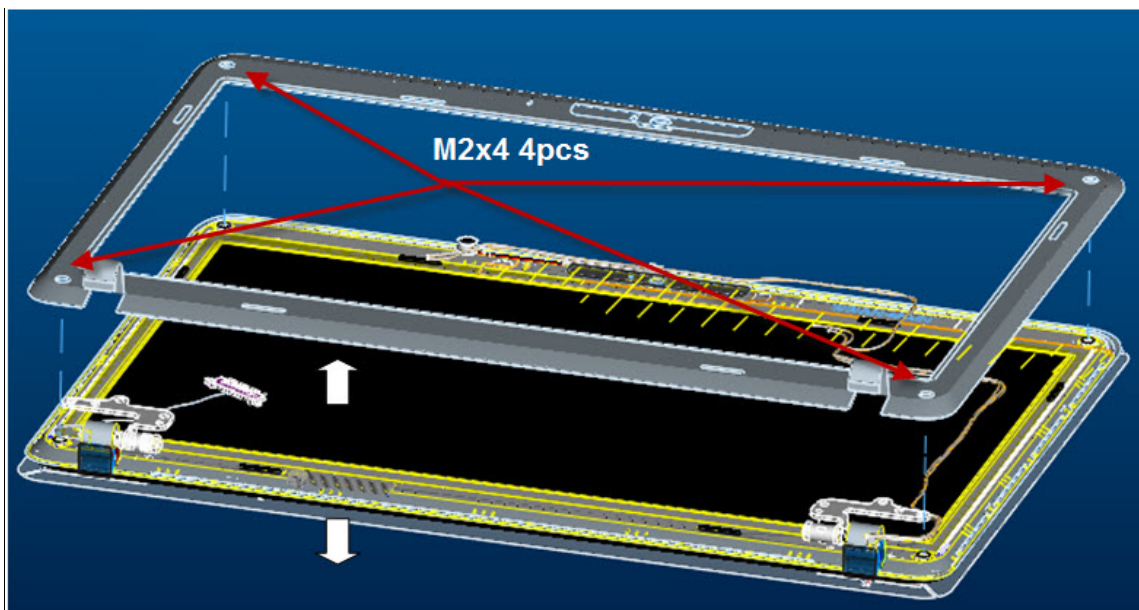

Figure 4-14-1 Remove the display mask

4. Remove the following **screws** securing the LCD unit, and disconnect CCD FPC
  - M2.0×3.0F FLAT BIND screw x4



Figure 4-14-2 Remove screws securing the LCD

5. Remove the LCD unit, the hinge and the LCD Harness from the bottom side

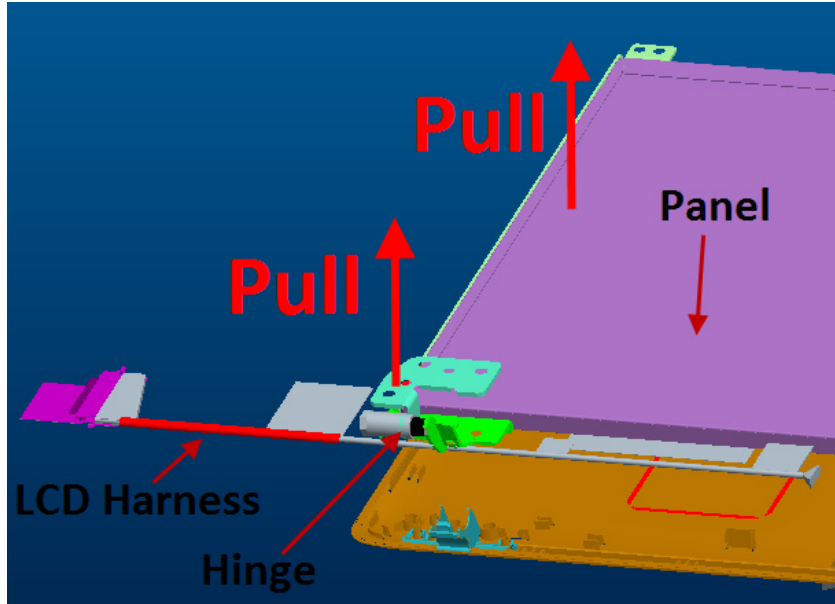
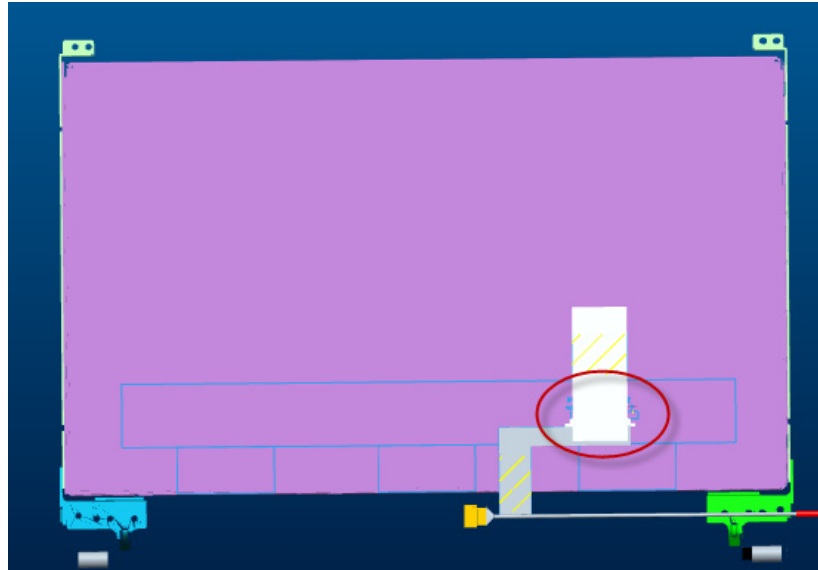

Figure 4-14-3 Remove the LCD

6. With the bottom edge of the LCD unit on the display cover, lift only the top edge of the LCD unit. After peeling off the MYLAR tape, disconnect the LCD harness from the connector on the back of the LCD.



*Figure 4-14-4 Remove the harness*

7. Remove the following **screws** securing the LCD support (LCD unit side) and remove the **hinge** from the LCD unit.

- M2.0×2.5F FLAT BIND screw x4



*Figure 4-14-5 Remove the LCD hinge*

## **Installing the LCD unit**

The following describes the procedure for installing the LCD unit.

Install the LCD supports (LCD unit side) and hinge to the LCD and secure them with the following **screws**.

- M2×2.5F FLAT BIND screw x4

1. Stand the **LCD unit** on the display cover and connect the **LCD harness** to the connector on the back of LCD.
2. Stick the **MYLAR tape** on the connector of LCD harness.
3. Secure the LCD unit with the following **screws**, and connect LCD harness with CCD FPC.

- M2.0×3.0F FLAT BIND screw x4

4. Secure the display mask with following **screws**

- M2.0×4.0F FLAT BIND screw x4

5. Cover screws with Screw MYLAR cover x4

**NOTE:** *When installing the display mask, make sure there is no gap between the display mask and the display cover.*

## 4.15 Web Camera module

### Removing Web Camera module

The following describes the procedure for removing the Web Camera module.

(See Figure 4-15-1 to 4-15-3).

1. Remove EMI tape on the web camera module.
2. Peel off the glue of Web Camera module.
3. Peel off the glue of Web Camera module.

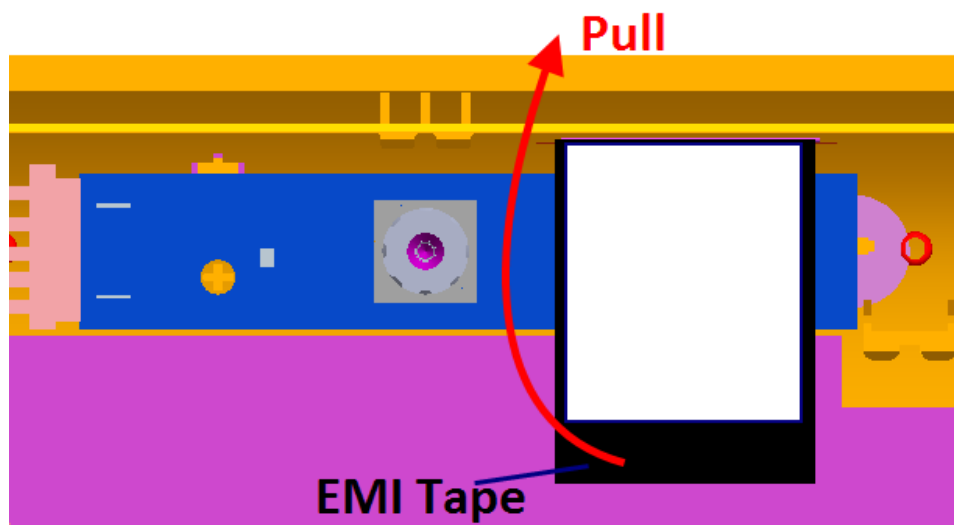

Figure 4-15-1 Remove EMI tape on the web camera module

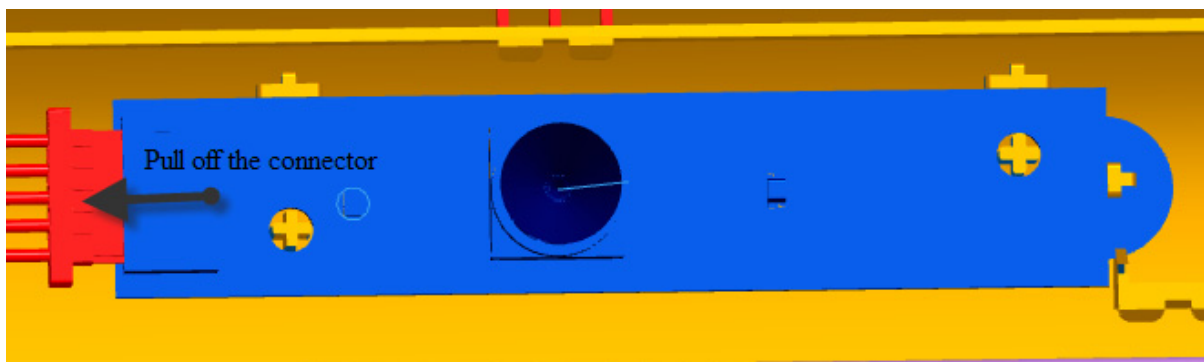
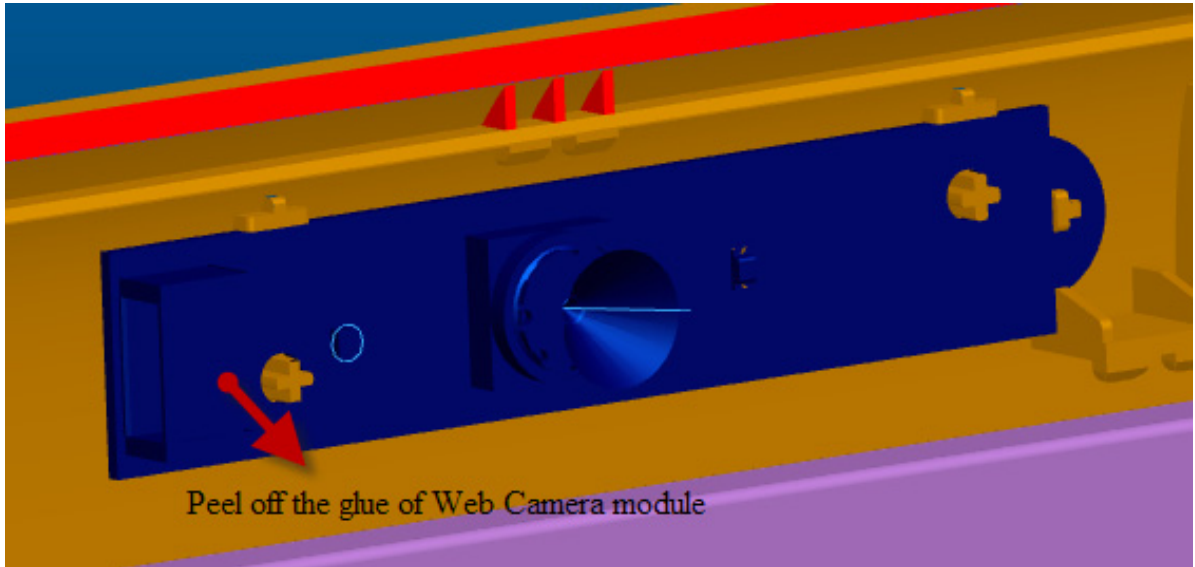

Figure 4-15-2 Remove the connector of Web Camera module



*Figure 4-15-3 Peel off the glue of Web Camera module*

### **Installing Web Camera module**

The following describes the procedure for installing the Web Camera module.

1. Connect the connector of Web Camera module.
2. Pull in the glue of Web Camera Module.
3. Install the EMI tape on the web camera module.



## 4.16 Application for Thermal grease on CPU and North Bridge

(See Figure 4-16-1)

### I. For Flatiron mini thermal grease on North Bridge and CPU

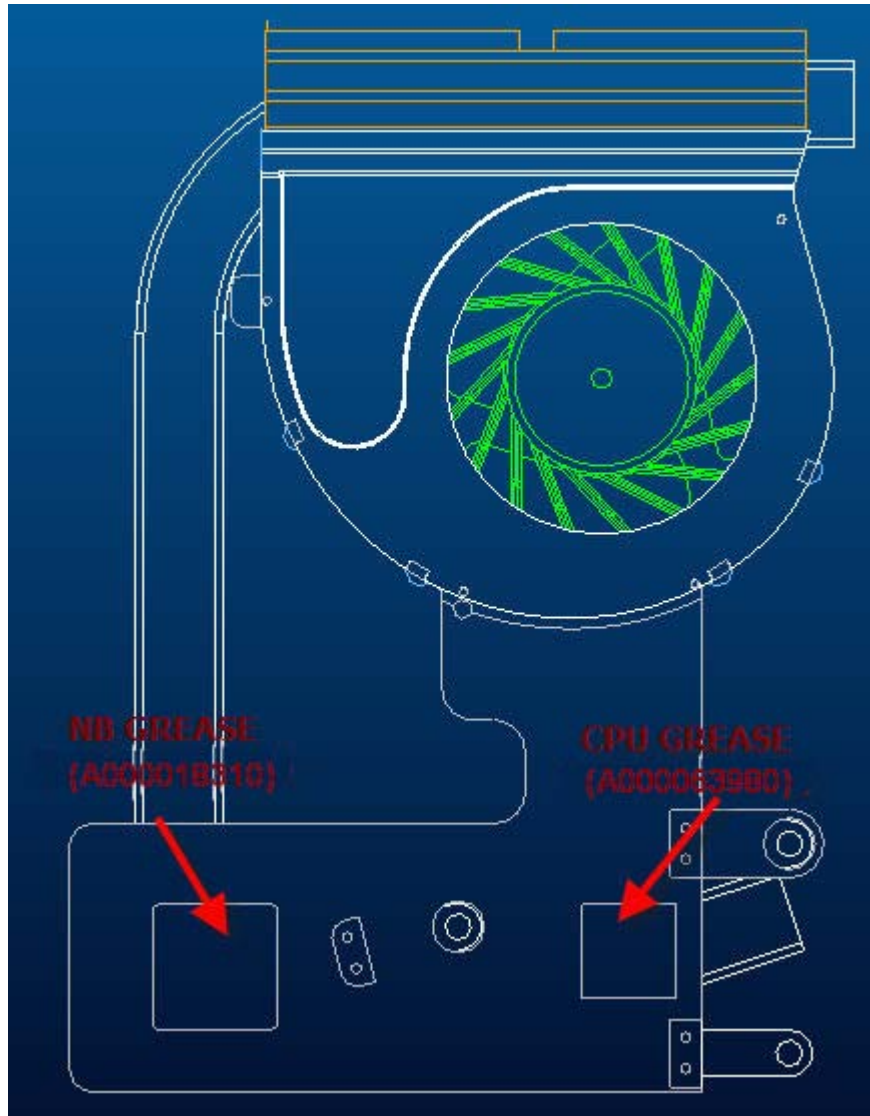
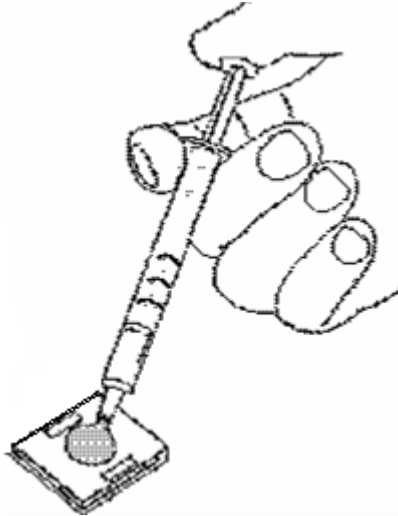

Figure 4-16-1 Intel &AMD Thermal grease on North Bridge and CPU

<b>A000018310</b>	<b>THERMAL GREASE FCR-AS</b>
<b>A000063980</b>	<b>THERMAL GREASE 7762</b>

**II. Use grease on North Bridge and CPU**

0.15cc for one repair.



*Figure 4-16-2 Apply silicon grease for North Bridge and CPU*

## 4.17 Speaker Box

### Removing Speaker Box

The following describes the procedure for removing Speaker Box. (See Figure 4-17-1 to 4-17-3).

1. Remove the following **screws** securing Speaker Box.
  - M2.0×3F FLAT BIND screw x4
2. Remove the Speaker Box.



*Figure 4-17-1 Remove the securing screws at left side.*

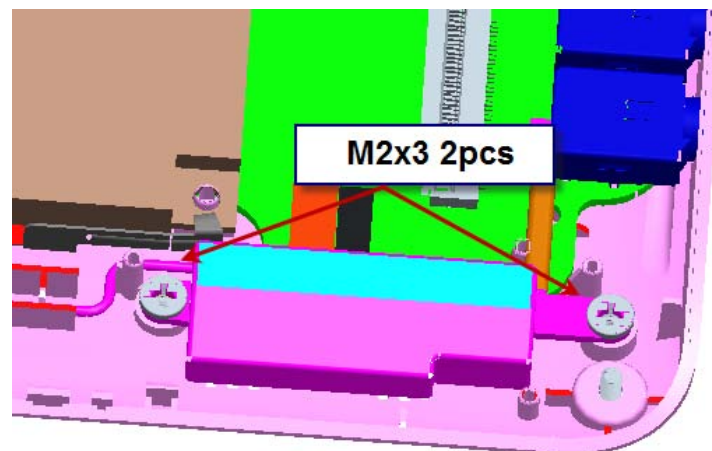

*Figure 4-17-2 Remove the securing screws at right side*

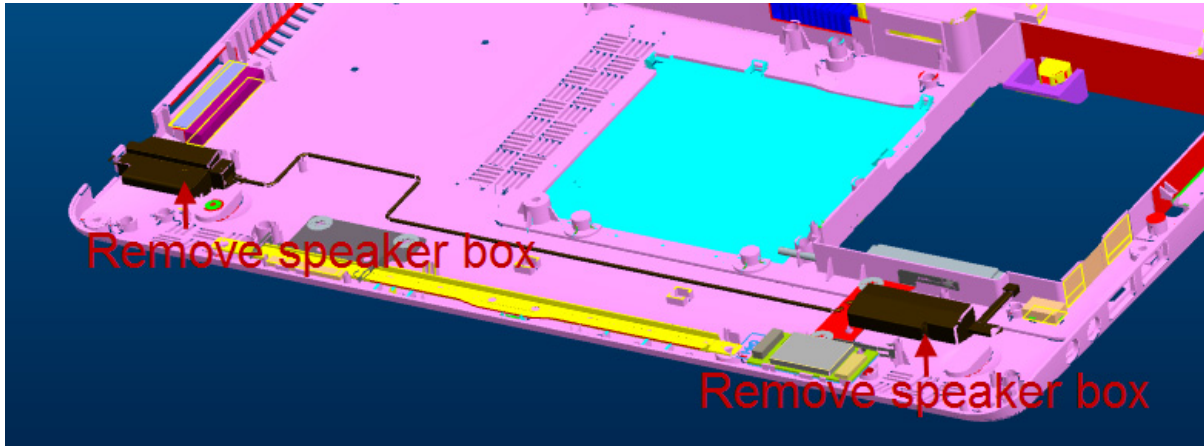

*Figure 4-17-3 Remove the Speaker Box.*

### **Installing Speaker Box**

The following describes the procedure for installing Speaker Box.

1. Install the Speaker Box.
2. Secure Speaker Box of following screws.
  - M2.0×3F FLAT BIND screw x4

## **4.18 HDD Cable**

### **Removing HDD cable**

The following describes the procedure for removing HDD cable. (See Figure 4-18-1).

1. Remove HDD door and RAM door.
2. Pull out HDD cable from the direction as below picture showed.

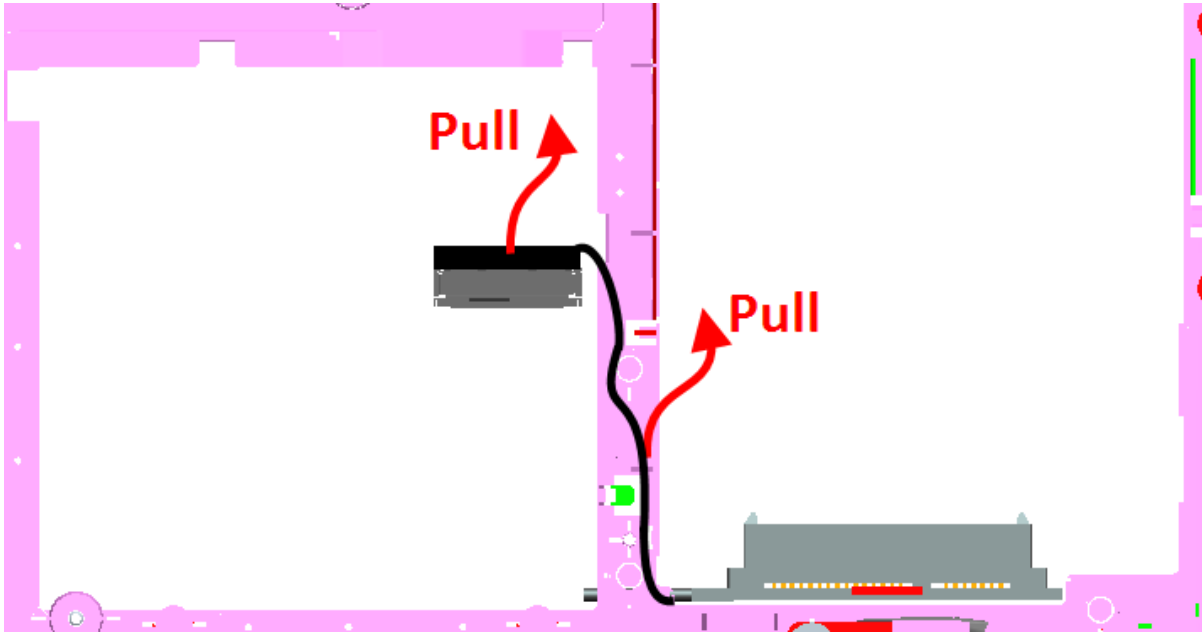

*Figure 4-18-1 Remove the HDD cable.*

### **Installing HDD cable**

The following describes the procedure for installing HDD cable.

1. Install the HDD cable.

---

# **Chapter 4**

## **Replacement Procedures**

---

## **Chapter 4 Contents**

---

4.1	Overview.....	1
	Safety Precautions.....	2
	Before You Begin .....	3
	Disassembly Procedure.....	4
	Assembly Procedure .....	5
	Tools and Equipment .....	5
	Screw Tightening Torque .....	6
	Grip Color .....	6
	Screw Notation.....	7
4.2	Battery pack .....	8
4.3	HDD.....	11
4.4	Memory Module .....	14
4.5	Keyboard.....	17
4.6	Wireless LAN card and BT Module .....	20
4.7	3G Module card .....	22
4.8	Display Assembly .....	23
4.9	Top Cover Assembly .....	31
4.10	Touch pad.....	35
4.11	I/O boards.....	38
4.12	System Board .....	39
4.13	CPU heat sink .....	45
4.14	LCD unit .....	47
4.15	Web Camera Module .....	51
4.16	Application for Thermal grease on CPU and North Bridge .....	53
4.17	Speaker Box .....	55
4.18	HDD cable .....	57

**Figures**

Figure 4-2-1	Remove the battery pack.....	9
Figure 4-2-2	Install the battery pack.....	10
Figure 4-3-1	Turn the computer upside down .....	11
Figure 4-3-2	Remove HDD assembly.....	12
Figure 4-3-3	Remove HDD .....	13
Figure 4-4-1	Remove memory slot cover .....	15
Figure 4-4-2	Remove a memory module.....	15
Figure 4-4-3	Insert a memory module .....	16
Figure 4-5-1	Remove 2 screws for KB Holder .....	18
Figure 4-5-2	Remove Keyboard holder and Keyboard.....	18
Figure 4-6-1	Remove a wireless LAN card .....	20
Figure 4-6-2	Remove a Bluetooth Module .....	21
Figure 4-7-1	Remove a 3G module card.....	22
Figure 4-8-1	Remove HDD slot cover.....	23
Figure 4-8-2	Remove the memory slot cover .....	24
Figure 4-8-3	Remove the screws (from bottom side) .....	24
Figure 4-8-4	Remove the screws (from top side) .....	25
Figure 4-8-5	Disconnect the touch pad FFC/LAN FFC/Power FFC .....	25
Figure 4-8-6	Remove the LAN board.....	26
Figure 4-8-7	Remove the LCD cable from system board.....	26
Figure 4-8-8	Remove the hinge screws .....	27
Figure 4-8-9	Remove the display assembly.....	27
Figure 4-8-10	Secure the hinge screws.....	28
Figure 4-8-11	Connect LCD harness to the system board.....	29
Figure 4-8-12	Arrange and connect Wireless LAN cable and 3G.....	29
Figure 4-8-13	Install the LAN board .....	30
Figure 4-9-1	Remove the screws(back) .....	31
Figure 4-9-2	Remove the screws (front) and top cover assembly .....	32
Figure 4-9-3	Disconnect the touch pad FFC/LAN FFC/Power FFC .....	32
Figure 4-9-4	Remove the screws and Power FFC from the Power Board.....	33
Figure 4-10-1	Remove the touch FFC cable.....	35



## ***Chapter 4 Replacement Procedures***

---

Figure 4-10-2	Loose the screws.....	35
Figure 4-10-3	Remove the touchpad and touchpad board.....	36
Figure 4-11-1	Positions of I/O boards .....	38
Figure 4-11-2	Remove the screws from I/O boards.....	39
Figure 4-12-1	Remove the system board.....	40
Figure 4-12-2	Remove the RTC battery-step_1.....	42
Figure 4-12-3	Remove the RTC battery-step_2.....	43
Figure 4-12-4	Install the RTC Battery .....	44
Figure 4-13-1	Remove the CPU heat sink.....	45
Figure 4-14-1	Remove the display mask .....	47
Figure 4-14-2	Remove screws securing the LCD.....	48
Figure 4-14-3	Remove the LCD .....	48
Figure 4-14-4	Remove the harness .....	49
Figure 4-14-5	Remove the LCD hinge .....	49
Figure 4-15-1	Remove EMI tape on the web camera module.....	51
Figure 4-15-2	Remove the connector of Web Camera module.....	51
Figure 4-15-3	Peel off the glue of Web Camera module.....	52
Figure 4-16-1	Intel &AMD Thermal grease on North Bridge and CPU .....	53
Figure 4-16-2	Apply silicon grease for North Bridge and CPU .....	54
Figure 4-17-1	Remove the securing screws at left side.....	55
Figure 4-17-2	Remove the securing screws at right side.....	55
Figure 4-17-3	Remove the Speaker Box.....	56
Figure 4-18-1	Remove the HDD cable .....	57

---

# Appendices

---

---

# Appendix Contents

---

<b>Appendix A</b>	<b>Handling the LCD Module.....</b>	<b>1</b>
<b>Appendix B</b>	<b>Board Layout.....</b>	<b>1</b>
B.1	System Board.....	1
B.2	Touch Pad Board.....	4
B.3	CRT Board.....	6
B.4	Power Board.....	8
B.5	SIM Card Board.....	10
B.6	HDMI Board.....	12
B.7	ADO_USB Board.....	14
B.8	LAN Board.....	16
<b>Appendix C</b>	<b>Pin Assignment.....</b>	<b>1</b>
C.1	CN1 LCD Panel Connector.....	1
C.2	CN2 Power Board Connectors.....	1
C.3	CN3 Keyboard connectors.....	2
C.4	CN4 LAN Connectors.....	2
C.5	CN5 SATA HDD Connectors.....	3
C.6	CN6 Touchpad Connectors.....	4
C.7	CN8 3G Connector.....	4
C.8	CN9 Audio _ USB Board Connectors.....	5
C.9	CN10 RTC Battery Connectors.....	5
C.10	CN11 HDMI Connectors.....	6
C.11	CN12 Bluetooth Connectors.....	6
C.12	CN14 Battery Connectors.....	7
C.13	CN15 FAN Connectors.....	7
C.14	CN16 CRT Connector.....	7
C.15	CN19 DDR Connectors.....	8
C.16	CN20 DDR Connectors.....	12

C.17	CN21 3G Connectors .....	16
C.18	CN22 WLAN Connectors.....	17
<b>AppendixD</b>	<b>Display Codes.....</b>	<b>1</b>
D.1	Display Codes .....	1
<b>Appendix E</b>	<b>Keyboard Layout .....</b>	<b>1</b>
E.1	United States (US) Keyboard.....	1
E.2	Thai (TI) Keyboard.....	1
E.3	Korean (KO) Keyboard .....	2
E.4	United Kingdom (UK) Keyboard.....	2
E.5	US International (UI) Keyboard.....	3
E.6	Hebrew (HB) Keyboard .....	3
E.7	Danish (DM) Keyboard.....	4
E.8	Swiss (SW) Keyboard .....	4
E.9	Arabic (ARE) Keyboard.....	5
E.10	Czech (CZ) Keyboard.....	5
E.11	Russian (RU) Keyboard .....	6
E.12	Portuguese (PO) Keyboard.....	6
E.13	Slovakian (SL) Keyboard .....	7
E.14	Italian (IT) Keyboard.....	7
E.15	French (FR) Keyboard.....	8
E.16	German (GR) Keyboard .....	8
E.17	Greek (GK) Keyboard .....	9
E.18	French_Canadian (Bilingual) Keyboard.....	9
E.19	Hungarian (HG) Keyboard.....	10
E.20	Spanish (SP) Keyboard.....	10
E.21	Turkish (TR) Keyboard .....	11
E.22	Turkish F (TF-F) Keyboard.....	11
E.23	Swedish (SD) Keyboard .....	12
E.24	Belgian_Flemish (BE) Keyboard .....	12
E.25	Yugoslavian (YU) Keyboard.....	13
E.26	Norwegian (NW) Keyboard .....	13

E.27	Scandinavian (ND) Keyboard .....	14
E.28	Romanian(RM) Keyboard .....	14
E.29	Frence_Canadian(Acnor) Keyboard.....	15
E.30	Japanese (JP) Keyboard.....	15
E.31	Bulgarian Keyboard.....	16
E.32	Taiwan(TW) Keyboard .....	16

<b>Appendix F</b>	<b>Wiring Diagrams.....</b>	<b>F-1</b>
F.1	RGB Monitor ID Wraparound Connector .....	F-1
F.2	LAN Loopbak Connector .....	F-1

---

## **Appendix A Handling the LCD Module**

---

### **Precautions for handling the LCD module**

The LCD module can be easily damaged during assembly or disassembly. Observe the following precautions when handling the LCD module:

1. When installing the LCD module in the LCD cover, be sure to seat it so that it is properly aligned and maximum visibility of the display is maintained.

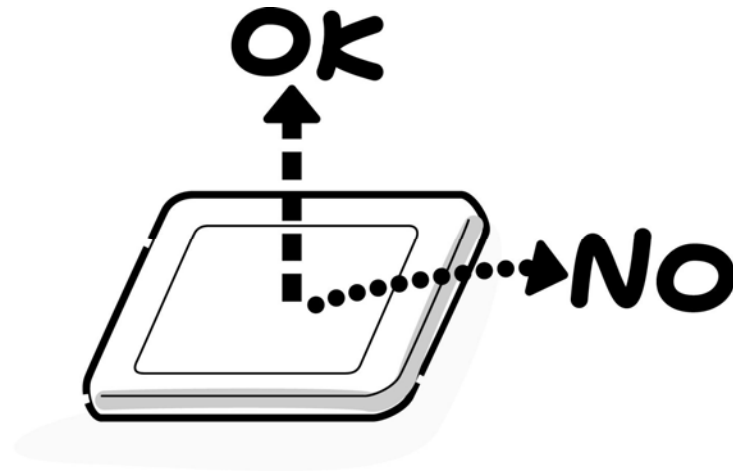

2. Be careful to align the holes at the four corners of the LCD module with the corresponding holes in the LCD cover before securing the module with screws. Do not force the module into place, because stress can affect its performance.

Also, the panel's polarized surface is easily scarred, so be careful when handling it.



## *Handling the LCD Module*

---

3. If the panel's surface gets fingerprint or dust, put on gloves and wipe it with static electricity cloth. If it is still dirty, drop some cleaning alcohol on the surface and wipe it again.

If the surface is much more fingerprint or dust, we recommend a CRT cleaning agent. Apply the agent to a cloth and then wipe the panel's surface. Do not apply cleanser directly to the panel.

If dust still exists, please use ionic FAN which can avoid static electricity to deal with it.



4. If water or other liquid is left on the panel's surface for a long period, it can change the screen's tint or stain it. Be sure to quickly wipe off any liquid with cloth or ionic FAN



5. Glass is used in the panel, so be careful not to drop it or let it strike a hard object, which could cause breakage or cracks.





6. CMOS-LSI circuits are used in the module, so guard against damage from electrostatic discharge. Be sure to wear a wrist or ankle ground when handling the module.

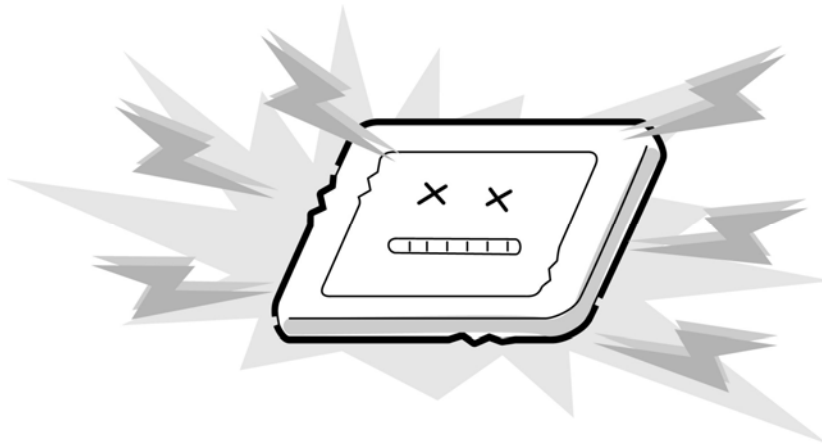

## *Handling the LCD Module*

---

7. Do not expose the module to direct sunlight or strong ultraviolet rays for long periods.

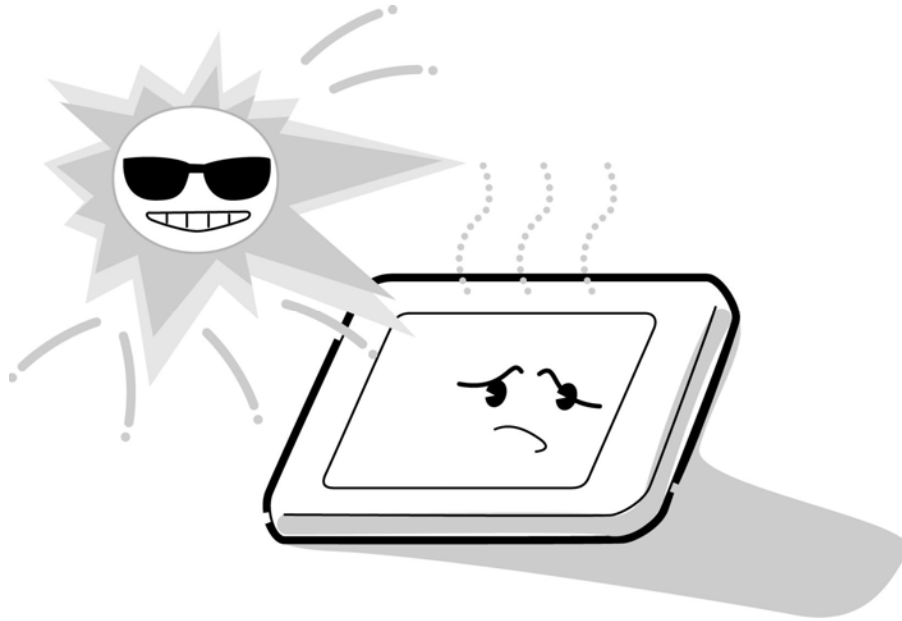

8. Do not store the module at temperatures below specifications. Cold can cause the liquid crystals to freeze, lose their elasticity or otherwise suffer damage.



9. Do not disassemble the LCD module. Disassembly can cause malfunctions.

## *Handling the LCD Module*

---

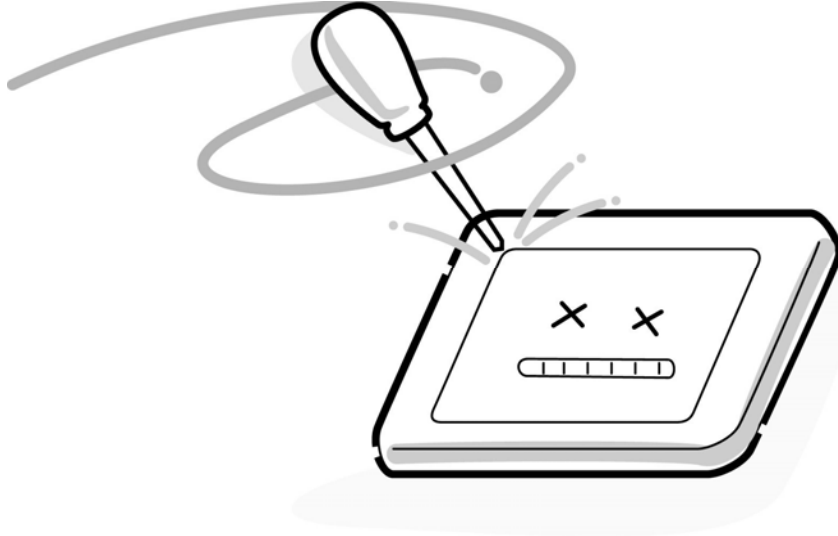

10. If you transport the module, do not use packing material that contains epoxy resin (amine) or silicon glue (alcohol or oxide). These materials can release gas that can damage the panel's polarization.

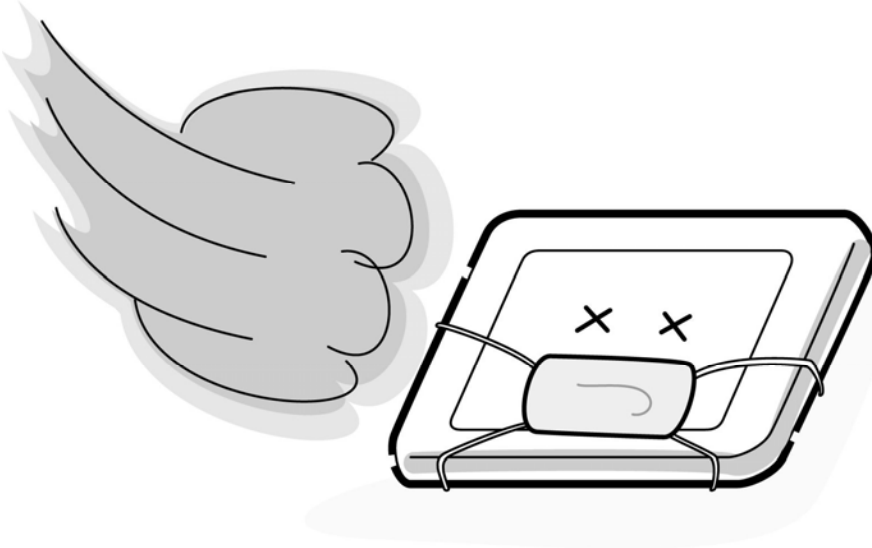

## Appendix B Board Layout

### B.1 System Board

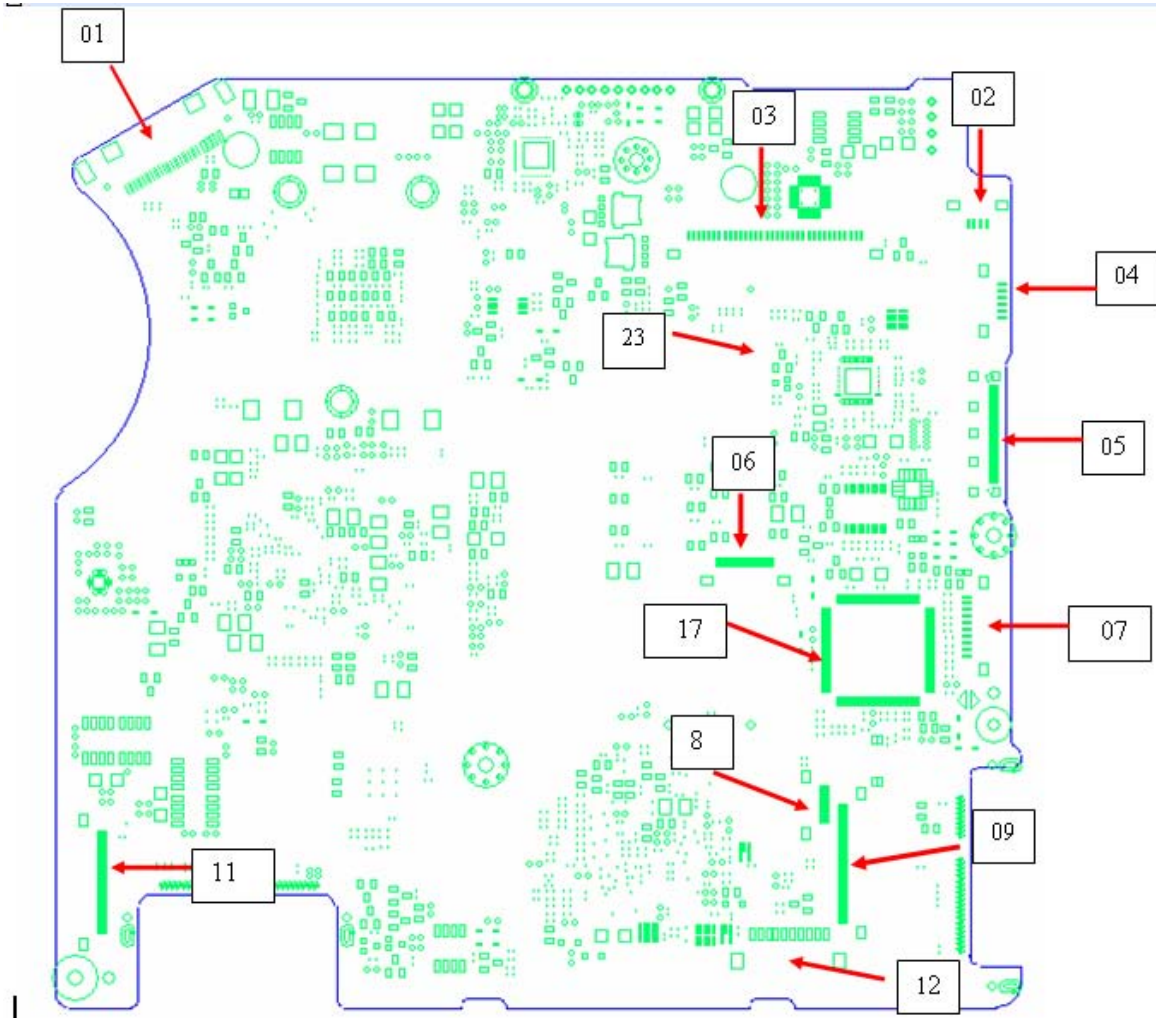
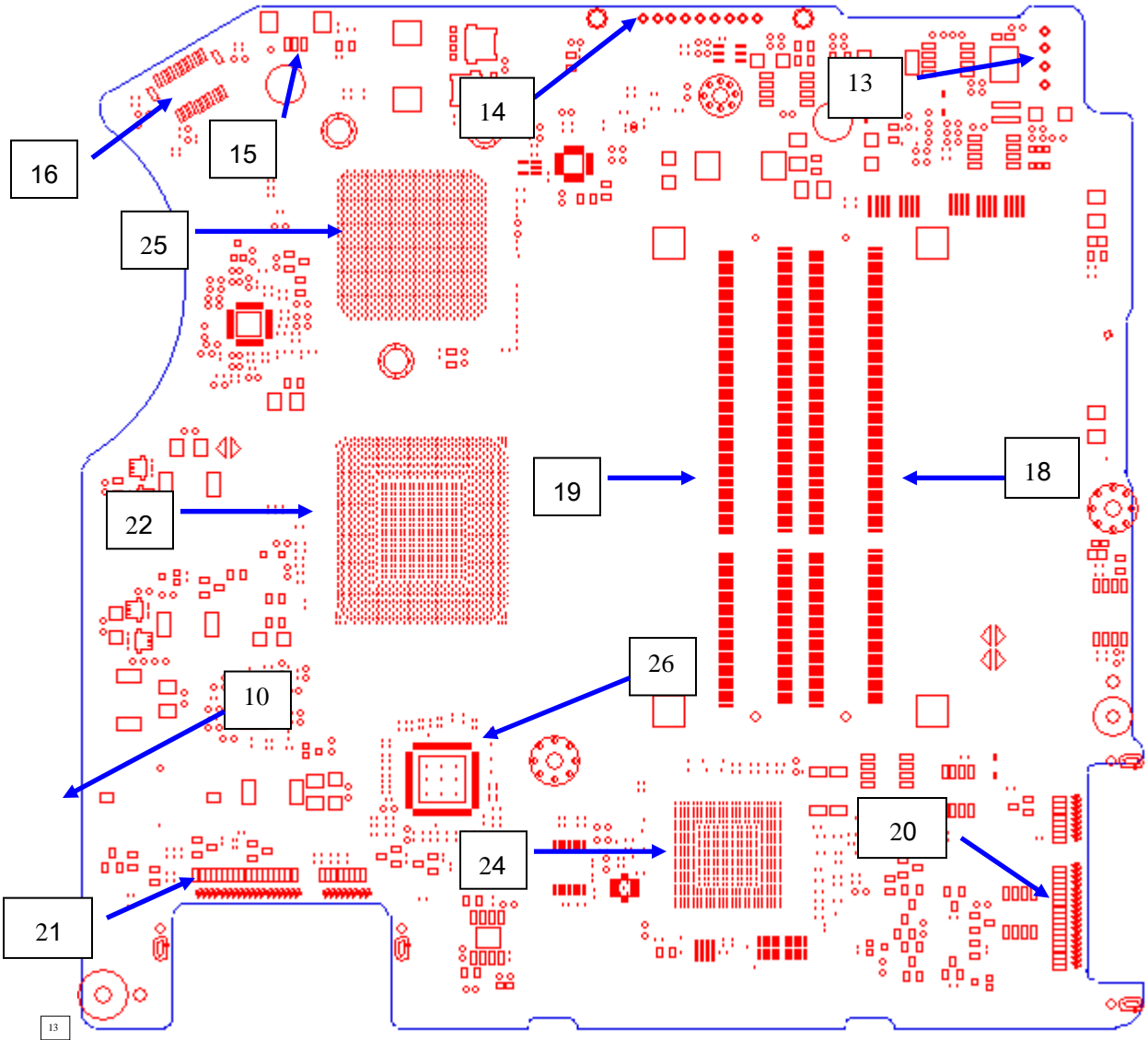

Figure B-1-1 System board layout (front)



*Figure B-1-2 System board layout (Back)*

<b>NUM</b>	<b>Location</b>	<b>Function</b>
<b>(01)</b>	<b>CN1</b>	<b>LVDS CONN</b>
<b>(02)</b>	<b>CN2</b>	<b>POWER BOARD CONN</b>
<b>(03)</b>	<b>CN3</b>	<b>KB CONN</b>
<b>(04)</b>	<b>CN4</b>	<b>LAN CONN</b>
<b>(05)</b>	<b>CN5</b>	<b>SATA HDD CONN</b>

<b>(06)</b>	<b>CN6</b>	<b>TP CONN</b>
<b>(07)</b>	<b>CN7</b>	<b>ODD CONN</b>
<b>(08)</b>	<b>CN8</b>	<b>3G CONN</b>
<b>(09)</b>	<b>CN9</b>	<b>AUDIO Board CONN</b>
<b>(10)</b>	<b>CN10</b>	<b>RTC CONN</b>
<b>(11)</b>	<b>CN11</b>	<b>HDMI Board CONN</b>
<b>(12)</b>	<b>CN12</b>	<b>BT CONN</b>
<b>(13)</b>	<b>PCN1</b>	<b>AC-IN CONN</b>
<b>(14)</b>	<b>CN14</b>	<b>BATTERY CONN</b>
<b>(15)</b>	<b>CN15</b>	<b>FAN CONN</b>
<b>(16)</b>	<b>CN16</b>	<b>CRT CONN</b>
<b>(17)</b>	<b>U9</b>	<b>EC IC</b>
<b>(18)</b>	<b>CN19</b>	<b>DDR CONN</b>
<b>(19)</b>	<b>CN20</b>	<b>DDR CONN</b>
<b>(20)</b>	<b>CN21</b>	<b>3G CONN</b>
<b>(21)</b>	<b>CN22</b>	<b>WLAN CONN</b>
<b>(22)</b>	<b>U15</b>	<b>CPU</b>
<b>(24)</b>	<b>U20</b>	<b>South Bridge</b>
<b>(25)</b>	<b>U14</b>	<b>NB</b>
<b>(26)</b>	<b>U18</b>	<b>CLOCK GEN</b>

Table B-1-3 System board ICs and connectors

## B.2 Touch Pad Board

### <Front layout>

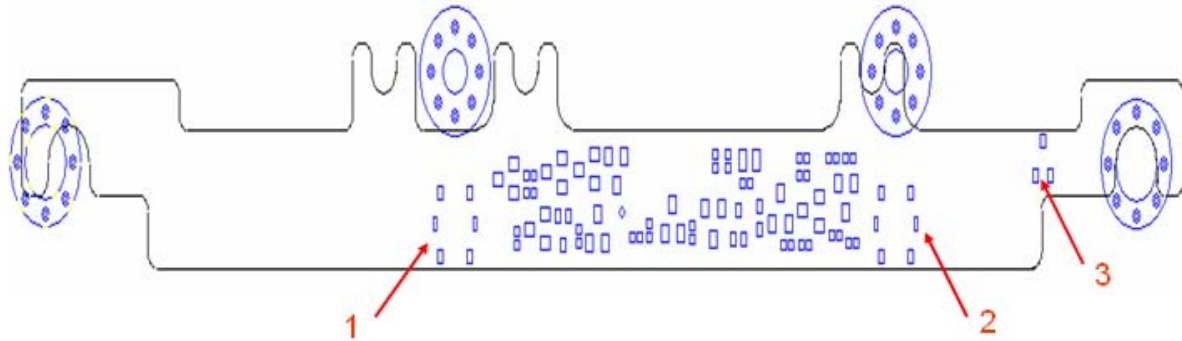

Figure B-2-1 Touch Pad board layout (Front)

NUM	Location	Function
(01)	SW1	Mouse Button Left key
(02)	SW2	Mouse Button Right key
(03)	LID	HALL Sensor

Table B-2-2 Touch Pad board connectors

### <Back layout>

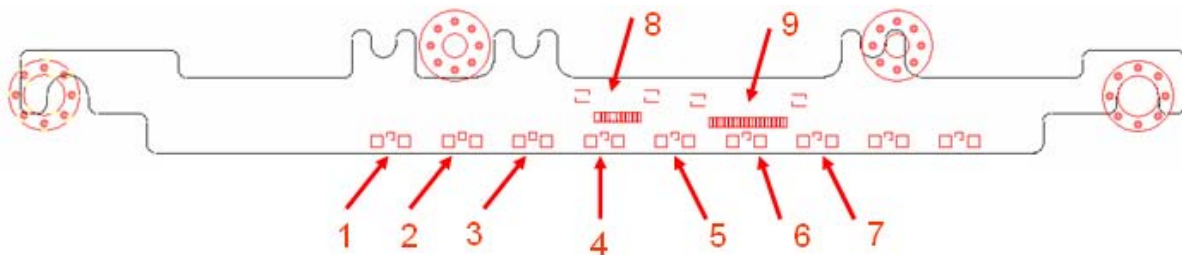

Figure B-2-3 Touch Pad board layout (Back)

<b>NUM</b>	<b>Location</b>	<b>Function</b>
<b>(01)</b>	<b>LED1</b>	<b>AC-IN LED</b>
<b>(02)</b>	<b>LED2</b>	<b>POWER LED</b>
<b>(03)</b>	<b>LED3</b>	<b>BATT LED</b>
<b>(04)</b>	<b>LED4</b>	<b>HDD LED</b>
<b>(05)</b>	<b>LED5</b>	<b>Bridge Media LED</b>
<b>(06)</b>	<b>LED6</b>	<b>W-LAN LED</b>
<b>(07)</b>	<b>LED7</b>	<b>WiMAX/3G LED</b>
<b>(08)</b>	<b>CN2</b>	<b>TP Board to TP Module CONN</b>
<b>(09)</b>	<b>CN1</b>	<b>TP Board to M/B CONN</b>

*Table B-2-4 Touch Pad board connectors*



### B.3 CRT Board

<Front layout>

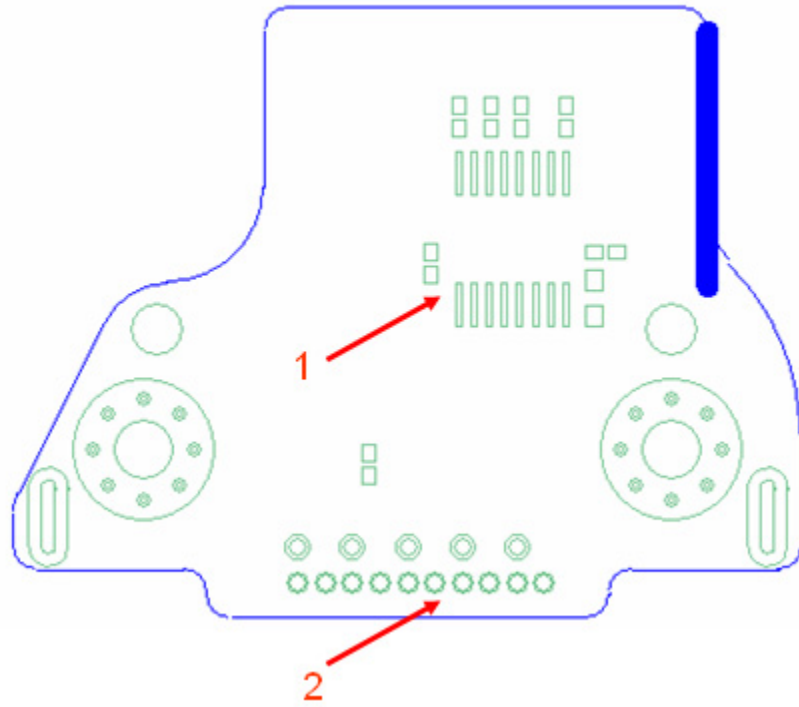
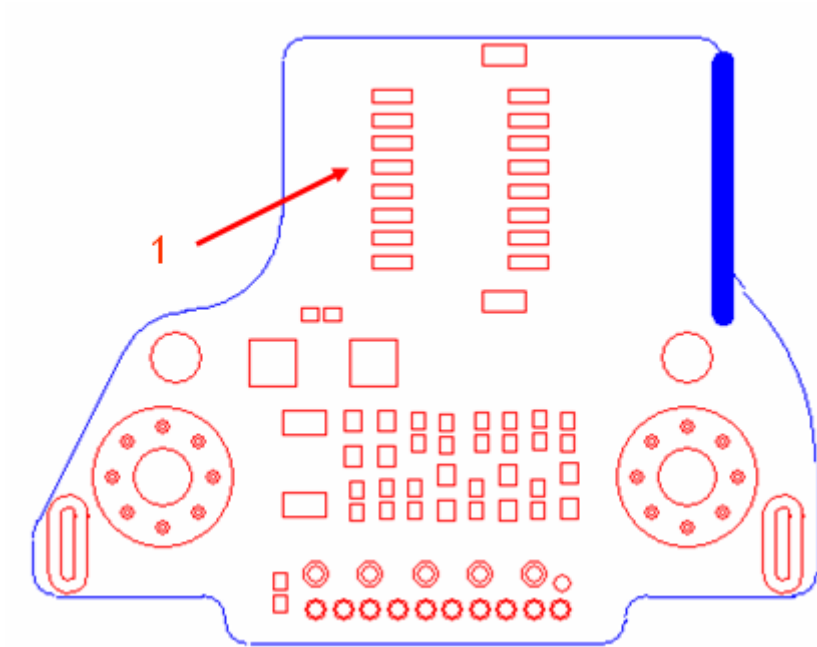

Figure B-3-1 Finger Print Board layout (Front)

NUM	Location	Function
(01)	U1	CRT ESD protection, level-shifting ,sync impedance matching IC
(02)	CN2	CRT CONN

Table B-3-2 CRT Board connectors

**<Back layout>**



*Figure B-3-3 CRT Board layout (Back)*

<b>NUM</b>	<b>Location</b>	<b>Function</b>
<b>(01)</b>	<b>CN1</b>	<b>CRT to M/B CONN</b>

*Table B-3-4 Finger Print Board connectors*

## B.4 Power Board

<Front layout>

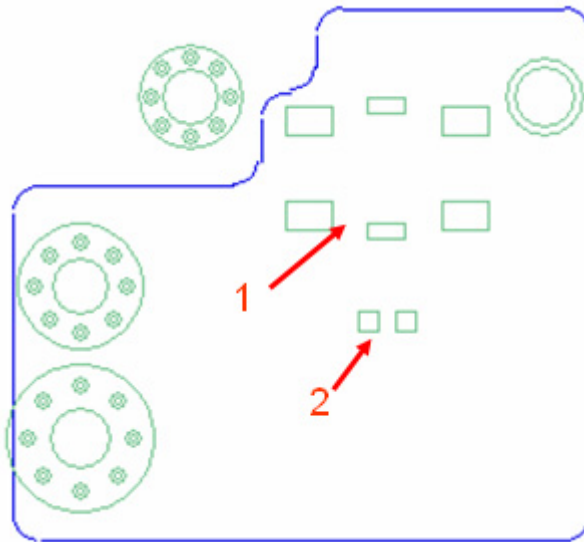

Figure B-4-1 Power Board layout (Front)

NUM	Location	Function
(01)	SW1	Power SW
(02)	LED1	Power LED

Table B-4-2 Power Board connectors

<Back layout>

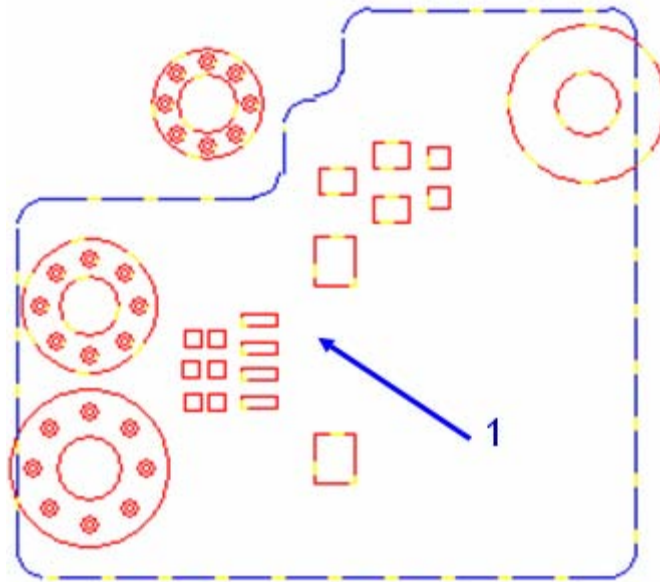

Figure B-4-3 Power Board layout (Back)

NUM	Location	Function
(01)	CN1	Power/B to M/B CONN

Table B-4-4 Power Board connectors

## B.5 SIM (3G) Board

<Front layout>

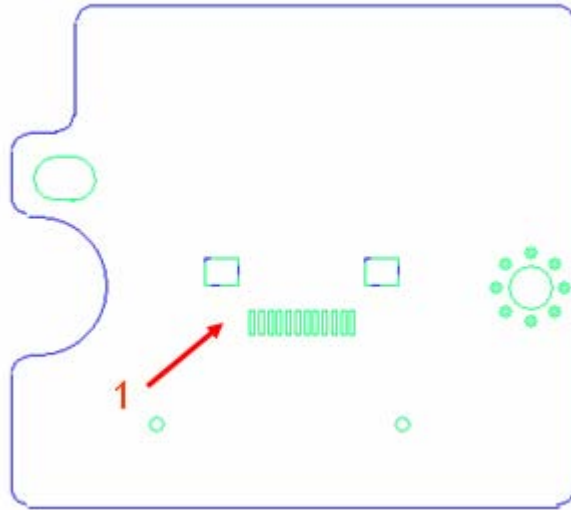
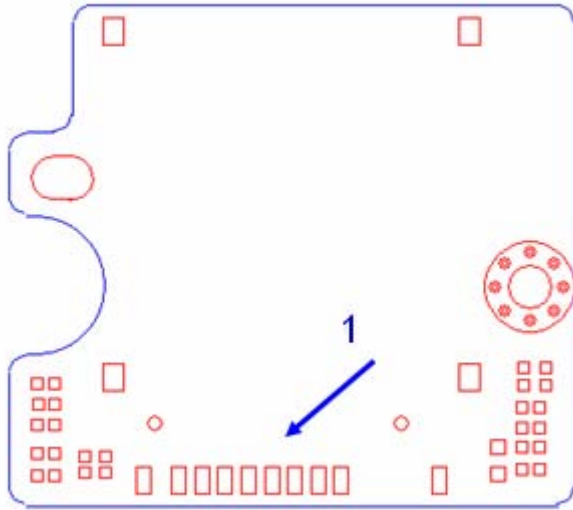

Figure B-5-1 SIM (3G) Board layout (Front)

NUM	Location	Function
(01)	CN1	SIM(3G)/B to M/B CONN

Table B-5-2 SIM (3G) Board connectors

**<Back layout>**



*Figure B-5-3 SIM (3G) Board layout (Back)*

<b>NUM</b>	<b>Location</b>	<b>Function</b>
<b>(01)</b>	<b>JSIM1</b>	<b>SIM Card CONN</b>

*Table B-5-4 SIM (3G) Board connectors*

## B.6 HDMI Board

<Front layout>

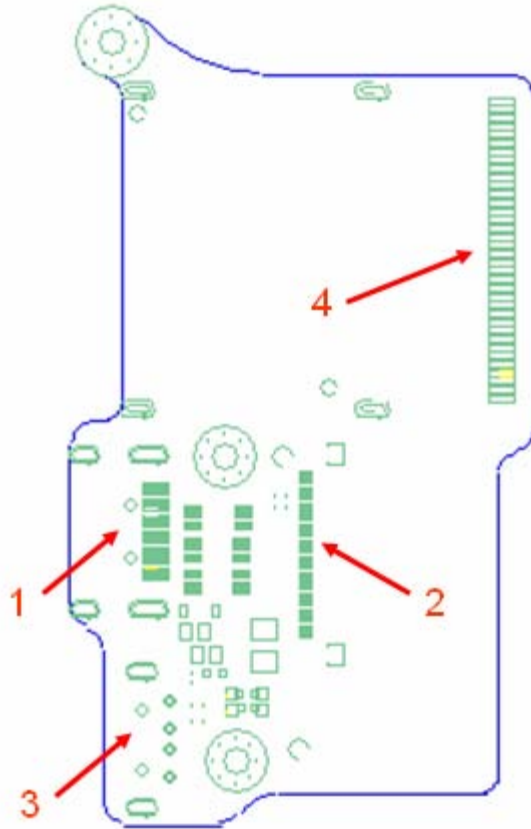

Figure B-6-1 HDMI Board layout (Front)

NUM	Location	Function
(01)	CN1	HDMI CONN
(02)	CN2	HDMI/B to M/B CONN
(03)	CN3	USB CONN
(04)	CN4	5 IN 1 Card Reader CONN

Table B-6-2 HDMI Board connectors

<Back layout>

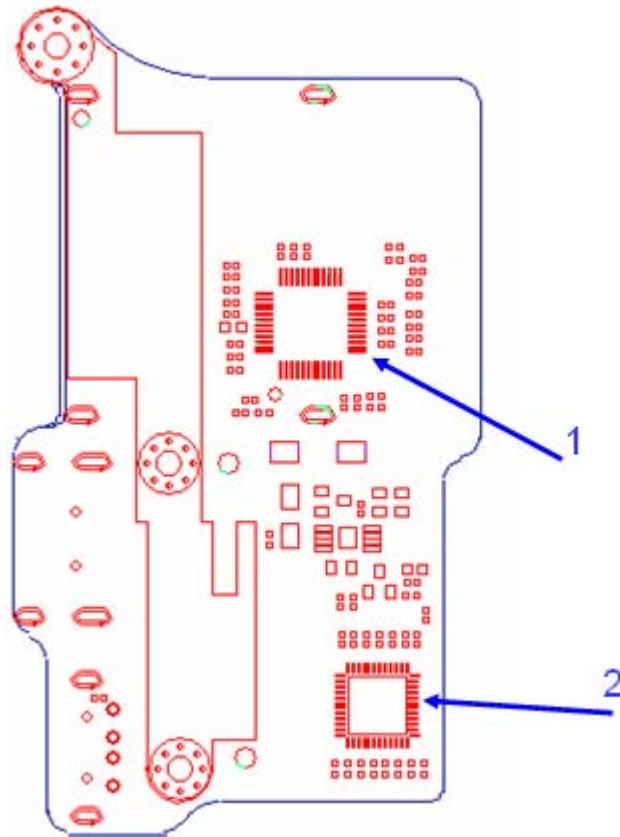

Figure B-6-3 HDMI Board layout (Front)

	Location	Function
(01)	U3	HDMI LEVEL SHIFT IC
(02)	U1	Card Reader IC

Table B-6-4 HDMI Board connectors



B.7 ADO\_USB Board

<Front layout>

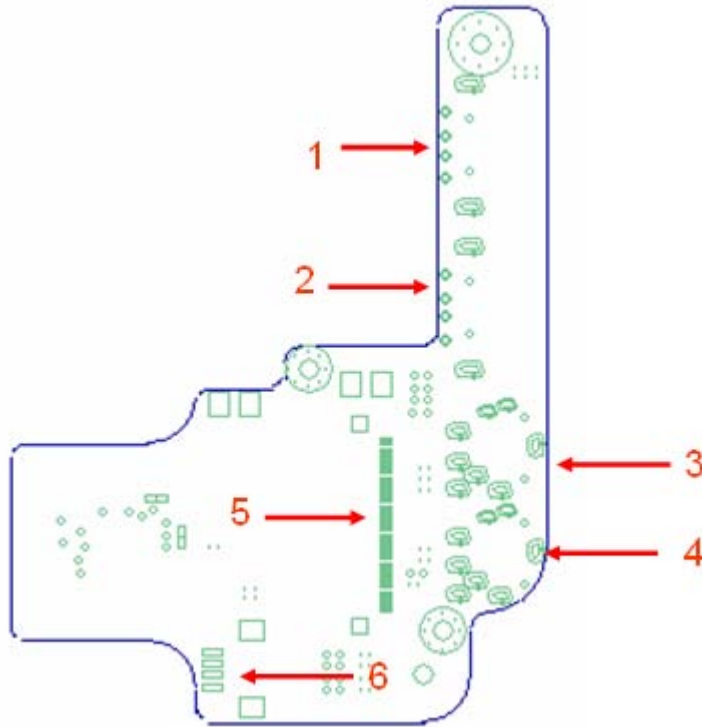

Figure B-7-1 ADO\_USB Board layout (Front)

NUM	Location	Function
(01)	CN3	USB CONN
(02)	CN2	USB CONN
(03)	CN7	Inner Speaker CONN
(04)	CN5	Earphone CONN
(05)	CN1	ADO_USB Board to M/B CONN
(06)	CN6	External MIC CONN

Table B-7-2 ADO\_USB Board connectors

<Back layout>

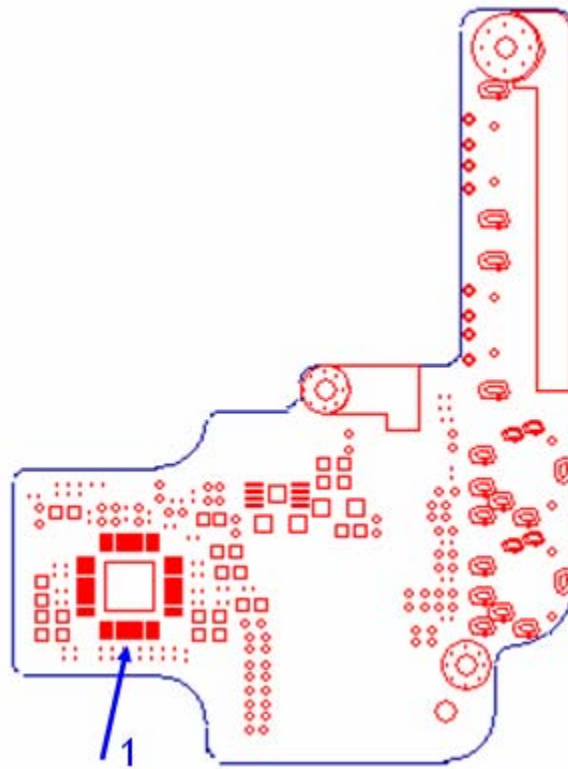

Figure B-7-3 ADO\_USB Board layout (Back)

NUM	Location	Function
(01)	U2	Codec IC

Table B-7-4 ADO\_USB Board IC

## B.8 LAN Board

<Front layout>

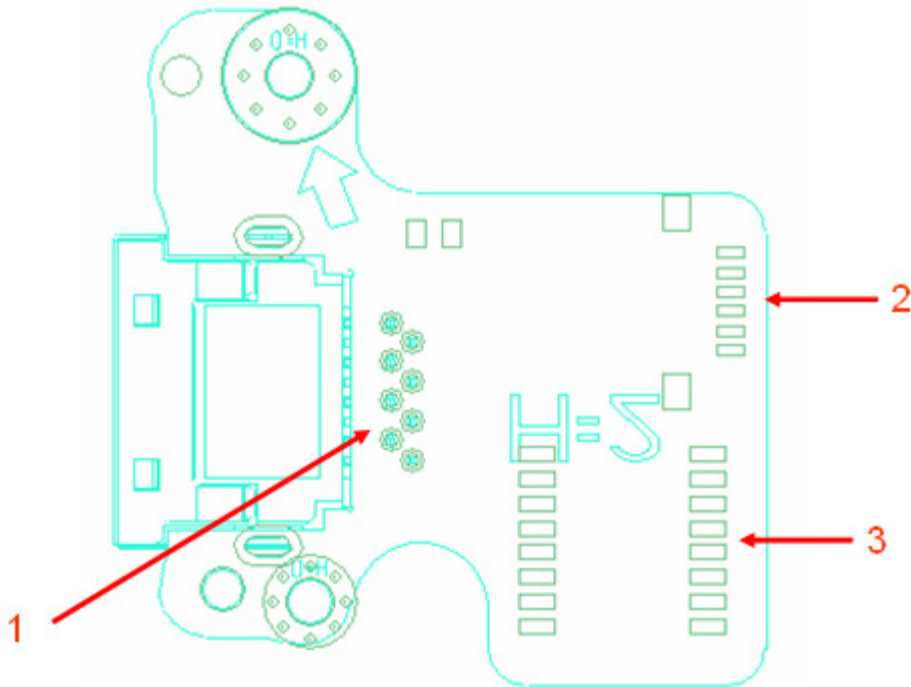
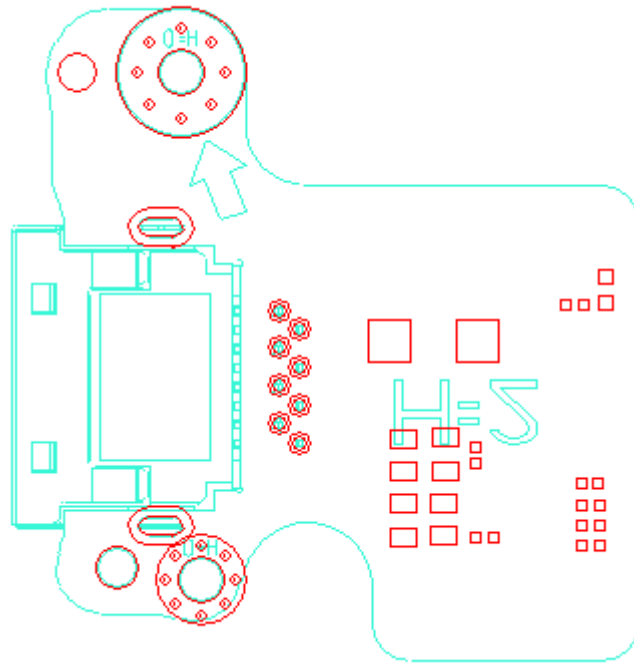

Figure B-8-1 LAN Board layout (Front)

NUM	Location	Function
(01)	CN1	RJ45 CONN
(02)	CN2	LAN Board to M/B CONN
(03)	U1	LAN Transformer

Table B-8-1 LAN Board IC and connectors

**<Back layout>**



*Figure B-8-2 LAN Board layout (Back)*

---

## **Appendix C Pin Assignment**

---

### **C.1 CN1 LCD Panel Connectors**

PIN No.	Signal name	I/O	PIN No.	Signal name	I/O
1	VIN	---	2	VIN	---
3	LCDVCC	---	4	LCDVCC	---
5	+3V	---	6	CDD_POWER	I
7	MIC_GND	---	8	IN_MIC_R	I
9	GND	---	10	GND	---
11	USBP3-_LCD	---	12	USBP3+_LCD	---
13	GND	---	14	LCD_DDCCLK	I/O
15	LCD_DDCDAT	I/O	16	GND	---
17	INT_TXLCLKOUT-	I	18	INT_TXLCLKOUT+	I
19	GND	---	20	INT_TXOUT2-	I
21	INT_TXOUT2+	I	22	GND	---
23	INT_TXOUT1-	I	24	INT_TXOUT1+	I
25	GND	---	26	INT_TXOUT0-	I
27	INT_TXOUT0+	I	28	GND	---
29	LVDS_VADJ	---	30	DISPON	---

### **C.2 CN2 Power Board Connector**

PIN No.	Signal name	I/O	PIN No.	Signal name	I/O
1	+3VPCU	I	2	NBSWON#	I
3	PWRLED#	I	4	GND	---

### **C.3 CN3 Keyboard Connectors**

<b>PIN No.</b>	<b>Signal name</b>	<b>I/O</b>	<b>PIN No.</b>	<b>Signal name</b>	<b>I/O</b>
1	K_LED_P	---	2	MY16	O
3	---	---	4	MX17	O
5	---	---	6	K_LED_P	---
7	MY2	O	8	MY1	O
9	MY0	O	10	MY4	O
11	MY3	O	12	MY5	O
13	MY14	O	14	MY6	O
15	MY7	O	16	MY13	O
17	MY8	O	18	MY9	O
19	MY10	O	20	MY11	O
21	MY12	O	22	MY15	O
23	MX7	O	24	MX2	O
25	MX3	O	26	MX4	O
27	MX0	O	28	MX5	O
29	MX6	O	30	MX1	O
31	K_LED_P	O	32	CAPSLED	O
33	FN_F10	O	34	NUMLED	O

### **C.4 CN4 LAN Connector**

<b>PIN No.</b>	<b>Signal name</b>	<b>I/O</b>	<b>PIN No.</b>	<b>Signal name</b>	<b>I/O</b>
1	AVDD_CEN	---	2	TX1P	---
3	TX1N	---	4	GND	---
5	TX0P	---	6	TX0N	---

**C.5 CN5 SATA HDD Connectors**

<b>PIN No.</b>	<b>Signal name</b>	<b>I/O</b>	<b>PIN No.</b>	<b>Signal name</b>	<b>I/O</b>
1	NC	---	2	GND	---
3	NC	---	4	SATA_TXP0	I/O
5	NC	---	6	SATA_TXN0	I/O
7	NC	---	8	GND	---
9	NC	---	10	SATA_RXN0	I/O
11	NC	---	12	SATA_RXP0	I/O
13	NC	---	14	GND	---
15	NC	---	16	NC	---
17	GND	---	18	GND	---
19	GND	---	20	GND	---
21	GND	---	22	GND	---
23	NC	---	24	+5V	---
25	+5V	---	26	+5V	---
27	+5V	---	28	+5V	---
29	+5V	---	30	NC	---
31	GND	---	32	GND	---
33	GND	---	34	GND	---
35	GND	---	36	GND	---
37	GND	---			

**C.6 CN6 Touchpad Connectors**

PIN No.	Signal name	I/O	PIN No.	Signal name	I/O
1	GND	---	2	GND	---
3	GND	---	4	LID591#	O
5	TPCLK	I	6	TPDATA	I
7	MMC_LED#	---	8	3G_WIMAX_LED#	---
9	RF_LED	I	10	SATA_LED#_C	---
11	BAT_SAT1	I	12	BAT_SAT0	I
13	SUSLED_EC	I	14	PWERLED#	I
15	ACIN	I	16	+3V	---
17	+3VPCU	---	18	NUMLED	---
19	+5V	---	20	FN_F10	---

**C.7 CN8 3G Connector**

PIN No.	Signal name	I/O	PIN No.	Signal name	I/O
1	GND	---	2	UIM_CLK	I/O
3	GND	---	4	UIM_DATA	I/O
5	GND	---	6	UIM_RST	I/O
7	UIM_VPP	I/O	8	UIM_PWR	---
9	GND	---	10	USBP7+	I/O
11	USBP7-	G/O	12	GND	---



**C.8 CN9 Audio USB Board Connectors**

<b>PIN No.</b>	<b>Signal name</b>	<b>I/O</b>	<b>PIN No.</b>	<b>Signal name</b>	<b>I/O</b>
1	ACZ_SDIN0_AUDIO	O	2	ACZ_SDOUT_AUDIO	I/O
3	GND	---	4	ACZ_SYNC_AUDIO	I
5	ACZ_RST#_AUDIO	I	6	GND	---
7	BIT_CLK_AUDIO	I/O	8	GND	---
9	GND	---	10	MIC_GND	O
11	INT_MIC_R	O	12	GND	---
13	AMP_MUTE#	I	14	PCBEEP	I
15	GND	---	16	GND	---
17	USBOC#0_1	I/O	18	GND	---
19	USBP0+	I/O	20	USBP0-	I/O
21	GND	---	22	USBP1+	I/O
23	USBP1-	I/O	24	GND	---
25	USB_EN#0_1	O	26	+3V	---
27	NC	---	28	+1.5V	---
29	NC	---	30	+5V	---
31	+5V	---	32	+5	---
33	+5VPCU	---	34	+5VPCU	---
35	+5VPCU	---	36	+5VPCU	---
37	+5VPCU	---			

**C.9 CN10 RTC Battery Connectors**

<b>PIN No.</b>	<b>Signal name</b>	<b>I/O</b>	<b>PIN No.</b>	<b>Signal name</b>	<b>I/O</b>
1	RTC_NO2	I	2	GND	---

**C.10 CN11 HDMI Connectors**

PIN No.	Signal name	I/O	PIN No.	Signal name	I/O
1	USBP5-	I/O	2	USBP5+	I/O
3	GND	---	4	PLTRST#	I
5	+3V	---	6	+5VPCU	---
7	+5VPCU	---	8	+5VPCU	---
9	+5VPCU	---	10	+5V	---
11	NC	---	12	BUSBP9-	I/O
13	BUSBP9+	I/O	14	GND	---
15	USBOC9#	O	16	USB_SLEEP_EN#	I
17	BOARD_ID4	O	18	PORT-B_HPD#	---
19	SDVO_CTRLDATA	O	20	SDVO_CTRLCLK	O
21	GND	I	22	TMDSB_CLK#	I
23	TMDSB_CLK	I	24	GND	---
25	TMDSB_DATA0#	I	26	TMDSB_DATA0	I
27	GND	---	28	TMDSB_DATA2#	I
29	TMDSB_DATA2	I	30	GND	---
31	TMDSB_DATA1#	I	32	TMDSB_DATA1	I

**C.11 CN12 Bluetooth Connectors**

PIN No.	Signal name	I/O	PIN No.	Signal name	I/O
1	GND	---	2	USBP2+	I/O
3	USBP2-	I/O	4	WCS_CLK	---
5	GND	---	6	BT_RESET	---
7	WCS_DAT	O	8	+3V	---

## Pin Assignment

---

9	BT_EN	O	10	GND	---
---	-------	---	----	-----	-----

### C.12 CN14 Battery Connectors

PIN No.	Signal name	I/O	PIN No.	Signal name	I/O
1	GND	---	2	GND	---
3	MBCLK	I/O	4	MBDATA	I/O
5	TEMP_MBAT	---	6	GND	---
7	ID	O	8	MBAT+	---
9	MBAT+	---	10	GND	---
11	GND	---			

### C.13 CN15 FAN Connectors

PIN No.	Signal name	I/O	PIN No.	Signal name	I/O
1	TH_FAN_POWER1	---	2	GND	---
3	FANSIG	O			

### C.14 CN16 CRT Connector

PIN No.	Signal name	I/O	PIN No.	Signal name	I/O
1	+5V	---	2	+3V	---
3	NC	---	4	NC	---
5	GND	---	6	CRT_DDCDAT	I/O
7	CRT_VSYNC	I	8	CRT_DDCCLK	I/O
9	CRT_HSYNC	I	10	GND	---
11	GND	---	12	RED_L	I
13	GREEN_L	I	14	GND	---
15	GND	---	16	BLUE_L	I

**C.15 CN19 DDR Connectors**

<b>PI N No.</b>	<b>Signal name</b>	<b>I/O</b>	<b>PIN No.</b>	<b>Signal name</b>	<b>I/O</b>
1	<i>SMDDR_VREF_DIMM</i>	---	2	<i>GND</i>	---
3	<i>GND</i>	---	4	<i>M_B_DQ4</i>	<i>I/O</i>
5	<i>M_B_DQ0</i>	<i>I/O</i>	6	<i>M_B_DQ5</i>	<i>I/O</i>
7	<i>M_B_DQ1</i>	<i>I/O</i>	8	<i>GND</i>	---
9	<i>GND</i>	---	10	<i>M_B_DQS#0</i>	<i>I</i>
11	<i>M_B_DM0</i>	<i>I/O</i>	12	<i>M_B_DQS0</i>	<i>I/O</i>
13	<i>GND</i>	---	14	<i>GND</i>	---
15	<i>M_B_DQ7</i>	<i>I/O</i>	16	<i>M_B_DQ3</i>	<i>I/O</i>
17	<i>M_B_DQ6</i>	<i>I/O</i>	18	<i>M_B_DQ2</i>	<i>I/O</i>
19	<i>GND</i>	---	20	<i>GND</i>	---
21	<i>M_B_DQ13</i>	<i>I/O</i>	22	<i>M_B_DQ12</i>	<i>I/O</i>
23	<i>M_B_DQ9</i>	<i>I/O</i>	24	<i>M_B_DQ8</i>	<i>I/O</i>
25	<i>GND</i>	---	26	<i>GND</i>	---
27	<i>M_B_DQS#1</i>	<i>I/O</i>	28	<i>M_B_DM1</i>	<i>I/O</i>
29	<i>M_B_DQS1</i>	<i>I/O</i>	30	<i>DDR3_DRAMRS T#</i>	<i>I</i>
31	<i>GND</i>	---	32	<i>GND</i>	---
33	<i>M_B_DQ11</i>	<i>I/O</i>	34	<i>M_B_DQ14</i>	<i>I/O</i>
35	<i>M_B_DQ10</i>	<i>I/O</i>	36	<i>M_B_DQ15</i>	<i>I/O</i>
37	<i>GND</i>	---	38	<i>GND</i>	---
39	<i>M_B_DQ16</i>	<i>I/O</i>	40	<i>M_B_DQ20</i>	<i>I/O</i>
41	<i>M_B_DQ21</i>	<i>I/O</i>	42	<i>M_B_DQ17</i>	<i>I/O</i>
43	<i>GND</i>	---	44	<i>GND</i>	---
45	<i>M_B_DQS#2</i>	<i>I/O</i>	46	<i>M_B_DM2</i>	<i>I/O</i>

## Pin Assignment

47	M_B_DQS2	I/O	48	GND	---
49	GND	---	50	M_B_DQ18	O
51	M_B_DQ22	I/O	52	M_B_DQ23	I/O
53	M_B_DQ19	I/O	54	GND	---
55	GND	---	56	M_B_DQ28	I/O
57	M_B_DQ24	I/O	58	M_B_DQ25	I/O
59	M_B_DQ29	I/O	60	GND	---
61	GND	---	62	M_B_DQS#3	I/O
63	M_B_DM3	I/O	64	M_B_DQS3	I/O
65	GND	---	66	GND	---
67	M_B_DQ26	I/O	68	M_B_DQ30	I/O
69	M_B_DQ27	I/O	70	M_B_DQ31	I/O
71	GND	---	72	GND	---
73	M_CKE2	I/O	74	M_CKE3	I/O
75	+1.5VSUS	---	76	+1.5VSUS	---
77	NC	---	78	NC	---
79	M_B_BS#2	I	80	M_B_A14	I
81	+1.5VSUS	---	82	+1.5VSUS	---
83	M_B_A12	I	84	M_B_A11	I
85	M_B_A9	I	86	M_B_A7	---
87	+1.5VSUS	---	88	+1.5VSUS	---
89	M_B_A8	I/O	90	M_B_A6	I/O
91	M_B_A5	I/O	92	M_B_A4	I/O
93	+1.5VSUS	---	94	+1.5VSUS	---
95	M_B_A3	I/O	96	M_B_A2	I/O

## Pin Assignment

97	<i>M_B_A1</i>	<i>I/O</i>	98	<i>M_B_A0</i>	<i>I/O</i>
99	+1.5VSUS	---	100	+1.5VSUS	---
101	<i>M_CLK_DDR2</i>	<i>I/O</i>	102	<i>M_CLK_DDR3</i>	<i>I/O</i>
103	<i>M_CLK_DDR#2</i>	<i>I/O</i>	104	<i>M_CLK_DDR#3</i>	<i>I/O</i>
105	+1.5VSUS	---	106	+1.5VSUS	----
107	<i>M_B_A13</i>	<i>I</i>	108	<i>M_B_BS#1</i>	<i>I</i>
109	<i>M_B_BS#0</i>	<i>I</i>	110	<i>M_B_RAS#</i>	<i>I</i>
111	+1.5VSUS	---	112	+1.5VSUS	---
113	<i>M_B_WE#</i>	<i>I</i>	114	<i>M_CS#2</i>	<i>I</i>
115	<i>M_B_CAS#</i>	<i>I</i>	116	<i>M_ODT2</i>	<i>I/O</i>
117	+1.5VSUS	---	118	+1.5VSUS	---
119	<i>M_B_A13</i>	<i>I</i>	120	<i>M_ODT3</i>	---
121	<i>M_CS#3</i>	---	122	<i>NC</i>	---
123	+1.5VSUS	---	124	+1.5VSUS	---
125	<i>NC</i>	<i>I/O</i>	126	<i>SMDDR_VREF_DIMM</i>	---
127	<i>GND</i>	---	128	<i>GND</i>	---
129	<i>M_B_DQ32</i>	<i>I/O</i>	130	<i>M_B_DQ36</i>	<i>I</i>
131	<i>M_B_DQ37</i>	<i>I/O</i>	132	<i>M_B_DQ33</i>	<i>I/O</i>
133	<i>GND</i>	---	134	<i>GND</i>	---
135	<i>M_B_DQS#4</i>	<i>I/O</i>	136	<i>M_B_DM4</i>	<i>I/O</i>
137	<i>M_B_DQS4</i>	<i>I/O</i>	138	<i>GND</i>	---
139	<i>GND</i>	---	140	<i>M_B_DQ38</i>	<i>I/O</i>
141	<i>M_B_DQ34</i>	<i>I/O</i>	142	<i>M_B_DQ39</i>	<i>I/O</i>
143	<i>M_B_DQ35</i>	<i>I/O</i>	144	<i>GND</i>	---
145	<i>GND</i>	---	146	<i>M_B_DQ44</i>	<i>I/O</i>

## Pin Assignment

147	M_B_DQ41	I/O	148	M_B_DQ45	I/O
149	M_B_DQ40	I/O	150	GND	---
151	GND	I/O	152	M_B_DQS#5	I/O
153	M_B_DM5	I/O	154	M_B_DQS5	I/O
155	GND	---	156	GND	---
157	M_B_DQ43	I/O	158	M_B_DQ46	I/O
159	M_B_DQ47	I/O	160	M_B_DQ42	I/O
161	GND	---	162	GND	---
163	M_B_DQ53	I/O	164	M_B_DQ50	I/O
165	M_B_DQ52	I/O	166	M_B_DQ48	I/O
167	GND	---	168	GND	---
169	M_B_DQS#6	I/O	170	M_B_DM6	I
171	M_B_DQS6	---	172	GND	---
173	GND	---	174	M_B_DQ51	I/O
175	M_B_DQ51	I/O	176	M_B_DQ55	I/O
177	M_B_DQ49	I/O	178	GND	---
179	GND	---	180	M_B_DQ59	I/O
181	M_B_DQ56	I/O	182	M_B_DQ61	I/O
183	M_B_DQ57	I/O	184	GND	---
185	GND	---	186	M_B_DQS#7	I/O
187	M_B_DM7	I/O	188	M_B_DQS7	I/O
189	GND	---	190	GND	---
191	M_B_DQ60	I/O	192	M_B_DQ58	I/O
193	M_B_DQ62	I/O	194	M_B_DQ63	I/O
195	GND	---	196	GND	---

## Pin Assignment

197	SA0	I/O	198	PM_EXTTS#1	--
199	+3V	---	200	CGDAT_SMB	I/O
201	SA0	---	202	CGCLK_SMB	I/O
203	+SMDDR_VTERM	I/O	204	+SMDDR_VTERM M	I/O

### C.16 CN20 DDR Connectors

PIN No.	Signal name	I/O	PIN No.	Signal name	I/O
1	SMDDR_VREF_DIMM	---	2	GND	---
3	GND	---	4	M_A_DQ4	I/O
5	M_A_DQ0	I/O	6	M_A_DQ7	I/O
7	M_A_DQ5	I/O	8	GND	---
9	GND	---	10	M_A_DQS#0	I/O
11	M_A_DM0	I/O	12	M_A_DQS0	I/O
13	GND	---	14	GND	---
15	M_A_DQ3	I/O	16	M_A_DQ1	I/O
17	M_A_DQ6	I/O	18	M_A_DQ2	I/O
19	GND	---	20	GND	---
21	M_A_DQ10	I/O	22	M_A_DQ15	I/O
23	M_A_DQ8	I/O	24	M_A_DQ13	I/O
25	GND	---	26	GND	---
27	M_A_DQS#1	I/O	28	M_A_DM1	I/O
29	M_A_DQS1	I/O	30	DDR3_DRAMRS T#	I
31	GND	---	32	GND	---
33	M_A_DQ9	I/O	34	M_A_DQ14	I/O
35	M_A_DQ10	I/O	36	M_A_DQ11	I/O



## Pin Assignment

37	GND	---	38	GND	---
39	M_A_DQ23	I/O	40	M_A_DQ17	I/O
41	M_A_DQ18	I/O	42	M_A_DQ21	I/O
43	GND	---	44	GND	---
45	M_A_DQS#2	I/O	46	M_A_DM2	I/O
47	M_A_DQS2	I/O	48	GND	---
49	GND	---	50	M_A_DQ20	I/O
51	M_A_DQ22	I/O	52	M_A_DQ19	I/O
53	M_A_DQ16	I/O	54	GND	---
55	GND	---	56	M_A_DQ26	I/O
57	M_A_DQ24	I/O	58	M_A_DQ29	I/O
59	M_A_DQ31	I/O	60	GND	---
61	GND	---	62	M_A_DQS#3	I/O
63	M_A_DM3	I/O	64	M_A_DQS3	I/O
65	GND	---	66	GND	---
67	M_A_DQ28	I/O	68	M_A_DQ27	I/O
69	M_A_DQ25	I/O	70	M_A_DQ30	I/O
71	GND	---	72	GND	---
73	M_CKE2	I/O	74	M_CKE3	I/O
75	+1.5VSUS	---	76	+1.5VSUS	---
77	NC	---	78	NC	---
79	M_A_BS#2	I	80	M_A_A14	I
81	+1.5VSUS	---	82	+1.5VSUS	---
83	M_A_A12	I	84	M_A_A11	I
85	M_A_A9	I	86	M_A_A7	---

## Pin Assignment

87	+1.5VSUS	---	88	+1.5VSUS	---
89	M_A_A8	I/O	90	M_A_A6	I/O
91	M_A_A5	I/O	92	M_A_A4	I/O
93	+1.5VSUS	---	94	+1.5VSUS	---
95	M_A_A3	I/O	96	M_A_A2	I/O
97	M_A_A1	I/O	98	M_A_A0	I/O
99	+1.5VSUS	---	100	+1.5VSUS	---
101	M_CLK_DDR0	I/O	102	M_CLK_DDR1	I/O
103	M_CLK_DDR#0	I/O	104	M_CLK_DDR#1	I/O
105	+1.5VSUS	---	106	+1.5VSUS	----
107	M_A_A13	I	108	M_A_BS#1	I
109	M_A_BS#0	I	110	M_A_RAS#	I
111	+1.5VSUS	---	112	+1.5VSUS	---
113	M_A_WE#	I	114	M_CS#0	I
115	M_A_CAS#	I	116	M_ODT0	I/O
117	+1.5VSUS	---	118	+1.5VSUS	---
119	M_A_A13	I	120	M_ODT1	---
121	M_CS#1	---	122	NC	---
123	+1.5VSUS	---	124	+1.5VSUS	---
125	NC	---	126	SMDDR_VREF_ DIMM	---
127	GND	---	128	GND	---
129	M_A_DQ32	I/O	130	M_A_DQ34	I
131	M_A_DQ37	I/O	132	M_A_DQ39	I/O
133	GND	---	134	GND	---
135	M_A_DQS#4	I/O	136	M_A_DM4	I/O

## Pin Assignment

137	M_A_DQS4	I/O	138	GND	---
139	GND	---	140	M_A_DQ33	I/O
141	M_A_DQ36	I/O	142	M_A_DQ38	I/O
143	M_A_DQ35	I/O	144	GND	---
145	GND	---	146	M_A_DQ47	I/O
147	M_A_DQ41	I/O	148	M_A_DQ45	I/O
149	M_A_DQ40	I/O	150	GND	---
151	GND	I/O	152	M_A_DQS#5	I/O
153	M_A_DM5	I/O	154	M_A_DQS5	I/O
155	GND	---	156	GND	---
157	M_A_DQ42	I/O	158	M_A_DQ44	I/O
159	M_A_DQ43	I/O	160	M_A_DQ46	I/O
161	GND	---	162	GND	---
163	M_A_DQ49	I/O	164	M_A_DQ50	I/O
165	M_A_DQ55	I/O	166	M_A_DQ53	I/O
167	GND	---	168	GND	---
169	M_A_DQS#6	I/O	170	M_A_DM6	I
171	M_A_DQS6	---	172	GND	---
173	GND	---	174	M_A_DQ48	I/O
175	M_A_DQ51	I/O	176	M_A_DQ55	I/O
177	M_A_DQ54	I/O	178	GND	---
179	GND	---	180	M_A_DQ57	I/O
181	M_A_DQ63	I/O	182	M_A_DQ60	I/O
183	M_A_DQ56	I/O	184	GND	---
185	GND	---	186	M_A_DQS#7	I/O

## Pin Assignment

187	M_A_DM7	I/O	188	M_A_DQS7	I/O
189	GND	---	190	GND	---
191	M_A_DQ59	I/O	192	M_A_DQ62	I/O
193	M_A_DQ61	I/O	194	M_A_DQ58	I/O
195	GND	---	196	GND	---
197	SA0	I/O	198	PM_EXTTS#0	--
199	+3V	---	200	CGDAT_SMB	I/O
201	SA0	---	202	CGCLK_SMB	I/O
203	+SMDDR_VTERM	I/O	204	+SMDDR_VTER M	I/O

### C.17 CN21 3G Connectors

PIN No.	Signal name	I/O	PIN No.	Signal name	I/O
1	3G_WAKE#	O	2	+3V	---
3	NC	---	4	GND	---
5	NC	---	6	+1.5V_3G	---
7	NC	---	8	UIM_PWR	I/O
9	GND	---	10	UIM_DATA	I/O
11	CLK_PCIE_3G#	I	12	UIM_CLK	I/O
13	CLK_PCIE_3G	I	14	UIM_RST	I/O
15	GND	---	16	UIM_VPP	I
17	NC	---	18	GND	---
19	NC	---	20	3G_EN	I
21	GND	---	22	PLTRST#	I
23	PCIE_RXN3	O	24	+3V_3G	---
25	PCIE_RXP3	O	26	GND	---

## Pin Assignment

---

27	GND	---	28	+1.5V_3G	---
29	GND	---	30	NC	I/O
31	PCIE_TXN3	I	32	NC	I/O
33	PCIE_TXP3	I	34	GND	---
35	GND	---	36	USBP6-	I/O
37	NC	---	38	USBP6+	I/O
39	+3V_3G	---	40	CPUSB#	---
41	+3V_3G	---	42	3G_LED#	---
43	GND	---	44	NC	---
45	NC	---	46	NC	---
47	NC	---	48	+1.5V_3G	---
49	NC	---	50	GND	---
51	NC	O	52	+3V_3G	---

### C.18 CN22 WLAN Connectors

PIN No.	Signal name	I/O	PIN No.	Signal name	I/O
1	WLAN_WAKE#	O	2	+3V	---
3	WCS_DAT	---	4	GND	---
5	WCS_CLK	---	6	+1.5V	---
7	NC	---	8	LAD0_PCIE	I/O
9	GND	---	10	LAD1_PCIE	I/O
11	CLK_PCIE_MINI1#	I	12	LAD2_PCIE	I/O
13	CLK_PCIE_MINI1	I	14	LAD3_PCIE	I/O
15	GND	---	16	LFRAME#_PCIE	I
17	NC	---	18	GND	---

## Pin Assignment

---

19	NC	---	20	RF_EN	I
21	GND	---	22	PLTRST#	I
23	PCIE_RXN6	O	24	+3V_S5	---
25	PCIE_RXP6	O	26	GND	---
27	GND	---	28	+1.5V	---
29	GND	---	30	WL_SMCLK	I/O
31	PCIE_TXN6	I	32	WL_SMDATA	I/O
33	PCIE_TXP6	I	34	GND	---
35	GND	---	36	USBP10-	I/O
37	GND	---	38	USBP10+	I/O
39	WIMAX_P	---	40	GND	---
41	WIMAX_P	---	42	WIMAX_LED#	---
43	GND	---	44	NC	---
45	CL_CLK1_WLAN	---	46	NC	---
47	PLTRST#_PCIE	---	48	+1.5V	---
49	CL_RST#1_WLAN	---	50	GND	---
51	NC	O	52	WIMAX_P	---

## Appendix D Display Codes

### D.1 Display Codes

Cap No.	Keytop	Code set 1		Code set 2			Note
		Make	Break	Make	Break		
01	' ~	29	A9	0E	F0	0E	
02	1 !	02	82	16	F0	16	
03	2 @	03	83	1E	F0	1E	
04	3 #	04	84	26	F0	26	
05	4 \$	05	85	25	F0	25	
06	5 %	06	86	2E	F0	2E	
07	6 ^	07	87	36	F0	36	
08	7 &	08	88	3D	F0	3D	*2
09	8 *	09	89	3E	F0	3E	*2
10	9 (	0A	8A	46	F0	46	*2
11	0 )	0B	8B	45	F0	45	
12	- _	0C	8C	4E	F0	4E	
13	= +	0D	8D	55	F0	55	
15	BkSp	0E	8E	66	F0	66	
16	Tab	0F	8F	0D	F0	0D	
17	Q	10	90	15	F0	15	
18	W	11	91	1D	F0	1D	
19	E	12	92	24	F0	24	
20	R	13	93	2D	F0	2D	
21	T	14	94	2C	F0	2C	
22	Y	15	95	35	F0	35	
23	U	16	96	3C	F0	3C	*2
24	I	17	97	43	F0	43	*2
25	O	13	98	44	F0	44	*2
26	P	19	99	4D	F0	4D	*2
27	[ {	1A	9A	54	F0	54	
28	] }	1B	9B	5B	F0	5B	

Table D-1-1 Scan codes (set 1 and set 2) (1/4)

## Display Codes

Cap No.	Keytop	Code set 1		Code set 2		Note
		Make	Break	Make	Break	
29	\	2B	AB	5D	F0 5D	*5
30	Caps Lock	3A	BA	58	F0 58	
31	A	1E	9E	1C	F0 1C	
32	S	1F	9F	1B	F0 1B	
33	D	20	A0	23	F0 23	
34	F	21	A1	2B	F0 2B	
35	G	22	A2	34	F0 34	
36	H	23	A3	33	F0 33	
37	J	24	A4	3B	F0 3B	*2
38	K	25	A5	42	F0 42	*2
39	L	26	A6	4B	F0 4B	*2
40	; :	27	A7	4C	F0 4C	*2
41	' "	28	A8	52	F0 52	
43	Enter	1C	9C	5A	F0 5A	*3
44	Shift (L)	2A	AA	12	F0 12	
45	No.102 key	56	D6	61	F0 61	
46	Z	2C	AC	1A	F0 1A	
47	X	2D	AD	22	F0 22	
48	C	2E	AE	21	F0 21	
49	V	2F	AF	2A	F0 2A	
50	B	30	B0	32	F0 32	
51	N	31	B1	31	F0 31	
52	M	32	B2	3A	F0 3A	*2
53	, <	33	B3	41	F0 41	*2
54	. >	34	B4	49	F0 49	*2
55	/ ?	35	B5	4A	F0 4A	*2
57	Shift (R)	36	B6	59	F0 59	

Table D-1-1 Scan codes (set 1 and set 2) (2/4)



*Display Codes*

Cap No.	Keytop	Code set 1				Code set 2				Note
		Make		Break		Make		Break		
58	Ctrl	1D		9D		14		F0 14		*3
60	Alt (L)	38		B8		11		F0 11		*3
61	Space	39		B9		29		F0 29		
62	ALT (R)	E0	38	E0	B8	E0	11	E0	F0 11	
75	Ins	E0	52	E0	D2	E0	70	E0	F0 70	*1
76	Del	E0	53	E0	D3	E0	71	E0	F0 71	*1
79	←	E0	4B	E0	CB	E0	6B	E0	F0 6B	*1
80	Home	E0	47	E0	C7	E0	6C	E0	F0 6C	*1
81	End	E0	4F	E0	CF	E0	69	E0	F0 69	*1
83	↑	E0	48	E0	C8	E0	75	E0	F0 75	*1
84	↓	E0	50	E0	D0	E0	72	E0	F0 72	*1
85	PgUp	E0	49	E0	C9	E0	7D	E0	F0 7D	*1
86	PgDn	E0	51	E0	D1	E0	7A	E0	F0 7A	*1
89	→	E0	4D	E0	CD	E0	74	E0	F0 74	*1
110	Esc	01		81		76		F0 76		
112	F1	3B		BB		05		F0 05		
113	F2	3C		BC		06		F0 06		
114	F3	3D		BD		04		F0 04		
115	F4	3E		BE		0C		F0 0C		
116	F5	3F		BF		03		F0 03		
117	F6	40		C0		0B		F0 0B		
118	F7	41		C1		83		F0 83		
119	F8	42		C2		0A		F0 0A		
120	F9	43		C3		01		F0 01		
121	F10	44		C4		09		F0 09		*3

*Table D-1-1 Scan codes (set 1 and set 2) (3/4)*

Cap No.	Keytop	Code set 1		Code set 2			Note
		Make	Break	Make	Break		
122	F11	57	D7	78	F0	78	*3
123	F12	58	D8	07	F0	07	*3
124	PrintSc	*6	*6	*6	*6		*6
126	Pause	*7	*7	*7	*7		*7
202	Fn	—	—	—	—		*4
203	Win	E0 5B	E0 DB	E0 1F	E0 F0	1F	
204	App	E0 5D	E0 DD	E0 2F	E0 F0	2F	

*Table D-1-1 Scan codes (set 1 and set 2) (4/4)*

**Notes:**

1. \* Scan codes differ by mode.
2. \* Scan codes differ by overlay function.
3. \* Combined with the **Fn** key makes different codes.
4. \* **Fn** key does not generate a code by itself.
5. \* This key corresponds to key No. 42 in a 102-key model.
6. \* Refer to Table D-6, No. 124 key scan code.
7. \* Refer to Table D-7, No. 126 key scan code.

## Display Codes

Cap No.	Key top	Code set 1				Code set 2			
		Make		Break		Make		Break	
55	/	E0 AA E0 35	E0 B5 E0 2A	E0 F0 12 E0 4A	E0 F0 4A E0 12				
75	INS	E0 AA E0 52	E0 D2 E0 2A	E0 F0 12 E0 70	E0 F0 70 E0 12				
76	DEL	E0 AA E0 53	E0 D3 E0 2A	E0 F0 12 E0 71	E0 F0 71 E0 12				
79	←	E0 AA E0 4B	E0 CB E0 2A	E0 F0 12 E0 6B	E0 F0 6B E0 12				
80	Home	E0 AA E0 47	E0 C7 E0 2A	E0 F0 12 E0 6C	E0 F0 6C E0 12				
81	End	E0 AA E0 4F	E0 CF E0 2A	E0 F0 12 E0 69	E0 F0 69 E0 12				
83	↑	E0 AA E0 48	E0 C8 E0 2A	E0 F0 12 E0 75	E0 F0 75 E0 12				
84	↓	E0 AA E0 50	E0 D0 E0 2A	E0 F0 12 E0 72	E0 F0 72 E0 12				
85	PgUp	E0 AA E0 49	E0 C9 E0 2A	E0 F0 12 E0 7D	E0 F0 7D E0 12				
86	PgDn	E0 AA E0 51	E0 D1 E0 2A	E0 F0 12 E0 7A	E0 F0 7A E0 12				
89	→	E0 AA E0 4D	E0 CD E0 2A	E0 F0 12 E0 74	E0 F0 74 E0 12				
203	Win	E0 AA E0 5B	E0 DB E0 2A	E0 F0 12 E0 1F	E0 F0 1F E0 12				
204	App	E0 AA E0 5D	E0 DD E0 2A	E0 F0 12 E0 2F	E0 F0 2F E0 12				

Table D-1-2 Scan codes with left Shift key

**Note :** The table above shows scan codes with the left **Shift** key. In combination with the right **Shift** key, scan codes are changed as listed below:

	With left <b>Shift</b>	With right <b>Shift</b>
Set 1	E0 AA _____	E0 B6
	E0 2A _____	E0 36
Set 2	E0 F0 12 _____	E0 F0 59
	E0 12 _____	E0 59

## Display Codes

Cap No.	Key top	Code set 1				Code set 2			
		Make		Break		Make		Break	
75	INS	E0 2A E0 52	E0 D2 E0 AA	E0 12 E0 70	E0 F0 70 E0 F0 12				
76	DEL	E0 2A E0 53	E0 D3 E0 AA	E0 12 E0 71	E0 F0 71 E0 F0 12				
79	←	E0 2A E0 4B	E0 CB E0 AA	E0 12 E0 6B	E0 F0 6B E0 F0 12				
80	Home	E0 2A E0 47	E0 C7 E0 AA	E0 12 E0 6C	E0 F0 6C E0 F0 12				
81	End	E0 2A E0 4F	E0 CF E0 AA	E0 12 E0 69	E0 F0 69 E0 F0 12				
83	↑	E0 2A E0 48	E0 C8 E0 AA	E0 12 E0 75	E0 F0 75 E0 F0 12				
84	↓	E0 2A E0 50	E0 D0 E0 AA	E0 12 E0 72	E0 F0 72 E0 F0 12				
85	PgUp	E0 2A E0 49	E0 C9 E0 AA	E0 12 E0 7D	E0 F0 7D E0 F0 12				
86	PgDn	E0 2A E0 51	E0 D1 E0 AA	E0 12 E0 7A	E0 F0 7A E0 F0 12				
89	→	E0 2A E0 4D	E0 CD E0 AA	E0 12 E0 74	E0 F0 74 E0 F0 12				
203	Win	E0 2A E0 5B	E0 DB E0 AA	E0 12 E0 1F	E0 F0 1F E0 F0 12				
204	App	E0 2A E0 5D	E0 DD E0 AA	E0 12 E0 2F	E0 F0 2F E0 F0 12				

Table D-1-3 Scan codes in Numlock mode

Cap No.	Keytop	Code set 1		Code set 2	
		Make	Break	Make	Break
43	ENT	E0 1C	E0 9C	E0 5A	E0 F0 5A
58	CTRL	E0 1D	E0 9D	E0 14	E0 F0 14
60	LALT	E0 38	E0 B8	E0 11	E0 F0 11
121	ARROW	45	C5	77	F0 77
122	NUMERIC	45	C5	77	F0 77
123	Scrl	46	C5	7E	F0 7E

Table D-1-4 Scan codes with Fn key

## Display Codes

Cap No.	Keytop		Code set 1		Code set 2		
			Make	Break	Make	Break	
09	8	(8)	48	C8	75	F0	75
10	9	(9)	49	C9	7D	F0	7D
11	0	(*)	37	B7	7C	F0	7C
23	U	(4)	4B	CB	6B	F0	6B
24	I	(5)	4C	CC	73	F0	73
25	O	(6)	4D	CD	74	F0	74
26	P	(-)	4A	CA	7B	F0	7B
37	J	(1)	4F	CF	69	F0	69
38	K	(2)	50	D0	72	F0	72
39	L	(3)	51	D1	7A	F0	7A
40	;	(+)	4E	CE	79	F0	79
52	M	(0)	52	D2	70	F0	70
54	.	(.)	53	D3	71	F0	71
55	/	(/)	E0 35	E0 B5	40 4A	E0 F0	4A

Table D-1-5 Scan codes in overlay mode

Key top	Shift	Code set 1				Code set 2			
		Make		Break		Make		Break	
Prt Sc	Common	E0 2A	E0 37	E0 B7	E0 AA	E0 12	E0 7C	E0 F0	7C E0 F0 12
	Ctrl +	E0 37		E0 B7		E0 7C		E0 F0	7C
	Shift +	E0 37		E0 B7		E0 7C		E0 F0	7C
	Alt +		54	D4		84		F0 B4	

Table D-1-6 No.124 key scan code

## Display Codes

---

Key top	Shift	Code set 1						Code set 2							
		Make						Make							
Pause	Common*	E1	1D	45	E1	9D	C5	E1	14	77	E1	F0	14	F0	77
	Ctrl*	E0	46	E0	C6			E0	7E	E0	F0	7E			

*Table D-1-7 No.126 key scan code*

\*: *This key generates only make codes.*

# Appendix E Keyboard Layout

## E.1 United States (US) Keyboard

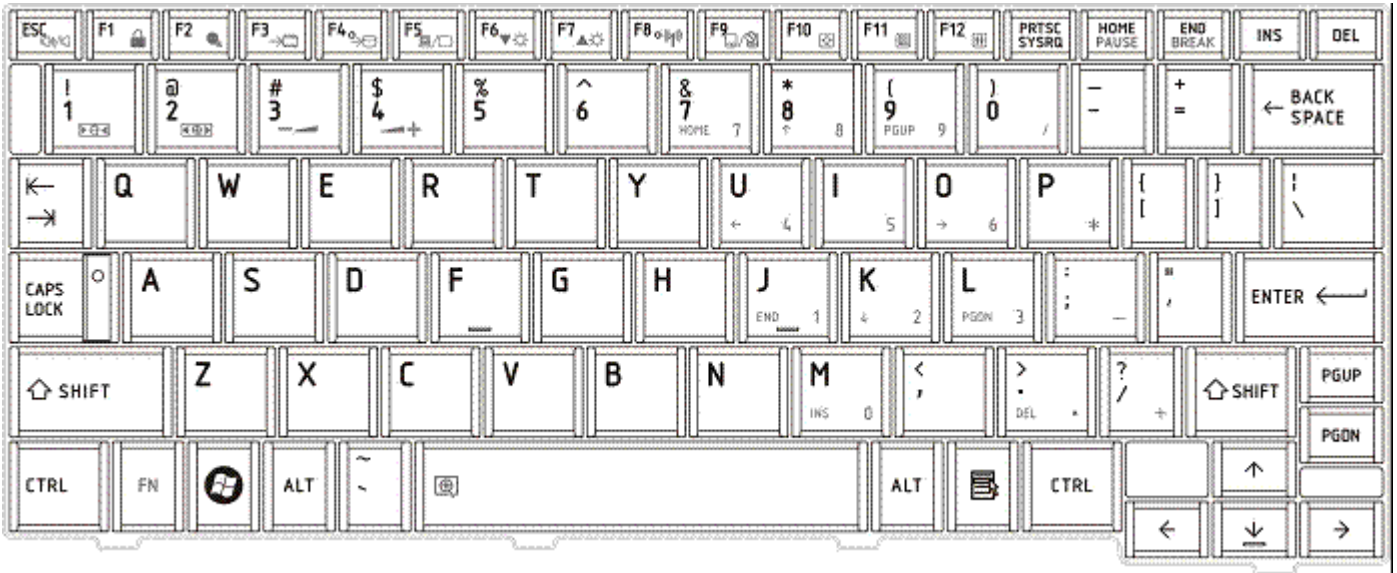

Figure US keyboard

## E.2 Thai (TI) Keyboard

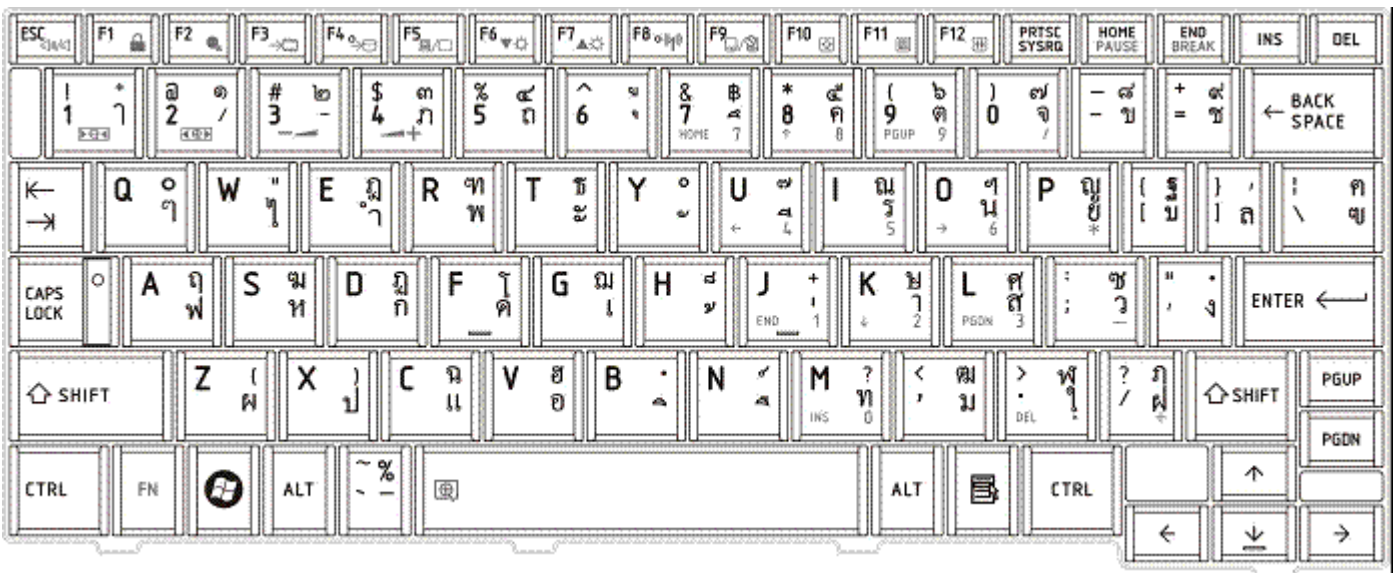

Figure TI keyboard

### E.3 Korean (KO) Keyboard

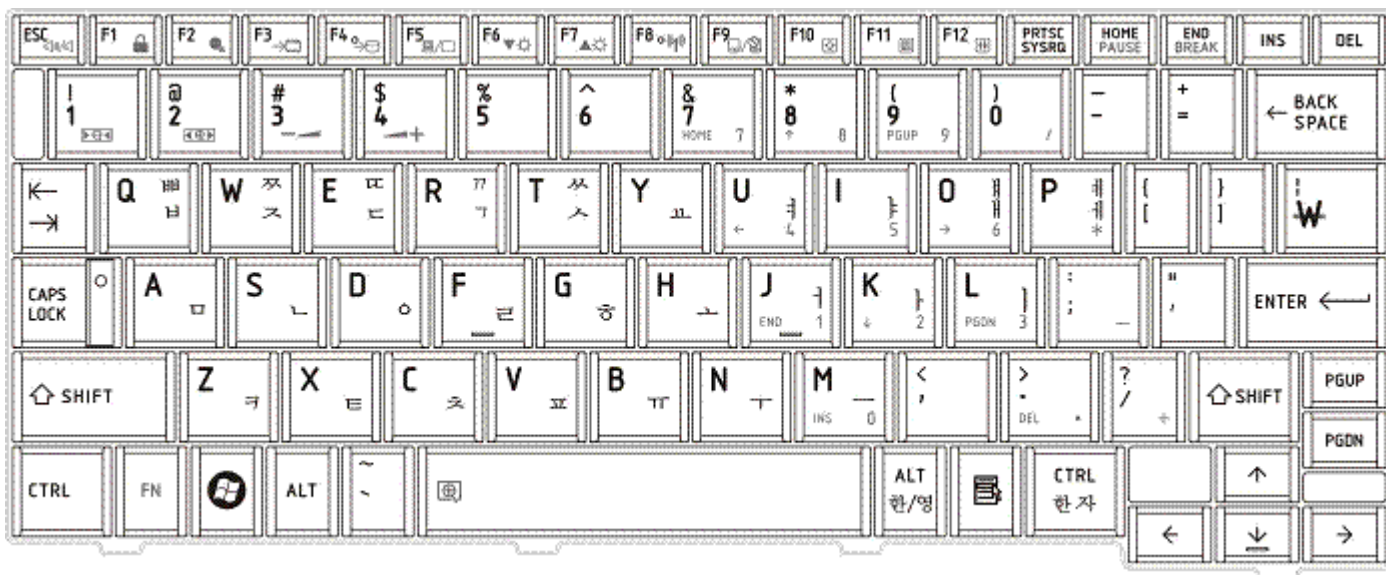

Figure KO keyboard

### E.4 United Kingdom (UK) Keyboard

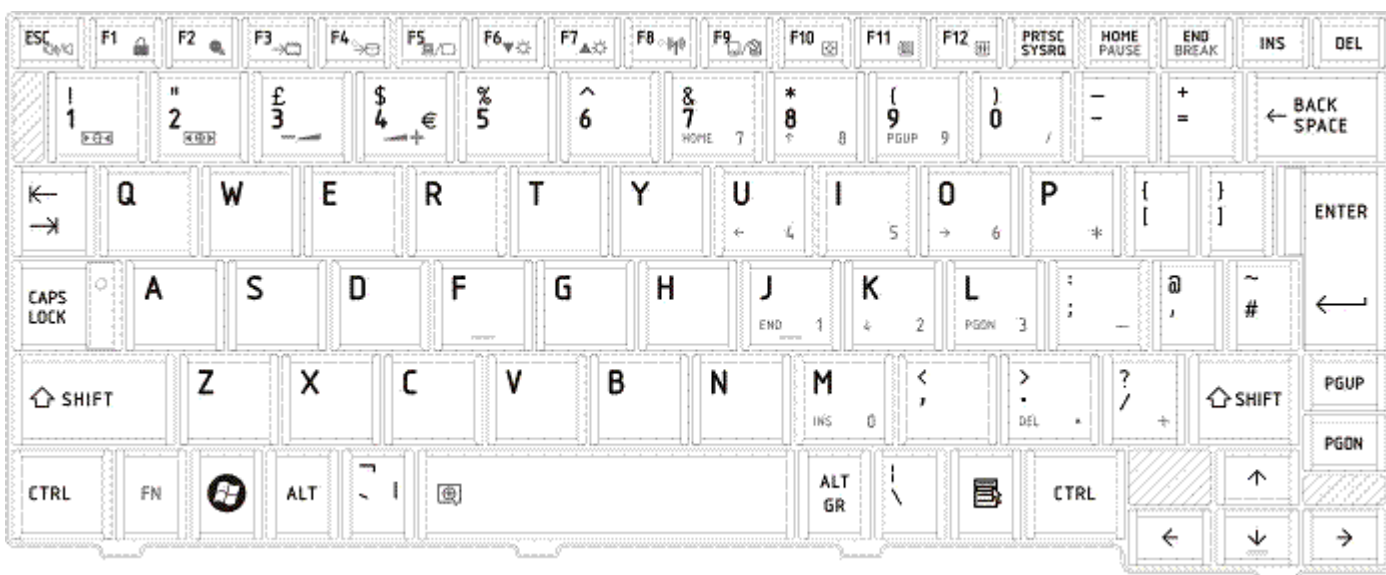

Figure UK keyboard



## E.5 US International (UI) Keyboard

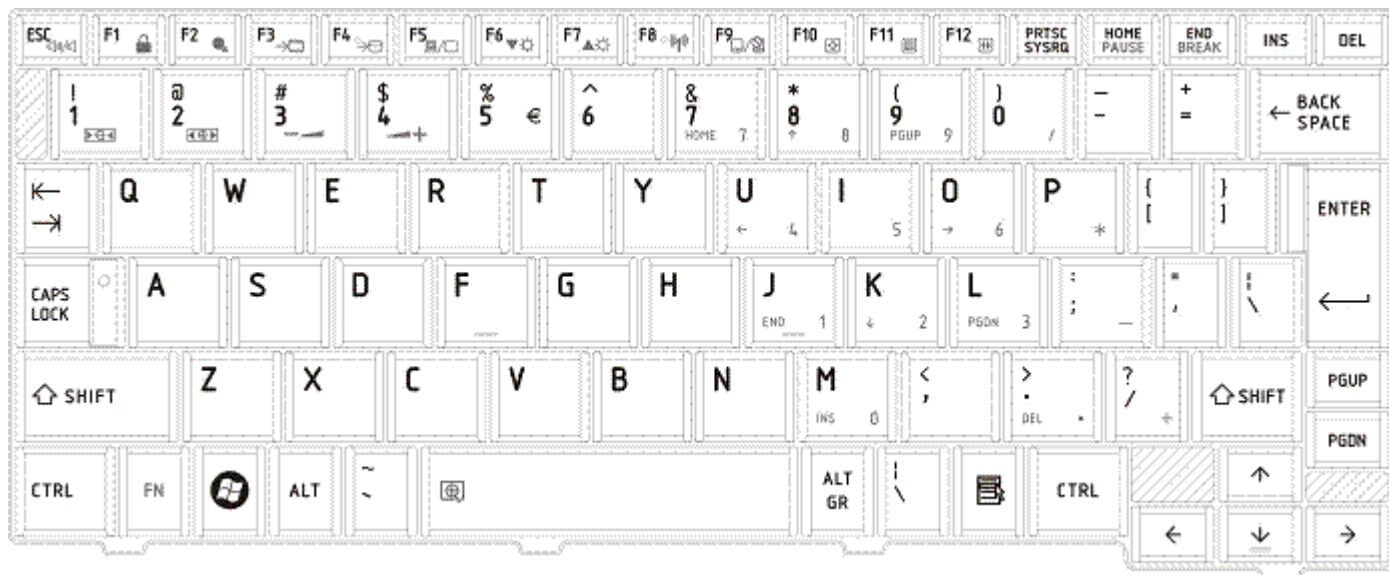

Figure UI keyboard

## E.6 Hebrew (HB) Keyboard

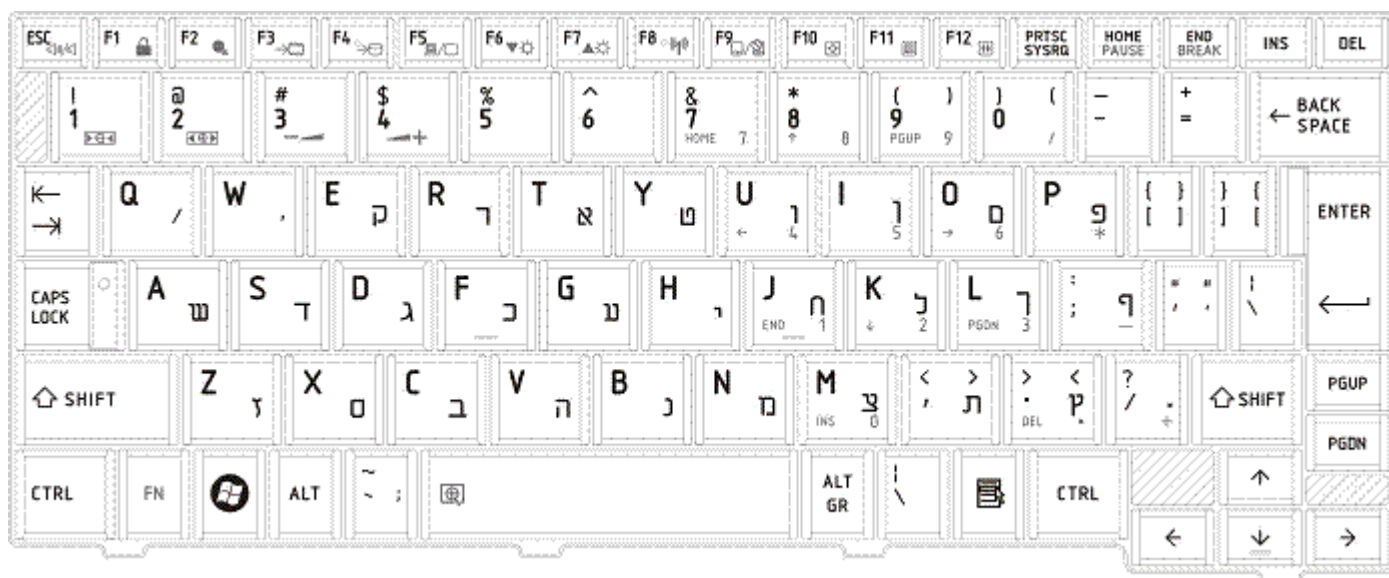

Figure HB keyboard

## E.7 Danish (DM) Keyboard

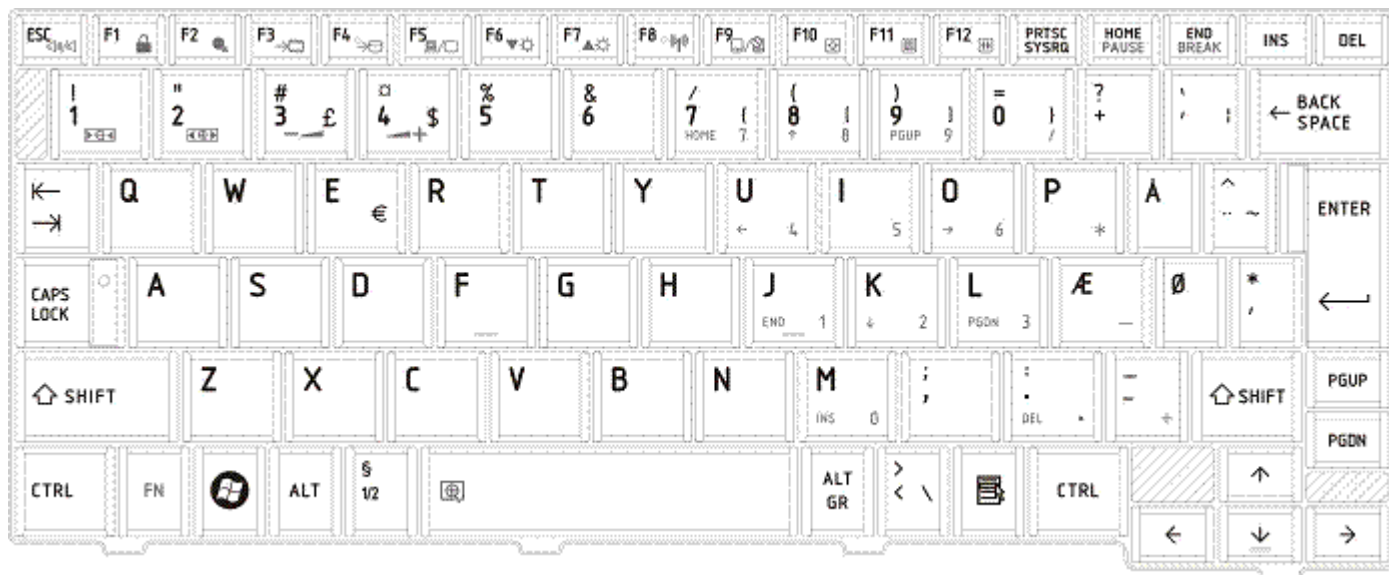

Figure DM keyboard

## E.8 Swiss (SW) Keyboard

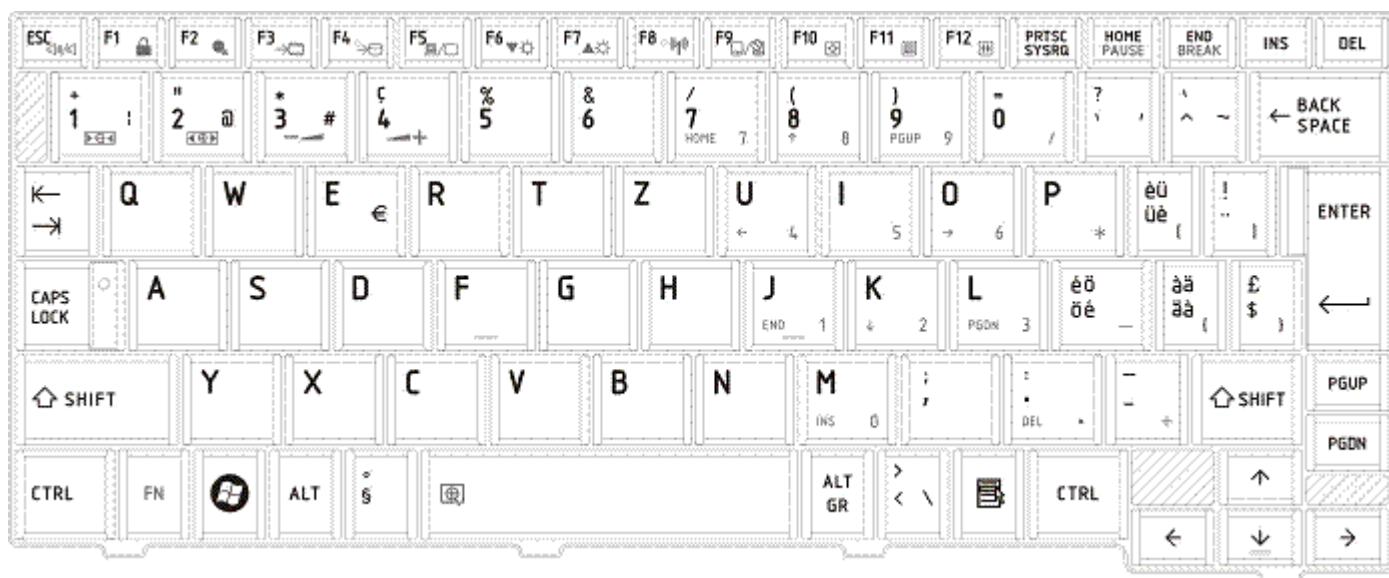

Figure SW keyboard

## E.9 Arabic (ARE) Keyboard

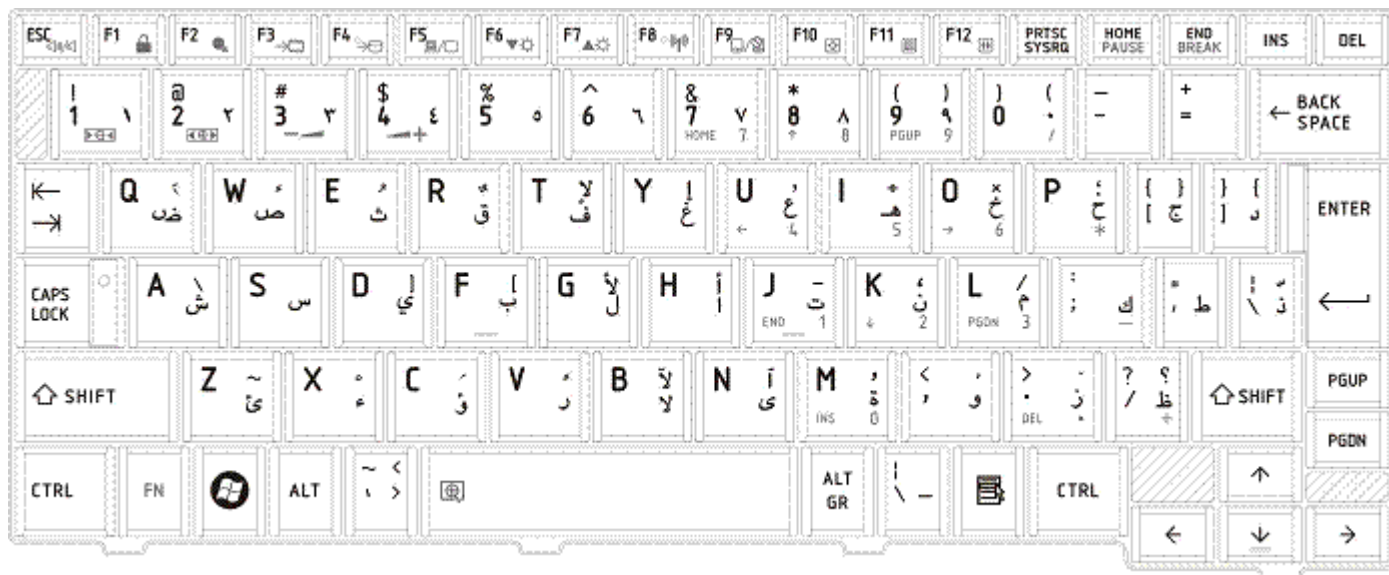

Figure ARE keyboard

## E.10 Czech (CZ) Keyboard

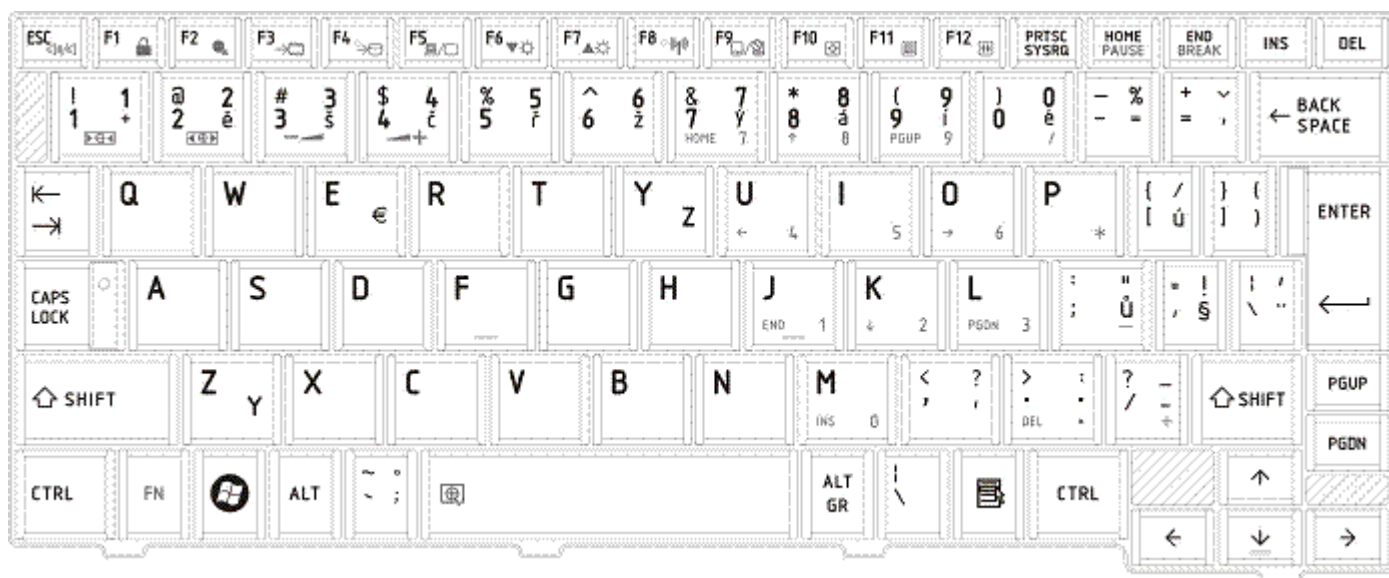

Figure CZ keyboard

## E.11 Russian (RU) Keyboard

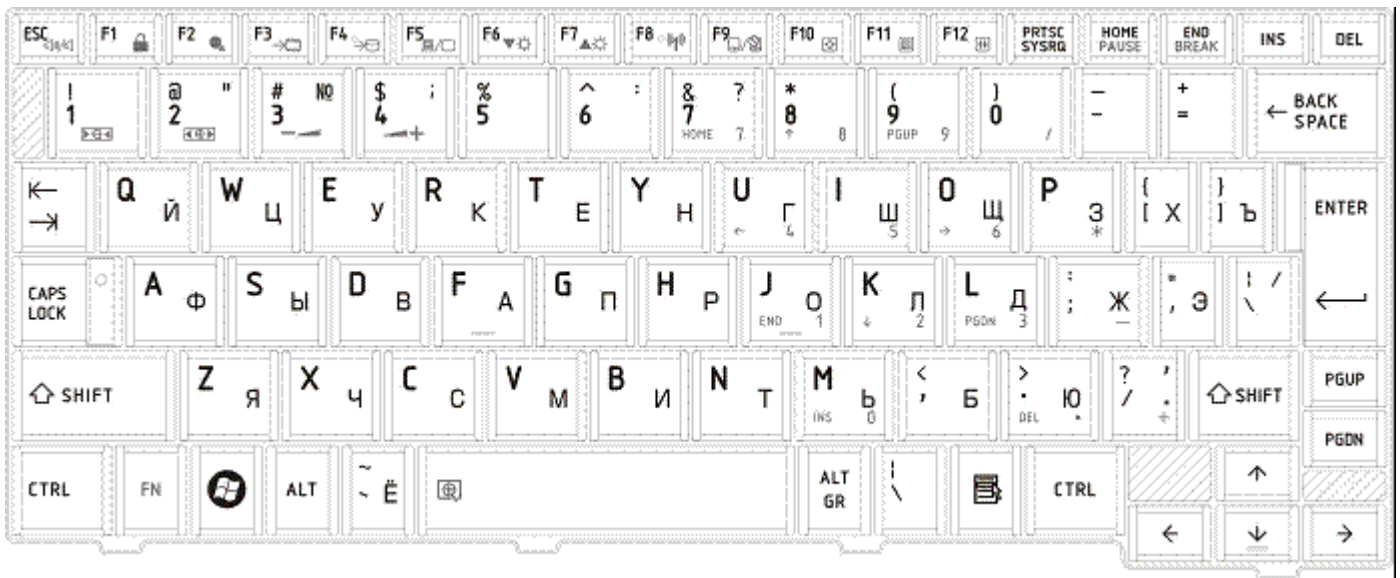

Figure RU keyboard

## E.12 Portuguese (PO) Keyboard

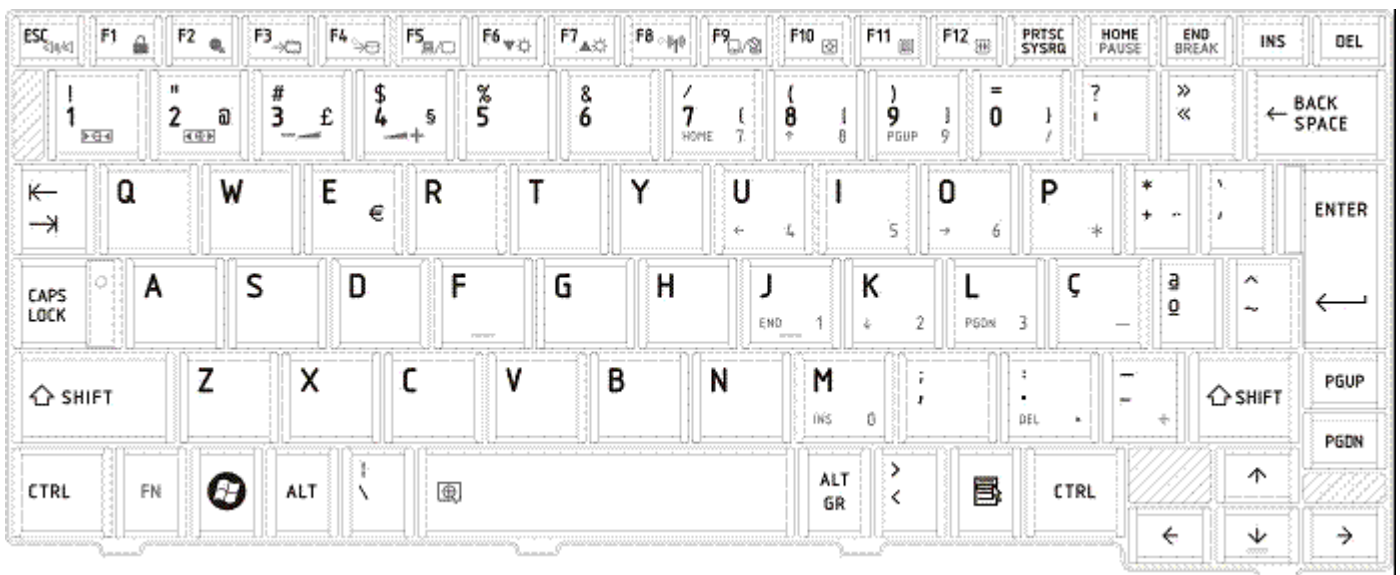

Figure PO keyboard

## E.13 Slovakian (SL) Keyboard

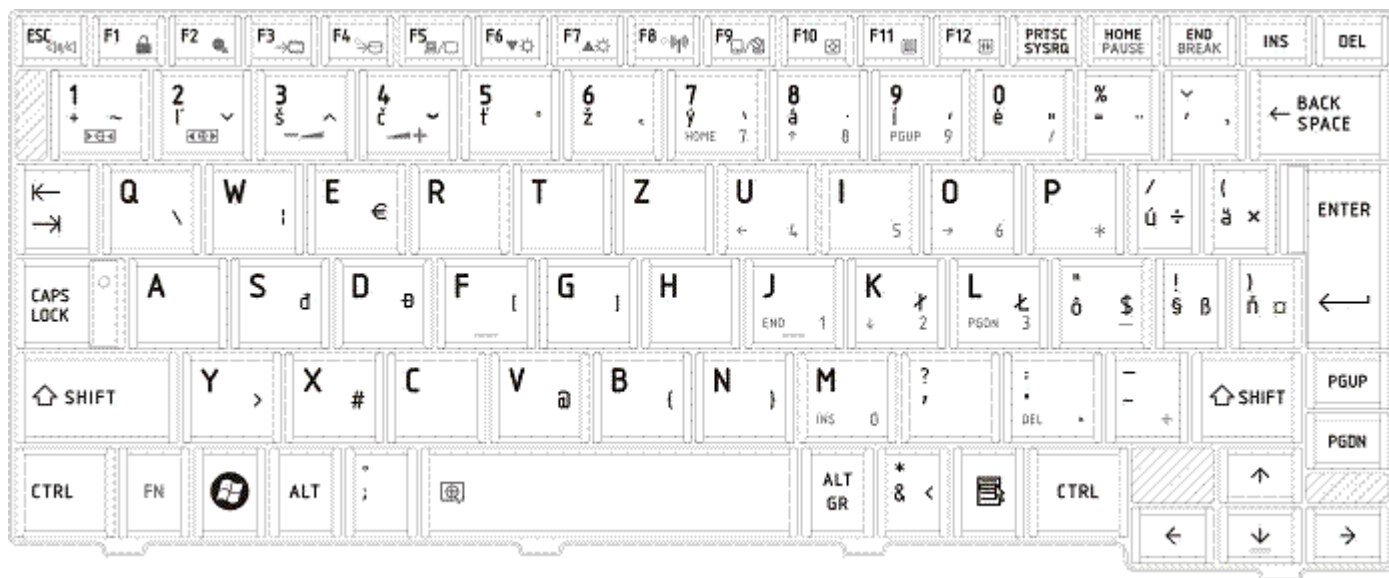

Figure SL keyboard

## E.14 Italian (IT) Keyboard

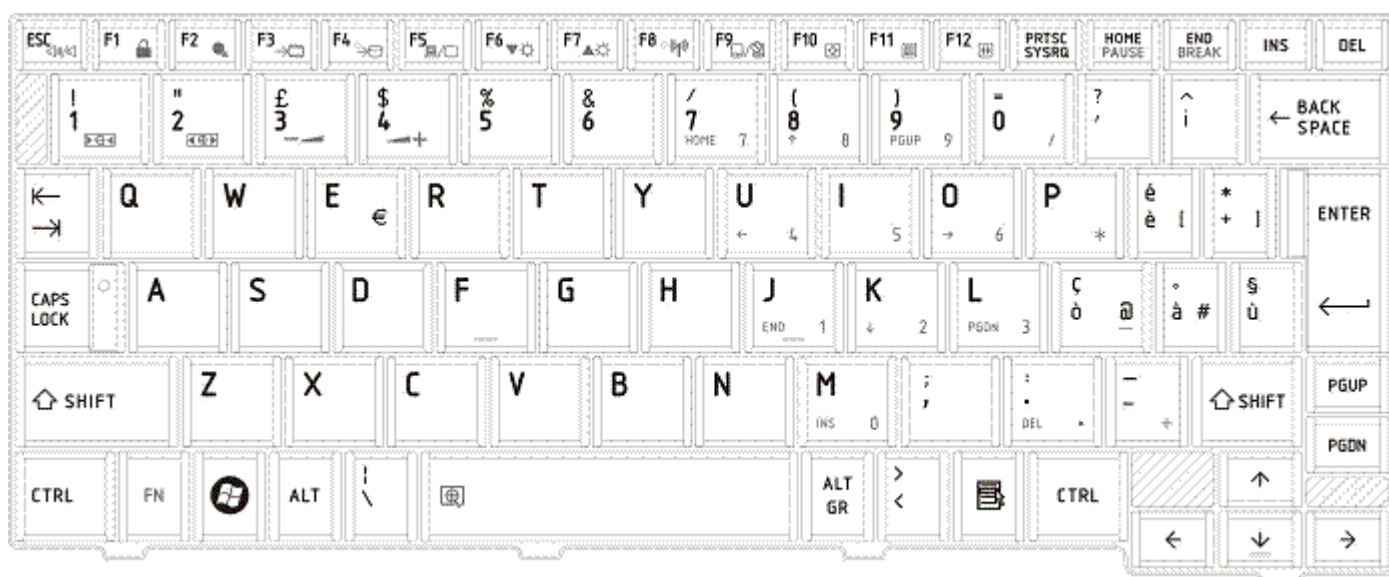

Figure IT keyboard

## E.15 French (FR) Keyboard

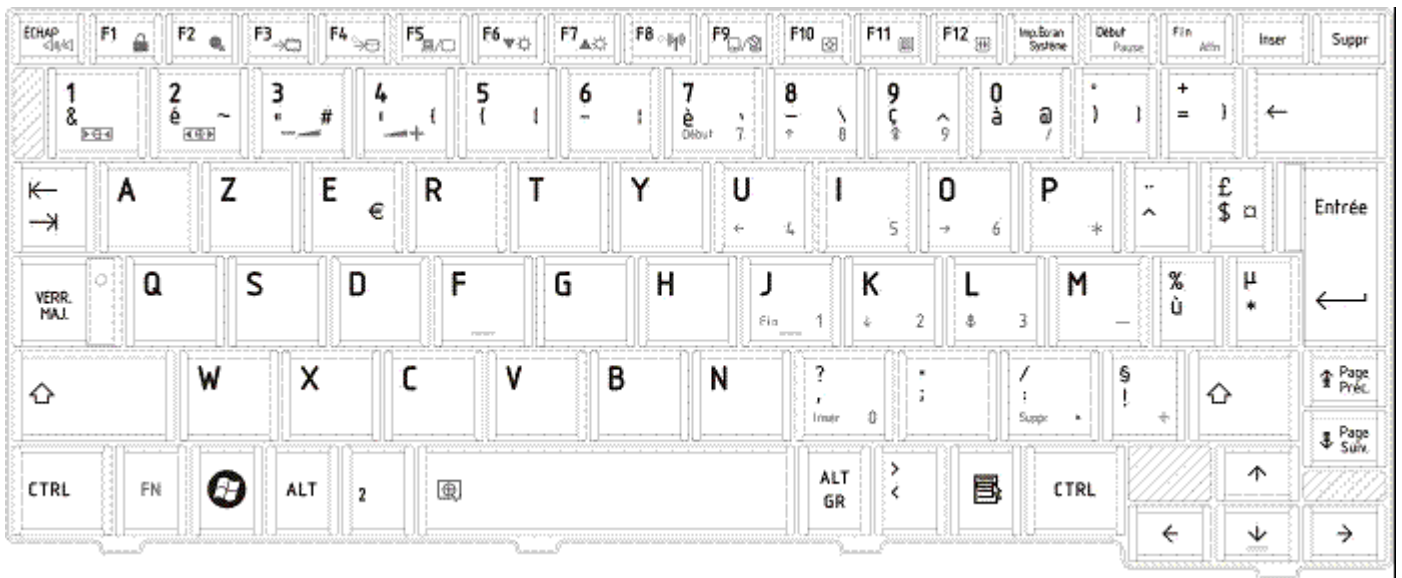

Figure FR keyboard

## E.16 German (GR) Keyboard

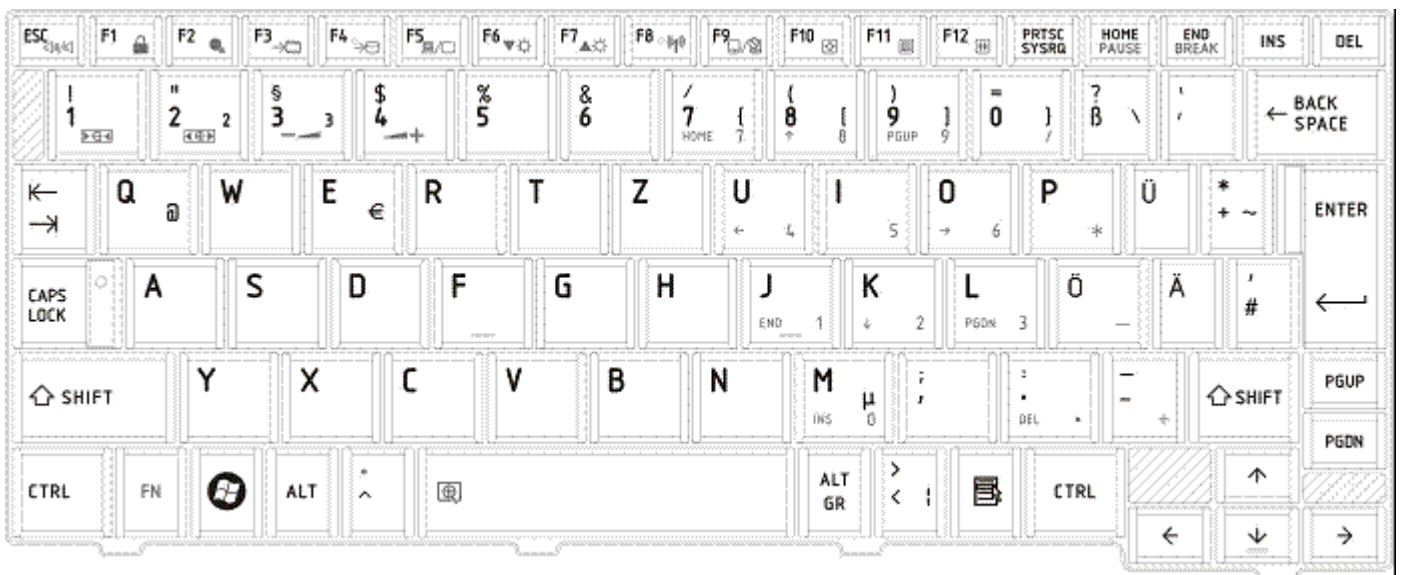

Figure GR keyboard

## E.17 Greek (GK) Keyboard

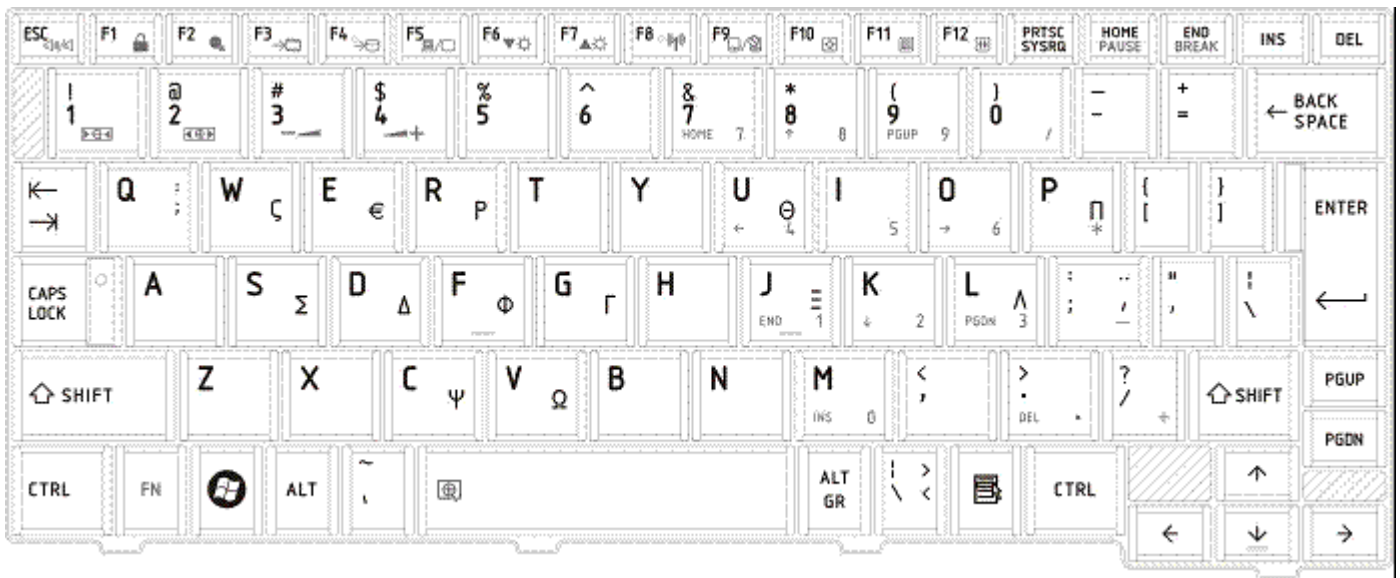

Figure GK keyboard

## E.18 French\_Canadian (Bilingual) Keyboard

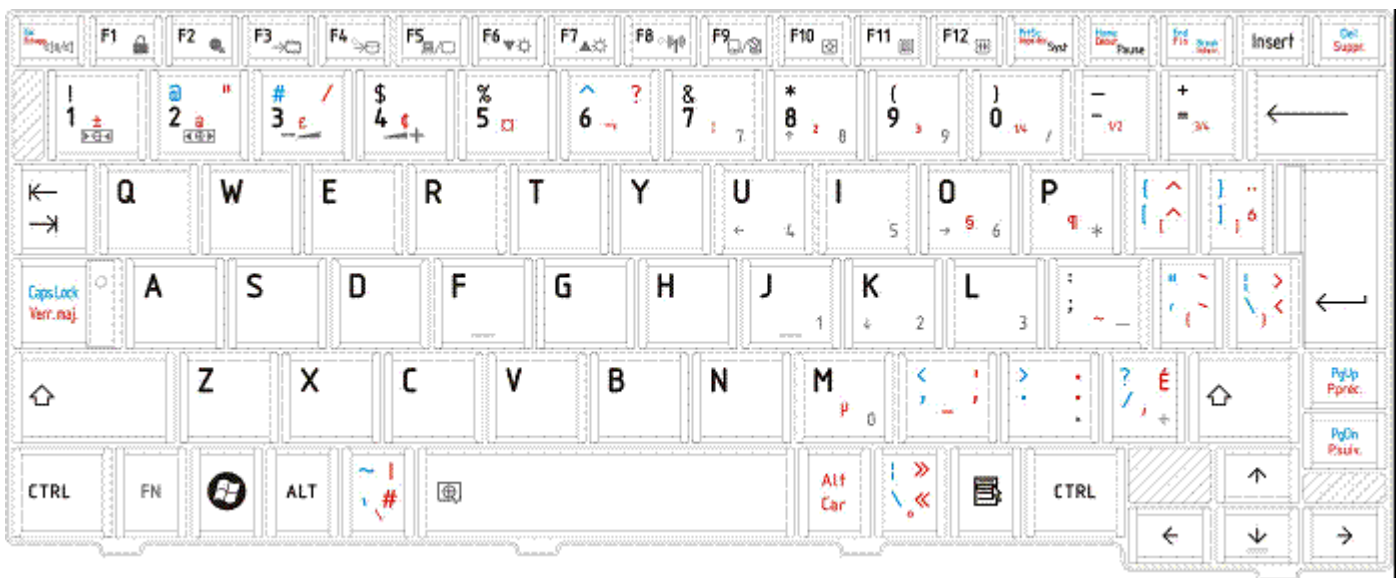

Figure CF(BI) keyboard

## E.19 Hungarian (HG) Keyboard

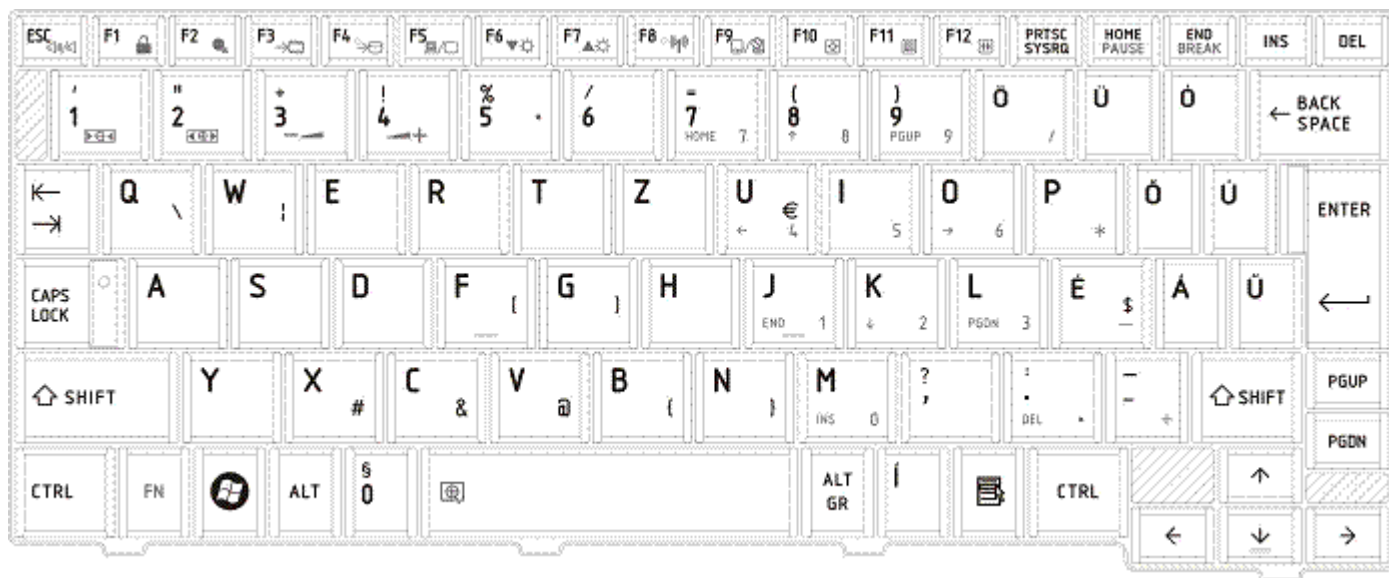

Figure HG keyboard

## E.20 Spanish (SP) Keyboard

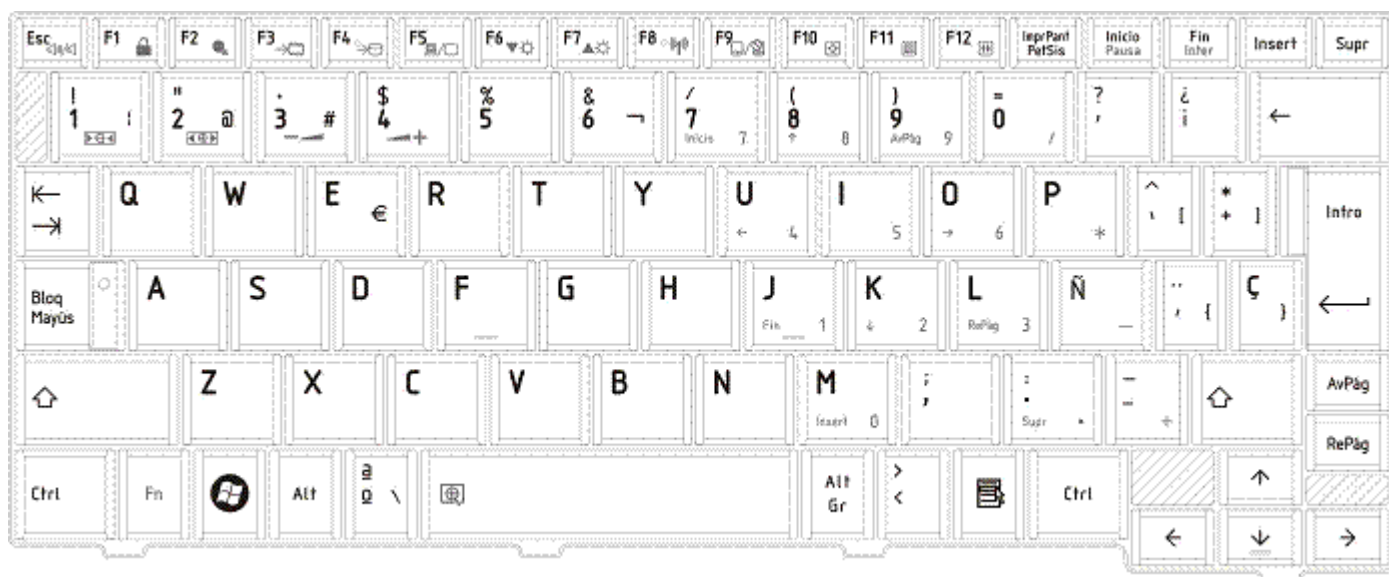

Figure SP keyboard



## E.21 Turkish (TR) Keyboard

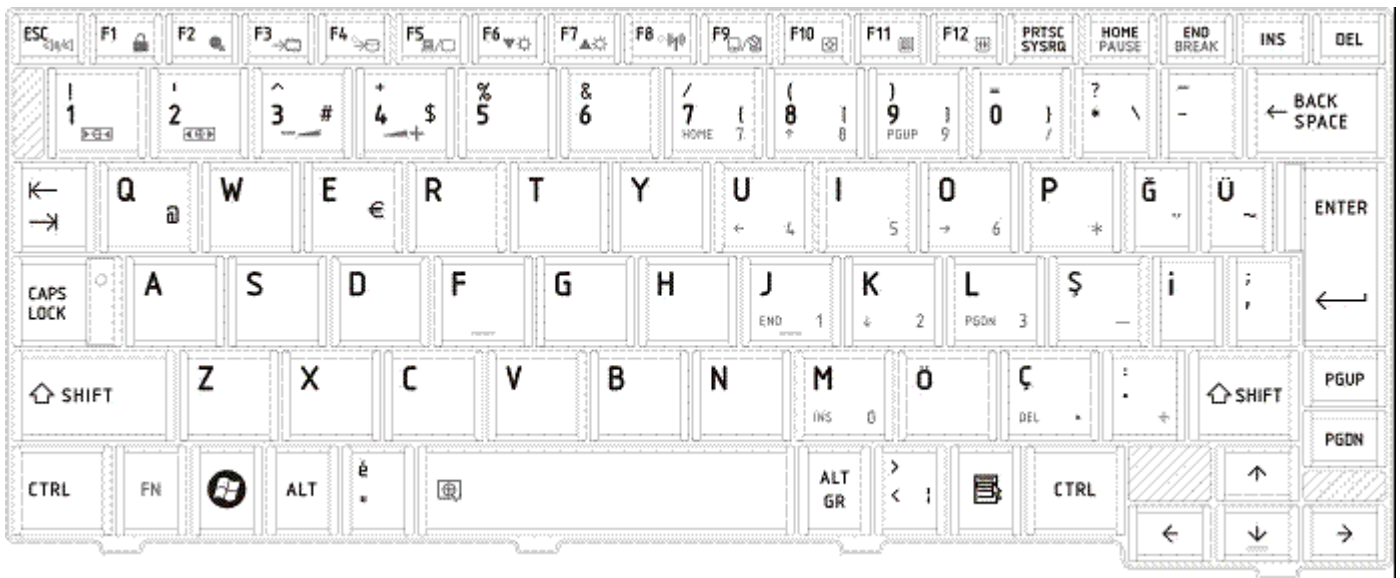

Figure TR keyboard

## E.22 Turkish F (TF-F) Keyboard

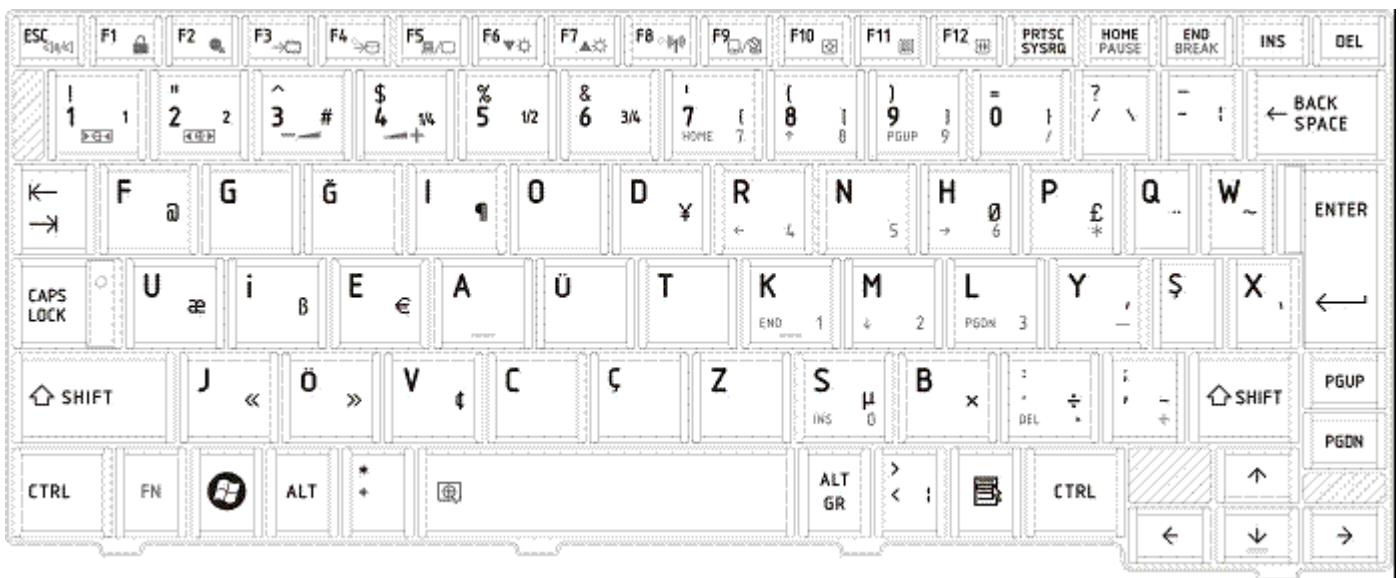

Figure TF-F keyboard

## E.23 Swedish (SD) Keyboard

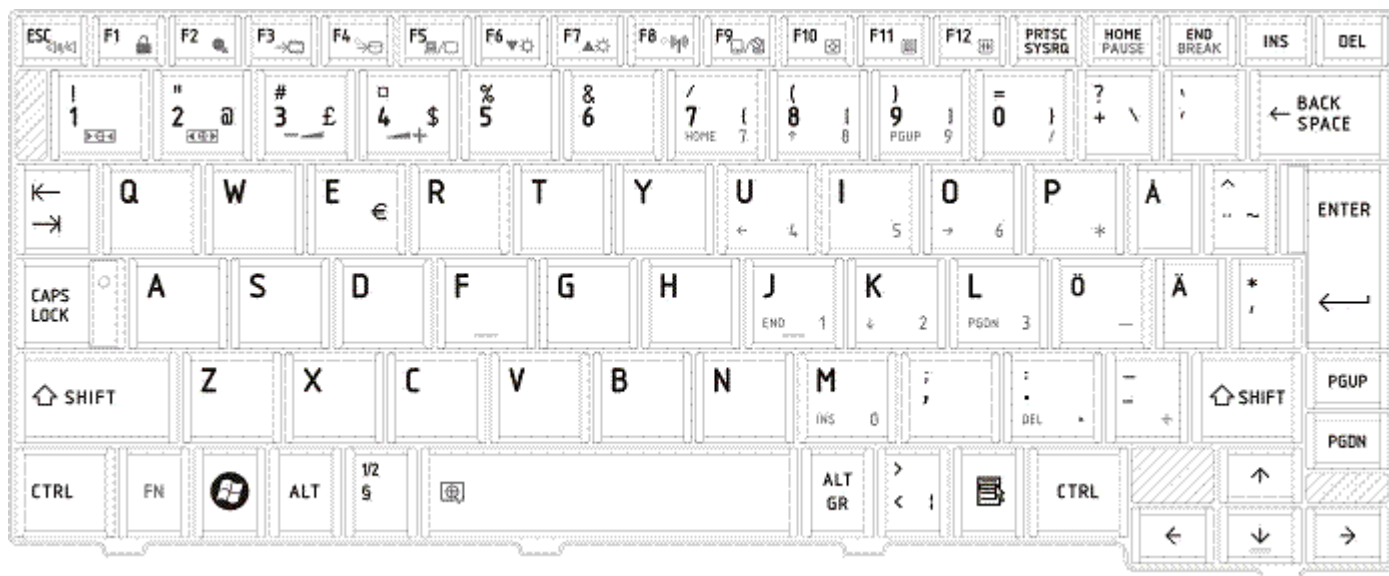

Figure SD keyboard

## E.24 Belgian\_Flemish (BE) Keyboard

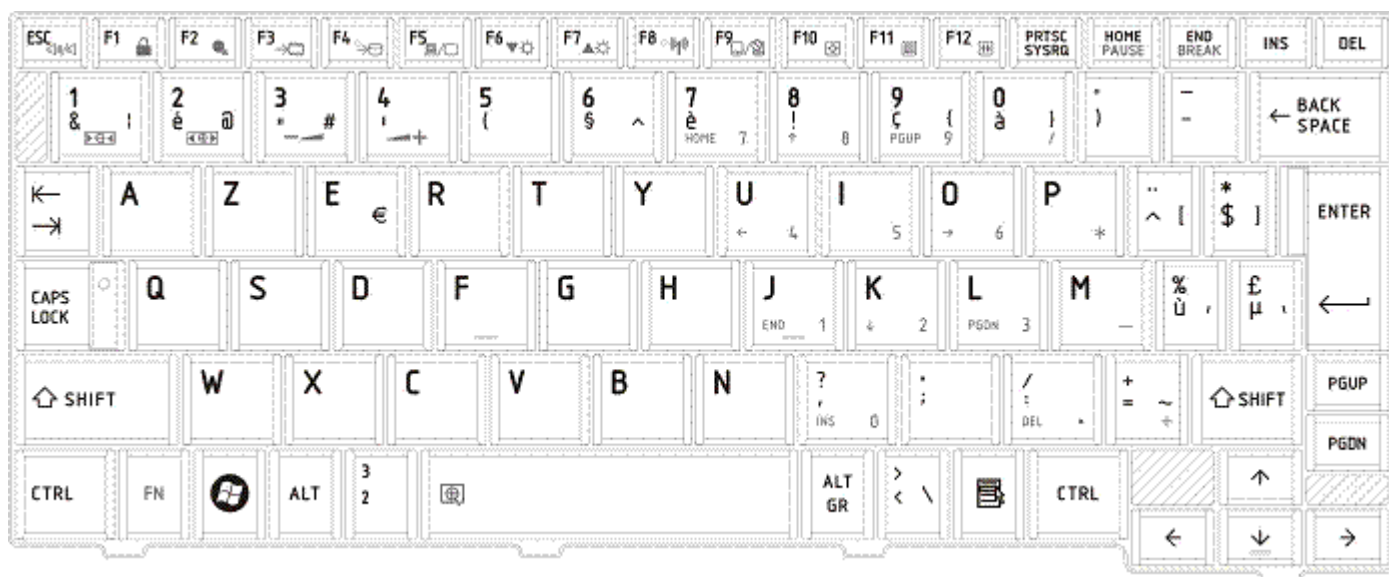

Figure BE keyboard

## E.25 Yugoslavian (YU) Keyboard

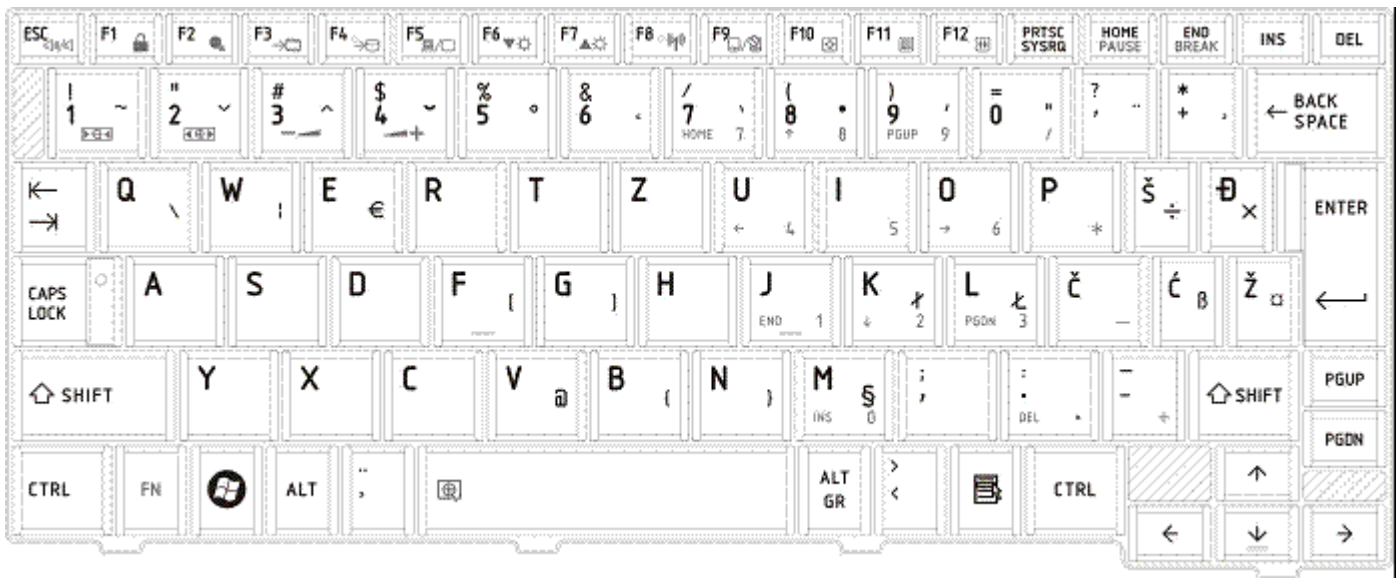

Figure YU keyboard

## E.26 Norwegian (NW) Keyboard

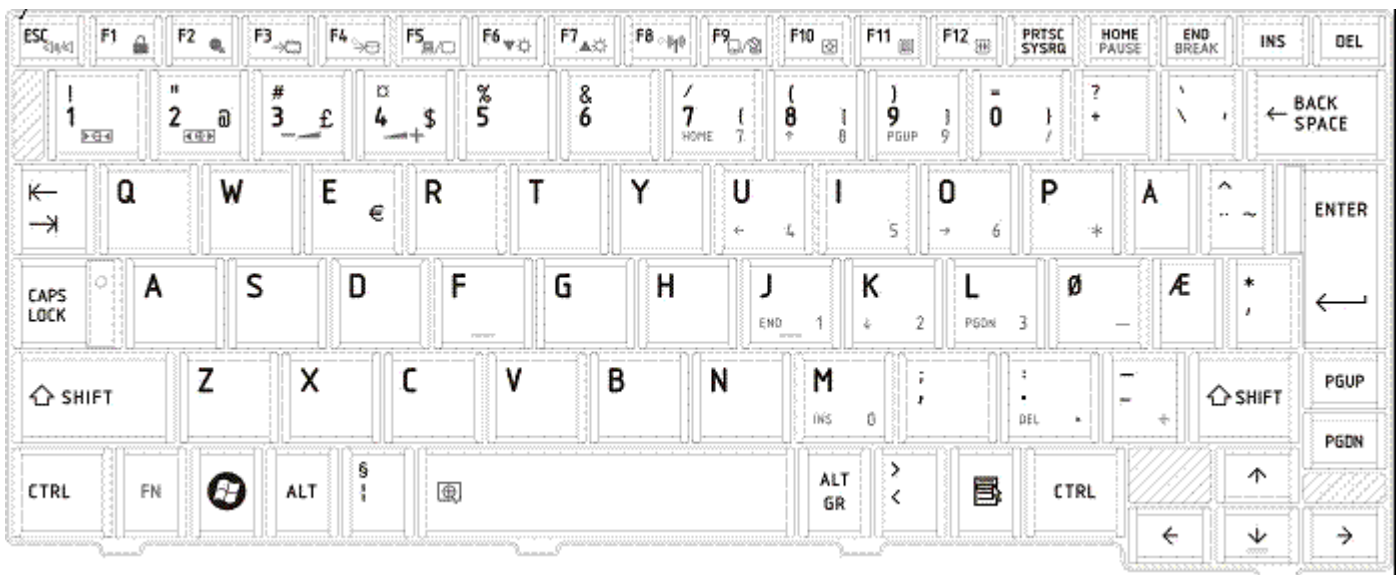

Figure NW keyboard

## E.27 Scandinavian (ND) Keyboard

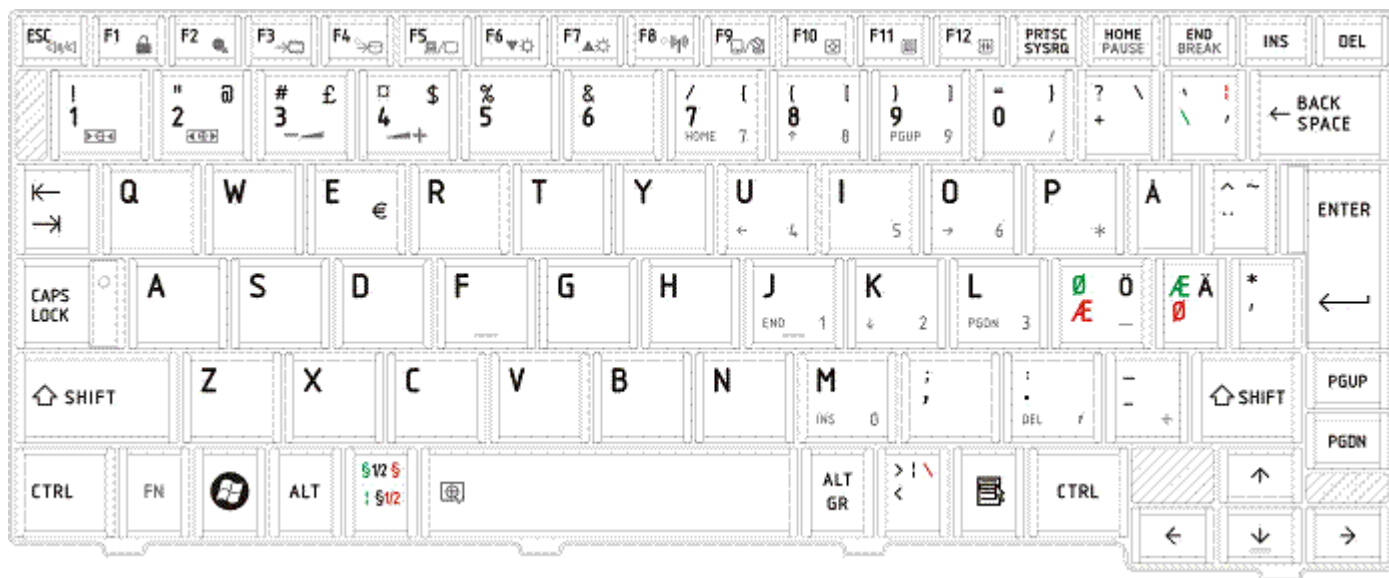

Figure ND keyboard

## E.28 Romanian(RM) Keyboard

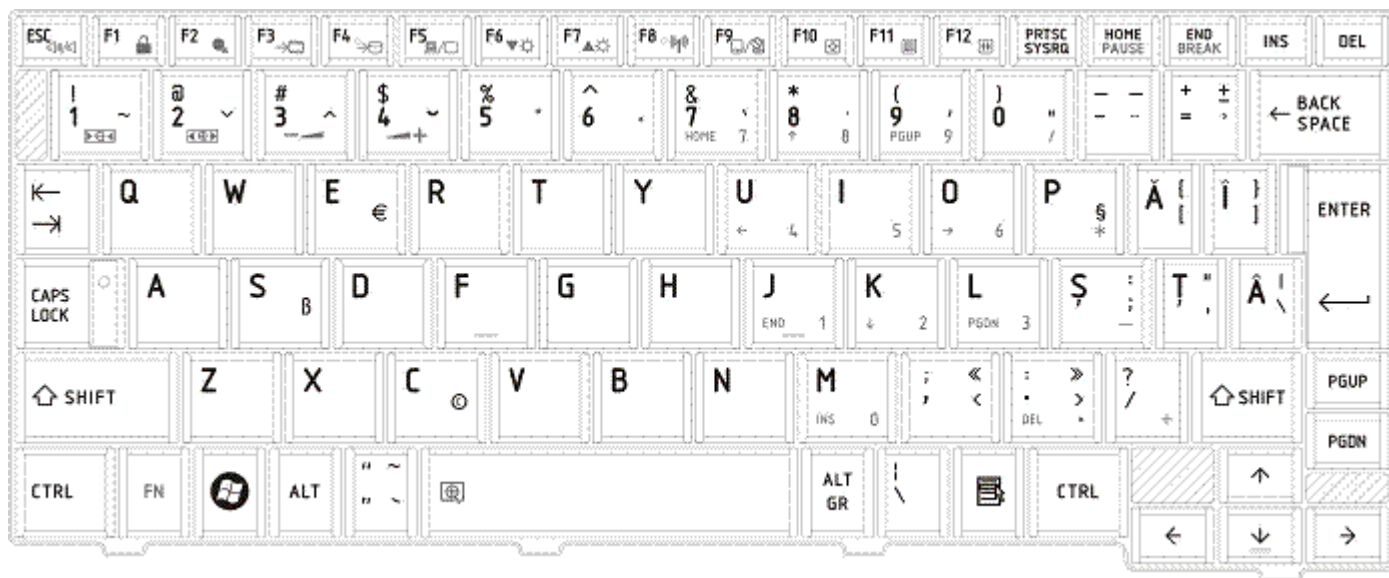

Figure RM keyboard

## E.29 France\_Canadian(Acnor) Keyboard



Figure Acnor keyboard

## E.30 Japanese (JP) Keyboard

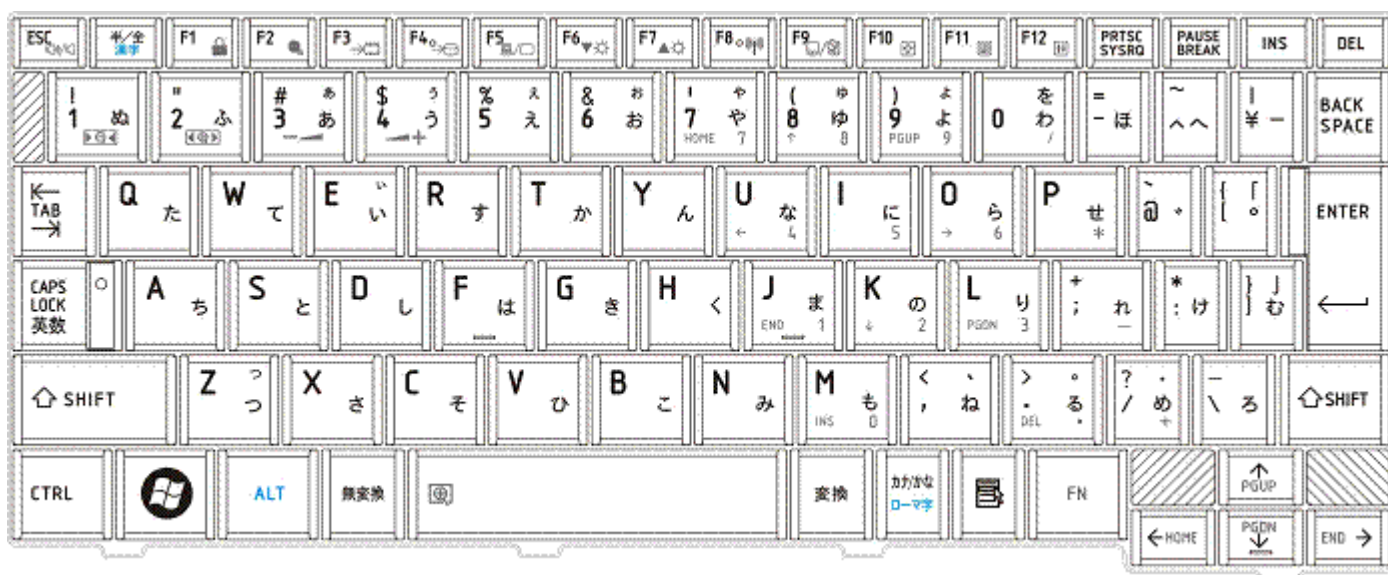

Figure JP Keyboard

## E.31 Bulgarian Keyboard

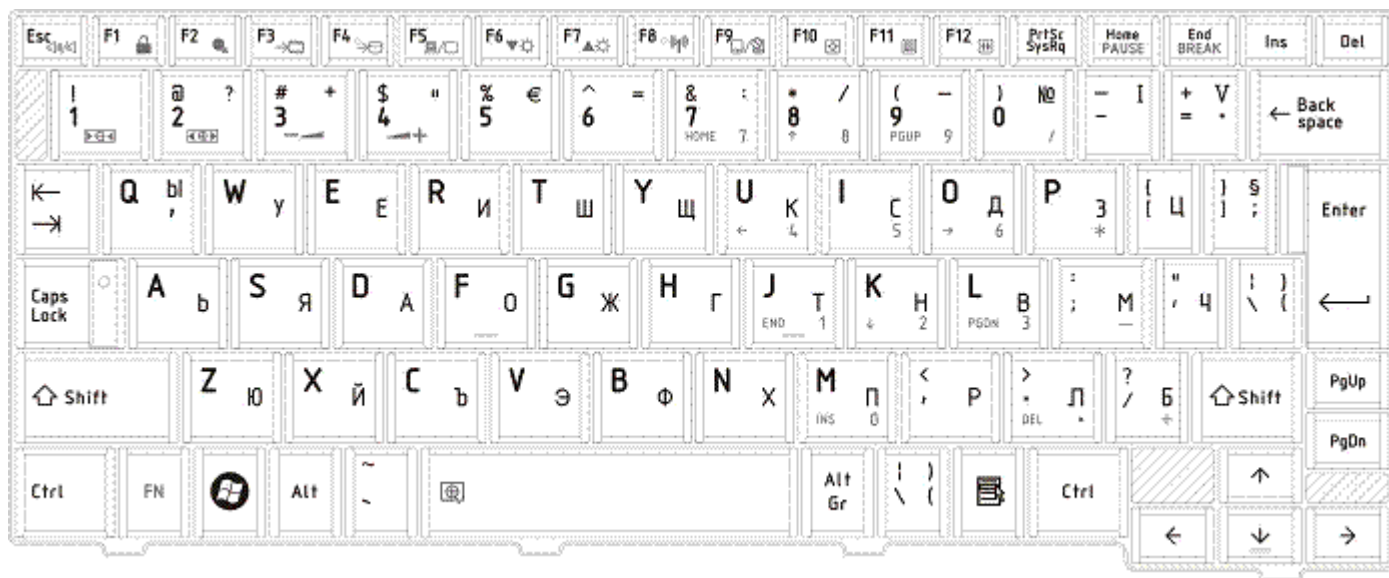

Figure BU Keyboard

## E.32 Taiwan(TW) Keyboard

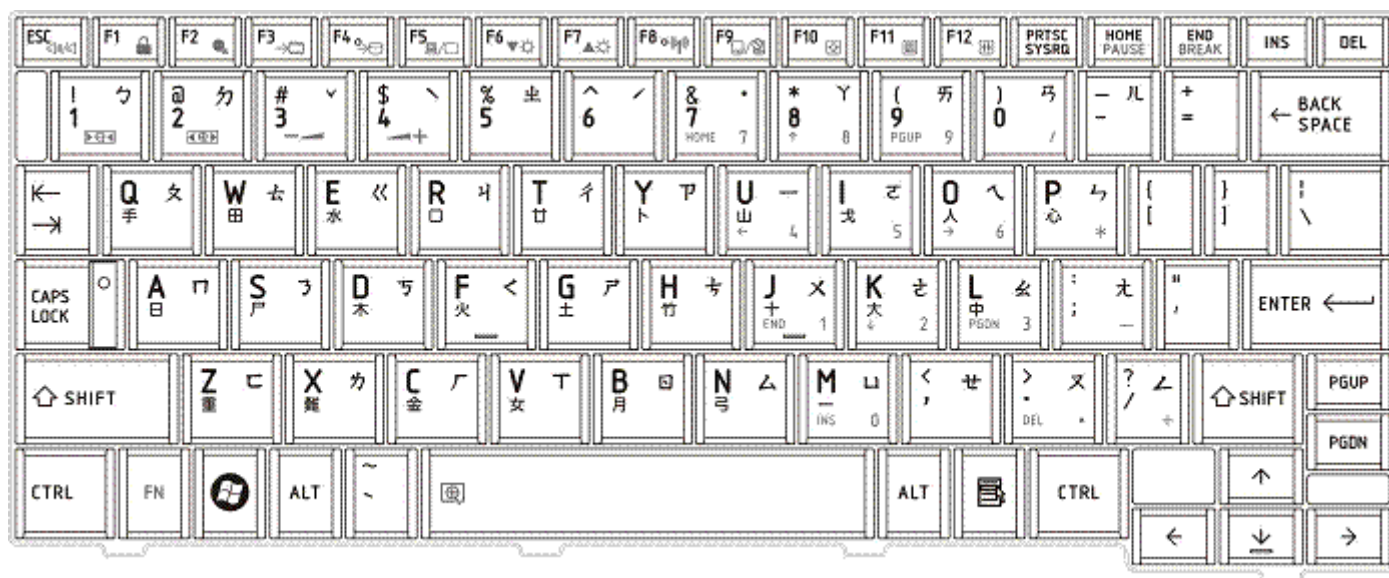

Figure TW Keyboard

---

## Appendix F Wiring Diagrams

---

### F.1 RGB Monitor ID Wraparound connector

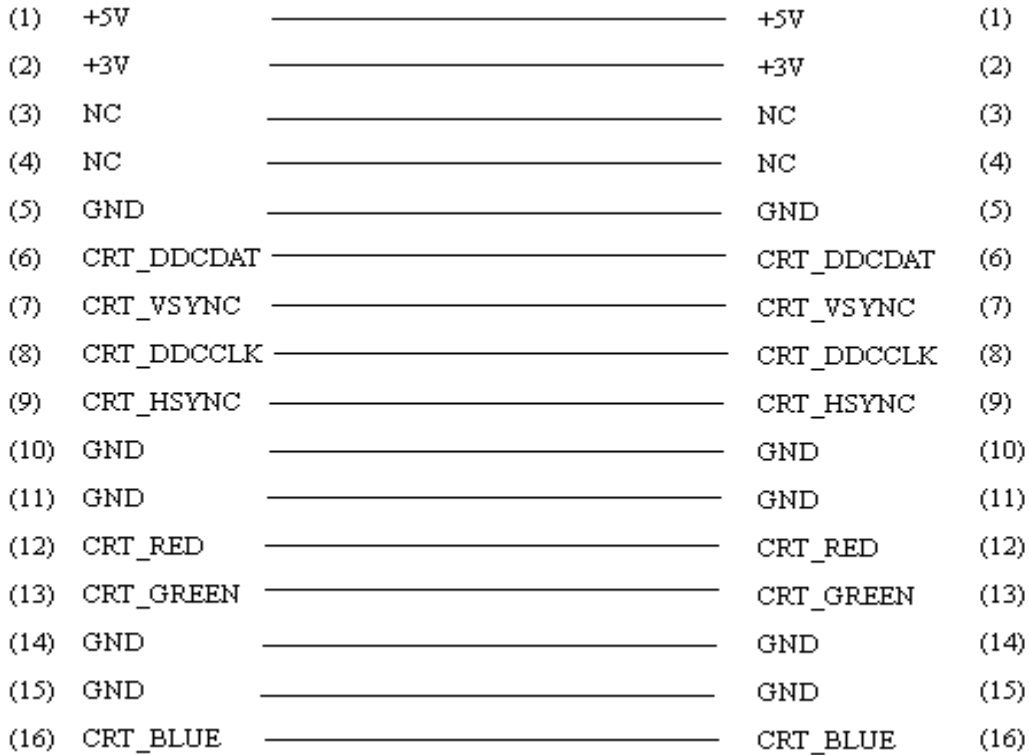

Figure F-1-1 RGB Monitor ID Wraparound connector (15PIN to 15PIN)

### F.2 LAN Loopback Connector

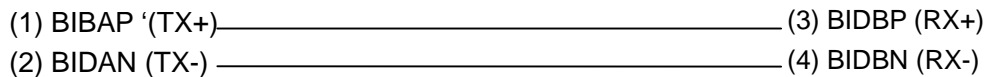

Figure F-2-1 LAN loopback connector

## Free Manuals Download Website

<http://myh66.com>

<http://usermanuals.us>

<http://www.somanuals.com>

<http://www.4manuals.cc>

<http://www.manual-lib.com>

<http://www.404manual.com>

<http://www.luxmanual.com>

<http://aubethermostatmanual.com>

Golf course search by state

<http://golfingnear.com>

Email search by domain

<http://emailbydomain.com>

Auto manuals search

<http://auto.somanuals.com>

TV manuals search

<http://tv.somanuals.com>