



Ascotel® IntelliGate® Communications Systems

A150
A300
2025
2045
2065

Office 70IP User's Guide





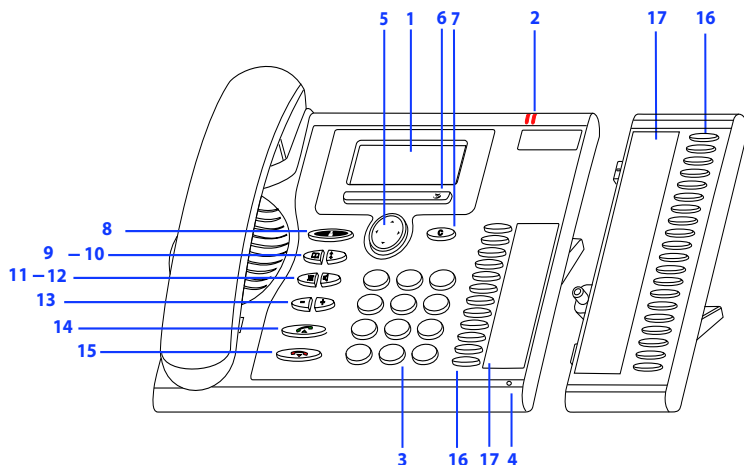





AASTRA



Operating elements

- 1 Display**
- In the upper area: status display with symbols.
 - In the middle area: current displays on the telephone traffic.
 - In the lower area: display of the available Foxkey functions.
- 2 Indicator LED**
- Left LED flashes: Call.
 - Right LED flashes: Voice Mail, message, or callback.
- 3 Key block**
Enters digits or letters.
- 4 Hands-free microphone**
- 5 Navigation key**
Scrolls back and forth in a menu, opens or exits menus, navigates in lists.
- 6 Foxkey**
Executes displayed function using the key. Foxkeys can be freely configured.
- 7 Correction key**
Deletes the last character or goes back one step in the menu.



- 8** **Absence key with LED**
 Preconfigured as call forwarding. The Absence key can be configured as a function key or digit key. 
- 9** **Phone book key**
 Opens phone books. 
- 10** **Redialkey**
 Selects the phone numbers last dialled. 
- 11** **Microphone key**
 Hands-free or handset microphone off / on. 
- 12** **Loudspeaker key**
 Hands-free operation on/off. 
- 13** **Volume/cursor keys**
 Adjustsvolume. 
- 14** **Call key**
 Set up / answer a call. 
- 15** **End key**
- Ends a call.
 - Exits input without saving and goes back to the idle state.
- 
- Configurable keys / line keys with LED (incl. Office KBM expansion keypad)**
 Freely configurable as a number, function or Team key:
- Number key with 2 storage locations (1st phone number: press once, 2nd phone number: Press twice).
 - Function key: Activate / Deactivate function.
 - Team key: Makes call or answers call. Announcement to a team partner (press twice).
- If preconfigured as a line key: Set up or answer call via line.
 Configure key: press and hold down.
- 16** **write-on labels (incl. Office KBM expansion keypad)**
 Write-on labels for the configurable keys can be found as an electronic document on the internet. You can fill out the fields directly on your PC and then print out the labels. The internet address is listed on the last page of this document. 
- 17**

■ Display symbols



Detailed information available



Other Foxkeys available
(Foxkey)



Search mode



Function activated



Entries on the call list



New text messages



Microphone deactivated



Loudspeaker/hands-free mode
activated



Forwarding activated



Call Forwarding on No Reply
activated



New Voice Mail



Voice Mail retrieved



Call parked



Retrieve parked call (Foxkey)



Headset mode activated



Activate discreet ringing

■ Safety Information

Failure to observe this information can be hazardous and infringe existing laws.



Connections

Always plug the phone cable connectors into the appropriate sockets. Do not modify the connections in any way.



Maintenance

Use original accessories only. Make sure all installation and repair work is carried out by a specially qualified technician.

Always use a soft, moistened, or antistatic cloth to clean your phone. Do not use chemicals or other chemical products.



Environmental influences

Do not operate the phone outside the temperature range of +5 °C to approx. +40 °C. Avoid direct sunlight and other sources of heat.

Protect your phone against the wet, excessive dust, corrosive liquids and steam.



Do not expose your phone to electromagnetic fields (electric motors, household appliances). The speech quality could be affected. To prevent interference, avoid placing your handset in the immediate vicinity of computers, radios, TV sets, VCRs, and other telephone sets.



Disposal

Be sure to dispose of your phone and its packaging in an environmentally compatible way; alternatively send it back to your supplier or servicing agent.

■ User information

Your terminal has been supplied with a Quick User's Guide, safety information and, where applicable, with other terminal-specific information. You can also download these documents as a complete User's Guide from www.aastra.ch/docfinder. More information on your terminal can be found at www.aastra.ch or in the documentation or your dealer's homepage. It is your responsibility to inform yourself about the scope of functions, operation and proper use of your equipment.

- Check whether you have all the user information available on your terminal, whether it conforms to your terminal's version and whether it is up to date.
- Read through the user information carefully before putting your terminal into operation.
- Store the user information within easy reach and refer to it whenever uncertainties arise in connection with the use of the terminal.
- When handing over your terminal to others, make sure you enclose the relevant user information.

■ Intended Purpose

This phone is part of the Ascotel® IntelliGate® communication system and is intended to be operated on that system.

Ascotel® IntelliGate® is an open, modular and comprehensive communication system that comprises the IP-PBX (referred to in the end-user information as “the system”), a vast number of expansion cards and modules, and a complete series of system terminals including IP system terminals. The system and all its component parts were designed to cover in full all the telecommunication requirements of companies and organisations with a single user-friendly solution. The individual components of the overall system are fully compatible and must not be used for other purposes or replaced by third-party components (except when connecting other authorized networks, applications and terminals to the interfaces provided specifically for that purpose).

■ About this document

Document number: eud-0830

- Document version: 1.0
- Valid for systems upwards: 17.5
- © 01.2007

Dialling and Phoning	8
You Receive a Call	9
You Want to Make a Call	10
Using the Display and Operating Elements	13
Display	14
Keys	14
Input	15
Menu-Guided Navigation	17
Signals	18
Supplementary features	19
Making and answering calls	20
Using functions while in a call	29
Organising absences from the desk.....	32
Organisation Within the Team.....	38
Functions for special situations.....	40
Line Keys	48
Setting functions by remote control	50
Personalizing Your Phone	51
Display	52
Setting the Ringing Properties (Audio).....	52
Hands-free and headset settings	54
General settings	56
Protection	59
Phone Book Management.....	60
Configuring Voice Mail.....	62
Configuring Keys	63
Configuring Line Keys.....	68
Formulating Functions	69
Local settings.....	70
Further information	71
Troubleshooting	72
Declaration Open Source Software	73
Liability.....	73
Installation and First-Time Operation	74
Equipment provided.....	75
Options	75
Setting up and mounting the phone	76
Connecting the phone	78
Office KBM expansion keypad (option)	80
Labelling Configurable Keys.....	81

Dialling and Phoning

The following sections explain how to make phone calls simply and the functions your phone offers you whenever you receive a call.

<i>You Receive a Call</i>	<i>9</i>
<i>You Want to Make a Call</i>	<i>10</i>

You Receive a Call

This section explains the procedure for answering a call.

■ Answering a Call

Your phone is ringing and the indicator LED is flashing. To answer the call, proceed as follows:



Pick up the handset.



Hands-free operation:

Press the Call key or the Loudspeakerkey.

Notes:

- If the caller's phone number is received, it is shown on the display. If the phone number is stored in the private phone book or in the system, the display also shows the corresponding name.
- To find out how to make phone calls with the headset, refer to the Chapter "Using a Headset", 12.
- To find out how to make phone calls in hands-free mode or in automatic hands-free mode, refer to the Chapter "Using Your Phone in Hands-Free Mode", 11 and the Chapter "Automatic Hands-Free Mode", 54 respectively.

■ Ending a Call

You want to end the call.

After the call the call duration is indicated. Call charges are also displayed after any external call which you initiated, provided your provider supports this function.



Put the handset on-hook.



Ending a call in hands-free mode:

Press the End key or the Loudspeakerkey.

Notes:

- To disconnect the call, simply replace the handset.
- To find out how to make phone calls with the headset, refer to the Chapter "Using a Headset", 12.
- To find out how to make phone calls in hands-free mode or in automatic hands-free mode, refer to the Chapter "Using Your Phone in Hands-Free Mode", 11 and the Chapter "Automatic Hands-Free Mode", 54 respectively.

You Want to Make a Call

This section explains the different ways you can make a call with your phone.

■ Dialling with the Phone Number

You want to call someone and key in that person's phone number.

With call preparation you can enter a phone number without it being dialled automatically, so you have time to check the number and, if necessary, correct it. The number is not dialled until you go off-hook, for example by picking up the handset.



Enter a phone number in call preparation.

Note:

You can use the Correction key to delete any incorrect character.



Pick up the handset.

→ The person is called.

Or:

Press the Call key or the Foxkey *Call*

→ The person is called.

■ Dialling with Redial

You want to call a person you have already called.

In the last-number redial list your phone automatically stores the phone numbers of the persons you have already called, complete with their names, where available. You can now call the person in question using this last-number redial list.



Press the Redial key.

→ The first phone number on the last-number redial list is displayed.



Press the Redial key several times or press the down navigation key to scroll through all the phone numbers you last dialled.



Pick up the handset.

→ The phone number displayed is dialled.

■ Using Your Phone in Open Listening Mode

You want other people in the room to be able to listen in to the call.

The open listening function lets you activate the loudspeaker in addition to the handset.



During a call:

Press the Loudspeaker key.

→ Open listening is now activated,  is displayed.

Note:

You can continue with the call as usual using the handset.



Deactivating open listening:

Press the Loudspeaker key a second time.

→ Open listening is now deactivated.

Note:

To end a call in open listening mode, you need to press the Loudspeaker key and hang up the phone. If you merely replace the handset, the phone switches to the hands-free mode.

■ Using Your Phone in Hands-Free Mode

You want other people to join the conversation or to have your hands free while making the call.

The hands-free mode function activates the loudspeaker and the microphone.



During a call:

Press the Loudspeaker key.

→ Open listening is now activated,  is displayed.



Put the handset on-hook.

→ The hands-free mode is now activated,  is displayed.

Notes:

- Make sure the hands-free microphone is not obstructed.
- The sound quality is improved if you set the volume of your phone to a low setting.



To continue the call with the handset:

Pick up the handset.

→ The loudspeaker and hands-free microphone are now deactivated.

Notes:

- To find out how to make phone calls with the headset, refer to the Chapter "[Using a Headset](#)", 12.
- To find out how to activate the automatic hands-free mode, refer to the Chapter "[Automatic Hands-Free Mode](#)", 54.

■ Muting the Microphone

In the middle of a call you want to talk briefly with other persons in the room without your call partner hearing your conversation.

You can switch the microphone on and off during a call.



Switching the microphone off:

Press Microphone key.

→ The microphone is now deactivated,  is displayed.



Switching the microphone back on:

Press the Microphone key once again.

■ Using a Headset

To make a phone call with the headset.

If you answer a call in headset mode using the Call key or Loudspeaker key, the call is provided on the headset. Alternatively you can also answer the call by picking up the handset.



Your phone is ringing and the indicator LED is flashing. To answer the call, proceed as follows:

Press the Call key or Loudspeaker key.

→ The call is provided on your headset.

Open listening



Press the *Hands-free* Foxkey.

→ The phone's loudspeaker is activated.

Hands-free operation



Press the *Hands-free* Foxkey.

→ The phone's microphone is switched on and the headset microphone is switched off.

Headset



Press the *Headset* Foxkey.

→ Back to the headset mode.



Ending a Call:

Press the End key or the Loudspeakerkey.

Notes:

- To find out how to activate the headset, refer to the Chapter "[To activate headset operation](#)", 55.
- To call a subscriber, dial the subscriber's phone number and press the Call key or Loudspeaker key.
- For more information refer to your headset's operating instructions.

Using the Display and Operating Elements

The following sections explain how to operate your phone quickly and simply.

<i>Display</i>	14
<i>Keys</i>	14
<i>Input</i>	15
<i>Menu-Guided Navigation</i>	17
<i>Signals</i>	18

Display

■ Display symbols and display text

New events such as a call in your absence, a new message or activated functions (e.g. Forwarding) are signalled on the display in the idle state by a symbol or a display text. You can then use the relevant Foxkey to call up the information.

**If more Foxkeys are available:**

Press the >> Foxkey.

**Retrieving detailed information:**

Press the right navigation key.

**Function activated:**

The activated function or selected setting is indicated by a check mark.

End

**Deleting the display text:**

Press the End Foxkey.

→ The display returns to the idle state; the function remains activated.

Keys

■ Pressing a Key

A key may have various functions depending on the situation and the operating mode. The function activated depends on the number of times the key is pressed or whether it is pressed quickly or held down for a moment. Here are some examples:



Press the Foxkey.

<long>



Keep the Foxkey held down for a moment (about 2 seconds).

<2x short>



Press the key twice in quick succession.

■ Using the Foxkey

The Foxkey has variable functions. These functions are displayed above the key.

Several contacts are stored under the broad Foxkey, which means you need to press the Foxkey precisely under the function you want.



Press the Foxkey under the position where the display shows the function you want.

Input

■ Enters digits

The digit keys are used to enter the digits 0 to 9.

■ Enter the letters

You can also use the digit keys to enter letters and special characters. A number of letters and special characters are assigned to each key.

To enter letters using the digit keys, you need to be in text mode. The text mode is activated automatically if the phone is expecting a text input. You can switch back and forth between number mode and letter mode during your input.

abc-->123















Switching between number mode and letter mode during your input:

Press the *abc-->123* and *123-->abc* Foxkey.

■ Digit keys

The characters are assigned to the digit keys as follows. Press the relevant digit key repeatedly until the character you want is displayed:

	-.? !!,:;' " 'i		ABC 2 Ä Æ Å Ç a b c 2 ä æ å à ç
	DEF 3 É d e f 3 é è ê		GHI 4 g h i 4 i
	JKL 5 j k l 5		MNO 6 Ñ Ö Ø m n o 6 ñ ö ø ò
	PQRS 7 p q r s 7 ß		TUV 8 Ü t u v 8 ü ù
	WXYZ 9 w x y z 9		+ 0 +
	@ * / () < = > % £ \$ € ¥ ¢ & § @		<Space> # #

■ Switching between Upper and Lower Case

You want to switch between upper and lower case while making an input in text mode.

Upper-case input is automatically activated when the first letter is entered. The text mode then automatically switches to lower-case input. You can use the Foxkey to switch manually between upper-case and lower-case input.



Switching between upper case and lower case in text mode:

Press Foxkey *a>A* or *A>a*.

■ Correcting your Input

You notice you have entered a wrong digit or character. You can either delete the input one character at a time or cancel the entire input.



To delete the last character:

Press the correction key.

Note:

With the navigation key you can go straight to the character you want to delete.



End input without saving:

Press the End key.

■ Moving the Cursor

You want to go to a certain character for an input or correction.

With the navigation key you can move the cursor to the left or right.



Move the cursor with the horizontal navigation key.

Menu-Guided Navigation

■ Accessing the menu

The phone is in standby mode:

Menu



Press the *Menu* Foxkey.
→ The first menu entry is displayed.



Use the vertical navigation key to scroll through the menu entries.

Selecting



Press the *Select* Foxkey.
→ Accessing the displayed menu.

■ Navigating with the navigation key

You can retrieve a particular menu entry even more simply and efficiently using the navigation key. You can scroll vertically and horizontally through the different menu entries.



Horizontal navigation key:

Left: scrolls back through the menu.

Right: scrolls forward through the menu, opens displayed menu, retrieves detailed information.



Vertical navigation key:

Bottom: scrolls downwards in the list.

Top: scrolls upwards in the list.

■ Undoing Actions

To cancel operating steps, proceed as follows.



End input without saving:

Press the End key.



Back to the idle state in the menu:

Press the End key.

■ Other navigation possibilities



Scrolling back through the menu:

Press the correction key.

■ Resetting activated features

You can deactivate again all the activated functions (e.g. Forwarding, Barring).

Menu



Press the *Menu* Foxkey.

Activated features



Scroll to *Activated features* and press the *Select* Foxkey.

→ All the activated functions are now displayed.

Reset



Reset the function in question.

→ The function is now deactivated.

Signals

■ Indicator LED Signals

Depending on the situation the indicator LEDs either flash or remain steadily lit.



Left LED flashes:

→ Phone is ringing.



Right LED flashes:

→ New Voice Mail, message, or callback received.

Supplementary features

The following sections explain the supplementary features provided by your phone for more efficient use.

<i>Making and answering calls</i>	20
<i>Using functions while in a call</i>	29
<i>Organising absences from the desk</i>	32
<i>Organisation Within the Team</i>	38
<i>Functions for special situations</i>	40
<i>Line Keys</i>	48
<i>Setting functions by remote control</i>	50

Making and answering calls

This section explains some convenient features provided by your phone for making a call.

■ Dialling by Name - Quickdial

You want to make a call by entering a name.

With Quickdial you only need to press the digit keys for each letter once, even though each key is assigned several letters. An efficient algorithm provides quick search results.

The surname and first name have to be separated by a space (# key), for example "no s" (6 6 # 7) for Noble Stephen. Ask your system administrator whether you should start with the surname or the first name.

Requirement: The name and the corresponding call number are stored in one of the system's phone book or in an external phone directory connected to the system.

Note:

To be able to search in an external phone book using Quick Dial, you need to press the *-key or 0-key before entering the first letter.



Press each of the corresponding digit keys once for the first few letters of the name you are looking for.

→ For each letter, the display shows the corresponding digit, for example a "6" for the letter "n".



Press the phone book key.

→ The phone searches for matching names.



You may have to enter another letter before the name you want or a list of names is displayed.



Scroll through the list until the subscriber you want is displayed.



Pick up the handset.

→ The phone number displayed is dialed.

■ Dialling from the phone book

You want to search directly in one of the connected phone books.

The surname and first name have to be separated by a space, for example "no s" for Noble Stephen. Ask your system administrator whether you should start with the surname or the first name.



Press the phone book key.

Finding an entry



Scroll to *Search entry* and press the *Select* Foxkey.



If required, enter the first few letters of the name you are looking for (first name and surname separated by a space) until the subscriber or a list is displayed.

Notes:

- Text mode is activated automatically.
- Use the #-key to enter spaces.



Scroll through the list until the subscriber you want is displayed.



Pick up the handset.

→ The phone number displayed is dialled.

Notes:

- The search function is not affected by upper/lower case and special characters.
- If the phone is unable to find a matching name, *List empty* will appear on the display.
- To find out to create a new contact in your private phone book, refer to the Chapter "[Creating a New Phone Book Entry](#)", 60.

■ Dialling from external phone books

If you select *Advanced search*, you can search directly in the connected external phone books. This function is not available if no external phone book is connected.

The surname, first name and town each have to be separated by a space, for example "no s so" for Noble Stephen in Solothurn. Ask your system administrator whether you should start with the surname or the first name.



Press the phone book key.

Advanced search



Scroll to *Advanced search* and press the *Select* Foxkey.



Enter the first few letters of the name you want (first and last name separated by a space).

Notes:

- Text mode is activated automatically.
- Use the #-key to enter spaces.



If required, enter the first few letters of the town's name (name and town name separated by a space) until the subscriber or a list is displayed.



Scroll through the list until the subscriber you want is displayed.



Pick up the handset.

→ The phone number displayed is dialled.

Notes:

- The search function is not affected by upper/lower case and special characters.
- When searching in external phone books you must always enter portions of the first and last name and possibly of the town name.
- The response time may vary greatly depending on the size and the number of phone books connected.

■ Dialling from the Call List of Unanswered Calls

You want to call someone who has previously tried to reach you.

Your phone automatically stores the phone number of this subscriber in a calllist and the display reads *Missed calls*. You can now call the person back using this call list.

The call list of unanswered calls contains a maximum of 10 entries.



Calling a subscriber back:

Press the *Show* Foxkey.

→ The display shows a list of the last unanswered calls.



Scroll through the list until the subscriber you want is displayed.



Pick up the handset.

→ The phone number displayed is dialled. Once the call has been successfully connected, the entry is deleted from the call list.

Note:

The call list of unanswered calls can also be accessed via the menu. For navigation see the Chapter "[Dialling from the Call List of Answered Calls](#)", 23.

■ Dialling from the Call List of Answered Calls

You want to call back someone whose call you answered.

Your phone automatically stored the person's phone number on the list of answered calls. You can now call the person back using this call list.

The list of answered calls contains a maximum of 10 entries.



Press the *Menu* Foxkey.

Call lists



Scroll to *Call lists* and press the *Select* Foxkey.

Answered calls



Scroll to the *Answered calls* call list and press the *Ok* Foxkey.

→ The display shows the list of the last calls.



Scroll through the list until the subscriber you want is displayed.



Pick up the handset.

→ The phone number displayed is dialled.

■ Dialling with Redial

You want to call a person you have already called.

In the last-number redial list your phone automatically stores the phone numbers of the persons you have already called, complete with their names, where available. You can now call the person in question using this last-number redial list.

The last-number redial list has a maximum of 10 entries.



Press the Redial key.

→ The first phone number on the last-number redial list is displayed.



Press the Redial key several times or press the down navigation key to scroll through all the phone numbers you last dialled.



Pick up the handset.

→ The phone number displayed is dialled.

■ Selecting with a preconfigured Foxkey

You want to call someone whose phone number is stored under a Foxkey.

You can dial the person by pressing the corresponding position on the Foxkey.



Press the corresponding Foxkey.

→ The key's allocated function is shown on the display.



Pick up the handset.

→ The phone number is dialled.

Note:

To find out how to configure a Foxkey, refer to the Chapter "[Configuring Keys](#)", 63.

■ Dialling with a Configurable Key

You want to call someone whose phone number is stored under a configurable key.

You can dial the person by pressing the corresponding key.

<1x short>



Activate the key's first allocated function:

Press the key once.

→ The key's first allocated function is displayed.

<2x short>



Activate the key's second allocated function:

Press the key twice in quick succession.

→ The key's second allocated function is displayed.



Pick up the handset.
→ The phone number is dialled.

Note:

To find out how to configure a configurable key, refer to the Chapter "Configuring Keys", 63.

■ Requesting a Callback

You want to talk to a certain person. The person is busy or does not answer. You can make callback requests to both internal and external subscribers. Not all providers support this function.

If the called party is busy, you can activate an automatic callback. In this case, your phone will start ringing as soon as the party you are trying to reach goes on-hook. When you pick up the handset, the person you want to call is dialled directly.

If the called party does not answer, you can also request a callback. The subscriber then obtains a message indicating your callback request on his display.

You called someone and hear the busy tone or the ring-back tone.

Callback



To activate a callback request:

Press the *Callback* Foxkey.



Put the handset on-hook.
→ The display shows *Call expected...*

End



Back to the idle state:
Press the *End* Foxkey.
→ Callback remains activated.

Reset



Reset callback:
Press the *Reset* Foxkey.
→ Callback is deactivated.

Note:

You can only have 1 callback activated at a time and only 1 callback can be expected from you. Your callback request will automatically be cancelled by the system after about half an hour.

■ To answer the callback request

Someone has asked you to call back. You can tell this from the lit attention LED in the idle state. The display reads *Call back requested...*

Call



Press the *Calls* Foxkey.
→ The phone number is dialled.

Note:

You can deactivate a requested callback using *Menu > Activated features > Reset* Foxkey.

■ Call Waiting on an Internal Subscriber

You want to talk to an internal subscriber. However, the person is busy.

As a result of your call waiting, the person hears a call waiting tone and your phone number or name appears on his display. The person can either answer or reject your call.

Requirement: It is essential that the internal subscriber has not barred the Call waiting function on his phone (for configuration see the Chapter "[Protect against Do not disturb/Call waiting/Intrusion/Announcement/Forward](#)", 59).

Ask your system administrator whether the Call waiting function is enabled on the system.

Call waiting



Subscriber is busy:

Press the *Call waiting* Foxkey.

→ You hear the dialling tone.

Note:

If the person rejects your call request or if call waiting is not possible, the call is disconnected (busy tone).

■ Answering Call Waiting

You are in a call and hear the call waiting tone. Someone is urgently trying to reach you.

You can either answer, deflect or reject the call.

Answer



Answering the call:

Press the *Answer* Foxkey.

→ 1. Your original call partner is put on hold. You are now connected with the party who initiated the call waiting.

Note:

For more detailed information on how to broker between callers or set up a conference, please refer to the Chapters "[Brokering between an Enquiry Call Party and Your Call Partner](#)", 29 and "[Making a Conference Call](#)", 30 respectively.

<Phone number>



Deflect call:

Enter the subscriber phone number and confirm with the *Ok* Foxkey.

→ Call-waiting party is put through.

Note:

You can also search in the phone book, last-number redial list or call list for the phone number of the person you are looking for.

Deflection



Press the *Deflect* Foxkey.

Reject



Rejecting the call:

Press Foxkey *Reject* or End key.

→ You remain connected with your first call partner. The call-waiting party hears the busy tone.

Exit



Ending a current call:

Press the *End* Foxkey.

→ 1. The first call is terminated. You are now connected with the party who initiated the call waiting.

■ Starting an Announcement

You want to address internal subscribers directly via their loudspeaker – where available –, without waiting for a reply (similar principle to that of an intercom system).

Requirement: It is essential that the internal subscriber has not barred his phone against announcement (for configuration see the Chapter "[Protect against Do not disturb/Call waiting/Intrusion/Announcement/Forward](#)", 59).



Pick up the handset.

Announcement



Press the *Announcement* Foxkey.

<Destination>



Select destination (*Subscriber* or *Group*) and confirm *Ok* with the Foxkey.

<Phone number>



Enter the phone number and confirm with the *Ok* Foxkey.

→ Subscriber is made aware of the announcement by an acoustic signal. The display reads *Announcement*: You can now talk.

Note:

You can also search in the phone book, last-number redial list or call list for the phone number of the person you are looking for.

Or:

- Press the *Menu* Foxkey.
- Scroll to *Call features* and press the *Select* Foxkey.
- Press *Announcement*, select destination, and confirm *Ok* with the Foxkey.
 - The display shows the number of the phone from which you last picked up a call.
- Confirm *Ok* with the Foxkey or pick up the handset.
 - Subscriber is made aware of the announcement by an acoustic signal. The display reads *Announcement*: You can now talk.

■ Receiving an Announcement

After an attention tone you will be addressed via your loudspeaker.

You can listen to the announcement or stop it.



To continue the announcement as a phone call:

Pick up the handset.

→ You are now connected to the person who initiated the announcement.

Note:

If the announcement was started to a group, all the other recipients of the announcement are excluded.



To stop the announcement:

Press the End key.

■ Private call with PIN

You want to make a private call on your phone or on a third-party phone.

With the aid of your PIN you can use any phone to make an external call with your own personal settings, even if that phone is locked for external calls. The called party's display shows your personal phone number and not the number of the phone from which you are making your call. Any call charges incurred will be charged to you.

The call number dialled is not stored in the last-number redial list.



Enter #46 followed by your internal call number.

Enter your PIN.

Enter the external call number directly, without the exchange access digit.

→ The phone is now enabled. The external subscriber is called.



Pick up the handset.

Note:

The factory setting "0000" is not accepted. First change the PIN as described in the Chapter "[Changing the PIN](#)", 57 or using the */# procedure *47 (see "User's Guide */# Procedures as of 17.1"). If you have forgotten your PIN, your system administrator can reset it to the factory setting.

Using functions while in a call

This section explains the different options provided by your phone while you are in a call.

■ Enquiry Call During a Call

You want to call someone else briefly without losing your current call partner. Then you want to resume your conversation with your original call partner.

With the *Enquiry call* function you can call someone else in the middle of a call and put your original call partner on hold. You can make enquiry calls to both internal and external subscribers.



Enquiry call



Exit



You are making/taking a call:

Enter the phone number of the enquiry call party.

Note:

You can also search in the phone book, last-number redial list or call list for the phone number of the person you are looking for.

Press the *Enquiry call* Foxkey.

→ Enquiry call party is called; 1st call partner is on hold.

To end the enquiry call:

Press the *End* Foxkey.

→ You are now back through to your first call partner.

Note:

If your enquiry call party hangs up and you also go on-hook by mistake, you will hear a continuous ringing signal for 10 seconds to draw your attention to the person still on hold. If you pick up the receiver during the continuous ringing, you will be reconnected with your first call partner.

■ Brokering between an Enquiry Call Party and Your Call Partner

You are talking with an enquiry call party and have your original call partner on hold. You want to be able to switch back and forth between the two.

In an enquiry call you can use the brokering function to switch back and forth between an enquiry call party and the party on hold. Brokering is possible with both internal and external subscribers. You can also broker between conference parties as a group and an enquiry call party.

Brokering



Exit



Brokering:

Press the *Brokering* Foxkey.

→ Your call partner changes. The other call party is put on hold.

To terminate the current connection:

Press the *End* Foxkey.

→ Call party disconnected. Connected with the call party on hold.

■ Making a Conference Call

You are in a call and have a call party on hold at the same time. You want to include the party on hold in the conversation and hold a conference call.

With the conference function you can include a call party on hold in the current conversation. From the conference call you can initiate an enquiry call to someone else. You can broker between the parties of the conference and the enquiry call party.

Depending on the system, a conference call can consist of up to 6 conference participants. You can hold a conference call with internal and external subscribers.

Conference



To connect the call party on hold:

Press the *Conference* Foxkey.

→ The call party on hold is now included in the call.

Note:

Depending on the system's configuration you may hear an attention tone.

Leaving a conference call:

Put the handset on-hook.

→ The other conference parties remain in the call.



■ Transferring a Call Partner

You want to put your call partner through to someone else.

With the *Enquiry call* function you can connect your call partner with someone else. You can connect internal and external subscribers with one another.



Enter the other party's phone number.

→ The other party is called.

Note:

You can also search in the phone book, last-number redial list or call list for the phone number of the person you are looking for.

Enquiry call



Press the *Enquiry call* Foxkey.

→ 1. Your original call partner is put on hold.

Connecting with notification:

Wait until the person has answered the call. Announce the call party.

Connect



Put the handset on-hook or press the *Connect* Foxkey.

→ 1. Your call partner and the other person are now connected with each other.

Note:

If the other subscriber does not answer, you can cancel the enquiry call with the *Brokering* Foxkey, and take back the first call.



Connecting without notification:

Wait for the first ringing tone, then hang up.

→ The other party is then called directly by your first call partner.

Note:

Recall: If the other party does not answer, the call comes back to your phone.

■ Parking a Call Partner

You want to put your call partner on hold without using a phone channel as a result.

You can park your call partner locally. A locally parked call partner can only be retrieved by the phone from which the function was initially carried out. You can also allocate the Park function to a freely configurable key (see Chapter "Configuring Keys", 63).

Park



Press the *Park* Foxkey.

→ Your call partner is now parked locally; [P] is displayed.



Put the handset on-hook.



Pick up the handset.

[P]



To retrieve a parked call party:

Press the [P] Foxkey.

→ Connected in hands-free mode.



To phone with the handset:

Pick up the handset.

Notes:

- With the Foxkey *End* the display returns to the idle state. As long as your call partner does not hang up, he remains parked. You can retrieve your parked call party using *Menu > Activated features > Foxkey [P]*.
- The */# procedure for central parking can be found in the "User's Guide */# Procedures as of I7.1".

Organising absences from the desk

This section explains the different options provided by your phone when you want to leave your desk.

■ Using the Absence Key

You want to leave your desk and set up your phone for your absence.

Your phone has an Absence key. It is factory set as a call forwarding unconditional key. By simply pressing the Absence key you can activate a call forwarding unconditional.



Enter the phone number to which the call is to be forwarded.



Press the Absence key.

→ Call Forwarding is activated; LED is lit.



To activate the last forwarded destination:

Press the Absence key.

→ Call Forwarding is activated; LED is lit.

Note:

You can configure the Absence key like any other configurable key (see Chapter "Configuring Keys", 63).

When you are back at your desk:

Press the Absence key.

→ The call forwarding unconditional is deactivated. The phone reverts to the idle state.



■ Forwarding Calls (Call forwarding)

You want to leave your desk. Calls for you are to be forwarded to a different destination (e.g. phone, Voice Mail, pager).

With Call Forwarding you can forward incoming calls directly to a different destination.

Menu



Press the *Menu* Foxkey.

Forwarding



Scroll to *Forwarding* and press the *Select* Foxkey.

Call Forwarding
Unconditional



Scroll to *Call Forwarding* and confirm *Ok* with the Foxkey.

Subscriber



Scroll to *Subscriber* and confirm *Ok* with the Foxkey.

<Phone number>



Enter the subscriber phone number and confirm with the *Ok* Foxkey.

Notes:

- You can also search in the phone book, last-number redial list or call list for the phone number of the person you are looking for.
- If a call is to be forwarded only when you are already in a call, select *Call forwarding busy*.
- You can also forward to your *Voice Mail* (see Chapter "[Forward to Voice Mail](#)", 35), to a *Message* (see Chapter "[Forwarding to a message](#)", 36) or to a *Pager*.
- You can deactivate callforwarding again using *Menu > Activated features > Reset* Foxkey.
- You can also activate call forwarding by remote control, see Chapter "[Setting functions by remote control](#)", 50.

■ Forwarding a Call on No Reply (CFNR)

You want calls that you receive on your phone to be forwarded to another destination.

Both your own phone and the other destination will then start ringing. The system configuration determines whether or not there is a ringing delay at the other destination. Whoever goes off-hook first, answers the call. Depending on the system configuration, Call Forwarding on No Reply can also be activated when your phone is busy.

Menu



Press the *Menu* Foxkey.

Forwarding



Scroll to *Forwarding* and press the *Select* Foxkey.

Call Forwarding on No
Reply



Scroll to *Call Forwarding on No Reply* and confirm *Ok* with the Foxkey.

Subscriber



Scroll to *Subscriber* and confirm *Ok* with the Foxkey.

<Phone number>



Enter the phone number of the destination to which your calls are to be forwarded and confirm *Ok* with the Foxkey.

Notes:

- You can also search in the phone book, last-number redial list or call list for the phone number of the person you are looking for.
- You can also forward calls to your *Voice Mail* (see Chapter "[Forward to Voice Mail](#)", 35) or to a *Pager*.
- You can deactivate call forwarding on no reply using *Menu > Activated features > Reset* Foxkey.
- You can also activate call forwarding on no reply by remote control, see Chapter "[Setting functions by remote control](#)", 50.

■ Forward to Voice Mail

You cannot momentarily be reached on your phone. If you activate Voice Mail, a subscriber can nonetheless leave you a message.

You can use the global greeting or your own greeting (see Chapter "[Configuring Voice Mail](#)", 62).

For more information on Voice Mail refer to the "Operating Instructions for the Ascotel Intelligate Voice Mail Systems".

Menu



Press the *Menu* Foxkey.

Forwarding



Scroll to *Forwarding* and press the *Select* Foxkey.

Call Forwarding
Unconditional



Scroll to *Call Forwarding* and confirm *Ok* with the Foxkey.

Voice Mail



Scroll to *Voice Mail* and confirm *Ok* with the Foxkey.
→ Forwarding to Voice Mail is activated.

Notes:

- You can specify whether your Voice Mail should answer directly (*Call Forwarding*) or with a delay (*Call Forwarding on No Reply*), or only if you are already on the phone (*Call Forwarding Busy*).
- You can deactivate forwarding using *Menu > Activated features > Reset* Foxkey.
- A new Voice Mail message is signalled with a text message on the display and a lit indicator LED in the idle state.

■ Forwarding to a message

You cannot be reached on your phone. You want any internal subscriber who calls you to get a message. The subscriber hears the busy tone and obtains a message on his display.

Requirement: The internal subscriber must have a phone capable of receiving messages. Subscribers whose phone cannot receive messages are put through to your phone or rerouted to a destination predefined within the system.

You can use one of the text messages stored in the system directly, modify it or create a new message.

Menu



Press the *Menu* Foxkey.

Forwarding



Scroll to *Forwarding* and press the *Select* Foxkey.

Call Forwarding
Unconditional



Scroll to *Call Forwarding* and confirm *Ok* with the Foxkey.

Message



Scroll to *Message* and confirm *Ok* with the Foxkey.

<Message>



Select one of the text messages stored in the system and press *Select* Foxkey.

<Text>



Adapt or expand the text and confirm *Ok* with the Foxkey.

→ Forwarding to message is activated.







Note:

If you activate another call forwarding unconditional, the message you have left on your phone will be deactivated.

■ Locking Your Phone

You need to leave your desk and want to ensure that no-one can alter your phone's settings, look at your private data, or make outside calls from your phone.

You can lock your phone with a PIN consisting of two to ten digits. You can modify the PIN using the menu (see Chapter "[Changing the PIN](#)", 57) or the */# procedure *47 (see "User's Guide */# Procedures as of I7.1").

- | | |
|--|--|
| <p>Menu
</p> | Press the <i>Menu</i> Foxkey. |
| <p>Settings
</p> | Scroll to <i>Settings</i> and press the <i>Select</i> Foxkey. |
| <p>General
</p> | Scroll to <i>General</i> and press the <i>Select</i> Foxkey. |
| <p>Lock
</p> | Scroll to <i>Barring</i> and press the <i>Modify</i> Foxkey.
→ You are prompted to enter your PIN. |
| <p><PIN>
</p> | Enter the PIN and confirm with the <i>Ok</i> Foxkey. |
| <p><Setting value>
</p> | Select the required type of barring and confirm <i>Ok</i> with the Foxkey.
→ The phone is now locked;  is displayed. |

Note:

You can bar either just the configuration (*Configuration barred*) or the entire phone (*Phone barred*). With *Phone barred* your private data cannot be viewed and external calls can only be made from your phone in accordance with the system settings.

■ Unlocking your phone

You want to unlock your phone.

You can use the PIN to unlock your phone. If you have forgotten your PIN, your system administrator can reset it to the factory setting.

Menu



Press the *Menu* Foxkey.

Activated features



Scroll to *Activated features* and press the *Select* Foxkey.

<Barring>



Select the barring you want and press the *Reset* Foxkey.
→ You are prompted to enter your PIN.

<PIN>



Enter the PIN and confirm with the *Ok* Foxkey.

Unlocked



Scroll to *Free* and confirm *Ok* with the Foxkey.
→ The phone is unlocked.

Organisation Within the Team

This section explains the different options provided by your phone to communicate in a team.

■ Using the Team Key

You and your team partners want to be reachable at all times as a team and be able to communicate with one another as quickly as possible.

By pressing a single key you can call a team partner or answer a call for anyone in the team.

When a team partner makes a call, the corresponding Team key lights up; this tells you when a team partner is busy. The Team key flashes to indicate that the team partner is receiving a call.

■ Calling a Team Partner

You want to call a team partner as quickly as possible.

Requirement: You have configured a configurable key as a Team key and stored the team partner's phone number under it (see Chapter "[Configuring Keys](#)", 63).



Press the Team key for the team partner.

→ The phone number and possibly the name of the team partner appear on the display. The team partner is called.

■ Substituting for a Team Partner

Your team partner is called. The Team key flashes. You know that your team partner is not at his desk at present and therefore decide to answer the call.

You can answer the call using the Team key. As soon as you have answered the call, your team partner is free again.



While the Team key is flashing:

Pick up the handset.

→ You hear the dialling tone.

Press the Team key.

→ You are through to the person who is calling your team partner.

Note:

Depending on the Team key's configuration, you are immediately connected with your team partner's caller as soon as you pick up the handset.

■ Starting an Announcement to a Team Partner

You want to tell a team partner something without waiting for a reply.

With the Team key you can initiate an announcement to a team partner.

Requirement: It is essential that the team partner has not barred his phone against announcement (for configuration see the Chapter "[Protect against Do not disturb/Call waiting/Intrusion/Announcement/Forward](#)", 59).



Initiating an announcement to a team partner using a handset:

Pick up the handset.

→ You hear the dialling tone.

<2x short>

Press the Team key for the team partner twice in quick succession.

→ You hear the acknowledgement tone. The display reads *Announcement:*
You can now talk.

<2x short>

Initiating an announcement to a team partner using hands-free mode:

Press the Team key for the team partner twice in quick succession.

→ You hear the acknowledgement tone. The display reads *Announcement:*
You can now talk.

Note:

Depending on the Team key's configuration, you are immediately connected with your team partner's caller as soon as you pick up the handset.

Functions for special situations

This section explains the different options provided by your phone to deal with special situations.

■ Deflect a call during the ringing phase

You do not want to answer a call yourself but deflect it to another subscriber.

With the function *Deflect* you can deflect calls to an internal or external subscriber or to the Voice Mail during the ringing phase.

Your phone is ringing and the indicator LED is flashing. To deflect the call, proceed as follows.

Deflection



Press the *Deflect* Foxkey.

<Phone number>



Enter the phone number and confirm with the *Ok* Foxkey.

→ The call is deflected to the desired subscriber.

Notes:

- You can also search in the phone book, last-number redial list or call list for the phone number of the person you are looking for.
- If the subscriber you want to deflect to is busy, the call will not be deflected. The display reads *Busy* and your phone still rings.

■ Reject a call during the ringing phase

You do not want to answer a call.

You can reject a call already during the ringing phase

Reject



Press Foxkey *Reject* or End key.

→ The connection is rejected and the caller obtains the busy tone.







■ Send text messages

You want to send a written message to an internal subscriber.

You can send a text message to an internal subscriber. The text message will appear on the person's display.

Requirement: The internal subscriber must have a phone capable of receiving messages.

You can use one of the text messages stored in the system directly, modify it or create a new message.

<p>Menu </p>	<p>Press the <i>Menu</i> Foxkey.</p>
<p>Text message </p>	<p>Scroll to <i>Text message</i> and press the <i>Select</i> Foxkey.</p>
<p>New </p>	<p>Scroll to <i>New</i> and press <i>Select</i> Foxkey.</p>
<p><Message> </p>	<p>Select one of the text messages stored in the system and press <i>Select</i> Foxkey.</p>
<p><Text> </p>	<p>Adapt or expand the text and press the <i>Send</i> Foxkey.</p>
<p><Destination> </p>	<p>Select the destination and press the <i>Select</i> Foxkey.</p>
<p><Phone number> </p>	<p>For subscriber and group: Enter the call number and press the <i>Send</i> Foxkey. → The message is sent.</p>

Note:

If the display reads *Not available*, the message could not be sent.

■ Read text messages

Your display shows *New message* and the envelope symbol. The right-hand indicator LED is lit.

Show



Press the *Show* Foxkey.

→ The display shows the sender and the date/time of the text message.

Read



Read Message:

Select the message you want and press the *Read* Foxkey.

→ If the message runs over several lines, use the navigation key to scroll.

Delete



To delete the message:

Press the *Delete* Foxkey.

→ The message is deleted; the next message is retrieved from the memory.

Or:

- Press the *Menu* Foxkey.
- Scroll to *Text message* and press the *Select* Foxkey.
- Scroll to *Inbox* and press the *Select* Foxkey. Continue as described above.

■ Picking up a call

You hear a phone ringing in your vicinity and want to pick up the call.

With the *Pick up* function you can pick up the call from the other phone on your own phone.

Menu



Press the *Menu* Foxkey.

Call features



Scroll to *Call features* and press the *Select* Foxkey.

Pick-up



Scroll to *Pick up* and confirm *Ok* with the Foxkey.

Subscriber



Scroll to *Subscriber* and confirm *Ok* with the Foxkey.

→ The display shows the number of the phone from which you last picked up a call.

<Phone number>



Enter the number of the phone from which you want to pick up the call and confirm with the *Ok* Foxkey.

→ You are now through to the caller.

■ Using the DTMF Mode. Activating/deactivating DTMF

You want to be able to use your phone to control other equipment or to access certain services, such as remote polling of an answering machine or telebanking. For these services you need the DTMF mode.

In the DTMF mode each key press generates a tone. If for example you key in a call number during a call, your call partner will hear the tone signals.

You can specify whether the DTMF mode should be generally activated or deactivated (see Chapter "Configuring the DTMF mode", 56). DTMF is activated as the default dialling mode.

If the DTMF mode is generally deactivated, you can activate it and deactivate it again temporarily during a call.

DTMF



You're in a call and the DTMF mode is generally deactivated. You want to activate the DTMF mode temporarily.

Press the *DTMF* Foxkey.

→ The display shows *Enter number DTMF*. You can now enter the DTMF characters.

Reset



Resetting DTMF mode:

Press the *Reset* Foxkey.

Note:

When you hang up, the DTMF mode is automatically deactivated again.

■ Making a call on a third-party phone

You want to make a call on a third-party phone using your personal settings, for example on a colleague's phone or in a meeting room.

You can activate a third-party phone to make an internal or external call using your personal settings, even if the phone is locked for external calls.

You can activate the phone for a business or private call.

Once you have activated the phone using a */# procedure and your PIN, dialling by your private phone book is available.

The called party's display shows your personal phone number and not the number of the phone from which you are making your call.

Any call charges incurred will be charged to you.



Enter #36.

Enter your internal phone number.

Enter your PIN.

Enter the internal or external phone number with the exchange access digit.



Pick up the handset.

→ The phone number displayed is dialled.

Note:

When you hang up, dialling by name and your private phone book remain available for a whole minute so you can make another call.

Or:

- Enter #46 for a private call.
- Enter your internal phone number.
- Enter your PIN.
- Enter the external call number directly, without the exchange access digit.
- Pick up the handset.

→ The phone is now enabled; the external subscriber is called.

Note:

The factory setting "0000" is not accepted. First modify the PIN (see Chapter "Changing the PIN", 57) or use the */# procedure *47 (see "User's Guide */# Procedures as of 17.1"). If you have forgotten your PIN, your system administrator can reset it to the factory setting.

■ Paging an Internal Subscriber

You are unable to reach an internal subscriber and thus want to page them.

If the system is equipped with a paging system (PS), the person can be paged. The paged person can answer from any phone.

- Menu 

Press the *Menu* Foxkey.
- Call features 

Scroll to *Call features* and press the *Select* Foxkey.
- Page 

Scroll to *Seach* and confirm *Ok* with the Foxkey.
- <Phone number> 

Enter the phone number f the person to be paged and confirm with the *Ok* Foxkey.
 → The person is paged and sees your phone number on the pager.

■ Answering a Pager

Your pager is ringing and shows the phone number of the person trying to reach you.

You can answer from any internal phone.

- Menu 

Press the *Menu* Foxkey.
- Call features 

Scroll to *Call features* and press the *Select* Foxkey.
- Pick-up 

Scroll to *Pick up* and confirm *Ok* with the Foxkey.
- Pager 

Scroll to *Pager* and confirm *Ok* with the Foxkey.
- <Phone number> 

Enter your own phone number and confirm with the *Ok* Foxkey.
 → You are now connected with the person who is trying to reach you.

Note:
 You can also answer a pager with the */# procedure *82.

■ Answering a General Bell

Via the general bell, you hear either your personal ringing pattern or the general ringing signal. Calls with the general bell as the destination can be signalled visually or acoustically via an external piece of supplementary equipment. The call can be answered on any terminal.

Ask your system administrator whether a general bell is set up.

You can answer from any internal phone.

Menu



Press the *Menu* Foxkey.

Call features



Scroll to *Call features* and press the *Select* Foxkey.

Pick-up



Scroll to *Pick up* and confirm *Ok* with the Foxkey.

General bell



Scroll to *General bell* and confirm *Ok* with the Foxkey.

<Phone number>



Enter your own phone number and confirm with the *Ok* Foxkey.
→ You are now connected with the person who is trying to reach you.

Note:

You can also answer a general bell with the */# procedure *83.

■ Activating/Deactivating a Discreet ring

You do not want to be disturbed by your phone ringing. However, you do not want to switch off your phone.

Discreet ringing is available on your phone as an alternative to the usual ringing. If discreet ring is activated, the phone rings only once.

This function must be stored under a Foxkey or a function key (see Chapter "[Configuring Keys](#)", 63).



In the idle state:

Press the function key for *<Discreet ring>*.

■ Suppressing your call number from your called party's terminal display

You do not want your call number to appear on the terminal display of a called party in the public network.

You have two possibilities:

- If you never want the phone number to be displayed, set *CLIR permanently*.
- To suppress your call number display for certain calls only, select the function *CLIR per call* before dialling your party's call number.

This function must be stored under a Foxkey or a function key (see Chapter "Configuring Keys", 63).

You can also execute the function with a */# procedure (see "User's Guide */# Procedures as of 17.1").



Before the call:

Press the function key for <CLIR>.

Notes:

- CLIR works only with external calls.
- This feature depends on the range of services offered by your provider.

■ Tracing Malicious Calls

You are being threatened or molested by a call. You want to identify the caller.

Using the MCID function (*MCID*: Malicious Call Identification), the provider records the following call data: Your phone number, the caller's phone number, and the date and time of the call.

MCID has to be enabled by your provider. Your provider will inform you about accessing the recorded call data.

This function must be stored under a Foxkey or a function key (see Chapter "Configuring Keys", 63).



During a call:

Press the function key for MCID (*MCID*).



After the call do not hang up: press the function key for MCID (*MCID*) while you hear the busy tone.

Line Keys

This section explains the different options provided by your phone, if your system administrator has assigned you one or more configurable keys as Line keys. Line keys turn your phone into a key phone.

A line has a number which can be used to make an external or internal call. One or usually several phones can be connected to this line, for example, in a travel agent's all the staff assigned to handling Europe as a travel destination. A Line key has an LED to indicate the line's status and lets you answer calls on that line.

If your phone has one or more line keys, the configurable key at the very top is always your personal line key.

■ Answering a Call on a Line Key

You are called on one or more Line keys. The line key(s) flash rapidly. You want to answer the call on one of the Line keys.

To decide which call to answer on which Line key, simply press one of the Line keys. If you pick up the receiver without pressing a Line key, you are connected with the call on the line with the highest priority.



Pick up the handset.

→ Connection with the line with the highest priority.

Or:

- Press the Line key.

→ The line is selected.

- Pick up the handset.

→ Connection with the selected line.

Notes:

If you keep the line key pressed down for approx. 2 seconds while it is lit, the caller's phone number is displayed.

■ Phoning over a Line Key

You want to make a call via a Line key.

You can make a call via any free Line key. Each Line key has its own phone number; in other words when you make a phone call you transfer the phone number belonging to the active Line key.

The call charges are recorded separately for each Line key.



Enter the person's phone number.



Press a free Line key.

→ The Line key lights up. The line is selected.



Pick up the handset.

→ The person is called.

Note:

Depending on the configuration of a line key the caller is called directly in hands-free mode.

■ Parking a Call Partner on a Line Key

You are connected with your call partner via a Line key and decide to park the party.

You can park your call partner on the current Line key.

Park



Press the *Park* Foxkey.

→ The Line key flashes slowly.



To retrieve a parked call party:

Press the relevant line key.

→ You are now back through to the parked call partner.

■ Switching active lines

You are in a call and want to answer a call on another Line key or make a call.

You can switch lines by pressing a key. The active call is automatically parked locally.



Parking the call and switching lines:

Press the Line key you want.

→ The active call is parked. The call on the selected line is activated.



To retrieve a parked call:

Press the relevant line key.

→ The parked call is reactivated.

Note:

You cannot take a call on a line between two other call parties by pressing the corresponding Line key.

Setting functions by remote control

This section explains how you can alter your phone's settings even if you are not directly at your phone.

You are not at your desk and want to set various functions on your phone from a different phone.

You can activate/deactivate many of your phone's functions by remote control from a different phone.

The remote control is initiated using a special */# procedure. You can then enter the function commands and */# procedures in the usual way.



Using remote control from a third-party phone:

Enter */# procedure 36.
Enter your phone number.
Enter your PIN.



Enter the */# procedure for activating/deactivating the function you want.



Pick up the handset.
→ You hear the acknowledgement tone.



Put the handset on-hook.
→ The function is now activated/deactivated.

Note:

The factory setting "0000" is not accepted. First change the PIN as described in the Chapter "[Changing the PIN](#)", 57 or using the */# procedure *47 (see "User's Guide */# Procedures as of 17.1"). If you have forgotten your PIN, your system administrator can reset it to the factory setting.

Personalizing Your Phone

These sections explain how to adapt the phone's basic settings to suit your personal requirements.

<i>Display</i>	52
<i>Setting the Ringing Properties (Audio)</i>	52
<i>Hands-free and headset settings</i>	54
<i>General settings</i>	56
<i>Protection</i>	59
<i>Phone Book Management</i>	60
<i>Configuring Voice Mail</i>	62
<i>Configuring Keys</i>	63
<i>Configuring Line Keys</i>	68
<i>Formulating Functions</i>	69
<i>Local settings</i>	70





Display

This section explains how to set display properties.

■ Setting the display

You may find the display is too bright or too dark.

You can adjust the display contrast.

- | | |
|---|--|
|  | Press the <i>Menu</i> Foxkey. |
|  | Scroll to <i>Settings</i> and press the <i>Select</i> Foxkey. |
|  | Scroll to <i>Display</i> and press the <i>Select</i> Foxkey. |
|  | Scroll to <i>Display contrast</i> and press the <i>Modify</i> Foxkey. |
|  | Select the required setting and confirm with the <i>Ok</i> Foxkey.
→ The setting is stored. |



Setting the Ringing Properties (Audio)

This section explains how to set your phone's ringing tone properties.

■ Setting the ringing volume during ringing

You want to adjust the ringing volume.

You can adjust the ringing volume while the phone is ringing.

- | | |
|---|---------------------------|
|  | Quieter: Press the --key. |
|  | Louder: Press the ++key. |

■ Setting the Volume during a Call

You want to adjust the volume while in a call.

This automatically adjusts the volume of the handset and loudspeaker.

The new volume will remain stored even after the call is ended.

—|+ Quieter: Press the —key.

—|+ Louder: Press the +key.

■ Setting the Ringing Properties

You want to change the way in which your phone rings.

You can set the ringing volume, ringing speed, and ringing melody.

Menu



Press the *Menu* Foxkey.

Settings



Scroll to *Settings* and press the *Select* Foxkey.

Audio



Scroll to *Audio* and press the *Select* Foxkey.

<Audio setting>



Scroll to the required audio settings and press the *Modify* Foxkey.

<Setting value>



Select the required setting and confirm with the *Ok* Foxkey.
→ The setting is stored.

Note:

To list to all the settings, use the *Test* Foxkey.

Hands-free and headset settings

This section explains other ways in which you can make calls with your phone.

■ Automatic Hands-Free Mode

You want to answer a call without picking up the handset or pressing a key.

You can choose whether your phone should immediately and automatically activate hands-free operation after one ring, for internal calls or announcements.

Menu



Press the *Menu* Foxkey.

Settings



Scroll to *Settings* and press the *Select* Foxkey.

Audio



Scroll to *Audio* and press the *Select* Foxkey.

Autom. Hands-free



Scroll to *Automatic hands-free* and press the *Modify* Foxkey.

<Setting value>



Select the setting value for which you want to switch automatically to hands-free and confirm *Ok* with the Foxkey.

→ The setting is stored.

■ To activate headset operation

You have connected a headset and now want to activate the headset mode.







A headset can be connected in parallel with the handset. You can switch the headset mode on and off.

If you answer a call in headset mode using the Call key or Loudspeaker key, the call is provided on the headset. Alternatively you can also answer the call by picking up the handset.

This phone supports wireless headsets based on the DHSG standard, which allows you to set up and to end calls from the headset. Ask your dealer which headsets are particularly well suited for this phone.

Note:

To find out how to make phone calls with the headset, refer to the Chapter ["Using a Headset", 12](#).

- | | |
|---|--|
| <p>Menu
</p> | <p>Press the <i>Menu</i> Foxkey.</p> |
| <p>Settings
</p> | <p>Scroll to <i>Settings</i> and press the <i>Select</i> Foxkey.</p> |
| <p>Audio
</p> | <p>Scroll to <i>Audio</i> and press the <i>Select</i> Foxkey.</p> |
| <p>Headset
</p> | <p>Scroll to <i>Headset</i> and press the <i>Modify</i> Foxkey.</p> |
| <p><Setting value>
</p> | <p>Activate/deactivate the headset mode and confirm with the <i>Ok</i> Foxkey.
→ The microphone is now deactivated,  is displayed.</p> |



General settings

This section explains other settings you can make on your phone.

■ Selecting the Language





The display text is not in the language you want.

You can select a different language. The menu item under which you select your language is marked by an "*" in front of the word for "language" in the language of your choice, e.g. "*Language" for English.

- Menu
 Press the *Menu* Foxkey.
- <*Language>
 Scroll to **Language* and press the *Modify* Foxkey.
→ The set language is displayed with .
- <Setting value>
 Select the required language and confirm with the *Ok* Foxkey.
→ The display text appears in your selected language.

■ Configuring the DTMF mode

You want to decide whether the DTMF mode is to be activated or deactivated as default on your phone.







- Menu
 Press the *Menu* Foxkey.
- Settings
 Scroll to *Settings* and press the *Select* Foxkey.
- General
 Scroll to *General* and press the *Select* Foxkey.
- DTMF
 Scroll to *DTMF* and press the *Modify* Foxkey.
- <Setting value>
 Activate or deactivate DTMF and confirm *Ok* with the Foxkey.
→ The setting is stored.

■ Changing the PIN

You want to change the PIN used to lock/unlock your phone (see Chapter "Locking Your Phone", 37 and "Unlocking your phone", 38).

The factory setting is digit combination "0000"; you can select any 2 to 10-digit combination for your new PIN.

If you have forgotten your PIN, your system administrator can reset it to the factory setting.

	<p>Press the <i>Menu</i> Foxkey.</p>
<p>Settings</p> 	<p>Scroll to <i>Settings</i> and press the <i>Select</i> Foxkey.</p>
<p>General</p> 	<p>Scroll to <i>General</i> and press the <i>Select</i> Foxkey.</p>
<p>PIN</p> 	<p>Scroll to <i>PIN</i> and press the <i>Modify</i> Foxkey. → The display reads <i>Old PIN</i>.</p>
<p><PIN></p> 	<p>Enter the old PIN and confirm with the <i>Ok</i> Foxkey. → The display reads <i>New PIN</i>.</p>
<p><PIN></p> 	<p>Enter the new PIN and confirm with the <i>Ok</i> Foxkey. → The display reads <i>Confirm</i>.</p>
<p><PIN></p> 	<p>Enter the new PIN a second time and confirm with the <i>Ok</i> Foxkey. → The new PIN is stored.</p>





Notes:

- For each digit entered, the display shows an "*".
- You can also modify the PIN using */# procedure *47 (see "User's Guide */# Procedures as of 17.1").

■ Entering the Display Text for the Idle State

You want to change the text displayed by your phone in the idle state.

In addition to the date and/or time you can enter a personal text for the text displayed in the idle state.

- Menu
 Press the *Menu* Foxkey.
- Settings
 Scroll to *Settings* and press the *Select* Foxkey.
- General
 Scroll to *General* and press the *Select* Foxkey.
- Idle text
 Scroll to *Idle text* and press the *Modify* Foxkey.
- <Text>
 Enter the text and confirm with the *Ok* Foxkey.
→ The text is stored.

Notes:

- The text mode for letter input is automatically activated.
- You can use the Correction key to delete any incorrect character.

Protection

This section explains how you can protect yourself against certain types of call.

■ Protect against Do not disturb/Call waiting/Intrusion/Announcement/Forward

You want to protect yourself against certain types of calls.

You can set your phone so that these functions are not permitted on it. Ask your system administrator whether these functions are enabled on the system.

Menu



Press the *Menu* Foxkey.

Settings



Scroll to *Settings* and press the *Select* Foxkey.

Protection



Scroll to *Protection* and press the *Select* Foxkey.

<Protection setting>



Scroll to the required protection settings and press the *Modify* Foxkey.

<Setting value>



Select the required setting and confirm with the *Ok* Foxkey.
→ The setting is stored.

Note:

You can deactivate an activated protection using *Menu* > *Activated features* > Foxkey *Reset*.

Phone Book Management

This section explains how to create a new entry in the phone book and how to edit or delete an entry.

■ Creating a New Phone Book Entry

You want to store your own phone numbers.

You can store your own phone numbers in the private phone book.



Press the phone book key.

Modifying contacts



Scroll to *Modify contact* and press the *Select* Foxkey.

New



Press the *New* Foxkey.

Name



Select *Name* and press the *Modify* Foxkey.

<Name>



Enter the subscriber's name and confirm with the *Ok* Foxkey.
→ The name is now stored.

Number



Select *Number* and press the *Modify* Foxkey.

<Phone number>



Enter the subscriber phone number and confirm with the *Ok* Foxkey.
→ The phone number is now stored.

Notes:

- The text mode for letter input is automatically activated.
- You can use the Correction key to delete any incorrect character.

■ Modifying or deleting a phone book entry

You want to modify a phone number stored on your private phone book.

Note:

You cannot modify entries in other phone books.



Press the phone book key.

Modifying contacts



Scroll to *Modify contact* and press the *Select* Foxkey.

<Entry>

To change an entry:

Select the entry you want and press the *Edit* Foxkey.

→ The display shows the current name.



<Name>

Press the *Modify* Foxkey, modify the name, and confirm with the *Ok* Foxkey.

→ The display shows the current phone number.



<Phone number>

Press the *Modify* Foxkey, modify the phone number, and confirm with the *Ok* Foxkey.

→ The data is now stored.



<Entry>

To delete an entry:

Select the entry you want and press the *Delete* Foxkey.

→ The entry is now deleted.



Notes:

- The text mode for letter input is automatically activated.
- You can use the Correction key to delete any incorrect character.

Configuring Voice Mail

This section explains how to set your Voice Mail.

■ Personal greeting

You have the possibility of recording up to three different greetings. If no personal greeting is activated or if none is available, the global greeting is activated automatically, provided it has been recorded. For more information contact your system administrator.

Menu



Press the *Menu* Foxkey.

Voice Mail



Scroll to *Voice Mail* and press the *Select* Foxkey.

<Greeting>



Recording a greeting:

Select the greeting you want and press the *Record* Foxkey.

→ Now record your personal greeting text.

Note:

You can improve the quality by recording the text through the handset.

<Greeting>



Listening to the greeting:

Select the greeting you want and press the *Listen* Foxkey.

→ You can monitor your personal greeting text and re-record it if necessary.

<Greeting>



Selecting the greeting:

Select the greeting you want and confirm with the *Ok* Foxkey.

→ The announcement last recorded is automatically activated.

Notes:

- To find out how to configure call forwarding to your Voice Mail, refer to the Chapter "[Forward to Voice Mail](#)", 35.
- More information on Voice Mail can be found in the "Operating Instructions for the Ascotel Intelligate Voice Mail Systems".

Configuring Keys

This section explains how to assign phone numbers and functions to a configurable key.

■ Available keys

You can store phone numbers or functions under two different keys:

- a configurable key – accessible at all times
- directly on the Foxkey itself – retrievable only in the idle state

You can assign each key with a specific type so you can trigger a particular action by simply pressing that key. Choice available:

- Number key – stores phone number
- Function key – activates / deactivates function
- Team key – organisation within the team
- Setting up a line key – key phone (line keys must be set up by your system administrator).

■ Storing a Phone Number under a Key – Number Key

You want to retrieve a frequently used phone number with a single keystroke rather than enter it digit by digit.

You can store a phone number including the associated name under any configurable key and the Foxkey. The key automatically becomes a number key.

Each configurable key is assigned 2 memory locations allowing you to store 2 phone numbers under a single configurable key.



To store a phone number under a configurable key:

Press the key and hold it down for a moment.

→ Display shows choice of key types.

Menu



To store a phone number under the Foxkey:

Press the *Menu* Foxkey.

Settings



Scroll to *Settings* and press the *Select* Foxkey.

Keys



Scroll to *Keys* and press the *Select* Foxkey.

Foxkey



Scroll to *Foxkey* and press the *Select* Foxkey.

→ Display shows choice of key types.



Select the Foxkey you want.

Note:

From here onwards the steps for storing under a configurable key and storing under the Foxkey are identical.

Number key



Scroll to *Number key* and press the *Select* Foxkey.

→ The display shows the current phone number.

<Phone number>



Press the *Modify* Foxkey, enter or modify the phone number, and confirm with the *Ok* Foxkey.

→ The display shows the current name.

<Name>



Press the *Modify* Foxkey, enter or modify the name, and confirm with the *Ok* Foxkey.

→ The first allocated function is now stored.

<Phone number>



Press the *Modify* Foxkey, enter or modify the phone number, and confirm with the *Ok* Foxkey.

→ The display shows the current name.

<Name>



Press the *Modify* Foxkey, enter or modify the name, and confirm with the *Ok* Foxkey.

→ The second allocated function is now stored.

Notes:

- The text mode for letter input is automatically activated.
- You can use the Correction key to delete any incorrect character.

■ Storing a Function under a Key – Function Key

You want to retrieve a frequently used function - for example "call forwarding on no reply" - using a single keystroke rather than having to enter it by hand. Usually the function is assigned so that you:

- activate the function with the first keystroke - LED lit,
- and deactivate the command again with a second keystroke - LED off.

<long>



To store a function under a configurable key:

Press the key and hold it down for a moment.

→ Display shows choice of key types.

Menu



Storing a function under the Foxkey:

Press the *Menu* Foxkey.

Settings



Scroll to *Settings* and press the *Select* Foxkey.

Keys



Scroll to *Keys* and press the *Select* Foxkey.

Foxkey



Scroll to *Foxkey* and press the *Select* Foxkey.

→ Display shows choice of key types.



Select the Foxkey you want.

Note:

From here onwards identical steps for storing under a configurable key and storing under the Foxkey.

Function key



Scroll to *Function key* and press the *Select* Foxkey.

→ The display shows the function currently set.

<Function>



Select the function you want and press the *Select* Foxkey.

→ The further prompting depends on the function (see Chapter "[Supplementary features](#)", 19). Once you have made all the settings, the function is stored under the key.

Note:

Besides the predefined functions you can also define your own function. For more information please refer to the Chapter "[Function Commands](#)", 69.

■ Storing a Team Partner under a Key – Team Key

Together with other members you wish to organise yourself into a team so that on the one hand you can always be reached as a team and, on the other, to ensure mutual substitution. You can configure a configurable key as a Team key and then assign it to a team partner. One team key is configured for each team member, allowing you:

- to call one another with a single keystroke;
- to answer an incoming call for another team member with a single keystroke;
- and to select whether the flashing team key should be complemented by a ringing tone whenever a team partner is called. You can configure a ringing delay for the ringing tone;
- to choose between answering directly using automatic hands-free operation, picking up the handset, and pressing the Team key.

The following audio settings are possible: ringing, ringing melody, ringing signal speed, answering mode.

To find out how to use a Team key, refer to the Chapter "[Using the Team Key](#)", 38.

Note:

A team key can only be allocated to a configurable key.



Press the configurable key and hold it down for a moment.
→ Display shows choice of key types.



Scroll to *Team key* and press the *Select* Foxkey.
→ The display shows the current phone number.

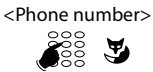

Enter or modify the phone number and confirm with the *Ok* Foxkey.
→ The display shows the properties with which you can configure the team key.



Scroll to the required audio settings and press the *Modify* Foxkey.



Select the required setting and confirm with the *Ok* Foxkey.
→ The setting is stored.

Note:

- Setting possibilities for ringing: *Off* for no ringing tone, *On* for instant ringing tone, and ringing tone *Del 10s*, *Del 20s* and *Del 30s* and confirm *Ok* with the Foxkey.
- You can listen to each setting using the *Test* Foxkey.



Setting the answering mode:

Scroll to *Answer* and press the *Modify* Foxkey.

<Setting value>



Changing the settings used to answer a call: *Key* to answer the call by pressing the line key, *Handset* to answer by picking up the handset, and *Hands-free* to answer automatically with hands-free, and confirm *Ok* with the Foxkey.

→ The setting is stored.

Notes:

- The *Handset* and *Hands-free* settings only work when the ringing signal is activated.
- If you select answer using *Handset* or *Hands-free*, you must also specify the *Priority*, with 1 being the highest priority, and 8 the lowest:

Priority



Setting the priority:

Select the priority you want from 1 to 8 and confirm with the *Ok* Foxkey.

→ The setting is stored.

■ Clearing a Key

You want to clear the assignment made to a configurable key.

The *No function* function is provided specifically for this purpose.

<long>



To clear a configurable key:

Press the configurable key and hold it down for a moment.

→ The display shows the key type.

<long>



To clear the Foxkey:

Press the Foxkey with a long keystroke.

→ The display shows the key type.

No function



Scroll to *No function* and confirm *Ok* with the Foxkey.

→ The key configuration is cleared.

Configuring Line Keys

This section explains how to adapt your Line key settings to suit your personal requirements.

Your system administrator will determine whether your phone has Line keys.

■ Setting the Response of a Line Key

You want to set the response of a Line key in case you are called on that Line key.





You can choose whether you also want a ringing signal in addition to the flashing Line key when you receive a call on a Line key. You can configure a ringing delay for the ringing tone.

To answer a call you can choose between answering directly by pressing the Team key, picking up the handset, and using automatic hands-free operation.

Answering an external call using automatic hands-free operation is not available.

The following audio settings are possible: ringing, ringing melody, ringing signal speed, answering mode.

To find out how to use a line key, refer to the Chapter "[Phoning over a Line Key](#)", 49.

-  <long> Press the Line key you want and hold it down for a moment.
→ The display shows the line key and the properties with which you can configure the line key.
Note:
The Personal key is also treated as a line key.
- <Audio setting>
 Scroll to the required audio settings and press the *Modify* Foxkey.
- <Setting value>
 Select the required setting and confirm with the *Ok* Foxkey.
→ The setting is stored.
Note:
- Setting possibilities for ringing: *Off* for no ringing tone, *On* for instant ringing tone, and ringing tone *Del 10s*, *Del 20s* and *Del 30s* and confirm *Ok* with the Foxkey.
 - You can listen to each setting using the *Test* Foxkey.
- Setting the answering mode:**
Scroll to *Answer* and press the *Modify* Foxkey.
- Answer**
 Change the settings used to answer a call: *Key* to answer the call by pressing the line key, *Handset* to answer by picking up the handset, and *Hands-free* to answer automatically with hands-free, and confirm with the *Ok* Foxkey.
→ The setting is stored.
- <Setting value>

Notes:

- The *Handset* and *Hands-free* settings only work when the ringing signal is activated.
- If you select answer using *Handset* or *Hands-free*, you must also specify the *Priority*, with 1 being the highest priority, and 8 the lowest:



Setting the priority:

Select the priority you want from 1 to 8 and confirm with the *Ok* Foxkey.
 → The setting is stored.

Formulating Functions

This section explains how to activate an individual function, for example call forwarding unconditional, with the aid of function commands and how to assign it to a key.

■ Function Commands

You can use function commands to define a function to suit your personal requirements. A function can consist of one or more function commands, function codes, and the phone number. You can either carry out a function directly or store it under a function key (select *configurable* function).

Tab. 1 The following function commands are available:

"A"	Seize line with highest priority
"I"	Seize line
"X"	Disconnect
"P"	Pause 1 second before the next operation
"Lxx"	Seize line xx (Line keys)
"N"	Use the phone number entered in call preparation
."	Control key function (up-circuit system)
"Z"	Activate/deactivate DTMF mode
"R"	Use the phone number last dialled
"Y"	Disconnect and reseat the line.

Tab. 2 Examples of how to define a function:

"IR"	Seize line ("I"), dial phone number last dialed ("R")
"I201"	Seize line ("I") and dial phone number 201
"I*21201X"	Seize line ("I"), activate call forwarding unconditional ("*21") to phone number 201, disconnect ("X")
	<p>Notes:</p> <ul style="list-style-type: none"> • Text mode has to be activated before you can enter function commands. • A list with all the */# procedures can be found at http://www.aastra.ch/doc-finder. • Functions that are not available via the menu can be activated using */# procedures (see "User's Guide */# Procedures as of I7.1"). • You can either type in a */# procedure directly or store it under a key. • You can only activate certain */# procedures if the same function cannot be obtained via the menu. • The availability of certain */# procedures may be restricted depending on the system and software version.

Local settings

This section provides a short description of the IP-relevant settings.

■ IP settings

The IP-relevant data for your phone is stored in this menu. The input of this data is password-protected; it can therefore only be carried out by your system administrator. You can however call up the data.

- Menu



Press the *Menu* Foxkey.
- Settings



Scroll to *Settings* and press the *Select* Foxkey.
- General



Scroll to *General* and press the *Select* Foxkey.
- Local settings



Scroll to *Local settings* and press the *Select* Foxkey.
→ IP-relevant settings retrievable.

Further information

The following sections contain more useful information about your phone.

<i>Troubleshooting</i>	72
<i>Declaration Open Source Software</i>	73
<i>Liability</i>	73

Troubleshooting

This section contains a few tips on how to operate your phone if you encounter any problems.

■ Malfunctions

Your call partner cannot hear you or you cannot hear your call partner

Make sure the handset cord is correctly plugged into both the handset and the phone (see Chapter "Installation and First-Time Operation", 74).

Handset off-hook, no dialling tone, no display

Make sure the phone cord is correctly plugged in to both the phone and the LAN socket (see Chapter "Installation and First-Time Operation", 74).

Display reads "Not configured", handset off-hook, no dial tone

Your phone has not been assigned a call number. Contact your system administrator.

The display reads: "Trying to register"

The telephone cannot be registered. Contact your system administrator.

Display is working, but connection is not possible

Your phone may be locked. Unlock your phone (see Chapter "Unlocking your phone", 38).

Freely configurable keys cannot be configured.

The configuration may be locked. Unlock your phone (see Chapter "Unlocking your phone", 38). The key for a reconfiguration may be barred in the system. Contact your system administrator.

Insufficient display contrast

The setting for the display contrast is inadequate. Change the setting (see Chapter "Setting the display", 52).

Impaired sound quality during hands-free operation

The sound quality can be affected if the volume is too loud – turn down the volume. If the sound quality fluctuates, contact your system administrator.

Note:

For all other messages, faults and questions you may have, contact your system administrator.

Declaration Open Source Software

■ About Open Source Software

This product contains Open Source Software from third-party suppliers subject to the GNU licence provisions GPL (GNU General Public License) and LGPL (GNU Library/Lesser General Public License).

The licence texts for the GPL and LGPL and for the source code of the software sections listed below are available at <http://www.aastra.ch/docfinder> ("Public GNU source" document type).

The licence texts for the GPL and LGPL are also stored on the terminal itself and can be viewed using the integrated web interface (URL: <IP address of your system terminal>).

Please read through the text carefully to find out all you need to know about your rights with regard to the licences concerned.

This product contains the following software subject to GPL provisions:

- Linux kernel, available at <http://www.kernel.org/>.
- Busybox, available at <http://www.busybox.net/>.
- This product contains the following software subject to the LGPL provisions:
- uClibc, available at <http://www.uclibc.org/>

Liability

■ Disclaimer

This procedure was manufactured in accordance with ISO 9001 quality guidelines.

This product and the user information supplied with it have been produced with the utmost care. The product's functions have been tested and approved after comprehensive conformity tests. Nonetheless errors cannot be entirely excluded. The warranty is limited to the replacement of defective hardware.

The manufacturers shall not be liable for any direct or indirect damage that may be caused by incorrect handling, improper use, or any other faulty behaviour on the part of a product. Potential hazards are mentioned in the relevant places in the User Guides. Liability for loss of profit shall be excluded in any case.

Installation and First-Time Operation

These sections explain the setup options available with your phone.

<i>Equipment provided</i>	75
<i>Options</i>	75
<i>Setting up and mounting the phone</i>	76
<i>Connecting the phone</i>	78
<i>Office KBM expansion keypad (option)</i>	80
<i>Labelling Configurable Keys</i>	81

Equipment provided

Telephone



Handset



Handset cord

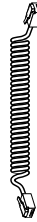

Stand rest; can also be used as a mounting frame for wall mounting

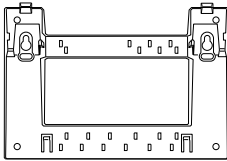

Quick User's Guide and safety information

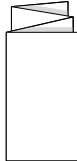

Options

Plug-in power adapter (if the power supply is not supplied via the LAN).

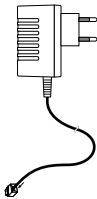

Office KBM expansion keypad

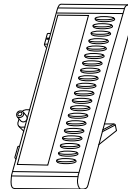

Setting up and mounting the phone

With the aid of the supplied stand rest you can set up the phone as a desktop phone or mount it to the wall.

■ Setting the phone up as a desktop phone

You can set up the phone either at a 40° or a 25° angle. To do so, insert the stand rest in different positions into the back of the phone until it snaps into place.

- Insert the stand rest as indicated on the installation diagram until it snaps into place.
- Connecting the handset: Plug the connector on the shorter straight extremity of the handset cord into the socket on the handset. Plug the connector at the loose extremity of the cord into the handset socket on the underside of the phone. To relieve the strain on the cable feed the cable through one of the cable guides on the stand rest.
- Connect the phone as indicated in the Chapter "[Connecting the phone](#)", 78.

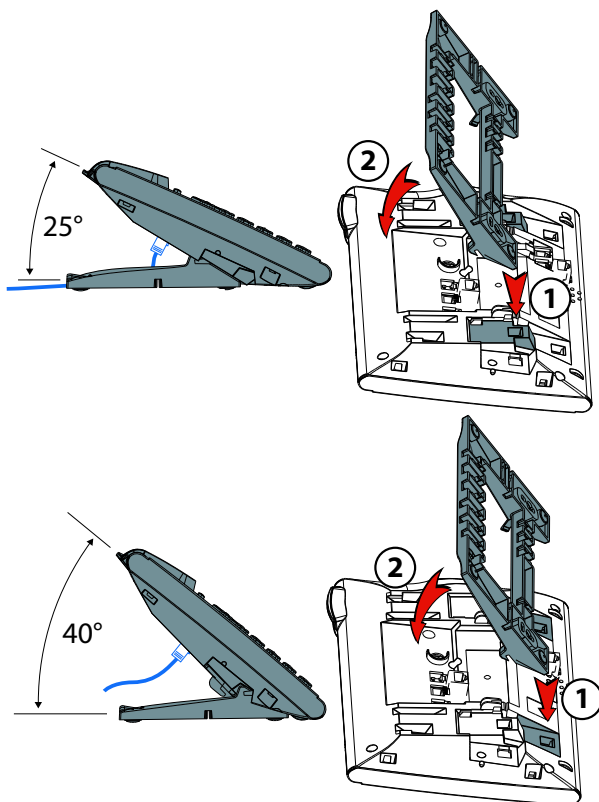

■ Wall mounting

You can also mount the phone on the wall. To do so, screw the stand rest onto the wall as a bracket and hook the phone onto the stand rest.

Notes:

- As there is only a limited amount of space between the sockets on the back of the phone and the wall on which it is mounted, you need to use a ribbon cable with a short connector for the cord. Ask your dealer for a list of suppliers for a suitable ribbon cable.
 - You can only connect one Office KBM expansion keypad (option) if the phone is wall-mounted.
- Fit the screws for securing the stand rest and mount the stand rest (Figure A).
 - Connect the handset cord and the phone cord to the phone (Figure B). For the correct connection assignment refer to the Chapter "[Connecting the phone](#)", 78.
 - Insert the phone into the stand rest horizontally (Figure C-1) and slide downwards (Figure C-2).
 - Unscrew the cams for holding the handset (Figures D-1 to D-3).
 - Insert the handset.

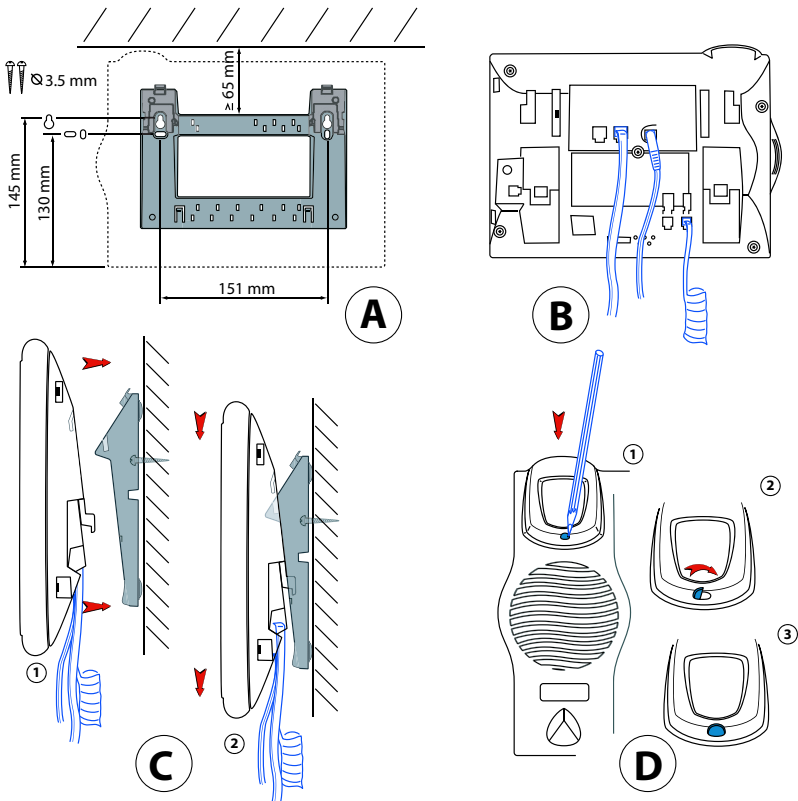

■ Dismantling

Desktop phone:





- Disconnect the phone cord and remove.
- Carefully pull the stand rest away in the opposite direction.

Wall set:

- Carefully slide the phone upwards out of the stand rest.
- Disconnect the phone cord and remove.

Connecting the phone

■ Connections

LAN	Connecting to the IP network
PC X	Connecting a PC (if required)
	Connecting the handset
	Connecting the headset
	Connecting the power supply
	Connection for Office KBM expansion keypad
	Connection on the Office KBM expansion keypad

Note:

Your system administration will take care of the IP addressing and the commissioning of the phone. The IP addresses and other information about your phone is available in the setting mode.

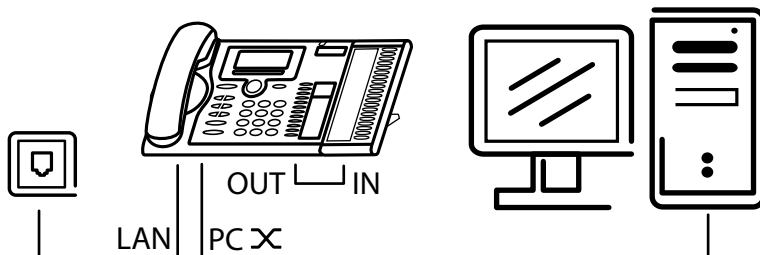

■ Connecting your phone to the LAN

This phone communicates via the same connection as your PC (IP network / LAN). This means you do not need a special phone connection. Ask your system administrator if you have any doubts about your phone's connection.

- Connecting the LAN cord (not included in the scope of delivery) to a LAN socket.
- Plug the connector at the loose end on the underside of the phone into the LAN socket.
- Desktop installation only: To relieve the strain on the cable feed the cable through one of the cable guides on the stand rest.

■ Connecting your PC to the LAN

If required, you can connect your PC or another LAN device to the phone, for example a printer.

- Connecting the LAN cord (not included in the scope of delivery) to the PC's network socket.
- Plug the connector at the loose end on the underside of the phone into the PC socket.
- Desktop installation only: To relieve the strain on the cable feed the cable through one of the cable guides on the stand rest.

■ Connecting the power supply

If your LAN supports Power-Over-Ethernet (PoE), the phone will be powered via the LAN cord and you will not require a power adapter.

If your LAN does not support PoE or if you have installed a switch between the LAN and the phone that does not support PoE, you will need the optional power adapter to power the phone.

Note:

Only use the optional original plug-in power adapter.

- Plug the round connector of the thin power cord on the underside of the phone into the power socket.
- Desktop installation only: To relieve the strain on the cable feed the cable through one of the cable guides on the stand rest.
- Connect the power supply to the mains.

■ Logging your phone on

Your system administrator has to prepare the system before you can log on your phone.

Office KBM expansion keypad (option)

You can connect one Office KBM expansion keypad with 20 configurable keys to your phone. Each key has an LED for visual signalling.

■ Connecting the Office KBM expansion keypad

Note:

Always disconnect the phone from the mains first before you connect/disconnect an expansion keypad Office KBM.

- Unplug the phone cord from the socket on the underside of the phone.
- Attach Office KBM expansion keypad to the right of the phone until you feel and hear it snap into place, as indicated in the installation instructions.
- Plug the cord into the supplementary equipment sockets on the underside of the phone and the Office KBM expansion keypad.
- Feed the connecting cable through the strain relief on the underside of the Office KBM expansion keypad.
- Plug the phone cord back into the socket on the underside of the phone. The Office KBM expansion keypad is now ready for operation.
- If required, connect the power supply to the mains.

Note:

To find out how to label the configurable keys, refer to the Chapter "[Labelling Configurable Keys](#)", 81.

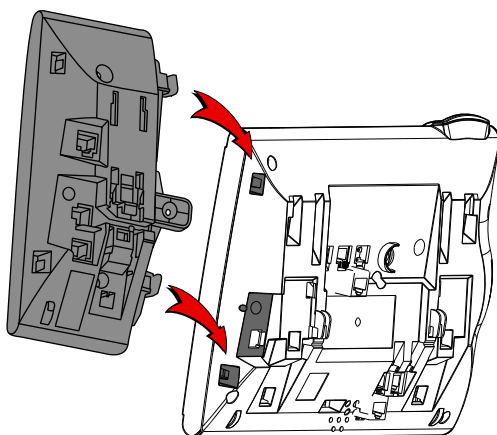

Labelling Configurable Keys

Write-on labels for the configurable keys can be found as an electronic document on the internet. You can fill out the fields directly on your PC and then print out the labels. The internet address is listed on the last page of this document.

- Label the fields on the PC, then print them out and cut them out.
- Carefully remove the transparent cover next to the configurable keys.
- Place the label into the recess next to the configurable keys.
- Carefully replace the transparent cover.

A		
Absence key	3, 32	
Accessing the menu	17	
Activate / deactivate DTMF mode	43	
Activating/Deactivating a Discreet Ring	46	
Announcement	59	
Answer the pager	45	
Answering a Call	9	
Answering a Call on a Line Key	48	
Answering a General Bell	46	
Answering Call Waiting	26	
Audio	52	
Automatic Hands-Free Mode	54	
B		
Brokering	29	
C		
Call duration	9	
Call Forwarding on No Reply	34	
Call Forwarding Unconditional	32, 33, 35, 36	
Call key	3	
Call list	23	
Call waiting	59	
Call waiting on an internal subscriber	26	
Calling a Team Partner	38	
Changing the PIN	57	
Charges	9, 28, 44	
Clearing a Key	67	
CLIR	47	
Conference Call	30	
Configurable Keys	3, 67	
Configuring Keys	63	
Configuring Line keys	68	
Configuring the DTMF mode	56	
Configuring Voice Mail	62	
Connect	30	
Connecting the expansion keypad	80	
Connecting the phone	78	
Connecting the power supply	79	
Connecting your PC to the LAN	79	
Connecting your phone to the LAN	79	
Connections	78	
Correcting your Input	16	
Correction key	2	
Creating a New Phone Book Entry	60	
D		
Deflect a call during the ringing phase	40	
Deflection	40	
Deleting a phone book entry	61	
Desktop phone	76	
Dialling	8	
Dialling by Name	20	
Dialling from external phone books	22	
Dialling from the Call List of Answered Calls	23	
Dialling from the Call List of Unanswered Calls	23	
Dialling from the phone book	21	
Dialling with a Configurable Key	24	
Dialling with Redial	24	
Dialling with the Phone Number	10	
Digit keys	15	
Dismantling	78	
Display	14, 52	
Display contrast	52	
Display symbols	4	
Display text for the idle state	58	
Disposal	5	
Do not disturb	59	
Document information	6	
DTMF Mode	43	
DTMF mode	43, 56	
E		
Editing a Phone Book Entry	61	
End key	3	
Ending a Call	9	
Enquiry Call During a Call	29	
Enters digits	15	
Enters letters	15	
Environmental influences	5	
Equipment provided	75	
F		
Finding by paging system	45	
First-Time Operation	74	
Formulating Functions	69	
Forwarding	32, 59	
Forwarding a Call	32, 33	
Forwarding a Call on No Reply	34	
Forwarding to a message	36	
Forwarding to Voice Mail	35	
Foxkey	2, 14	
Function Commands	69	
Function key	64	
Function MCID (Malicious Call Identification)	47	
G		
GNU licence provisions	73	
H		
Hands-free microphone	2	
Hands-free operation	11, 54	
Headset	12	
I		
Installation	74	

Intended Purpose	6	PoE	79
Intrusion	59	Pressing a Key	14
IP settings	70	Private call with PIN	28
K		Protection	59
Key block	2	Q	
Key phone	48	Quickdial	20
L		R	
LED	2, 18, 64	Read Text Messages	42
Liability	73	Receiving an Announcement	28
Line Keys	48	Redial	10, 24
Local settings	70	Redial key	3
Lock	37	Reject	40
Logging your phone on	79	Reject a call during the ringing phase	40
Loudspeaker key	3	Remote control	50
M		Requesting a Callback	25
Maintenance	5	Resetting activated features	18
Makes announcement to team partner	39	Ringing melody	53
Making a Call	8	Ringing properties	53
Making a call on a third-party phone	44	Ringing speed	53
Malfunctions	72	Ringing volume	53
MCID	47	S	
Menu-Guided Navigation	17	Safety Information	5
Microphone key	3	Selecting the Language	56
Mounting the phone	76	Selecting with the Foxkey	24
Moving the Cursor	16	Send text messages	41
Muting the Microphone	12	Set the ringing volume	52, 53
N		Setting the display	52
Navigating with the navigation key	17	Setting the Ringing Properties	52
Navigation key	2	Setting up the phone	76
Not configured	72	Signals	18
Number key	63	Starting an Announcement	27
O		Store a function under a key	64
Office KBM expansion keypad	3, 80	Store a phone number under a key	63
Open listening	11	Storing a Team Partner under a Key	66
Open Source Software	73	Substituting for a Team Partner	39
Operating elements	2	Supplementary features	19
Options	75	Suppressing your call number	47
Organisation within the team	38	Switching lines	49
Organizing an Absence	32	T	
P		Team key	66
Pager	45	Text mode	15, 16
Park	31	To activate headset operation	55
Parking on a Line key	49	To answer the callback request	25
Personal greeting	62	Tracking a Malicious Call	47
Phone book	21, 22	Transferring a Call Partner	30
Phone book key	3	Troubleshooting	72
Phoning over a Line Key	49	Trying to register	72
Picking Up a Call	42	U	
		Undoing Actions	17

Unlock	38	V	
Upper and Lower Case	16	Voice Mail	35
User information	5	Volume/cursor keys	3
Using a Headset	12	W	
Using the Display and Operating Elements	13	Wall mounting	77
Using the Team Key	38	Write-on labels	3, 81

Declaration of Conformity

Aastra Telecom Schweiz AG hereby declares that the equipment Ascotel®, Ascotel® IntelliGate® and the accessories there to comply with the basic requirements and other relevant stipulations of Directive 1999/5/EC.

You will find the complete text of the declaration of conformity and other documents for this device and the telecommunications systems Ascotel® and Ascotel® IntelliGate® under:

<http://www.aastra.ch/docfinder>

Ascotel® and IntelliGate® are trademarks of Aastra.
Technical modifications and product availability subject to change without notice.
Copyright © Aastra Telecom Schweiz AG



eud-0830 / 1.0 - 01.2007

AASTRA

Free Manuals Download Website

<http://myh66.com>

<http://usermanuals.us>

<http://www.somanuals.com>

<http://www.4manuals.cc>

<http://www.manual-lib.com>

<http://www.404manual.com>

<http://www.luxmanual.com>

<http://aubethermostatmanual.com>

Golf course search by state

<http://golfingnear.com>

Email search by domain

<http://emailbydomain.com>

Auto manuals search

<http://auto.somanuals.com>

TV manuals search

<http://tv.somanuals.com>