



MODEL

480 *e*



Table of Contents

Introduction	1	the Directory	13
Emergency Service Feature.....	1	Changing a number in the Callers List before dialing	13
Unpacking the Phone.....	1	Deleting an entry in the Callers List.....	13
Key Description.....	2	Deleting all entries in the Callers List.....	13
Installation	4	Headset/ Dataport Operation ...	14
Prompts and Indicators	6	Using a Headset with your Telephone	14
How do I use softkeys?	6	Making and Receiving Calls using a Headset	14
Display Prompts	6	Using the Dataport	14
Making and Answering Calls	7	Using Services	15
Predialing a number	7	Icons.....	16
Handsfree Calling	7	Troubleshooting	17
Timing a call	7	Limited Warranty	19
Using Flash	7		
Extension in Use	7		
Using the Redial List	7		
Status lights	8		
Using Hold key	8		
Adjusting the Volume	8		
Customizing your phone.....	9		
Setting your Options	9		
Using the Directory.....	11		
Adding a name and number to the Directory.....	11		
Entering Letters and Characters	11		
Finding entries in the Directory.....	11		
Changing entries in the Directory.....	11		
Copying to the Directory.....	12		
Dialing from the Directory.....	12		
Deleting an entry in the Directory.....	12		
Deleting all entries in the Directory.....	12		
Locking the Directory	12		
Using the Callers List	13		
Viewing the Callers List.....	13		
Calling an entry in the Callers List	13		
Copying from the Callers List to			

Introduction

Congratulations on your purchase of the Model 480 *e* telephone! The Model 480 *e* boasts several timesaving and advanced features, including:

- a large 8-line backlit display
- a 200 Name/Number Directory with 100 entry Callers List
- a speakerphone for handsfree calls
- access to advanced services
- a jack for headset usage

Use this guide to learn more about the Model 480 *e*'s features.

Emergency Service Feature

The Model 480 *e* will provide basic telephone service during a power failure. However, only the dial pad, ringer and handset will function. If you are on a handset call during a power interruption, the Model 480 *e* will keep the call, although the display will not work while the power is off. Handsfree calls will not be re-established during a power interruption.

Unpacking the Phone



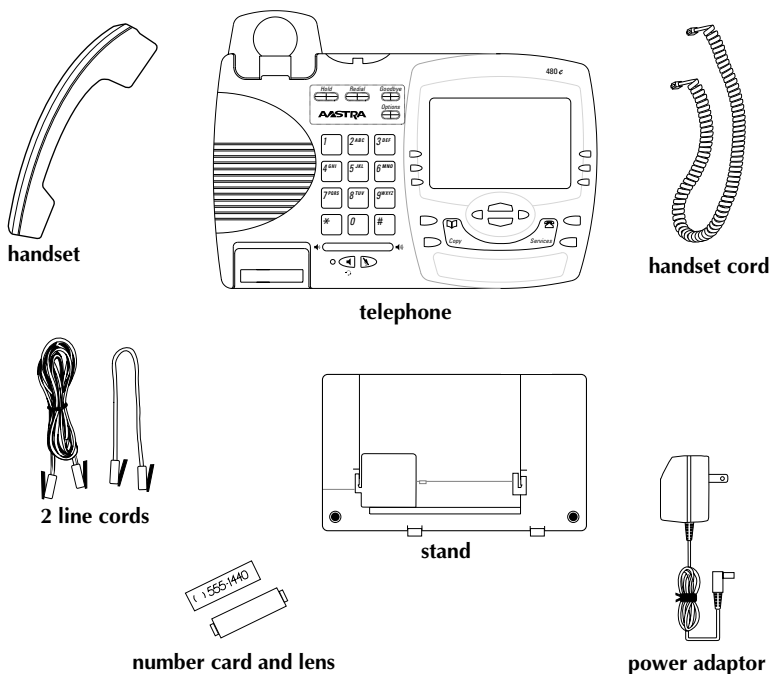





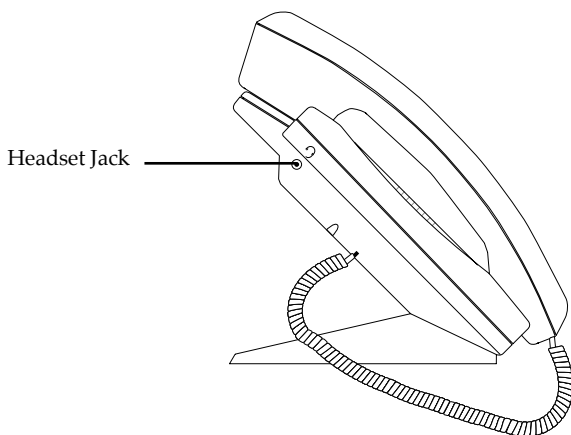
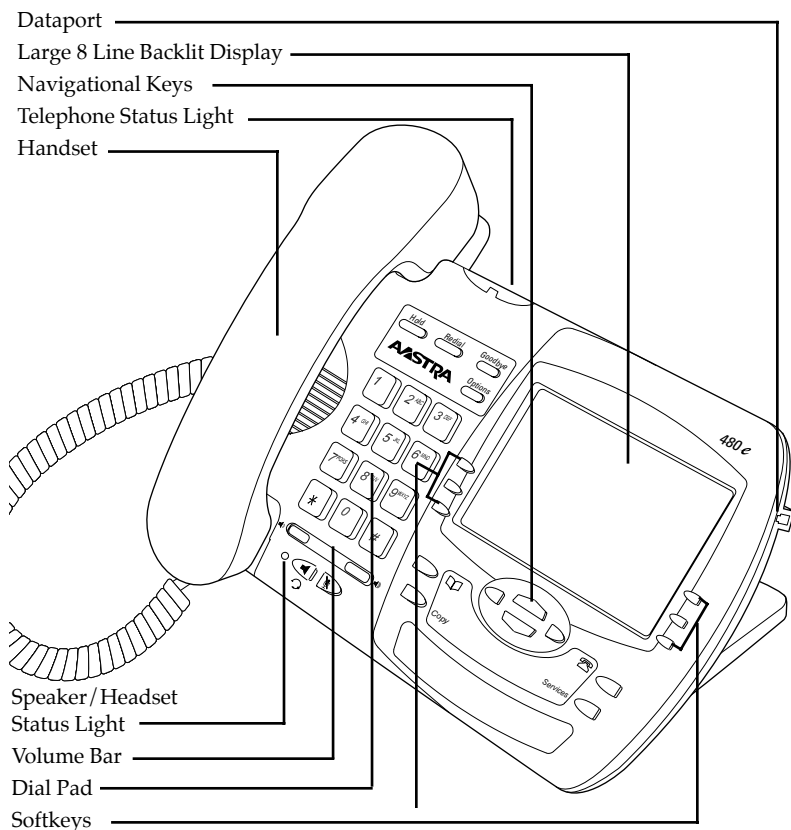













When you unpack your telephone, you should ensure that you have all of the following items. If any part is missing, contact the supplier of your telephone.



The power adaptor is 16 VAC, 250mA – please see the regulatory sheet for safety instructions regarding the power adaptor and operation of the telephone.

Key Description



Keys	Key Description
	Places an active call on hold or releases this call from being held. This key also enters pauses during predial or editing mode. See the section "Using Hold key" for more information.
	Displays the last 10 numbers dialed. See the section "Using the Redial List" for more information.
	Pressing  ends an active call.  exits an open list, such as the Directory or Callers List, but if a call is active when the list is open, it will also end the call. It will not hang up a call that is on hold.
	The  button lets you access nine options to customize your telephone. See the section "Customizing your phone" for more information.
	Adjusts the volume for the handset, headset, ringer and handsfree speaker. See the section "Adjusting the Volume" for more information.
	Pressing  activates Handsfree so you can make and receive calls without lifting the handset. When the audio mode option is activated, this key is used to switch between a headset and the Handsfree speakerphone. See the sections "Handsfree calling" and "Customizing your phone" for more information.
	Mute, when activated, prevents the caller from hearing you through the handsfree, handset or headset. The display will show MICROPHONE MUTED . When a Handsfree or Headset call is muted, the speaker light blinks. To take a call off mute, press  again.
	Directory, which can store up to 200 names and numbers in alphabetical order. See the section "Using the Directory" for more information.
	Pressing  copies a displayed number into the Directory.
	Pressing  and  lets you move between screens when you are using services. These buttons also let you scroll through menu selections, such as the Options List. When you are editing entries on the display,  deletes a character or number, and  adds a space when entering or editing names.
	Callers List, which stores the last 100 callers. See the section "Using the Callers List" for more information.
	Pressing  opens a list of Services scripts that are stored in memory. See the section "Services" for more information on downloading and using services.

Installation

Your Model 480e telephone can be installed on a desk or mounted on the wall. To use the phone's Call Waiting and Caller Identification capabilities, contact your local Service Provider for subscription details. Your Service Provider may call these services by different names.



1. Connect the handset cord

Turn the telephone over and locate the handset jack marked . Insert one end of handset cord into the jack until it clicks into place. Then route the handset cord through the groove as shown in the illustration below.

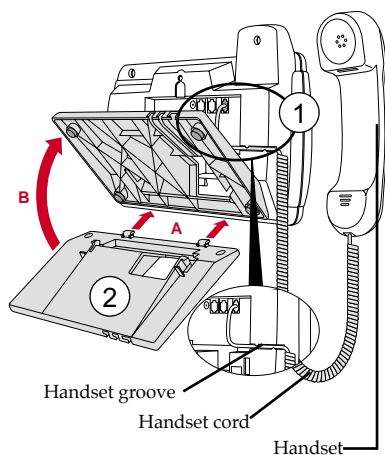
Attach the handset to the other end of the handset cord.





2. Attach the stand

If you plan to mount the phone on the wall, you do not need to attach the stand; skip this step. If you plan to use the phone on a desk, attach the stand by inserting the tabs on the stand (marked with ) into the slots on the bottom of the telephone (A). For a higher viewing angle, use the slots marked . For a lower

viewing angle, use the slots marked . Then slide the stand towards the phone until it snaps into place (B).

3. Connect the cords

If you attached the stand to install the phone on a desk, route both the phone cord and power adapter cord through the opening in the stand. Insert the phone cord into the middle slot on the back of the telephone marked  until it clicks into place. Insert the power cord into the power jack marked .

4. Press the cords into grooves

Press the cords into two of the grooves provided on the bottom of the stand. This will allow the stand to sit flat on a desk surface.

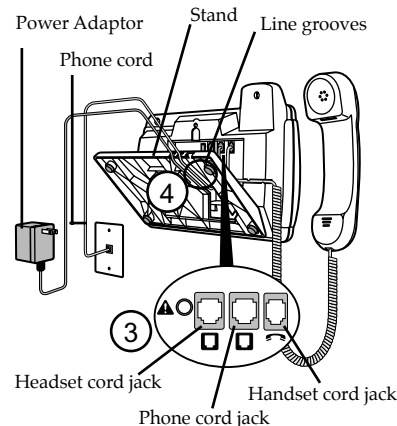

5. Install the phone

If you have installed the stand and are using the phone on a desk: Simply turn the telephone over so it rests on the stand. Connect the phone cord to a phone jack and plug the power adapter into a power outlet.

Note: You should connect the power adaptor to a surge protector or power bar.

6. Install on a wall

To install the Model 480 e on a wall: Connect the cord to the wall jack (A). Coil the phone cord into the space provided on the back of the phone (B). Then align the telephone so the hooks on the wall plate (C) align with the wall-mount slots on the back of the phone, as shown here. Push the phone onto the pegs, then slide it down until it is secure (D). Plug the power adaptor into a power outlet (E).

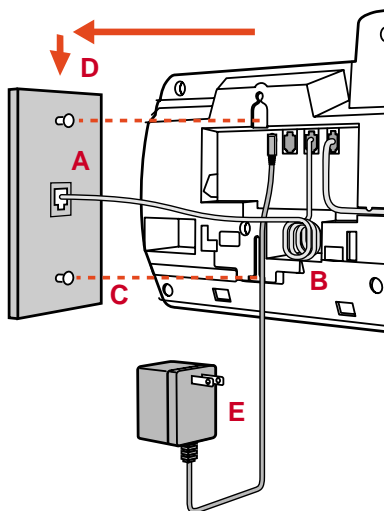

Note: You should connect the power adaptor to a surge protector or power bar.

7. Insert number card

Write your telephone number on the number card, and place it into the card slot on the telephone, located under the mouthpiece in the handset cradle. Gently bend the clear plastic lens into the slot, over the number card.

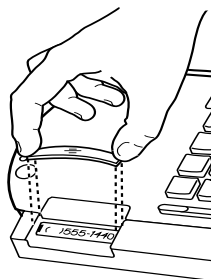

8. Customize the telephone

Follow the instructions in the section “Customizing your phone” to customize your Model 480 e telephone.

Prompts and Indicators

How do I use softkeys?

This telephone uses softkeys to give you commands to choose from. Each choice corresponds to the

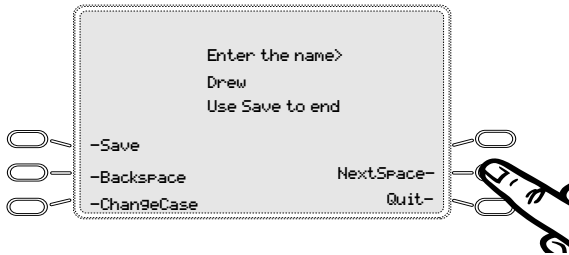

button next to it. In this illustration, the user is selecting **NextSpace** to insert a space. Commands will change depending upon the action you are performing.



Display Prompts

Instructions and information are displayed on the large screen. If you are unsure what a certain prompt



means, find it here, or see the **Troubleshooting** or index section for additional information.

Display Prompt	Explanation
Call is on hold	A call is on hold. Press the  Hold key or the Handsfree key to speak with the caller.
Check phone cord	A line cord () may not be connected properly.
Directory is full	The Directory has reached its maximum number of entries. If you want to add entries, you must first delete some entries.
Directory locked	The Directory has been locked, and you cannot edit, add, or delete entries. See the section “Using the Directory” for more information.
Message Waiting	Check for new messages in your Voice Mail service*.
more ►	Press ► to see other display prompts.
Private Name or Private Number	The caller has requested that the name (or number) not be shown.
Ringer is OFF	No audible ringing. To turn the ringer on again, press the right side of  .
Unknown name or Unknown number	The telephone company is unable to provide the name (or number) of the caller.
XX New callers	XX new calls have been added to the Callers List since you last checked it.
XX Call(s) bumped	XX callers have been deleted from the Callers List to make room for new callers.

* You must subscribe to a Message Waiting service for this feature to work. Consult your local telephone company for information.







Making and Answering Calls

Predialing a number

Predialing lets you view a number before you dial. Enter the number using the dial pad before lifting the handset. Use the **Backspace** softkey or  to correct any errors. To dial the number, lift the handset, or press the **Dial** softkey, or press .

Note: This feature is not available if you choose to use the Live DialPad option. See the section "**Customizing your phone**" for more information.

Handsfree Calling

The Handsfree feature allows you to speak to someone without using the handset. To dial using Handsfree, enter a number and then press  or the **Dial** softkey. To answer using Handsfree, press  when a call is ringing. To switch between Handsfree and the handset when the handset is off hook, press . When the handset is on hook, press  to disconnect a Handsfree call. When Handsfree is on, the speaker light turns on. When the speaker light is on, press  at any time to mute Handsfree. The speaker light will flash and you will hear the caller, but they will not hear you. To switch between Handsfree and mute press .

Note: Handsfree operation as described above will be affected and may be disabled if the set audio option has been activated. See the section "**Customizing your phone**" for more information.

Timing a call

When you make or answer a call, the Timer shows the elapsed time of the call.

Using Flash

The **Flash** softkey allows you to access telephone company subscribed services, such as call waiting and three-way calling. These services vary from area to area, so contact your telephone company for instructions on using available services with your Model **480e** telephone. If these instructions say to press the "hook-switch" or "receiver button," press the **Flash** softkey.

Extension in Use





The **Extension in use** prompt appears on the telephone display and the telephone status light turns on when someone uses another telephone on the same line.

This message also appears when the telephone is not properly connected to a phone line.

Using the Redial List

The Redial List records the last 10 numbers you dialed.

Redialing a number

1. Press  to view the Redial List.
2. Use the   keys to move the cursor to the number you want to dial.
3. Lift the handset to dial the number, or press the **Dial** softkey or  to dial the number using Handsfree.

Deleting the Redial List

1. Press  to view the Redial List.
2. Press the **DeleteList** softkey.
3. Press the **Delete** softkey to confirm.

Status lights

Speaker Light



- Speaker light is on: a call is on Handsfree (speaker).
- Speaker light flashes slowly: indicates that the headset/hands-free option is being used. See the section "Customizing your phone" for more information.
- Speaker light flashes and the display shows **Microphone muted**: a call is muted. Press  to take the call off mute.

Telephone Light

- Light flashes and the display shows **Call is on hold**: a call is on hold. Press  or lift the handset to take the call off hold.
- Light flashes and the display shows **Message Waiting**: a message is waiting for you at your message or voice mail service[†].
- Light flashes quickly and the ringer sounds: you have an incoming call.
- Light is on and the display shows **Extension in use**: an extension telephone is using the line. The message also appears when the telephone is not properly connected to a phone line.

Using Hold key

Pressing  puts a call on hold.

- You can hang up the handset without losing the call.
- The display will show the message **Call is on hold**.
- The telephone light will flash.
- To retrieve the call, lift the handset or press  again. You can also press  to retrieve a Headset or Handsfree call.

Note: A call is taken off hold automatically after 15 minutes. If the handset is on the phone, the call will be disconnected. If the handset is off, the caller will be able to hear you again.

Adjusting the Volume

Pressing the volume button adjusts the receiver, headset, speaker, and ringer volume.

- To adjust the ringer volume, leave the handset in the cradle and press the volume bar  while there is no active call. There are 8 settings for the ringer – the display will temporarily indicate the current ringer volume setting.
- To adjust the handset volume, lift the handset and press the volume button while you are on a call. The handset will return to the default volume after you hang up.
- To adjust the headset volume, press the volume button while on a call. The headset will return to the default volume after you end the call.

Note: The default handset and headset volume is always set at medium.

- To adjust the speaker volume, press the volume button while the speaker is activated (activate the speaker by pressing ). The speaker will remain at this volume until it is adjusted again.





[†] You must subscribe to a Message Waiting service for this feature to work. Consult your local telephone company for information.

Customizing your phone

There are nine configuration options, accessed by pressing

 .

Setting your Options

1. Press  to enter the Options List.
2. Use  and  to scroll through the list of nine options.
3. Press the **Show** softkey to configure an option.
4. Use the softkeys to change a selected option.
5. Press the **Done** softkey at any time to exit the option, or press  to exit the Options list.

The following nine options may be changed on the Model 480 e:

1. **Language** – Select a language for the display prompts (English, French, or Spanish).
2. **Time / Date** – Use this option to change the time and date setting on the display. Press the appropriate softkey to increase that item by 1. For example, press the **Hour** softkey to increase the hour from 1 to 2.
Note: The time and date are automatically set when the phone receives its first Caller ID[†] call.
3. **Set ring tone** – Press the **Change** softkey to select one of four ring tones.
4. **Clear Msg. Wtg.** – Sometimes the **Message Waiting** prompt will appear and the light will flash when there are no messages waiting on your Voice Mail[†] service. When in this option, select the **Clear** softkey to clear the prompt and flashing

light. The light will flash again when there are new messages waiting.

5. **Area Code** – In some locations, you cannot dial a local number using the area code. By default, incoming calls are recorded with area codes in the Callers List. This option allows you to enter up to three local area codes to be removed from incoming calls. Press the **Change** softkey to enter an area code.
6. **Contrast Level** – Use the **Change** softkey to cycle through 8 contrast settings, which brighten or darken the display.
7. **Security Numbers** – This option allows you to keep selected numbers from appearing on the screen when dialed. Use this option to protect passwords, access codes etc. When a security number is used, your telephone displays the asterisk * symbol for all digits that you dial after the security number and the digits do not appear in the Redial list display. Up to three security numbers can be created using this option. Press the **Change** soft key and then enter the security number.
8. **Live Dialpad** – Use this option to turn on or off the dial pad mode. With live dialpad on, the telephone automatically dials out and turns on Handsfree as soon a dial pad key or softkey is pressed. With live dialpad off, you must dial the number first and then lift the handset or press the  button before the number is dialed. Press the **Change** soft key to turn on or off the dial pad mode.

9. **Set Audio** – The Model 480e telephone allows you to use a handset, headset or handsfree to handle incoming and outgoing calls. This option provides different combinations of these three methods to provide maximum flexibility in handling calls. There are four options to choose from:

- **Handsfree** – this is the default setting. Calls can be made or received using the handset or handsfree speakerphone and can be switched between the two modes.
- **Headset** – choose this setting if you want to make or receive all calls using a headset.

Note: If this option is chosen, the handsfree speakerphone will not function.

- **Spkr/Hset** – calls will be sent to the handsfree speakerphone. By pressing the / button on the phone you can switch between the handsfree speakerphone and a headset.
- **Hset/Spkr** – calls will be sent to the headset. By pressing the / button on the phone you can switch between the headset and the handsfree speakerphone.







[†] These services may have different names in your area, and may require paid subscription. Contact your telephone company for details.

Using the Directory

The Directory can store up to 200 names and numbers, which are displayed in alphabetical order.

Tip: Store all your Directory contacts the same way, either first name first, or last name first. This will make it easier to find names and numbers.

Adding a name and number to the Directory



1. Press the Directory button .
2. Press the **AddNew** softkey.
3. Enter the number using the dial pad. You can enter up to 24 digits. Hyphens will be automatically added. If you need to enter a pause (between your voice mail number and password, for example), press the **Pause** softkey. The pause icon  will appear. To program a number that uses Flash, press the **Flash** softkey where it is required in the number. The Flash icon  will appear. Press the **Backspace** softkey or  to erase a number.
4. Press the **Save** softkey.
5. Enter a name using the letters on the dial pad. See the following instructions “**Entering Letters and Characters**” to enter names using the dial pad. The name can have up to 16 characters, including spaces. Press the **NextSpace** softkey or  to move to the next letter or add a space. Press the **Backspace** softkey or  to erase a character.
6. Press the **Save** softkey. The new entry now shows on the display.

Note: You can also copy an entry from the Callers List to the Directory using the  button, before or after you have changed it.

Entering Letters and Characters

You can enter characters using the telephone’s dial pad. To enter a letter, press the key with that letter on it. If the letter is the second one on that key, press the key twice. For example, to enter ‘R’, press  three times. The cursor will advance to the next space after a delay of 2 seconds or if you press a different key.



To change the case of a letter, press the **ChangeCase** softkey, and then enter the letter. By default the first letter of a word or name will be capitalized, and the letters following will be lower case.

Special characters are entered by pressing the  and the  keys. Characters will appear in this order:



: *, < > ` . - 1.

: # / \ @.

Finding entries in the Directory

1. Press the Directory button .
2. Once in the Directory, press  to scroll down and  to scroll up one listing at a time. Hold either key down to scroll continuously.

OR

Press a dial pad key to see listings that start with that letter. For example,  takes you to the first “J” listing,  takes you to the first “K” listing.

Changing entries in the Directory

1. Press the Directory button .
2. Find the entry you would like to change.
3. Press the **Change** softkey.

- To change the number, use the **Backspace** softkey or **◀** to erase digits. Use the dial pad to add digits. Use the **Pause** softkey to insert a 2 second pause. The pause icon **⏸** will appear.
- Press **Save** to move to the name.
- To change the name, use the **Backspace** softkey or **◀** to erase letters. Use the dial pad and the **NextSpace** softkey to add letters. Press the **ChangeCase** softkey to switch between upper and lower case.
- Press **Save** to save changes.

Copying from the Callers List, the Redial List, or the Display to the Directory

- Open the Callers List, Redial List, or answer a call.
- When the number is displayed on the screen, press **Copy**. If the entry includes a name and number, the display will show **Saved: Directory**.
- If the entry is a number only (such as in the Redial List), you will be prompted to enter a name. Once you've pressed the **Save** softkey to save the name, the display will show **Saved: Directory**.

Dialing from the Directory

- Press the Directory button **☞**.
- Find the entry you would like to call in the Directory.
- Lift the handset to dial the number, or press the **Dial** softkey or **◀** to dial the number using Handsfree.

Deleting an entry in the Directory

- Press the Directory button **☞**.
- Find the entry you would like to delete.
- Press the **Delete** softkey.
- Press the **Delete** softkey again to confirm.

Deleting all entries in the Directory

Once you have deleted the Directory, you cannot get entries back. You can protect the Directory by locking it.

To permanently delete all entries in the directory:

- Press the Directory button **☞** to open the Directory.
- Press the **DeleteList** softkey.
- Press the **Delete** softkey to confirm.

Locking the Directory

You can lock the Directory so that entries cannot be deleted or changed. You cannot add entries to a locked directory.

- Press **Options**.
- Press **Hold**.
- Press ***1**. The display shows **Directory Locked**.

To unlock the Directory





- Press **Options**.
- Press **Hold**.
- Press **#1**. The display shows **Directory Unlocked**.

Using the Callers List

The Callers List records the last 100 callers, in the order they called. The telephone display will indicate when there are new callers.



When the Callers List is full, new callers are added to the list, and the oldest callers are deleted. In the Callers List you will see the message **XX New caller(s), XX Call(s) bumped** on the display.

Viewing the Callers List

1. Press the Callers button .
2. Press  and  to move up and down in the Callers List. Hold either key down to scroll continuously. You can also press the **Resume** softkey to see the last caller you viewed the previous time you entered the Callers List.
3. Press the Callers button , the **Quiet** softkey, or **Goodbye** at any time to leave the Callers List.

Note: **Goodbye** will also hang up a caller if you are on a call.

Calling an entry in the Callers List

1. Press the Callers button .
2. Find the entry you would like to call in the Callers List.
3. Lift the handset to dial the number, or press the **Dial** softkey or  to dial the number using Handsfree.

Copying from the Callers List to the Directory



When the number is displayed in the Callers List, press **Copy**. The display will show **Saved: Directory**.

If the entry in the Callers List does not have a name (i.e. if the name is listed as **Unknown or Private**), you will be prompted to enter a name. You can edit a number in the Callers List and then copy it to the Directory.

Changing a number in the Callers List before dialing

Tip: If you have to frequently remove area codes to return local calls, you should use the **Area Codes** option and add your local area code(s).

Note: The Callers List does not save changes. If you plan to dial the number again, copy it to the Directory and change it there.

1. Press the Callers button .
2. Find the caller in the Callers List you wish to dial.
3. To add digits, use the dial pad.
4. To delete digits, press the **Edit Num** softkey to begin editing. Use the dial pad to add digits.
5. Lift the handset to dial the number, or press the **Dial** softkey or  to dial the number using Handsfree.

Deleting an entry in the Callers List

1. Press the Callers button .
2. Find the entry you would like to delete in the Callers List.
3. Press the **Delete** softkey.
4. Press the **Delete** softkey again to confirm. The display shows **Item is erased**.

Deleting all entries in the Callers List

1. Press the Callers button .
2. Press the **DeleteList** softkey.
3. Press the **Delete** softkey to confirm. The display shows **Callers list is empty**.

Headset/ Dataport Operation

Using a Headset with your Telephone

The Model 480 *e* is equipped to accept headsets with either a modular RJ22 jack or a 2.5mm standard jack. Headsets with a modular RJ22 jack can be connected to the phone by using the jack on the back of the set. Headsets with a standard 2.5mm jack can be plugged into the headset jack located on the left hand side of the telephone.

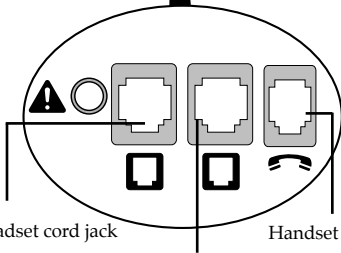
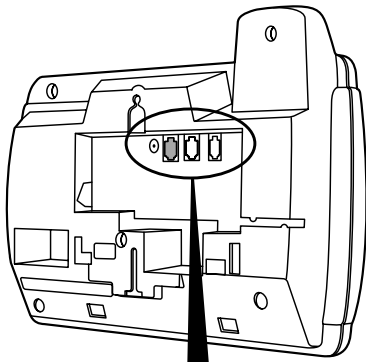



Headset cord jack

Phone cord jack

Handset cord jack

Contact your telephone equipment retailer or distributor to purchase a headset. Customers should read and observe all safety recommendations contained in headset operating guides when using any headset.

Making and Receiving Calls using a Headset

1. Ensure that you have selected a headset audio mode by accessing the Options menu. See the section "**Customizing your phone**" for detailed information.
2. Plug the headset into jack.
3. Press the  key to obtain dialtone or answer an incoming call. Depending on the audio mode selected from the Options menu, dialtone or an incoming call will be received on either the headset or the handsfree speakerphone.
4. Press the  key to end the call.

Using the Dataport

Located on the right hand side of the Model 480 *e*, the dataport can be used to connect another device such as a fax machine or computer modem to the phone. Plug one end of a line cord to the phone and the other end to the device to be connected.

Note: The dataport will only operate when the handset is on hook (in the phone base cradle).

Using Services

The Model 480e telephone allows you to access enhanced telephone company subscription features and services, which can include home banking, catalogue shopping, restaurant guides, and voice mail. Services may be free or may have a subscription cost. Contact your telephone company for information. Before selecting a service, you must download the service into your telephone. Contact your telephone company for information on downloading services in your area. Downloading a service is as simple as dialing the subscription number and following any voice prompts. Your phone may be capable of automatically dialing out to update your subscribed features and services. For more information on this ability, contact your telephone company.

Some services may be available by dialing them directly. You do not have to download these services, but you may wish to save them in your Directory.

Note: Some options, such as the call timer, may be disabled when you are using a service.

Activating services:

1. Dial the number provided by your telephone company and follow the prompts.
2. Once you have successfully downloaded the services of your choice, press the **Services** key. The Services menu appears.
3. Use the **Left** and **Right** keys to move the **▶** indicator to the Service you want to select.
4. Press the **Select** softkey to activate the service next to the **▶** indicator.
5. Once you have connected to the service, follow the instructions on the display.
6. To exit a service session, press the **Quit** softkey, **Services** or **Goodbye** to leave the Services List.

Deactivating services:





You may deactivate a service by contacting your telephone company. You can delete a downloaded service in the Services menu by selecting it and pressing the **Delete** softkey. The service will appear as **<deleted>**.

If you download another service, it may overwrite any service displayed as **<deleted>**.



Icons

The display uses icons to convey information about calls, Directory entries, Callers, and services.



Icons in the Callers List

	You are viewing the Callers List.
	You answered the call when it came in.
	You did not answer the call when it came in.
	You were on another call when this call came in.
	You have returned the call from the Callers List.



Icons in the Directory

	You are viewing the Directory.
	You pressed the Flash softkey, or Flash has been programmed into a number.
	You pressed the Pause softkey or a pause (which is about 2 seconds) has been programmed into a number.

Other List Icons

	You are viewing the Redial List.
	You are viewing the Options List.

Icons in the Services List

	You are viewing the Services List.
	Press ► or ◀ for more information.
	Service information is being downloaded to your telephone.

Troubleshooting

What are services, and how do I use them?

Services are provided by your telephone company, and include basic features such as Caller ID[†]. Other services can be accessed through the **Services** key, and may include services such as Call Forwarding[†] and Voice Mail[†]. Before using your services, you must activate them by contacting your local telephone company. See the section “Using Services” for more information.

I'm having trouble with services I have subscribed to – how do I get help?

Usually your telephone company supplies a special number to call for activation of your services. When you call this number, you must follow the recorded instructions carefully. This allows the telephone company's system to recognize your phone and customize it with the services you have subscribed to. If you have any activation problems call your local telephone company.

Why are there no prompts on the screen when a Call Waiting call comes in?

You must subscribe to Call Waiting Identification[†] from your telephone company.

Why is the light not coming on with a new Voice Mail Message?

You must subscribe to the “Visual” Message Waiting[†] service from your telephone company for this function to work.

Why don't numbers I return from the Callers List connect?



Incoming calls are recorded with the area code attached, whether they are

long distance or local calls. You may have to remove the area code from local calls in order to call from the Callers List, or use the Area Code option in the options list to have local area codes automatically removed. See the section “Customizing your phone” for information about the Area Code option. Alternatively, you may need to add '1' before long distance numbers in order to dial long distance.

Why is my handset not working?

Check to ensure that the handset cord is fully connected to both the phone and handset. See the section “Installation” for information.

Why is my speakerphone not working?

If you press  and the speaker light flashes and you do not hear dialtone, the **Set Audio** option has been used to set up the phone for headset use. Press  a second time. If the light goes out, the phone is set up to be used only with a headset or handset. If the light stays on steady and you hear dialtone, you can alternate between the speakerphone and the headset by pressing . See the section “Customizing your phone” for instructions on how to change the **Set Audio** feature.

Why is my display blank?

Ensure that the power adaptor is fully plugged into the electrical outlet, and that the outlet is supplying power (you can test this with another electrical device, such as a lamp).

How do I set the time and date?

If you subscribe to the Caller ID[†] service, the first incoming call will update the phone with the correct time & date. Otherwise, use the Time/Date option in the options list to manually set the time and date.

Why can I only see 4 options when the user guide says there are 9?

The telephone screen will only show 4 options at a time. To see more, press the down arrow button .

How do I remove the stand from the phone?

Place one hand on top of the phone, and place the other hand on the top of the stand. Pull the stand away from the telephone. You will have to pull quite forcefully, but this will not break the stand.

Can I turn the light on the screen off?

No. You can only adjust the contrast of the display.

Why are Callers not identified on the display?

Caller ID[†] information usually arrives between the first and second ring. Let the telephone ring at least once before answering. Make sure you subscribe to Caller ID[†] services from your local telephone company.

Why can't I dial a number in the Callers List?

You must subscribe to a Caller ID[†] service for names and/or numbers to be recorded in the Callers List. If the number of the caller is unknown or private, you cannot return the call. Or, the number may require an area code. Press the **EditNum** softkey to edit the number, then press the **Dial** softkey.

Why does the telephone wobble?

Make sure the cords are routed properly through the stand, as indicated in the Installation section. Check that the stand has been properly snapped into place.

What does Hold Msg do?

This is an option available with some Call Waiting[†] services. When you are on a call, and another call comes in on Call Waiting, you can press the **Hold Msg** softkey to send a network message to the caller. The message will ask the caller to hold, and tell them that you will be with them shortly. You can then answer the call at your convenience. Contact your local telephone company for activation information.

What does Answ. CW or Swi tch do?

This is an option available with some Call Waiting[†] services. These softkeys allow you to put the current call on hold, and answer a Call Waiting call. You can then switch between calls normally. Contact your local telephone company for activation information.

What is a softkey?

There are three keys on both the left and right side of the display. They do different things, depending on the command displayed next to them. See the section "How do I use softkeys?" for more information.

[†] These services may have different names in your area. Contact your telephone company for details.

Limited Warranty

Aastra Telecom warrants this product against defects and malfunctions during a one (1) year period from the date of original purchase. If there is a defect or malfunction, Aastra Telecom shall, at its option, and as the exclusive remedy, either repair or replace the telephone set at no charge, if returned within the warranty period.

If replacement parts are used in making repairs, these parts may be refurbished, or may contain refurbished materials. If it is necessary to replace the telephone set, it may be replaced with a refurbished telephone of the same design and color. If it should become necessary to repair or replace a defective or malfunctioning telephone set under this warranty, the provisions of this warranty shall apply to the repaired or replaced telephone set until the expiration of ninety (90) days from the date of pick up, or the date of shipment to you, of the repaired or replacement set, or until the end of the original warranty period, whichever is later. Proof of the original purchase date is to be provided with all telephone sets returned for warranty repairs.

Exclusions

Aastra Telecom does not warrant its telephone sets to be compatible with the equipment of any particular telephone company. This warranty does not extend to damage to products resulting from improper installation or operation, alteration, accident, neglect, abuse, misuse, fire or natural causes such as storms or floods, after the telephone is in your possession.

Aastra Telecom shall not be liable for any incidental or consequential damages, including, but not limited to, loss, damage or expense directly or indirectly arising from the customers use of or inability to use this telephone, either separately or in combination with other equipment. This paragraph, however, shall not apply to

consequential damages for injury to the person in the case of telephones used or bought for use primarily for personal, family or household purposes.

This warranty sets forth the entire liability and obligations of Aastra Telecom with respect to breach of warranty, and the warranties set forth or limited herein are the sole warranties and are in lieu of all other warranties, expressed or implied, including warranties or fitness for particular purpose and merchantability.

Warranty Repair Services

Should the set fail during the warranty period;

In North America, please call 1-800-574-1611 for further information.

Outside North America, contact your sales representative for return instructions.

You will be responsible for shipping charges, if any. When you return this telephone for warranty service, you must present proof of purchase.

After Warranty Service

Aastra Telecom offers ongoing repair and support for this product. This service provides repair or replacement of your Aastra Telecom product, at Aastra Telecom's option, for a fixed charge. You are responsible for all shipping charges. For further information and shipping instructions;

In North America, contact our service information number: 1-800-574-1611.

Outside North America, contact your sales representative.

Note: Repairs to this product may be made only by the manufacturer and its authorized agents, or by others who are legally authorized. This restriction applies during and after the warranty period. Unauthorized repair will void the warranty.

Index

A

- Area Code 9, 13, 18
- Audio Mode 7, 9, 14

B

- Backlit Display 2, 18

C

- Callers
 - Key 3
- Callers List
 - Calling an entry 13
 - Changing a listing 13
 - Copying from 12, 13
 - Deleting all entries 13
 - Deleting an entry 13
 - Viewing 13
- Contrast Level 9
- Copy key 3

D

- Dataport 2, 14
- Date and Time 9
- Directory
 - Adding name/number 11
 - Changing entries 11
 - Copy to 12, 13
 - Deleting all entries 12
 - Deleting an entry 12
 - Dialing from 12
 - Entering
 - letters/characters 11
 - Finding entries 11
 - Key 3
 - Locking 12
 - Unlocking 12

Display

Contrast

- See Contrast Level
- Language 9
- Prompts 6

E

- Emergency Service Feature 1
- Extension in Use 7

F

- Flash 7, 11, 16

G

- Goodbye key 3

H

- Handsfree calling 3, 7
- Headset
 - Jack 2
 - Making calls 14
 - Receiving calls 14
 - Switch 2, 14, 17
- Hold key 3, 8

I

- Icons 16
- Insert Number Card 5
- Installation 4

K

- Key Description 2

L

- Language selection
 - See Display
- Lights See Status Lights
- Live Dialpad 7, 9
- Locking Directory

Index

See Directory

M

Message Waiting 6, 8, 9

Mute key 3

O

Options

Area Code 9

Audio Mode 9

Clear Message Waiting 9

Contrast level 9

Language 9

Live Dialpad 9

Ring Tone 9

Security Numbers 9

Time/Date 9

Options key 3

P

Pause

Icon 16

Inserting 3, 11

Predialing 7

Prompts 6

R

Redial key 3

Redial List

Deleting List 7

Redialing a number 7

Ringer

ON/OFF 6

Tone 9

Volume 8

S

Security Numbers 9

Services 15, 16

Services key 3

Softkeys 6, 18

Speaker

Key 3

Light See Status Lights

Operation 7

Stand 4

Status Lights

Speaker 8

Telephone 8

T

Timing a call 7

Troubleshooting 17

V

Viewing items

Callers List 13, 16, 18

Directory 16

Redial List 16

Voice Mail 6, 17

Volume

Handset 8

Key 3

Ringer 8

Speaker 8

W

Warranty 19

If you've read this owner's manual and consulted the Troubleshooting section and still have problems, please visit our website at www.aastra.com or call 1-800-574-1611 for technical assistance.

© Aastra Telecom 2003
D0041-0049-00-00 Rev.01

Free Manuals Download Website

<http://myh66.com>

<http://usermanuals.us>

<http://www.somanuals.com>

<http://www.4manuals.cc>

<http://www.manual-lib.com>

<http://www.404manual.com>

<http://www.luxmanual.com>

<http://aubethermostatmanual.com>

Golf course search by state

<http://golfingnear.com>

Email search by domain

<http://emailbydomain.com>

Auto manuals search

<http://auto.somanuals.com>

TV manuals search

<http://tv.somanuals.com>