



# 57i CT IP Phone

User Guide  
Release 2.0

41-001202-00

Rev 01

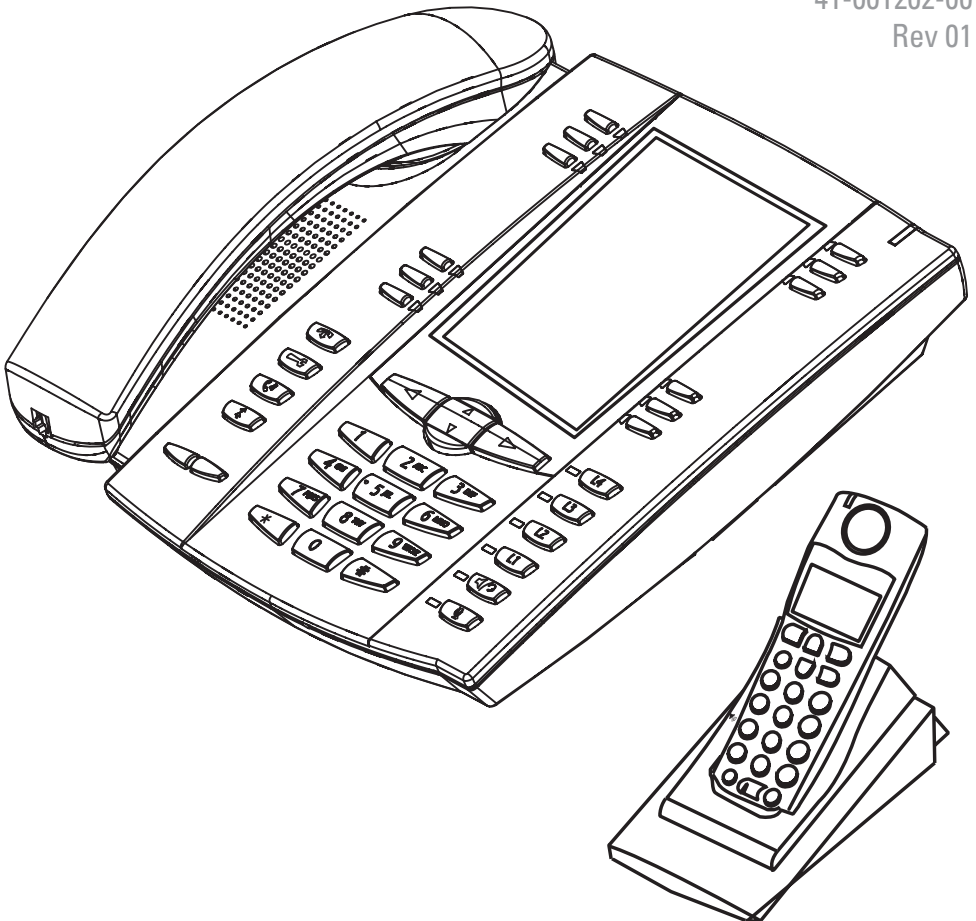

Aastra Telecom will not accept liability for any damages and/or long distance charges, which result from unauthorized and/or unlawful use.

While every effort has been made to ensure accuracy, Aastra Telecom will not be liable for technical or editorial errors or omissions contained within this documentation. The information contained in this documentation is subject to change without notice.



Copyright 2007 Aastra Telecom. [www.aastra.com](http://www.aastra.com)

All Rights Reserved.

# Software License Agreement

Aastra Telecom Inc., hereinafter known as "Seller", grants to Customer a personal, worldwide, non-transferable, non-sublicenseable and non-exclusive, restricted use license to use Software in object form solely with the Equipment for which the Software was intended. This Product may integrate programs, licensed to Aastra by third party Suppliers, for distribution under the terms of this agreement. These programs are confidential and proprietary, and are protected as such by copyright law as unpublished works and by international treaties to the fullest extent under the applicable law of the jurisdiction of the Customer. In addition, these confidential and proprietary programs are works conforming to the requirements of Section 401 of title 17 of the United States Code. Customer shall not disclose to any third party such confidential and proprietary programs and information and shall not export licensed Software to any country except in accordance with United States Export laws and restrictions.

Customer agrees to not reverse engineer, decompile, disassemble or display Software furnished in object code form. Customer shall not modify, copy, reproduce, distribute, transcribe, translate or reduce to electronic medium or machine readable form or language, derive source code without the express written consent of the Seller and its Suppliers, or disseminate or otherwise disclose the Software to third parties. All Software furnished hereunder (whether or not part of firmware), including all copies thereof, are and shall remain the property of Seller and its Suppliers and are subject to the terms and conditions of this agreement. All rights reserved.

Customer's use of this software shall be deemed to reflect Customer's agreement to abide by the terms and conditions contained herein. Removal or modification of trademarks, copyright notices, logos, etc., or the use of Software on any Equipment other than that for which it is intended, or any other material breach of this Agreement, shall automatically terminate this license. If this Agreement is terminated for breach, Customer shall immediately discontinue use and destroy or return to Seller all licensed software and other confidential or proprietary information of Seller. In no event shall Seller or its suppliers or licensors be liable for any damages whatsoever (including without limitation, damages for loss of business profits, business interruption, loss of business information, other pecuniary loss, or consequential damages) arising out of the use of or inability to use the software, even if Seller has been advised of the possibility of such damages.



# Table of Contents

Software License Agreement.....	iii
About this Guide .....	1
Documentation .....	1
Introduction .....	2
<b>Phone Features</b> .....	<b>2</b>
<b>Requirements</b> .....	<b>2</b>
<b>Installation and Setup</b> .....	<b>3</b>
Getting Started .....	4
<b>Plugging in and Starting the Phone</b> .....	<b>4</b>
<b>Network Connected/Network Disconnected</b> .....	<b>8</b>
<b>Idle Screen</b> .....	<b>9</b>
<b>Phone Options via the IP Phone UI</b> .....	<b>13</b>
<b>References</b> .....	<b>14</b>
<b>Phone Options via the Aastra Web UI</b> .....	<b>15</b>
User Password .....	19
Using Your 57i CT Base Unit Phone.....	20
57i CT Base Unit Key Descriptions .....	20
<b>Multiple Line and Call Appearances</b> .....	<b>23</b>
Softkeys.....	24
<b>Softkey Functions</b> .....	<b>25</b>
<b>State-Based Softkeys (Bottom Keys only)</b> .....	<b>26</b>
<b>Softkeys as Line/Call Appearances</b> .....	<b>28</b>
<b>Softkeys as Speeddials</b> .....	<b>31</b>
<b>Softkeys as "Do not Disturb"</b> .....	<b>35</b>
<b>Softkeys as Busy Lamp Field (BLF)</b> .....	<b>36</b>
<b>Softkeys as BLF List</b> .....	<b>38</b>
<b>Softkeys for Accessing XML Services</b> .....	<b>40</b>
<b>Softkeys as Flash Key</b> .....	<b>44</b>
<b>Softkeys as Sprecode</b> .....	<b>45</b>
<b>Static and Softkey Settings for Park/Pickup</b> .....	<b>47</b>
<b>Softkeys as Last Call Return (lcr) (Sylantro Servers only)..</b>	<b>52</b>
<b>Softkeys as Services</b> .....	<b>54</b>
<b>For more information about Services you can access on your phone, contact your system administrator.</b> .....	<b>54</b>
<b>Softkeys as Directory</b> .....	<b>56</b>
<b>Softkeys as Callers List</b> .....	<b>58</b>
<b>Softkeys as an Intercom Key</b> .....	<b>60</b>
<b>Softkeys as an Empty Key</b> .....	<b>62</b>
<b>Deleting a Softkey</b> .....	<b>63</b>
Restarting your phone.....	64
Making Calls.....	65

# Table of Contents

- Dialing a Number** ..... 65
- Pre-dialing a Number**..... 65
- Using Handsfree Speakerphone.....66
- Using a Headset .....66
- Intercom** ..... 68
- Redial**..... 70
- Mute**..... 71
- Receiving Calls .....72
  - Answering an Incoming Call** ..... 72
  - Sending an Incoming Call to Voicemail**..... 72
- Handling Calls .....73
  - Placing a Call on Hold** ..... 73
  - Transferring Calls**..... 75
  - Conferencing Calls** ..... 76
  - Picking up Calls**..... 79
  - Ending Calls**..... 79
- Managing Calls .....80
  - Directory List**..... 80
  - Callers List** ..... 87
  - Call Forwarding** ..... 92
  - Missed Calls Indicator** ..... 95
  - Voicemail**..... 96
- Using Your 57i CT Cordless Handset.....97
  - 57i CT Handset Key Panel** ..... 97
  - 57i CT Handset Key Description**..... 98
  - Accessing Options** ..... 99
  - Intercom** ..... 100
  - Language** ..... 100
  - Ring Tone** ..... 100
  - Custom name** ..... 101
  - Call timer**..... 101
  - Vibrate** ..... 101
  - Handset Pairing**..... 101
  - Key Lock On or Off** ..... 102
  - Backlight** ..... 102
  - Silent Alert** ..... 102
  - Finding the Phones's IP Address using the Handset**..... 102
  - Feature Keys on the Handset** ..... 103
  - Idle Mode**..... 105
  - Handset Icons and Status Messages** ..... 105
  - Handset Keys** ..... 106
  - Multifunction Handset LED Indicator** ..... 107
  - Battery Charging** ..... 107

# Table of Contents

<b>Volume Control</b> .....	<b>108</b>
<b>Directory - 57i CT Cordless Handset</b> .....	<b>108</b>
<b>Callers List - 57i CT Cordless Handset</b> .....	<b>111</b>
<b>Making Calls from 57i CT Cordless Handset</b> .....	<b>113</b>
<b>Pre-dialling a Number</b> .....	<b>113</b>
<b>Using a Headset</b> .....	<b>113</b>
<b>Receiving Calls</b> .....	<b>113</b>
<b>Call Privacy</b> .....	<b>113</b>
<b>Ending Calls</b> .....	<b>114</b>
<b>Pairing and Unpairing Cordless Handset to Base</b> .....	<b>115</b>
<b>Pairing Handset</b> .....	<b>115</b>
<b>Unpairing Handset</b> .....	<b>117</b>
<b>Additional Features</b> .....	<b>120</b>
<b>Star Codes</b> .....	<b>120</b>
<b>Suppressing DTMF Playback</b> .....	<b>120</b>
<b>Display DTMF Digits</b> .....	<b>121</b>
<b>Stuttered Dial Tone</b> .....	<b>122</b>
<b>Play Call Waiting Tone</b> .....	<b>123</b>
<b>Incoming Intercom Calls and Auto-Answer</b> .....	<b>124</b>
<b>Using Redial Key for “Last Number Redial”</b> .....	<b>125</b>
<b>Ring Tones and Tone Sets</b> .....	<b>126</b>
<b>Time and Date</b> .....	<b>130</b>
<b>Locking and Unlocking the Phone</b> .....	<b>134</b>
<b>Resetting a User Password</b> .....	<b>136</b>
<b>Defining an Emergency Dial Plan</b> .....	<b>137</b>
<b>Language</b> .....	<b>139</b>
<b>Specifying the Language to Use</b> .....	<b>139</b>
<b>Model 536 and 560 Expansion Modules</b> .....	<b>141</b>
<b>Troubleshooting Solutions</b> .....	<b>143</b>
<b>Limited Warranty</b> .....	<b>147</b>
<b>Appendix A - Time Zone Codes</b> .....	<b>A-1</b>





## About this Guide

This guide explains how to use the basic features of your new 57i CT phone. Not all features listed are available by default. Contact your system or network administrator to find out which features and services are available to you on your system.

Your system administrator has the ability to customize some features on this phone. For information on more advanced settings and configurations, administrators should refer to the ***Aastra SIP 53i, 55i, 57i, and 57i CT IP Phone Administration Guide***.

## Documentation

- ***Aastra 57i CT IP Phone Installation Guide*** – Installation and set-up instructions, general features and functions, and basic options list customization. This Installation Guide is included with the telephone.
- ***Aastra 57i CT IP Phone User Guide*** – Describes the most commonly used features and functions for an end user.
- ***Aastra 53i, 55i, 57i, and 57i CT IP Phone Administration Guide*** – Describes how to set the 57i phone up on the network and contains advanced configuration instructions for the 57i. This guide has instructions that are at a user level.

## Introduction

This 57iCT IP telephone has all the features of a regular business phone, allowing you to make and receive calls, transfer, conference and more. The 57i CT IP telephone provides communications over an IP Network using the SIP IP telephony protocol.

### Phone Features

- 11 line graphical LCD screen (144 x 128 pixels) with white backlight
- 12 multi-functional softkeys
  - 6 Top Keys: Programmable static softkeys (up to 10 programmable functions)
  - 6 Bottom Keys: Programmable state-based softkeys (up to 20 programmable functions)
- 4 call appearance lines with LEDs
- Supports up to 9 call lines
- Full-duplex speakerphone for handsfree calls
- Headset support (modular connector)
- Built-in-two-port, 10/100 Ethernet switch - lets you share a connection with your computer.
- Inline power support (based on 802.3af standard) which eliminates power adapters.
- AC power adapter (included)
- Enhanced busy lamp fields\*
- Set paging\*

### *Cordless Handset Features*

- 5 line backlit display screen
- 2 multi-functional softkeys
- Programmable function key supports up to 14 functions
- Vibration Alerter
- Headset Jack
- Desk charging stand

\* Availability of feature dependant on your phone system or service provider.

### Requirements

The 57i CT IP Phone requires the following environment:

- SIP-based IP PBX system or network installed and running with a SIP account created for the 57i phone.
- Access to a Trivial File Transfer Protocol (TFTP), File Transfer Protocol (FTP), Hypertext Transfer Protocol (HTTP) server, or Hyper Text Transfer Protocol over Secure Sockets Layer (SSL) (HTTPS).
- 802.3af Ethernet/Fast Ethernet LAN
- Category 5/5e straight through cabling
- Power over Ethernet (PoE) inline power injector (optional accessory - necessary only if your network provides no inline power and if you do not use the IP Phone's power adapter).

## Installation and Setup

If your system administrator has not already setup your 57i CT phone, please refer to the ***Aastra 57i CT Installation Guide*** for basic installation and physical setup information. For more advanced administration and configuration information, system administrators should refer to the ***Aastra SIP 53i, 55i, 57i, 57i CT IP Phone Administrators Guide***.

## Getting Started

The 57i CT must be set up and be configured prior to its first use. This section describes phone behavior and start up screens you may see when the phone is first plugged in, or when it is restarted.

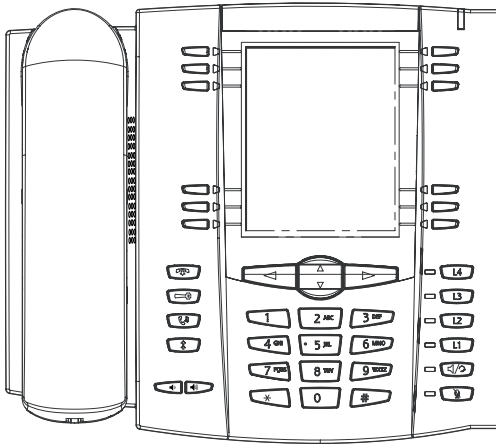

### Plugging in and Starting the Phone

The 57i CT automatically begins the start up sequence as soon as it is connected. The phone goes through this process the first time you plug in your phone and every time you restart your phone.

The phone displays the following startup screens.





The 57i CT phone then checks settings and looks for new configuration and firmware updates for the phone from a server. If a new update is found, the phone displays the message “**Updating Configuration**”. This may take a few moments while the phone downloads the latest updates.





**Note:** New updates to your phone can be automatically scheduled from the server. This is set up on the phone system by your system administrator and should be scheduled during non-business hours or slow call periods.

**Important! Do not unplug or remove power to the phone while it is checking or installing firmware and configuration information.**

If language packs were loaded to your phone by your system administrator, the following screen displays during startup.



When the configuration update is complete, the phone displays the following screens and then displays the Idle screen..





**Idle Screen**

## Network Connected/Network Disconnected

If your phone is successful when connecting to the network the following screen displays before changing to the Idle screen..



If your phone did not successfully connect to the network, the "**Network Disconnected**" prompt appears on the display and the telephone status light turns on.



Check that the cables are tightly connected to the phone and to the wall jack. The phone should automatically detect when it is reconnected and display the "**Network Connected**" prompt for a few seconds. However, if changes have been made to your phone's network settings, you may need to restart your phone.

For more information about connecting your phone, see the **Aastra 55i IP Phone Installation Guide**, the section "**Connecting to the Network and to Power**".

Check with your system or network administrator for assistance.

**Note:** If the phone displays "No Service" you can still use the phone but it is not registered with the Registrar. For more information about registering your phone, see your system administrator.



## Idle Screen

When the phone has successfully updated the configuration and connected to the network, the phone displays the **Idle State** screen. The idle screen is shown whenever your phone is not in use.



**Note:** Your system administrator sets up your SIP screen name, line number, and any other administrative features required. If your name does not display on the screen, contact your system administrator.

The **Idle State** screen lists your name (SIP screen name) and day, date, and time. In the above screen, the "L1" indicates John Smith is configured on Line 1.

The idle screen also displays the following default softkeys located on the top left and top right of the screen:

- Services
- Directory
- Callers List
- Intercom

When you lift the handset, the screen displays the default bottom softkeys of:

- Dial
- Conference
- Transfer.



You can configure the 6 top softkeys and the 6 bottom softkeys as required.

*Reference*

For more information about configuring the top default softkeys and all other softkeys, see ["Softkeys"](#) on [page 24](#).

For more information about using all of the default softkeys (Services, Directory, Callers List, Intercom, Dial, Conference, and Transfer), see the following sections:

- ["Making Calls"](#) on [page 65](#).
- ["Handling Calls"](#) on [page 73](#).
- ["Managing Calls"](#) on [page 80](#).

*Idle Screen With Softkeys Configured*

If you or your administrator have configured softkey functions on your phone, the labels for those functions display on the screen. For example, in the following illustration, "Home" was configured as a speedial key on the bottom set of softkeys and "Do Not Disturb" (DND) was configured on the top set of softkeys..

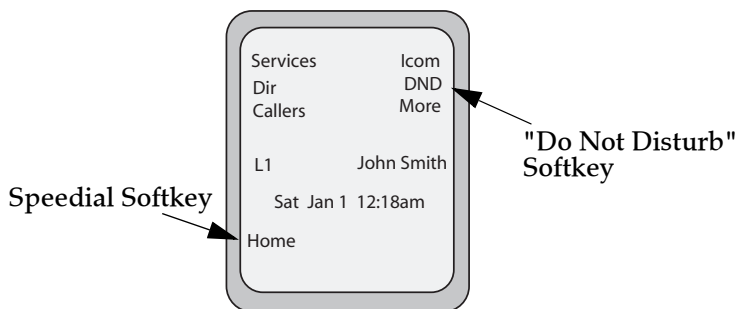

**Idle Screen**

You can configure up to 10 functions on the top set of softkeys. If you have additional functions configured on the top softkeys that do not display on the main idle screen, a **"More"** displays at the top right of the screen. Pressing the **More** softkey toggles between the first screen and a second screen of softkeys configured on your phone.

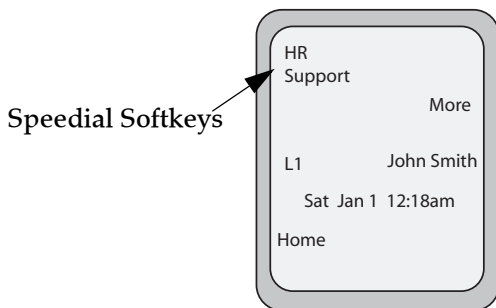

**Idle Screen**

## Idle Screen with Voicemail Messages

The envelope icon  displays on the Idle State screen only if you have new messages waiting. The number next to the envelope indicates how many new messages you have.

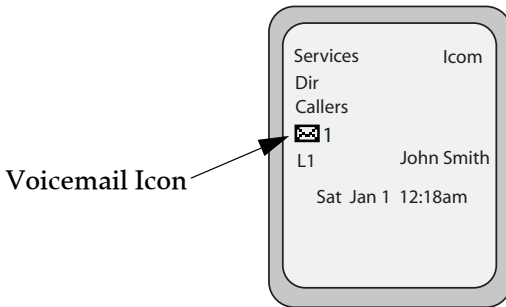

**Idle Screen**

To access your voicemail messages, use the star codes for your system if a voicemail softkey has not been configured on your phone. For more information on your system's star codes, please refer to the documentation for the voicemail system you are using.

### Screen Display After Picking Up the Handset

When you pickup the handset, the screen displays as follows:

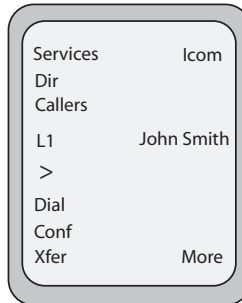

This screen displays the following default softkeys located on the bottom left of the screen:

- Dial
- Conference
- Transfer

A **More** softkey also displays at the bottom right of the screen if you have configured softkeys other than the default softkeys.

For example, if you configure a bottom softkey for speeddialing to Home, and then you pickup the handset, the screen displays the **Dial**, **Conf**, and **Xfer** default softkeys with a **More** softkey. You can press the **More** softkey to toggle between the first and second screens to display all configured softkeys. See illustrations below.



Idle Screen



After Handset Pickup



After Pressing "More"

**Note:** The bottom set of 6 softkeys map to the current state-based configurable softkeys. The top set of 6 softkeys allow you to configure up to 10 functions.

## Phone Options via the IP Phone UI

You can access specific options for the 57i CT IP phone using the phone's user interface (UI) via the keypad. Pressing the Option button  gives you a list of configurable options.

These options allow you to customize your phone settings.



1	Language
2	Time and Date 1 Time Server 2 Set Time 3 Time Format 4 Set Date 5 Date Format 6 Time Zone 7 Daylight Savings
3	Tones 1 Set Ring Tone 2 Tone Set
4	Clear Msg. Wtg.
5	Display 1 Contrast Level 2 Backlight
6	Live Dialpad
7	Set Audio Audio Mode  Advanced Setting Headset Mic Volume
8	Call Forward Number: Mode: No. Rings:
9	Network*
10	SIP Settings*
11	Phone Status 1 Network Status 2 Firmware Version 3 Restart Phone 4 Factory Default*
12	User Password
13	Phone Lock

**Note:** \*The "Network" and "SIP Settings" options are administrator level functions only, and are not accessible by the user. Under the "Phone Status" option, the "Factory Default" selection is also an administrator level function only. These options should only be set up and changed by your system administrator.



## IP Phone UI

---

1. Press the Options key  on the phone to enter the options list.
2. To go to an **Option**, use  $\triangle$  and  $\nabla$  to scroll through the list, or press the number corresponding to the **Option**.
3. Press the **Show** softkey, the  $\triangleright$  button, or press the digit number of the corresponding option to select an option.
4. Use the softkeys that display for each option to change a selected option.
5. Press the **Done** button to save the change.
6. Press the  button, the  $\triangleleft$  button, or the  button at any time to exit without saving changes.

### References

For more information about customizing your phone using the available options from the IP Phone UI, see the section "**Customizing Your Phone**" in the *Aastra 57i CT Installation Guide*.

For more information about administrator options, contact your system administrator.



## Phone Options via the Aastra Web UI

In addition to the IP Phone UI options, you can also customize additional options on the IP Phone using the Aastra Web UI. In order to access your phone using the Aastra Web UI, you need to know your phone's IP address.

### *Finding Your Phone's IP Address*



#### IP Phone UI

1. Press  to enter the Options List.
2. Use  to scroll down the list of options to **Phone Status** and press **Show**.

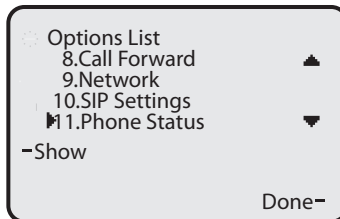

3. Use  to scroll to **Network Status** and press **Show**.

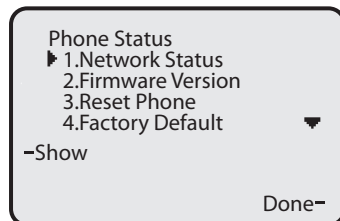

4. Press **IP Addr.**

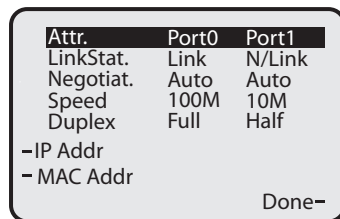

## 5. Your phone's IP Address displays.

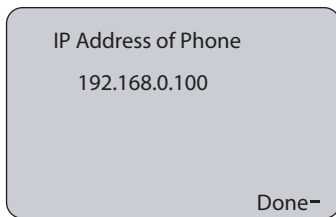

## Using the Aastra Web UI



1. Open your web browser and enter the phone's IP address or host name into the address field.

If the browser is using HTTP, the following redirect screen displays, followed by the "Security Alert" window. This process redirects HTTP to use HTTPS for a more secure connection..

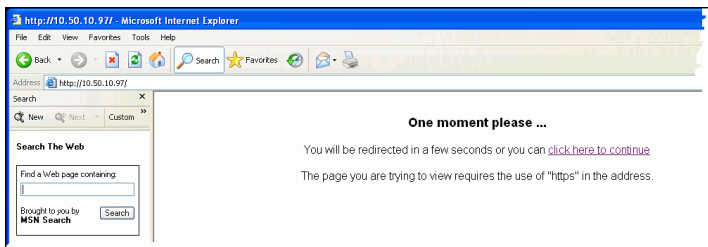

2. Click **YES** to accept the certificate



3. At the prompt, enter your username and password and click  .

The Network Status window displays for the IP phone you are accessing.

**Note:** For a user, the default user name is “**user**” and the password field is left blank.

The Network Status window displays for the IP phone you are accessing.

**AASTRA** 57i  
Log Off

**Status**

- System Information

**Operation**

- User Password
- Phone Lock
- Softkeys and XML
- Directory
- Reset
- Expansion Modules

**Basic Settings**

- Preferences
- Call Forward

**Network Status**

Attribute	Port 0	Port 1
Link State	Up	Down
Negotiation	Auto	Auto
Speed	10Mbps	10Mbps
Duplex	Half	Half

MAC Address: 00-08-5D-16-10-49

**Hardware Information**

Attribute	Value
Platform	57i Revision 0

**Firmware Information**

Attribute	Value
Firmware Version	2.0.0.1255
Firmware Release Code	SIP
Boot Version	1.1.0.1182
Date/Time	Oct 20 2006 11:44:23

4. You can logout of the Aastra Web UI at any time by clicking **Log Off**.

The following categories display in the side menu of the Aastra Web UI:  
**Status, Operation, Basic Settings.**

### Status

The **Status** section displays the network status and the MAC address of the IP phone. It also displays hardware and firmware information about the IP phone. The information in the Network Status window is read-only.

### Operation

The **Operation** section provides the following options:

- **User Password** - Allows you to change user password
- **Phone Lock** - Allows you to assign an emergency dial plan to the phone, lock the phone to prevent any changes to the phone and to prevent use of the phone, and reset the user password.
- **Softkeys and XML** - Allows you to configure up to 6 top softkeys and 6 bottom softkeys for a specific function (none, line, speedial, do not disturb (DND), Busy Lamp Field (BLF), BLF list, flash, Extensible Markup Language (XML), flash, sprecode, park, pickup, Last Call Return (lcr), Directory, Callers List, Conference, and Transfer.) You can configure up to 10 functions on the top softkeys and up to 20 functions on the bottom softkeys.
- **Directory** - Allows you to copy the Callers List and Directory List from your IP phone to your PC.
- **Reset** - Allows you to restart the IP phone when required.
- **Expansion Modules** - Allows you to configure an additional 36 softkeys (with 536EM) or 60 softkeys (with 560EM) if an expansion module is attached to the phone. If no expansion module is attached, the following message displays: "**No expansion modules are currently attached**".

## *Basic Settings*

The **Basic Settings** section provides the following options:

- **Preferences** - Allows you to enable/disable the following: static configuration of park/pickup, suppression of DTMF playback, display of DTMF digits, the playing of call waiting tone, and stuttered dial tone. This category also allows you to configure incoming intercom call settings, ring tones (global and per-line basis), and ring tone sets, time and date settings, and language settings.
- **Call Forward** - Allows you to set a phone number destination for where you want calls forwarded. Call forward can be configured using a specific mode (off, all, busy, no answer, busy no answer) on a global or per-line basis.

## User Password





This category allows you to change the user password for your phone. Changing your password ensures that only you can alter your phone settings, and helps keep your system secure. You can change your user password using the IP Phone UI or the Aastra Web UI.

If you change the password	you will need to:
using the IP Phone UI,	use that new password to log into the Aastra Web UI.
using the Aastra Web UI,	use that new password when changing the user password via the IP Phone UI.

**Note:** Valid values when creating or changing a password are 0 to 4294967295 (integers only; symbols and alpha characters are not allowed). Default password is an empty string "" (field is blank).



### IP Phone UI

1. Press  on the phone to enter the Options List.
2. Select **User Password** and press .
3. Enter the current user password and press .
4. Enter the new user password and press .
5. Re-enter the new user password and press .  
A message, "Password Changed" displays on the screen.



### Aastra Web UI

1. Click on **Operation->User Password**.

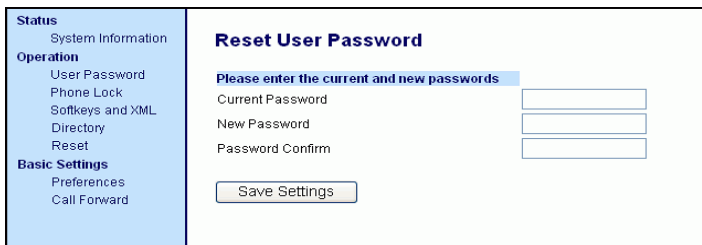

2. In the "**Current Password**" field, enter the current user password.  
**Note:** By default, the user name is "user" (all lowercase) and the password field is left blank.
3. In the "**New Password**" field, enter the new user password.
4. In the "**Password Confirm**" field, enter the new user password again.
5. Click  to save your changes.



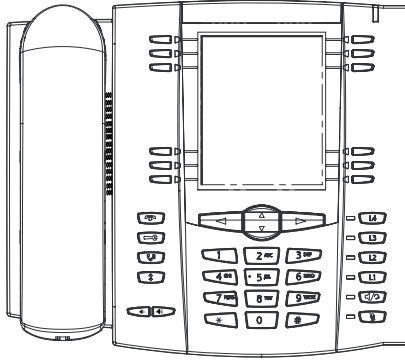

## Using Your 57i CT Base Unit Phone

The following sections describe the various 57i CT phone key functions, and how they help you make and manage your calls and caller information.





### 57i CT Base Unit Key Descriptions

The following table identifies the keys on the key panel of your 57i CT IP phone that you can use for handling calls.

Keys	Key Description
	<b>Goodbye key</b> - Ends an active call. The Goodbye key also exits an open list, such as the Options List, without saving changes.
	<b>Options key</b> - Accesses options to customize your phone. Your System Administrator may have already customized some of your settings. Check with your System Administrator before changing the administrator-only options.
	<b>Hold key</b> - Places an active call on hold. To retrieve a held call, press the call appearance button beside the light that is flashing.
	<b>Redial key</b> - Redials up to 100 previously dialed numbers. Pressing the Redial key twice simultaneously redials the last dialed number.
	<b>Volume control key</b> - Adjusts the volume for the handset, headset, ringer, and handsfree speaker.

Keys	Key Description
------	-----------------

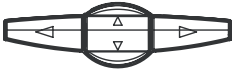
	<p><b>Line/Call Appearance key</b> - Connects you to a line or call. The Astra 57i CT IP phone supports up to 4 line keys.</p>
	<p><b>Handsfree key</b> - Activates Handsfree for making and receiving calls without lifting the handset. When the audio mode option is set, this key is used to switch between a headset and the handsfree speakerphone.</p>
	<p><b>Mute key</b> - Mutes the microphone so that your caller cannot hear you (the light indicator flashes when the microphone is on mute).</p>
	<p><b>Navigation keys</b> - Pressing the UP and DOWN arrow keys lets you view different status and text messages on the LCD display (if there is more than 1 line of status/text messages). These buttons also let you scroll through menu selections, such as the Options List.</p> <p>Pressing the LEFT and RIGHT arrow keys lets you view the different line/call appearances. While in the Options List, these keys allow you to exit or enter the current option. When you are editing entries on the display, pressing the LEFT arrow key erases the character on the left; pressing the RIGHT arrow key sets the option.</p>

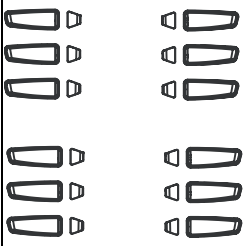
Keys	Key Description
	<p><b>Softkeys</b> - 12 softkeys on the 57i CT IP Phone.</p> <ul style="list-style-type: none"> <li>- 6 Top Keys: programmable static softkeys (up to 10 programmable functions)</li> <li>- 6 Bottom Keys: programmable state-based softkeys (up to 20 programmable functions)</li> </ul> <p>These keys also perform as follows:</p> <ul style="list-style-type: none"> <li>• <b>Callers list key</b> - Accesses the last 200 calls received.</li> <li>• <b>Conference key</b> - Begins a conference call with the active call.</li> <li>• <b>Xfer Key</b> - Transfers the active call to another number.</li> <li>• <b>Directory Key</b> - Displays up to 200 names and phone numbers (stored in alphabetical order)</li> </ul> <p><b>Note:</b> For more information about programming the softkeys to perform specific functions, see the <i>Aastra Model 57i CT User Guide</i>.</p>

## Multiple Line and Call Appearances

The 57i CT has 4 hard line/call appearance buttons each with a corresponding status light. These line/call appearance buttons and lights can represent physical lines, calls for your extension or calls from a group that your extension is part of. By pressing a line/call appearance button, you connect to the line or a call it represents. The line/call appearance light indicates the status of that line or call. When the phone is taken off-hook, the phone automatically selects a line for you.

<b>Line/Call Appearance Light Behavior</b>	<b>Line/Call Appearance Status</b>
Off	Idle line or no call activity
Light flashes quickly	Ringing
Light is solid	Connected
Light flashes slowly	Hold

When you have more than one call, you can use the left and right navigation buttons (◀ and ▶) to scroll left and right to the different call information. Icons ◀ and ▶ will appear if there is call information either left, right or both sides of the current information you are viewing.

The display shows which line the call information is referring to (L1, L2, L3, etc.), the Caller ID information (name and number, if available), the call status (Connected, Ring, Hold etc.) and the timer specific to that call.

## Softkeys

Your 57i CT has 12 multi-functional softkeys:

- **6 Top Keys:** programmable static softkeys (up to 10 programmable functions)
- **6 Bottom Keys:** programmable state-based softkeys (up to 20 programmable functions).

**Note:** If 536 or 560 Expansion Module(s) are attached to the phone, click on **Operation->Expansion Keys** to access and configure up to 36 softkeys on each 536EM and up to 60 softkeys on each 560EM. (Phone allows up to 3 expansion modules totaling up to 108 additional softkeys on the 536EM and up to 180 softkeys on the 560EM). These keys allow you to configure BLF, Speeddial, and Shared Call Appearance functions only. For more information about expansion modules, see "[Model 536 and 560 Expansion Modules](#)" on [page 141](#).

You can program these softkeys for call handling and extension management of the SIP system. The softkey menus on the IP phone UI change depending on the phone's state, displaying relevant softkeys only.

**Note:** The softkey functions outlined in this section represent the default arrangement of softkeys on the 57i CT IP phone. Only the bottom softkeys are state-based.

The 57i CT default softkeys are shown in the following illustration.

### Top Softkeys

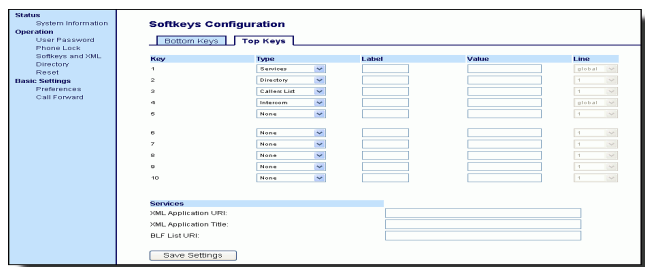

### Bottom Softkeys

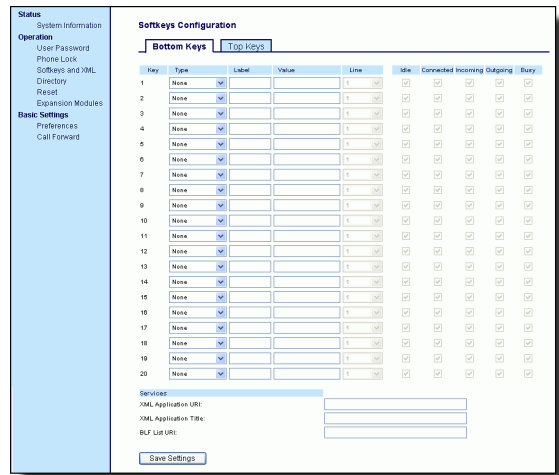



## Softkey Functions

You can configure the 57i CT softkeys for any of the following:

Softkey Function	Description
<b>None</b>	Indicates softkey is disabled (option for Web UI only)
<b>Line</b>	Indicates softkey is configured for line use.
<b>Speedial</b>	Indicates softkey is configured for speedial use.
<b>Do Not Disturb (DND)</b>	Indicates softkey is configured for "do not disturb" use.
<b>BLF</b>	Indicates softkey is configured for Busy Lamp Field (BLF) use. A user can dial out on a BLF configured softkey.
<b>BLF\List</b>	Indicates softkey is configured for BLF list use. A user can dial out on a BLF\List configured softkey.
<b>XML</b>	Indicates the softkey is configured to accept an XML application for accessing customized XML services. You can also use this option to configure an XML URI softkey.
<b>Flash</b>	Indicates the softkey is set to generate a flash event when it is pressed, or when a feature key is pressed on the 57i CT handset. The IP phone generates flash events only when a call is connected and there is an active RTP stream (for example, when the call is not on hold.)
<b>Sprecode</b>	Indicates the softkey is set to automatically activate specific services offered by the server. For example, if the spre value of *82 is configured, then by pressing the softkey, *82 automatically activates a service provided by the server. The value you enter for this field is dependent on the services provided by the server.
<b>Park</b>	Indicates the softkey is set to be used as a park key to park an incoming call.
<b>Pickup</b>	Indicates the softkey is set to be used as a pickup key to pick up a parked call.
<b>Last Call Return (lcr)</b>	Indicates the softkey is set to be used as a "last call return" key.

<b>Services</b>	Indicates the softkey is set to be used as the Services key.
<b>Callers List</b>	Indicates the softkey is set for accessing the Callers List.
<b>Directory</b>	Indicates the softkey is set for accessing the Directory List.
<b>Intercom</b>	Indicates the softkey is set to be used as the Intercom key.
<b>Empty</b>	Indicates the softkey is configured to force a blank entry on the IP phone display for a specific softkey. The soft keys are added in order (from softkey1 to softkey20) after any hard-coded keys have been added. If a particular soft key is not defined, it is ignored.

### State-Based Softkeys (Bottom Keys only)

On the 57i CT bottom softkeys, you can configure a specific state to display when a softkey is being used. Available states you can configure for each softkey include:

- **idle** - The phone is not being used.
- **connected** - The current line is in an active call (or the call is on hold)
- **incoming** - The phone is ringing.
- **outgoing** - The user is dialing a number, or the far-end is ringing.
- **busy** - The current line is busy because the line is in use or the line is set as "Do Not Disturb".

The following table identifies the applicable default states for each softkeys type on the IP phone.

Softkey Type	Default States
None	All states disabled.
Line	idle, connected, incoming, outgoing, busy
DND	idle, connected, incoming, outgoing, busy
Speeddial	idle, connected, incoming, outgoing, busy
BLF	idle, connected, incoming, outgoing, busy
BLF List	idle, connected, incoming, outgoing, busy
XML	idle, connected, incoming, outgoing, busy
lcr	idle, connected, incoming, outgoing, busy
Directory	idle, connected, incoming, outgoing, busy
Callers List	idle, connected, incoming, outgoing, busy
Intercom	idle, connected, incoming, outgoing, busy

Softkey Type	Default States
Services	idle, connected, incoming, outgoing, busy
empty	idle, connected, incoming, outgoing, busy
Flash	All states disabled.
Sprecode	connected
Park	connected
Pickup	idle, outgoing

In the Aastra Web UI, the operational states for each softkey display enabled. To disable a state, you uncheck the box for that operational state.

The IP phone idle screen condenses the softkeys. For example, if you set softkey 12 as the following:

**Type:** speeddial

**Label:** Voicemail

**Value** \*89

**State:** outgoing

then softkey 12 appears in position 1 if no other softkeys are set. A softkey type of "empty" does not display on the idle screen at all.

## Softkeys as Line/Call Appearances

You can customize the softkeys on your 57i CT phone to function as line/call appearance softkeys. These line/call appearance softkeys function in a similar manner to the 4 line/call appearance hard keys and lights on your phone. For details on the line/call appearance hard keys and lights, please refer to the section "[Multiple Line and Call Appearances](#)" on page 23 of this manual.

Lines/call appearance softkeys appear on the phone's display as shown in the following image.

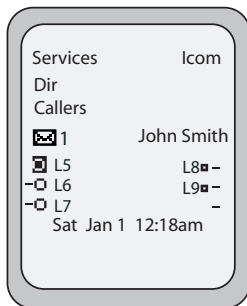

Icons next to the softkeys within the phone's display indicate the status for that line or call and have equivalent status to the line/call appearance lights of the hard keys on the phone. The following table provides a description for each icon.

Softkey Line/Call Appearance Lights			
Activity	Light	Icon	Definition
Idle	Solid	■	There is no call activity for the line/call appearance softkey.
Connected	Solid	○	A call is connected to your phone on this line/call appearance softkey. The equivalent on a line/call appearance hard key is a solid green light.
Ringing	Flashing	○	A call is ringing at your phone on this line/call appearance softkey. The equivalent on a line/call appearance hard key is a fast flashing green light.
On Hold	Flashing	◻	A call is on hold on your phone on this line/call appearance softkey. The equivalent on a line/call appearance hard key is a slow flashing green light.

Depending on how the phone has been configured, the maximum number of total line/call appearances that can be set up is 8 or 9 (4 line/call appearance as hard keys and 4 or 5 as softkeys). If all line/call appearances have been set up for the same number, a total of 9 lines can be configured. If all line/call appearances have been set up between two different numbers, a total of 8 lines can be configured. This means that when all line/call appearances are in use, 1 call is connected while the rest are on hold. No further outgoing or incoming calls can be made until one of the line/call appearances becomes available.

In active states, such as ringing, conference, connected, etc., all softkeys disappear except softkeys that have been set up as line/call appearances, and any context dependent softkeys required for the active state, such as the **DROP** softkey in the connected state. Typically, context dependent softkeys appear in the top left position and all line/call appearance softkeys appear in the remaining positions.

**Note:** In some situations, such as during a conference call, the line/call appearance softkeys may overwrite some of the context dependent soft keys. In this case, instead of the **Previous** and **Next** softkeys, up or down icons, ▾ ▴ appear on the display. By using the ▾ ▴ navigation keys, you can access the same functionality as the **Previous** and **Next** softkeys.

## Setting a Line Softkey

You can set a softkey as an additional line on the 57i CT. The softkey acts as a line that behaves the same as a hard line key. For more information about the behavior of line keys, see "[Multiple Line and Call Appearances](#)" on [page 23](#).

You can use the Aastra Web UI only to set a softkey as a line. On the 57i CT, you can set the top softkeys with up to 10 functions and the bottom softkeys with up to 20 functions.



Aastra Web UI

Use the following procedure to set a softkey to function as a line.

### 1. Click on **Operation->Softkeys and XML**.

Key	Type	Label	Value	Line	Idle	Connected	Incoming	Outgoing	Busy
1	Speedial	labtest	1111	2	<input checked="" type="checkbox"/>	<input checked="" type="checkbox"/>	<input checked="" type="checkbox"/>	<input checked="" type="checkbox"/>	<input checked="" type="checkbox"/>
2	Speedial	Portal		1	<input checked="" type="checkbox"/>	<input checked="" type="checkbox"/>	<input checked="" type="checkbox"/>	<input checked="" type="checkbox"/>	<input checked="" type="checkbox"/>
3	Speedial	Speed Dial	1111	1	<input checked="" type="checkbox"/>	<input checked="" type="checkbox"/>	<input checked="" type="checkbox"/>	<input checked="" type="checkbox"/>	<input checked="" type="checkbox"/>
4	Speedial	Call Return	*69	1	<input checked="" type="checkbox"/>	<input checked="" type="checkbox"/>	<input checked="" type="checkbox"/>	<input checked="" type="checkbox"/>	<input checked="" type="checkbox"/>
5	Speedial	Pickup	*98	1	<input checked="" type="checkbox"/>	<input checked="" type="checkbox"/>	<input checked="" type="checkbox"/>	<input checked="" type="checkbox"/>	<input checked="" type="checkbox"/>
6	Speedial	CallFwdOn	*72	1	<input checked="" type="checkbox"/>	<input checked="" type="checkbox"/>	<input checked="" type="checkbox"/>	<input checked="" type="checkbox"/>	<input checked="" type="checkbox"/>
7	Speedial	CallFwdOff	*73	1	<input checked="" type="checkbox"/>	<input checked="" type="checkbox"/>	<input checked="" type="checkbox"/>	<input checked="" type="checkbox"/>	<input checked="" type="checkbox"/>
8	Speedial	DND On	*78	1	<input checked="" type="checkbox"/>	<input checked="" type="checkbox"/>	<input checked="" type="checkbox"/>	<input checked="" type="checkbox"/>	<input checked="" type="checkbox"/>
9	Speedial	DND Off	*79	1	<input checked="" type="checkbox"/>	<input checked="" type="checkbox"/>	<input checked="" type="checkbox"/>	<input checked="" type="checkbox"/>	<input checked="" type="checkbox"/>
10	Speedial	CLIDBlock	*87	1	<input checked="" type="checkbox"/>	<input checked="" type="checkbox"/>	<input checked="" type="checkbox"/>	<input checked="" type="checkbox"/>	<input checked="" type="checkbox"/>
11	Speedial	Trace	*57	1	<input checked="" type="checkbox"/>	<input checked="" type="checkbox"/>	<input checked="" type="checkbox"/>	<input checked="" type="checkbox"/>	<input checked="" type="checkbox"/>
12	Speedial	Clear MWI	*99	1	<input checked="" type="checkbox"/>	<input checked="" type="checkbox"/>	<input checked="" type="checkbox"/>	<input checked="" type="checkbox"/>	<input checked="" type="checkbox"/>
13	Speedial	Cancel CW	*70	1	<input checked="" type="checkbox"/>	<input checked="" type="checkbox"/>	<input checked="" type="checkbox"/>	<input checked="" type="checkbox"/>	<input checked="" type="checkbox"/>
14	Speedial	Unpark	*88	1	<input checked="" type="checkbox"/>	<input checked="" type="checkbox"/>	<input checked="" type="checkbox"/>	<input checked="" type="checkbox"/>	<input checked="" type="checkbox"/>
15	None			1	<input type="checkbox"/>	<input checked="" type="checkbox"/>	<input checked="" type="checkbox"/>	<input checked="" type="checkbox"/>	<input checked="" type="checkbox"/>
16	None			1	<input type="checkbox"/>	<input checked="" type="checkbox"/>	<input checked="" type="checkbox"/>	<input checked="" type="checkbox"/>	<input checked="" type="checkbox"/>
17	None			1	<input type="checkbox"/>	<input checked="" type="checkbox"/>	<input checked="" type="checkbox"/>	<input checked="" type="checkbox"/>	<input checked="" type="checkbox"/>
18	None			1	<input type="checkbox"/>	<input checked="" type="checkbox"/>	<input checked="" type="checkbox"/>	<input checked="" type="checkbox"/>	<input checked="" type="checkbox"/>
19	None			1	<input type="checkbox"/>	<input checked="" type="checkbox"/>	<input checked="" type="checkbox"/>	<input checked="" type="checkbox"/>	<input checked="" type="checkbox"/>
20	None			1	<input type="checkbox"/>	<input checked="" type="checkbox"/>	<input checked="" type="checkbox"/>	<input checked="" type="checkbox"/>	<input checked="" type="checkbox"/>

### 2. Click on the **Bottom Keys** tab or the **Top Keys** tab.

### 3. Select from "**Key 1**" through "**Key 20**" on the bottom tab.

or

Select from "**Key 1**" through "**Key 10**" on the top tab.

### 4. In the "**Type**" field, select **Line** to apply to the softkey.

### 5. In the "**Label**" field, enter a label to apply to this softkey.

### 6. In the "**Line**" field, select a line to apply to this softkey.

Valid values are 5 through 9.

### 7. If configuring a softkey on the Bottom Keys, in the state fields, check (enable) or uncheck (disable) the states you want to apply to this softkey.

### 8. Click to save your changes.

### 9. Click on **Operation->Reset**.

### 10. In the "**Restart Phone**" field click to restart the IP phone.

## Softkeys as Speeddials

You can set up custom softkeys as speeddials. Speeddial softkeys can dial a star code for a feature on the system or a phone number or a set of digits. A customized label displays inside the phone's display for each softkey. If you press a custom softkey, the phone goes off-hook and dials the star code or the number set up for this softkey.

### *Setting a Speeddial Softkey*

The speeddial function can be set using the IP Phone UI or the Aastra Web UI.

You can save up to 30 speed dial numbers and names on the 57i CT. These can be programmed to dial directly to another person's line or extension, or set up to quickly access features such as Caller ID (\*69), Voicemail.

Use the following procedures to set speeddial on the 57i CT IP phone.

### *Entering a Name/Number for Speeddial Key*



#### IP Phone UI

---

To enter a number and name in a programmable key:

1. Press the **Save** key. The screen displays "**Save to?**"

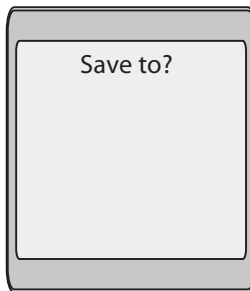

2. Select a softkey you want to save to.
3. At the "**Enter Number**" prompt, use the dial pad key to enter the number.

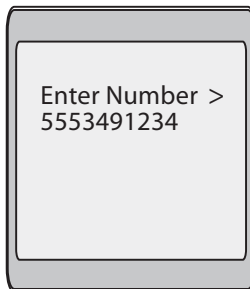

4. Press the **Save** key to save the speeddial configuration.
5. At the "**Enter Name**" prompt, use the dial pad keys to select the letters.

Continue to press the number key to access the next letter for that key (i.e. press **2** three times to access **C**). Press  $\triangleright$  to move to the next space, or wait a moment and the cursor automatically advances. To insert a space between letters, press  $\triangleright$  . To backspace and erase a mistake, press  $\triangleleft$  or the **Delete** key. You can save up to 16 letters and numbers on each softkey entry.



6. Press the **Save** key to finish.







On the 57i CT, you can set the top softkeys with up to 10 speeddials and the bottom softkeys with up to 20 speeddials.

1. Click on **Operation->Softkeys and XML.**

Key	Type	Label	Value	Line	Idle	Connected	Incoming	Outgoing	Busy
1	Speeddial	labtest	1111	2	<input checked="" type="checkbox"/>	<input checked="" type="checkbox"/>	<input checked="" type="checkbox"/>	<input checked="" type="checkbox"/>	<input checked="" type="checkbox"/>
2	Speeddial	Portal		1	<input checked="" type="checkbox"/>	<input checked="" type="checkbox"/>	<input checked="" type="checkbox"/>	<input checked="" type="checkbox"/>	<input checked="" type="checkbox"/>
3	Speeddial	Speed Dial	1111	1	<input checked="" type="checkbox"/>	<input checked="" type="checkbox"/>	<input checked="" type="checkbox"/>	<input checked="" type="checkbox"/>	<input checked="" type="checkbox"/>
4	Speeddial	Call Return	*69	1	<input checked="" type="checkbox"/>	<input checked="" type="checkbox"/>	<input checked="" type="checkbox"/>	<input checked="" type="checkbox"/>	<input checked="" type="checkbox"/>
5	Speeddial	Pickup	*98	1	<input checked="" type="checkbox"/>	<input checked="" type="checkbox"/>	<input checked="" type="checkbox"/>	<input checked="" type="checkbox"/>	<input checked="" type="checkbox"/>
6	Speeddial	CallFwdOn	*72	1	<input checked="" type="checkbox"/>	<input checked="" type="checkbox"/>	<input checked="" type="checkbox"/>	<input checked="" type="checkbox"/>	<input checked="" type="checkbox"/>
7	Speeddial	CallFwdOff	*73	1	<input checked="" type="checkbox"/>	<input checked="" type="checkbox"/>	<input checked="" type="checkbox"/>	<input checked="" type="checkbox"/>	<input checked="" type="checkbox"/>
8	Speeddial	DND On	*78	1	<input checked="" type="checkbox"/>	<input checked="" type="checkbox"/>	<input checked="" type="checkbox"/>	<input checked="" type="checkbox"/>	<input checked="" type="checkbox"/>
9	Speeddial	DND Off	*79	1	<input checked="" type="checkbox"/>	<input checked="" type="checkbox"/>	<input checked="" type="checkbox"/>	<input checked="" type="checkbox"/>	<input checked="" type="checkbox"/>
10	Speeddial	CLIDBlock	*67	1	<input checked="" type="checkbox"/>	<input checked="" type="checkbox"/>	<input checked="" type="checkbox"/>	<input checked="" type="checkbox"/>	<input checked="" type="checkbox"/>
11	Speeddial	Trace	*67	1	<input checked="" type="checkbox"/>	<input checked="" type="checkbox"/>	<input checked="" type="checkbox"/>	<input checked="" type="checkbox"/>	<input checked="" type="checkbox"/>
12	Speeddial	Clear MWI	*99	1	<input checked="" type="checkbox"/>	<input checked="" type="checkbox"/>	<input checked="" type="checkbox"/>	<input checked="" type="checkbox"/>	<input checked="" type="checkbox"/>
13	Speeddial	Cancel CW	*70	1	<input checked="" type="checkbox"/>	<input checked="" type="checkbox"/>	<input checked="" type="checkbox"/>	<input checked="" type="checkbox"/>	<input checked="" type="checkbox"/>
14	Speeddial	Unpak	*88	1	<input checked="" type="checkbox"/>	<input checked="" type="checkbox"/>	<input checked="" type="checkbox"/>	<input checked="" type="checkbox"/>	<input checked="" type="checkbox"/>
15	None			1	<input checked="" type="checkbox"/>	<input checked="" type="checkbox"/>	<input checked="" type="checkbox"/>	<input checked="" type="checkbox"/>	<input checked="" type="checkbox"/>
16	None			1	<input checked="" type="checkbox"/>	<input checked="" type="checkbox"/>	<input checked="" type="checkbox"/>	<input checked="" type="checkbox"/>	<input checked="" type="checkbox"/>
17	None			1	<input checked="" type="checkbox"/>	<input checked="" type="checkbox"/>	<input checked="" type="checkbox"/>	<input checked="" type="checkbox"/>	<input checked="" type="checkbox"/>
18	None			1	<input checked="" type="checkbox"/>	<input checked="" type="checkbox"/>	<input checked="" type="checkbox"/>	<input checked="" type="checkbox"/>	<input checked="" type="checkbox"/>
19	None			1	<input checked="" type="checkbox"/>	<input checked="" type="checkbox"/>	<input checked="" type="checkbox"/>	<input checked="" type="checkbox"/>	<input checked="" type="checkbox"/>
20	None			1	<input checked="" type="checkbox"/>	<input checked="" type="checkbox"/>	<input checked="" type="checkbox"/>	<input checked="" type="checkbox"/>	<input checked="" type="checkbox"/>

2. Click on the **Bottom Keys** tab or the **Top Keys** tab.
3. Select from **"Key 1"** through **"Key 20"** on the bottom tab.  
or  
Select from **"Key 1"** through **"Key 10"** on the top tab.
4. In the **"Type"** field, select **Speeddial** to apply to the softkey.
5. In the **"Label"** field, enter a label to apply to this softkey.
6. In the **"Value"** field, enter the phone number or extension to apply to this softkey.
7. In the **"Line"** field, select a line to apply to this softkey.  
Valid values are 1 through 9.
8. If configuring a softkey on the Bottom Keys, in the state fields, check (enable) or uncheck (disable) the states you want to apply to this softkey.
9. Click  to save your changes.
10. Click on **Operation->Reset**.
11. In the **"Restart Phone"** field click  to restart the IP phone.

## *Saving an Entry from the Redial, Callers, or Directory Lists to a Speedial key*



### IP Phone UI

Use the following procedure to save an entry from your Directory List, Callers List, or Redial List on the IP phone.

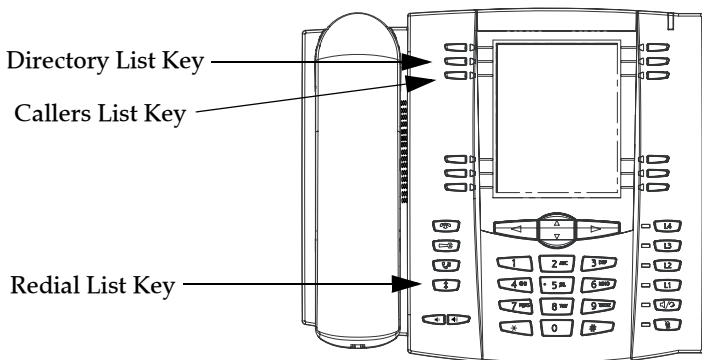

1. Press the Directory List, Callers List, or Redial List key. From the Callers List or Redial List, scroll through the list to find the name and number that you wish to save to your speed dial.
2. Press the **Save** key.
3. Press the selected speed dial. If the name is displayed with the number, both are saved to the speed dial. If no name is displayed, you can enter the name using the dial pad.

## Softkeys as "Do not Disturb"

The IP phones have a feature you can enable called "Do not Disturb (DND)". The DND function allows you to turn "do not disturb" ON and OFF.

**Note:** You can configure DND using the Aastra Web UI only.

If DND is ON, callers calling into the phone hear a busy signal or a message, depending on how your system administrator set up the configuration server. The second line on the screen of the IP phone shows when DND is set.

If the phone shares a line with other phones, only the phone that has DND configured is affected.

You can set DND on the softkeys using the Aastra Web UI only. DND is not configurable from the IP phone UI.

### Setting a "Do Not Disturb" Softkey



Aastra Web UI

#### Setting "Do Not Disturb" Softkey

##### 1. Click on **Operation->Softkeys and XML.**

Key	Type	Label	Value	Line	Idle	Connected	Incoming	Outgoing	Busy
1	Speedial	labstat	1111	2	<input checked="" type="checkbox"/>	<input checked="" type="checkbox"/>	<input checked="" type="checkbox"/>	<input checked="" type="checkbox"/>	<input checked="" type="checkbox"/>
2	Speedial	Portal	1111	1	<input checked="" type="checkbox"/>	<input checked="" type="checkbox"/>	<input checked="" type="checkbox"/>	<input checked="" type="checkbox"/>	<input checked="" type="checkbox"/>
3	Speedial	Speed Dial	1111	1	<input checked="" type="checkbox"/>	<input checked="" type="checkbox"/>	<input checked="" type="checkbox"/>	<input checked="" type="checkbox"/>	<input checked="" type="checkbox"/>
4	Speedial	Call Return	90	1	<input checked="" type="checkbox"/>	<input checked="" type="checkbox"/>	<input checked="" type="checkbox"/>	<input checked="" type="checkbox"/>	<input checked="" type="checkbox"/>
5	Speedial	Pickup	98	1	<input checked="" type="checkbox"/>	<input checked="" type="checkbox"/>	<input checked="" type="checkbox"/>	<input checked="" type="checkbox"/>	<input checked="" type="checkbox"/>
6	Speedial	CallFwdOn	72	1	<input checked="" type="checkbox"/>	<input checked="" type="checkbox"/>	<input checked="" type="checkbox"/>	<input checked="" type="checkbox"/>	<input checked="" type="checkbox"/>
7	Speedial	CallFwdOff	73	1	<input checked="" type="checkbox"/>	<input checked="" type="checkbox"/>	<input checked="" type="checkbox"/>	<input checked="" type="checkbox"/>	<input checked="" type="checkbox"/>
8	Speedial	DND On	78	1	<input checked="" type="checkbox"/>	<input checked="" type="checkbox"/>	<input checked="" type="checkbox"/>	<input checked="" type="checkbox"/>	<input checked="" type="checkbox"/>
9	Speedial	DND Off	79	1	<input checked="" type="checkbox"/>	<input checked="" type="checkbox"/>	<input checked="" type="checkbox"/>	<input checked="" type="checkbox"/>	<input checked="" type="checkbox"/>
10	Speedial	CLIDBlock	87	1	<input checked="" type="checkbox"/>	<input checked="" type="checkbox"/>	<input checked="" type="checkbox"/>	<input checked="" type="checkbox"/>	<input checked="" type="checkbox"/>
11	Speedial	Trace	87	1	<input checked="" type="checkbox"/>	<input checked="" type="checkbox"/>	<input checked="" type="checkbox"/>	<input checked="" type="checkbox"/>	<input checked="" type="checkbox"/>
12	Speedial	ClearMNM	89	1	<input checked="" type="checkbox"/>	<input checked="" type="checkbox"/>	<input checked="" type="checkbox"/>	<input checked="" type="checkbox"/>	<input checked="" type="checkbox"/>
13	Speedial	Cancel CW	70	1	<input checked="" type="checkbox"/>	<input checked="" type="checkbox"/>	<input checked="" type="checkbox"/>	<input checked="" type="checkbox"/>	<input checked="" type="checkbox"/>
14	Speedial	Unpark	88	1	<input checked="" type="checkbox"/>	<input checked="" type="checkbox"/>	<input checked="" type="checkbox"/>	<input checked="" type="checkbox"/>	<input checked="" type="checkbox"/>
15	None			1	<input type="checkbox"/>	<input checked="" type="checkbox"/>	<input checked="" type="checkbox"/>	<input checked="" type="checkbox"/>	<input checked="" type="checkbox"/>
16	None			1	<input type="checkbox"/>	<input checked="" type="checkbox"/>	<input checked="" type="checkbox"/>	<input checked="" type="checkbox"/>	<input checked="" type="checkbox"/>
17	None			1	<input type="checkbox"/>	<input checked="" type="checkbox"/>	<input checked="" type="checkbox"/>	<input checked="" type="checkbox"/>	<input checked="" type="checkbox"/>
18	None			1	<input type="checkbox"/>	<input checked="" type="checkbox"/>	<input checked="" type="checkbox"/>	<input checked="" type="checkbox"/>	<input checked="" type="checkbox"/>
19	None			1	<input type="checkbox"/>	<input checked="" type="checkbox"/>	<input checked="" type="checkbox"/>	<input checked="" type="checkbox"/>	<input checked="" type="checkbox"/>
20	None			1	<input type="checkbox"/>	<input checked="" type="checkbox"/>	<input checked="" type="checkbox"/>	<input checked="" type="checkbox"/>	<input checked="" type="checkbox"/>

##### 2. Click on the **Bottom Keys** tab or the **Top Keys** tab.

##### 3. Select from "Key 1" through "Key 20" on the bottom tab.

or

Select from "Key 1" through "Key 10" on the top tab.

##### 4. In the "Type" field, select **Do Not Disturb** to apply to the softkey.

##### 5. If configuring a softkey on the Bottom Keys, in the state fields, check (enable) or uncheck (disable) the states you want to apply to this softkey.

##### 6. Click to save your changes.

##### 7. Click on **Operation->Reset**.

##### 8. In the "Restart Phone" field click to restart the IP phone.

## Softkeys as Busy Lamp Field (BLF)

You can set a softkey to Busy Lamp Field (BLF).

The BLF feature on the IP phones allows a specific extension to be monitored for state changes. BLF monitors the status (busy or idle) of extensions on the IP phone.

**Note:** The BLF setting is applicable to the Asterisk server only.

### Example

A Supervisor configures BLFs on his phone for monitoring the status of a worker's phone use (busy or idle). When the worker picks up his phone to make a call, a busy indicator on the Supervisor's phone shows that the worker's phone is in use and busy.

On the 57i CT, the busy and idle indicators show on the IP phone screen display next to the softkey programmed for BLF functionality. When the monitored user is idle, an icon with the handset on-hook shows next to the BLF softkey. When the monitored user is on an active call, a small telephone icon is shown with the handset off-hook.

**Note:** You can also use the BLF configured softkey to dial out. Contact your system administrator for more information.

### Setting a BLF Softkey



Aastra Web UI

#### 1. Click on **Operation->Softkeys and XML.**

Status  
System Information

**Operation**  
User Password  
Phone Lock  
Softkeys and XML  
Directory  
Reset

**Basic Settings**  
Preferences  
Call Forward

### Softkeys Configuration

Bottom Keys
Top Keys

Key	Type	Label	Value	Line	Idle	Connected	Incoming	Outgoing	Busy
1	Speedial	labtest	1111	2	✓	✓	✓	✓	✓
2	Speedial	Portal		1	✓	✓	✓	✓	✓
3	Speedial	Speed Dial	1111	1	✓	✓	✓	✓	✓
4	Speedial	Call Return	*99	1	✓	✓	✓	✓	✓
5	Speedial	Pickup	*98	1	✓	✓	✓	✓	✓
6	Speedial	CallfwdOn	*72	1	✓	✓	✓	✓	✓
7	Speedial	CallfwdOff	*73	1	✓	✓	✓	✓	✓
8	Speedial	DND On	*78	1	✓	✓	✓	✓	✓
9	Speedial	DND Off	*79	1	✓	✓	✓	✓	✓
10	Speedial	CLIDBlock	*67	1	✓	✓	✓	✓	✓
11	Speedial	Trace	*57	1	✓	✓	✓	✓	✓
12	Speedial	Clear MWI	*99	1	✓	✓	✓	✓	✓
13	Speedial	Cancel CW	*70	1	✓	✓	✓	✓	✓
14	Speedial	Unpak	*88	1	✓	✓	✓	✓	✓
15	None			1	✓	✓	✓	✓	✓
16	None			1	✓	✓	✓	✓	✓
17	None			1	✓	✓	✓	✓	✓
18	None			1	✓	✓	✓	✓	✓
19	None			1	✓	✓	✓	✓	✓
20	None			1	✓	✓	✓	✓	✓

#### 2. Click on the **Bottom Keys** tab or the **Top Keys** tab.

3. Select from "**Key 1**" through "**Key 20**" on the bottom tab.  
or  
Select from "**Key 1**" through "**Key 10**" on the top tab.

4. In the "**Type**" field, select **BLF** to apply to the softkey.
5. In the "**Label**" field, enter a label to apply to this softkey.
6. In the "**Value**" field, enter the phone number or extension you want to monitor.
7. In the "**Line**" field, select a line for which to apply this softkey.  
Valid values are 1 through 9.
8. If configuring a softkey on the Bottom Keys, in the state fields, check (enable) or uncheck (disable) the states you want to apply to this softkey.
9. Click  to save your changes.
10. Click on **Operation->Reset**.
11. In the "**Restart Phone**" field click  to restart the IP phone.

## Softkeys as BLF List

*(For use with the BroadSoft Broadworks Rel 13 or higher platform only)*

You can set a softkey to BLF list.

The BLF list feature on the IP phones is specifically designed to support the BroadSoft Broadworks Rel 13 Busy Lamp Field feature. This feature allows the IP phone to subscribe to a list of monitored users defined through the BroadWorks web portal.

**Note:** Your system administrator must have BLF List enabled on the BroadWorks Server. Contact your system administrator for more information.

In addition to monitoring the idle and busy state, the BLF list feature also supports the ringing state. When the monitored user is idle, there is a small telephone icon shown with the handset on-hook. When the monitored user is on an active call then a small telephone icon is shown with the handset off-hook.

**Note:** You can also use a BLF/List configured key to dial out.

### Example

A receptionist has a 57i CT running Broadsoft firmware that subscribes to a list of extensions from the BroadWorks Application Server. On the 57i CT, the softkey LEDs illuminate either flashing, solid, or turn off depending on the state of those extensions.

**Note:** The Broadworks BLF feature is not the same as the Broadworks Shared Call Appearance (SCA) feature and does not permit call control over the monitored extension.

### Setting a BLF List Softkey

The BLF List functions can be configured on the 57i CT using the Aastra Web UI only. If you set a softkey to use BLF/List, you must also enter a **BLF List URI** at **Operation->Softkeys and XML->Services**. The BLF List URI is the name of the BLF list defined on the BroadSoft BroadWorks Busy Lamp field page for your particular user. For example, my480i-blf-list@as.broadworks.com. The value of the BLF/List URI parameter must match the list name configured. Otherwise, no values display on the 57i CT screen and the feature is disabled.



1. Click on **Operation->Softkeys and XML.**

**Softkeys Configuration**

**Bottom Keys** | **Top Keys**

Key	Type	Label	Value	Line	Idle	Connected	Incoming	Outgoing	Busy
1	BLF/List	blflist	1111	2	<input checked="" type="checkbox"/>	<input checked="" type="checkbox"/>	<input checked="" type="checkbox"/>	<input checked="" type="checkbox"/>	<input checked="" type="checkbox"/>
2	Speedial	Portal		1	<input checked="" type="checkbox"/>	<input checked="" type="checkbox"/>	<input checked="" type="checkbox"/>	<input checked="" type="checkbox"/>	<input checked="" type="checkbox"/>
3	Speedial	Speed Dial	1111	1	<input checked="" type="checkbox"/>	<input checked="" type="checkbox"/>	<input checked="" type="checkbox"/>	<input checked="" type="checkbox"/>	<input checked="" type="checkbox"/>
4	Speedial	Call Return	*09	1	<input checked="" type="checkbox"/>	<input checked="" type="checkbox"/>	<input checked="" type="checkbox"/>	<input checked="" type="checkbox"/>	<input checked="" type="checkbox"/>
5	Speedial	Pickup	*98	1	<input checked="" type="checkbox"/>	<input checked="" type="checkbox"/>	<input checked="" type="checkbox"/>	<input checked="" type="checkbox"/>	<input checked="" type="checkbox"/>
6	Speedial	CallForward	*72	1	<input checked="" type="checkbox"/>	<input checked="" type="checkbox"/>	<input checked="" type="checkbox"/>	<input checked="" type="checkbox"/>	<input checked="" type="checkbox"/>
7	Speedial	CallForward	*73	1	<input checked="" type="checkbox"/>	<input checked="" type="checkbox"/>	<input checked="" type="checkbox"/>	<input checked="" type="checkbox"/>	<input checked="" type="checkbox"/>
8	Speedial	DND On	*79	1	<input checked="" type="checkbox"/>	<input checked="" type="checkbox"/>	<input checked="" type="checkbox"/>	<input checked="" type="checkbox"/>	<input checked="" type="checkbox"/>
9	Speedial	DND Off	*79	1	<input checked="" type="checkbox"/>	<input checked="" type="checkbox"/>	<input checked="" type="checkbox"/>	<input checked="" type="checkbox"/>	<input checked="" type="checkbox"/>
10	Speedial	CLIDBlock	*67	1	<input checked="" type="checkbox"/>	<input checked="" type="checkbox"/>	<input checked="" type="checkbox"/>	<input checked="" type="checkbox"/>	<input checked="" type="checkbox"/>
11	Speedial	Trace	*67	1	<input checked="" type="checkbox"/>	<input checked="" type="checkbox"/>	<input checked="" type="checkbox"/>	<input checked="" type="checkbox"/>	<input checked="" type="checkbox"/>
12	Speedial	Clear MWI	*99	1	<input checked="" type="checkbox"/>	<input checked="" type="checkbox"/>	<input checked="" type="checkbox"/>	<input checked="" type="checkbox"/>	<input checked="" type="checkbox"/>
13	Speedial	Cancel CW	*70	1	<input checked="" type="checkbox"/>	<input checked="" type="checkbox"/>	<input checked="" type="checkbox"/>	<input checked="" type="checkbox"/>	<input checked="" type="checkbox"/>
14	Speedial	Unpak	*88	1	<input checked="" type="checkbox"/>	<input checked="" type="checkbox"/>	<input checked="" type="checkbox"/>	<input checked="" type="checkbox"/>	<input checked="" type="checkbox"/>
15	None			1	<input checked="" type="checkbox"/>	<input checked="" type="checkbox"/>	<input checked="" type="checkbox"/>	<input checked="" type="checkbox"/>	<input checked="" type="checkbox"/>
16	None			1	<input checked="" type="checkbox"/>	<input checked="" type="checkbox"/>	<input checked="" type="checkbox"/>	<input checked="" type="checkbox"/>	<input checked="" type="checkbox"/>
17	None			1	<input checked="" type="checkbox"/>	<input checked="" type="checkbox"/>	<input checked="" type="checkbox"/>	<input checked="" type="checkbox"/>	<input checked="" type="checkbox"/>
18	None			1	<input checked="" type="checkbox"/>	<input checked="" type="checkbox"/>	<input checked="" type="checkbox"/>	<input checked="" type="checkbox"/>	<input checked="" type="checkbox"/>
19	None			1	<input checked="" type="checkbox"/>	<input checked="" type="checkbox"/>	<input checked="" type="checkbox"/>	<input checked="" type="checkbox"/>	<input checked="" type="checkbox"/>
20	None			1	<input checked="" type="checkbox"/>	<input checked="" type="checkbox"/>	<input checked="" type="checkbox"/>	<input checked="" type="checkbox"/>	<input checked="" type="checkbox"/>

**Services**

XML Application URI:

XML Application Title:

BLF List URI:

- Click on the **Bottom Keys** tab or the **Top Keys** tab.
  - Select from **"Key 1"** through **"Key 20"** on the bottom tab.  
or  
Select from **"Key 1"** through **"Key 10"** on the top tab.
  - In the **"Type"** field, select **"BLF/List"** (BroadSoft BroadWorks).
- Note:** The "Label" and "Value" field are not required. The BroadWorks BLF List name is configured in the "BLF List URI" field instead.
- In the **"Line"** field, select a line number that is actively registered to the appropriate SIP proxy you are using.
  - If configuring a softkey on the Bottom Keys, in the state fields, check (enable) or uncheck (disable) the states you want to apply to this softkey.
  - In the **"BLF List URI"** field, enter the name of the BLF list defined on the BroadSoft BroadWorks Busy Lamp field page for your particular user. For example, my53i-blf-list@as.broadworks.com.
- Note:** Contact your System Administrator for the BLF List URI.
- Click  to save your changes.
  - Click on **Operation->Reset**.
  - In the **"Restart Phone"** field click  to restart the IP phone.

## Softkeys for Accessing XML Services

The 57i CT IP phone has a feature you can enable called "XML" (Extensible Markup Language). XML is a markup language much like HTML. Your system administrator can create customized XML menu services and load them to your IP phone. These services include things like weather and traffic reports, contact information, company info, stock quotes, or custom call scripts.

**Note:** You can configure XML using the Aastra Web UI only.

On the 57i CT IP phone, you can access the XML applications from the IP Phone UI in two ways:

- Via the "Services" menu
- Via an XML softkey

**Note:** The XML services must be set up by your system administrator before you can use the key. Contact your system administrator for more information.

By default, the Services key is the first key on the "Top" softkeys.

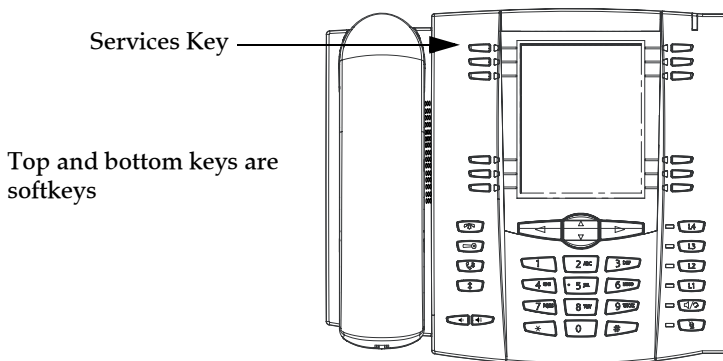

Using the Aastra Web UI, you can setup the Services menu on the IP phone to display XML applications. Under **Operations->Softkeys and XML**, you can click on the "Top Keys" tab and enter the XML URI and Services Label in the "XML Application URI" and "XML Application Title" fields, respectively.

**Note:** Contact your system administrator for the applicable URI to enter in this field. After the Services menu is configured, you can use the IP Phone UI and press the Services key to access the XML applications.

Using the Aastra Web UI, you can also configure a softkey to access XML applications. Under **Operations->Softkeys and XML**, you can click on the "Bottom Keys" or "Top Keys" tabs and assign a key type as "XML". You must also set the following for XML softkeys:

- **XML Application URI**
- **XML Application Title**



The XML Application URI is the URI loaded by your phone. The phone performs an HTTP GET. Contact your system administrator for the applicable XML URI to enter in the "XML Application URI" field.

The XML Application Title is the label that displays beside the XML softkey on your phone. If you use the Services key to access the XML features, the "XML Application Title" is the label that displays on the Services Menu in the IP Phone UI.

## Setting XML Services



Aastra Web UI

### 1. Click on **Operation->Softkeys and XML**.

Status

System Information

Operation

User Password

Phone Lock

Softkeys and XML

Directory

Reset

Basic Settings

Preferences

Call Forward

### Softkeys Configuration

Bottom Keys
Top Keys

Key	Type	Label	Value	Line	Idle	Connected	Incoming	Outgoing	Busy
1	BLFList	Label	1111	2	<input checked="" type="checkbox"/>	<input checked="" type="checkbox"/>	<input checked="" type="checkbox"/>	<input checked="" type="checkbox"/>	<input checked="" type="checkbox"/>
2	Speedial	Portal		1	<input checked="" type="checkbox"/>	<input checked="" type="checkbox"/>	<input checked="" type="checkbox"/>	<input checked="" type="checkbox"/>	<input checked="" type="checkbox"/>
3	Speedial	Speed Dial	1111	1	<input checked="" type="checkbox"/>	<input checked="" type="checkbox"/>	<input checked="" type="checkbox"/>	<input checked="" type="checkbox"/>	<input checked="" type="checkbox"/>
4	Speedial	Call Return	*90	1	<input checked="" type="checkbox"/>	<input checked="" type="checkbox"/>	<input checked="" type="checkbox"/>	<input checked="" type="checkbox"/>	<input checked="" type="checkbox"/>
5	Speedial	Pickup	*90	1	<input checked="" type="checkbox"/>	<input checked="" type="checkbox"/>	<input checked="" type="checkbox"/>	<input checked="" type="checkbox"/>	<input checked="" type="checkbox"/>
6	Speedial	CallFwdOn	*72	1	<input checked="" type="checkbox"/>	<input checked="" type="checkbox"/>	<input checked="" type="checkbox"/>	<input checked="" type="checkbox"/>	<input checked="" type="checkbox"/>
7	Speedial	CallFwdOff	*73	1	<input checked="" type="checkbox"/>	<input checked="" type="checkbox"/>	<input checked="" type="checkbox"/>	<input checked="" type="checkbox"/>	<input checked="" type="checkbox"/>
8	Speedial	DND On	*79	1	<input checked="" type="checkbox"/>	<input checked="" type="checkbox"/>	<input checked="" type="checkbox"/>	<input checked="" type="checkbox"/>	<input checked="" type="checkbox"/>
9	Speedial	DND Off	*70	1	<input checked="" type="checkbox"/>	<input checked="" type="checkbox"/>	<input checked="" type="checkbox"/>	<input checked="" type="checkbox"/>	<input checked="" type="checkbox"/>
10	Speedial	CLIPBlock	*67	1	<input checked="" type="checkbox"/>	<input checked="" type="checkbox"/>	<input checked="" type="checkbox"/>	<input checked="" type="checkbox"/>	<input checked="" type="checkbox"/>
11	Speedial	Trasx	*67	1	<input checked="" type="checkbox"/>	<input checked="" type="checkbox"/>	<input checked="" type="checkbox"/>	<input checked="" type="checkbox"/>	<input checked="" type="checkbox"/>
12	Speedial	Clear MMR	*90	1	<input checked="" type="checkbox"/>	<input checked="" type="checkbox"/>	<input checked="" type="checkbox"/>	<input checked="" type="checkbox"/>	<input checked="" type="checkbox"/>
13	Speedial	Cancel CW	*70	1	<input checked="" type="checkbox"/>	<input checked="" type="checkbox"/>	<input checked="" type="checkbox"/>	<input checked="" type="checkbox"/>	<input checked="" type="checkbox"/>
14	Speedial	Unpak	*89	1	<input checked="" type="checkbox"/>	<input checked="" type="checkbox"/>	<input checked="" type="checkbox"/>	<input checked="" type="checkbox"/>	<input checked="" type="checkbox"/>
15	None			1	<input type="checkbox"/>	<input type="checkbox"/>	<input type="checkbox"/>	<input type="checkbox"/>	<input type="checkbox"/>
16	None			1	<input type="checkbox"/>	<input type="checkbox"/>	<input type="checkbox"/>	<input type="checkbox"/>	<input type="checkbox"/>
17	None			1	<input type="checkbox"/>	<input type="checkbox"/>	<input type="checkbox"/>	<input type="checkbox"/>	<input type="checkbox"/>
18	None			1	<input type="checkbox"/>	<input type="checkbox"/>	<input type="checkbox"/>	<input type="checkbox"/>	<input type="checkbox"/>
19	None			1	<input type="checkbox"/>	<input type="checkbox"/>	<input type="checkbox"/>	<input type="checkbox"/>	<input type="checkbox"/>
20	None			1	<input type="checkbox"/>	<input type="checkbox"/>	<input type="checkbox"/>	<input type="checkbox"/>	<input type="checkbox"/>

**Services**

XML Application URI:

XML Application Title:

BLF List URI:

### 2. Click on the **Bottom Keys** tab or the **Top Keys** tab.

### 3. Select from "Key 1" through "Key 20" on the bottom tab.

or

Select from "Key 1" through "Key 10" on the top tab.

### 4. Select "Key 1" (Services).

### 5. In the "Type" field, select "XML".

### 6. If configuring a softkey on the Bottom Keys, in the state fields, check (enable) or uncheck (disable) the states you want to apply to this softkey.

### 7. Under the "Services" section in the "XML Application URI" field, enter the applicable URI(s).

### 8. in the "XML Application Title" field, enter the applicable label to display for the Services Menu.

**Note:** Contact your system administrator for the appropriate value(s) to enter in the "XML Application URI" field.

9. Click  to save your changes.

10. Click on **Operation->Reset**.

11. In the **"Restart Phone"** field click  to restart the IP phone.

## Setting an XML Softkey



Aastra Web UI

1. Click on **Operation->Softkeys and XML**.

Key	Type	Label	Value	Line	Idle	Connected	Incoming	Outgoing	Busy
1	BLFList	latest	1111	2	<input checked="" type="checkbox"/>	<input checked="" type="checkbox"/>	<input checked="" type="checkbox"/>	<input checked="" type="checkbox"/>	<input checked="" type="checkbox"/>
2	Speedial	Portal		1	<input checked="" type="checkbox"/>	<input checked="" type="checkbox"/>	<input checked="" type="checkbox"/>	<input checked="" type="checkbox"/>	<input checked="" type="checkbox"/>
3	Speedial	Speed Dial	1111	1	<input checked="" type="checkbox"/>	<input checked="" type="checkbox"/>	<input checked="" type="checkbox"/>	<input checked="" type="checkbox"/>	<input checked="" type="checkbox"/>
4	Speedial	Call Return	*69	1	<input checked="" type="checkbox"/>	<input checked="" type="checkbox"/>	<input checked="" type="checkbox"/>	<input checked="" type="checkbox"/>	<input checked="" type="checkbox"/>
5	Speedial	Pickup	*98	1	<input checked="" type="checkbox"/>	<input checked="" type="checkbox"/>	<input checked="" type="checkbox"/>	<input checked="" type="checkbox"/>	<input checked="" type="checkbox"/>
6	Speedial	CallFwdOn	*72	1	<input checked="" type="checkbox"/>	<input checked="" type="checkbox"/>	<input checked="" type="checkbox"/>	<input checked="" type="checkbox"/>	<input checked="" type="checkbox"/>
7	Speedial	CallFwdOff	*73	1	<input checked="" type="checkbox"/>	<input checked="" type="checkbox"/>	<input checked="" type="checkbox"/>	<input checked="" type="checkbox"/>	<input checked="" type="checkbox"/>
8	Speedial	DND On	*78	1	<input checked="" type="checkbox"/>	<input checked="" type="checkbox"/>	<input checked="" type="checkbox"/>	<input checked="" type="checkbox"/>	<input checked="" type="checkbox"/>
9	Speedial	DND Off	*79	1	<input checked="" type="checkbox"/>	<input checked="" type="checkbox"/>	<input checked="" type="checkbox"/>	<input checked="" type="checkbox"/>	<input checked="" type="checkbox"/>
10	Speedial	CLIRBlock	*67	1	<input checked="" type="checkbox"/>	<input checked="" type="checkbox"/>	<input checked="" type="checkbox"/>	<input checked="" type="checkbox"/>	<input checked="" type="checkbox"/>
11	Speedial	Trace	*57	1	<input checked="" type="checkbox"/>	<input checked="" type="checkbox"/>	<input checked="" type="checkbox"/>	<input checked="" type="checkbox"/>	<input checked="" type="checkbox"/>
12	Speedial	Clear MMR	*99	1	<input checked="" type="checkbox"/>	<input checked="" type="checkbox"/>	<input checked="" type="checkbox"/>	<input checked="" type="checkbox"/>	<input checked="" type="checkbox"/>
13	Speedial	Cancel CW	*70	1	<input checked="" type="checkbox"/>	<input checked="" type="checkbox"/>	<input checked="" type="checkbox"/>	<input checked="" type="checkbox"/>	<input checked="" type="checkbox"/>
14	Speedial	Unpark	*88	1	<input checked="" type="checkbox"/>	<input checked="" type="checkbox"/>	<input checked="" type="checkbox"/>	<input checked="" type="checkbox"/>	<input checked="" type="checkbox"/>
15	None			1	<input checked="" type="checkbox"/>	<input checked="" type="checkbox"/>	<input checked="" type="checkbox"/>	<input checked="" type="checkbox"/>	<input checked="" type="checkbox"/>
16	None			1	<input checked="" type="checkbox"/>	<input checked="" type="checkbox"/>	<input checked="" type="checkbox"/>	<input checked="" type="checkbox"/>	<input checked="" type="checkbox"/>
17	None			1	<input checked="" type="checkbox"/>	<input checked="" type="checkbox"/>	<input checked="" type="checkbox"/>	<input checked="" type="checkbox"/>	<input checked="" type="checkbox"/>
18	None			1	<input checked="" type="checkbox"/>	<input checked="" type="checkbox"/>	<input checked="" type="checkbox"/>	<input checked="" type="checkbox"/>	<input checked="" type="checkbox"/>
19	None			1	<input checked="" type="checkbox"/>	<input checked="" type="checkbox"/>	<input checked="" type="checkbox"/>	<input checked="" type="checkbox"/>	<input checked="" type="checkbox"/>
20	None			1	<input checked="" type="checkbox"/>	<input checked="" type="checkbox"/>	<input checked="" type="checkbox"/>	<input checked="" type="checkbox"/>	<input checked="" type="checkbox"/>

**Services**

XML Application URI:

XML Application Title:

BLF List URI:

2. Click on the **Bottom** tab or the **Top** tab.

3. Select from **"Key 1"** through **"Key 20"** on the bottom tab.

or

Select from **"Key 1"** through **"Key 10"** on the top tab.

4. In the **"Type"** field, select **"XML"**.

5. In the **"Label"** field, enter a label to apply to this softkey.

6. In the **"Value"** field, enter a URI to apply to this softkey.

**Note:** Contact your system administrator for the appropriate value(s) to enter in the "Value" field.

7. If configuring a softkey on the Bottom Keys, in the state fields, check (enable) or uncheck (disable) the states you want to apply to this softkey.

8. Click  to save your changes.

9. Click on **Operation->Reset**.

10. In the **"Restart Phone"** field click  to restart the IP phone.

## Accessing the XML Service

After an XML application(s) has been saved to your IP phone, and either the Services Menu or a softkey have been configured to access the XML applications, the customized service is ready for you to use.



### IP Phone UI

#### From the Services Menu

Use the following procedure to access XML applications from the Services Menu. Use the following illustration as a reference.

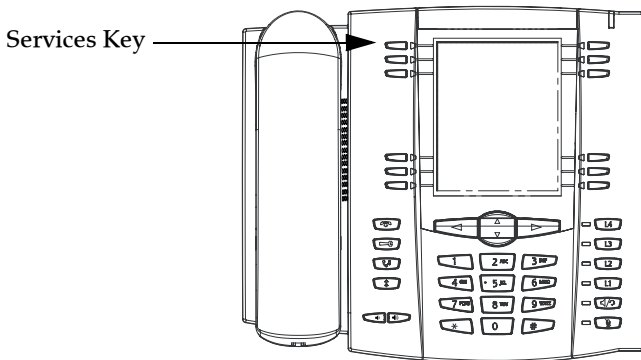

1. Press the **Services** key.
2. Use the  $\Delta$  and  $\nabla$  to scroll through the items.
3. For menu and directory services, select a service to display the information for that customized service. Message services display to the screen after pressing the programmable key. For user input services, follow the prompts as appropriate.
4. To exit from the "**Services**" menu, press the Services key again.

#### From an XML Softkey

1. Press the XML softkey on the 57i CT phone. A "**Custom Features**" screen displays or the title you specified.
2. Use the  $\Delta$  and  $\nabla$  to scroll through the customized features.
3. For menu and directory services, select a service to display the information for that customized service. Message services display to the screen after pressing the programmable key. For user input services, follow the prompts as appropriate.
4. To exit from the "**Customized Features**" screen, press the XML softkey again.

## Softkeys as Flash Key

You can set a softkey to generate a flash event when it is pressed on the 57i CT or 57i CT handset. You do this by setting the softkey to "flash". The IP phone generates flash events only when a call is connected and there is an active RTP stream (for example, when the call is not on hold).

### Setting a Flash Softkey



Aastra Web UI

#### 1. Click on **Operation->Softkeys and XML.**

Key	Hard Key	Value	Line
1	Save		global
2	Delete		global
3	Directory		1
4	Callers List		1
5	Transfer		global
6	Conference		global

Services

BLF List URI:

#### 2. Click on the **Bottom** tab or the **Top** tab.

#### 3. Select from "Key 1" through "Key 20" on the bottom tab.

or

Select from "Key 1" through "Key 10" on the top tab.

#### 4. In the "Type" field, select "Flash".

#### 5. In the "Label" field, enter a label to display on the phone for the softkey.

#### 6. Click to save your changes.

#### 7. Click on **Operation->Reset.**

#### 8. In the "Restart Phone" field click to restart the IP phone.

## Softkeys as Sprecode

You can set a softkey to automatically activate specific services offered by the server by setting a softkey to "**sprecode**". For example, if the sprecode value of \*82 is configured, then by pressing the softkey, \*82 automatically activates a service provided by the server. The value you enter for this field is dependent on the services provided by the server. Contact your system administrator for information about available services.

### Setting a Sprecode Softkey



Aastra Web UI

Use the following procedure to configure a sprecode softkey on the 57i CT phone.

#### 1. Click on **Operation->Softkeys and XML**.

Key	Type	Label	Value	Line	Idle	Connected	Incoming	Outgoing	Busy
1	BLF/List	listlist	1111	2	<input checked="" type="checkbox"/>	<input checked="" type="checkbox"/>	<input checked="" type="checkbox"/>	<input checked="" type="checkbox"/>	<input checked="" type="checkbox"/>
2	Speeddial	Portal		1	<input checked="" type="checkbox"/>	<input checked="" type="checkbox"/>	<input checked="" type="checkbox"/>	<input checked="" type="checkbox"/>	<input checked="" type="checkbox"/>
3	Speeddial	Speed Dial	1111	1	<input checked="" type="checkbox"/>	<input checked="" type="checkbox"/>	<input checked="" type="checkbox"/>	<input checked="" type="checkbox"/>	<input checked="" type="checkbox"/>
4	Speeddial	Call Return	*60	1	<input checked="" type="checkbox"/>	<input checked="" type="checkbox"/>	<input checked="" type="checkbox"/>	<input checked="" type="checkbox"/>	<input checked="" type="checkbox"/>
5	Speeddial	Pickup	*98	1	<input checked="" type="checkbox"/>	<input checked="" type="checkbox"/>	<input checked="" type="checkbox"/>	<input checked="" type="checkbox"/>	<input checked="" type="checkbox"/>
6	Speeddial	CallfwdOn	*72	1	<input checked="" type="checkbox"/>	<input checked="" type="checkbox"/>	<input checked="" type="checkbox"/>	<input checked="" type="checkbox"/>	<input checked="" type="checkbox"/>
7	Speeddial	CallfwdOff	*73	1	<input checked="" type="checkbox"/>	<input checked="" type="checkbox"/>	<input checked="" type="checkbox"/>	<input checked="" type="checkbox"/>	<input checked="" type="checkbox"/>
8	Speeddial	DND On	*78	1	<input checked="" type="checkbox"/>	<input checked="" type="checkbox"/>	<input checked="" type="checkbox"/>	<input checked="" type="checkbox"/>	<input checked="" type="checkbox"/>
9	Speeddial	DND Off	*79	1	<input checked="" type="checkbox"/>	<input checked="" type="checkbox"/>	<input checked="" type="checkbox"/>	<input checked="" type="checkbox"/>	<input checked="" type="checkbox"/>
10	Speeddial	CLIDBlock	*67	1	<input checked="" type="checkbox"/>	<input checked="" type="checkbox"/>	<input checked="" type="checkbox"/>	<input checked="" type="checkbox"/>	<input checked="" type="checkbox"/>
11	Speeddial	Trace	*67	1	<input checked="" type="checkbox"/>	<input checked="" type="checkbox"/>	<input checked="" type="checkbox"/>	<input checked="" type="checkbox"/>	<input checked="" type="checkbox"/>
12	Speeddial	ClearMMI	*90	1	<input checked="" type="checkbox"/>	<input checked="" type="checkbox"/>	<input checked="" type="checkbox"/>	<input checked="" type="checkbox"/>	<input checked="" type="checkbox"/>
13	Speeddial	Cancel CW	*70	1	<input checked="" type="checkbox"/>	<input checked="" type="checkbox"/>	<input checked="" type="checkbox"/>	<input checked="" type="checkbox"/>	<input checked="" type="checkbox"/>
14	Speeddial	Unpark	*88	1	<input checked="" type="checkbox"/>	<input checked="" type="checkbox"/>	<input checked="" type="checkbox"/>	<input checked="" type="checkbox"/>	<input checked="" type="checkbox"/>
15	None			1	<input checked="" type="checkbox"/>	<input checked="" type="checkbox"/>	<input checked="" type="checkbox"/>	<input checked="" type="checkbox"/>	<input checked="" type="checkbox"/>
16	None			1	<input checked="" type="checkbox"/>	<input checked="" type="checkbox"/>	<input checked="" type="checkbox"/>	<input checked="" type="checkbox"/>	<input checked="" type="checkbox"/>
17	None			1	<input checked="" type="checkbox"/>	<input checked="" type="checkbox"/>	<input checked="" type="checkbox"/>	<input checked="" type="checkbox"/>	<input checked="" type="checkbox"/>
18	None			1	<input checked="" type="checkbox"/>	<input checked="" type="checkbox"/>	<input checked="" type="checkbox"/>	<input checked="" type="checkbox"/>	<input checked="" type="checkbox"/>
19	None			1	<input checked="" type="checkbox"/>	<input checked="" type="checkbox"/>	<input checked="" type="checkbox"/>	<input checked="" type="checkbox"/>	<input checked="" type="checkbox"/>
20	None			1	<input checked="" type="checkbox"/>	<input checked="" type="checkbox"/>	<input checked="" type="checkbox"/>	<input checked="" type="checkbox"/>	<input checked="" type="checkbox"/>

**Services**

XML Application URI:

XML Application Title:

BLF List URI:

#### 2. Click on the **Bottom** tab or the **Top** tab.

#### 3. Select from "**Key 1**" through "**Key 20**" on the bottom tab..

or



Select from "**Key 1**" through "**Key 10**" on the top tab.

#### 4. In the "**Type**" field, select **Sprecode**.

#### 5. In the "**Label**" field, enter a label to display on the IP phone for this softkey.

#### 6. In the "**Value**" field, enter the appropriate value for accessing specific services from the server.

**Note:** For values to enter in this field, contact your system administrator.

7. If configuring a softkey on the Bottom Keys, in the state fields, check (enable) or uncheck (disable) the "**Connected**" state to apply to this softkey.
8. Click  to save your changes.
9. Click on **Operation->Reset**.
10. In the "**Restart Phone**" field click  to restart the IP phone.

## Static and Softkey Settings for Park/Pickup

The IP phone has a park and pickup call feature that allows you to park a call and pickup a call when required. There are two ways a user can configure this feature:

- Using a static configuration
- Using a programmable configuration (using softkeys)

**Note:** The IP phone accepts both methods of configuration. However, to avoid redundancy, Aastra Telecom recommends you configure either a static configuration or a programmable configuration.

The IP phone supports the Park/Pickup feature on the Asterisk, BroadWorks, Sylanro, and ININ PBX servers.

The following paragraphs describe the park and pickup methods of configuration on the IP phones.

### *Park/Pickup Static Configuration*

You can configure a static configuration for parking and picking up a call using the Aastra Web UI at **Basic Settings-> Preferences**. By entering the appropriate value in the "**Park Call**" and "**Pickup Parked Call**" fields, you tell the phone where to park a live call and where to pickup the parked call.

On the IP phone UI, the static configuration method displays the following:

- When a call comes in, and you pickup the handset, the default label of "**Park**" displays on the Phone UI.
- After pressing the "**Park**" softkey to park the call, the default label of "**Pickup**" displays on the phone UI.

**Note:** On the 57i CT handset, pressing  displays the "Park" and "Pickup" labels. The values you enter in the Aastra Web UI for the Park/Pickup call feature are dependant on your type of server. The following table provides the values you enter for the "**Park Call**" and "**Pickup Parked Call**" fields in the Aastra Web UI.

### **Park/Pickup Call Server Configuration Values**

Server	Park Values*	Pickup Values*
Aasterisk	700	700
Sylanro	*98	*99
BroadWorks	*68	*88
ININ PBX	callpark	pickup

\*Leave "value" fields blank to disable the park and pickup feature.

### *Configuring Park /Pickup using Static Configuration*

Use the following procedure to configure the Park/Pickup call feature using the static configuration method.

**Note:** Aastra recommends you configure either the static or the programmable configuration, but not both.



Aastra Web UI

---

1. Click on **Basic Settings->Preferences->General.**

<p><b>Status</b></p> <p>System Information</p> <p><b>Operation</b></p> <p>User Password</p> <p>Phone Lock</p> <p>Softkeys and XML</p> <p>Directory</p> <p>Reset</p> <p><b>Basic Settings</b></p> <p>Preferences</p> <p>Call Forward</p>	<h2 style="text-align: center;">Preferences</h2> <p><b>General</b></p> <p>Park Call: <input type="text"/></p> <p>Pick Up Parked Call: <input type="text"/></p> <p>Suppress DTMF Playback <input type="checkbox"/> Enabled</p> <p>Display DTMF Digits <input type="checkbox"/> Enabled</p> <p>Play Call Waiting Tone <input checked="" type="checkbox"/> Enabled</p> <p>Stuttered Dial Tone <input checked="" type="checkbox"/> Enabled</p> <p><b>Incoming Intercom Settings</b></p> <p>Auto-Answer <input checked="" type="checkbox"/> Enabled</p> <p>Microphone Mute <input checked="" type="checkbox"/> Enabled</p> <p>Play Warning Tone <input checked="" type="checkbox"/> Enabled</p> <p><b>Ring Tones</b></p> <p>Tone Set <input type="text" value="US"/></p> <p>Global Ring Tone <input type="text" value="Tone 1"/></p> <p>Line 1 <input type="text" value="Global"/></p> <p>Line 2 <input type="text" value="Global"/></p> <p>Line 3 <input type="text" value="Global"/></p> <p>Line 4 <input type="text" value="Global"/></p> <p>Line 5 <input type="text" value="Global"/></p> <p>Line 6 <input type="text" value="Global"/></p> <p>Line 7 <input type="text" value="Global"/></p> <p>Line 8 <input type="text" value="Global"/></p> <p>Line 9 <input type="text" value="Global"/></p> <p><b>Time and Date Setting</b></p> <p>Time Format <input type="text" value="12h"/></p> <p>Date Format <input type="text" value="WWW MMM DD"/></p> <p><b>Language Settings</b></p> <p>Webpage Language <input type="text" value="English"/></p> <p style="text-align: center;"><input type="button" value="Save Settings"/></p>
---	---

2. Enter a server value in the **Park Call** field to which incoming live calls will be parked.

**Note:** For values to enter in this field, see the table "[Park/Pickup Call Server Configuration Values](#)" on page 47.

3. Enter a server value in the "**Pickup Parked Call**" field.

**Note:** For values to enter in this field, see the table "[Park/Pickup Call Server Configuration Values](#)" on page 47.

4. Click  to save your changes.

5. Click on **Operation->Reset**.

6. In the "**Restart Phone**" field click  to restart the IP phone.

### *Park/Pickup Softkey Configuration*

The programmable method of configuration creates park and pickup softkeys that you can configure on the 57i CT phone.

You can set a softkey as "Park" or "Pickup" and then:



- specify a customized label to display on the Phone UI
- specify a value
- specify which line to use
- specify the state of the park and/or pickup keys

On the IP phone UI, the Park/Pickup feature displays the following:

- When a call comes in, and you pickup the handset, the custom label that you configured for the Park softkey displays on the Phone UI.
- After the call is parked, the label that you configured for the Pickup softkey displays on other phones in the network. You can then press the "Pickup" softkey, followed by the applicable value to pickup the call on another phone in your network.

You can configure a Park and Pickup programmable configuration using the Aastra Web UI.

### Softkey Configuration Using the Aastra Web UI

On the 57i CT, you configure a Park and/or Pickup key at **Operation->Softkeys and XML**. You enter a key label, and value for a specific line on the phone. The default state of the Park configuration is **"connected"**. The default state of the Pickup configuration is **"idle, outgoing"**.

**Note:** Applicable values depend on the server in your network (Asterisk, Broadworks, Sylantro, ININ PBX. See the table ["Park/Pickup Call Server Configuration Values"](#) on page 47.

### Configuring Park/Pickup using Softkey Configuration

Use the following procedure to configure the Park/Pickup call feature using the softkey configuration method.



Aastra Web UI

## 1. Click on **Operation->Softkeys and XML**.

**Softkeys Configuration**

Bottom Keys | Top Keys

Key	Type	Label	Value	Line	Idle	Connected	Incoming	Outgoing	Busy
1	BLFList	list	1111	2	<input checked="" type="checkbox"/>	<input checked="" type="checkbox"/>	<input checked="" type="checkbox"/>	<input checked="" type="checkbox"/>	<input checked="" type="checkbox"/>
2	Speedial	Park		1	<input checked="" type="checkbox"/>	<input checked="" type="checkbox"/>	<input checked="" type="checkbox"/>	<input checked="" type="checkbox"/>	<input checked="" type="checkbox"/>
3	Speedial	Speed Dial	1111	1	<input checked="" type="checkbox"/>	<input checked="" type="checkbox"/>	<input checked="" type="checkbox"/>	<input checked="" type="checkbox"/>	<input checked="" type="checkbox"/>
4	Speedial	Call Return	99	1	<input checked="" type="checkbox"/>	<input checked="" type="checkbox"/>	<input checked="" type="checkbox"/>	<input checked="" type="checkbox"/>	<input checked="" type="checkbox"/>
5	Speedial	Pickup	99	1	<input checked="" type="checkbox"/>	<input checked="" type="checkbox"/>	<input checked="" type="checkbox"/>	<input checked="" type="checkbox"/>	<input checked="" type="checkbox"/>
6	Speedial	CallFwdOn	72	1	<input checked="" type="checkbox"/>	<input checked="" type="checkbox"/>	<input checked="" type="checkbox"/>	<input checked="" type="checkbox"/>	<input checked="" type="checkbox"/>
7	Speedial	CallFwdOff	73	1	<input checked="" type="checkbox"/>	<input checked="" type="checkbox"/>	<input checked="" type="checkbox"/>	<input checked="" type="checkbox"/>	<input checked="" type="checkbox"/>
8	Speedial	DND On	78	1	<input checked="" type="checkbox"/>	<input checked="" type="checkbox"/>	<input checked="" type="checkbox"/>	<input checked="" type="checkbox"/>	<input checked="" type="checkbox"/>
9	Speedial	DND Off	79	1	<input checked="" type="checkbox"/>	<input checked="" type="checkbox"/>	<input checked="" type="checkbox"/>	<input checked="" type="checkbox"/>	<input checked="" type="checkbox"/>
10	Speedial	CLIRBlock	97	1	<input checked="" type="checkbox"/>	<input checked="" type="checkbox"/>	<input checked="" type="checkbox"/>	<input checked="" type="checkbox"/>	<input checked="" type="checkbox"/>
11	Speedial	Trace	97	1	<input checked="" type="checkbox"/>	<input checked="" type="checkbox"/>	<input checked="" type="checkbox"/>	<input checked="" type="checkbox"/>	<input checked="" type="checkbox"/>
12	Speedial	ClearMMI	99	1	<input checked="" type="checkbox"/>	<input checked="" type="checkbox"/>	<input checked="" type="checkbox"/>	<input checked="" type="checkbox"/>	<input checked="" type="checkbox"/>
13	Speedial	Cancel CW	70	1	<input checked="" type="checkbox"/>	<input checked="" type="checkbox"/>	<input checked="" type="checkbox"/>	<input checked="" type="checkbox"/>	<input checked="" type="checkbox"/>
14	Speedial	Unpark	99	1	<input checked="" type="checkbox"/>	<input checked="" type="checkbox"/>	<input checked="" type="checkbox"/>	<input checked="" type="checkbox"/>	<input checked="" type="checkbox"/>
15	None			1	<input checked="" type="checkbox"/>	<input checked="" type="checkbox"/>	<input checked="" type="checkbox"/>	<input checked="" type="checkbox"/>	<input checked="" type="checkbox"/>
16	None			1	<input checked="" type="checkbox"/>	<input checked="" type="checkbox"/>	<input checked="" type="checkbox"/>	<input checked="" type="checkbox"/>	<input checked="" type="checkbox"/>
17	None			1	<input checked="" type="checkbox"/>	<input checked="" type="checkbox"/>	<input checked="" type="checkbox"/>	<input checked="" type="checkbox"/>	<input checked="" type="checkbox"/>
18	None			1	<input checked="" type="checkbox"/>	<input checked="" type="checkbox"/>	<input checked="" type="checkbox"/>	<input checked="" type="checkbox"/>	<input checked="" type="checkbox"/>
19	None			1	<input checked="" type="checkbox"/>	<input checked="" type="checkbox"/>	<input checked="" type="checkbox"/>	<input checked="" type="checkbox"/>	<input checked="" type="checkbox"/>
20	None			1	<input checked="" type="checkbox"/>	<input checked="" type="checkbox"/>	<input checked="" type="checkbox"/>	<input checked="" type="checkbox"/>	<input checked="" type="checkbox"/>

**Services**

XML Application URI:

XML Application Title:

BLF List URI:

Save Settings

2. Click on the **Bottom** tab or the **Top** tab.
3. Select from "**Key 1**" through "**Key 20**" on the bottom tab for parking a call.  
or  
Select from "**Key 1**" through "**Key 10**" on the top tab for parking a call.
4. In the "**Type**" field, select **Park**.
5. In the "**Label**" field, enter a label for the Park softkey.
6. In the "**Value**" field, enter the appropriate value based on the server in your network.  
**Note:** For values to enter in this field, see the table "[Park/Pickup Call Server Configuration Values](#)" on [page 47](#).
7. In the "**Line**" field, select a line for which to apply the Park configuration.
8. If configuring a softkey on the Bottom Keys, in the state fields, check (enable) or uncheck (disable) the "**Connected**" state to apply to this softkey.
9. Pick another softkey (from top or bottom keys) to configure for Picking up a call.
10. In the "**Label**" field, enter a label for the Pickup softkey.
11. In the "**Value**" field, enter the appropriate value based on the server in your network.  
**Note:** For values to enter in this field, see the table "[Park/Pickup Call Server Configuration Values](#)" on [page 47](#).
12. In the "**Line**" field, select a line for which to apply the Pickup configuration.
13. If configuring a softkey on the Bottom Keys, in the state fields, check (enable) or uncheck (disable) the "**Idle**" and "**Outgoing**" states to apply to this softkey.
14. Click  to save your changes.
15. Click on **Operation->Reset**.
16. In the "**Restart Phone**" field click  to restart the IP phone.

## Using the Park Call/Pickup Parked Call Feature

Use the following procedure on the IP phones to park a call and pick up a parked call.

### *Park a Call*

1. While on a live call, press the "**Park**" softkey.
2. Perform the following for your specific server:

<b>For Asterisk Server</b>
- Server announces the extension number where the call has been parked. Once the call is parked, press the  key to complete parking.
<b>For BroadWorks Server</b>
- After you hear the greeting from the CallPark server, enter the extension where you want to park the call.
<b>For Slnatro Server</b>
- Enter the extension number where you want to park the call, followed by "#" key.
<b>For ININ Server</b>
- Enter the extension number where you want to park the call, followed by "#" key.

If the call is parked successfully, the response is either a greeting voice confirming that the call was parked, or a hang up occurs. The parked call party will get music on hold.

3. If the call fails, you can pick up the call (using the next procedure) and press the "**Park**" softkey again to retry step 2.

### *Pickup a Parked Call*

1. Pick up the handset on the phone.
2. Enter the extension number where the call was parked.
3. Press the "**Pickup**" softkey.

If the call pick up is successful, you are connected with the parked call.

## Softkeys as Last Call Return (lcr) (Sylantro Servers only)

Using the Aastra Web UI, you can configure the "Last call return" (lcr) function on a softkey. This feature is for Sylantro servers only.

### How it works

If you configure "lcr" on a softkey, and a call comes into your phone, after you are finished with the call and hangup, you can press the key configured for "lcr" and the phone dials the last call you received. When you configure an "lcr" softkey, the label "LCR" displays next to that softkey on the IP phone. When the Sylantro server detects an "lcr" request, it translates this request and routes the call to the last caller.

### Setting a Last Call Return Softkey



Aastra Web UI

Use the following procedure to configure a Last Call Return softkey on the 57i CT phone.

#### 1. Click on **Operation->Softkeys and XML.**

**Status**  
System Information

**Operation**  
User Password  
Phone Lock  
Softkeys and XML  
Directory  
Reset

**Basic Settings**  
Preferences  
Call Forward

### Softkeys Configuration

Bottom Keys
Top Keys

Key	Type	Label	Value	Line	Idle	Connected	Incoming	Outgoing	Busy
1	BLF/List	labtest	1111	2	<input checked="" type="checkbox"/>	<input checked="" type="checkbox"/>	<input checked="" type="checkbox"/>	<input checked="" type="checkbox"/>	<input checked="" type="checkbox"/>
2	Speeddial	Portal		1	<input checked="" type="checkbox"/>	<input checked="" type="checkbox"/>	<input checked="" type="checkbox"/>	<input checked="" type="checkbox"/>	<input checked="" type="checkbox"/>
3	Speeddial	Speed Dial	1111	1	<input checked="" type="checkbox"/>	<input checked="" type="checkbox"/>	<input checked="" type="checkbox"/>	<input checked="" type="checkbox"/>	<input checked="" type="checkbox"/>
4	Speeddial	Call Return	*69	1	<input checked="" type="checkbox"/>	<input checked="" type="checkbox"/>	<input checked="" type="checkbox"/>	<input checked="" type="checkbox"/>	<input checked="" type="checkbox"/>
5	Speeddial	Pickup	*68	1	<input checked="" type="checkbox"/>	<input checked="" type="checkbox"/>	<input checked="" type="checkbox"/>	<input checked="" type="checkbox"/>	<input checked="" type="checkbox"/>
6	Speeddial	CallFeedOn	*72	1	<input checked="" type="checkbox"/>	<input checked="" type="checkbox"/>	<input checked="" type="checkbox"/>	<input checked="" type="checkbox"/>	<input checked="" type="checkbox"/>
7	Speeddial	CallFeedOff	*73	1	<input checked="" type="checkbox"/>	<input checked="" type="checkbox"/>	<input checked="" type="checkbox"/>	<input checked="" type="checkbox"/>	<input checked="" type="checkbox"/>
8	Speeddial	DND On	*78	1	<input checked="" type="checkbox"/>	<input checked="" type="checkbox"/>	<input checked="" type="checkbox"/>	<input checked="" type="checkbox"/>	<input checked="" type="checkbox"/>
9	Speeddial	DND Off	*79	1	<input checked="" type="checkbox"/>	<input checked="" type="checkbox"/>	<input checked="" type="checkbox"/>	<input checked="" type="checkbox"/>	<input checked="" type="checkbox"/>
10	Speeddial	CLIDBlock	*67	1	<input checked="" type="checkbox"/>	<input checked="" type="checkbox"/>	<input checked="" type="checkbox"/>	<input checked="" type="checkbox"/>	<input checked="" type="checkbox"/>
11	Speeddial	Trace	*67	1	<input checked="" type="checkbox"/>	<input checked="" type="checkbox"/>	<input checked="" type="checkbox"/>	<input checked="" type="checkbox"/>	<input checked="" type="checkbox"/>
12	Speeddial	Clear MWI	*69	1	<input checked="" type="checkbox"/>	<input checked="" type="checkbox"/>	<input checked="" type="checkbox"/>	<input checked="" type="checkbox"/>	<input checked="" type="checkbox"/>
13	Speeddial	Cancel CW	*70	1	<input checked="" type="checkbox"/>	<input checked="" type="checkbox"/>	<input checked="" type="checkbox"/>	<input checked="" type="checkbox"/>	<input checked="" type="checkbox"/>
14	Speeddial	Unpark	*68	1	<input checked="" type="checkbox"/>	<input checked="" type="checkbox"/>	<input checked="" type="checkbox"/>	<input checked="" type="checkbox"/>	<input checked="" type="checkbox"/>
15	None			1	<input checked="" type="checkbox"/>	<input checked="" type="checkbox"/>	<input checked="" type="checkbox"/>	<input checked="" type="checkbox"/>	<input checked="" type="checkbox"/>
16	None			1	<input checked="" type="checkbox"/>	<input checked="" type="checkbox"/>	<input checked="" type="checkbox"/>	<input checked="" type="checkbox"/>	<input checked="" type="checkbox"/>
17	None			1	<input checked="" type="checkbox"/>	<input checked="" type="checkbox"/>	<input checked="" type="checkbox"/>	<input checked="" type="checkbox"/>	<input checked="" type="checkbox"/>
18	None			1	<input checked="" type="checkbox"/>	<input checked="" type="checkbox"/>	<input checked="" type="checkbox"/>	<input checked="" type="checkbox"/>	<input checked="" type="checkbox"/>
19	None			1	<input checked="" type="checkbox"/>	<input checked="" type="checkbox"/>	<input checked="" type="checkbox"/>	<input checked="" type="checkbox"/>	<input checked="" type="checkbox"/>
20	None			1	<input checked="" type="checkbox"/>	<input checked="" type="checkbox"/>	<input checked="" type="checkbox"/>	<input checked="" type="checkbox"/>	<input checked="" type="checkbox"/>

**Services**



XML Application URI:

XML Application Title:

BLF List URI:

2. Click on the **Bottom** tab or the **Top** tab.
3. Select from "**Key 1**" through "**Key 20**" on the bottom tab.  
or  
Select from "**Key 1**" through "**Key 10**" on the top tab.
4. In the "**Type**" field, select **Last Call Return**.
5. In the "**Line**" field, select the line you want to apply to this softkey.

Valid values are 1 through 9.

6. If configuring a softkey on the Bottom Keys, in the state fields, check (enable) or uncheck (disable) the states you want to apply to this softkey.
7. Click  to save your changes.
8. Click on **Operation->Reset**.
9. In the "**Restart Phone**" field click  to restart the IP phone.

## Softkeys as Services

By default, the 57i CT has a Services key configured on key 1 of the top set of keys. However, you can use any softkey to configure a "Services" key.

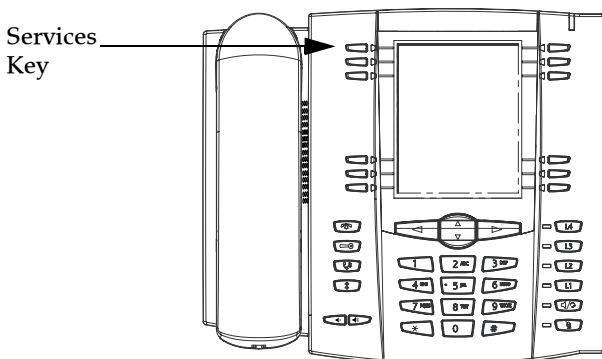

The Services key accesses enhanced features and services provided by third parties. Using the "Services" key, you can:

- Select customized (XML) features
- Utilize a Caller List
- Utilize a Directory
- Utilize Voicemail

**Note:** Other than the Services Menu, you can also configure the Caller List and Directory List on separate softkeys.

The XML customized services are created and provided by your system administrator through the diverse web based language of XML. Availability of these services depends on your phone system or service provider.

### Reference

For more information about XML, Caller List, Directory, and Voicemail, see the following:

- ["Softkeys for Accessing XML Services" on page 40](#)
- ["Callers List" on page 87](#)
- ["Directory List" on page 80](#)
- ["Voicemail" on page 96](#)

For more information about Services you can access on your phone, contact your system administrator.

Use the following procedure to configure a Services softkey on the 57i CT phone.

1. Click on **Operation->Softkeys and XML**.

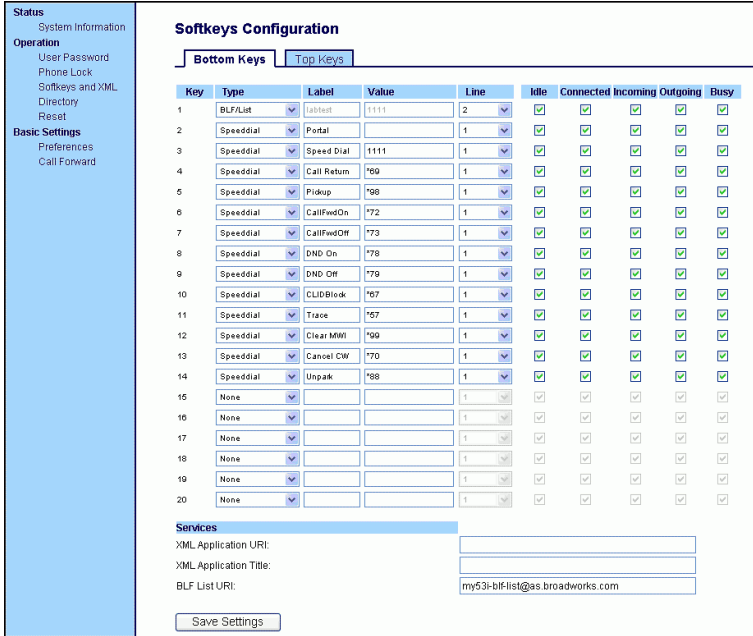

**Softkeys Configuration**

Bottom Keys | Top Keys

Key	Type	Label	Value	Line	Idle	Connected	Incoming	Outgoing	Busy
1	BLF/List	latest	1111	2	<input checked="" type="checkbox"/>	<input checked="" type="checkbox"/>	<input checked="" type="checkbox"/>	<input checked="" type="checkbox"/>	<input checked="" type="checkbox"/>
2	Speeddial	Portal		1	<input checked="" type="checkbox"/>	<input checked="" type="checkbox"/>	<input checked="" type="checkbox"/>	<input checked="" type="checkbox"/>	<input checked="" type="checkbox"/>
3	Speeddial	Speed Dial	1111	1	<input checked="" type="checkbox"/>	<input checked="" type="checkbox"/>	<input checked="" type="checkbox"/>	<input checked="" type="checkbox"/>	<input checked="" type="checkbox"/>
4	Speeddial	Call Return	*60	1	<input checked="" type="checkbox"/>	<input checked="" type="checkbox"/>	<input checked="" type="checkbox"/>	<input checked="" type="checkbox"/>	<input checked="" type="checkbox"/>
5	Speeddial	Pickup	*80	1	<input checked="" type="checkbox"/>	<input checked="" type="checkbox"/>	<input checked="" type="checkbox"/>	<input checked="" type="checkbox"/>	<input checked="" type="checkbox"/>
6	Speeddial	CallFwdOn	*72	1	<input checked="" type="checkbox"/>	<input checked="" type="checkbox"/>	<input checked="" type="checkbox"/>	<input checked="" type="checkbox"/>	<input checked="" type="checkbox"/>
7	Speeddial	CallFwdOff	*73	1	<input checked="" type="checkbox"/>	<input checked="" type="checkbox"/>	<input checked="" type="checkbox"/>	<input checked="" type="checkbox"/>	<input checked="" type="checkbox"/>
8	Speeddial	DND On	*78	1	<input checked="" type="checkbox"/>	<input checked="" type="checkbox"/>	<input checked="" type="checkbox"/>	<input checked="" type="checkbox"/>	<input checked="" type="checkbox"/>
9	Speeddial	DND Off	*79	1	<input checked="" type="checkbox"/>	<input checked="" type="checkbox"/>	<input checked="" type="checkbox"/>	<input checked="" type="checkbox"/>	<input checked="" type="checkbox"/>
10	Speeddial	CLIDBlock	*67	1	<input checked="" type="checkbox"/>	<input checked="" type="checkbox"/>	<input checked="" type="checkbox"/>	<input checked="" type="checkbox"/>	<input checked="" type="checkbox"/>
11	Speeddial	Trace	*67	1	<input checked="" type="checkbox"/>	<input checked="" type="checkbox"/>	<input checked="" type="checkbox"/>	<input checked="" type="checkbox"/>	<input checked="" type="checkbox"/>
12	Speeddial	Clear MVM	*90	1	<input checked="" type="checkbox"/>	<input checked="" type="checkbox"/>	<input checked="" type="checkbox"/>	<input checked="" type="checkbox"/>	<input checked="" type="checkbox"/>
13	Speeddial	Cancel CW	*70	1	<input checked="" type="checkbox"/>	<input checked="" type="checkbox"/>	<input checked="" type="checkbox"/>	<input checked="" type="checkbox"/>	<input checked="" type="checkbox"/>
14	Speeddial	Unpak	*88	1	<input checked="" type="checkbox"/>	<input checked="" type="checkbox"/>	<input checked="" type="checkbox"/>	<input checked="" type="checkbox"/>	<input checked="" type="checkbox"/>
15	None			1	<input checked="" type="checkbox"/>	<input checked="" type="checkbox"/>	<input checked="" type="checkbox"/>	<input checked="" type="checkbox"/>	<input checked="" type="checkbox"/>
16	None			1	<input checked="" type="checkbox"/>	<input checked="" type="checkbox"/>	<input checked="" type="checkbox"/>	<input checked="" type="checkbox"/>	<input checked="" type="checkbox"/>
17	None			1	<input checked="" type="checkbox"/>	<input checked="" type="checkbox"/>	<input checked="" type="checkbox"/>	<input checked="" type="checkbox"/>	<input checked="" type="checkbox"/>
18	None			1	<input checked="" type="checkbox"/>	<input checked="" type="checkbox"/>	<input checked="" type="checkbox"/>	<input checked="" type="checkbox"/>	<input checked="" type="checkbox"/>
19	None			1	<input checked="" type="checkbox"/>	<input checked="" type="checkbox"/>	<input checked="" type="checkbox"/>	<input checked="" type="checkbox"/>	<input checked="" type="checkbox"/>
20	None			1	<input checked="" type="checkbox"/>	<input checked="" type="checkbox"/>	<input checked="" type="checkbox"/>	<input checked="" type="checkbox"/>	<input checked="" type="checkbox"/>

Services

XML Application URI:

XML Application Title:

BLF List URI:

2. Click on the **Bottom** tab or the **Top** tab.
3. Select from "**Key 1**" through "**Key 20**" on the bottom tab.  
or  
Select from "**Key 1**" through "**Key 10**" on the top tab.
4. In the "**Type**" field, select **Services**.
5. In the "**Label**" field, enter a label to apply to this softkey.
6. In the "**Line**" field, select the line you want to apply to this softkey. Valid values are 1 through 9.
7. If configuring a softkey on the Bottom Keys, in the state fields, check (enable) or uncheck (disable) the states you want to apply to this softkey.
8. Click  to save your changes.
9. Click on **Operation->Reset**.
10. In the "**Restart Phone**" field click  to restart the IP phone.

## Softkeys as Directory

By default, the 57i CT has a Directory key configured on key 2 of the top set of keys. However, using the Aastra Web UI, you can assign the Directory key to any softkey on the top or bottom keys on the phone..

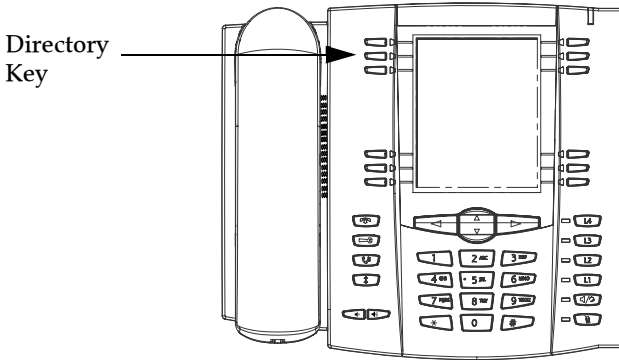

*The "Directory List" feature allows you to store frequently used names and numbers on the phone. You can also dial directly from a directory entry. You can use the Directory key to access a Directory List which contains a customized list of names with phone numbers and labels.*

In addition to creating a Directory softkey, you can also download a Directory List to your PC if required using the Aastra Web UI.

### **Reference**

For more information about the Directory List, see "[Directory List](#)" on [page 80](#).





Use the following procedure to configure a Directory softkey on the 57i CT phone.

1. Click on **Operation->Softkeys and XML.**

**Status**

System Information

**Operation**

User Password

Phone Lock

Softkeys and XML

Directory

Reset

**Basic Settings**

Preferences

Call Forward

### Softkeys Configuration

Bottom Keys
Top Keys

Key	Type	Label	Value	Line	Idle	Connected	Incoming	Outgoing	Busy
1	BLFList	labtest	1111	2	<input checked="" type="checkbox"/>	<input checked="" type="checkbox"/>	<input checked="" type="checkbox"/>	<input checked="" type="checkbox"/>	<input checked="" type="checkbox"/>
2	Speeddial	Portal		1	<input checked="" type="checkbox"/>	<input checked="" type="checkbox"/>	<input checked="" type="checkbox"/>	<input checked="" type="checkbox"/>	<input checked="" type="checkbox"/>
3	Speeddial	Speed Dial	1111	1	<input checked="" type="checkbox"/>	<input checked="" type="checkbox"/>	<input checked="" type="checkbox"/>	<input checked="" type="checkbox"/>	<input checked="" type="checkbox"/>
4	Speeddial	Call Return	*60	1	<input checked="" type="checkbox"/>	<input checked="" type="checkbox"/>	<input checked="" type="checkbox"/>	<input checked="" type="checkbox"/>	<input checked="" type="checkbox"/>
5	Speeddial	Pickup	*98	1	<input checked="" type="checkbox"/>	<input checked="" type="checkbox"/>	<input checked="" type="checkbox"/>	<input checked="" type="checkbox"/>	<input checked="" type="checkbox"/>
6	Speeddial	CallFwdOn	*72	1	<input checked="" type="checkbox"/>	<input checked="" type="checkbox"/>	<input checked="" type="checkbox"/>	<input checked="" type="checkbox"/>	<input checked="" type="checkbox"/>
7	Speeddial	CallFwdOff	*73	1	<input checked="" type="checkbox"/>	<input checked="" type="checkbox"/>	<input checked="" type="checkbox"/>	<input checked="" type="checkbox"/>	<input checked="" type="checkbox"/>
8	Speeddial	DND On	*78	1	<input checked="" type="checkbox"/>	<input checked="" type="checkbox"/>	<input checked="" type="checkbox"/>	<input checked="" type="checkbox"/>	<input checked="" type="checkbox"/>
9	Speeddial	DND Off	*79	1	<input checked="" type="checkbox"/>	<input checked="" type="checkbox"/>	<input checked="" type="checkbox"/>	<input checked="" type="checkbox"/>	<input checked="" type="checkbox"/>
10	Speeddial	CLIDBlock	*67	1	<input checked="" type="checkbox"/>	<input checked="" type="checkbox"/>	<input checked="" type="checkbox"/>	<input checked="" type="checkbox"/>	<input checked="" type="checkbox"/>
11	Speeddial	Trace	*67	1	<input checked="" type="checkbox"/>	<input checked="" type="checkbox"/>	<input checked="" type="checkbox"/>	<input checked="" type="checkbox"/>	<input checked="" type="checkbox"/>
12	Speeddial	Clear MWH	*99	1	<input checked="" type="checkbox"/>	<input checked="" type="checkbox"/>	<input checked="" type="checkbox"/>	<input checked="" type="checkbox"/>	<input checked="" type="checkbox"/>
13	Speeddial	Cancel CW	*70	1	<input checked="" type="checkbox"/>	<input checked="" type="checkbox"/>	<input checked="" type="checkbox"/>	<input checked="" type="checkbox"/>	<input checked="" type="checkbox"/>
14	Speeddial	Unpak	*88	1	<input checked="" type="checkbox"/>	<input checked="" type="checkbox"/>	<input checked="" type="checkbox"/>	<input checked="" type="checkbox"/>	<input checked="" type="checkbox"/>
15	None			1	<input checked="" type="checkbox"/>	<input checked="" type="checkbox"/>	<input checked="" type="checkbox"/>	<input checked="" type="checkbox"/>	<input checked="" type="checkbox"/>
16	None			1	<input checked="" type="checkbox"/>	<input checked="" type="checkbox"/>	<input checked="" type="checkbox"/>	<input checked="" type="checkbox"/>	<input checked="" type="checkbox"/>
17	None			1	<input checked="" type="checkbox"/>	<input checked="" type="checkbox"/>	<input checked="" type="checkbox"/>	<input checked="" type="checkbox"/>	<input checked="" type="checkbox"/>
18	None			1	<input checked="" type="checkbox"/>	<input checked="" type="checkbox"/>	<input checked="" type="checkbox"/>	<input checked="" type="checkbox"/>	<input checked="" type="checkbox"/>
19	None			1	<input checked="" type="checkbox"/>	<input checked="" type="checkbox"/>	<input checked="" type="checkbox"/>	<input checked="" type="checkbox"/>	<input checked="" type="checkbox"/>
20	None			1	<input checked="" type="checkbox"/>	<input checked="" type="checkbox"/>	<input checked="" type="checkbox"/>	<input checked="" type="checkbox"/>	<input checked="" type="checkbox"/>

**Services**

XML Application URI:

XML Application Title:

BLF List URI:

2. Click on the **Bottom** tab or the **Top** tab.
3. Select from "**Key 1**" through "**Key 20**" on the bottom tab.  
or  
Select from "**Key 1**" through "**Key 10**" on the top tab.
4. In the "**Type**" field, select **Directory**.
5. In the "**Label**" field, enter a label to apply to this softkey.
6. If configuring a softkey on the Bottom Keys, in the state fields, check (enable) or uncheck (disable) the states you want to apply to this softkey.
7. Click  to save your changes.
8. Click on **Operation->Reset**.
9. In the "**Restart Phone**" field click  to restart the IP phone.

## Softkeys as Callers List

By default, the 57i CT has a Callers List key configured on key 3 of the top set of keys. However, using the Aastra Web UI, you can assign the Callers List key to any softkey on the top or bottom keys on the phone.

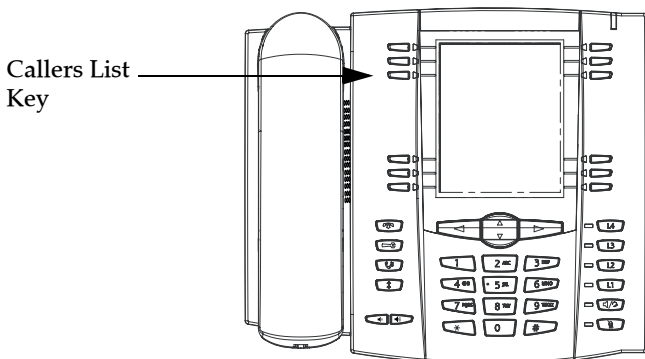

The Callers list is a stored log of your incoming calls. You can use the Callers List key to access a list of callers that called your phone.

### Reference

For more information about the Callers List, see "[Suppressing DTMF Playback](#)" on [page 120](#).

### Setting Callers List Softkey



Aastra Web UI

Use the following procedure to configure a Callers List softkey on the 57i CT phone.

1. Click on **Operation->Softkeys and XML**.

**Status**  
System Information

**Operation**  
Open Password  
Phone Lock  
Softkeys and XML  
Directory  
Reset

**Basic Settings**  
Preferences  
Call Forward

**Softkeys Configuration**

Bottom Keys    Top Keys

Key	Type	Label	Value	Line	Idle	Connected	Incoming	Outgoing	Busy
1	BLF/List	CallList	0111	2	<input checked="" type="checkbox"/>	<input checked="" type="checkbox"/>	<input checked="" type="checkbox"/>	<input checked="" type="checkbox"/>	<input checked="" type="checkbox"/>
2	Speedial	Portal		1	<input checked="" type="checkbox"/>	<input checked="" type="checkbox"/>	<input checked="" type="checkbox"/>	<input checked="" type="checkbox"/>	<input checked="" type="checkbox"/>
3	Speedial	Speed Dial	0111	1	<input checked="" type="checkbox"/>	<input checked="" type="checkbox"/>	<input checked="" type="checkbox"/>	<input checked="" type="checkbox"/>	<input checked="" type="checkbox"/>
4	Speedial	Call Return	790	1	<input checked="" type="checkbox"/>	<input checked="" type="checkbox"/>	<input checked="" type="checkbox"/>	<input checked="" type="checkbox"/>	<input checked="" type="checkbox"/>
5	Speedial	Flipup	790	1	<input checked="" type="checkbox"/>	<input checked="" type="checkbox"/>	<input checked="" type="checkbox"/>	<input checked="" type="checkbox"/>	<input checked="" type="checkbox"/>
6	Speedial	CallFwdOn	772	1	<input checked="" type="checkbox"/>	<input checked="" type="checkbox"/>	<input checked="" type="checkbox"/>	<input checked="" type="checkbox"/>	<input checked="" type="checkbox"/>
7	Speedial	CallFwdOff	773	1	<input checked="" type="checkbox"/>	<input checked="" type="checkbox"/>	<input checked="" type="checkbox"/>	<input checked="" type="checkbox"/>	<input checked="" type="checkbox"/>
8	Speedial	DND On	778	1	<input checked="" type="checkbox"/>	<input checked="" type="checkbox"/>	<input checked="" type="checkbox"/>	<input checked="" type="checkbox"/>	<input checked="" type="checkbox"/>
9	Speedial	DND Off	779	1	<input checked="" type="checkbox"/>	<input checked="" type="checkbox"/>	<input checked="" type="checkbox"/>	<input checked="" type="checkbox"/>	<input checked="" type="checkbox"/>
10	Speedial	CLIRBlock	707	1	<input checked="" type="checkbox"/>	<input checked="" type="checkbox"/>	<input checked="" type="checkbox"/>	<input checked="" type="checkbox"/>	<input checked="" type="checkbox"/>
11	Speedial	Trace	707	1	<input checked="" type="checkbox"/>	<input checked="" type="checkbox"/>	<input checked="" type="checkbox"/>	<input checked="" type="checkbox"/>	<input checked="" type="checkbox"/>
12	Speedial	Clear MMR	709	1	<input checked="" type="checkbox"/>	<input checked="" type="checkbox"/>	<input checked="" type="checkbox"/>	<input checked="" type="checkbox"/>	<input checked="" type="checkbox"/>
13	Speedial	Cancel CW	770	1	<input checked="" type="checkbox"/>	<input checked="" type="checkbox"/>	<input checked="" type="checkbox"/>	<input checked="" type="checkbox"/>	<input checked="" type="checkbox"/>
14	Speedial	Unpark	789	1	<input checked="" type="checkbox"/>	<input checked="" type="checkbox"/>	<input checked="" type="checkbox"/>	<input checked="" type="checkbox"/>	<input checked="" type="checkbox"/>
15	None			1	<input checked="" type="checkbox"/>	<input checked="" type="checkbox"/>	<input checked="" type="checkbox"/>	<input checked="" type="checkbox"/>	<input checked="" type="checkbox"/>
16	None			1	<input checked="" type="checkbox"/>	<input checked="" type="checkbox"/>	<input checked="" type="checkbox"/>	<input checked="" type="checkbox"/>	<input checked="" type="checkbox"/>
17	None			1	<input checked="" type="checkbox"/>	<input checked="" type="checkbox"/>	<input checked="" type="checkbox"/>	<input checked="" type="checkbox"/>	<input checked="" type="checkbox"/>
18	None			1	<input checked="" type="checkbox"/>	<input checked="" type="checkbox"/>	<input checked="" type="checkbox"/>	<input checked="" type="checkbox"/>	<input checked="" type="checkbox"/>
19	None			1	<input checked="" type="checkbox"/>	<input checked="" type="checkbox"/>	<input checked="" type="checkbox"/>	<input checked="" type="checkbox"/>	<input checked="" type="checkbox"/>
20	None			1	<input checked="" type="checkbox"/>	<input checked="" type="checkbox"/>	<input checked="" type="checkbox"/>	<input checked="" type="checkbox"/>	<input checked="" type="checkbox"/>

**Services**

XML Application URI:

XML Application Title:

BLF List URI:

2. Click on the **Bottom** tab or the **Top** tab.
3. Select from "**Key 1**" through "**Key 20**" on the bottom tab.  
or  
Select from "**Key 1**" through "**Key 10**" on the top tab.
4. In the "**Type**" field, select **Callers List**.
5. In the "**Label**" field, enter a label to apply to this softkey.
6. If configuring a softkey on the Bottom Keys, in the state fields, check (enable) or uncheck (disable) the states you want to apply to this softkey.
7. Click  to save your changes.
8. Click on **Operation->Reset**.
9. In the "**Restart Phone**" field click  to restart the IP phone.

## Softkeys as an Intercom Key

By default, the 57i CT has an Intercom key configured on key 4 of the top set of keys. However, using the Aastra Web UI, you can assign the Intercom key to any softkey on the top or bottom keys on the phone..

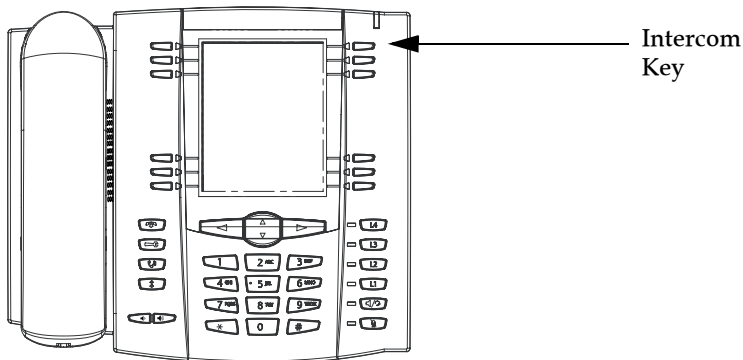

*You can use the Intercom key to automatically connect with a remote extension for outgoing calls, and to answer an incoming intercom call.*

### Reference

For more information about the Intercom key, see "[Intercom](#)" on [page 68](#).

### Setting an Intercom Softkey



#### Aastra Web UI

---

Use the following procedure to configure an Intercom softkey on the 57i CT phone.

# 1. Click on **Operation->Softkeys and XML.**

**Softkeys Configuration**

Bottom Keys | Top Keys

Key	Type	Label	Value	Line	Idle	Connected	Incoming	Outgoing	Busy
1	BLFList	Intercom	1111	2	<input checked="" type="checkbox"/>	<input checked="" type="checkbox"/>	<input checked="" type="checkbox"/>	<input checked="" type="checkbox"/>	<input checked="" type="checkbox"/>
2	Speedial	Portal		1	<input checked="" type="checkbox"/>	<input checked="" type="checkbox"/>	<input checked="" type="checkbox"/>	<input checked="" type="checkbox"/>	<input checked="" type="checkbox"/>
3	Speedial	Speed Dial	1111	1	<input checked="" type="checkbox"/>	<input checked="" type="checkbox"/>	<input checked="" type="checkbox"/>	<input checked="" type="checkbox"/>	<input checked="" type="checkbox"/>
4	Speedial	Call Return	*50	1	<input checked="" type="checkbox"/>	<input checked="" type="checkbox"/>	<input checked="" type="checkbox"/>	<input checked="" type="checkbox"/>	<input checked="" type="checkbox"/>
5	Speedial	Pickup	*58	1	<input checked="" type="checkbox"/>	<input checked="" type="checkbox"/>	<input checked="" type="checkbox"/>	<input checked="" type="checkbox"/>	<input checked="" type="checkbox"/>
6	Speedial	CallFwdOn	*72	1	<input checked="" type="checkbox"/>	<input checked="" type="checkbox"/>	<input checked="" type="checkbox"/>	<input checked="" type="checkbox"/>	<input checked="" type="checkbox"/>
7	Speedial	CallFwdOff	*73	1	<input checked="" type="checkbox"/>	<input checked="" type="checkbox"/>	<input checked="" type="checkbox"/>	<input checked="" type="checkbox"/>	<input checked="" type="checkbox"/>
8	Speedial	DND On	*78	1	<input checked="" type="checkbox"/>	<input checked="" type="checkbox"/>	<input checked="" type="checkbox"/>	<input checked="" type="checkbox"/>	<input checked="" type="checkbox"/>
9	Speedial	DND Off	*79	1	<input checked="" type="checkbox"/>	<input checked="" type="checkbox"/>	<input checked="" type="checkbox"/>	<input checked="" type="checkbox"/>	<input checked="" type="checkbox"/>
10	Speedial	CLIRBlock	*57	1	<input checked="" type="checkbox"/>	<input checked="" type="checkbox"/>	<input checked="" type="checkbox"/>	<input checked="" type="checkbox"/>	<input checked="" type="checkbox"/>
11	Speedial	Trans	*57	1	<input checked="" type="checkbox"/>	<input checked="" type="checkbox"/>	<input checked="" type="checkbox"/>	<input checked="" type="checkbox"/>	<input checked="" type="checkbox"/>
12	Speedial	Clear MMR	*50	1	<input checked="" type="checkbox"/>	<input checked="" type="checkbox"/>	<input checked="" type="checkbox"/>	<input checked="" type="checkbox"/>	<input checked="" type="checkbox"/>
13	Speedial	Cancel CW	*70	1	<input checked="" type="checkbox"/>	<input checked="" type="checkbox"/>	<input checked="" type="checkbox"/>	<input checked="" type="checkbox"/>	<input checked="" type="checkbox"/>
14	Speedial	Unpak	*58	1	<input checked="" type="checkbox"/>	<input checked="" type="checkbox"/>	<input checked="" type="checkbox"/>	<input checked="" type="checkbox"/>	<input checked="" type="checkbox"/>
15	None			1	<input checked="" type="checkbox"/>	<input checked="" type="checkbox"/>	<input checked="" type="checkbox"/>	<input checked="" type="checkbox"/>	<input checked="" type="checkbox"/>
16	None			1	<input checked="" type="checkbox"/>	<input checked="" type="checkbox"/>	<input checked="" type="checkbox"/>	<input checked="" type="checkbox"/>	<input checked="" type="checkbox"/>
17	None			1	<input checked="" type="checkbox"/>	<input checked="" type="checkbox"/>	<input checked="" type="checkbox"/>	<input checked="" type="checkbox"/>	<input checked="" type="checkbox"/>
18	None			1	<input checked="" type="checkbox"/>	<input checked="" type="checkbox"/>	<input checked="" type="checkbox"/>	<input checked="" type="checkbox"/>	<input checked="" type="checkbox"/>
19	None			1	<input checked="" type="checkbox"/>	<input checked="" type="checkbox"/>	<input checked="" type="checkbox"/>	<input checked="" type="checkbox"/>	<input checked="" type="checkbox"/>
20	None			1	<input checked="" type="checkbox"/>	<input checked="" type="checkbox"/>	<input checked="" type="checkbox"/>	<input checked="" type="checkbox"/>	<input checked="" type="checkbox"/>

**Services**

XML Application URI:

XML Application Title:

BLF List URI:

2. Click on the **Bottom** tab or the **Top** tab.
3. Select from **"Key 1"** through **"Key 20"** on the bottom tab.  
or  
Select from **"Key 1"** through **"Key 10"** on the top tab.
4. In the **"Type"** field, select **Intercom**.
5. In the **"Label"** field, enter a label to apply to this softkey.
6. If configuring a softkey on the Bottom Keys, in the state fields, check (enable) or uncheck (disable) the states you want to apply to this softkey.
7. Click  to save your changes.
8. Click on **Operation->Reset**.
9. In the **"Restart Phone"** field click  to restart the IP phone.

## Softkeys as an Empty Key

You can set a softkey to force a blank entry on the IP phone display for a specific softkey. You do this by setting the softkey to "**empty**". The soft keys are added in order (from softkey1 to softkey20) after any hard-coded keys have been added. If a particular soft key is not defined, it is ignored.

### Setting an Empty Softkey



Aastra Web UI

Use the following procedure to configure an Empty softkey on the 57i CT phone.

#### 1. Click on **Operation->Softkeys and XML**.

Key	Type	Label	Value	Line	Idle	Connected	Incoming	Outgoing	Busy
1	BLFList	Label	1111	2	<input checked="" type="checkbox"/>	<input checked="" type="checkbox"/>	<input checked="" type="checkbox"/>	<input checked="" type="checkbox"/>	<input checked="" type="checkbox"/>
2	Speedial	Portal		1	<input checked="" type="checkbox"/>	<input checked="" type="checkbox"/>	<input checked="" type="checkbox"/>	<input checked="" type="checkbox"/>	<input checked="" type="checkbox"/>
3	Speedial	Speed Dial	1111	1	<input checked="" type="checkbox"/>	<input checked="" type="checkbox"/>	<input checked="" type="checkbox"/>	<input checked="" type="checkbox"/>	<input checked="" type="checkbox"/>
4	Speedial	Call Return	909	1	<input checked="" type="checkbox"/>	<input checked="" type="checkbox"/>	<input checked="" type="checkbox"/>	<input checked="" type="checkbox"/>	<input checked="" type="checkbox"/>
5	Speedial	Pinup	909	1	<input checked="" type="checkbox"/>	<input checked="" type="checkbox"/>	<input checked="" type="checkbox"/>	<input checked="" type="checkbox"/>	<input checked="" type="checkbox"/>
6	Speedial	CallForward	772	1	<input checked="" type="checkbox"/>	<input checked="" type="checkbox"/>	<input checked="" type="checkbox"/>	<input checked="" type="checkbox"/>	<input checked="" type="checkbox"/>
7	Speedial	CallForward	773	1	<input checked="" type="checkbox"/>	<input checked="" type="checkbox"/>	<input checked="" type="checkbox"/>	<input checked="" type="checkbox"/>	<input checked="" type="checkbox"/>
8	Speedial	OND On	770	1	<input checked="" type="checkbox"/>	<input checked="" type="checkbox"/>	<input checked="" type="checkbox"/>	<input checked="" type="checkbox"/>	<input checked="" type="checkbox"/>
9	Speedial	OND Off	770	1	<input checked="" type="checkbox"/>	<input checked="" type="checkbox"/>	<input checked="" type="checkbox"/>	<input checked="" type="checkbox"/>	<input checked="" type="checkbox"/>
10	Speedial	CLIPBlock	907	1	<input checked="" type="checkbox"/>	<input checked="" type="checkbox"/>	<input checked="" type="checkbox"/>	<input checked="" type="checkbox"/>	<input checked="" type="checkbox"/>
11	Speedial	Trave	907	1	<input checked="" type="checkbox"/>	<input checked="" type="checkbox"/>	<input checked="" type="checkbox"/>	<input checked="" type="checkbox"/>	<input checked="" type="checkbox"/>
12	Speedial	Clear MMR	999	1	<input checked="" type="checkbox"/>	<input checked="" type="checkbox"/>	<input checked="" type="checkbox"/>	<input checked="" type="checkbox"/>	<input checked="" type="checkbox"/>
13	Speedial	Cancel CW	770	1	<input checked="" type="checkbox"/>	<input checked="" type="checkbox"/>	<input checked="" type="checkbox"/>	<input checked="" type="checkbox"/>	<input checked="" type="checkbox"/>
14	Speedial	Unpark	909	1	<input checked="" type="checkbox"/>	<input checked="" type="checkbox"/>	<input checked="" type="checkbox"/>	<input checked="" type="checkbox"/>	<input checked="" type="checkbox"/>
15	None			1	<input checked="" type="checkbox"/>	<input checked="" type="checkbox"/>	<input checked="" type="checkbox"/>	<input checked="" type="checkbox"/>	<input checked="" type="checkbox"/>
16	None			1	<input checked="" type="checkbox"/>	<input checked="" type="checkbox"/>	<input checked="" type="checkbox"/>	<input checked="" type="checkbox"/>	<input checked="" type="checkbox"/>
17	None			1	<input checked="" type="checkbox"/>	<input checked="" type="checkbox"/>	<input checked="" type="checkbox"/>	<input checked="" type="checkbox"/>	<input checked="" type="checkbox"/>
18	None			1	<input checked="" type="checkbox"/>	<input checked="" type="checkbox"/>	<input checked="" type="checkbox"/>	<input checked="" type="checkbox"/>	<input checked="" type="checkbox"/>
19	None			1	<input checked="" type="checkbox"/>	<input checked="" type="checkbox"/>	<input checked="" type="checkbox"/>	<input checked="" type="checkbox"/>	<input checked="" type="checkbox"/>
20	None			1	<input checked="" type="checkbox"/>	<input checked="" type="checkbox"/>	<input checked="" type="checkbox"/>	<input checked="" type="checkbox"/>	<input checked="" type="checkbox"/>

Services

XML Application URI:

XML Application Title:

BLF List URI:

#### 2. Click on the **Bottom** tab or the **Top** tab.

#### 3. Select from "**Key 1**" through "**Key 20**" on the bottom tab.

or

Select from "**Key 1**" through "**Key 10**" on the top tab.

#### 4. In the "**Type**" field, select **Empty**.

#### 5. If configuring a softkey on the Bottom Keys, in the state fields, check (enable) or uncheck (disable) the states you want to apply to this softkey.

#### 6. Click to save your changes.

#### 7. Click on **Operation->Reset**.

#### 8. In the "**Restart Phone**" field click to restart the IP phone.



Use the following procedure to delete a softkey function using the Aastra Web UI.

1. Click on **Operation->Softkeys and XML**.

**Softkeys Configuration**

Bottom Keys | Top Keys

Key	Type	Label	Value	Line	Idle	Connected	Incoming	Outgoing	Busy
1	BLFList	Label	0111	2	<input checked="" type="checkbox"/>	<input checked="" type="checkbox"/>	<input checked="" type="checkbox"/>	<input checked="" type="checkbox"/>	<input checked="" type="checkbox"/>
2	Speedial	Portal		1	<input checked="" type="checkbox"/>	<input checked="" type="checkbox"/>	<input checked="" type="checkbox"/>	<input checked="" type="checkbox"/>	<input checked="" type="checkbox"/>
3	Speedial	Speed Dial	0111	1	<input checked="" type="checkbox"/>	<input checked="" type="checkbox"/>	<input checked="" type="checkbox"/>	<input checked="" type="checkbox"/>	<input checked="" type="checkbox"/>
4	Speedial	Call Return	799	1	<input checked="" type="checkbox"/>	<input checked="" type="checkbox"/>	<input checked="" type="checkbox"/>	<input checked="" type="checkbox"/>	<input checked="" type="checkbox"/>
5	Speedial	Findup	790	1	<input checked="" type="checkbox"/>	<input checked="" type="checkbox"/>	<input checked="" type="checkbox"/>	<input checked="" type="checkbox"/>	<input checked="" type="checkbox"/>
6	Speedial	CallForward	772	1	<input checked="" type="checkbox"/>	<input checked="" type="checkbox"/>	<input checked="" type="checkbox"/>	<input checked="" type="checkbox"/>	<input checked="" type="checkbox"/>
7	Speedial	CallForward	773	1	<input checked="" type="checkbox"/>	<input checked="" type="checkbox"/>	<input checked="" type="checkbox"/>	<input checked="" type="checkbox"/>	<input checked="" type="checkbox"/>
8	Speedial	DND On	778	1	<input checked="" type="checkbox"/>	<input checked="" type="checkbox"/>	<input checked="" type="checkbox"/>	<input checked="" type="checkbox"/>	<input checked="" type="checkbox"/>
9	Speedial	DND Off	779	1	<input checked="" type="checkbox"/>	<input checked="" type="checkbox"/>	<input checked="" type="checkbox"/>	<input checked="" type="checkbox"/>	<input checked="" type="checkbox"/>
10	Speedial	CLIRBlock	787	1	<input checked="" type="checkbox"/>	<input checked="" type="checkbox"/>	<input checked="" type="checkbox"/>	<input checked="" type="checkbox"/>	<input checked="" type="checkbox"/>
11	Speedial	Trace	797	1	<input checked="" type="checkbox"/>	<input checked="" type="checkbox"/>	<input checked="" type="checkbox"/>	<input checked="" type="checkbox"/>	<input checked="" type="checkbox"/>
12	Speedial	Clear MMR	799	1	<input checked="" type="checkbox"/>	<input checked="" type="checkbox"/>	<input checked="" type="checkbox"/>	<input checked="" type="checkbox"/>	<input checked="" type="checkbox"/>
13	Speedial	Cancel CW	770	1	<input checked="" type="checkbox"/>	<input checked="" type="checkbox"/>	<input checked="" type="checkbox"/>	<input checked="" type="checkbox"/>	<input checked="" type="checkbox"/>
14	Speedial	Unpak	799	1	<input checked="" type="checkbox"/>	<input checked="" type="checkbox"/>	<input checked="" type="checkbox"/>	<input checked="" type="checkbox"/>	<input checked="" type="checkbox"/>
15	None			1	<input checked="" type="checkbox"/>	<input checked="" type="checkbox"/>	<input checked="" type="checkbox"/>	<input checked="" type="checkbox"/>	<input checked="" type="checkbox"/>
16	None			1	<input checked="" type="checkbox"/>	<input checked="" type="checkbox"/>	<input checked="" type="checkbox"/>	<input checked="" type="checkbox"/>	<input checked="" type="checkbox"/>
17	None			1	<input checked="" type="checkbox"/>	<input checked="" type="checkbox"/>	<input checked="" type="checkbox"/>	<input checked="" type="checkbox"/>	<input checked="" type="checkbox"/>
18	None			1	<input checked="" type="checkbox"/>	<input checked="" type="checkbox"/>	<input checked="" type="checkbox"/>	<input checked="" type="checkbox"/>	<input checked="" type="checkbox"/>
19	None			1	<input checked="" type="checkbox"/>	<input checked="" type="checkbox"/>	<input checked="" type="checkbox"/>	<input checked="" type="checkbox"/>	<input checked="" type="checkbox"/>
20	None			1	<input checked="" type="checkbox"/>	<input checked="" type="checkbox"/>	<input checked="" type="checkbox"/>	<input checked="" type="checkbox"/>	<input checked="" type="checkbox"/>

Services

XML Application URI:

XML Application Title:

BLF List URI:



- Click on the **Bottom** tab or the **Top** tab.
- Select from **"Key 1"** through **"Key 20"** on the bottom tab.  
or  
Select from **"Key 1"** through **"Key 10"** on the top tab.
- In the **"Type"** field, select **none**.
- Click  to save your changes.
- Click on **Operation->Reset**.
- In the **"Restart Phone"** field click  to restart the IP phone.  
The softkey function is deleted from the IP phone memory.

## Restarting your phone

You may want to restart your phone to check for updates on the server. You may occasionally need to restart your phone to set changes or updates to your phone or network settings. You may also need to restart your phone if you have been asked to do so by your system administrator, or should you experience any unexpected behaviour.



### IP Phone UI

1. Press the  button on the phone to enter the Options List.
2. Use the  key to scroll down the list of options to **Phone Status** and press **Show** to select.
3. Press the  key to scroll to the **Restart Phone** option.
4. Press **Show** to select the **Restart Phone** option.
5. Press **Restart** to restart of the phone. If you do not wish to restart your phone, press Cancel.

**Note:** Your phone will be out of service temporarily during the restart and downloading process.



### Aastra Web UI

1. Click on **Operation->Reset**.

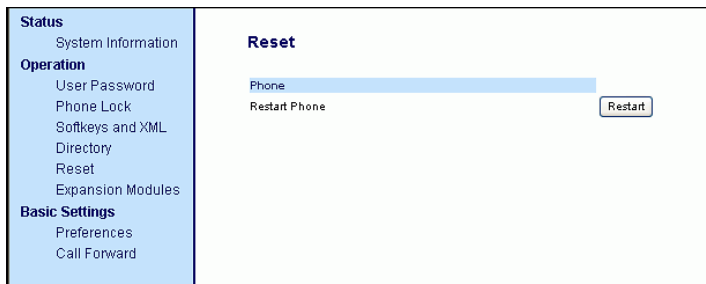

2. Click .
3. Click **OK** at the confirmation prompt.



# Making Calls

## Dialing a Number

First, take the phone off-hook by:

- lifting the handset
- pressing  or
- pressing a line/call appearance button.

At the dial tone, enter the number you wish to call. If you are unable to make calls within certain area codes, check with your system administrator for any toll restrictions placed on your extension that may restrict your access to long distance area codes or dialling prefixes.

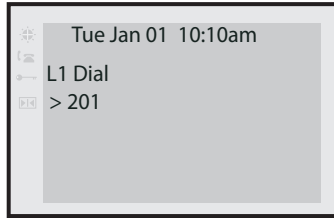

When your party picks up, a timer appears on your display that records the length of your call.

## Pre-dialing a Number

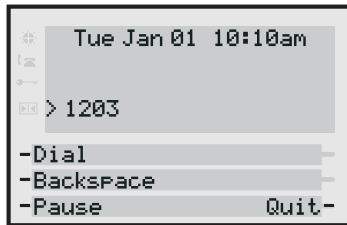

You can also make a call by pre-dialling a number. Pre-dialling lets you view a number before you dial. Use the **Backspace** softkey to correct any errors.

## Using Handsfree Speakerphone

The handsfree feature allows you to speak to someone without using the handset or headset. Your phone must be in either the Speaker or Speaker/Headset audio mode. You can set your desired audio mode using the **Headset Settings** option from the Options list. For more information, see the section "**Customizing Your Phone**" in the *57i CT Installation Guide*.



### IP Phone UI

- To dial using handsfree, first press and enter a number at the dial tone.
- If in speaker audio mode, press to switch between handsfree and handset.
- If in speaker/headset audio mode, press to switch between handsfree and headset.
- When the handset is on hook, press to disconnect a handsfree call.

When handsfree is on, the speaker light turns on.

## Using a Headset

The 57i CT accepts headsets through the modular RJ22 jack on the back of the phone. Contact your telephone equipment retailer or distributor to purchase a compatible headset.

**Note:** Customers should read and observe all safety recommendations contained in headset operating guides when using any headset.

### *Advanced Volume Controls for the Headset Mic*

On the 57i CT, there are 3 options for the headset microphone volume.



### IP Phone UI

#### *To change this volume*

1. Press to enter the Options list.
2. Use to scroll down the list of options to **Headset Settings** and press **Show**.  
or
3. Press the list number to jump directly to this option, and press **Show**.
4. Press to scroll down to **headset/mic volume** and press **Show**.
5. Use to scroll down the list and press **Show** to select your desired volume.

6. Press **Done** to save changes and exit.
  7. If you do not wish to save changes, press **Cancel** to return to the previous screen.
- Note:** By default, the volume for the headset microphone is set to medium.



### *To Make and Receive Calls Using a Headset*

---



#### IP Phone UI

---

1. Ensure that you have selected a headset audio mode by accessing the Options list (under option **Headset Settings**).
2. Plug the headset into the jack.
3. Press the  key to obtain a dial tone or to answer an incoming call. Depending on the audio mode selected from the Options menu, a dial tone or an incoming call will be received on either the headset or the handsfree speakerphone.
4. Press the  to end the call.

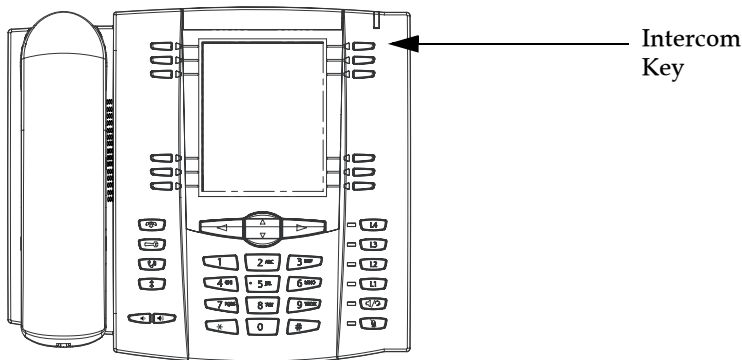

## Intercom

On the 57i CT, you can use the **Intercom** key to automatically connect with a remote extension. By default, the Intercom key is configured as Key 4 on the top set of softkeys.



### IP Phone UI

#### *To use the Intercom key*

1. Press the **Intercom** key.
2. Enter the extension number of the person you wish to intercom or the BLF softkey for that extension.
3. After a beep tone, your phone will automatically connect with the remote extension and you can speak through its speaker.
4. To cancel intercom, press  or the **Cancel** softkey.
5. When you are finished speaking, hang up the phone by placing the handset back on-hook or by pressing  or the line/call appearance button for the active call. When you hang up, the remote phone will also hang up.

#### *Incoming Intercom Calls*

On the 57i CT, you can receive incoming intercom calls. By default, the microphone for an incoming intercom call is OFF, and the automatic answer for an intercom call is ON.

Using the Aastra Web UI, you can enable (turn ON) or disable (turn OFF) the microphone or automatic answering (auto-answer) on the IP phone for incoming intercom calls. If auto-answer is enabled on the IP phone, the phone plays a tone to alert the user before answering the intercom call. If auto-answer is disabled, the phone rejects the incoming intercom call and sends a busy signal to the caller.

Use the following procedure to enable/disable the microphone and/or auto-answer on the IP phone.

1. Click on **Basic Settings->Preferences->Incoming Intercom Settings**.

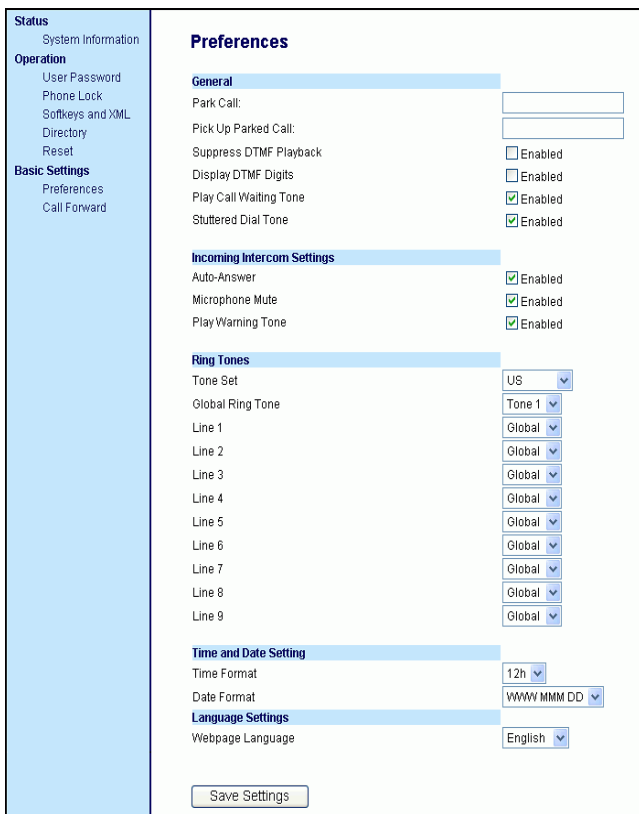

The screenshot shows the Aastra Web UI interface. On the left is a navigation menu with sections: Status (System Information), Operation (User Password, Phone Lock, Softkeys and XML, Directory, Reset), and Basic Settings (Preferences, Call Forward). The main content area is titled 'Preferences' and contains several sections: 'General' with fields for Park Call, Pick Up Parked Call, Suppress DTMF Playback, Display DTMF Digits, Play Call Waiting Tone, and Stuttered Dial Tone; 'Incoming Intercom Settings' with Auto-Answer, Microphone Mute, and Play Warning Tone; 'Ring Tones' with Tone Set, Global Ring Tone, and Line 1-9; 'Time and Date Setting' with Time Format and Date Format; and 'Language Settings' with Webpage Language. A 'Save Settings' button is at the bottom.

Section	Field	Value/Status
General	Park Call:	[Empty Text Box]
	Pick Up Parked Call:	[Empty Text Box]
	Suppress DTMF Playback	<input type="checkbox"/> Enabled
	Display DTMF Digits	<input type="checkbox"/> Enabled
	Play Call Waiting Tone	<input checked="" type="checkbox"/> Enabled
	Stuttered Dial Tone	<input checked="" type="checkbox"/> Enabled
Incoming Intercom Settings	Auto-Answer	<input checked="" type="checkbox"/> Enabled
	Microphone Mute	<input checked="" type="checkbox"/> Enabled
	Play Warning Tone	<input checked="" type="checkbox"/> Enabled
Ring Tones	Tone Set	US
	Global Ring Tone	Tone 1
	Line 1	Global
	Line 2	Global
	Line 3	Global
	Line 4	Global
	Line 5	Global
	Line 6	Global
	Line 7	Global
Line 8	Global	
Line 9	Global	
Time and Date Setting	Time Format	12h
	Date Format	WWW MMM DD
Language Settings	Webpage Language	English

The "**Microphone Mute**" field is enabled by default (turned OFF).

The "**Auto-Answer**" field is enabled by default (turned ON).

2. To disable the "**Microphone Mute**" field (turn ON), uncheck the check box.
  3. To disable the "**Auto-Answer**" field (turn OFF), uncheck the check box.
  4. Click  to save your changes.
  5. Click on **Operation->Reset**.
  6. In the "**Restart Phone**" field click  to restart the IP phone.
- Refer to the following procedure for using the Intercom feature.



## Redial

---



### IP Phone UI

---

- Press  to dial the most recent number you dialed from the phone.
- If you are off-hook and press  the last number you called will be called back.
- If you are on-hook and press , a **Redial Directory** list appears on-screen.

The redial list stores up to the last 100 numbers you called, allowing you to scroll through and select the number you wish to redial.

**Note:** Your system administrator can set your Redial key to speedial a specific number. Contact your system administrator for more information.









### *Accessing the Redial List*

---



### IP Phone UI

---

1. If you are off-hook and press , the telephone automatically dials the last number you called.
2. If you are not on the phone, press  to display the most recently dialed number and use   to scroll through the list to view the other numbers
3. Press  to see the second most recently dialed number, or  to see the oldest call on your list.
4. To dial the displayed number press , or lift the Handset or press any line keys.
5. Press  or the  key to cancel.

### *Deleting from the Redial List*

**Note:** You cannot delete individual entries in the Redial List.

---



### IP Phone UI

---

#### *To Delete All Items*

1. Press .
2. Press the **Delete** Key, then press the **Delete** Key again at the prompt to erase all items.



## Mute

---



### IP Phone UI

---

Press the  button at any time to mute handset, headset or handsfree. The speaker light will flash slowly and you can hear the caller, but they cannot hear you. To switch mute on or off, press .

**Note:** If you place a muted call on hold, the phone automatically takes the call off mute when you reconnect to the call.

## Receiving Calls

When a call is ringing at your extension, you will see the "**Inbound Call**" Screen. The line/call appearance light flashes quickly for the incoming call.

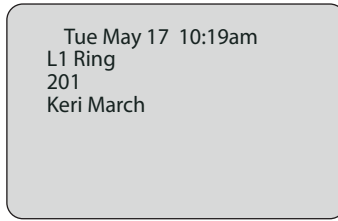



### Answering an Incoming Call



#### IP Phone UI

##### *To answer the call*

- For handsfree operation, press  or the line/call appearance button for the incoming call.
- Press  for handsfree or headset operation.

**Note:** The audio mode setting you have selected in the options list under **Headset Settings** determines if the call goes to handsfree or headset operation. For more information, see the section "**Customizing Your Phone**" in the **53i Installation Guide**.



- Lift the handset for handset operation.

If the phone is already connected to a call, pressing the line/call appearance button for the new incoming call automatically places the connected call on hold and answers the new call. To reconnect to a party, press the line/call appearance button for that call.

If you cannot answer the call, the caller goes to voicemail if voicemail has been configured for your extension.

**Note:** The  button can be used to cancel the call pickup procedure.

### Sending an Incoming Call to Voicemail

You can send an incoming call directly to voicemail without answering the call. To do this, press  without picking up the handset. If you're already on the phone your incoming call should go directly to voicemail. Your phone screen displays a voicemail icon (  ) along with the number of waiting messages, if you have unheard messages (example:  ×4).

**Note:**



# Handling Calls

When you are connected to a call, you can use the softkeys or hard keys on the phone to transfer, conference, or place a call on hold.

## Placing a Call on Hold

When you place a call on hold, only your phone can retrieve the call.



### IP Phone UI

#### *To place a call on hold*

1. Connect to the call (if not already connected).
2. Press the Hold  key.

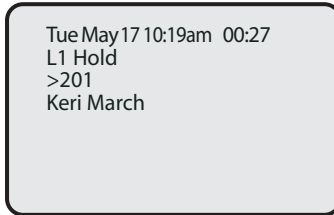

The line/call appearance light will begin to flash slowly and after a short time the phone will beep softly to remind you that you still have a call on hold. The screen displays "**Call Held**" with the line number the call is held at the phone.

**Note:** The phone will not beep to remind you that you still have a call on hold if you are connected to another call.

#### *When on Hold*

To let your caller know that they are still on hold, music plays softly (if this has been set up for your system). The call/line appearance light for the line you are on remains solid to indicate that you are still connected.

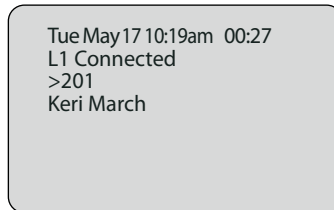

## *Automatic Hold*

When juggling between calls, you do not have to press the hold button to go from one call to the next. The phone automatically puts your current call on hold as soon as you press a new line/call appearance button. If you have more than one call on hold, you can reconnect to a held call by pressing the line/call appearance button where that call is being held. Press  to disconnect the call.

## *Retrieving a Held Call*

If you have more than 1 call on hold, you can scroll through the held call information by pressing ◀ and ▶ navigation keys. To reconnect to a call press the line/call appearance button where that call is being held. If you press the call/line appearance button again, you will disconnect from the call.

## Transferring Calls

### *Blind Transfer*

A blind transfer is when you transfer a call directly to another extension without consulting with the person receiving the call. To do this, simply complete the transfer immediately after you have entered the number. The call goes directly to the extension or outside line you transferred to. If the party you are transferring the call to does not answer, the transferred call rings back to your extension.

### *Consultative Transfer*

You also have the option to consult with the person you are transferring the call to, before you complete the transfer. To do this, simply remain on the line until the receiving party answers the call. After consulting with the receiving party, you can either complete the transfer or cancel the transfer to go back to the original call.



### IP Phone UI

When you lift the handset on the phone, the **Transfer** key displays on the bottom set of softkeys by default. Use this key to transfer calls



Use the following procedure to transfer a call to another extension. Use the following illustration as a reference.

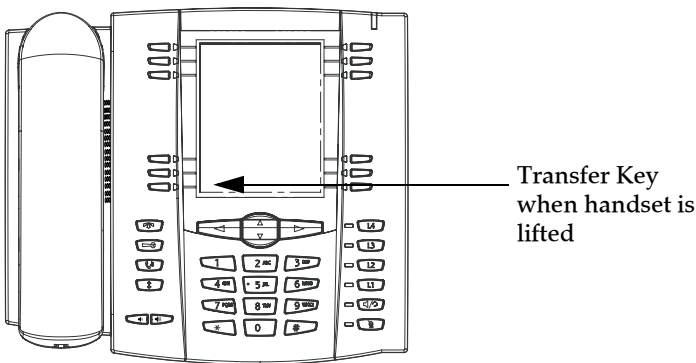

### *To transfer a call to another extension*

1. Connect to the call you wish to transfer (if not already connected).

2. Press the **Intercom** key.

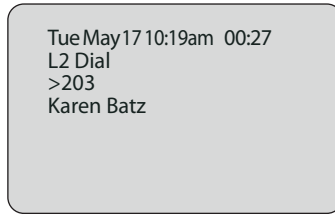

3. Press a line/call appearance button followed by the extension number of the person you wish to transfer the call to.

4. If you do not wish to transfer the call, press the line/call appearance button again to abort the transfer. This disconnects the new call, leaving the original call on hold. To go back to the original call, press the line/call appearance button for this call.

5. To complete the transfer, you can press the **Intercom** key again, or disconnect by placing the handset back on hook, pressing  or pressing the line/call appearance button for the active call.

**Note:** To complete a "blind" transfer, press the **Intercom** Key again before the phone begins dialing. To complete a consultive transfer, remain on the line to speak with the party, before pressing the **Intercom** Key again. To cancel the transfer, select **Cancel** on the display screen.

## Conferencing Calls

The 57i phone system supports up to 3 parties (including yourself) in a conference call.

**Note:** Your system administrator can set your conference key to speedial a specific number. Contact your system administrator for more information.

When you lift the handset on the phone, the **Conference** key displays on the bottom set of softkeys by default. Use this key to create conference call.





Use the following procedure to create a conference call. Use the following illustration as a reference.

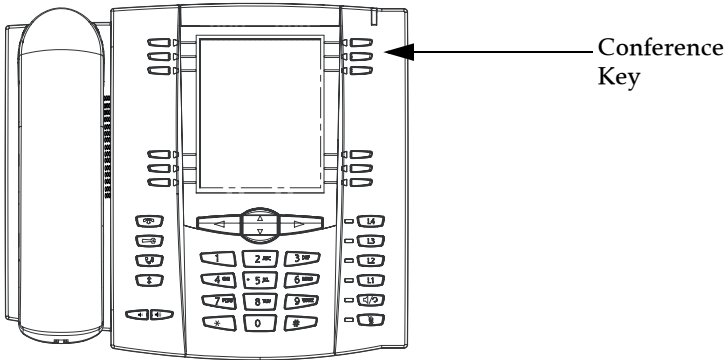

1. Connect to the first party you wish to include in the conference (if not already connected).

**Note:** A "Conference" softkey automatically appears in the display when on a call.

2. Press the **Conference** key. A new line opens.

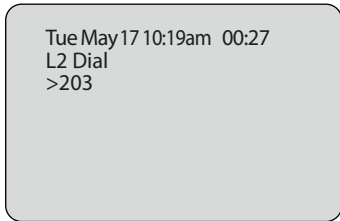

3. Press a line/call appearance button followed by the extension number of the person you wish to add to the conference.

4. Wait for the new party to answer. You can consult with the new party first before adding them to the conference.

5. If you do not wish to add the new party to the conference, press the line/call appearance button for this call. This disconnects the new party, leaving the original call on hold. To go back to the original call, press the line/call appearance button for this call.

6. To add the new party to the conference, press the **Conference** key again.

7. To drop the new party from the conference, press the **Conference** key one more time.

**Note:** You can use ▾ ▴ to scroll through and see the numbers and names (if available) of the parties in the conference call.

8.If you wish to exit the conference leaving the other two parties connected, disconnect by placing the handset back on-hook or by pressing  .

*To conference two calls you are already connected to*

---



## IP Phone UI

---

1. Begin with active calls on two different lines.
2. Press the **Conference** key. A new line will open.
3. Press the line key of the call you wish to conference with.
4. Press the **Conference** key again. The two lines link into a conference call.

**Note:** When a name is displayed, pressing ▷ drops the displayed party from the call.

**Note:** When a name is displayed, pressing ▷ drops the displayed party from the call.

## Picking up Calls

Press the line/call appearance button for an incoming call. If the phone is connected to a call, pressing one of the line/call appearance buttons will automatically place this call on hold before opening up a new line for the new call.





IP Phone UI

---

### *To pickup a call*

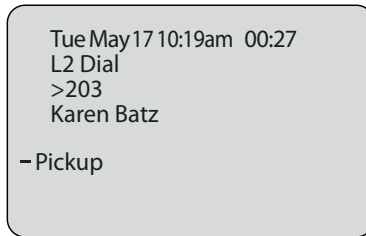
1. Press the line/call appearance button for that call.



2. Press  if you do not wish to pickup a call. This cancels the call pickup procedure.

## Ending Calls



IP Phone UI

---

To end a call, you first need to connect to the call if not already connected. To end a call, you first need to reconnect to the call if not already connected (for example, if your caller is on hold). Press  or the line/call appearance button of the active call to end the call. If connected through the handset, you can also place the handset back on hook to end the call.





## Adding to and Editing the Directory List

You can store a maximum of 7 numbers associated with a unique name. You can apply pre-defined labels to the entry which include, Office, Home, Cell, and Pager, or create your own labels. The following table indicates the maximum characters for each line and field in the Directory List.

Directory List Limitations	
Maximum length of a line	255 characters
Maximum length of a name	16 characters
Maximum length of a label	14 characters
Maximum length of a URI	45 characters
Maximum number directory entries in the NVRAM	200 entries

The following examples illustrate the IP Phone UI screens you can use to add/edit entries in the Directory List.

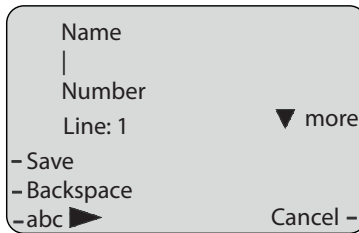

Screen 1

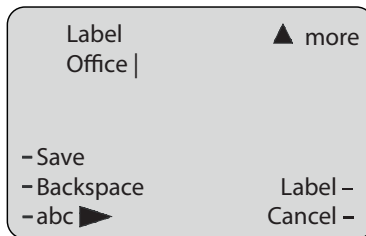

Screen 2

### Adding Names, Numbers, Labels

#### On Screen 1:

- You can add names using the **abc** softkey.
- You can add numbers (up to 7 numbers per name) using the numbers on the phone's keypad.
- Use the **Backspace** softkey when required.

- Use the **Save** softkey when you are finished adding the name and number(s).
- You can exit from Screen 1 at any time without saving by pressing the **Cancel** softkey.

**Note:** Use the ▾ △ keys to toggle between Screen 1 and Screen 2.

### On Screen 2:

- You can add a label or URI using the **abc** softkey; Or you can populate the "Label" field with a pre-defined label (Office, Home, Cell, Pager) by pressing the **Label** softkey.
- Use the **Backspace** softkey when required.
- Use the **Save** softkey when you are finished adding the Label.
- You can exit from Screen 2 at any time without saving by pressing the **Cancel** softkey.

### *Editing Names, Numbers, and Labels*

On Screen 1, when the cursor is in the "Line" field, softkey 5 displays a **Change** softkey. The following example illustrates a Directory entry for "Steve Smith", with a phone number and an "Office" label. Since the cursor is in the "Line" field, the **Change** softkey displays.

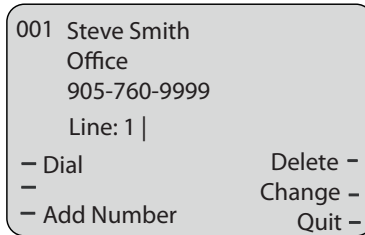

The following example shows the same Directory entry without a label.

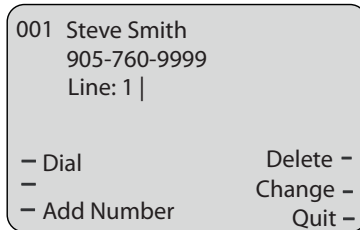

- You can use the **Dial** softkey to automatically dial the number in the Directory entry.
- You can use the **Add Number** softkey to add additional numbers to the current Directory entry (up to 7 numbers per name).

- You can use the **Delete** softkey to delete a number or to delete multiple numbers in an entry (see "[Deleting Single and Multiple Numbers in an Entry](#)" on [page 85](#)).
- You can use the **Change** softkey to change a number or a name.
- You can use the **Quit** softkey to quit the editing of the current Directory entry.

### *Scrolling Multiple Screens Per Entry*

If there are multiple numbers for an entry, the ◀ and ▶ keys display for you to scroll multiple screens. The following examples show **Screen 1** as Steve Smith's Office number, **Screen 2** as Steve Smith's Home number, and **Screen 3** as Steve Smith's Cell number. The first scroll ▶ indicates there are multiple number entries for the name. The ◀ ▶ indicates you can scroll forward or backward between screens. The ◀ indicates this is the last number entry for the name.

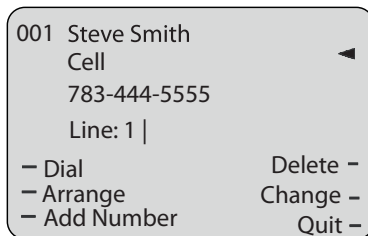
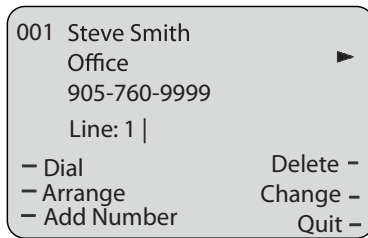

## Arranging Multiple Screens

You can use the **Arrange** softkey to move the number/label/line forward or backward between screens for the specified name. If there is a label assigned to the entry, the following screen displays after pressing the **Arrange** softkey.

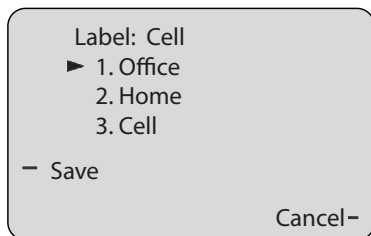

- Pressing the **Save** softkey in the above screen places the Cell label, the Cell number, and line associated with the Cell number, into the one position. So the first screen to display for the entry would be the Cell number screen. If no label is assigned to the entry, the numbers would be arranged in the order you specify.

The following example illustrates the new arrangement of Steve Smith's numbers.

**Note:** The Office label moves to the second position and the Home label moves to the last position.

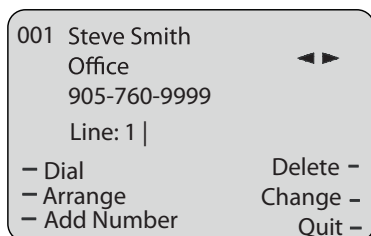
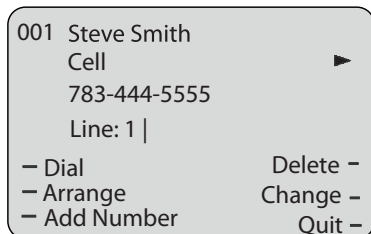



### *Deleting Single and Multiple Numbers in an Entry*

You use the Delete softkey to delete a single number or multiple numbers for an entry. For a single number assigned to a name, pressing the **Delete** softkey displays the following screen.

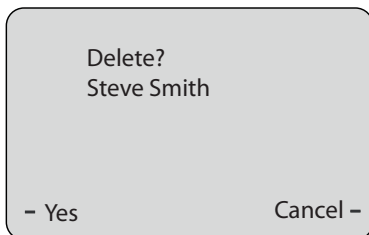

- You can press **Yes** to delete the directory entry (name, number, label, and line) from the Directory List.
- You can press **Cancel** to cancel the delete function.

For multiple numbers assigned to a name, pressing the **Delete** softkey displays the following screen.

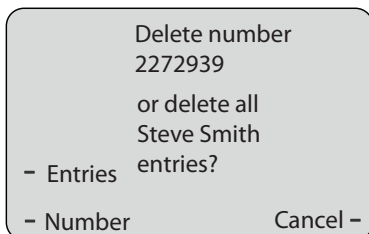

- You can press **Entries** to delete the directory entry (name, all numbers, labels, and lines associated with the name) from the Directory List.
- You can press **Number** to delete only a specific number associated with a name.
- You can press **Cancel** to cancel the delete function.

## Downloading the Directory List to Your PC

You can download the Directory List to your PC via the Aastra Web UI. The phone stores the **directorylist.csv** file to your PC in comma-separated value (CSV) format.

You can use any spreadsheet application to open the file for viewing. The following is an example of a Directory List in a spreadsheet application.

	A	B	C	D	E	F
1	John	41373	2			
2	Tim	41376	1			
3	Carol	4443245	1			
4	Tom	41356	3			
5						
6						
7						
8						
9						
10						
11						
12						

The file displays the name, phone number, and line number for each Directory entry.

### Server to IP Phone Download

Your system administrator can populate your IP phone Directory List with server directory files. Contact your system administrator for more details.

### Accessing the Directory List

Use the following procedures to access the Directory List.



#### IP Phone UI

1. Press the **Services** key on the phone to display the **Services** menu, and select "**Directory List**".  
or  
Press the **Directory** softkey (default key is key 2 on the Top Keys).
2. Use the  $\nabla$   $\triangle$  keys to scroll through the line items in the Directory List.
3. To dial a displayed entry from the Directory List, pick up the handset, press the  handsfree key, or press the **Dial** softkey.
4. To exit the Directory List, press the **Quit** softkey.

## Callers List





The Callers list is a stored log of your incoming calls. The 57i telephone stores information on up to 200 incoming calls in the Callers list. Your telephone logs the number and name (if available) of the caller, when they last called, and the number of times they tried to reach you.

When the Callers list is full, the oldest call records are deleted to accommodate the information of new callers.

If the telephone number of an incoming or outgoing call matches a number that you have programmed with a name in a programmable key or the Directory, the Callers list will display the name and number.

The display shows you how many callers have been added to the list since you last checked it.

### *Caller's List Screen Display*

Display Item	Description
450-349-0438	Indicates you have returned the call from the Callers list.
N MAR 04 3:30pm 2x	"N" indicates a new call.
XX New Callers	When you're not on the telephone and not in the Callers list, the display shows you how many callers have been added to the list since you last checked it.
	Indicates an unanswered call in the Callers list.
	Indicates an answered call in the Callers list.
	Indicates a Call Waiting call in the Callers list.
	Indicates an incoming Call Waiting call.
John Burns 9054550055 Jun 8 2:41pm 2X	"2x" indicates this caller has called twice. The display shows the date and time of the last call from that caller.

You can view, scroll, and delete line items in the Callers List from the IP phone UI. You can also directly dial from a displayed line item in the Callers List.

You can also download the Callers List to your PC for viewing using the Aastra Web UI. When you download the Callers List, the phone stores the **callerlist.csv** file to your computer in comma-separated value (CSV) format.

You can use any spreadsheet application to open the file for viewing. The following is an example of a Callers List in a spreadsheet application. This file displays the name, phone number, and the line that the call came in on.

	A	B	C	D	E	F
1	John	41373		2		
2	Tim	41376		1		
3	Carol	4443245		1		
4	Tom	41356		3		
5						
6						
7						
8						
9						
10						
11						
12						

## Using the Callers List



### IP Phone UI

Use the following procedure to access the Callers List. Use the following illustration as a reference.

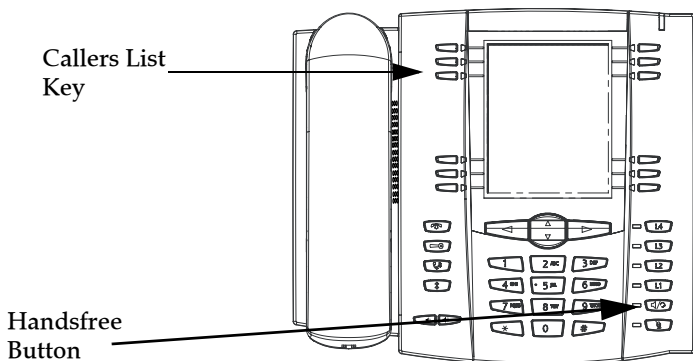

1. Press the **Callers List** key.  
or  
Press the **Services** key if your system administrator has configured the Services key to access the Callers List.
  2. Use the  $\nabla$   $\triangle$  keys to scroll through the line items in the Callers List.
- Note:** To the left of a line item, a icon displays with the handset ON or OFF the receiver. The ON receiver indicates the call came in as a missed call. The OFF receiver indicates the call came in and was answered.
3. To delete all entries in the Callers list, press the **Delete** softkey at the "Callers List" header.

To delete a line item from the Callers List, select the line item you want to delete and press the **Delete** softkey.



4. To cancel a delete function, press the  $\nabla$  or the  $\triangle$  **Scroll** keys.
5. To save a line item to a softkey for speeddialing, press the **Save** softkey and enter the line number at the "Save to?" prompt that is already configured for speeddialing at a softkey.
6. To dial a displayed entry from the Callers List, pick up the handset, press the  handsfree button, or press a line key.
7. To exit the Callers List, press the **Callers List** key.

### *Editing in the Callers List*

**Important:** The Caller List does not save changes. Editing in the Callers List is generally used if you plan to call the number and need to add a prefix.

In the Callers List, if a dial pad key is pressed when a number and/or a name is displayed, the cursor will automatically add the digit at the left side of the number to enable the entry of the prefix.

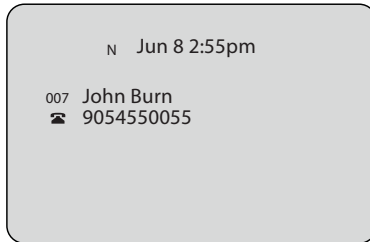

### IP Phone UI

Use the following procedure to edit the Callers List. Use the following illustration as a reference.

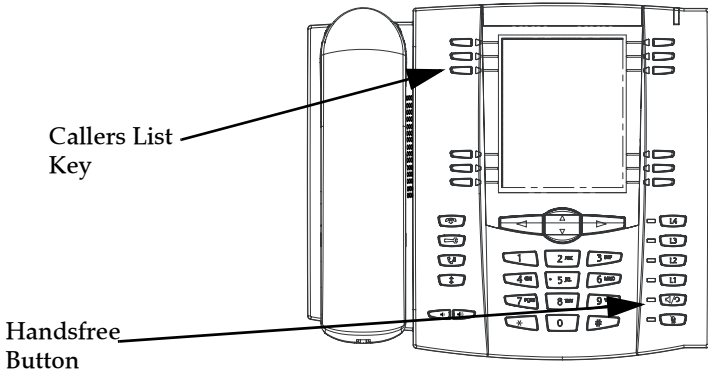

1. Press the **Callers List** Key.
2. Press  $\nabla$   $\triangle$  to find the entry you want to edit. Press  $\nabla$  to view the most recent call, or  $\triangle$  to see the oldest call on your list.

3. Press any key on the dial pad to begin editing.
4. To move the cursor one digit to the right, press  $\triangleright$  . To erase one digit to the left of the cursor, press  $\triangleleft$  .
5. To dial the displayed number press , or just lift the handset, or press any line keys.

### *Deleting from the Callers List*

You can delete individual items from the Callers List, or you can delete all items in the Callers List..



#### IP Phone UI

Use the following procedure to delete an individual item from the Callers List. Use the following illustration as a reference.

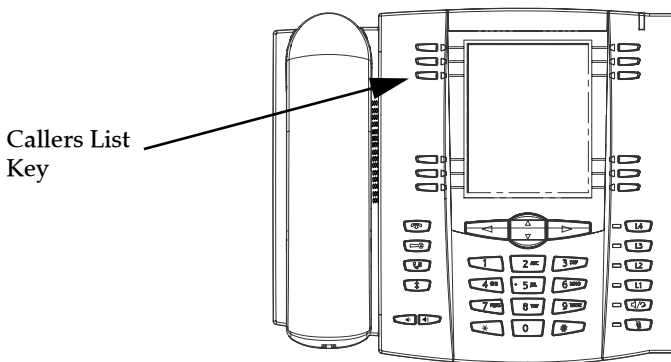

1. Press the **Callers List** Key.
2. Use  $\nabla$   $\triangle$  keys to find the item you want to delete.
3. Press the **Delete** softkey.
4. Press the **Delete** softkey again at the prompt to erase the item.



#### IP Phone UI

Use the following procedure to delete all items from the Callers List.

1. Press the **Callers List** Key.
2. Press the **Delete** softkey.
3. Press the **Delete** softkey again at the prompt to erase all items.

## Downloading the Callers List

Use the following procedure to download the Callers List to your PC using the Aastra Web UI.



Aastra Web UI

### 1. Click on **Operation->Directory**.

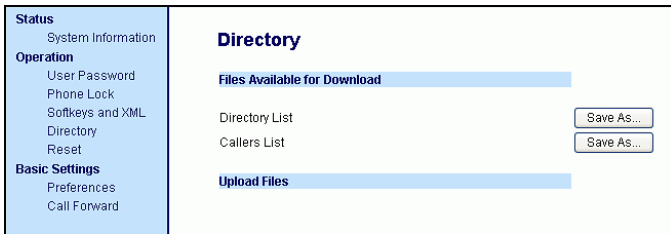

### 2. In the Callers List field, click on **Save As...**.

A File Download message displays.

### 3. Click **OK**.

### 4. Enter the location on your computer where you want to download the Callers List and click **SAVE**.

The *callerslist.csv* file downloads to your computer.

### 5. Use a spreadsheet application to open and view the Callers List.

## Call Forwarding

The call forwarding feature on the IP phone allows incoming calls to be forwarded to another destination. The phone sends the SIP message to the SIP proxy, which then forwards the call to the assigned destination.

Call forwarding is disabled by default. You can enable call forwarding on a global basis or on an individual line-basis, for each line. If you have configured call forwarding on an individual line, then the settings for this line are used; otherwise, the phone-wide call forward settings are used.

You can enable call forwarding on all phones (global settings) or on specific lines (local settings) of a single phone. For local settings, you can set call forwarding on up to 9 individual lines.

For global and local call forwarding, you can set the following:

- **Call forward mode**
- **Destination number**
- **Number of rings before forwarding the call** (from 1 to 9 rings)

The following are the call forward modes you can set:

Call ForwardMode	Description
Off (Aastra Web UI only)	Disables call forward
All	Phone forwards all incoming calls immediately to the specified destination.
Busy	Phone forwards incoming calls if the line is already in use.
No Answer	Phone forwards the call if it is not answered in the specified number of rings
Busy No Answer	Phone forwards the call if either the line is already in use or the call is not answered in the specified number of rings.

**Note:** You can set the global call forward settings using the IP phone UI or the Aastra Web UI. However, you must use the Aastra Web UI to set the per-line call forward settings. The per-line settings override the settings for global call forwarding.

## Setting Call Forwarding

Use the following procedure to set global call forwarding.

### For Global Call Forward Settings



#### IP Phone UI

1. Press  on the phone to enter the Options List.
  2. Select **Call Forward** and press **Show**.
  3. Enter the "**Call Forward**" number destination for which you want your incoming calls to be forwarded.
- Note:** If you leave the "Number" field blank, call forwarding is disabled.
4. Enter the "**Call Mode**" that you want to set on your phone.
  5. Enter the "**Number of Rings**" you want to set before the call is forwarded. Valid values are 1 to 9.
- Note:** "Number of Rings" field applies to **No Answer** and **Busy No Answer** modes only.
6. Press **Enter** to save the settings.



#### Aastra Web UI

1. Click on **Basic Settings->Call Forward**.

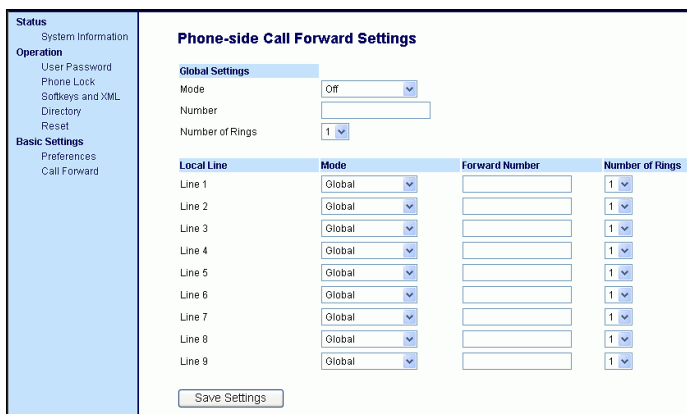

Local Line	Mode	Forward Number	Number of Rings
Line 1	Global		1
Line 2	Global		1
Line 3	Global		1
Line 4	Global		1
Line 5	Global		1
Line 6	Global		1
Line 7	Global		1
Line 8	Global		1
Line 9	Global		1

### For Global Call Forward Settings:

2. In the "**Mode**" field, select the mode you want to set on your phone.
- Note:** To disable call forwarding in the Aastra Web UI, set the mode to **OFF** and remove the phone number in the "**Number**" field.
3. In the "**Number**" field, enter the call forward number for which you want your calls to be call forwarded.

4. In the "**Number of Rings**" field, enter the number of rings you want to set before the call is forwarded. Valid values are 1 to 9.
5. Click  to save the Call Forward settings. The changes are dynamic and are immediately applied to the phone.

### ***For Per-Line Call Forward Settings:***

1. Select a line to set Call Forwarding on.
2. In the "**Mode**" field, select the mode you want to set on this line.  
**Note:** To disable call forwarding in the Aastra Web UI, set the mode to **OFF** and remove the phone number in the "**Forward Number**" field.  
**Note:** To force a line to use the global settings, set the "**Mode**" field to **Global**.
3. In the "**Forward Number**" field, enter the call forward number for which you want your calls on this line to be call forwarded.
4. In the "**Number of Rings**" field, select the number of rings on the line before the call is forwarded. Valid values are 1 to 9.
5. Click  to save the Call Forward settings. The changes are dynamic and are immediately applied to the phone.

## Missed Calls Indicator

The IP phone has a "missed calls" indicator that increments the number of missed calls to the phone. This feature is accessible from the IP phone UI only.

The number of calls that have not been answered increment on the phone's idle screen as "**<number> New Calls**". As the number of unanswered calls increment, the phone numbers associated with the calls are stored in the Callers List. The user can access the Callers List and clear the call from the list. Once the user accesses the Callers List, the "**<number> New Calls**" on the idle screen is cleared.

### *Accessing and Clearing Missed Calls.*



#### IP Phone UI

Use the following procedure to access and clear missed calls from the Callers List. Once you display the Callers List, the "**<number> New Calls**" indicator clears. Use the following illustration as a reference.

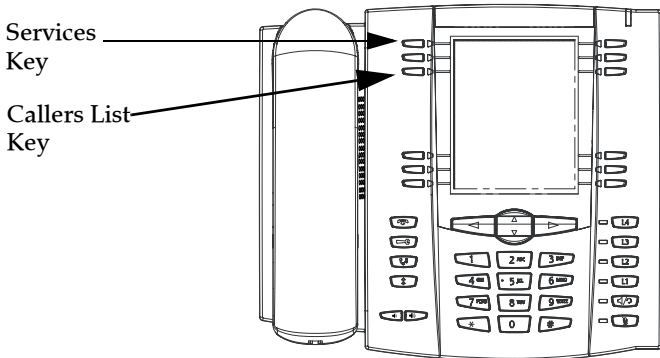

1. Press **Callers List** key on the phone.  
or  
Press the **Services** key and select **Callers List** from the menu.
2. Use the  $\nabla$   $\triangle$  keys to scroll through the line items in the Callers List to find the line items that have the  $\text{☎}$  icon with the receiver ON. These are the missed calls to the phone.
3. To clear a line item from the Callers List, select the line item you want to delete and press the **Clear** softkey.

The line item is deleted from the Callers List.

## Voicemail

The Voicemail feature on the 57i IP phone allows you to use a line, configured with a phone number for dialing out, to connect to a voicemail server.

For each assigned Voicemail number, there can be a minimum of 0 or a maximum of 1 Voicemail access phone number.

The Voicemail list displays a list of phone numbers assigned to the 57i that have registered voicemail accounts associated with them.

**Note:** The Voicemail list does not display the voicemail access number.

The phone displays up to 99 voicemails for an account even if the number of voicemails exceeds the limit.

Registered account numbers/URIs that exceed the length of the screen, either with or without the voicemail icon and the message count, are truncated with an ellipse character at the end of the number/URI string.

The end of the Voicemail list displays the number of new voicemail messages (if any exist).

Contact your system administrator for lines configured for Voicemail.

### *Using Voicemail*



#### IP Phone UI

---

1. Press the **Services** key on the phone.
2. Select "**Voicemail**".
3. Use the  $\nabla$   $\triangle$  keys to scroll through the line items in the Voicemail list.
4. When you have selected a line item, press the  handsfree key,  $\triangleright$  **Scroll Right** key, or press a line softkey to make an outgoing call using the voicemail access phone number associated with the line for which the voicemail account is registered.

From a selected item in the Voicemail list, you can also lift the handset (go offhook) to make an outgoing call using the voicemail access phone number.



## Using Your 57i CT Cordless Handset

The following sections describe the various 57i CT cordless handset key functions, and how they help you make and manage your calls and caller information.

### 57i CT Handset Key Panel

The following illustration and table identify the keys on the key panel of your 57i CT handset that you can use for handling calls.

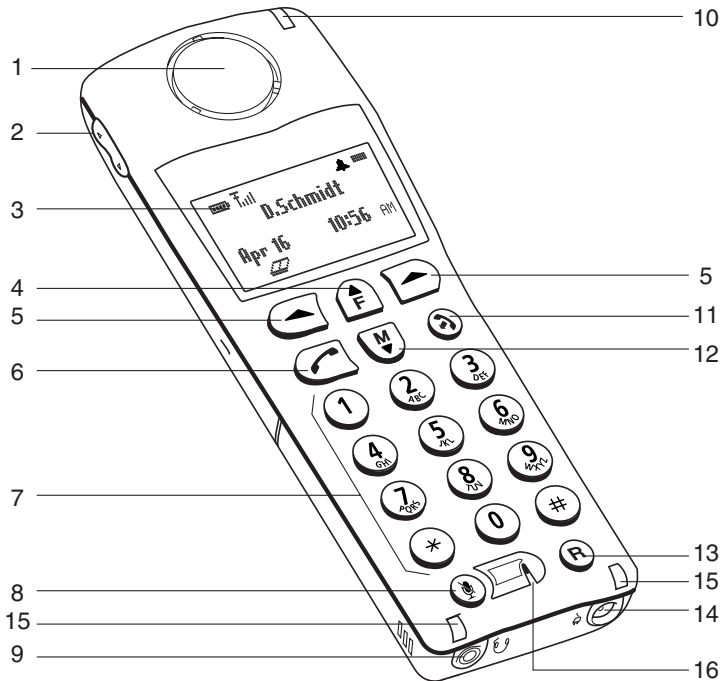

## 57i CT Handset Key Description

Function #	Function Description
1	<b>Receiver</b>
2	<b>Volume key</b> <ul style="list-style-type: none"> <li>• During Ringing: Adjusts ringer volume</li> <li>• During a call: Adjusts receiver volume</li> <li>• During text mode (not in a call): Moves cursor right/left</li> </ul>
3	<b>Display</b>
4	<b>Features f Key List</b> <ul style="list-style-type: none"> <li>• Access key to the programmed Feature Key List</li> <li>• Scrolls up when in the various lists</li> <li>• Adds a space during editing</li> </ul>
5	<b>Softkeys</b> <ul style="list-style-type: none"> <li>• Activates feature or option shown on the display above the keys</li> </ul>
6	<b>Call key</b> <ul style="list-style-type: none"> <li>• Used to obtain dial tone</li> <li>• Also used as a Hold key</li> </ul>
7	<b>Dial Pad</b>
8	<b>Mute Key</b> <ul style="list-style-type: none"> <li>• When used, prevents the caller from hearing you</li> </ul>
9	<b>Headset Jack</b>
10	<b>Status Light</b>
11	<b>Release key</b> <ul style="list-style-type: none"> <li>• To end calls and go on hook</li> <li>• Exits Menu and the various lists</li> </ul>
12	<b>Menu Key</b> <ul style="list-style-type: none"> <li>• Access key to the different Options</li> <li>• Scrolls down when in the various lists</li> <li>• Used as Backspace during editing</li> </ul>
13	<b>Redial Key</b> <ul style="list-style-type: none"> <li>• Displays the last 10 numbers dialed</li> </ul>
14	<b>Charging Jack</b>
15	<b>Charging Contacts</b>
16	<b>Microphone</b>

When in an idle state, pressing the Menu key (M) of the handset will present the following list of options. Once in the menu list the user can scroll up (F) and down (D) using the scrolling keys to see each option.

Item #	Menu list
1	Intercom
2	Language
3	Ring tone
4	Custom name
5	Timer Off
6	Vibrate Off
7	Hset pairing
8	Key lock Off
9	Backlight Off
10	Silent Alert

**Note:** The display will return to idle if no action/activity is initiated within 20 seconds.

### Accessing Options

Pressing the (M) key will access the options list menu. This action results in displaying a Menu list header with brief list navigation instructions .



Navigation of the menu is performed using the down arrow (D) key) or the up arrow (F) key). Shortcut to the menu item can also be performed by pressing the corresponding menu item number. Two digits numbered items can be short-cutted by pressing the digits within a one second time span.

Pressing the (E) key will quit the Menu and return to the idle mode or call mode.

## Intercom

The 57i CT supports intercom function between a 57i CT base and any of its paired cordless handsets, and vice versa.

Pressing **Select** while viewing this option will bring up a list of base and paired handsets available for intercom. To select a handset or base to intercom, navigate to the desired handset or the base using the **Up** key or the **Down** key. Then press the **Call** soft key. Shortcut to any handset or base in the list is permitted by pressing the corresponding numeric key digit; the order of the list is numbered from zero (0) for the base (0) and four (4) for the 4th handset in the list.

**Note:** Your system administrator can configure outgoing Intercom calls using the **Icom** button. Contact your system administrator for more information.

### Reference

For more information about the intercom feature, see "[Intercom](#)" on [page 100](#).

## Language

The prompt on 57i CT handset can be personalized to English, French, or Spanish language. A checkmark beside the language indicate the currently selected language prompt.

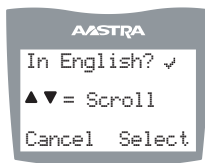

### Reference

For more information about changing language on the handset, see "[Language](#)" on [page 139](#).

## Ring Tone

There are several selectable Ring tones available on the 57i CT handset. A checkmark beside the ring tone number indicates the currently selected ring tone.

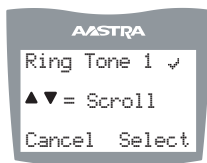

### Reference

For more information about changing ring tones on the handset, see "[Using Your 57i CT Cordless Handset](#)" on [page 97](#).

## Custom name

Custom name allows the user to personalize the name/label for the cordless handset. In a multi-handset environment, this is an ideal option to personalize each handset to its user or extension number.



### IP Phone UI

1. Press **⏏**.
2. Navigate to **Custom Name** or press **4**.
3. Press the **Change** softkey.
4. Press the **Edit** softkey. If a custom name already exists, the **Delete** softkey will be presented.
5. Using the keypad, type out a new label or use the scroll keys **⏏** and **⏏** to move the cursor to the desired display position or to erase text.
6. The **ChCase** softkey is available to toggle between upper and lower case text entry.
7. Press the **Save** softkey to save the name.
8. Press the **Goodbye** **⏏** key to return to the main idle screen.

**Note:** In editing mode, the Volume Bar can be used in place of the **⏏** and **⏏** keys to control the screen cursor. Pressing the Lower end volume bar for Backspace/Erase; and pressing the Higher end volume bar to add a Space.

## Call timer

When the call timer is enabled, the timer starts from the first call and continues until all calls have been released.

**Note:** The call timer is not usable for call accounting since the timer continues to increment even when the call is on hold.

## Vibrate

The Vibrate option allows the handset to signal an incoming call by vibrating as well as ringing. By default, this option is always Off.

- To enable this feature, press the **Change** softkey and the display will indicate "Vibrate On" and "-confirmed-" and will quickly return to the previous menu display.
- Once the Vibrate is On, **⏏** icon is shown beside the ringer icon on the top right line of the display.
- Pressing the **⏏** key will return you to the main idle display screen.

## Handset Pairing

All handsets must be paired to a 57i CT base before it can be used. Please refer to the section entitled 115.



## Key Lock On or Off

The key lock option enables the user to lock the keypad keys. This prevents accidental activation of the phone.

To lock the keys from the key lock option page:

- Press **Change** softkey to turn Key lock ON or OFF. The screen will display **Key lock On** or **Key lock Off -confirmed-**.

Pressing the  key will return you to the main idle display screen.

**Note:** You can activate the Key Lock Off or On by pressing only the  and then the  key from the idle screen.

## Backlight

The Backlight option allows the user to turn on or off the backlit light on the LCD display.

- Press **Change** softkey to turn Backlight ON or OFF.

Once the Backlight option is chosen, the screen will display **Backlight On** or **Backlight Off -confirmed-**.



## Silent Alert

The Silent Alert option will activate an internal hardware vibrator instead of a regular ringer during an incoming call. By default, the Silent Alert is automatically set to Off.

To activate Silent Alert from the option display:

- Press **Change** softkey to turn alert On or Off. The display will show **-confirmed-**.
- Once the Alert is On,  icon is shown on the top line of the display.

### Notes:

1. You can activate or deactivate the Silent alert by pressing only the  key and then the  key.
2. The Ringer Icon does not appear on the display when the Silent alert is On.







## Finding the Phones's IP Address using the Handset

You can find the IP address of the IP phone's Base Unit using the handset. Use the following procedure to find the IP address.



### IP Phone UI

---

1. Press the  key to enter the Options List when the phone is not in use.
2. Use the scroll keys  and  to scroll to the "Network" option.
3. Press  to select the "Network" option.
4. Use the scroll keys  and  to scroll through the network status until the IP address of the phone appears in the display.
5. Press  when done.



## Feature Keys on the Handset

You can program up to 15 feature keys on the 57i CT handset with specific functions using the Aastra Web UI. The following table identifies the functions available for all 15 handset keys and the default functions for each key.

Key Function	Description	Default for:
Line 1	Line 1 key - Selects line one	Handset Key 1
Line 2	Line 2 key - Selects line two	Handset Key 2
Line 3	Line 3 key - Selects line three	Handset Key 3
Line 4	Line 4 key - Selects line four	Handset Key 4
Icom	Intercom key – Enter handset list to select handset to call	Handset Key 5
Dir	Directory key – Activate directory feature	Handset Key 6
Callers	Callers key – Activate callers feature	Handset Key 7
Xfer	Transfer key - Activate transfer feature	Handset Key 8
Conf	Conference key - Activate conference feature	Handset Key 9
Public	Public key – Toggle between public & private call mode	Handset Key 10
None	No function is selected – this key is empty, no label.	Handset Key 11 and 12
Line 5	Line 5 key (if available) - Selects line five.	Handset Key 13
Line 6	Line 6 key (if available) - Selects line six.	Handset Key 14
Line 7	Line 7 key (if available) - Selects line seven.	Handset Key 15
Line 8	Line 8 key (if available) - Selects line eight	
Line 9	Line 9 key (if available) - Selects line nine	

### Feature Key Programming Guidelines

The following are guidelines to use when programming the feature keys on the handset:

- All handsets paired with the same Base Station have the same programmed functions since the web interface applies the functions to all the handsets paired with that base.
- A newly registered handset or handset that was out-of-range during the programming needs to perform an "off-hook and on-hook" sequence in order for the newly programmed function to be broadcasted to the affected handsets. Simply press the  key from the idle state to go off-hook. Then, press the  key to go back on-hook.
- Duplicate functions can exist in the feature key as there is no filtering or duplicate checking done on the handset or the base.
- If no line keys are programmed for the feature key, the handset is restricted to intercom calls only.

- If all 12 programmable functions have been programmed to "None", the user is presented with a List empty message when the feature key is pressed.



- For security reasons, the user has 180 seconds (3 minutes) to complete the programming. Otherwise, the phone displays the following error: **\*\* Error \*\*: Session expired, Please reload Page.**
- For security reasons, the user must submit the page from the same browser that was used to load the page. If the user tries to submit the page from any other IP address, the following error displays: **\*\* Error \*\*: Session invalid. Different Client IP Addresses. — Please reload Page**

### Programming Feature Keys

You can program up to 15 feature keys on the 57i CT IP phone using the Aastra Web UI. Use the following procedure to program the feature keys on your 57i CT Base Station and all paired handsets.



#### Aastra Web UI

1. Open your web browser and enter the phone's IP address or host name into the address field.
  2. At the prompt, enter your username and password and click .
- Note:** For a user, the default user name is "user" and the password field is left blank
3. Click on **Operation->Handset Keys..**

Key	Type	Label
1	Line 1	Line1
2	Line 2	Line2
3	Line 3	Line3
4	Line 4	Line4
5	Icom	Intercom
6	Dir	Directory
7	Callers	Callers
8	Xfer	Transfer
9	Conf	Conference
10	Public	Public
11	None	
12	None	
13	None	
14	None	
15	None	

4. Select the handset key you want to program.



5. Select the function for that handset key from the "**Key Function**" field.
6. Click  to save the function you selected to the handset key.  
The key programming information is sent to the 480i Base Station and to all the cordless handsets associated with that Base Station. Any key programmed to "None" does not appear in the handset's list.

## Idle Mode

During idle mode (i.e. no incoming call, no active call, or no call on hold), the handset name, date & time, status messages, and status icons are present on the display.



**Note:** The phone name label (Angela in the diagram above) can be edited in the Options list.

## Handset Icons and Status Messages

### Screen Icons

	<b>Battery Charge State</b> 4 bars for battery full and the battery icon flashes when charging
	<b>Reception (Radio Link)</b> On - Within Range: Ready for use OFF - Out of range/no radio link
	<b>Feature Key Activation</b> Indicates the phone is off hook or a call is in progress
	<b>Silent Alerter</b> Silent alerter activated
	<b>Ringer Volume</b> This icon is available only when the phone is in idle mode to indicate the ringer volume level. The box will go from empty to fully black to represent from off to low to high volume.
	<b>Receiver Volume</b> This icon is available only when the phone goes off-hook to indicate the receiver audio volume. The box will go from empty to fully black to represent from low to high volume; there are 10 volume levels total.
	<b>Directory List</b> This icon located just above the softkey allows access to the Directory List feature.
	<b>Callers List</b> This icon located just above the softkey allows access to the Callers List feature.

*Status Messages*

Display Message	Description
Microphone mute	Indicates when the Mute button has been Activated
Out of range	Appears briefly when pressing a key if out of range of the base station

**Handset Keys***Softkeys* (  or  )

Your 57i CT cordless handset has 2 softkeys directly under the LCD display. The softkey menus will change depending on the phone's state, displaying relevant softkeys only. These softkeys are pre-programmed for the call handling and extension management features.

*Talk/Hold*  *Key*

The Talk/Hold key  is a multi-purpose key with the following uses:

- To initiate a call by seizing the line or through pre-dial.
- To answer a call during ringing.
- To place a call on hold during an active call.

*Hold*  *Key*

Pressing the hold key  while on a call will place the call on hold. While a call is on hold, and if there are no other active calls, the LED will flash at the hold rate and the display will present the **Call is on hold** prompt. In addition, held call reminder tone will be played in the form of a short ring burst (flash ring).

This handset is equipped with an auto-hold feature. While on an active call, pressing any other line key will result in the current line being placed on hold and the new line being seized.

*Release Key* (  )

The release key is a multi-purpose key with the following uses:



- To end a call.

**Note:** If handset is placed in the charger cradle, it will also end the call.



- To silent the ringing during an incoming call.
- To exit feature such as Menu (options), Directory, Callers, Redial, Pre-dial.

**Note:** Pressing this key in a feature will not terminate an active call.

*Mute Key* (  )

Use the mute key when you want to be able to hear a caller but have them not hear you. Press the  key to mute the handset. Press the  key again to disengage mute. The **MicroPHONE MUTE** prompt is displayed when mute is activated.

*Redial Key* (  )

The Redial key displays a list of the last 10 calls made from the handset. Use the  and  to scroll through the list.

### *Feature Key List* ( )

The 57i CT cordless handset supports a programmable feature key list for easy access to common features. The available features include line keys, intercom, directory, callers log, transfer, conference, and public/private call mode. For more information about the feature keys, see "[Feature Keys on the Handset](#)" on [page 103](#).

### *Menu List* ( )

The Menu list allows access to intercom calling, and personalization of handset including language, ring tone, vibrate, backlight and silent alert. Please refer to the section "[Using Your 57i CT Cordless Handset](#)" on [page 97](#).

### **Multifunction Handset LED Indicator**

The multifunction Handset LED provides the following user feedback:

- Flash: Message Waiting Indicator – Slow
- Flash: Alerting – Rapid
- Flash: Mute – intermittent
- Flash: Hold – Intermediate
- Solid: On an active call

### **Battery Charging**

The handset is powered by a nickel metal hydride battery pack. To install and charge the battery:



1. Slide the cover of the battery compartment.
2. Place the battery pack in the compartment with the connector wires pointing towards the bottom of the handset.
3. Connect the battery terminal wire to the charging pins located in the compartment
4. Slide the cover of the battery compartment back onto the handset
5. Place the handset, face up, in the charging cradle. The handset should easily slide into the charging cradle. If it does not, check the battery compartment cover to ensure it is in the proper position.

To confirm that the battery is charging, check the battery icon symbol on the handset display to see if the lines inside the icon are flashing left to right.

**Note:** The battery must be charged for a minimum of six hours prior to initial usage of the phone.

## Handset Battery Indicator & Status

The display provides "at a glance" information on the handset battery.

	The bars indicate the battery charge level — 4 for full, needs recharging when only 1 bar appear
	The bars will flash when the battery is being recharged on the charger stand.

**Note:** The handset is designed to recharge the batteries automatically, when required and placed on the charger stand. The battery icon will not flash and the handset does not charge every time it is placed on the stand. If a defective battery is replaced, then the battery Icon is not identified until the new battery is charged for at least 2 minutes.

## Volume Control

The volume key, located on the side of the handset, controls both the receiver and ringer volume.

**Note:** The volume key can also be used to adjust the right/left cursor to add spaces or to erase characters on the display when editing or creating names, key labels etc.

### To adjust the receiver volume:

- While on a call, press the top of the key to increase the receiver volume and press the bottom of the key to decrease the volume. The receiver volume icon on display will indicate the current volume level. In absence of a PBX, the receiver volume returns to the default setting after each call. However, the PBX directive can direct the handset default to the volume.

### To adjust the ringer volume:



- When the handset is not being used for a call, press the top of the key to increase the ringer volume and press the bottom of the key to decrease the ringer volume. The handset ringer will sound on each adjustment to reflect the new setting and the ringer volume icon on display will also show the current level chosen.

## Directory – 57i CT Cordless Handset

### Entering Characters and Numbers

#### Editing keys

During alphanumeric entry, the volume control keys become edit keys. They are used to provide backspace and forward-space capability to the unit. For Backspace/Erase, press the Lower end of the volume bar. To add a space or to erase from left to right, press the higher end of the volume bar.

**Note:** The Down scroll key (marked ) or the Up scroll key (marked ) are also used to provide backspace and forward space respectively.

#### General Record Editing

To accommodate adding and editing, use the available characters as labelled on the keypad. Pause key and special characters are also available:

### 0 key / Pause key

To allow the user to enter pause characters, the pause key is the 0 digit key in alphanumeric editing mode. Characters will appear in the following order: : 0, [ ] .

### 1 key

In the alphanumeric mode, the 1 digit key will access several special characters. Characters will appear in the following order:

1	@	.	:	;	=	_	,	-	`	&	(	)
---	---	---	---	---	---	---	---	---	---	---	---	---

As can be seen, these special characters accessible through the 1 key allow URI and IP address data entry.

**Note:** To enter the dot/period in the IP address format, the star (\*) key is used when in numeric "123" editing mode. Alternatively, in text "abc" or "ABC" editing mode, use the 1 key to access the ".".

### "123" —p"abc"p—"ABC" softkey

You can use the left soft key to toggle from numeric "123" editing mode to lower case text "abc" editing mode, to upper case text "ABC" editing mode.

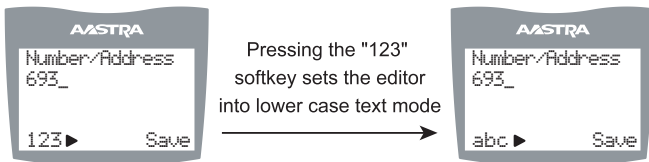

### Switch from Numeric to Lower Case Alphanumeric Mode

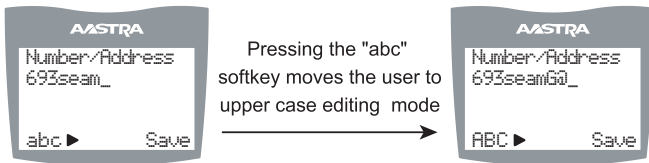

### Continued Editing in Lower Case Text mode Then Switch to Upper Case Text Mode

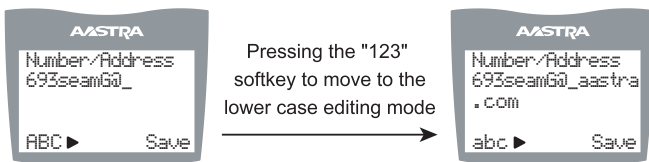

### Cycle Edit Mode Back to Lower Case and Finish Address Entry

### Adding Record to Directory

The directory can store up to 50 names and numbers, which are displayed in alphabetical order. If no name is entered, the entries are sorted by number, at the beginning of the directory.

To add an item to the directory,

1. Press the  soft key from the idle mode as shown below.



2. Press the Add soft key.



3. Enter the Number/Address information. Please refer to 108.
4. Press Save to advance to the name entry screen.

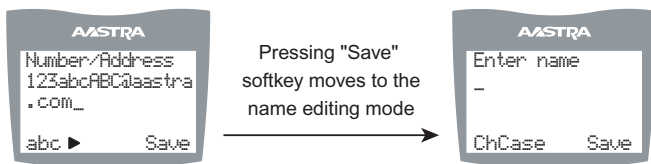

5. Enter a name for the Number/Address information. The name can have up to 15 characters, including spaces. Please refer to 108.
6. Press the Save softkey. The display will show Item saved.

## Callers List – 57i CT Cordless Handset

The Callers list stores the last 50 calls received. Items are stored in chronological order with new items being first in the list. Each call received is stored, no collapsing of records, and can be deleted or saved to a directory. Oldest call records are automatically removed from the list when the list is full and new items are received.

The following figure shows the header screen. On this screen, there is the title, the number of total items, the number of new items, instructions for viewing the items and two soft keys — **Exit** and **Delete**. The exit key quits the list and the delete key deletes the entire Callers list.



If there are no new items, then the **x New** line is not displayed. Once items are viewed, they are marked as old and do not show up in the new item count or in the new item scroll list.

Once in the list, items are displayed as shown in the next figure.

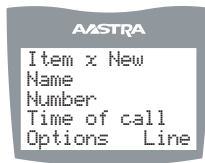

The above screen shows the item number, the name and number of the caller, and the time the call was received. Also shown are two soft keys — **Options** and **Line**.

**Options** allow the user to save to directory or delete the record.

### *Dialing from Callers List*

To dial the caller back, the **Line** soft key can be pressed and the user is taken to the feature list where the configured lines can be chosen to place the call. The user simply scrolls to the desired line and presses **Select**. The call will then be placed on that line over the cordless link.

### *Saving Item to Directory*

From the **Options** softkey of the Callers List, scroll to the **Save to Directory** item and press the **Select** softkey. will be displayed upon successful saving to the directory.



## *Deleting Item from Callers List*

From the Options softkey of the Callers List, scroll to the Delete item and press the Select softkey.





The user is prompted to confirm the delete action by pressing the Delete softkey.





## Making Calls from 57i CT Cordless Handset

### Pre-dialling a Number

Press the  key to obtain dial tone and use the Keypad to dial the number. You can also make a call by pre-dialling a number. Pre-dialling lets you view a number before you dial. If the number is correct, press the  key to dial the number. If the number is incorrect, use the  key or press down on the volume key to erase digits from right to left. Calls can also be made directly from the Directory.

### Using a Headset

The 57i CT cordless handset accepts headsets through the 2.5 mm audio jack on the bottom of the phone. Contact your telephone equipment retailer or distributor to purchase a compatible headset. Customers should read and observe all safety recommendations contained in headset operating guides when using any headset.

### Receiving Calls

When a call is ringing at your extension, you will see the Inbound Call screen. Press the  key to answer an incoming call or lift the handset out of the charging cradle.

### Call Privacy

In the 57i CT multi-handset system, it is possible to connect several cordless handsets together with each other or with the base as extensions to a call. This is just like an analog system with extension phones going off hook to join a call in progress. However, because this system is actually intended for use in an enterprise environment, some method of call privacy is required.

**All calls, base or handset, will begin in the "private" mode.** In this mode, no extensions will be allowed to join that handset or base call. There will be a user interface provided to toggle between the "private" and "public" modes.

#### *"Public" Feature Key*

A feature key will be available in the feature list for the user to press to toggle between the "private" and "public" modes for a call. Pressing the **Public** feature key in the feature list anytime during a call will put the call into the public call mode. When the call is in public call mode, the triangle indicator will light in front of the **Public** label in the feature list. This will also cause that feature key to appear on an available soft key but with a different label – **Private**. The user can then press the **Private** soft key to toggle the call back to private or he can navigate into the feature list and press the **Public** feature key.

Either way, the triangle indicator will clear and the call will be back in private mode. The figures of this section demonstrate the UI.



Private Call in Progress



Feature List View with the Public Key Selected but not Invoked



Public Call in Progress



Feature List View with the Public Key Invoked but not Selected

In the figure above, the left screen depicts a call that is public. The user can press the **Private** soft key at any time to make the call private – i.e. no extensions allowed to join. In the right screen, the right pointing triangle indicates the current call is in public mode. The user could also select this feature key to return the call to private.

**Note:** Any local caller on the call can convert the call. For instance, if one cordless caller is on an external call, he can press the "Public" feature key to make the call public. At that point up to three other handsets can join in on the call. If any of those joining handsets presses the "Private" soft key, then the call is made private and no other users can join the call unless the call was made public again.

## Ending Calls

To end a call, you first need to connect to the call, if not already connected, and press the  key. You can also place the handset back on the charging cradle to end the call.

## Pairing and Unpairing Cordless Handset to Base

### Pairing Handset

All handsets must be paired to a Base Station. This is performed from both the base and the cordless handset. Successful pairing will add the handset name to the handset list on the base and synchronize the handset list from the base to the newly paired handset. A total of 4 handsets can be paired to a single 57i CT base.

**Note:** When performing the handset pairing, it is recommended that the handset be within 3 feet of the 57i CT base.

1. On the 57i CT base unit press .
2. Select Handset Pairing

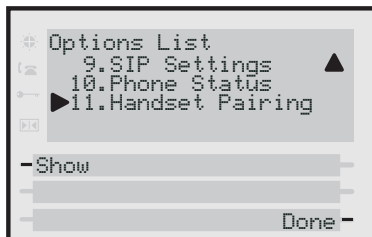

3. Select Pair

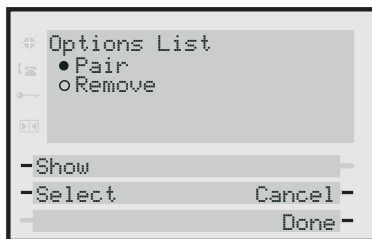

**Note:** If there are already 4 handsets paired to the base, you will not be able to select the Pair option.

4. On the 57i CT cordless handset press .
5. Select Hset Pairing

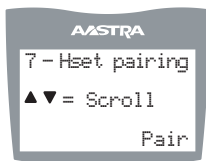

**Note:** If the handset has already been paired, the softkey will be labelled as Remove instead of Pair.

Ensure the handset being paired is within close proximity to the base. It is recommended that the handset be within 3 feet from the 57i CT base.

**Note:** It is recommended that both steps 6 and 7 be executed at the same time.

6. On the 57i CT base, select Done.

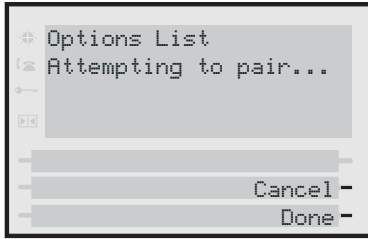

7. On the 57i CT cordless handset, press the softkey for Pair.



Upon success or failure of pairing, one of the following will be displayed on the handset and base, respectively:



Successful Pairing of Handset



Failed Pairing of Handset

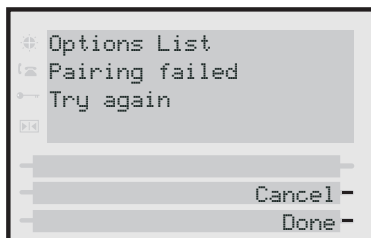

Pairing Failed Display

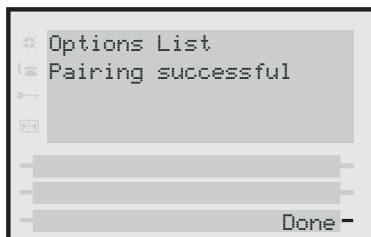

Pairing Success Display

### Unpairing Handset

Unpairing of the handset can be done from either the cordless handset or the base. However, if the handset being removed is out of range from the base, the unpairing is only performed local to the device where the removal process was initiated.

If the unpairing is only successful from the local device, the unpairing procedure will need to be completed from the other device.

1. On the 57i CT base press  .
2. Select Handset Pairing

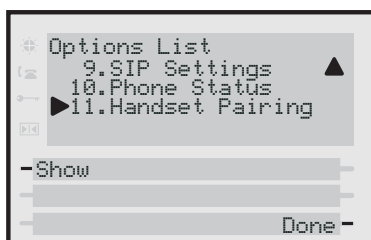

3. Select Remove.

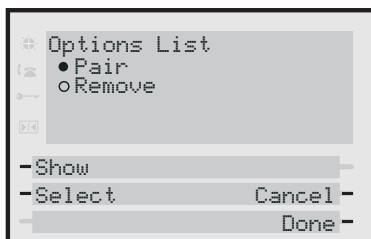

4. Select Done. The following will be displayed on the screen.

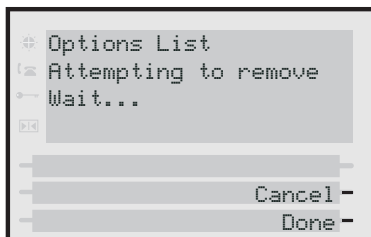

Upon success or failure of unpairing, one of the following screen will be displayed on the base:

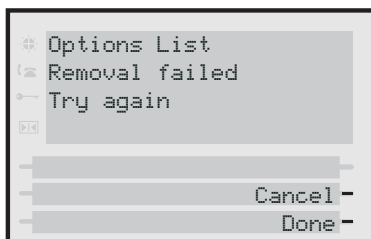

Failed Removal

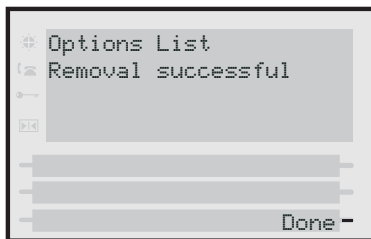

Successful Removal

5. If required, on the 57i CT cordless handset press .

## 6. Select Hset Pairing



**Note:** If the handset is not paired, the softkey will be labelled as Pair instead of Remove.

## 7. Press the softkey for Remove.



Upon success or failure of unpairing, one of the following screen will be displayed on the handset:



Successful Removal Attempts



Failed Removal Attempts

**Note:** Unpairing of the handset will return it to factory default state. All data including the functions in the Feature key will be removed.

## Additional Features

This section describes additional features you can use on the 57i phone.

### Star Codes

All of the main call handling and extension management features for your system can be set up as speed dials on softkeys on your phone. Contact your system administrator for more information.

If these have not been set up, you can dial any star code commands on the 57i phone the same way you would on a regular telephone.

### Suppressing DTMF Playback

A feature on the IP phones allows you to enable or disable the suppression of DTMF playback when a number is dialed from the softkeys.

When suppression of DTMF playback is disabled, and you press a softkey, the IP phone dials the stored number and displays each digit as dialed in the LCD window.

When the suppression of DTMF playback is enabled, the IP phone dials the stored number and displays the entire number immediately in the LCD window, allowing the call to be dialed faster.

DTMF playback suppression is disabled by default. Suppressing DTMF playback can be configured using the Aastra Web UI.

### *Configuring Suppression of DTMF Playback*



#### Aastra Web UI

Use the following procedure to configure suppression of DTMF playback.

1. Click on **Basic Settings->Preferences**.

<p><b>Status</b></p> <p>System Information</p> <p><b>Operation</b></p> <p>User Password</p> <p>Phone Lock</p> <p>Softkeys and XML</p> <p>Directory</p> <p>Reset</p> <p><b>Basic Settings</b></p> <p>Preferences</p> <p>Call Forward</p>	<p><b>Preferences</b></p> <p><b>General</b></p> <p>Park Call: <input type="text"/></p> <p>Pick Up Parked Call: <input type="text"/></p> <p>Suppress DTMF Playback <input type="checkbox"/> Enabled</p> <p>Display DTMF Digits <input type="checkbox"/> Enabled</p> <p>Play Call Waiting Tone <input checked="" type="checkbox"/> Enabled</p> <p>Stuttered Dial Tone <input checked="" type="checkbox"/> Enabled</p>
---	---

2. Go to the "**General**" section.
3. Enable the "**Suppress DTMF Playback**" field by checking the check box. (Disable this field by unchecking the box). Default is disabled.
4. Click  to save your settings. These changes are not dynamic. You must restart your IP phone for the changes to take affect.
5. Click on **Operation->Reset**.
6. In the "**Restart Phone**" field click  to restart the IP phone and apply the changes.



## Display DTMF Digits

A feature on the 57i phone allows users to enable or disable DTMF (dual-tone multi-frequency) digits to display to the IP phone when using the keypad to dial, or when dialing from a softkey or programmable key.

DTMF is the signal sent from the phone to the network that you generate when you press the phone's touch keys. This is also known as "touchtone" dialing. Each key you press on your phone generates two tones of specific frequencies. One tone is generated from a high-frequency group of tones and the other from a low frequency group.

If you enable the Display DTMF Digits parameter, the digits you are dialing from the keypad or from a programmable key display to the IP phone's LCD display. This parameter is disabled by default (no digits display when dialing).

You can enable the "Display DTMF Digits" parameter using the Aastra Web UI.

### *Configuring Display of DTMF Digits*



#### Aastra Web UI

Use the following procedure to configure the display of DTMF digits on the IP phone.

1. Click on **Basic Settings->Preferences->General**.

<b>Status</b> System Information	<b>Preferences</b>
<b>Operation</b> User Password Phone Lock Softkeys and XML Directory Reset	<b>General</b>
<b>Basic Settings</b> Preferences Call Forward	Park Call: <input type="text"/>
	Pick Up Parked Call: <input type="text"/>
	Suppress DTMF Playback <input type="checkbox"/> Enabled
	Display DTMF Digits <input type="checkbox"/> Enabled
	Play Call Waiting Tone <input checked="" type="checkbox"/> Enabled
	Stuttered Dial Tone <input checked="" type="checkbox"/> Enabled

2. Enable the "**Display DTMF Digits**" field by checking the check box. Disable this field by unchecking the box). Default is disabled.
3. Click  to save your settings. These changes are not dynamic. You must restart your IP phone for the changes to take affect.
4. Click on **Operation->Reset**.
5. In the "**Restart Phone**" field click  to restart the IP phone and apply the changes.

## Stuttered Dial Tone

You can enable or disable the playing of a stuttered dial tone when there is a message waiting on the IP phone.

You can configure this feature using the Aastra Web UI.

### *Configuring Stuttered Dial Tone*



Aastra Web UI

Use the following procedures to configure stuttered dial tone on the IP phone.

1. Click on **Basic Settings->Preferences->General**.

2. Stuttered dial tone is enabled by default. If required, disable the "**Stuttered Dial Tone**" field by unchecking the check box.
3. Click  to save your settings.
4. Click on **Operation->Reset**.
5. In the "**Restart Phone**" field click  to restart the IP phone.

## Play Call Waiting Tone

You can enable or disable the playing of a call waiting tone when a caller is on an active call and a new call comes into the phone.

You can configure this feature using the Aastra Web UI.

### *Configuring Call Waiting Tone*

---



Aastra Web UI

---

Use the following procedures to configure a call waiting tone on the IP phone.

1. Click on **Basic Settings->Preferences->General**.

<b>Status</b> System Information	<b>Preferences</b>
<b>Operation</b> User Password Phone Lock Softkeys and XML Directory Reset	<b>General</b>
<b>Basic Settings</b> Preferences Call Forward	Park Call: <input type="text"/>
	Pick Up Parked Call: <input type="text"/>
	Suppress DTMF Playback <input type="checkbox"/> Enabled
	Display DTMF Digits <input type="checkbox"/> Enabled
	Play Call Waiting Tone <input checked="" type="checkbox"/> Enabled
	Stuttered Dial Tone <input checked="" type="checkbox"/> Enabled

2. A call waiting tone is enabled by default. If required, disable the "**Play Call Waiting Tone**" field by unchecking the check box.
3. Click  to save your settings.
4. Click on **Operation->Reset**.
5. In the "**Restart Phone**" field click  to restart the IP phone.

## Incoming Intercom Calls and Auto-Answer

A feature on the 57i IP phone allows you to set intercom settings and automatic answering for incoming intercom calls.

On incoming intercom calls, you can enable (turn ON) or disable (turn OFF) the microphone on the IP phone. You can also enable or disable "Auto-Answer" and "Play Warning Tone" for incoming intercom calls.

If "Auto-Answer" is enabled, the phone automatically answers an incoming intercom call. If "Play Warning Tone" is also enabled, the phone plays a tone to alert the user before answering the intercom call. If "Auto-Answer" is disabled, the phone rejects the incoming intercom call and sends a busy signal to the caller. By default, auto-answer, the microphone, and playing a warning tone are all enabled for incoming intercom calls.

You can set incoming intercom settings and auto-answer using the Aastra Web UI only.

### Configuring Incoming Intercom and Auto-Answer



Aastra Web UI

Use the following procedures to configure incoming intercom calls and auto-answer on the IP phone.

1. Click on **Basic Settings->Preferences->Incoming Intercom Settings**.

The screenshot shows the Aastra Web UI interface. On the left is a navigation menu with sections: Status (System Information), Operation (User Password, Phone Lock, Softkeys and XML, Directory, Reset), and Basic Settings (Preferences, Call Forward). The main content area is titled 'Preferences' and has two sections: 'General' and 'Incoming Intercom Settings'. Under 'General', there are fields for 'Park Call' and 'Pick Up Parked Call', and checkboxes for 'Suppress DTMF Playback', 'Display DTMF Digits', 'Play Call Waiting Tone', and 'Stuttered Dial Tone'. Under 'Incoming Intercom Settings', there are checkboxes for 'Auto-Answer' and 'Microphone Mute', both of which are checked.

2. The "Auto-Answer" field is enabled by default. The automatic answering feature is turned on for the IP phone for answering Intercom calls. To disable this field, uncheck the box.

**Note:** If the Auto-Answer field is not checked (disabled), the phone rejects the incoming intercom call and sends a busy signal to the caller.

3. The "Microphone Mute" field is enabled by default. The microphone is muted on the IP phone for Intercom calls made by the originating caller. To disable this field, uncheck the box.
4. The "Play Warning Tone" field is enabled by default. If "Auto-Answer" is enabled, the phone plays a warning tone when it receives in incoming intercom call. To disable this field, uncheck the box.

5. Click  to save your settings.

6. Click on **Operation->Reset**.

7. In the "Restart Phone" field click  to restart the IP phone.

### Using Redial Key for "Last Number Redial"

The IP phone has an enhanced redial user interface that allows a user to quickly redial the last number that was dialed out from the phone. You can:

- Press the REDIAL button twice to redial the last number dialed.
- Press the REDIAL button once, scroll the list of numbers, then press the REDIAL button again to dial the number that displays on the screen.

The "last number redial" feature for the Redial key is static and is not configurable.

## Ring Tones and Tone Sets

You can configure ring tones and ring tone sets on the IP phone.

### *Ring Tones*

There are several distinct ring tones a user can select from to set on the IP phones. You can enable/disable these ring tones on a global or per-line basis.

The following table identifies the valid settings and default values for each type of configuration method.

**Ring Tone Settings Table**

Configuration Method	Valid Values	Default Value
IP Phone UI	<u>Global:</u> Tone 1 Tone 2 Tone 3 Tone 4	<u>Global:</u> Tone 1
Aastra Web UI	<u>Global:</u> Tone 1 Tone 2 Tone 3 Tone 4 Tone 5 Silent  <u>Per-Line:</u> Global Tone 1 Tone 2 Tone 3 Tone 4 Tone 5 Silent	<u>Global:</u> Tone 1          <u>Per-Line:</u> Global

## Ring Tone Sets

In addition to ring tones, you can configure ring tone sets on a global-basis on the IP phone. Ring tone sets consist of tones customized for a specific country. The ring tone sets you can configure on the IP phones are:

- **US** (Default - also used in Canada)
- **United Kingdom**
- **Italy**
- **Germany**
- **France**
- **Europe** (generic tones)
- **Australia**

When you configure the country's tone set, the country-specific tone is heard on the phone for the following:

- dial tone
- secondary dial tone
- ring tone
- busy tone
- congestion tones
- call waiting tone
- ring cadence pattern

You configure global ring tones and tone sets using the Aastra Web UI and the IP Phone UI.

### Configuring Ring Tones and Tone Sets

---





#### IP Phone UI

---

Use the following procedures to configure ring tones and tone sets on the IP phone.

*(global configuration only)*

1. Press  on the phone to enter the Options List.
2. Select **Tones**.
3. Select **Set Ring Tone**.
4. Select the type of ring tone (**Tone 1** through **Tone 5**, or **Silent**).
5. Select **Set** and then press  .
6. Select **Tone Set**.
7. Select the country for which you want to apply the tone set. Valid values are **Australia**, **Europe**, **France**, **Germany**, **Italy**, **UK**, and **US**. Default is **US**.
8. Press  .  
The ring tone and tone set you select is immediately applied to the IP phone.

**1. Click on Basic Settings->Preferences->Ring Tones.**

<b>Status</b> System Information	<b>Preferences</b>	
	<b>Operation</b>	
	User Password	
	Phone Lock	
	Softkeys and XML	
	Directory	
	Reset	
	<b>Basic Settings</b>	
	Preferences	
	Call Forward	
	<b>General</b>	
	Park Call:	<input type="text"/>
Pick Up Parked Call:	<input type="text"/>	
Suppress DTMF Playback	<input type="checkbox"/> Enabled	
Display DTMF Digits	<input type="checkbox"/> Enabled	
Play Call Waiting Tone	<input checked="" type="checkbox"/> Enabled	
Stuttered Dial Tone	<input checked="" type="checkbox"/> Enabled	
<b>Incoming Intercom Settings</b>		
Auto-Answer	<input checked="" type="checkbox"/> Enabled	
Microphone Mute	<input checked="" type="checkbox"/> Enabled	
Play Warning Tone	<input checked="" type="checkbox"/> Enabled	
<b>Ring Tones</b>		
Tone Set	US <input type="button" value="v"/>	
Global Ring Tone	Tone 1 <input type="button" value="v"/>	
Line 1	Global <input type="button" value="v"/>	
Line 2	Global <input type="button" value="v"/>	
Line 3	Global <input type="button" value="v"/>	
Line 4	Global <input type="button" value="v"/>	
Line 5	Global <input type="button" value="v"/>	
Line 6	Global <input type="button" value="v"/>	
Line 7	Global <input type="button" value="v"/>	
Line 8	Global <input type="button" value="v"/>	
Line 9	Global <input type="button" value="v"/>	
<b>Time and Date Setting</b>		
Time Format	12h <input type="button" value="v"/>	
Date Format	WWW MMM DD <input type="button" value="v"/>	
<b>Language Settings</b>		
Webpage Language	English <input type="button" value="v"/>	
<input type="button" value="Save Settings"/>		

**For global configuration:**

2. In the "Ring Tones" section, select a country from the "Tone Set" field.
3. Select a value from the "Global Ring Tone" field.

**Note:** See the [Ring Tone Settings Table](#) on page 126 for valid values.

**For per-line configuration:**

4. In the "Ring Tone" section, select a line for which you want to set ring tone.
5. Select a value from the "LineN" field.

**Note:** See the [Ring Tone Settings Table](#) on page 126 for valid values.



6. Click  to save your settings. These changes are not dynamic. You must restart your IP phone for the changes to take affect.
7. Click on **Operation->Reset**.
8. In the "**Restart Phone**" field click  to restart the IP phone and apply the ring tone.

## Time and Date

On the IP phones, you can configure the following:

- Time and date
- Time and date format
- Time zone
- Daylight savings time

**Note:** You can set all the above features on the IP Phone UI. However, only the Time and Date Formats can be set using the Aastra Web UI.

### *Configuring Time and Date*

Use the following procedures to configure the time and date settings on the IP phone.



#### IP Phone UI

#### *Set Time and Time Format*

1. Press  on the phone to enter the Options List.
2. Select **Time and Date**.
3. Select **Set Time**.
4. Using the keys on the keypad, enter a time to set on the IP phone.
5. Press **Done** to save the time you entered.
6. Select **Time Format**.
7. Valid values are **12hr** and **24hr**.

**Note:** The default Time Format is **12hr**.

8. Press **Change** to toggle between 24hr and 12hr format.
9. Press **Done** to save the Time Format you selected.

#### *Set Date and Date Format*

1. Select **Set Date**.
2. Using the keys on the keypad, enter a date to set on the IP phone.
3. Press **Done** to save the date you entered.
4. Select **Date Format**.
5. Select a date format from the list of options.

Valid values are:

- WWW MMM DD (default)
- DD-MMM-YY
- YYYY-MM-DD
- DD/MM/YYYY
- DD/MM/YY
- DD-MM-YY
- MM/DD/YY
- MMM DD

**Note:** The default Date Format is **WWW MMM DD** (Day of Week, Month, Day)

6. Press **Done** to save the Date Format.

### *Set Time Zone*

1. Select **Time Zone**.
2. Press \* to display a list of Time Zone options.
3. Select a Time Zone from the list of options.  
For valid time zone values, see Appendix B.

**Note:** The default Time Zone is **US-Eastern**.

4. Press Done to save the Time Zone you selected.

### *Daylight Savings Time*

1. Select **Daylight Savings**.
2. Select a Daylight Savings time from the list of options.  
Valid values are:

- OFF
- 30 min summertime
- 1 hr summertime
- automatic

**Note:** The default for Daylight Savings is **Automatic**.

3. Press Done to save the Daylight Savings value you selected.



1. Click on **Basic Settings->Preferences->Time and Date Setting.**

<b>Status</b> System Information	<b>Preferences</b>	
	<b>General</b>	
	Park Call:	<input type="text"/>
	Pick Up Parked Call:	<input type="text"/>
	Suppress DTMF Playback	<input type="checkbox"/> Enabled
	Display DTMF Digits	<input type="checkbox"/> Enabled
	Play Call Waiting Tone	<input checked="" type="checkbox"/> Enabled
	Stuttered Dial Tone	<input checked="" type="checkbox"/> Enabled
	<b>Incoming Intercom Settings</b>	
	Auto-Answer	<input checked="" type="checkbox"/> Enabled
Microphone Mute	<input checked="" type="checkbox"/> Enabled	
Play Warning Tone	<input checked="" type="checkbox"/> Enabled	
<b>Ring Tones</b>		
Tone Set	US <input type="button" value="v"/>	
Global Ring Tone	Tone 1 <input type="button" value="v"/>	
Line 1	Global <input type="button" value="v"/>	
Line 2	Global <input type="button" value="v"/>	
Line 3	Global <input type="button" value="v"/>	
Line 4	Global <input type="button" value="v"/>	
Line 5	Global <input type="button" value="v"/>	
Line 6	Global <input type="button" value="v"/>	
Line 7	Global <input type="button" value="v"/>	
Line 8	Global <input type="button" value="v"/>	
Line 9	Global <input type="button" value="v"/>	
<b>Time and Date Setting</b>		
Time Format	12h <input type="button" value="v"/>	
Date Format	WWW MMM DD <input type="button" value="v"/>	
<b>Language Settings</b>		
Webpage Language	English <input type="button" value="v"/>	
<input type="button" value="Save Settings"/>		

2. In the **“Time Format”** field, select the time format you want to use on your phone. Valid values are:  
**12h** (12 hour format) (default)  
**24h** (24 hour format)

**Note:** The time displays on the phone’s idle screen in the format you select for this field.

3. In the **“Date Format”** field, select the date format you want to use on your phone. Valid values are:
- WWW MMM DD (default)
  - DD-MMM-YY
  - YYYY-MM-DD

- DD/MM/YYYY
- DD/MM/YY
- DD-MM-YY
- MM/DD/YY
- MMM DD

**Note:** The date displays on the phone's idle screen in the format you select.

4. Click  to save your settings.
5. Click on **Operation->Reset**.
6. In the "**Restart Phone**" field click  to restart the IP phone.

## Locking and Unlocking the Phone

You can lock your phone to prevent the phone from being used or configured. You can lock the phone using the IP Phone UI or the Aastra Web UI.

In the Aastra Web UI, the **Operation->Phone Lock** path also allows you to perform the following:

- Reset a user password. Clicking on the “**Reset**” button in the “**Reset User Password**” field displays a screen that allows you to enter and save a new user password.
- Set an emergency dial plan. An emergency dial plan can be 911, 999, 112, 110 or all of the above. The default emergency dial plan is 911|999|112|110.

The following procedures describe locking the phone, setting an emergency dial plan, and resetting the user password.





### *Locking/Unlocking a Phone*

Use the following procedures to lock an IP phone and prevent it from being used or configured.





#### IP Phone UI

### *Lock the Phone*

1. Press  on the phone to enter the Options List.
2. Select **Phone Lock** and press .
3. Press  to set the phone to lock.
4. Press  on the phone.  
The following message displays:  
**"Phone is locked"**.

### *Unlock the Phone*

1. Press  on the phone to enter the Options List.
  2. Enter your user password and press .
- The phone unlocks.



1. Click on **Operation->Phone Lock**.

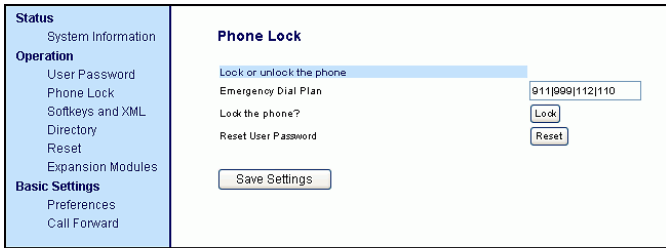

*Lock the Phone*

2. In the "**Lock the Phone?**" field, click **Lock** .

The phone locks dynamically and displays the following message:  
**"Phone is locked"**.

*Unlock the Phone*

3. Click on **Operation->Phone Lock**.

4. In the "**Unlock the Phone?**" field, click **Unlock** .

The phone unlocks dynamically and displays the following message:  
**"Phone is unlocked"**.

## Resetting a User Password

If you forget your password, you can reset it and enter a new password. The reset user password feature resets the password to the factory default which is blank (no password).

You can reset a user password using the Aastra Web UI only.

**Note:** Valid values when creating or changing a password are 0 to 4294967295 (integers only; symbols and alpha characters are not allowed). Default password is an empty string "" (field is blank).

Use the following procedure to reset a user password.



Aastra Web UI

### 1. Click on **Operation->Phone Lock**.

<b>Status</b> System Information	<b>Phone Lock</b> Lock or unlock the phone Emergency Dial Plan <input type="text" value="9119991121110"/> Lock the phone? <input type="button" value="Lock"/> Reset User Password <input type="button" value="Reset"/> <input type="button" value="Save Settings"/>
<b>Operation</b> User Password Phone Lock Softkeys and XML Directory Reset Expansion Modules	
<b>Basic Settings</b> Preferences Call Forward	

### 2. In the "**Reset User Password**" field, click . The following screen displays.

<b>Status</b> System Information	<b>Reset User Password</b> Please enter the current and new passwords: Current Password <input type="text"/> New Password <input type="text"/> Password Confirm <input type="text"/> <input type="button" value="Save Settings"/>
<b>Operation</b> User Password Phone Lock Softkeys and XML Directory Reset Expansion Modules	
<b>Basic Settings</b> Preferences Call Forward	

3. In the "**Current Password**" field, leave this blank.
4. In the "**New Password**" field, enter a new password.
5. In the "**Password Confirm**" field, re-enter your new user password.
6. Click  to save your settings.



## Defining an Emergency Dial Plan

Public telephone networks in countries around the world have a single emergency telephone number (emergency services number), that allows a caller to contact local emergency services for assistance when required. The emergency telephone number may differ from country to country. It is typically a three-digit number so that it can be easily remembered and dialed quickly. Some countries have a different emergency number for each of the different emergency services.

You can specify the digits to dial on the IP phone for contacting emergency services. Once you specify the emergency number(s) on the phone, you can dial those numbers directly on the dial pad when required and the phone automatically dials to those emergency services.

**Note:** Contact your local phone service provider for available emergency numbers in your area.

The following table describes the default emergency numbers on the IP phones.

Emergency Number	Description
911	A United States emergency number
999	A United Kingdom emergency number
112	An international emergency telephone number for <b>GSM mobile phone</b> networks. In all European Union countries it is also the emergency telephone number for both mobile and fixed-line telephones.
110	A police and/or fire emergency number in Asia, Europe, Middle East, and South America.

You can set the emergency dial plan using the Aastra Web UI.

Use the following procedure to specify the numbers to use on your phone for dialing emergency services in your area.



## Aastra Web UI

### 1. Click on **Operation->Phone Lock**.

<b>Status</b> System Information	<b>Phone Lock</b>
<b>Operation</b> User Password Phone Lock Softkeys and XML Directory Reset Expansion Modules	Lock or unlock the phone Emergency Dial Plan Lock the phone? Reset User Password
<b>Basic Settings</b> Preferences Call Forward	<input type="text" value="911 999 112 110"/> <input type="button" value="Lock"/> <input type="button" value="Reset"/> <input type="button" value="Save Settings"/>

### 2. In the "Emergency Dial Plan" field, enter the 3-digit number used in your local area to contact emergency services. For multiple numbers, enter a "|" between each emergency number. For example:

**911|110**

Default for this field is **911|999|112|110**.

### 3. Click to save the emergency dial plan to your phone.

## Language

The IP phones support several different languages. You can have the IP Phone UI and the Aastra Web UI display in a specific language as required. When you set the language to use, all of the display screens (menus, services, options, configuration parameters, etc.) display in that language. The IP phones support the following languages:

- English (default)
- French
- Spanish
- German
- Italian

### Specifying the Language to Use

Once the language pack(s) are available on your phone from your System Administrator, you can specify which language to use on the phone and/or the Aastra Web UI.



**Note:** All languages may not be available for selection. The available languages are dependant on the language packs currently loaded to the IP phone.



#### IP Phone UI

---

Use the following procedure to specify which language to use for the IP Phone UI.

1. Press  on the phone to enter the Options List.
2. Select **Language** and press .
3. Select **English** (English), **Francais** (French), **Espanol** (Spanish), **Deutsch** (German), or **Italiano** (Italian). Default is English.

**Note:** All languages may not be available for selection. The available languages are dependant on the language packs currently loaded to the IP phone. English is the default language and cannot be changed or removed. For more information about loading language packs, see your System Administrator.

4. Press  to set the language on the phone.  
The language you select displays a check mark indicating this is the current language for the IP Phone UI. The change is dynamic. When you exit the Options Menu, the phone displays all menu items in the language you selected.



**Note:** You must have the language pack(s) already loaded to your phone in order to use them. For more information about loading language packs, see your System Administrator.

1. Click on **Basic Settings->Preferences->Language Settings.**

<b>Status</b> System Information <b>Operation</b> User Password Phone Lock Softkeys and XML Directory Reset <b>Basic Settings</b> Preferences Call Forward	<h3 style="text-align: center;">Preferences</h3> <p><b>General</b></p> Park Call: <input type="text"/> Pick Up Parked Call: <input type="text"/> Suppress DTMF Playback <input type="checkbox"/> Enabled Display DTMF Digits <input type="checkbox"/> Enabled Play Call Waiting Tone <input checked="" type="checkbox"/> Enabled Stuttered Dial Tone <input checked="" type="checkbox"/> Enabled <p><b>Incoming Intercom Settings</b></p> Auto-Answer <input checked="" type="checkbox"/> Enabled Microphone Mute <input checked="" type="checkbox"/> Enabled Play Warning Tone <input checked="" type="checkbox"/> Enabled <p><b>Ring Tones</b></p> Tone Set: US <input type="button" value="v"/> Global Ring Tone: Tone 1 <input type="button" value="v"/> Line 1: Global <input type="button" value="v"/> Line 2: Global <input type="button" value="v"/> Line 3: Global <input type="button" value="v"/> Line 4: Global <input type="button" value="v"/> Line 5: Global <input type="button" value="v"/> Line 6: Global <input type="button" value="v"/> Line 7: Global <input type="button" value="v"/> Line 8: Global <input type="button" value="v"/> Line 9: Global <input type="button" value="v"/> <p><b>Time and Date Setting</b></p> Time Format: 12h <input type="button" value="v"/> Date Format: WWW MMM DD <input type="button" value="v"/> <p><b>Language Settings</b></p> Webpage Language: English <input type="button" value="v"/> <p style="text-align: center;"><input type="button" value="Save Settings"/></p>
--	---

2. In the **“Webpage Language”** field, select a language to apply to the Aastra Web UI. The IP phone supports the following languages:

English (default)  
 French  
 Spanish  
 German  
 Italian

**Note:** All languages may not be available for selection. The available languages are dependant on the language packs currently loaded to the IP phone by your System Administrator. English is the default language and cannot be changed or removed.

3. Click  to save your settings. The change is dynamic. The Aastra Web UI displays all screens in the language you selected.

## Model 536 and 560 Expansion Modules (536EM, 560EM)

The 57i IP Phone offers optional Expansion Modules that attach to the right side of the phone to provide additional softkeys.

### *Model 536EM*

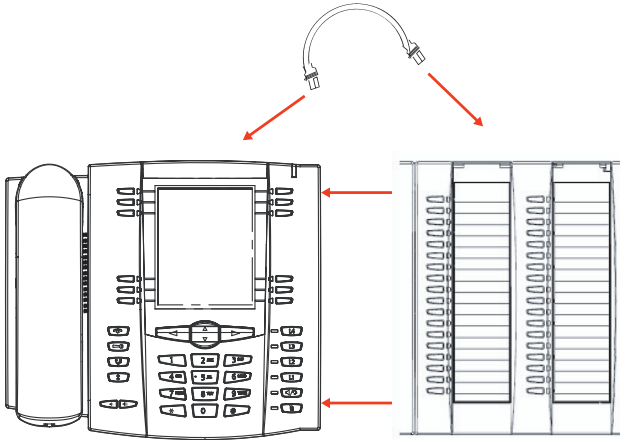

### *Model 560EM*

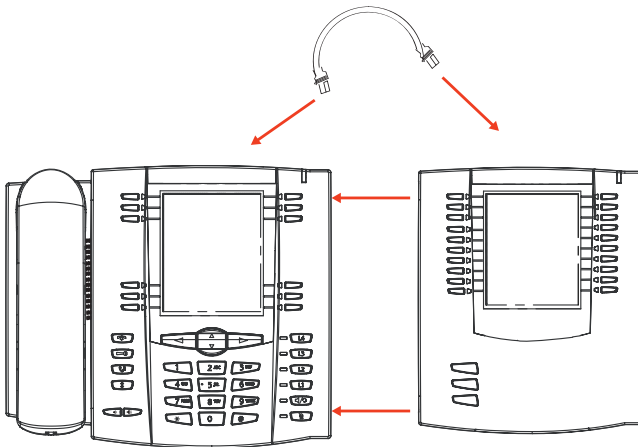

The 536EM provides 36 additional softkeys on a 57i IP Phone. The 560EM provides 60 additional softkeys. The softkeys support the following features:

- BLF
- Speedial
- Shared Call Appearance

Each key provides an LED for indicating call status. The 536EM provides a paper label for convenient key labeling, and the 560EM provides an LCD for displaying key labeling.

Additional modules (up to 3 total modules) can be piggy-backed to an existing module providing an additional 108 softkeys with 536EMs and an additional 180 softkeys with 560EMs. You connect the additional modules to the right side of an existing module. The following figure illustrates the addition of multiple 536EM modules on the 57i IP Phone.

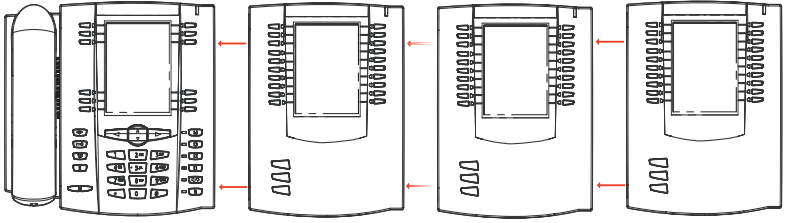

You can configure the softkeys using the Aastra Web UI.

### References

For more information about configuring softkeys, see [Softkeys](#) on [page 24](#).

For more information about installing 536EM and 560EM modules on your phone, see the **Aastra 57i IP Phone Installation Guide**.



## Troubleshooting Solutions

This section describes solutions to some most commonly occurring problems.

### *Why is my display blank?*

Ensure that power is being provided to your phone. If your network does not provide inline power over Ethernet, you can obtain an additional accessory, the Aastra PoE (Power over Ethernet) inline power supply, to provide power over Ethernet locally to your phone. See the section **“Connecting to the Network and to Power”** in the **Aastra 57i Installation Guide** for details.

### *Why is my speakerphone not working?*

If you press the  button and the speaker light flashes and you do not hear dial tone through the speaker phone, the Set Audio option in the phone's Options list has been set up for headset use. Press  a second time and if the light goes out, the phone has been set up to be used only with a headset or handset. If the light stays on steady and you hear dial tone, the phone has been set up so that you can alternate between the speakerphone and the headset by pressing . See the section **“Customizing your phone”** in the **57i Installation Guide** for instructions on how to change the Set Audio option.

### *Why can't I get a dial tone?*

Check for any loose connections and that the phone has been installed properly. For installation instructions, please refer to the **“Installation and Setup”** section in the **Aastra 57i Installation Guide** provided with your phone.

### *Why doesn't my phone ring?*

Check the ring volume on your phone. It may be turned down or turned off. To adjust the ringer volume setting, press the volume button when the phone is on-hook and idle. For more information, refer to the **“Adjusting Volume section”** in the **Aastra 57i Installation Guide** provided with your phone.

### *Why is the light not coming on with a new Voice Mail Message?*

Your phone system or service provider must provide “Visual” Message Waiting service for this function to work. Check with your system administrator for more information.

### *Why is my handset not working?*

Check to ensure that the handset cord is fully connected to both the phone and handset. See the section **“Connecting a Handset or Headset”** in the **Aastra 57i Installation Guide** for information.

## *What are services, and how do I use them?*

Services on the IP phone include:

- XML Applications
- Callers List
- Directory List
- Voicemail

See the section, "[Setting Services Softkey](#)" on [page 55](#) more information about the options available under "Services".

## *How do I find the IP address of my phone?*

Instructions on where to find the IP address of your phone can be found in this guide in the section, "[Finding Your Phone's IP Address](#)" on [page 15](#).

## *Why does my phone display the "No Service" message?*

The phone displays the "**No Service**" message if the SIP settings have not been set up correctly.





Contact your system administrator for more information.

## *How do I change my user password?*

You can change the user password from the IP phone UI or the Aastra Web UI.



### IP Phone UI

1. Press  on the phone to enter the Options List.
2. Select **User Password** and press  .
3. Enter the current user password and press  .
4. Enter the new user password and press  .
5. Re-enter the new user password and press  .  
A message, "Password Changed" displays on the screen.



### Aastra Web UI

1. Click on **Operation->User Password**.
2. In the "**Current Password**" field, enter the current user password.  
**Note:** By default, the user name is "user" (all lowercase) and the password field is left blank. If you have forgotten your password, contact your system administrator for assistance.
3. In the "**New Password**" field, enter the new user password.
4. In the "**Password Confirm**" field, enter the new user password again.
5. Click  to save your changes.



For information on how to access the Aastra Web UI, go to the section "Using the Aastra Web UI" on page 16.

### *Why does my phone display "Bad Encrypted Config"?*

The IP phone displays "Bad Encrypted Config" because encrypted configuration files are enabled but the decryption process has failed.

Report this error to your system administrator.

### *How do I restart the IP phone?*



#### IP Phone UI

---

1. Press the  button on the phone to enter the Option List.
2. Use the  $\nabla$  key to scroll down the list of options to **Phone Status** and press the  $\triangleright$  key to select.
3. Press the  $\nabla$  key to scroll to the **Restart Phone** option.
4. Press the  $\triangleright$  key to confirm and restart the phone. If you do not wish to restart your phone, press the  $\triangleleft$  key to cancel.

**Note:** Your phone will be out of service temporarily during the restart and downloading process.



#### Aastra Web UI

---

1. Click on **Operation->Reset**.

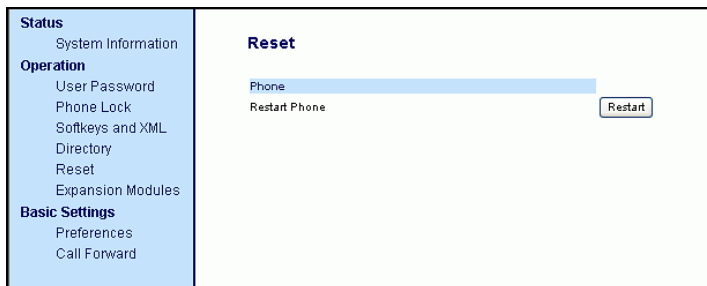

2. Click  .
3. Click **OK** at the confirmation prompt.



## Limited Warranty

Aastra Telecom warrants this product against defects and malfunctions during a one (1) year period from the date of original purchase. If there is a defect or malfunction, Aastra Telecom shall, at its option, and as the exclusive remedy, either repair or replace the telephone set at no charge, if returned within the warranty period.

If replacement parts are used in making repairs, these parts may be refurbished, or may contain refurbished materials. If it is necessary to replace the telephone set, it may be replaced with a refurbished telephone of the same design and color. If it should become necessary to repair or replace a defective or malfunctioning telephone set under this warranty, the provisions of this warranty shall apply to the repaired or replaced telephone set until the expiration of ninety (90) days from the date of pick up, or the date of shipment to you, of the repaired or replacement set, or until the end of the original warranty period, whichever is later. Proof of the original purchase date is to be provided with all telephone sets returned for warranty repairs.

### Exclusions

Aastra Telecom does not warrant its telephone sets to be compatible with the equipment of any particular telephone company. This warranty does not extend to damage to products resulting from improper installation or operation, alteration, accident, neglect, abuse, misuse, fire or natural causes such as storms or floods, after the telephone is in your possession.

Aastra Telecom shall not be liable for any incidental or consequential damages, including, but not limited to, loss, damage or expense directly or indirectly arising from the customer's use of or inability to use this telephone, either separately or in combination with other equipment. This paragraph, however, shall not apply to consequential damages for injury to the person in the case of telephones used or bought for use primarily for personal, family or household purposes.

This warranty sets forth the entire liability and obligations of Aastra Telecom with respect to breach of warranty, and the warranties set forth or limited herein are the sole warranties and are in lieu of all other warranties, expressed or implied, including warranties or fitness for particular purpose and merchantability.

### Warranty Repair Services

Should the set fail during the warranty period;

**In North America**, please call 1-800-574-1611 for further information.

**Outside North America**, contact your sales representative for return instructions.

You will be responsible for shipping charges, if any. When you return this telephone for warranty service, you must present proof of purchase.

### After Warranty Service

Aastra Telecom offers ongoing repair and support for this product. This service provides repair or replacement of your Aastra Telecom product, at Aastra Telecom's option, for a fixed charge. You are responsible for all shipping charges. For further information and shipping instructions;

**In North America**, contact our service information number: 1-800-574-1611.

**Outside North America**, contact your sales representative.

**Note:** Repairs to this product may be made only by the manufacturer and its authorized agents, or by others who are legally authorized. This restriction applies during and after the warranty period. Unauthorized repair will void the warranty.



# Appendix A - Time Zone Codes

The following table identifies the time zone name and time zone code to use on the IP phone.

**Time Zone Name/Time Zone Code Table**

Time Zone Name	Time Zone Code
AD-Andorra	CET
AG-Antigua	AST
AI-Anguilla	AST
AL-Tirane	CET
AN-Curacao	AST
AR-Buenos Aires	ART
AS-Pago Pago	BST
AT-Vienna	CET
AU-Lord Howe	LHS
AU-Tasmania	EST
AU-Melbourne	EST
AU-Sydney	EST
AU-Broken Hill	CST
AU-Brisbane	EST
AU-Lindeman	EST
AU-Adelaide	CST
AU-Darwin	CST
AU-Perth	WST
AW-Aruba	AST
BA-Sarajevo	EET
BB-Barbados	AST
BE-Brussels	CET
BG-Sofia	EET
BM-Bermuda	AST
BO-La Paz	BOT
BR-Noronha	FNT
BR-Belem	BRT
BR-Fortaleza	BRT
BR-Recife	BRT
BR-Araguaina	BRS
BR-Maceio	BRT
BR-Sao Paulo	BRS
BR-Cuiaba	AMS
BR-Porto Velho	AMT
BR-Boa Vista	AMT
BR-Manaus	AMT
BR-Eirunepe	ACT
BR-Rio Branco	ACT
BS-Nassau	EST
BY-Minsk	EET
BZ-Belize	CST

# Appendix A - Time Zone Codes

Time Zone Name	Time Zone Code
CA-Newfoundland	NST
CA-Atlantic	AST
CA-Eastern	EST
CA-Saskatchewan	EST
CA-Central	CST
CA-Mountain	MST
CA-Pacific	PST
CA-Yukon	PST
CH-Zurich	CET
CK-Rarotonga	CKS
CL-Santiago	CLS
CL-Easter	EAS
CN-China	CST
CO-Bogota	COS
CR-Costa Rica	CST
CU-Havana	CST
CY-Nicosia	EES
CZ-Prague	CET
DE-Berlin	CET
DK-Copenhagen	CET
DM-Dominica	AST
DO-Santo Domingo	AST
EE-Tallinn	EET
ES-Madrid	CET
ES-Canary	WET
FI-Helsinki	EET
FJ-Fiji	NZT
FK-Stanley	FKS
FO-Faeroe	WET
FR-Paris	CET
GB-London	GMT
GB-Belfast	GMT
GD-Grenada	AST
GF-Cayenne	GFT
GI-Gibraltar	CET
GP-Guadeloupe	AST
GR-Athens	EET
GS-South Georgia	GST
GT-Guatemala	CST
GU-Guam	CST
GY-Guyana	GYT

Time Zone Name	Time Zone Code
HK-Hong Kong	HKS
HN-Tegucigalpa	CST
HR-Zagreb	CET
HT-Port-au-Prince	EST
HU-Budapest	CET
IE-Dublin	GMT
IS-Reykjavik	GMT
IT-Rome	CET
JM-Jamaica	EST
JP-Tokyo	JST
KY-Cayman	EST
LC-St Lucia	AST
LI-Vaduz	CET
LT-Vilnius	EET
LU-Luxembourg	CET
LV-Riga	EET
MC-Monaco	CET
MD-Chisinau	EET
MK-Skopje	CET
MQ-Martinique	AST
MS-Montserrat	AST
MT-Malta	CET
MX-Mexico City	CST
MX-Cancun	CST
MX-Merida	CST
MX-Monterrey	CST
MX-Mazatlan	MST
MX-Chihuahua	MST
MX-Hermosillo	MST
MX-Tijuana	PST
NI-Managua	CST
NL-Amsterdam	CET
NO-Oslo	CET
NR-Nauru	NRT
NU-Niue	NUT
NZ-Auckland	NZS
NZ-Chatham	CHA
PA-Panama	EST
PE-Lima	PES
PL-Warsaw	CET
PR-Puerto Rico	AST
PT-Lisbon	WET
PT-Madeira	WET
PT-Azores	AZO
PY-Asuncion	PYS

# Appendix A - Time Zone Codes

<b>Time Zone Name</b>	<b>Time Zone Code</b>
RO-Bucharest	EET
RU-Kaliningrad	EET
RU-Moscow	MSK
RU-Samara	SAM
RU-Yekaterinburg	YEK
RU-Omsk	OMS
RU-Novosibirsk	NOV
RU-Krasnoyarsk	KRA
RU-Irkutsk	IRK
RU-Yakutsk	YAK
RU-Vladivostok	VLA
RU-Sakhalin	SAK
RU-Magadan	MAG
RU-Kamchatka	PET
RU-Anadyr	ANA
SE-Stockholm	CET
SG-Singapore	SGT
SI-Ljubljana	CET
SK-Bratislava	CET
SM-San Marino	CET
SR-Paramaribo	SRT
SV-El Salvador	CST
TR-Istanbul	EET
TT-Port of Spain	AST
TW-Taipei	CST
UA-Kiev	EET
US-Eastern	EST
US-Central	CST
US-Mountain	MST
US-Pacific	PST
US-Alaska	AKS
US-Aleutian	HAS
US-Hawaii	HST
UY-Montevideo	UYS
VA-Vatican	CET
YU-Belgrade	CET



## Numerics

57i CT features

base unit 2

cordless handset 2

57i CT line settings 23

57i CT requirements 2

## A

Aastra Web UI

basic settings description 18

operation description 17

status description 17

about this guide 1

additional features 120

answering incoming calls 72

auto-answer, enabling/disabling 69

## B

backlight on cordless handset 102

bad encrypted config 145

battery charge state 105

battery, on cordless handset

battery indicator and status 108

charging 107

BLF List, setting softkey for 38

BLF, setting softkey for 36

## C

call forwarding 92

configuring 93

call privacy, on cordless handset 113

call time on cordless handset 101

call waiting tone 123

callers list 87

deleting entries in 90

downloading to PC 91

downloading to phone 91

editing 89

using 88

using on phone 88

callers list, on cordless handset 111

callers list, softkey for 58

calls, transferring 75

conferencing calls 76

cordless handset

key description 97

key descriptions 98

key panel 97

pairing 115

unpairing 117

using 97

custom name on cordless handset 101

## D

deleting a softkey 63

dial plan, emergency 137

dial tones, stuttered 122

dialing

pre-dialling a number 65

dialing a number 65

directory key, softkey for 57

directory list 80

adding and editing entries 81

arranging entries 84

deleting single and multiple entries  
85

downloading to PC 86

downloading to server 86

limitations for 81

scrolling multiple screens 83

sorting 80

using 86

directory, on cordless handset 108

do not disturb, setting softkey for 35

documentation 1

DTMF digits, displaying 121

DTMF, suppressing playback 120

## E

emergency dial plan, defining 137

empty key, softkey for 62

ending calls 79

ending calls, from cordless handset 114

expansion module, 536EM 141

expansion module, 560EM 141

## F

feature key

guidelines 103

feature key activation 105

feature key on cordless handset 107

feature keys

description of 103

features keys

programming 104

**G**

getting started 4

**H**

handling calls 73

handset keys 97

handset pairing 101

headset mic 66

headset, using 66

headset, using on cordless handset 113

held calls, retrieving 74

hold, automatic 74

**I**

icons, on cordless handset 105

idle mode on cordless handset 105

idle screen 9

installation and setup, 9122i 3

intercom calls 68

intercom calls, incoming and auto-answer 124

Intercom key, softkey for 60

intercom on cordless handset 100

Intercom, using 68

IP address, finding 15, 144

IP address, finding on cordless handset 102

**K**

key descriptions 20

key lock on cordless handset 102

key panel

cordless handset 97

**L**

language

overview 139

specifying on IP phone 139

language on cordless handset 100

last call return, softkeys for 52

LED indicator on cordless handset 107

line, setting a softkey for 30

locking/unlocking the phone 134

**M**

making calls 65

making calls, from cordless handset 113

managing calls 80

menu list on cordless handset 107

microphone, enabling/disabling 69

missed calls indicator

accessing and clearing 95

overview 95

multiple line call appearances 23

mute 71

mute key on cordless handset 106

**N**

network disconnected 8

no service 144

**O**

on-hold calls 73

options

setting via the phone UI 13

setting via the Web UI 15

options on cordless handset 99

**P**

pairing and unpairing, handset to base 115

park and pickup, using on phone 51

park/pickup

configuring a static configuration 47

configuring softkey configuration 49

password, resetting user's 136

picking up calls 79

plugging in the phone 4

predialling a number, from cordless handset 113

public feature key 113

**R**

Receiver Volume 105

receiving calls 72

receiving calls, on cordless handset 113

Reception Range 105

redial 70

redial key on cordless handset 106

release key on cordless handset 106

restarting the phone 64

ring tone on cordless handset 100

ring tone sets 127

ring tones 126

Ringer Volume 105

# Index

## S

- services, softkey for 54
- softkeys 24
  - as BLF 36
  - as BLF List 38
  - as Callers List Key 58
  - as Directory key 56
  - as Do Not Disturb 35
  - as empty key 62
  - as Intercom Key 60
  - as Last Call Return 52
  - as line/call appearances 28
  - as park and pickup 48
  - as services 54
  - as speeddials 31
  - deleting 63
  - functions for 25
  - state-based 26
- softkeys on cordless handset 106
- speeddial, setting softkey for 31
- star codes 120
- starting up the phone 4
- status messages on cordless handset 105

## T

- talk/hold key on cordless handset 106
- time and date 130
- time and date format 130
- transferring calls, blind 75
- transferring calls, consultative 75
- troubleshooting solutions 143
  - How do I change my user password? 144
  - How do I find the IP address of my phone? 144
  - How do I restart the IP phone? 145
  - What are services, and how do I use them? 144
  - Why can't I get a dial tone? 143
  - Why does my phone display "Bad Encrypted Config"? 145
  - Why does my phone display the "No Service" message? 144
  - Why doesn't my phone ring? 143
  - Why is my display blank? 143
  - Why is my handset not working?

143

- Why is my speakerphone not working? 143
- Why is the light not coming on with a new Voice Mail Message? 143

## U

- user password 19
- using your phone 20

## V

- Vibrate 105
- voicemail 72, 96
- volume control on cordless handset 108
- vibrate on cordless handset 101

## W

- warranty, limited 147
- Web UI, using 16





If you've read this owner's manual and consulted the Troubleshooting section and still have problems, please visit our website at [www.aastra.com](http://www.aastra.com) or call 1-800-574-1611 for technical assistance.

© Aastra Telecom Inc. 2007 41-001202-00 Rev 01

## Free Manuals Download Website

<http://myh66.com>

<http://usermanuals.us>

<http://www.somanuals.com>

<http://www.4manuals.cc>

<http://www.manual-lib.com>

<http://www.404manual.com>

<http://www.luxmanual.com>

<http://aubethermostatmanual.com>

Golf course search by state

<http://golfingnear.com>

Email search by domain

<http://emailbydomain.com>

Auto manuals search

<http://auto.somanuals.com>

TV manuals search

<http://tv.somanuals.com>