



***9316CW Installation
and
User Guide***



9316CW Important Tips

- %o Wait for at least two rings to allow the phone to identify a caller and display the caller's name and/or number. You will have to subscribe to a Calling Line Identification service to take advantage of this feature.*
 - %o The 9316CW is able to make and receive calls even during a power failure. Features such as the display and memory keys will not work without power.*
 - %o To call back local calls from the Callers List, be sure to remove the area code.*
 - %o To use the Call Waiting Identification feature, you must subscribe to a Call Waiting Identification service from your local telephone company.*
 - %o Some memory keys may be factory pre-programmed, and cannot be programmed by the user.*
- Remember that there is a 24 digit limit on numbers and a 16 character limit on names stored in the Directory.*

Table of Contents

Introduction	1	Making a call from the Callers List	15
Key Descriptions	2	Editing in the Callers List	16
The Set Options list	3	Saving Callers List numbers to the Directory or a Memory key	16
Basic Installation	4	Deleting from the Callers List	17
Connecting the handset cord	4	Memory keys	17
Connecting the line cord	4	Saving numbers and names in memory keys	17
Connecting an optional fax machine or modem	4	Saving from the display into memory keys	17
Connecting the power adaptor	4	Labeling the memory keys	18
Checking your telephone	5	Making calls from memory keys	18
Desk Mounting	5	Editing memory keys	18
Optional Wall Mounting	5	Deleting memory keys	19
Adjusting the Display	5	Saving features in memory keys	19
The Set Options Key	5	Using feature keys	19
Basic Features	6	Saving a feature and light in memory keys	20
Making a call	6	Using FeatureLight keys	20
Answering a call	6	Advanced Features	21
Making a Handsfree call	7	Adding a timer key	21
Putting a call on mute	7	Using the call timer	21
Using the Redial List	7	Deleting a timer key	21
Super Call Waiting Identification [™]	8	Selecting the dial pad mode	21
SuperFlash	9	Entering area codes	22
Turning the display of Call Waiting Identification on or off	10	The Security Numbers feature	23
Changing the display language	10	Display messages and lights	24
Setting the date and time	10	The Callers List screen	24
Turning the ringer on or off	11	Knowing when you have a Voice Mail message	24
Setting ring tone and ringer volume	11	Clear Message Waiting	24
Controlling the ringer volume	11	General display messages	25
Controlling the receiver volume	11	Callers List display messages	26
Controlling the speaker volume	11	Learning about the lights	27
Directory	12	Set indicator light messages	27
Saving numbers and names to the Directory	12	Handsfree indicator light messages	27
Saving an active call into Directory	12	Viewing multiple display and light messages	27
Saving a memory key entry to the Directory	13	Troubleshooting	28
Entering Names	13	Index	
Making a call from the Directory	13		
Finding items in the Directory	14		
Editing in the Directory	14		
Deleting items from the Directory	14		
Callers List	15		
Using the Callers List	15		
Setting up the Callers List	15		
Finding an item in the Callers List	15		

Introduction

Thank you for purchasing 9316CW telephone. We think you'll find it's full of exciting features. With a personal Directory and a Callers list, your new telephone is designed to take full advantage of the latest services offered by your local telephone company.

When you subscribe to services such as Calling Line Identification and Call Waiting Identification[†] through your local telephone company, your 9316CW will show you all the caller information you'll need on its three-line back-lit display. For example, before you even answer a call you'll know who is calling, even if it's a Call Waiting call. And Call Waiting Identification information can appear on two telephone extensions at the same time so that someone at either extension can initiate the switch to a Call Waiting call. Your telephone will also tell you how many new callers you have.

You can set up a personal Directory in which you can enter up to 50 names and numbers, and your Callers List will log up to 50 incoming calls. The Options List makes it easy for you to personalize your telephone, and the back-lit three-line display provides walk-through prompting that makes all of the many features and options even easier to customize. Please read on for more information on the many features of your 9316CW.

[†] The names of these services may vary from area to area.

Key Descriptions

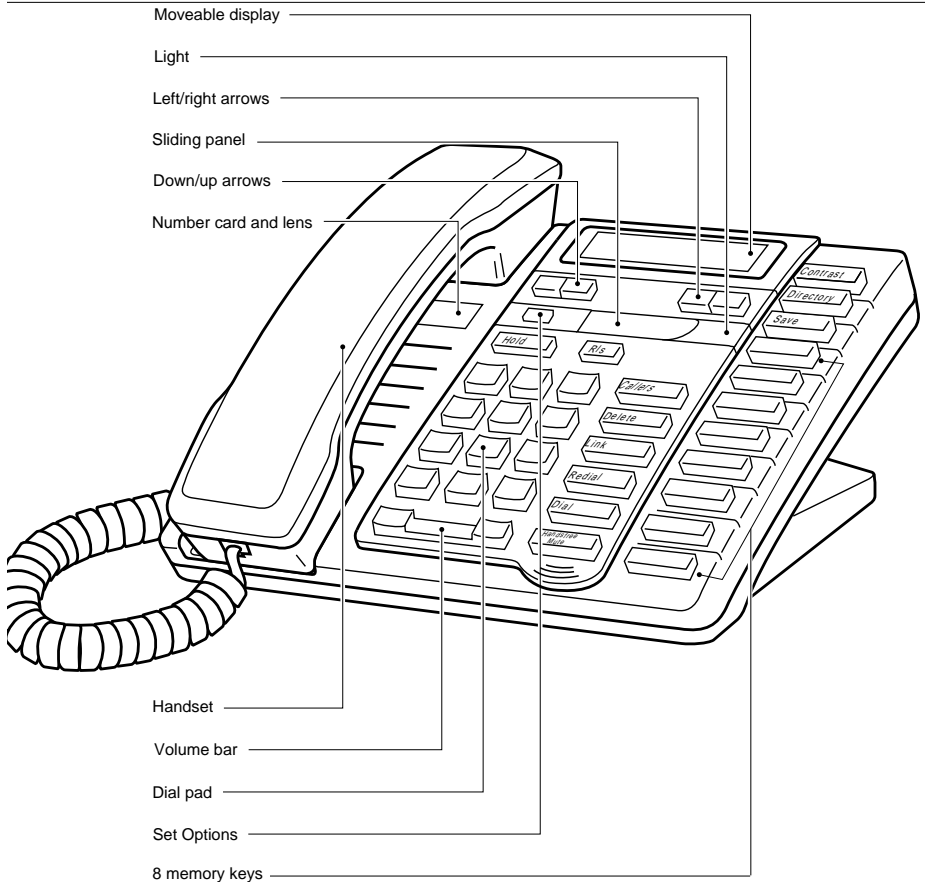

Contrast

Cycles through eight settings to adjust the display contrast.

Directory

Allows you to store and access up to 50 numbers and names.

Save

Stores numbers and names in the Directory and in memory keys.

↓ ↑

Allows you to move up and down any list such as the Set Options, Directory, Callers List, or Redial List.

←











Allows you to backspace and erase when predialing and when adding or changing numbers and names in the Directory, Callers List or in memory keys.

→

Adds a space when entering names in the Directory or in memory keys. Allows you to view status messages on the display.

Hold

Puts the call on hold, inserts a pause and shifts between upper and lower case.

-  Always hangs up a call. Also allows you to leave any list such as the Set Options List, Callers List, Redial List or Directory.
-  Allows you to access a list of people who called.
-  Allows you to erase memory keys, delete single or all items in the Directory and Callers List as well as the entire Redial List.
-  Allows you to access network features such as Call Waiting. Link is also referred to as Flash.
-  Allows you access to a list of the last five numbers you dialed.
-  Dials any displayed number. Activates Handsfree mode if you have not lifted the handset.
-  Activates the Handsfree speaker and microphone so you can listen and talk without lifting the handset. Also allows you to mute a handsfree call so that a caller cannot hear you.
-  Allows you to adjust the receiver, speaker, and ringer volume.
-  Memory keys store numbers, names, and features.
-  The unlabeled Set Options key is hidden under the sliding panel and allows you to access ten options to customize your telephone.

The Set Options list

Set Options list	page
01. Change display language	10
02. Set the time and date	10
03. Select the ring tone	11
04. Add a Timer key	21
05. Select the dial pad mode	21
06. Clear message waiting	24
07. Enter area codes	22
08. Set up the Callers List	15
09. Add Security Number	23
10. Call Waiting Identification display on or off	10

Note: Please refer to each section for the default settings for the above options.

Basic Installation

This section explains how to install your 9316CW telephone.

Connecting the handset cord

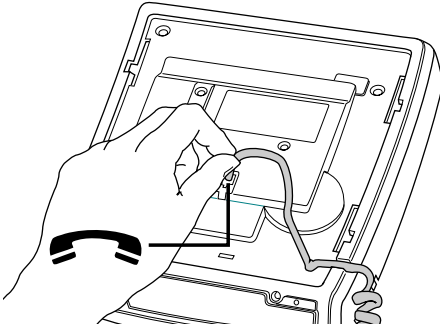

Attach one end of the handset cord to the handset and the other end to the handset jack.

Connecting the line cord

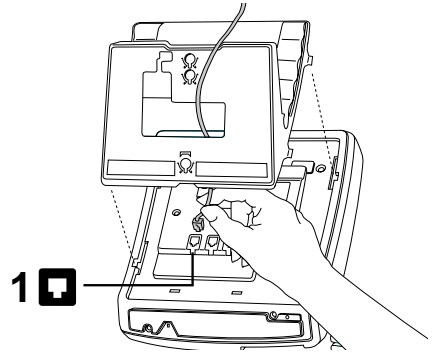

Attach one end of the line cord to jack number 1 and the other end of the line cord to the wall jack.

Connecting an optional fax machine or modem

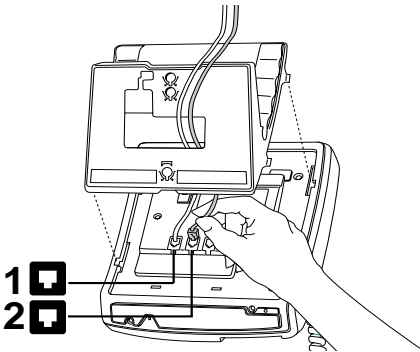

Attach the line cord to jack number 2 and the other end to the modem or fax machine. This line cord is not supplied with the telephone.

Connecting the power adaptor

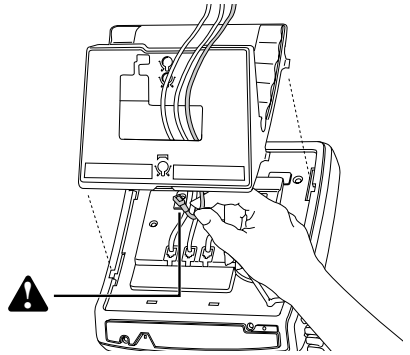

Attach the power adaptor to the base of the telephone where the warning symbol is marked. Connect the power adaptor into the closest electrical outlet.



To avoid potential electrical shock hazard to personnel or damage to the telephone, use **only** the manufacturer-supplied equipment and installation procedures. Specifically, use only 2 or 4 conductor modular teledapt plug/cords with this product, and an AC transformer that is CSA/UL or CSA-NRTL/C approved Class 2 level C, rated as follows:

For North American Markets mains nominal AC voltage 110-117V, Input: 110/117VAC, 50/60Hz, 10W and Output: 16VAC 250mA.

For International Markets mains nominal AC voltage 220-240V, Input: 220/240VAC, 50/60Hz, 10W and Output: 16VAC 250mA.

Substitution of non-approved equipment will void the Aastra Telecom Inc., warranty. For more information call 1-800-574-1611.

Checking your telephone

When you plug in your 9316CW, you may see a message asking you to make a language selection. Follow the directions on the display to select a language.

Your telephone also runs a test to ensure that the line cords are connected properly. If the test fails, the display prompts you to check the line cord. Make sure that all connections are fastened securely.

Desk Mounting

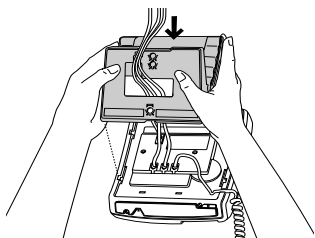

Lower the stand into the slots on the base of the telephone, as shown above.

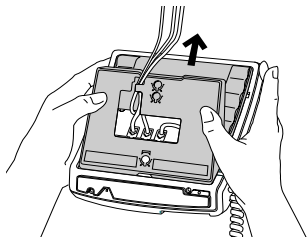

Slide the stand back until it clicks into the locked position.

Optional Wall Mounting[†]

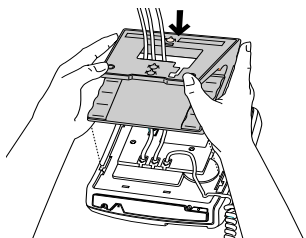

Lower the stand into the slots on the base of the telephone, as shown above.

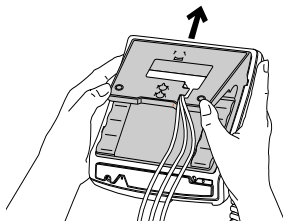

Slide the stand back until it clicks into the locked position.

Adjusting the Display

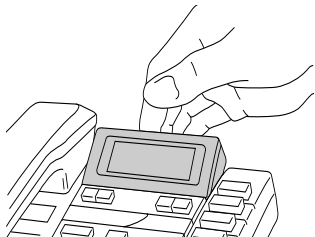

Place your 9316CW on a table or hang it on a wall, then adjust the display.

The Set Options Key

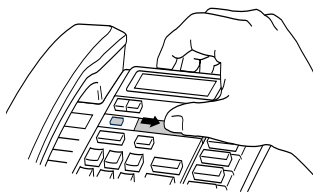

Move the sliding panel over to the right to reveal the Set Options key.

[†]We recommend that you use a wall mounting plate which is available through your telephone company. If you are going to wall mount your 9316CW, use the 20 cm (8") line cord supplied with your telephone.

Note: The Ringer Equivalence Number (REN) is 1.4B for the 9316CW telephone. Please see the base of your telephone or the Regulations sheet for more regulatory and safety information.

Basic Features



Making a call

You can use the 9316CW to simply make a regular call, or you can predial a telephone number to ensure it is correct before it is dialed out. Follow the procedures below to make a regular or predialed call.

To make a regular call:

1. Lift the handset or press .
2. Enter the number using the dial pad.

To make a predialed call:

1. Enter the number using the dial pad.
2. Lift the handset or press either  or .

Note: If you have turned on the live dial pad option, you will not have to lift the handset or press any buttons after entering the number. Refer to **Selecting the dial pad mode** on page 21.

Answering a call

To answer a call:



1. Lift the handset or press .

Calling Line Identification information is sent from the telephone company to your 9316CW telephone between the first and second ring. Therefore, if you want the telephone number of the incoming call to appear on the display and in the Callers List, you must wait until the information appears on the display before answering the telephone.

Putting a call on hold

When you put a call on hold it is important to hang up the handset.

To put a call on hold and take a call off hold:

1. Make or answer a call.
2. Press . The display shows that the call is on hold.
3. Hang up the handset.
4. To retrieve the call, lift the handset or press either  or . If you don't retrieve the call within 15 minutes, the call is automatically dropped.

Note: The 9316CW automatically releases the held call when a person on an extension telephone picks up the call. If you don't hang up the handset after you have put a call on hold and that call is picked up by someone at another extension, the call is taken off hold but remains connected to your telephone. If this happens, any background noise from your area will be heard by the caller and the person at the other extension.

Making a Handsfree call

You don't have to use the handset to use your telephone. Instead, you can use Handsfree mode to place a call, or you can switch to Handsfree mode while a call is already in progress.

To dial without picking up the handset:

1. Press .
2. Enter the number using the dial pad.

To switch to a Handsfree call:

1. Lift the handset.
2. Enter the number using the dial pad.
3. When the call is answered, press .
4. Hang up the handset.

Putting a call on mute

You can turn off the microphone so that the caller cannot hear you but you can still hear the caller. Muting a call only works when you are in Handsfree mode.

To mute a call:

1. Press .
2. Without lifting the handset, make a call.
3. To turn the microphone off, press again. You can hear your caller but your caller cannot hear you. The light beside flashes.
4. To speak to your caller, press again. Each time you press , you switch between handsfree and mute.
5. When the call is over, press .

Using the Redial List

The Redial List stores the last five numbers you dialed. When you press , the last number you called appears on the screen. You can scroll through the list to view the other numbers. Note that if you press after either lifting the handset or pressing , your telephone automatically dials the last number in the Redial list.

To make a call from the Redial List:

1. Press . The display shows the last number you dialed.
2. Find the number you wish to call by pressing .
3. When the number is displayed, lift the handset or press either or .

There may be times when you want to delete the contents of the Redial List. For example, if you have dialed a personal number such as a password or your calling card number, you may not want it to appear in the list where anyone can see it.

To delete the Redial List:

1. Press .
2. Press twice. The entire Redial List is deleted.

Call Waiting Identification†

The 9316CW is capable of displaying Call Waiting Identification information of a second incoming call while you have a call in progress. When you are on a call and you hear the Call Waiting tone, the Call Waiting information is displayed as shown below.

Incoming caller's information
(Caller One) is displayed.



When you hear the Call Waiting tone,
Caller Two's information is displayed.

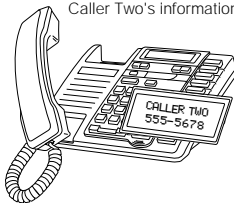

If you decide you want to speak to the new caller, simply press **Link** . Your first call will not be disconnected. You may switch between callers as often as you like by pressing **Link** . When you press **Link** and see a caller's Identification information but only hear a dial tone, it means the caller has hung up. Your second call will be stored in the Callers List even if it isn't answered. For more information about stored calls, see **Using the Callers List** on page 15.

Note: The Call Waiting Identification display option must be enabled in order to see the Call Waiting Identification information on the display. Refer to **Turning the display of Call Waiting Identification on or off** on page 10.

Super Call Waiting Identification†

The Super Call Waiting Identification feature allows the 9316CW and one other Super Call Waiting Identification compatible telephones to display identification information about the second call at the same time as shown below.

Incoming caller's information
(Caller One) is displayed.



Extension telephone picks up and also speaks with Caller One.

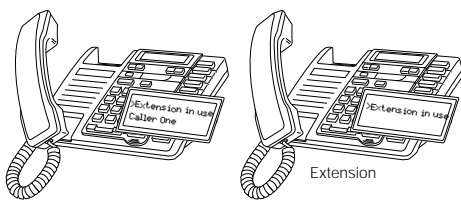

Call Waiting tone sounds and Caller Two's
information is displayed on both extensions.

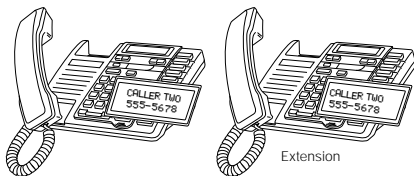

† You must subscribe to your telephone company for the Call Waiting with Calling Line Identification service.

SuperFlash†

The SuperFlash feature allows either of two telephone extensions to activate the link to a Call Waiting call. When a person at either extension presses **Link**, both extensions switch to and speak with the Call Waiting caller as shown in the diagrams below.

Incoming caller's information (Caller One) is displayed.



Extension telephone picks up and also speaks with Caller One.

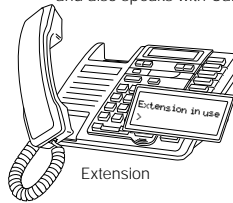

Call Waiting tone sounds and Caller Two's information is displayed on both extensions.

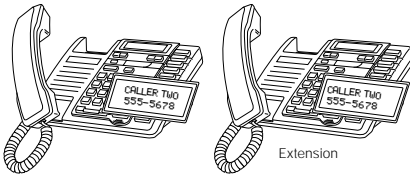

Either telephone can press **Link** to speak with Caller Two.



Both telephones speak to Caller Two and see the displayed information.

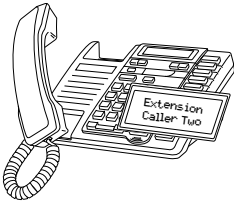

Either telephone can press **Link** again to switch back to Caller One.



Calls are not disconnected when you press **Link**. If you wish to return to your first caller press **Link** again. The 9316CW and one other SuperFlash compatible telephone extension will switch between the two callers each time you press **Link**. Once you have switched to one caller by pressing **Link**, you must wait three seconds before you can switch back to the previous caller. When you press **Link** and see a caller's Identification information but only hear a dial tone, it means that the caller has hung up.

To end a call, ensure you can see that call's Identification information (you may have to press **Link**), then press **RLS**.

Note: SuperFlash and Super Call Waiting Identification only work with SuperFlash and Super Call Waiting Identification compatible telephones.

† You must subscribe to your telephone company for the Call Waiting with Calling Line Identification service.

Turning the display of Call Waiting Identification on or off

You can choose whether or not Call Waiting Identification is displayed on your telephone.

To turn Call Waiting Identification on or off:

1. Press the Set Options key.
2. Use \downarrow \uparrow to scroll to number 10 or press $\boxed{10}$ to go directly to the item.
3. Press \otimes to turn the Call Waiting Identification display on or off.
4. Press $\boxed{R/S}$.

Note: Turning the display of Call Waiting Identification on or off does not turn the feature itself on or off. When the Call Waiting display is turned off, you will still hear the Call Waiting tone when a Call Waiting call comes in, but the identification information for the Call Waiting caller will not appear on your display screen. Contact your local telephone company to subscribe or unsubscribe to Calling Line Identification with Call Waiting Identification services.

Changing the display language

For changing business requirements, you may wish to change the language of your display messages and prompts.

To change the display language:

1. Press the Set Options key.
2. Use \downarrow \uparrow to scroll to number 1 or press $\boxed{01}$ to go directly to the item.
3. Press \otimes to change the language.
4. Press \downarrow \square until the display language you want appears on the display.
5. Press $\boxed{\#}$ to select the displayed language.
6. Press $\boxed{R/S}$.

Setting the date and time

If you subscribe to the Calling Line Identification service from your telephone company, the date and time are set automatically after you receive your first incoming call. If you do not subscribe, you must set the date and time manually.



To set the date and time manually:

1. Press the Set Options key.
2. Use \downarrow \uparrow to scroll to number 2 or press $\boxed{02}$ to go directly to the item.
3. Press \otimes and follow the instructions on the display.
4. Press $\boxed{R/S}$.



To resume the automatic date and time setting (if the date and time has been set manually), disconnect the power supply, then re-connect it. After your first incoming call, the date and time are automatically set.

Turning the ringer on or off

To turn the ringer on:

1. Press the right side of   . Continue pressing the right hand side until you reach the desired ring volume.

To turn the ringer off:









1. Press the left side of   . Continue pressing the left hand side until the ringer is off.
Ringer is OFF appears on the display.

Note: Do not lift the handset while you are turning the ringer on or off.



Setting the ring tone and ringer volume

You can choose one of four different ring tones and set the ringer volume.



To set the ring tone and volume:

1. Make sure that the ringer is turned on.
2. Press the Set Options key.
3. Use   to scroll to number 3 or press  to go directly to the item.
4. Press  and follow the instructions on the display.
When picking the ring tone, press    to adjust the volume.
5. Press  to end when you are satisfied with ring tone and ringer volume.
Note: You cannot turn the volume off when you are choosing the ring tone.
6. Press .



Controlling the ringer volume

When the telephone is ringing, you can press the left or right side of the volume bar    to adjust the ringer volume.

Controlling the receiver volume

When you are on the telephone, you can press the left or right side of the volume bar    to adjust the receiver volume. When you have completed your call, the receiver volume returns to default.

Controlling the speaker volume

When you are listening through the speaker, you can press the left or right side of the volume bar    to adjust the speaker volume.

Directory

The 9316CW stores the numbers and names of up to 50 of your business associates, clients, contacts, and friends in your Directory. You can dial these numbers by selecting them.

Names are sorted alphabetically starting with their first character. (If you want your Directory sorted by the last name, enter the last name first.) If you do not enter a name, the item is sorted by telephone number. The Directory items with only a telephone number are numerically sorted at the beginning of the Directory.

Saving numbers and names to the Directory

To save a new number and name:

1. Press .

2. Press .

3. Enter the number using the dial pad.

4. Press . Only the number is stored at this point.

5. If you do not want a name, go to step 6. To enter a name, use the dial pad. (See **Entering Names** on page 13.)

6. Press .

To save from the display:

1. Ensure a number is on the display. Choose a number from the Directory, Redial List, or Callers List, or turn off the Live Dial Pad option and press a memory key.

2. Press .

3. Press . If the name is displayed with the number, both are now saved in the Directory.

4. If no name is displayed, you are prompted to enter one. If you do not want a name, go to step 5. To enter a name, use the dial pad. (See **Entering Names** on page 13.)

5. Press .

Saving an active call into the Directory

To save an active call:

1. Answer or make a call.

2. Press .

3. Press . If the name was displayed with the number, both are now saved in the Directory.

4. If no name is displayed, you are prompted to enter one. If you do not want to enter one, go to step 5. To enter one, use the dial pad. (See **Entering Names** on page 13.)

5. Press .

6. Press .

Saving a memory key entry to the Directory

To save a memory key entry into the Directory:

1. Press the desired memory key. Ensure the live dial pad option is turned off.
2. Press .
3. Press . If the name was displayed with the number, both are now saved in the Directory.
4. If no name is saved, you are prompted to enter one. If you do not want to enter a name, go to step 5. To enter a name, use the dial pad. (See **Entering Names** on page 13.)
5. Press .
6. Press .

Entering Names

You can program names to correspond with numbers you have entered into the Directory or a memory key. The following paragraphs explain how to enter letters using the dial pad. Before you can use the dial pad to enter names, you must first save or edit a number in the Directory or memory key.

To program a name, find the dial pad key that has the first character of the name. Keep watching the display as you press the key until that character appears on the display. Press a different dial pad key for the next character. If the next character is on the same key, press > to move to the next space. To display upper case letters, press , then press the appropriate dial pad key. To insert a space, press > . To backspace and erase a mistake, press .

For example, to enter the name **Ruth** press these keys:

, , > , , .

If you wish to change a digit or letter after you have entered it, press to erase it.

<input type="text" value="1"/> , - ' & . () 1	<input type="text" value="2"/> a A b B c C 2	<input type="text" value="3"/> d D e E f F 3
<input type="text" value="4"/> g G h H i I 4	<input type="text" value="5"/> j J k K l L 5	<input type="text" value="6"/> m M n N o O 6
<input type="text" value="7"/> p P q Q r R s S 7	<input type="text" value="8"/> t T u U v V 8	<input type="text" value="9"/> w W x X y Y z Z 9
<input type="text" value="*"/> *	<input type="text" value="0"/> 0	<input type="text" value="#"/> #

Making a call from the Directory

To make a call from the Directory:

1. Press .
2. Press or use the dial pad to find the item you want to dial out.
3. Lift the handset or press either or .
4. To end the call, hang up the handset or press .

Finding items in the Directory

To find items in the Directory:

1. To see the Directory heading, press **Directory**.
2. To see the listings that start with a particular letter, press the appropriate dial pad key. Then to see the other listings under that letter, press **↓**. (For example: **5** takes you to the first "J" listing, then **↓** takes you to the next "J" listing. **5 5** takes you to the first "K" listing.) Use the letter chart shown previously.
OR, to move down and up the list, press **↓** or **↑**. If you want to scroll steadily, press and hold **↓** or **↑**.
3. To leave the Directory at any time, press **Directory** or **Rls**.
Note: If you are on a call while you are viewing the Directory, pressing **Rls** also drops the call.

Editing in the Directory

To edit a number and/or name in the Directory:

1. Press **Directory**.
2. Press **↓** **↑** to find the item you want to edit.
3. To begin editing, press **←**.
4. If you do not want to change the number, go to step 5. To backspace and erase digits, press **←**. To add digits, use the dial pad.
5. Press **Save**.
6. If you don't want to change the name, go to step 7. To change or add to a name, use **←** and the dial pad. (See **Entering Names** on page 13.) If you edit the wrong item or want to quit without saving changes, press **Directory** or **Rls**.
7. Press **Save**.
8. Press **Rls**.

Deleting items from the Directory

To delete individual items:

1. Press **Directory**.
2. Press **↓** **↑** to find the item you want to delete.
3. Press **Delete** twice. You are still in the Directory.
4. Press **Rls** or **Directory** to exit the Directory at any time.

To delete all items:

1. Press **Directory**.
2. Press **Delete**.
3. Press **Delete** again to confirm deletion of the entire Directory.
4. Press **Rls**.

Callers List†

Using the Callers List

The 9316CW stores up to 50 calls in the Callers List. Your telephone logs the number (and name if available) of the caller, when they last called, and the number of times they tried to reach you. See **Callers List display messages** on page 26 for a description of the display messages and icons.

If the telephone number of the incoming call matches a number that you have programmed with a name in a memory key or the Directory, the Callers List shows the name first and then the number. You can choose to log either all incoming calls or only unanswered calls in the Callers List.

Setting up the Callers List

You can program the 9316CW to record only unanswered calls or all incoming calls. The default is to record all calls.

To change the Callers List:

1. Press the Set Options key.
2. Use \downarrow \uparrow to scroll to number 8 or press $\boxed{0}$ $\boxed{8}$ to go directly to the item.
3. Press \otimes to change the Callers List.

Finding an item in the Callers List

To find items in the Callers List:

1. To see the Callers List heading, press $\boxed{\text{Callers}}$.
2. To see the first new caller in the list, press \downarrow $\boxed{}$.
To move down and up the list, press \downarrow \uparrow .
If you want to scroll steadily, press and hold \downarrow \uparrow .
3. To leave the Callers List at any time, press $\boxed{\text{Callers}}$ or $\boxed{\text{Ris}}$.
Note: If you are on a call while viewing the Callers List, pressing $\boxed{\text{Ris}}$ drops the call.

Making a call from the Callers List

To dial a number in the Callers List:

1. Press $\boxed{\text{Callers}}$.
2. Use \downarrow \uparrow to find the number you want to dial.
3. Lift the handset or press either $\boxed{\text{Handsfree Mute}}$ or $\boxed{\text{Dial}}$.
4. To end the call, hang up the handset or press $\boxed{\text{Ris}}$.
Note: When you finish the call, the display returns to the Callers List.

If you call a number from the Callers List and you do not get connected, you may have to edit the number (for example, the number may be long distance and you may have to add "1"). See **Editing in the Callers List** on page 16.

† You must subscribe to your telephone company for the Calling Line Identification service.

Editing in the Callers List

To edit a number in the Callers List:

1. Press .
2. Use to find the number you want to edit.
3. Press any key on the dial pad to begin editing.
4. To add digits, use the dial pad. To erase one digit to the right of the cursor, press . To erase one digit to the left of the cursor, press .
- Caution:** The Callers List does not save changes. If you plan to call the number again, copy it to the Directory or a memory key.
5. To dial the edited number, lift the handset or press either or .

To have the Callers List show local numbers without the area code and internal numbers as extensions, see **Entering area codes** on page 22.

To dial back a long distance number in the Callers List:

1. Press .
2. Use to find the item you want to edit.
3. Using the dial pad, press and the area code if necessary.
4. To dial the edited number, lift the handset or press either or .
5. If you want to save the number to the directory, press . See **Saving numbers and names to the Directory** on page 12.

Saving Callers List numbers to the Directory or a Memory key

To copy a number from the Callers List to the Directory or to a memory key:

1. Press .
2. Use to find the number you want to copy.
3. Press .
4. Press or the memory key where you want to store the number.
5. If no name is displayed, you are prompted to enter one. To enter a name, use the dial pad. (See **Entering Names** on page 13.) If you do not want to enter a name, go to step 6.
6. Press .
7. To leave the Callers List at any time, press or .

Deleting from the Callers List

To delete a number in the Callers List:

1. Press .
2. Use to find the item you want to delete.
3. Press twice.
You are still in the Callers List.
4. To leave the Callers List at any time, press or .

To delete all numbers in the Callers List:

1. Press .
2. Press twice.
3. To leave the Callers List at any time, press or .

Memory keys

Saving numbers and names in memory keys

You can save the numbers and names of your customers, business associates, or anyone you call frequently in 9316CW's eight memory keys. You can store more numbers and names in the Directory. See the **Directory** on page 12 for more information.

To save a number and name:

1. Press .
2. Press the desired memory key.
3. Enter the number using the dial pad. You can enter a maximum of 24 digits.
Note: If you require a pause (for example, between a telephone number and an access code), press where you want the pause. Each pause is 2 seconds.
4. Press .
5. To skip the name, go to step 6. To enter a name, use the dial pad.
(See **Entering Names** on page 13.)
6. Press .
7. Label the memory key. (See the diagram on page 18.)

Saving from the display into memory keys

To save from the display:

1. Ensure that a number is on the display. (For example, answer a call or make a call using the dial pad, or use the Redial List or Callers List.)
2. Press .
3. Press the desired memory key. If the name was displayed with the number, both are now saved in the memory key.
4. If no name is displayed, you are prompted to enter one. If you do not want to enter a name, go to step 5. To enter a name, use the dial pad. (See **Entering Names** on page 13.)
5. Press .
6. Label the memory key. (See the diagram, **Labeling the memory keys** on page 18.)

Labeling the memory keys

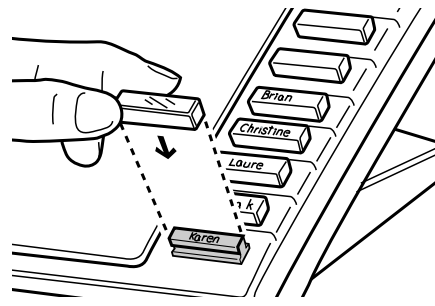
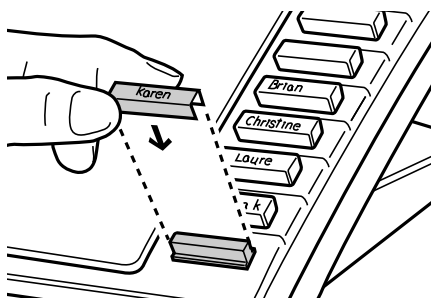

After programming the memory keys, label them with the supplied blank labels and key caps.[†]

Making calls from memory keys

To call from a memory key:

1. Lift the handset or press either or .
2. Press the memory key with the number you want to dial out.

To redial from a memory key:

1. Press the memory key with the number you want to dial out.
2. Lift the handset or press either or .

Note: If the Live dial pad option is turned on, you do not have to lift the handset or press any other button. Pressing the memory key will automatically dial the number and put the telephone in Handsfree mode.

Editing memory keys

To edit a memory key:

1. To see its contents, press the memory key.
2. Press .
3. If you do not want to change the number, go to step 4. To backspace and erase digits, press . To add digits, use the dial pad.
4. Press .
5. If you do not want to change the name, go to step 6. To add letters, use the dial pad. (See **Entering Names** on page 13.) To erase letters, press .
6. Press .

Note: The Live dial pad option must be turned off to edit memory keys. (See **Selecting the dial pad mode** on page 21.)

[†] Keep key caps and the sliding panel away from small children. These small parts may come off the telephone if it is dropped.

Deleting memory keys

To delete a memory key:

1. To see its contents, press the memory key.
2. To erase, press twice.

Note: The Live dial pad option must be turned off to edit memory keys. (See **Selecting the dial pad mode** on page 21.)

Saving features in memory keys[†]

For easy access, you can save the feature codes of telephone company services in your memory keys. This works well with network features such as Call Forwarding, Call Screen and Call Return. Some features require an On and Off code in two separate keys, while other features are stored on only one key. The following procedures show you how to save both On and Off codes.

To save a feature On code:

1. Press .
2. Press the desired memory key.
3. Enter the telephone company feature codes for turning the feature On.[†]
Read the display to confirm the number.
4. Press again.
5. Enter the feature name using the dial pad. (See **Entering Names** on page 13.)
6. Press again.
7. Label the memory key. (See the diagram on page 18.)

To save a feature Off code:

1. Press .
2. Press the desired memory key.
3. Enter the telephone company feature code for turning the feature Off.[†]
Read the display to confirm the number.
4. Press again.
5. Enter the feature name using the dial pad. (See **Entering Names** on page 13.)
6. Press again.
7. Label the memory key. (See the diagram on page 18.)

[†]**Note:** Contact your telephone company for the appropriate feature codes.

Using feature keys

When a memory key is programmed with a feature code, you can use the memory key to activate or deactivate the feature.

To turn a feature on or off:

1. Press the memory key where you stored the desired feature. The display shows the feature name and code.
 2. Lift the handset or press either or .
- The feature code is dialed out, which turns the feature on or off.

Note: If the Live dial pad option is turned on, you do not have to lift the handset or press any other button. Pressing the memory key will automatically dial the feature code and put the telephone in Handsfree mode.

[†] You must subscribe to your telephone company for Custom Calling Features.

Saving a feature and light in memory keys

You can make the set indicator light come on when you turn a feature on and go off when you turn that same feature off. You can only do this with one feature, and the feature must have separate On and Off codes (such as Call Forwarding).

For example, you may want the light to remind you that you have turned Call Forwarding on. To do this, use one key to turn the indicator light on when you activate the feature. Use the second key to turn the indicator light off when you deactivate that same feature. The following procedure shows you how to program a FeatureLight On and Off key.

To save a FeatureLight On key:

1. Press . Do NOT select a memory key yet.
2. To program the light on, press .
3. Press the desired memory key.
4. Enter the telephone company feature code for turning the feature on.†
5. Press .
6. Read the display to confirm the number.
7. Label the memory key.
(See the diagram on page 18.)

To save a FeatureLight Off key:

1. Press . Do NOT select a memory key yet.
2. To program the light off, press .
3. Press the desired memory key.
4. Enter the telephone company feature code for turning the feature off.†
5. Press .
6. Read the display to confirm the number.
7. Label the memory key.
(See the diagram on page 18.)

†**Note:** Contact your telephone company for the appropriate feature codes.

Using FeatureLight keys

To turn a feature and light on or off:

1. Press the memory key where you stored the FeatureLight.
The display shows **FeatureLight ON** or **FeatureLight OFF**.
 2. Lift the handset or press either or .
- The feature and light turn on or off. (When the feature and light are on and you are not using the telephone, the display shows **Feature ON** as a reminder.)

Advanced Features

Adding a timer key

You can program any of the memory keys to be a Timer key.

To add a timer key:

1. Press the Set Options key.
2. Use to scroll to number 4, or press to go directly to the item.
3. Press to add a Timer key.
4. Press a memory key.
5. Press .
6. Label the Timer key. (See the diagram on page 18.)

Using the call timer

The timer key is used to time the length of a call.

To show the timer on the display:

1. Make or answer a call. The timer starts running automatically.
2. Once on the call, press the Timer key. The display shows the running time of the call. Press the Timer key to see the date and time.
3. When the call is over, hang up the handset or press . The timer stops counting.

Note: To show the elapsed time of the most recent call (or last call) when you are not on a call, press the Timer key.

Deleting a timer key

To delete the timer key:

1. Press the timer key.
2. Press twice.

Selecting the dial pad mode

When you select the dial pad mode, you are turning the Live dial pad option on or off. With Live dial pad on, the telephone automatically dials out and turns on Handsfree as soon as you press a dial pad key or a memory key. When Live dial pad is off, the telephone is in regular or predial mode. This means after you dial the telephone number you must lift the handset or press either or before the telephone number is dialed.

To select the dial pad mode:

1. Press the Set Options key.
2. Use to scroll to number 5 or press to go directly to the item.
3. Press to change the dial pad mode.
4. Press .

Entering area codes

When you enter an area code or prefix using this feature, your 9316CW telephone will remove that code or prefix from incoming numbers that are logged in the Callers List. For example, if you enter your area code into this option, all calls in your area code will appear in the Callers List with the area code stripped off (the area code will appear in brackets after the number). This may make it easier to identify local calls. You can enter three separate area codes or prefixes, each up to seven digits long.

To enter area codes and prefixes:

1. Press the Set Options key.
2. Use to scroll to number 7 or press to go directly to the item.
3. Press .
4. Enter the area code or prefix and press .
Repeat this step for each area code or prefix you want to enter.
5. Press .

To delete or change an area code or prefix:

1. Press the Set Options key.
2. Use to scroll to number 7 or press to go directly to the item.
3. Press . The first area code is displayed. If this is the number you want to delete or change, go to step 5.
4. Press until you see the number you want to change or delete.
5. Press - 6. Press .
- 7. Press .

The Security Numbers feature

The 9316CW is equipped with a Security Numbers feature to keep selected numbers private when you dial. When you have entered a secure number using this option, your telephone does not display or store the digits that you dial after that secure number. Instead, the numbers that follow the secure number are replaced with the * symbol on the display. You can secure up to five 12-digit numbers.

For example, Joe enters 291-9000 as a secure number through the Set Options list. His Voice Mail number is 1234 and his password is 5678. To access his messages, Joe dials 291-9000 1234 5678. Because the Voice Mail number and password follow the secure number, the display shows 291-9000 *****, and Joe's password is not displayed on the screen or stored in the Redial List. For more information on the Redial List, refer to **Using the Redial List** on page 7.

To enter a security number:

1. Press the Set options key.
2. Use to scroll to number 9 or press to go directly to the item.
3. Press .
4. Using the dial pad, enter the security number.
5. Press to end.
Repeat steps 3 and 4 for each secure number you want to enter.
6. Press .

To delete or change a security number:

1. Press the Set options key.
2. Use to scroll to number 9 or press to go directly to the item.
3. Press .
4. Press until you find the number you want to change or delete.
5. Press to backspace and simply delete the secure number, or delete the secure number and use the dial pad to enter the changed number.
6. Press .
7. Press .

Display messages and lights

The 9316CW has a back-lit three-line display that uses icons and messages to give you call information.

The Callers List screen

A sample Callers List screen is shown below.

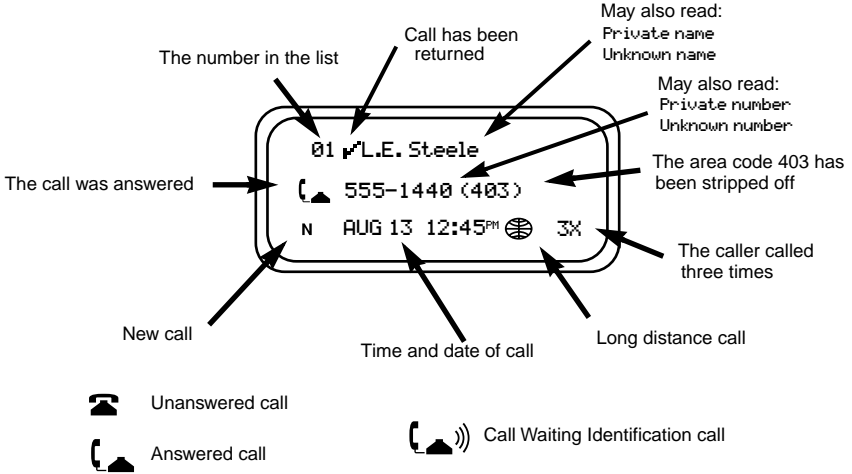

Knowing when you have a Voice Mail message

The 9316CW's set indicator light lets you know that your Voice Mail system has a message for you. The set indicator light flashes slowly and the display shows **Message Waiting** after your Voice Mail has received a call. Contact your local telephone company to find out how you can subscribe to Message Waiting (Voice Mail) services.

Clear Message Waiting







There may be times when **Message Waiting** appears on the display when there are no more voice messages. You can turn the display message off using the Clear Message Waiting feature.

To clear message waiting:





1. Press the Set Options key.
2. Use [Down] [Up] to scroll to number 6, or press [0] [6] to go directly to the item.
3. Press [X] to clear message waiting.
4. Press [Ris].

Note: This only applies when you subscribe to Voice Mail services from your telephone company.

General display messages

Message	What it means
Check line cord	If there is no dial tone, make sure the line cord and handset cord are attached securely.
Directory empty Use SAVE to add	The Directory remains empty until you add numbers and names to it.
Directory full No changes made	The Directory has a 50 entry limit. If you want to add an item, delete an item you no longer use.
Extension in use	An extension telephone is using the same line that you want to use. Wait until the message disappears before making your call.
Feature ON	The FeatureLight On key has been pressed and the code dialed out. To turn off the feature and the light, press the FeatureLight Off key and lift the handset or press either  or  .
<Forwarded call	The call is forwarded from another telephone.
Key is locked	The memory key is factory-programmed and cannot be erased or reprogrammed. Program a different memory key.
	The caller is calling from outside your local area. Long distance dialing is required to return the call.
Message Waiting	Your Voice Mail service has received a call for you. To subscribe to voice mail service contact your telephone company.
Private number or Private name	The caller has requested that the telephone company not deliver the number or name.
Redial list is empty	This appears if you press  before making any calls on your telephone or if power has been interrupted.
Ringer is OFF	The ringer volume is turned off. To turn the ringer ON; without lifting the handset, press the right side of the volume bar.
Unknown name or Unknown number	The name or number is unavailable from the telephone company.
XX New Callers	When you are not on the telephone and not in the Callers List, the display shows you how many callers have been added to the list since you last checked it.
>...xxxxxxxxxxxxxxxxx ...xxxxxxxxxxxxxxxxx	The telephone number is longer than the display. The display shows ... and 14 or 15 digits of the number depending on whether the phone is on or off hook.
	Indicates an incoming call.
	Indicates that the phone is off hook.
	Indicates an incoming Call Waiting call.

Callers List display messages

Message	What it means
Callers List is empty	Your telephone does not record incoming calls until you subscribe to Calling Line Identification service. If you do subscribe, you have not received any calls in the list yet or you have deleted all numbers in the Callers List.
Bumped calls=XX	XX is the number of old calls automatically removed to make room for incoming new calls in the Callers List. The limit is 50 calls.
<Forwarded	The call is forwarded from another location.
	The caller has called from outside your local area. Long distance dialing is required to return the call.
Private number or Private name	The caller has requested that the telephone company not deliver the number or name.
Unknown name or Unknown number	The name or number is unavailable from the telephone company.
N MAR 04 3:30pm 2x	N means a new call.
...xxxxxxxxxxxxxxxxxxx	... means the number is longer than the display.
01 ✓ Unknown Name	✓ means you have returned the call from the Callers List.
	Indicates an unanswered call in the Callers List
	Indicates an answered call in the Callers List
	Indicates a Call Waiting call in the Callers List
R Smith 123-456-7890 MAR 04 3:30pm 2x	2x means this caller has called twice. The display shows the date and time of the last call from that caller.

Learning about the lights

The 9316CW's set indicator light also alerts you when another extension is on the line, the telephone rings, a call is on hold, a feature is on, or the ringer is off. There is a small red light beside  to show you the status of handsfree and mute.

Set indicator light messages



Feature	Light
Call is on hold	Indicator light flashes quickly.
Extension in use	Set indicator light is on.
Feature ON	Set indicator light is on.
Message Waiting [†]	Set indicator light flashes slowly.
Ringer is OFF	Set indicator light is off.
Visual Ringing	Set indicator light flashes very quickly.

[†]You must subscribe to Voice Mail services from your telephone company for this feature to work.

Handsfree indicator light messages

Feature	Light
Call is on Handsfree	Handsfree/Mute indicator light is on.
Microphone is muted	Handsfree/Mute indicator light flashes quickly.

Viewing multiple display and light messages

When you are not using the telephone, several messages can be active at any time, such as date and time, ✕ **New Callers**, **Feature ON**, **Message Waiting**, **Ringer is OFF** and **Check line cord**. When more than one of these messages is active, the display shows the most recent message and an arrow beside it (e.g., **1 New Caller →**). You can view the other messages by pressing . Each time you press , the display shows the next active message and its associated light.

Troubleshooting

The display is in an alternate language.

You can change the display language using the Set Options key. See **Changing the display language** on page 10 for more information.

The cursor does not move when saving in the Directory.

The number or name is too long. Numbers can be no longer than 24 digits and names can be no longer than 16 characters.

You cannot save a Directory number into a memory key.

You cannot save Directory items into memory keys. Once you are in the Directory,

can only add an item to the Directory.

Callers are not identified on the display.

Let the telephone ring at least twice before answering. If that does not work, you may not have Calling Line Identification service. To subscribe, contact your local telephone company.

The Callers List is empty.

Until you subscribe to Calling Line Identification service, your telephone does not record incoming calls.

You cannot dial a number in the Callers List.

The caller may have an unknown number. If there is a number, you may have to edit it before you can dial it.

You cannot hear a caller or be heard.

Make sure the handset cord is inserted securely into the jack and make sure the receiver volume is high enough.

There is no information on the display and the ringer volume is low.

Make sure the power adaptor is connected to a working electrical outlet.

The power is out and the display is blank.

9316CW still operates as a regular telephone during a power failure. You can dial using the dial pad and you can receive calls, but the other keys and the display do not operate until the power is restored.

The display works but you can't hear a dial tone.

Your telephone lines may be wired differently from the telephone jack. To have a service person correct the wiring, contact your local telephone company.

The telephone wobbles.

Check that the handset cord is placed in the channel between the stand and the telephone. See the illustration on page 5.

You cannot program a memory key.

Some of the memory keys may be factory-programmed. These keys are locked and cannot be erased or reprogrammed.

Call Waiting Identification information is not being displayed.

Make sure that the Call Waiting Identification information option is enabled, and that you have subscribed to a Call Waiting ID[†] service.

You are unable to call back from the Callers List.

The Callers List will record the area code of any call, including local calls. You need to take the area code out when dialing numbers from the Callers List.

How do you answer Call Waiting?

To answer a Call Waiting call, press . You may have to subscribe to a Call Waiting[†] service to use this feature.

You can view regular Caller ID information, so why can't you see who is calling on Call Waiting?

Ensure that the Call Waiting Identification option (option 10) is on, and that you have subscribed to a Call Waiting ID[†] service from your telephone company. Also note that you will not receive Call Waiting ID when an extension is in use.

[†] The actual name for this service may differ in your area. Please consult your local telephone company for information.

Index

A

Area codes 22

C

Call Display

see Calling Line Identification

Call Waiting Identification 8

see also Link

turning display of on/off 10

Call Waiting Tone

see Call Waiting Identification

Callers List 6, 15

deleting in 17

dialing long distance 16

display messages 26

editing 16

finding items 15

making a call 15

saving to the Directory 16

setting the list mode 17

Calling from

Callers List 15

Directory 13

memory keys 18

Calling Line Identification 6, 8, 9, 10, 15,
26, 28

Calls 6

Call Waiting 8

holding 6

muting 7

redial list 7

Connecting

fax or modem 4

handset cord 4

line cord 4

power adaptor 4

Contrast key 2

Cords

see Connecting

D

Date and time 10

Deleting

area codes 22

Directory items 14

items in the callers list 17

memory key 19

Redial list 7

security numbers 23

timer key 21

Dial pad mode

selecting 21

Dialing

long distance 16

Directory 12

deleting items 14

editing 14

entering names 13

finding items 14

key 2

making a call from 13

saving numbers and names 12

Display language

changing 10

Display messages

Callers List 26

general 25

E

Editing

area codes 22

Callers List 16

Directory items 14

memory keys 18

security number 23

F

Feature Light keys

saving Feature Light OFF 20

saving Feature Light ON 20

using 20

H

Handsfree 7

Helpful Hints

See Troubleshooting

Hold

putting a call on hold 6

taking a call off hold 6

I

Installation 4

L

Language

see Display language 10

Left arrow key 2

Letters

entering 13

Link

Calling Line Identification 8

key 3

Live Dial Pad mode 21

Index

Long distance 16

M

Memory keys 17

- deleting 19
- editing 18
- labeling 18
- making calls 18
- predialing from 18
- saving a feature and light 20
- saving features 19
- saving from the display 17
- saving numbers and names 17
- trouble shooting 28

Mute 7

N

Names

- entering 13

O

Options list 3

P

Pause 2

- inserting in a number 17

R

Redial list 7

- making a call 7

Release key 3

Right arrow key 2

Ring tone 11

- setting 11

S

Save key 2

Saving

- a number to the Directory 12
- feature codes to memory keys 19
- Feature In Use light 20
- from Callers List to Directory or memory key 16
- to memory keys 17

Scroll key 2

Security Numbers feature 23

Set Options list 3

T

Timer key 21

- adding 21
- deleting 21
- using 21

Troubleshooting 28

V

Volume 11

- receiver 11
- ringer 11
- speaker 11
- turning the ringer on/off 11

GENERAL INQUIRIES

If you have read the guide and you still have questions, call 1-800-574-1611 in Canada and the USA. In other areas, contact your telephone company.

Free Manuals Download Website

<http://myh66.com>

<http://usermanuals.us>

<http://www.somanuals.com>

<http://www.4manuals.cc>

<http://www.manual-lib.com>

<http://www.404manual.com>

<http://www.luxmanual.com>

<http://aubethermostatmanual.com>

Golf course search by state

<http://golfingnear.com>

Email search by domain

<http://emailbydomain.com>

Auto manuals search

<http://auto.somanuals.com>

TV manuals search

<http://tv.somanuals.com>