



Your Reliable Partner

# **IS7 Series**

**(IS7-G, IS7, IS7-E, IS7-E2, IS7-E2G,  
IS7-E2V, IS7-M, IS7-V2)**

---

***Intel Pentium 4 System Board  
Socket 478***

***User's Manual***

**4200-0375-11  
Rev. 1.06**

---

---

## **Copyright and Warranty Notice**

The information in this document is subject to change without notice and does not represent a commitment on part of the vendor, who assumes no liability or responsibility for any errors that may appear in this manual.

No warranty or representation, either expressed or implied, is made with respect to the quality, accuracy or fitness for any particular part of this document. In no event shall the manufacturer be liable for direct, indirect, special, incidental or consequential damages arising from any defect or error in this manual or product.

Product names appearing in this manual are for identification purpose only and trademarks and product names or brand names appearing in this document are the property of their respective owners.

This document contains materials protected under International Copyright Laws. All rights reserved. No part of this manual may be reproduced, transmitted or transcribed without the expressed written permission of the manufacturer and authors of this manual.

If you do not properly set the motherboard settings, causing the motherboard to malfunction or fail, we cannot guarantee any responsibility.

---

---

# Table Of Contents

---

<b>Chapter 1. Introduction .....</b>	<b>1-1</b>
1-1. Features & Specifications .....	1-1
1-2. Layout Diagram (IS7-G/IS7/IS7-E).....	1-4
1-3. Layout Diagram (IS7-E2/IS7-E2G/IS7-E2V).....	1-5
1-4. Layout Diagram (IS7-M) .....	1-6
1-5. Layout Diagram (IS7-V2).....	1-7
<b>Chapter 2. Hardware Setup.....</b>	<b>2-1</b>
2-1. Install The Motherboard.....	2-1
2-2. Install Pentium® 4 CPU and Heatsink Supporting-Base.....	2-2
2-3. Install System Memory .....	2-3
2-4. Connectors, Headers and Switches .....	2-6
(1). ATX Power Input Connectors.....	2-6
(2). FAN Power Connectors .....	2-7
(3). CMOS Memory Clearing Header .....	2-8
(4). Wake-up Header.....	2-9
(5). Front Panel Audio Connection Header .....	2-10
(6). Front Panel Switches & Indicators Headers .....	2-12
(7). Infrared Device Header.....	2-14
(8). Additional IEEE1394 Port Headers .....	2-15
(9). Additional USB Port Headers.....	2-16
(10). System Management Bus Headers.....	2-17
(11). Internal Audio Connectors .....	2-18
(12). Accelerated Graphics Port Slot.....	2-20
(13). Floppy Disk Drive Connector.....	2-21
(14). IDE Connectors.....	2-22
(15). Serial ATA Connectors.....	2-23
(16). Status Indicator .....	2-25
(17). Back Panel Connectors .....	2-27
<b>Chapter 3. BIOS Setup.....</b>	<b>3-1</b>
3-1. SoftMenu Setup.....	3-2
3-2. Standard CMOS Features.....	3-4
3-3. Advanced BIOS Features.....	3-7
3-4. Advanced Chipset Features.....	3-10
3-5. Integrated Peripherals .....	3-12
3-6. Power Management Setup .....	3-19

---

---

3-7.	PnP/PCI Configurations.....	3-22
3-8.	PC Health Status .....	3-24
3-9.	Load Fail-Safe Defaults .....	3-25
3-10.	Load Optimized Defaults .....	3-25
3-11.	Set Password .....	3-25
3-12.	Save & Exit Setup .....	3-25
3-13.	Exit Without Saving.....	3-25
<i>Appendix A.</i>	<i>Install Intel Chipset Software Utility.....</i>	<i>A-1</i>
<i>Appendix B.</i>	<i>Install Intel Application Accelerator RAID (IS7-G, IS7) .....</i>	<i>B-1</i>
<i>Appendix C.</i>	<i>Install Audio Driver .....</i>	<i>C-1</i>
<i>Appendix D.</i>	<i>Install LAN Driver .....</i>	<i>D-1</i>
<i>Appendix E.</i>	<i>Install Silicon Serial ATA RAID Driver (IS7-G) .....</i>	<i>E-1</i>
<i>Appendix F.</i>	<i>Install VGA Driver (IS7-M) .....</i>	<i>F-1</i>
<i>Appendix G.</i>	<i>Install USB 2.0 Driver .....</i>	<i>G-1</i>
<i>Appendix H.</i>	<i>ABIT EQ (The Hardware Doctor Utility).....</i>	<i>H-1</i>
<i>Appendix I.</i>	<i>FlashMenu (BIOS Update Utility).....</i>	<i>I-1</i>
<i>Appendix J.</i>	<i>Troubleshooting (Need Assistance?).....</i>	<i>J-1</i>
<i>Appendix K.</i>	<i>How to Get Technical Support .....</i>	<i>K-1</i>

---

# Chapter 1. Introduction

---

## 1-1. Features & Specifications

---

### 1. CPU

- Supports Intel Pentium 4 Socket 478 processor with 800MHz, 533MHz, and 400MHz (for Northwood only) System Data Bus
- Supports Intel Hyper-Threading Technology

### 2. Chipset

- Intel 82865PE (MCH) + 82801ER (ICH5R) (*IS7-G/IS7*)
- Intel 82865PE (MCH) + 82801EB (ICH5) (*IS7-E/IS7-E2/IS7-E2G/IS7-E2V*)
- Intel 82865G (MCH) + 82801EB (ICH5) (*IS7-M*)
- Intel 82848P (MCH) + 82801EB (ICH5) (*IS7-V2*)
- Supports Hi-Speed Universal Serial Bus (USB 2.0)
- Supports Ultra ATA/100/66/33 mode
- Integrated Intel “**Extreme Graphics 2**” graphics controller (*IS7-M*)

### 3. Memory

- Supports 4 DIMM single/dual channel DDR 400/333/266 (Max. 4GB) (*IS7-G/IS7/IS7-E/IS7-M*)
- Supports 2 DIMM single/dual channel DDR 400/333/266 (Max. 2GB) (*IS7-E2/IS7-E2G/IS7-E2V*)
- Supports 2 DIMM single channel DDR 400/333/266 (Max. 2GB) (*IS7-V2*)

### 4. AGP

- Accelerated Graphics Port connector supports AGP 8X/4X Interface (0.8V/1.5V)

### 5. LAN

- Onboard 10/100/1000M LAN Controller (*IS7-G/IS7-E2G*)
- Onboard 10/100M LAN Controller (*IS7/IS7-E/IS7-M/IS7-E2/IS7-V2*)

### 6. Serial ATA RAID

- Onboard 2 channels of Serial ATA 150MB/s data transfer rate with RAID function (RAID 0/RAID 1) via ICH5R South Bridge (*IS7-G/IS7*)
- Onboard 2 channels of Serial ATA 150MB/s data transfer rate with RAID function (RAID 0/RAID 1) via Silicon Image PCI Chip (*IS7-G*)
- Onboard 2 channels of Serial ATA 150MB/s data transfer rate via ICH5 South Bridge (*IS7-E/IS7-M/IS7-E2/IS7-E2G/IS7-E2V/IS7-V2*)

### 7. USB 2.0

- 8x USB 2.0 ports support 480 Mb/s data transfer rate

### 8. IEEE 1394

- Supports IEEE 1394a at 400/200/100 Mb/s data transfer rate (*IS7-G/IS7*)

## 9. Audio

- Onboard 6-Channel AC 97 CODEC
- Professional digital audio interface supports S/PDIF In/Out (*IS7-G/IS7/IS7-E*)

## 10. ABIT Engineered

- ABIT SoftMenu™ Technology
- ABIT EQ™ (*IS7-G/IS7/IS7-E/IS7-E2/IS7-M/IS7-V2*)
- ABIT FANEQ™ (*IS7-G/IS7/IS7-E/IS7-M/IS7-E2*)
- ABIT FlashMenu™

## 11. Internal I/O Connectors

- 1x AGP slot
- 5x PCI slots
- 1x Floppy port supports up to 2.88MB
- 2x Ultra ATA/100/66/33 connectors
- 4x Serial ATA 150 connectors (*IS7-G*)
- 2x Serial ATA 150 connectors (*IS7/IS7-E/IS7-M/IS7-E2/IS7-E2G/IS7-E2V/IS7-V2*)
- 2x USB 2.0 headers
- 2x IEEE 1394a headers (*IS7-G/IS7*)
- 1x FP-Audio header
- 1x CD-IN header
- 1x AUX-IN header (*IS7-G/IS7/IS7-E/IS7-M*)
- 1x IrDA header (*IS7-G/IS7/IS7-E/IS7-M*)

## 12. Back Panel I/O

- 1x PS/2 Keyboard, 1x PS/2 mouse
- 1x Serial port connectors, 1x Parallel port connector
- 1x S/PDIF In connector (*IS7-G/IS7/IS7-E*)
- 1x S/PDIF Out connector (*IS7-G/IS7/IS7-E*)
- 1x VGA Out connector (*IS7-M*)
- 1x AUDIO1 connector
- 1x AUDIO2 connector (*IS7-G/IS7/IS7-E/IS7-M*)
- 2x USB 2.0, 1x IEEE 1394 Connector (*IS7-G/IS7*)
- 2x USB 2.0 Connectors (*IS7-E/IS7-M/IS7-E2/IS7-E2G/IS7-E2V/IS7-V2*)
- 2x USB 2.0, 1x RJ-45 LAN Connector

## 13. Miscellaneous

- ATX form factor
- Hardware Monitoring – including Fan Speed, Voltages, CPU and system temperature
- Supports Wake Up by LAN, Modem Ring, RTC Alarm, Keyboard and Mouse Power On
- Supports STR (Suspend to RAM)

**14. Order Information**

<b>Model</b>	<b>Chipset</b>	<b>LAN</b>	<b>SB SATA</b>	<b>PCI SATA</b>	<b>IEEE 1394</b>
IS7-G	865PE + ICH5R	10/100/1000M	RAID 0/1	RAID 0/1	3 Ports
IS7	865PE + ICH5R	10/100M	RAID 0/1	-	3 Ports
IS7-E	865PE + ICH5	10/100M	2 Ports	-	-
IS7-E2	865PE + ICH5	10/100M	2 Ports	-	-
IS7-E2G	865PE + ICH5	10/100/1000M	2 Ports	-	-
IS7-E2V	865PE + ICH5	-	2 Ports	-	-
IS7-M	865G + ICH5	10/100M	2 Ports	-	-
IS7-V2	848P + ICH5	10/100M	2 Ports	-	-

\* Specifications and information contained herein are subject to change without notice.

## 1-2. Layout Diagram (IS7-G/IS7/IS7-E)

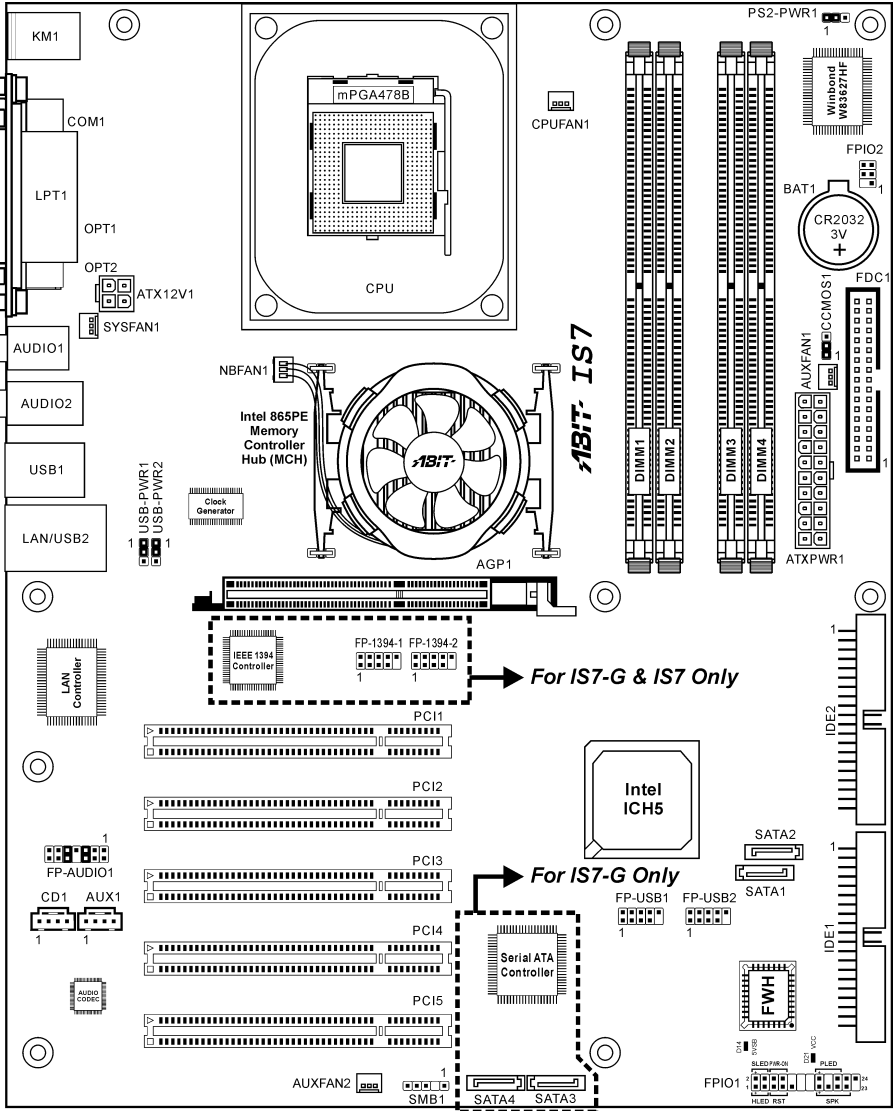



### 1-3. Layout Diagram (IS7-E2/IS7-E2G/IS7-E2V)

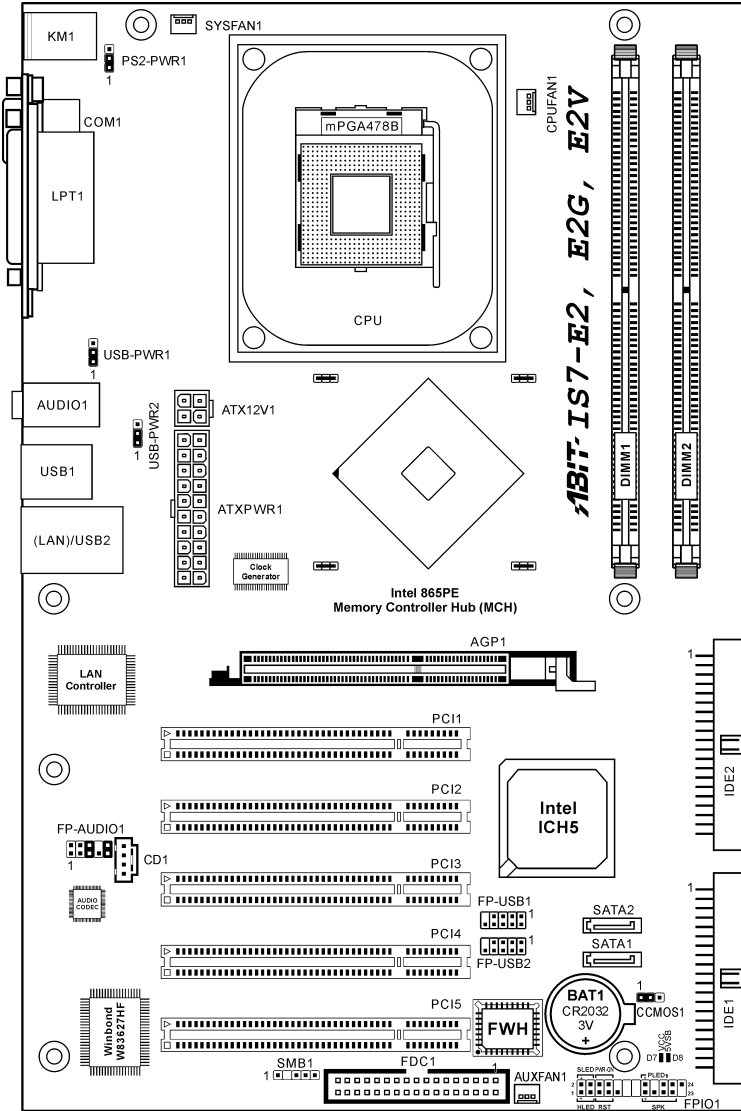

### 1-4. Layout Diagram (IS7-M)

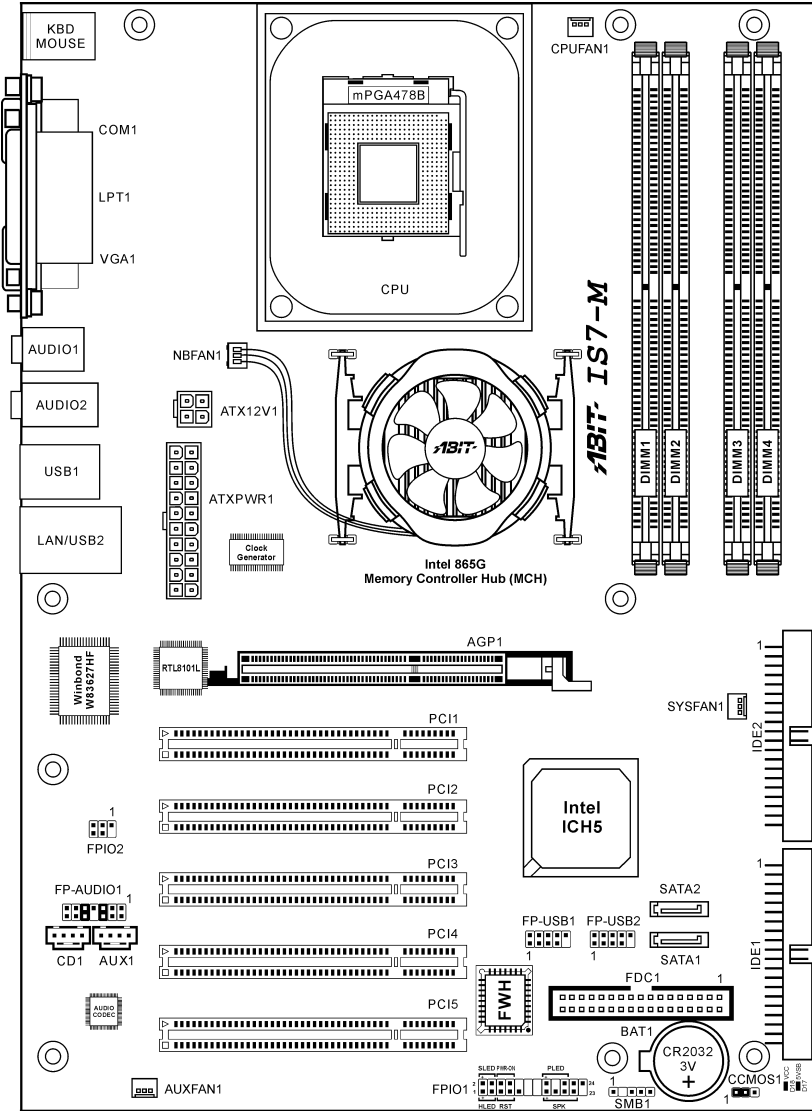

# 1-5. Layout Diagram (IS7-V2)

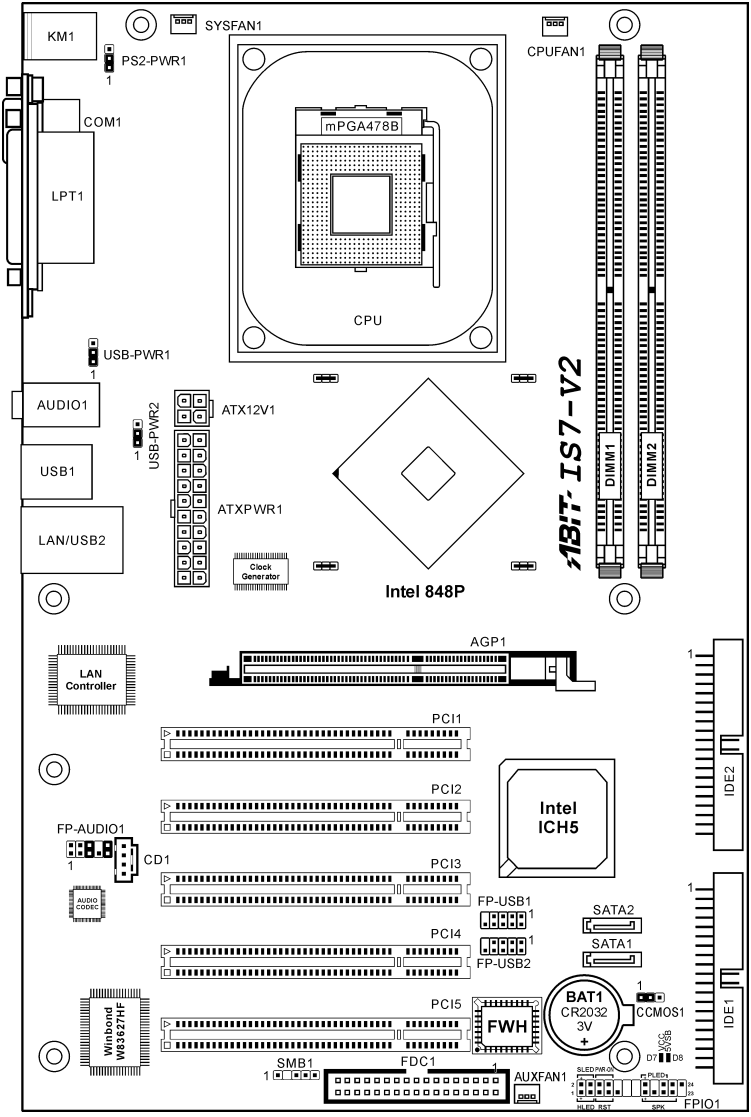



## Chapter 2. Hardware Setup

**Before the Installation:** Turn off the power supply switch (fully turn off the +5V standby power), or disconnect the power cord before installing or unplugging any connectors or add-on cards. Failing to do so may cause the motherboard components or add-on cards to malfunction or damaged.

### 2-1. Install The Motherboard

Most computer chassis have a base with many mounting holes to allow motherboard to be securely attached on and at the same time, prevented from short circuits. There are two ways to attach the motherboard to the chassis base:

1. use with studs
2. or use with spacers

In principle, the best way to attach the board is to use with studs. Only if you are unable to do this should you attach the board with spacers. Line up the holes on the board with the mounting holes on the chassis. If the holes line up and there are screw holes, you can attach the board with studs. If the holes line up and there are only slots, you can only attach with spacers. Take the tip of the spacers and insert them into the slots. After doing this to all the slots, you can slide the board into position aligned with slots. After the board has been positioned, check to make sure everything is OK before putting the chassis back on.

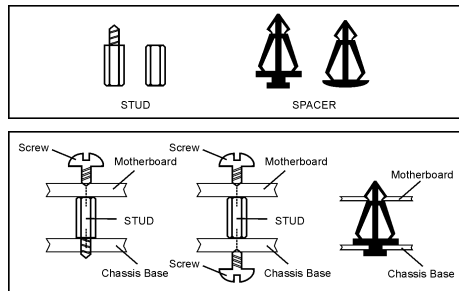

**ATTENTION:** To prevent shorting the PCB circuit, please REMOVE the metal studs or spacers if they are already fastened on the chassis base and are without mounting-holes on the motherboard to align with.

## 2-2. Install Pentium® 4 CPU and Heatsink Supporting-Base

This motherboard provides a ZIF (Zero Insertion Force) Socket 478 to install Intel® Pentium® 4 CPU. The CPU you bought should have a kit of heatsink and cooling fan along with. If that's not the case, buy one specially designed for Pentium® 4 Socket 478.

1. Locate the 478-pin ZIF socket on the motherboard. Fasten the Retention Module Base onto the motherboard.

**ATTENTION:** If you are using chassis specially designed for Pentium® 4, please pay attention to the location of metal studs or spacers if they are already installed on the chassis. Be careful not let the metal studs or spacers contact the printed circuit wire or parts on the PCB.

2. Pull the CPU socket lever sideways away from the socket and then upwards to 90 degree. Insert the CPU with the correct orientation. Do not use extra force to insert CPU; it only fits in one orientation. Close down the socket lever while holding down the CPU.
3. Put the heatsink faces down onto the CPU until it completely covers the CPU.
4. Put the Fan and Retention Mechanism Assembly onto the heatsink. Make sure all the four Retention Locks at each side of the Fan and Retention Mechanism Assembly snap into the Retention Holes.
5. Push down the Retention Lock at both sides of the Fan and Retention Mechanism Assembly to lock up together with the Retention Module Base.
6. The Fan and Retention Mechanism Assembly and Retention Module Base should now firmly lock up with each other with the heatsink inside.

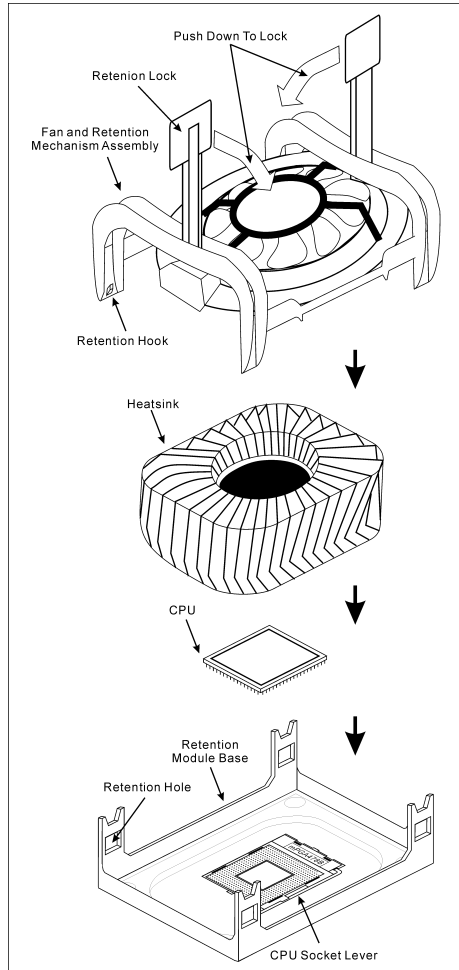

**ATTENTION:** Do not forget to set the correct bus frequency and multiple for your processor.

## 2-3. Install System Memory

### IS7-G/IS7/IS7-E/IS7-M:

This motherboard provides four 184-pin DDR DIMM slots for Single/Dual Channel DDR 400/333/266 memory modules with memory expansion size up to 4GB.

To reach the performance of Dual Channel DDR, the following rules must be obeyed:

- **When installing TWO DIMM modules:** Install DIMM modules of the same type and size for slots [DIMM1]+[DIMM3] or slots [DIMM2]+[DIMM4].
- **When installing FOUR DIMM modules:** Install DIMM modules of the same type and size for slots [DIMM1]+[DIMM3], and slots [DIMM2]+[DIMM4].

#### IS7-G/IS7/IS7-E:

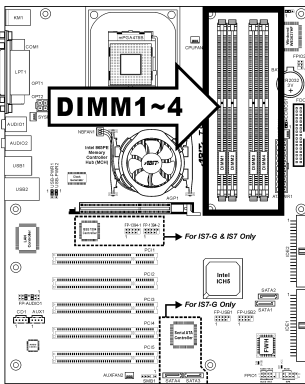

#### IS7-M:

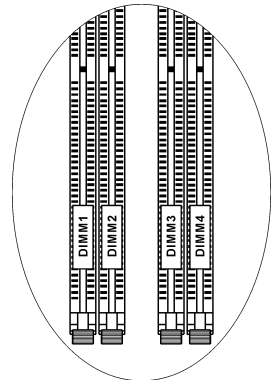
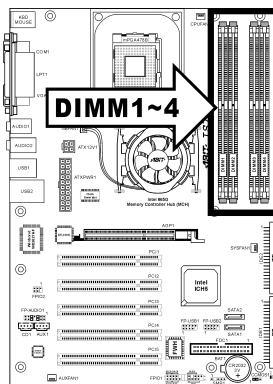

Bank	Memory Module	Total Memory
Bank 0, 1 (DIMM1)	128, 256, 512MB, 1GB	128MB ~ 1GB
Bank 2, 3 (DIMM2)	128, 256, 512MB, 1GB	128MB ~ 1GB
Bank 4, 5 (DIMM3)	128, 256, 512MB, 1GB	128MB ~ 1GB
Bank 6, 7 (DIMM4)	128, 256, 512MB, 1GB	128MB ~ 1GB
<b>Total System Memory</b>		128MB ~ 4GB

**IS7-E2/IS7-E2G/IS7-E2V/IS7-V2:**

This motherboard provides 2 184-pin DDR DIMM sites for memory expansion available from minimum 128MB to maximum 2GB.

**IS7-E2/IS7-E2G/IS7-E2V:**

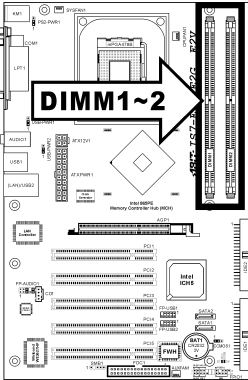

**IS7-V2:**

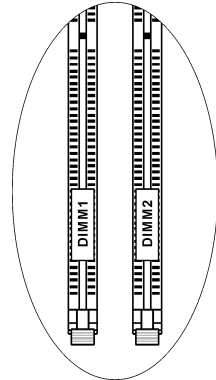
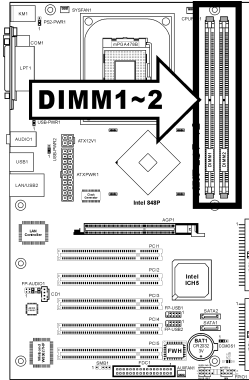

Bank	Memory Module	Total Memory
Bank 0, 1 (DIMM1)	128, 256, 512MB, 1GB	128MB ~ 1GB
Bank 2, 3 (DIMM2)	128, 256, 512MB, 1GB	128MB ~ 1GB
<b>Total System Memory</b>		128MB ~ 2GB

**NOTE:** No hardware or BIOS setup required after adding or removing memory modules.



Power off the computer and unplug the AC power cord before installing or removing memory modules.

1. Locate the DIMM slot on the board.
2. Hold two edges of the DIMM module carefully, keep away of touching its connectors.
3. Align the notch key on the module with the rib on the slot.
4. Firmly press the module into the slots until the ejector tabs at both sides of the slot automatically snaps into the mounting notch. Do not force the DIMM module in with extra force as the DIMM module only fit in one direction.

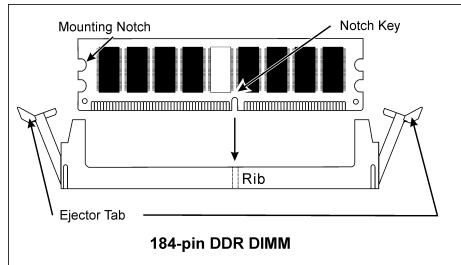

5. To remove the DIMM modules, push the two ejector tabs on the slot outward simultaneously, and then pull out the DIMM module.

**ATTENTION:** Static electricity can damage the electronic components of the computer or optional boards. Before starting these procedures, ensure that you are discharged of static electricity by touching a grounded metal object briefly.

## 2-4. Connectors, Headers and Switches

Here we will show you all of the connectors, headers and switches, and how to connect them. Please read the entire section for necessary information before attempting to finish all the hardware installation inside the computer chassis. A complete enlarged layout diagram is shown in Chapter 1 for all the position of connectors and headers on the board that you may refer to.

**WARNING:** Always power off the computer and unplug the AC power cord before adding or removing any peripheral or component. Failing to do so may cause severe damage to your motherboard and/or peripherals. Plug in the AC power cord only after you have carefully checked everything.

### (1). ATX Power Input Connectors

This motherboard provides two power connectors to connect to an ATX12V power supply with 300W, 20A +5VDC, and 720mA +5VSB capacity at least.

IS7-G/IS7/IS7-E:

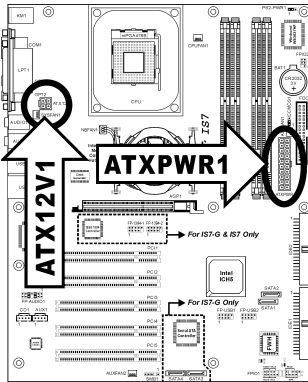

IS7-M:

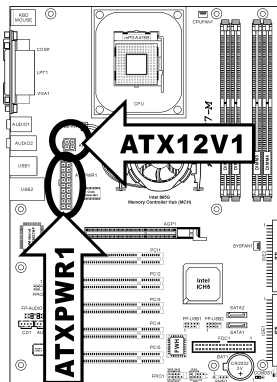

IS7-E2/IS7-E2G/IS7-E2V:

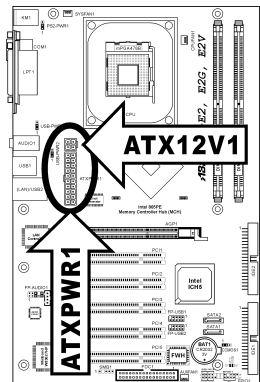

IS7-V2:

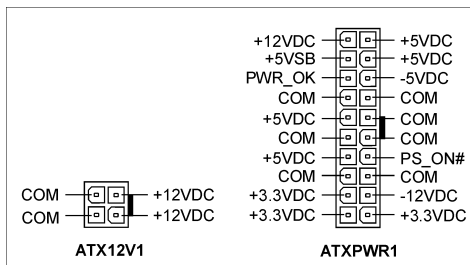
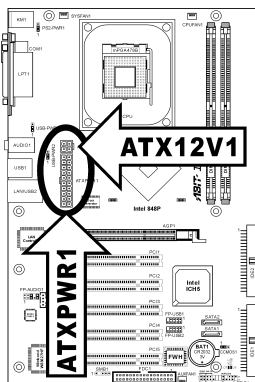

**(2). FAN Power Connectors**

These 3-pin connectors each provide power to the cooling fans installed in your system.

The CPU must be kept cool by using a powerful fan with heatsink. The system is capable of monitoring the speed of the CPU fan.

- **CPUFAN1:** CPU Fan Power Connector
- **NBFAN1:** Chipset Fan Power Connector
- **SYSFAN1:** System Fan Power Connector
- **AUXFAN1, AUXFAN2:** Auxiliary Fan Power Connector

**WARNING:** These fan connectors are not jumpers. DO NOT place jumper caps on these connectors.

**IS7-G/IS7/IS7-E:**

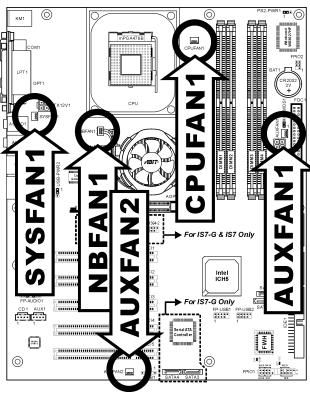

**IS7-M:**

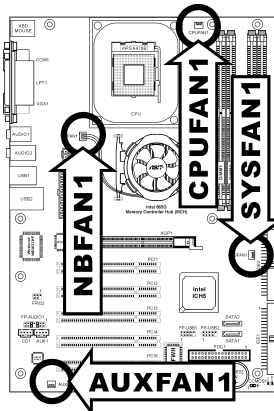

**IS7-E2/IS7-E2G/IS7-E2V:**

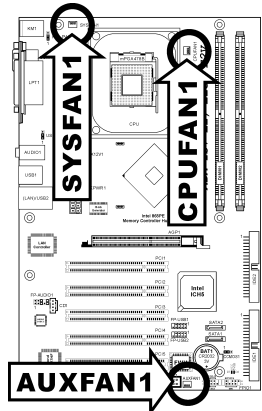

**IS7-V2:**

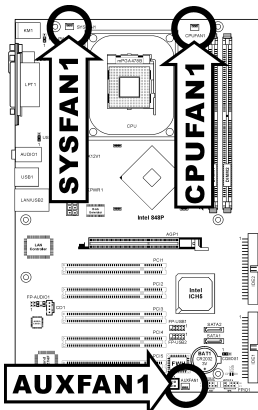

**(3). CMOS Memory Clearing Header**

This header uses a jumper cap to clear the CMOS memory.

- **Pin 1-2 shorted (default):** Normal operation.
- **Pin 2-3 shorted:** Clear CMOS memory.

**IS7-G/IS7/IS7-E:**

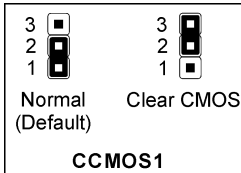
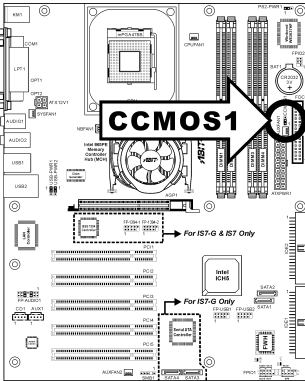

**IS7-M:**

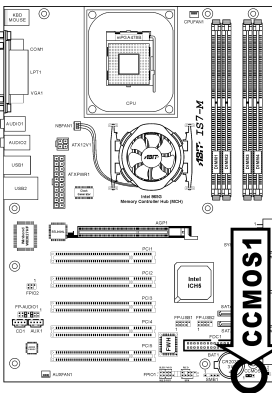

**IS7-E2/IS7-E2G/IS7-E2V:**

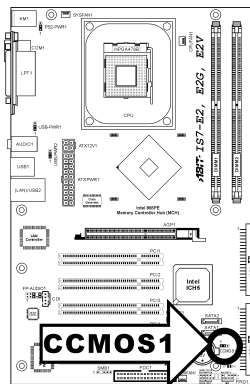

**IS7-V2**

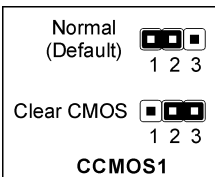
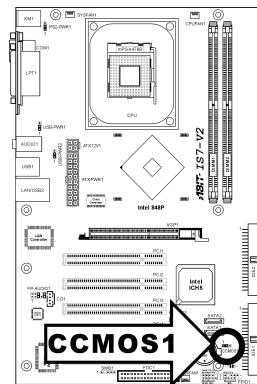

**WARNING:** Turn the power off first (including the +5V standby power) before clearing the CMOS memory. Failing to do so may cause your system to work abnormally or malfunction.

**(4). Wake-up Header**

These headers use a jumper cap to enable/disable the wake-up function.

- PS2-PWR1:**  
 Pin 1-2 shorted (default): Disable wake-up function support at Keyboard/Mouse port.  
 Pin 2-3 shorted: Enable wake-up function support at Keyboard/Mouse port
- USB-PWR1:**  
 Pin 1-2 shorted (default): Disable wake-up function support at USB1 port.  
 Pin 2-3 shorted: Enable wake-up function support at USB1 port.
- USB-PWR2:**  
 Pin 1-2 shorted (default): Disable wake-up function support at USB2 port.  
 Pin 2-3 shorted: Enable wake-up function support at USB2 port

**IS7-G/IS7/IS7-E:**

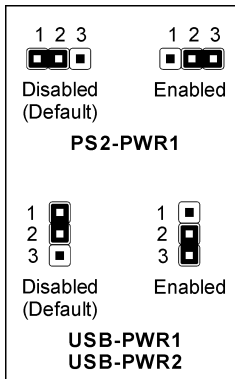
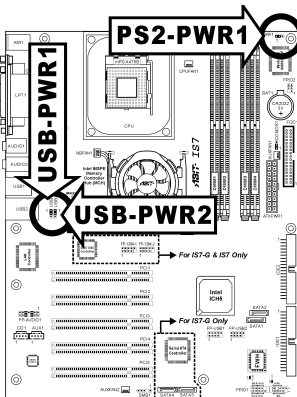

**IS7-E2/IS7-E2G/IS7-E2V:**

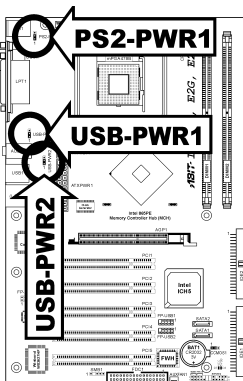

**IS7-V2**

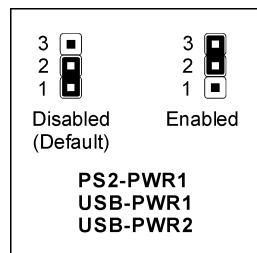
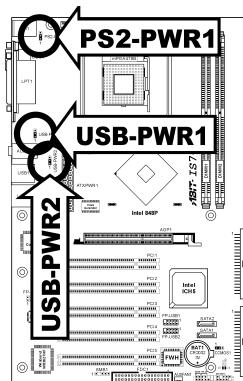

**(5). Front Panel Audio Connection Header**

This header provides the connection to audio connector at front panel.

- To use the audio connector at front panel, remove all the jumpers on this header, and then connect to front panel by the extension cable provided with the chassis.
- To use the audio connector at rear panel, disconnect the extension cable, attach the jumpers back at pin 5-6, and pin 9-10 (default setting).

**IS7-G/IS7/IS7-E:**

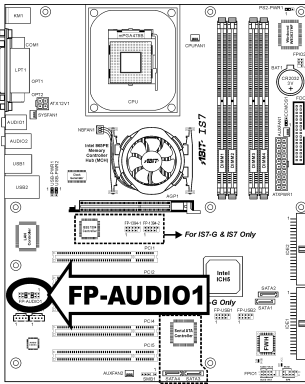

**IS7-M:**

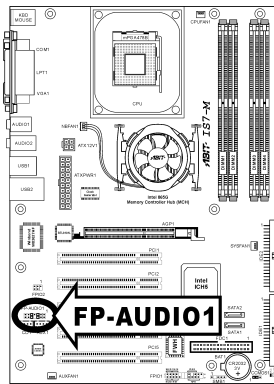

<p><b>FP-AUDIO1</b></p>	Pin	Pin Assignment	Pin	Pin Assignment
	1	Audio Mic.	2	Ground
	3	Audio Mic. Bias	4	VCC
	5	Speaker Out Right Channel	6	Speaker Out Right Channel Return
	7	X	8	NC
	9	Speaker Out Left Channel	10	Speaker Out Left Channel Return
	11	Ground	12	S/PDIF In
13	VCC	14	S/PDIF Out	

**IS7-E2/IS7-E2G/IS7-E2V:**

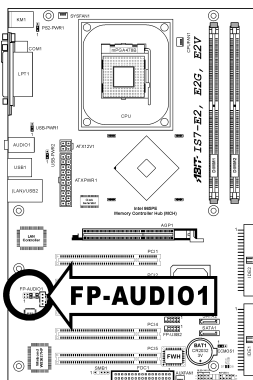

**IS7-V2**

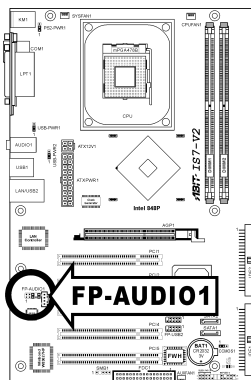

<p><b>FP-AUDIO1</b></p>	Pin	Pin Assignment	Pin	Pin Assignment
	1	Audio Mic.	2	Ground
	3	Audio Mic. Bias	4	VCC
	5	Speaker Out Right Channel	6	Speaker Out Right Channel Return
	7	X	8	NC
	9	Speaker Out Left Channel	10	Speaker Out Left Channel Return

**(6). Front Panel Switches & Indicators Headers**

This header is used for connecting switches and LED indicators on the chassis front panel.

Watch the power LED pin position and orientation. The mark “+” align to the pin in the figure below stands for positive polarity for the LED connection. Please pay attention to connect these headers. A wrong orientation will only cause the LED not lighting, but a wrong connection of the switches could cause system malfunction.

**IS7-G/IS7/IS7-E:**

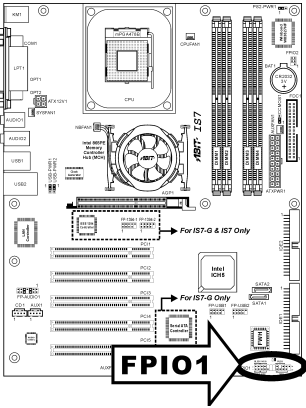

**IS7-M:**

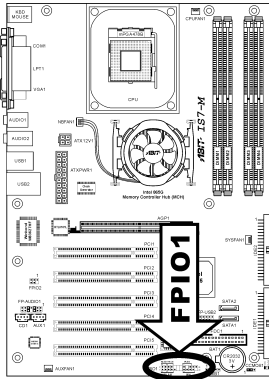

**IS7-E2/IS7-E2G/IS7-E2V:**

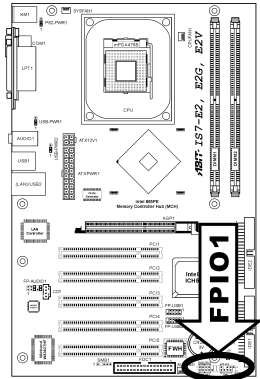

**IS7-V2:**

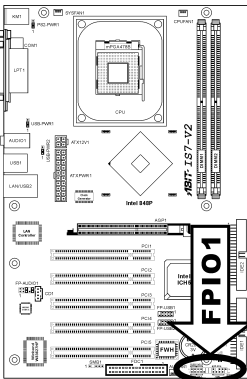



- **HLED (Pin 1, 3):**  
Connects to the HDD LED cable of chassis front panel.
- **RST (Pin 5, 7):**  
Connects to the Reset Switch cable of chassis front panel.
- **SPK (Pin 15, 17, 19, 21):**  
Connects to the System Speaker cable of chassis.
- **SLED (Pin 2, 4):**  
Connects to the Suspend LED cable (if there is one) of chassis front panel.
- **PWR-ON (Pin 6, 8):**  
Connects to the Power Switch cable of chassis front panel.
- **PLED (Pin 16, 18, 20):**  
Connects to the Power LED cable of chassis front panel.

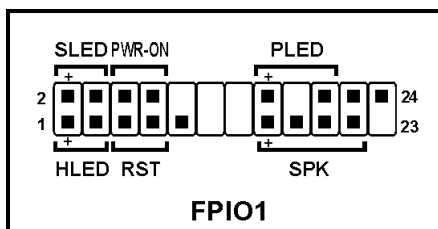

**(7). Infrared Device Header**

This header connects to an optional IR device attached to chassis. This motherboard supports standard IR transfer rates.

**IS7-G/IS7/IS7-E:**

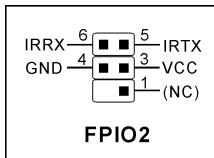
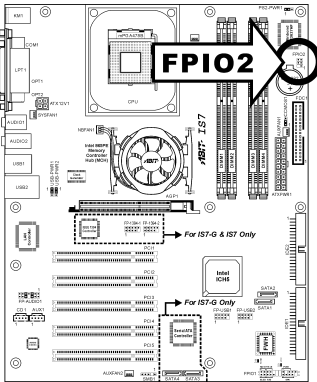

**IS7-M:**

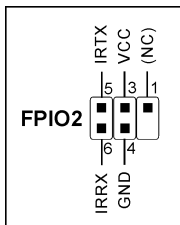
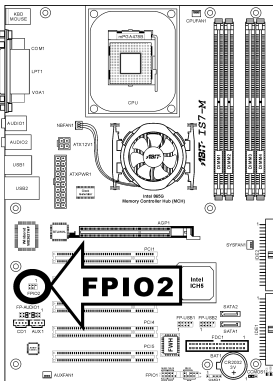

**(8). Additional IEEE1394 Port Headers**

These headers each provide one additional IEEE1394 port connection through an extension cable and bracket.

**IS7-G/IS7:**

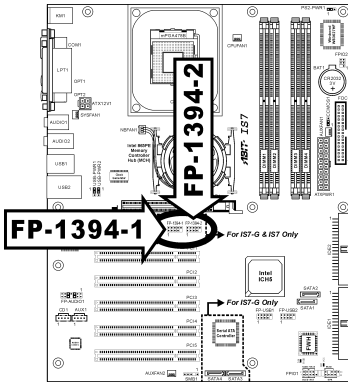

Pin	Pin Assignment	Pin	Pin Assignment
1	TPA0 +	2	TPA0 -
3	GND	4	GND
5	TPB0 +	6	TPB0 -
7	+12V	8	+12V
9	NC	10	GND

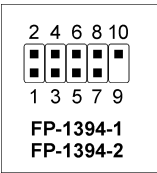

**(9). Additional USB Port Headers**

These headers each provide 2 additional USB 2.0 ports connection through an USB cable designed for USB 2.0 specifications.

**IS7-G/IS7/IS7-E:**

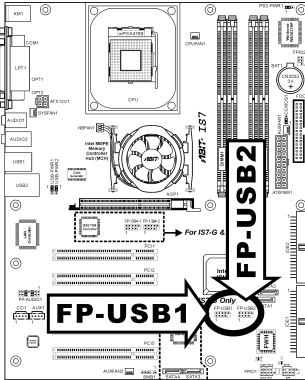

**IS7-M:**

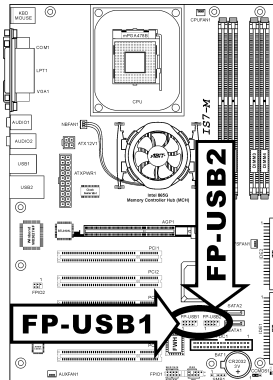

**IS7-E2/IS7-E2G/IS7-E2V:**

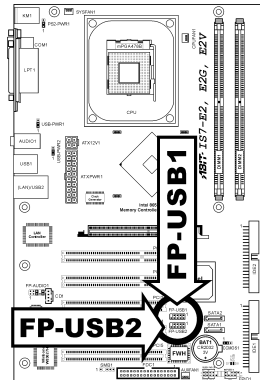

**IS7-V2:**

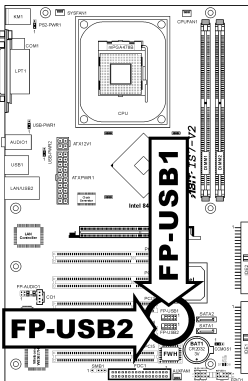

IS7-G/IS7/IS7-E/IS7-M	IS7-E2/IS7-E2G/ IS7-E2V/IS7-V2	Pin	Pin Assignment	Pin	Pin Assignment
		1	VCC	2	VCC
		3	Data0 -	4	Data1 -
		5	Data0 +	6	Data1 +
		7	Ground	8	Ground
		9	NC	10	NC

**(10). System Management Bus Headers**

This header is reserved for system management bus (SM bus). The SM bus is a specific implementation of an I<sup>2</sup>C bus. I<sup>2</sup>C is a multi-master bus, which means that multiple chips can be connected to the same bus and each one can act as a master by initiating a data transfer. If more than one master simultaneously tries to control the bus, an arbitration procedure decides which master gets priority.

**IS7-G/IS7/IS7-E:**

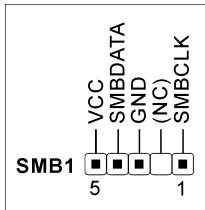
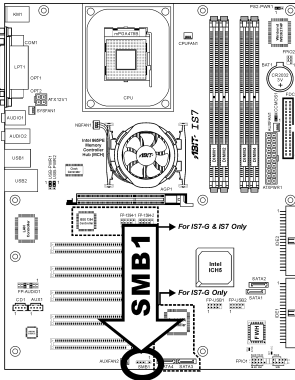

**IS7-M:**

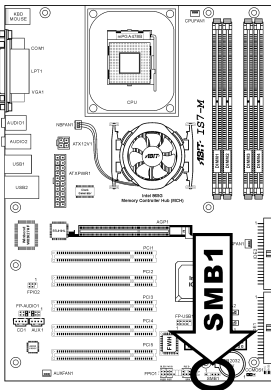

**IS7-E2/IS7-E2G/IS7-E2V:**

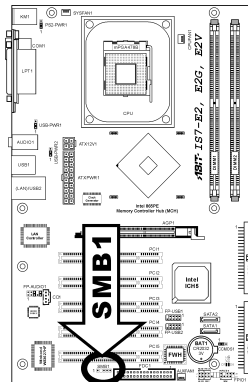

**IS7-V2:**

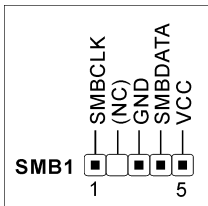
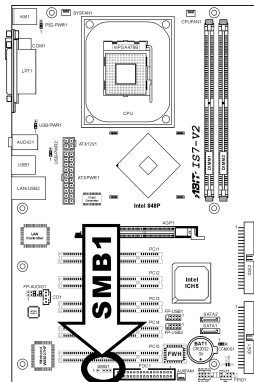

**(11). Internal Audio Connectors**

These connectors connect to the audio output of internal CD-ROM drive or add-on card.

**IS7-G/IS7/IS7-E:**

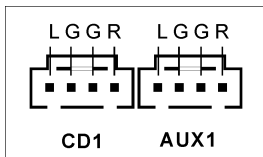
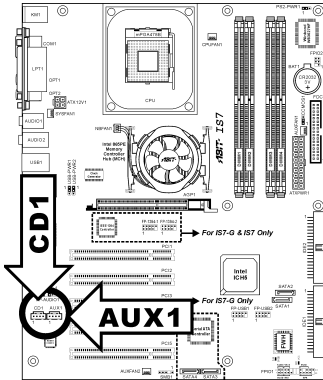

**IS7-M:**

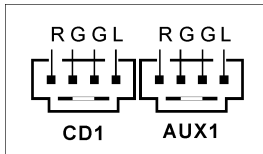
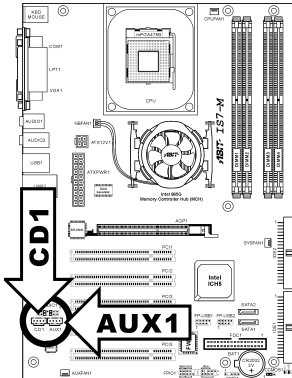

IS7-E2/IS7-E2G/IS7-E2V:

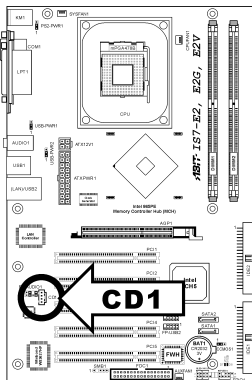

IS7-V2:

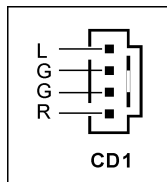
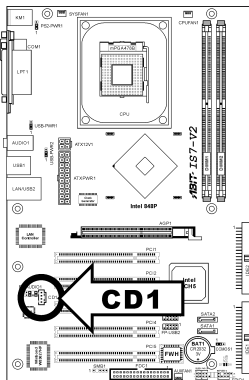

**(12). Accelerated Graphics Port Slot**

This slot supports an optional AGP graphics card up to AGP 4X/8X mode.

**ATTENTION:** This motherboard does not support 3.3V AGP cards. Use only 1.5V or 0.8V AGP cards.

**IS7-G/IS7/IS7-E:**

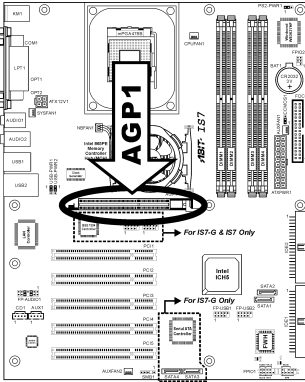

**IS7-M:**

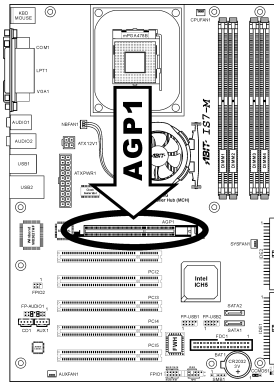

**IS7-E2/IS7-E2G/IS7-E2V:**

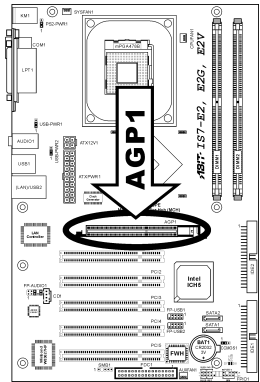

**IS7-V2:**

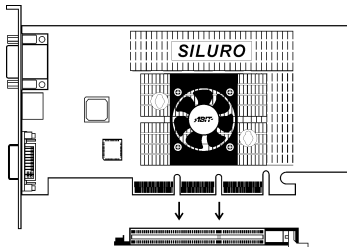
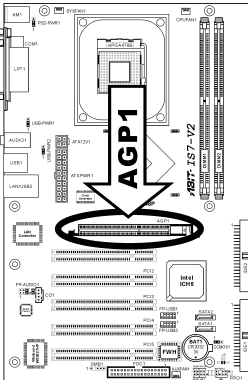



**(13). Floppy Disk Drive Connector**

This connector supports two standard floppy disk drives via a 34-pin 34-conductor ribbon cable.

Connecting the Floppy Disk Drive Cable:

1. Install one end of the ribbon cable into the FDC1 connector. The colored edge of the ribbon cable should be aligned with pin-1 of FDC1 connector.
2. Install the other end(s) of ribbon cable into the disk drive connector(s). The colored edge of the ribbon cable should be also aligned with pin-1 of disk drive connector. The endmost connector should be attached to the drive designated as Drive A.

**IS7-G/IS7/IS7-E:**

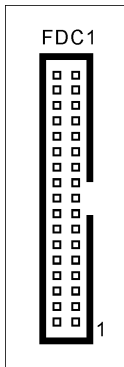
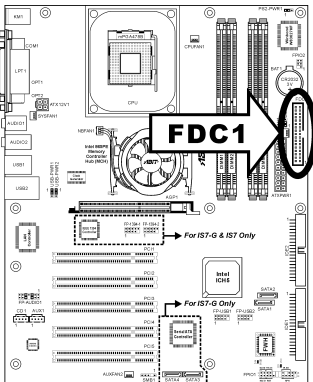

**IS7-M/IS7-E2/IS7-E2G/  
IS7-E2V/IS7-V2:**

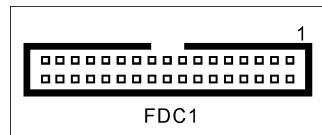

**IS7-M:**

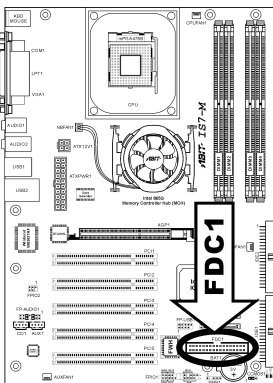

**IS7-E2/IS7-E2G/IS7-E2V:**

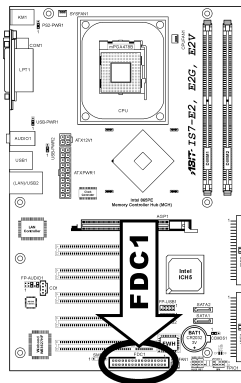

**IS7-V2:**

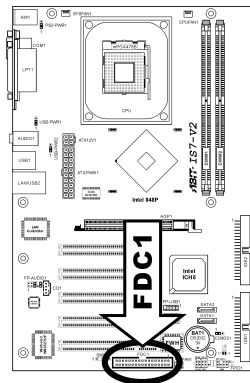

**(14). IDE Connectors**

**IS7-G/IS7/IS7-E:**

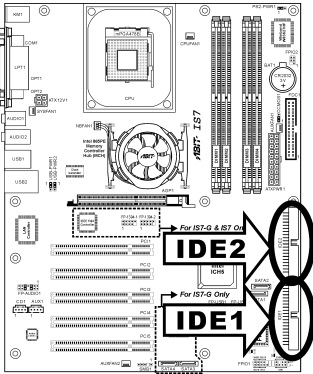

**IS7-M:**

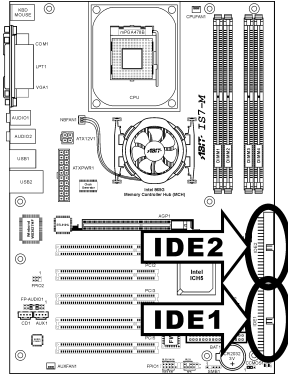

**IS7-E2/IS7-E2G/IS7-E2V:**

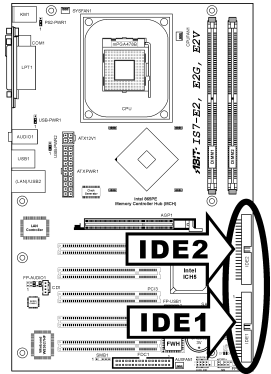

**IS7-V2:**

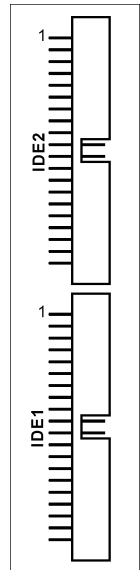
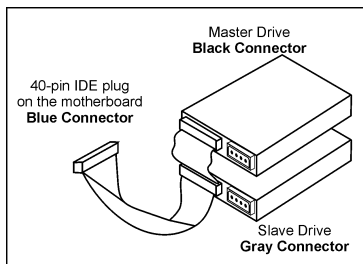
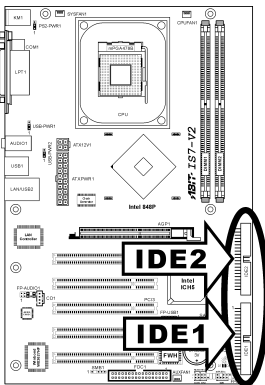

This motherboard provides two IDE ports to connect up to four IDE drives at Ultra ATA/100 mode by Ultra ATA/66 ribbon cables. Each cable has 40-pin 80-conductor and three connectors, providing two hard drives connection with motherboard. Connect the single end (blue connector) at the longer length of ribbon cable to the IDE port on motherboard, and the other two ends (gray and black connector) at the shorter length of the ribbon cable to the connectors on hard drives.

If you want to connect two hard drives together through one IDE channel, you must configure the second drive to Slave mode after the first Master drive. Please refer to the drives' documentation for jumper settings. The first drive connected to IDE1 is usually referred to as "Primary Master", and the second drive as "Primary Slave". The first drive connected to IDE2 is referred to as "Secondary Master" and the second drive as "Secondary Slave".

Keep away from connecting one legacy slow speed drive, like CD-ROM, together with another hard drive on the same IDE channel; this will drop your integral system performance.

**(15). Serial ATA Connectors**

These connectors are provided to attach one Serial ATA device at each channel via Serial ATA cable.

**IS7-G/IS7/IS7-E: (SATA3 and SATA4 are for IS7-G only)**

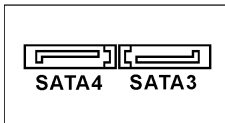
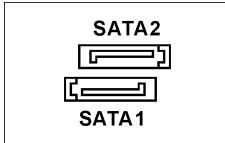
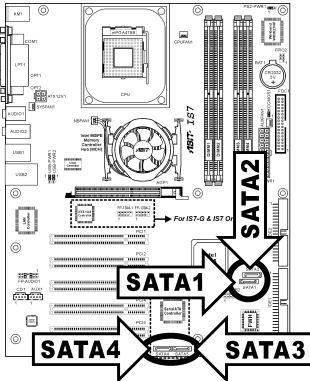

**IS7-M:**

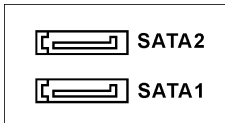
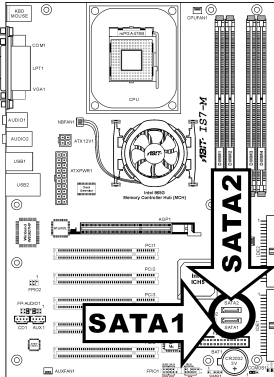

**IS7-E2/IS7-E2G/IS7-E2V:**

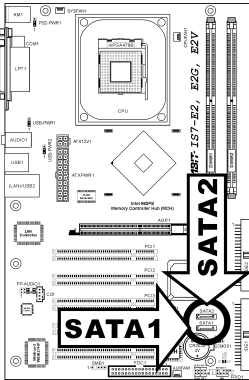

**IS7-V2:**

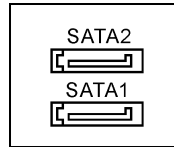
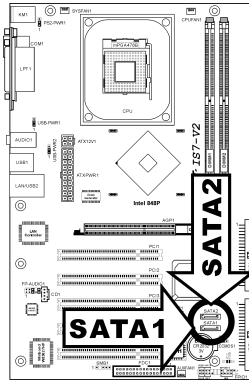

SATA1 and SATA2 are controlled by South Bridge. To enable the SATA1 and SATA2 controller, you have to enable the item “OnChip Serial ATA” first in the BIOS menu of “OnChip IDE Device”.

The following table displays the quantity of devices at IDE1, IDE2, SATA1 and SATA2 channel under different “OnChip Serial ATA” configuration:

**WinXP / Windows .NET Server:**

OnChip Serial ATA / OnChip Serial ATA Mode	IDE1	IDE2	SATA1	SATA2
Enhanced Mode / IDE	2	2	1	1

**DOS / Win2K / Win98 / WinME:**

OnChip Serial ATA / OnChip Serial ATA Mode	IDE1	IDE2	SATA1	SATA2
Combined Mode / IDE	0	2	1	1
	2	0	1	1
SATA Only / IDE	0	0	1	1
Disabled	2	2	0	0

**For IS7-G:** SATA3 and SATA4 are controlled by Silicon Image PCI Chip. To enable the SATA3 and SATA4 controller, you have to enable the item “Serial ATA Controller” first in the BIOS menu of “Onboard PCI Device”.

For more information on how to configure the function mode for SATA1 and SATA2, please refer to the item “Serial ATA 1 Mode” and “Serial ATA 2 Mode” in the BIOS menu of “OnChip IDE Device”.

**(16). Status Indicator**

- **5VSB:** This LED lights up when the power supply is connected with power source.
- **VCC:** This LED lights up when the system power is on.

**IS7-G/IS7/IS7-E:**

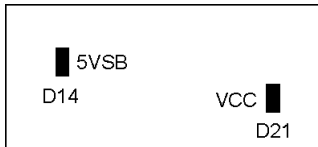
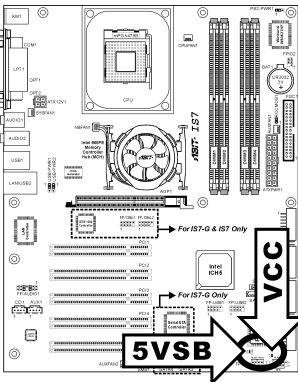

**IS7-M:**

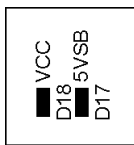
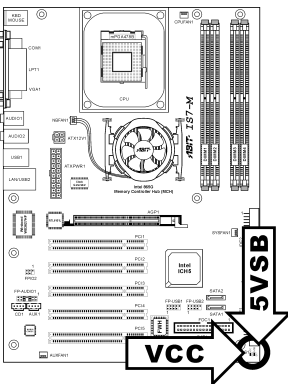

**IS7-E2/IS7-E2G/IS7-E2V:**

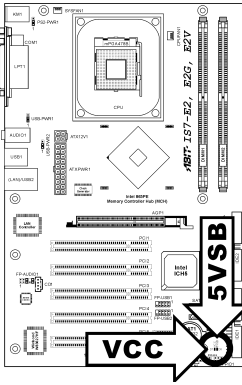

**IS7-V2:**

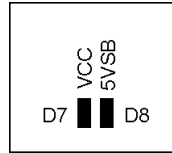
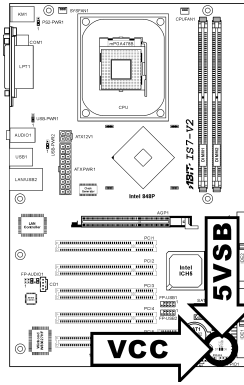

(17). **Back Panel Connectors**

**IS7-G/IS7/IS7-E:**

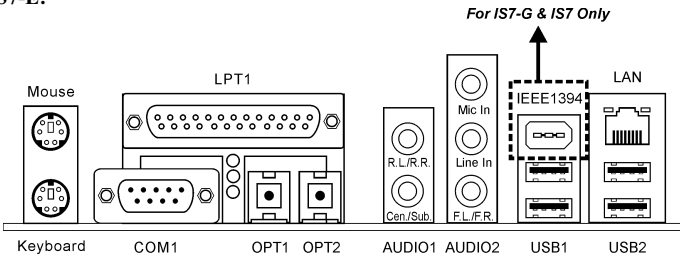

**IS7-M:**

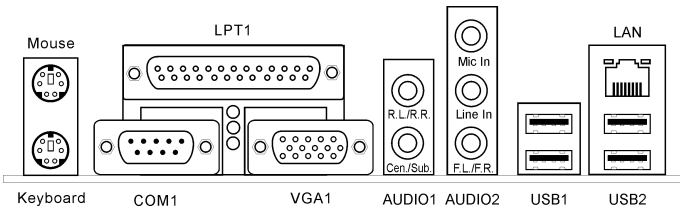

**IS7-E2/IS7-E2G/IS7-V2:**

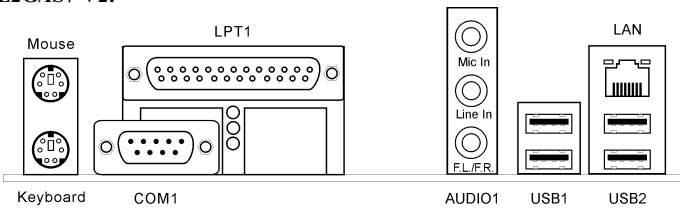

**IS7-E2V:**

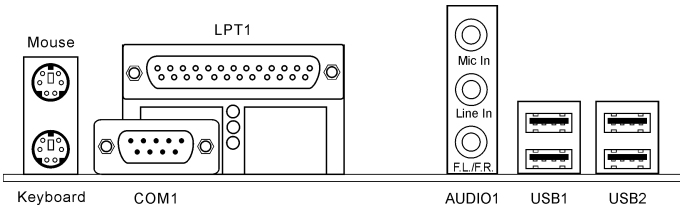

- **Mouse:** Connects to PS/2 mouse.
- **Keyboard:** Connects to PS/2 keyboard.
- **LPT1:** Connects to printer or other devices that support this communication protocol.
- **COM1:** Connects to external modem, mouse or other devices that support this communication protocol.
- **OPT1:** This connector provides an S/PDIF-In connection through optical fiber to digital multimedia devices. *(IS7-G/IS7/IS7-E)*
- **OPT2:** This connector provides an S/PDIF-Out connection through optical fiber to digital multimedia devices. *(IS7-G/IS7/IS7-E)*
- **VGA1:** Connects to monitor input. *(IS7-M)*
- **AUDIO1: (IS7-G/IS7/IS7-E/IS7-M)**  
**R.L./R.R. (Rear Left / Rear Right):** Connects to the rear left and rear right channel in the 5.1 channel audio system.  
**Cent./Sub. (Center / Subwoofer):** Connects to the center and subwoofer channel in the 5.1 channel audio system.
- **AUDIO1: (IS7-E2/IS7-V2)**  
**Mic In:** Connects to the plug from external microphone.  
**Line In:** Connects to the line out from external audio sources.  
**F.L./F.R. (Front Left / Front Right):** Connects to the front left and front right channel in the 5.1-channel or regular 2-channel audio system.
- **AUDIO2: (IS7-G/IS7/IS7-E/IS7-M)**  
**Mic In:** Connects to the plug from external microphone.  
**Line In:** Connects to the line out from external audio sources.  
**F.L./F.R. (Front Left / Front Right):** Connects to the front left and front right channel in the 5.1-channel or regular 2-channel audio system.
- **IEEE1394:** Connects to devices of IEEE1394 protocol. *(IS7-G/IS7)*
- **LAN:** Connects to Local Area Network. *(IS7-G/IS7/IS7-E/IS7-E2/IS7-E2G/IS7-M/IS7-V2)*
- **USB1/USB2:** Connects to USB devices such as scanner, digital speakers, monitor, mouse, keyboard, hub, digital camera, joystick etc.



## Chapter 3. BIOS Setup

This motherboard provides a programmable EEPROM that you can update the BIOS utility. The BIOS (Basic Input/Output System) is a program that deals with the basic level of communication between processor and peripherals. Use the BIOS Setup program only when installing motherboard, reconfiguring system, or prompted to “Run Setup”. This chapter explains the Setup Utility of BIOS utility.

After powering up the system, the BIOS message appears on the screen, the memory count begins, and then the following message appears on the screen:

**PRESS DEL TO ENTER SETUP**

If this message disappears before you respond, restart the system by pressing <Ctrl> + <Alt> + <Del> keys, or by pressing the Reset button on computer chassis. Only when it failed by these two methods can you restart the system by powering it off and then back on.

After pressing <Del> key, the main menu screen appears.

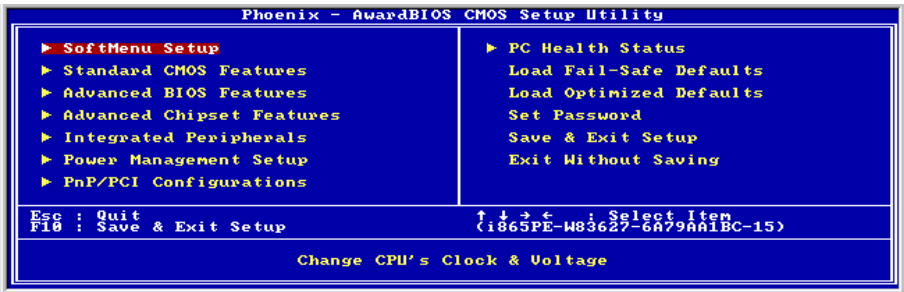

**NOTE:** In order to increase system stability and performance, our engineering staffs are constantly improving the BIOS menu. *The BIOS setup screens and descriptions illustrated in this manual are for your reference only, and may not completely match with what you see on your screen.*

## 3-1. SoftMenu Setup

The SoftMenu utility is ABIT's exclusive and ultimate solution in programming the CPU operating speed. All the parameters regarding CPU FSB speed, multiplier factor, the AGP & PCI clock, and even the CPU core voltage are all available at your fingertips.



### Brand Name:

This item displays the CPU model name, for example: Intel Pentium (R) 4.

### Frequency:

This item displays the processor speed.

### Cache Size:

This item displays the L2 cache size of your CPU.

### CPU Operating Speed:

This item displays the CPU operating speed according to the type and speed of your CPU. You can also select the [User Define] option to enter the manual option.

### User Define:

**WARNING:** The wrong settings of the multiplier and external clock in certain circumstances may cause CPU damage. Setting the working frequency higher than the PCI chipset or processor specs, may cause abnormal memory module functioning, system hangs, hard disk drive data lose, abnormal functioning of the VGA card, or abnormal functioning with other add-on cards. Using non-specification settings for your CPU is not the intention of this explanation. These should be used for engineering testing, not for normal applications.

There will be no guaranty for the settings beyond specification, any damage of any component on this motherboard or peripherals result therein is not our responsibility.

### \* Ext. Clock (CPU/AGP/PCI):

This item selects the external clock frequency.

---

**\* Multiplier Factor:**

This item selects the multiplier factors for your CPU if it is not locked.

**\* Estimated new CPU clock:**

This item displays the frequency sum up from the previous item [Ext. Clock] and [Multiplier Factor].

**\* N/B Strap CPU As:**

This item sets the external hardware reset strap assigned to MCH (Memory Controller Hub). The options are: [PSB400], [PSB533], [PSB800], and [By CPU]. The default setting is **By CPU**.

To set this option manually:

- Select [PSB400] for CPU of 100MHz FSB frequency.
- Select [PSB533] for CPU of 133MHz FSB frequency.
- Select [PSB800] for CPU of 200MHz FSB frequency.

**\* DRAM Ratio (CPU:DRAM):**

This item determines the frequency ratio between CPU and DRAM.

**\* AGP Ratio (CPU:AGP:PCI): (For IS7-G, IS7, IS7-E, and IS7-M only)**

This item determines the ratio among CPU, AGP, and PCI.

**\* Fixed AGP/PCI Frequency:**

This item determines the AGP/PCI bus frequency. This option allows you to keep your AGP/PCI clock at some fixed frequency to improve system stability.

---

**CPU Power Supply:**

This option allows you to switch between CPU default and user-defined voltages. Leave this setting to default unless the current CPU type and voltage setting cannot be detected or is not correct. The option “**User Define**” enables you to select the Core Voltage manually.

**\* CPU Core Voltage:**

This item selects the CPU core voltage.

**ATTENTION:** A wrong voltage setting may cause the system unstable or even damage the CPU. Please leave it to default settings unless you are fully aware of its consequences.

---

**DDR SDRAM Voltage:**

This item selects the voltage for DRAM slot.

---

**AGP Voltage:**

This item selects the voltage for AGP slot.

## 3-2. Standard CMOS Features

This section contains the basic configuration parameters of the BIOS. These parameters include date, hour, VGA card, FDD, and HDD settings.



### Date (mm:dd:yy):

This item sets the date you specify (usually the current date) in the format of [Month], [Date], and [Year].

### Time (hh:mm:ss):

This item sets the time you specify (usually the current time) in the format of [Hour], [Minute], and [Second].

### ☛ IDE Channel 1 Master/Slave, IDE Channel 2 Master/Slave, IDE Channel 3 Master, IDE Channel 4 Master:

Click <Enter> key to enter its submenu:



**NOTE:** Item “IDE Channel 3 Master” and “IDE Channel 4 Master” appears only when the item “OnChip Serial ATA” in the “OnChip IDE Device” menu is set as [Enhanced Mode], and the item “OnChip Serial ATA Mode” in the “OnChip IDE Device” menu is set as [IDE].

---

**IDE HDD Auto-Detection:**

This item allows you to detect the parameters of IDE drives by pressing <Enter> key. The parameters will be shown on the screen automatically.

---

**IDE Channel 1 Master/Slave, IDE Channel 2 Master/Slave, Extended IDE Drive:**

When set to [Auto], the BIOS will automatically check what kind of IDE drive you are using. If you want to define your own drive by yourself, set it to [Manual] and make sure you fully understand the meaning of the parameters. Please refer to the instruction manual provided by the device's manufacturer to get the setting right.

---

**Access Mode:**

This item selects the mode to access your IDE devices. Leave this item to its default [Auto] setting to detect the access mode of your HDD automatically.

---

**Capacity:**

This item displays the approximate capacity of the disk drive. Usually the size is slightly greater than the size of a formatted disk given by a disk-checking program.

---

**Cylinder:**

This item configures the numbers of cylinders.

---

**Head:**

This item configures the numbers of read/write heads.

---

**Precomp:**

This item displays the number of cylinders at which to change the write timing.

---

**Landing Zone:**

This item displays the number of cylinders specified as the landing zone for the read/write heads.

---

**Sector:**

This item configures the numbers of sectors per track.

---

 **Back to Standard CMOS Features Setup Menu:**

---

**Drive A & Drive B:**

This item sets the type of floppy drives (usually only Drive A) installed.

---

**Floppy 3 Mode Support:**

This item allows you to use "3 Mode Floppy Drive" in Japanese computer system by selecting drive A, B, or both. Leave this item to its default [Disabled] setting if you are not using this Japanese standard floppy drive.

---

**Video: (For IS7-G, IS7, IS7-E, and IS7-M only)**

This item selects the type of video adapter used for the primary system monitor.

**[EGA/VGA]:** (Enhanced Graphics Adapter/Video Graphics Array) For EGA, VGA, SVGA and PGA monitor adapters.

**[CGA 40]:** (Color Graphics Adapter) Power up in 40-column mode.

**[CGA 80]:** (Color Graphics Adapter) Power up in 80-column mode.

**[Mono]:** (Monochrome adapter) Includes high-resolution monochrome adapters.

---

#### **Halt On:**

This item determines whether the system stops if an error is detected during system boot-up.

**[All Errors]:** The system-boot will stop whenever the BIOS detect a non-fatal error.

**[No Errors]:** The system-boot will not stop for any error detected.

**[All, But Keyboard]:** The system-boot will stop for all errors except a keyboard error.

**[All, But Diskette]:** The system-boot will stop for all errors except a diskette error.

**[All, But Disk/Key]:** The system-boot will stop for all errors except a diskette or keyboard error.

---

#### **Base Memory:**

This item displays the amount of base memory installed in the system. The value of the base memory is typically 640K for system with 640K or more memory size installed on the motherboard.

---

#### **Extended Memory:**

This item displays the amount of extended memory detected during system boot-up.

---

#### **Total Memory:**

This item displays the total memory available in the system.

---

### 3-3. Advanced BIOS Features



#### Hyper-Threading Technology

This item is used to enable the functionality of the processor with Hyper-Threading Technology and will appear only when using such processor.

The Hyper-Threading Technology helps your PC work more efficiently by maximizing processor resources and enabling a single processor to run two separate threads of software simultaneously, bringing forth greater performance and system responsiveness when running multiple applications at once.

#### Quick Power On Self Test:

When set to [Enabled], this item speeds up the Power On Self Test (POST) after powering on the system. The BIOS shorten or skip some check during the POST.

#### Hard Disk Boot Priority:

This item selects the hard disks booting priority. By pressing <Enter> key, you can enter its submenu where the hard disks detected can be selected for the booting sequence to boot up system.

This item functions only when there is the option of [Hard Disk] in any one of the First/Second/Third Boot Device items.

#### \* Bootable Add-in Device: (For IS7-G and IS7 only)

This item allows you to select the add-in device among the [PCI Slot Device], [OnChip SATA], and [Onboard SATA] channel to serve as the bootable device listed in the item "Hard Disk Boot Priority".

**NOTE:** The option [Onboard SATA] appears only for the model with onboard Serial ATA controller.

#### \* HDD Change Message:

When set to [Enabled], a pop-up message will be displayed on the screen during the POST process if the hard drives installed in your system had been changed.

---

**First Boot Device / Second Boot Device / Third Boot Device / Boot Other Device:**

Select the drive to boot first, second and third in the [First Boot Device], [Second Boot Device], and [Third Boot Device] items respectively. The BIOS will boot the operating system according to the sequence of the drive selected. Set [Boot Other Device] to [Enabled] if you wish to boot from another device other than these three items.

---

**CPU L3 Cache:**

This item is used to enable the L3 cache (default setting), and appears only for certain CPU (Intel Pentium 4 processor with HT Technology Extreme Edition) that possesses L3 cache.

---

**Swap Floppy Drive:**

When set to [Enabled], and the system is booting from the floppy drive, the system will boot from drive B instead of the regular drive A. There must be two floppy drives connected in the system to use this function.

---

**Boot Up Floppy Seek:**

When set to [Enabled], the BIOS will check whether the floppy disk drive is installed or not.

---

**Boot Up NumLock Status:**

This item determines the default state of the numeric keypad at system booting up.

**[On]:** The numeric keypad functions as number keys.

**[Off]:** The numeric keypad functions as arrow keys.

---

**Security Option:**

This item determines when the system will prompt for password - every time the system boots or only when enters the BIOS setup.

**[Setup]:** The password is required only when accessing the BIOS Setup.

**[System]:** The password is required each time the computer boots up.

**NOTE:** Don't forget your password. If you forget the password, you will have to open the computer case and clear all information in the CMOS before you can start up the system. But by doing this, you will have to reset all previously set options.

---

**APIC Mode: (For IS7-G, IS7, IS7-E, and IS7-M only)**

Leave this item to its default setting.

---

**MPS Version Ctrl For OS:**

This item specifies which version of MPS (Multi-Processor Specification) this motherboard will use. Leave this item to its default setting.

---

**OS Select For DRAM > 64MB: (For IS7-G, IS7, IS7-E, and IS7-M only)**

This item allows you to access the memory that is over 64MB in OS/2. Leave this item to its default [Non-OS2] setting for operating system other than OS/2.



---

**Report No FDD For OS:**

When set to [Yes], this item allows you to run some older operating system without floppy disk drive. Leave this item to its default setting.

---

**Delay IDE Initial (Secs):**

This item allows the BIOS to support some old or special IDE devices by prolonging this delay time. A larger value will give more delay time to the device for which to initialize and to prepare for activation.

---

**Intel OnScreen Branding:**

This item determines whether to display the “Intel Inside” logo or not at system boots up.

---

**Disable Unused PCI Clock:**

This option disables the clock of PCI slot that is not in use.

**[Yes]:** The system automatically detect the unused DIMM and PCI slots, and stop sending clock signal to these unused PCI slots.

**[No]:** The system always send clock signal to all PCI slots.

**NOTE:** Set this option to [No] setting if there are adapters that cannot be automatically detected by the system and will cause malfunction.

### 3-4. Advanced Chipset Features



#### DRAM Timing Selectable:

This item sets the optimal timings for the following four items, depending on the memory module you are using. The default setting “By SPD” configures these four items by reading the contents in the SPD (Serial Presence Detect) device. The EEPROM on the memory module stores critical parameter information about the module, such as memory type, size, speed, voltage interface, and module banks.

##### \* CAS Latency Time:

This item controls the latency between the DRAM read command and the time that the data becomes actually available.

##### \* Act to Precharge Delay:

This item controls the number of DRAM clocks used for the DRAM parameters.

##### \* DRAM RAS# to CAS# Delay

This item controls the latency between the DRAM active command and the read/write command.

##### \* DRAM RAS# Precharge:

This item controls the idle clocks after issuing a precharge command to the DRAM.

#### System BIOS Cacheable: (For IS7-G, IS7, IS7-E, and IS7-M only)

When set to [Enabled], accesses to the system BIOS ROM addressed at F0000H-FFFFFH are cached, provided that the cache controller is enabled. The larger the range of the Cache RAM, the higher the efficiency of the system will be.

#### Video BIOS Cacheable:

As with caching the system BIOS, enabling the Video BIOS cache will allow access to video BIOS addressed at C0000H to C7FFFH to be cached, if the cache controller is also enabled. The larger the range of the Cache RAM, the faster the video performance will be.

---

**Memory Hole At 15M-16M:**

When set to [Enabled], the memory address space at 15M-16M will be reserved for ISA expansion cards that specifically requires this setting. This makes the memory from 15MB and up unavailable to the system. Leave this item to its default setting.

---

**Delay Prior to Thermal:**

This item selects the delay time before thermal activation.

---

**AGP Aperture Size:**

This option specifies the amount of system memory that can be used by the AGP device. The aperture is a portion of the PCI memory address range dedicated for graphics memory address space.

---

**Init Display First:**

This item selects to initialize AGP or PCI Slot first when the system boots.

**[AGP]:** When the system boots, it will first initialize AGP.

**[PCI Slot]:** When the system boots, it will first initialize PCI.

---

**AGP Data Rate Capability:**

This item selects the data transfer rate of AGP device. A higher rate delivers faster and better graphics to your system. Make sure your graphics card supports the mode you select.

---

**Game Accelerator: (For IS7-G and IS7 only)**

This item selects the mode for Game Accelerator among the options of [Auto], [Turbo], [Street Racer], and [F1].

NOTE: The option [Street Racer] and [F1] mode will stress the DDR memory critically; not every kind of DDR memories could be stable with these two options. [Turbo] mode is okay for most of DDR memories.

**\* Refresh Cycle Time:**

This item determines the DRAM Refresh Cycle among [Auto], [Normal], [Enhanced], [Strengthened], and [Aggressive].

**\* Read Delay (tRD):**

This item determines the timing of DRAM Read Delay.

**\* Read delay Adjust(tRDA):**

This item determines to adjust the timing of DRAM Read Delay.

**\* Command Per Clock(CPC):**

This item determines the address command timing according to the DRAM strobe clock.

---

**On-Chip VGA: (For IS7-M only)**

This option enables or disables the on-chip VGA controller.

---

**On-Chip Frame Buffer Size: (For IS7-M only)**

This option selects the size of on-chip frame buffer.

### 3-5. Integrated Peripherals



#### ↳ OnChip IDE Device:

Click <Enter> key to enter its submenu:



#### IDE Bus Master:

This option enables or disables the IDE bus mastering capability under the DOS environment.

#### OnChip IDE-1 Controller:

This item allows you to enable or disable the primary and secondary IDE controller. Select [Disabled] if you want to add a different hard drive controller.

#### \* Master/Slave Drive PIO Mode (For IS7-G, IS7, IS7-E, and IS7-M only)

The PIO (Programmed Input/Output) mode allows the BIOS to tell the controller what it wants and then let the controller and the CPU perform the complete task, rather than having the BIOS issue a series of commands to affect a transfer to or from the disk drive.

[Auto]: The BIOS will select the best available mode after checking your disk drive.

[Mode 0-4]: You can select a mode that matches your disk drive's timing. Do not use the wrong setting or you will have drive errors.

---

**\* Master/Slave Drive Ultra DMA (For IS7-G, IS7, IS7-E, and IS7-M only)**

This item allows you to set the Ultra DMA in use.

**[Auto]:** The BIOS will select the best available option after checking your hard drive or CD-ROM.

**[Disabled]:** The BIOS will not detect these categories. If problem arises in using Ultra DMA devices, try disabling this item.

---

**OnChip IDE-2 Controller:**

The description is same as the *OnChip IDE-1 Controller*.

---

**OnChip Serial ATA Mode: (For IS7-G and IS7 only)**

This item determines the mode for on-chip Serial ATA.

**[IDE]:** The on-chip Serial ATA served as IDE Mode.

**[RAID]:** The on-chip Serial ATA served as RAID Mode.

**[NOTE]:** The [RAID] option is only available when the item "OnChip Serial ATA" is set as [Enhanced Mode].

---

**\* SATA RAID ROM:**

This item allows you to use the boot ROM of on-chip Serial ATA RAID to boot-up system.

---

**OnChip Serial ATA:**

This item determines the function for on-chip Serial ATA.

**[Disabled]:** Disable the Serial ATA controller.

**[Auto]:** Allows the Serial ATA controller to be arranged by BIOS automatically.

**[Combined Mode]:** Parallel ATA and Serial ATA are combined together. Supports up to 4 IDE drives.

**[Enhanced Mode]:** Enable both Parallel ATA and Serial ATA. Supports up to 6 IDE drives.

**[SATA Only]:** The SATA is operating in legacy mode.

---

\* **Serial ATA 1 Mode / Serial ATA 2 Mode:**

This item determines the function mode for Serial ATA Port 1 (i.e. The SATA1 connector in this model) and Serial ATA Port 2 (i.e. The SATA2 connector in this model). Both SATA1 and SATA2 will be served each as one single IDE connector after selected as the following modes:

Mode	Serial ATA Port 1 (SATA1)	Serial ATA Port 2 (SATA2)	Description
Enhanced	IDE-3 Master	IDE-4 Master	<ul style="list-style-type: none"> <li>• SATA1 serves as IDE-3 Master</li> <li>• SATA2 serves as IDE-4 Master</li> <li>• OnChip IDE-1 and IDE-2 controller enabled</li> </ul>
	IDE-4 Master	IDE-3 Master	<ul style="list-style-type: none"> <li>• SATA1 serves as IDE-4 Master</li> <li>• SATA2 serves as IDE-3 Master</li> <li>• OnChip IDE-1 and IDE-2 controller enabled</li> </ul>
Combined	IDE-1 Master	IDE-1 Slave	<ul style="list-style-type: none"> <li>• SATA1 serves as IDE-1 Master</li> <li>• SATA2 serves as IDE-1 Slave</li> <li>• OnChip IDE-1 controller disabled</li> </ul>
	IDE-1 Slave	IDE-1 Master	<ul style="list-style-type: none"> <li>• SATA1 serves as IDE-1 Slave</li> <li>• SATA2 serves as IDE-1 Master</li> <li>• OnChip IDE-1 controller disabled</li> </ul>
	IDE-2 Master	IDE-2 Slave	<ul style="list-style-type: none"> <li>• SATA1 serves as IDE-2 Master</li> <li>• SATA2 serves as IDE-2 Slave</li> <li>• OnChip IDE-2 controller disabled</li> </ul>
	IDE-2 Slave	IDE-2 Master	<ul style="list-style-type: none"> <li>• SATA1 serves as IDE-2 Slave</li> <li>• SATA2 serves as IDE-2 Master</li> <li>• OnChip IDE-2 controller disabled</li> </ul>
SATA Only	IDE-1 Master	IDE-2 Master	<ul style="list-style-type: none"> <li>• SATA1 serves as IDE-1 Master</li> <li>• SATA2 serves as IDE-2 Master</li> <li>• OnChip IDE-1 and IDE-2 controller disabled</li> </ul>
	IDE-2 Master	IDE-1 Master	<ul style="list-style-type: none"> <li>• SATA1 serves as IDE-2 Master</li> <li>• SATA2 serves as IDE-1 Master</li> <li>• OnChip IDE-1 and IDE-2 controller disabled</li> </ul>

### ↳ OnChip PCI Device:

Click <Enter> key to enter its submenu:

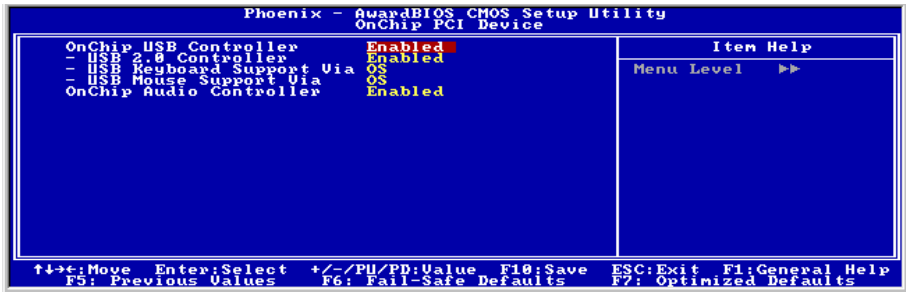

### OnChip USB Controller:

This option enables or disables the USB controller.

#### \* USB 2.0 Controller:

This option enables or disables the USB 2.0 controller.

#### \* USB Keyboard Support Via:

This item allows you to select **[BIOS]** for using USB keyboard in DOS environment, or **[OS]** in OS environment.

#### \* USB Mouse Support Via:

This item allows you to select **[BIOS]** for using USB mouse in DOS environment, or **[OS]** in OS environment.

### OnChip Audio Controller:

This option enables or disables the audio controller.

## ↳ SuperIO Device:

Click <Enter> key to enter its submenu:

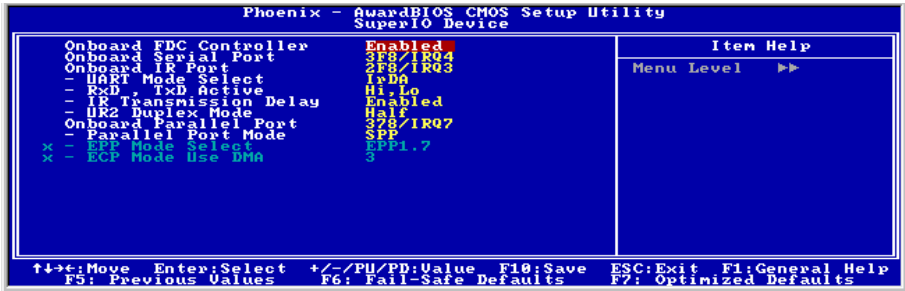

### Onboard FDC Controller:

This option enables or disables the onboard FDC controller.

### Onboard Serial Port:

This item determines which I/O addresses the onboard Serial Port controller will access.

**[Auto]:** The system automatically select an I/O address for the onboard Serial Port.

**[3F8/IRQ4, 2F8/IRQ3, 3E8/IRQ4, 2E8/IRQ3]:** Allows you to manually select an I/O address for the onboard Serial Port.

**[Disabled]:** Disables the onboard Serial Port.

### Onboard IR Port: (For IS7-G, IS7, IS7-E, and IS7-M only)

This item determines which I/O addresses the onboard IR Port controller will access.

**[Auto]:** The system automatically select an I/O address for the onboard IR Port.

**[3F8/IRQ4, 2F8/IRQ3, 3E8/IRQ4, 2E8/IRQ3]:** Allows you to manually select an I/O address for the onboard IR Port.

**[Disabled]:** Disables the onboard IR Port.

#### \* UART Mode Select:

This item selects the Infrared (IR) function mode.

#### \* Rx/D, Tx/D Active:

This item sets the IR transmission/reception polarity.

#### \* IR Transmission Delay:

This option enables or disables the IR transmission delay. When set to [Enabled], the transmission will be slower. This is recommended when transmission problem arise.



**\* UR2 Duplex Mode:**

This item selects the duplex mode required by the IR device connected to the IR port. Full-duplex mode permits simultaneous two-direction transmission. Half-duplex mode permits transmission in one direction only at a time. Refer to your IR KIT user's guide to find out which setting is correct.

---

**Onboard Parallel Port:**

This item specifies the I/O address used by the parallel port.

**[Disabled]:** This option prevents the parallel port from accessing any system resources. When the value of this option is set to [Disabled], the printer port becomes unavailable.

**[378/IRQ7]:** This option allows the parallel port to use [378/IRQ7] as its I/O port address. The majority of parallel ports on computer systems use IRQ7 and I/O Port 378H as the standard setting.

**[278/IRQ5]:** This option allows the parallel port to use [278/IRQ5] as its I/O port address.

**[3BC/IRQ7]:** This option allows the parallel port to use [3BC/IRQ7] as its I/O port address.

**\* Parallel Port Mode:**

This item specifies the parallel port mode.

**[Normal]:** Allows the standard parallel port mode to be used.

**[SPP]:** (Standard Parallel Port) Allows bi-directional parallel port operation at normal speed.

**[EPP]:** (Enhanced Parallel Port) Allows bi-directional parallel port operation at maximum speed.

**[ECP]:** (Extended Capabilities Port) Allows bi-directional parallel port operation at a speed faster than the normal mode's data transfer rate.

**[ECP+EPP]:** Allows parallel port operation at ECP and EPP mode.

**\* EPP Mode Select:**

This item selects the EPP mode.

**\* ECP Mode Use DMA:**

This item selects the DMA channel of the parallel port.

## ↳ Onboard PCI Device:

Click <Enter> key to enter its submenu:

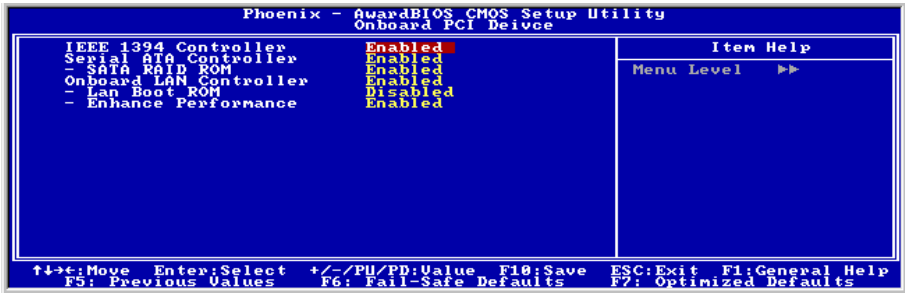

### IEEE 1394 Controller: (For IS7-G and IS7 only)

This option enables or disables the IEEE 1394 controller.

### Serial ATA Controller: (For IS7-G only)

This option enables or disables the Serial ATA controller of Silicon Image PCI Chip

#### \* SATA RAID ROM:

This item allows you to use the boot ROM of on-chip Serial ATA RAID to boot-up system.

### Onboard LAN Controller: (For IS7-G/IS7/IS7-E/IS7-E2/IS7-E2G/IS7-M/IS7-V2 only)

This option enables or disables the LAN controller.

#### \* LAN Boot ROM:

This item allows you to use the boot ROM (instead of a disk drive) to boot-up the system and access the local area network directly.

#### \* Enhance Performance:

This option enhances the LAN performance by making it as the first priority among the PCI devices.

## 3-6. Power Management Setup



### ACPI Suspend Type:

This item selects the type of Suspend mode.

[S1(PowerOn Suspend)]: Enables the Power On Suspend function.

[S3(Suspend To RAM)]: Enables the Suspend to RAM function.

### Resume by USB From S3:

When set to [Enabled], this item allows you to use a USB device to wake up a system that is in the S3 (STR - Suspend To RAM) state. This item can be configured only if the item “ACPI Suspend Type” is set to [S3(STR)].

### Power Button Function:

This item selects the method of powering off your system:

[Delay 4 Sec.]: Pushing the power button for more than 4 seconds will power off the system. This will prevent the system from powering off in case you accidentally hit or pushed the power button.

[Instant-Off]: Pressing and then releasing the power button at once will immediately power off the system.

### CPU THRM-Throttling

This item controls the CPU speed by cutting down its regular power to a percentage during the STR (Suspend To RAM) state.

### WakeUp by PME# of PCI:

When set to [Enabled], access to the onboard LAN or a PCI card such as a modem or LAN card will cause the system to wake up. The PCI card must support the wake up function.

### WakeUp by Onboard Lan: (For IS7-G/IS7/IS7-E/IS7-E2/IS7-M/IS7-V2 only)

When set to [Enabled], you can remotely wake up a PC in Soft-Off condition via a LAN card that support the wake up function.

---

**WakeUp by Alarm:**

When set to **[Enabled]**, you can set the date and time you would like the Soft-Off PC to power-on in the “**Date (of Month) Alarm**” and “**Time (hh:mm:ss) Alarm**” items. However, if the system is being accessed by incoming calls or the network (Resume On Ring/LAN) prior to the date and time set in these items, the system will give priority to the incoming calls or network instead.

\* **Date (of Month) Alarm**

**[0]:** This option power-on the system everyday according to the time set in the “Time (hh:mm:ss) Alarm” item.

**[1-31]:** This option selects a date you would like the system to power-on. The system will power-on on the date set, and the time set in the “Time (hh:mm:ss) Alarm” item.

\* **Time (hh:mm:ss) Alarm**

This item sets the time you would like the system to power-on.

---

**POWER ON Function:**

This item selects the way you want your system to power on.

**[Password]:** Use a password to power on the system, select this option then press <Enter>. Enter your password. You can enter up to 5 characters. Type in exactly the same password to confirm, and then press <Enter>.

**[Hot KEY]:** Use any of the function keys between <F1> to <F12> to power on the system.

**[Mouse Left]:** Double click the mouse left button to power on the system.

**[Mouse Right]:** Double click the mouse right button to power on the system.

**[Any KEY]:** Use any keyboard keys to power on the system.

**[Button Only]:** Use only the power button to power on the system.

**[Keyboard 98]:** Use the power-on button on the “Keyboard 98” compatible keyboard to power on the system.

**NOTE:** (For IS7-G, IS7, IS7-E, IS7-E2, IS7-E2G, IS7-E2V, and IS7-V2 only) To enable this “Power On” function, the wake-up header of [PS2-PWR1], [USB-PWR1], [USB-PWR2] must be set to [Enabled] position. Please refer to the configuration of “Wake-up Header” [PS2-PWR1], [USB-PWR1], and [USB-PWR2] in section 2-4, chapter 2.

**NOTE:** The mouse wake up function can only be used with the PS/2 mouse, not with the COM port or USB type. Some PS/2 mice cannot wake up the system because of compatible problems. If the specs of your keyboard are too old, it may fail to power on.

\* **KB Power ON Password:**

This item sets the password required in order to power on your computer.

**NOTE:** Do not forget your password, or you will have to clear the CMOS and reset all parameters in order to utilize this function again.

**\* Hot Key Power ON:**

This item powers on the system by pressing <Ctrl> key plus one of each function key (<F1> ~ <F12>) simultaneously.

---

**Restore On AC Power Loss:**

This item selects the system action after an AC power failure.

**[Power Off]:** When power returns after an AC power failure, the system's power remains off. You must press the Power button to power-on the system.

**[Power On]:** When power returns after an AC power failure, the system's power will be powered on automatically.

**[Last State]:** When power returns after an AC power failure, the system will return to the state where you left off before power failure occurs. If the system's power is off when AC power failure occurs, it will remain off when power returns. If the system's power is on when AC power failure occurs, the system will power-on when power returns.

### 3-7. PnP/PCI Configurations



#### Resources Controlled By:

This item configures all of the boot and Plug-and-Play compatible devices.

[Auto]: The system will automatically detect the settings.

[Manual]: Choose the specific IRQ resources in the "IRQ Resources" menu.

#### \* IRQ Resources:

Click <Enter> key to enter its submenu:

This item sets each system interrupt to either [PCI Device] or [Reserved].

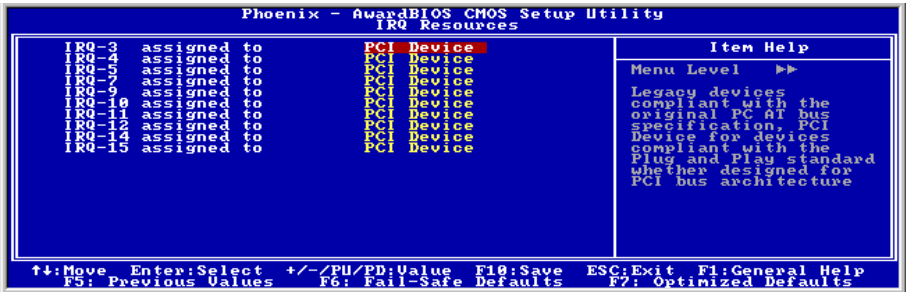

#### PCI/VGA Palette Snoop:

This item determines whether the MPEG ISA/VESA VGA cards can work with PCI/VGA or not.

[Enabled]: MPEG ISA/VESA VGA cards work with PCI/VGA.

[Disabled]: MPEG ISA/VESA VGA cards do not work with PCI/VGA.

#### Allocate IRQ To Video: (For IS7-G, IS7, IS7-E, and IS7-M only)

This item assigns an IRQ for the VGA card installed.

**[Enabled]:** Automatically assign an IRQ for the VGA card installed.

**[Disabled]:** The IRQ that was previously occupied by the VGA card will be available for new device.

---

#### Allocate IRQ To USB: (For IS7-G, IS7, IS7-E, and IS7-M only)

This item assigns an IRQ for the USB device connected.

**[Enabled]:** Automatically assign an IRQ for the USB device connected.

**[Disabled]:** The IRQ that was previously occupied by the USB device connected will be available for new device.

---

#### PCI Latency Timer(CLK):

This item controls how long each PCI device can hold the bus before another takes over. When set to higher values, every PCI device can conduct transactions for a longer time and thus improve the effective PCI bandwidth. For better PCI performance, you should set the item to higher values.

---

#### PIRQ\_0 Use IRQ No. ~ PIRQ\_7 Use IRQ No.:

This item specifies the IRQ number manually or automatically for the devices installed on PCI slots.

For the relations between the hardware layout of PIRQ (the signals from the ICH chipset), INT# (means PCI slot IRQ signals) and devices, please refer to the table below:

Signals	AGP	LAN	PCI-1	PCI-2	PCI-3	PCI-4	PCI-5	IEEE-1394 (IS7-G, IS7)	SATA (IS7-G)
PIRQ_0 Assignment	INT A		INT D						
PIRQ_1 Assignment	INT B		INT A					INT A	
PIRQ_2 Assignment		INT A	INT B						
PIRQ_3 Assignment			INT C						INT A
PIRQ_4 Assignment				INT A	INT D	INT C	INT B		
PIRQ_5 Assignment				INT B	INT A	INT D	INT C		
PIRQ_6 Assignment				INT C	INT B	INT A	INT D		
PIRQ_7 Assignment				INT D	INT C	INT B	INT A		

#### NOTE:

- PCI slot 1 shares IRQ signals with IEEE-1394. (IS7-G, IS7).
- If you want to install two PCI cards into those PCI slots that share IRQ with one another at the same time, you must make sure that your OS and PCI devices' driver supports the IRQ sharing function.

## 3-8. PC Health Status



### FAN Fail Alarm Selectable:

This item selects the fan that will be monitored for malfunction.

### Shutdown When CPUFAN Fail:

When set to [Enabled], the system will be shut down if the CPU fan is not running.

### CPU FanEQ Speed Control: (For IS7-G/IS7/IS7-E/IS7-E2/IS7-E2G/IS7-E2V only)

This item allows you to control the CPU fan speed down to a specific percentage.

When set to a specific percentage, the CPU fan speed will run at the percentage you set in this item if the temperature limit set in the item "Active Temperature" is not exceeded.

The CPU fan speed will run at 100% regardless of what the percentage you set in this item if the temperature limit set in the item "Active Temperature" is exceeded.

### \* Active Temperature:

This item sets the temperature limit that would activate the function of "CPU FanEQ Speed Control" option.

### Shutdown Temperature:

This item sets the temperature that would shutdown the system automatically in order to prevent system overheats.

### CPU Warning Temperature:

This item selects the CPU's warning temperature limit. Once the system has detected that the CPU's temperature exceeded the limit, warning beeps will sound.

**NOTE:** The onboard hardware monitor function is capable of detecting these system health conditions. If you want a warning message to pop-up or a warning alarm to sound when an abnormal condition occurs, you must install the "Hardware Doctor" utility. This utility is included in the "Driver & Utility CD" that came packed with this motherboard.



---

**All Voltages, Fans Speed and Thermal Monitoring:**

These unchangeable items list the current status of the CPU and environment temperatures, fan speeds, and system power voltage.

**NOTE:** The hardware monitoring features for temperatures, fans and voltages will occupy the I/O address from 294H to 297H. If you have a network adapter, sound card or other add-on cards that might use those I/O addresses, please adjust your add-on card I/O address to avoid using these addresses.

---

**3-9. Load Fail-Safe Defaults**

---

This option loads the BIOS default values for the most stable, minimal-performance system operations.

---

**3-10. Load Optimized Defaults**

---

This option loads the BIOS default values that are factory settings for optimal-performance system operations.

---

**3-11. Set Password**

---

This option protects the BIOS configuration or restricts access to the computer itself.

---

**3-12. Save & Exit Setup**

---

This option saves your selections and exits the BIOS setup menu.

---

**3-13. Exit Without Saving**

---

This option exits the BIOS setup menu without saving any change.



## Appendix A. Install Intel Chipset Software Utility

**NOTE:** Please install this Intel Chipset driver first after having installed the Windows operating system.

The installation procedures and screen shots in this section are based on Windows XP operating system. For those of other OS, please follow its on-screen instruction.

Insert the Driver & Utility CD into CD-ROM drive, it should execute the installation program automatically. If not, double-click the execution file at the main directory of this CD to enter the installation menu.

After entering the installation menu, move your cursor to [Drivers] tab. Click [Intel Chipset Software Utility]. The following screen appears.

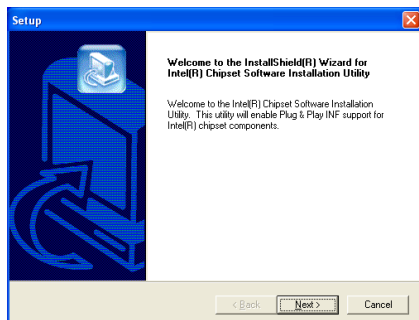

1. Click [Next].

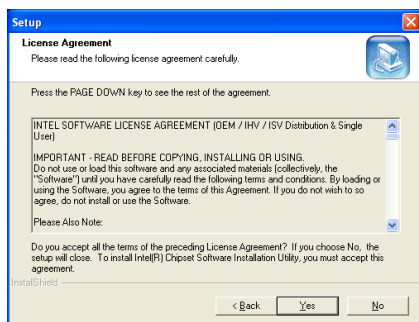

2. Click [Yes].

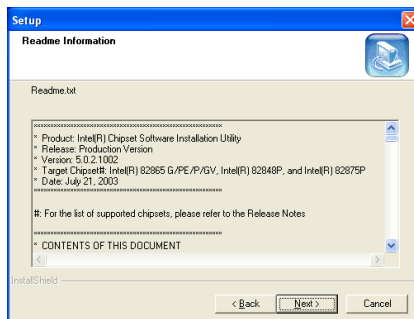

3. Click [Next].

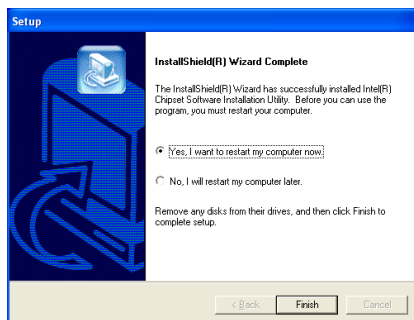

4. Choose [Yes, I want to restart my computer now.], and click [Finish] to complete setup.



## Appendix B. Install Intel Application Accelerator RAID (IS7-G, IS7)

The installation procedures and screen shots in this section are based on Windows XP operating system. For those of other OS, please follow its on-screen instruction.

Insert the Driver & Utility CD into CD-ROM drive, it should execute the installation program automatically. If not, double-click the execution file at the main directory of this CD to enter the installation menu.

After entering the installation menu, move your cursor to [Drivers] tab. Click [Intel Application Accelerator RAID]. The following screen appears.

**NOTE:** This “Intel Application Accelerator RAID” program edition is available for Windows 2000/XP only. To install this program, you have to enable the item “RAID Function” first in the BIOS menu of “OnChip Serial ATA Mode”.

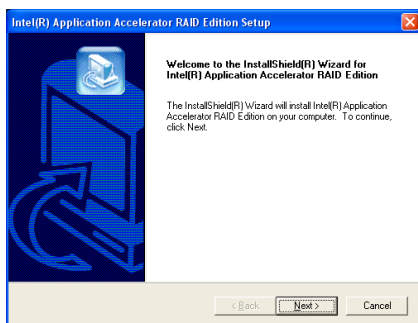

1. Click [Next].

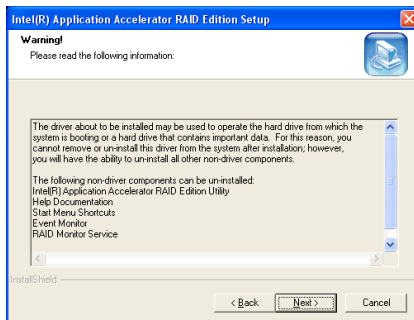

2. Click [Next].

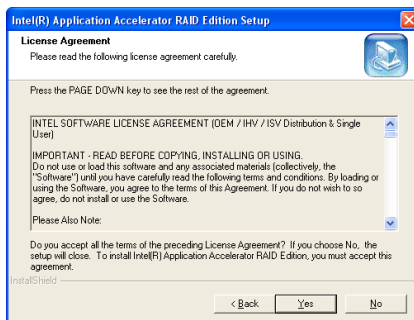

3. Click [Yes].

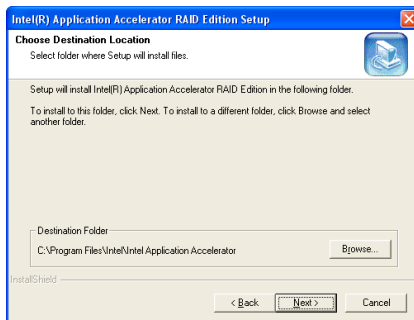

4. Click [Next].

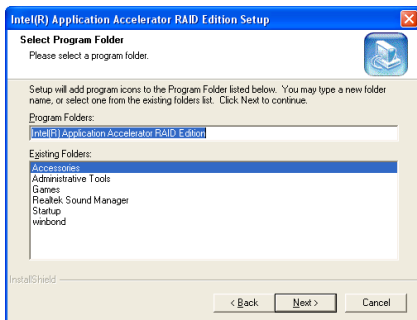

5. Click [Next].

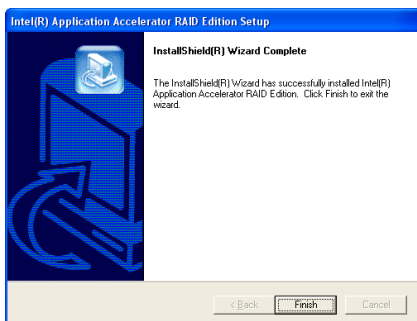

6. Click [Finish] to complete setup.

## Intel Serial ATA RAID Configuration Utility (IS7-G, IS7)

The on-chip Serial ATA RAID supports the Stripe (RAID 0) and Mirror (RAID 1) RAID set. For the striped RAID set, the identical drives can read and write data in parallel to increase performance. The Mirrored RAID set creates a complete backup of your files. Striped and Mirrored RAID set requires 2 hard disks to do so.

### Main Menu

Reboot your system. Press <CTRL> + <I> key while booting up the system to enter the main menu of RAID Configuration Utility:

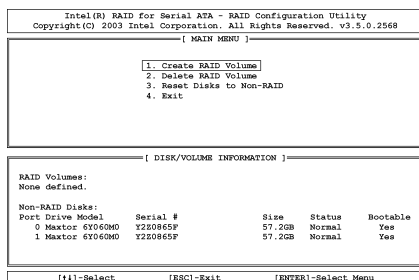

To select the option in this menu, you may:

- Press <↑ ↓> (up, down arrow) to choose the option you want to confirm or to modify.
- Press <Enter> to confirm the selection.
- Press <Esc> to return to previous menu.

**NOTE:** If you want to create a RAID 0 (striping) array, all the data stored in the hard disks will first be erased! Please backup the hard disk data before starting to create the RAID array.

If you want to create a RAID 1 (mirroring) array, please make sure which hard disk is the source disk and which one is the destination disk. If you make a mistake, you may copy the blank data to the source disk, which will result in both hard disks becoming blank!

### Create RAID Volume

This item allows you to create a RAID array.

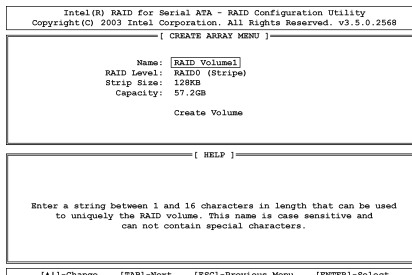

**Name:** This item displays the name of the RAID array. You can enter up to 16 characters in length. This name is case sensitive and cannot contain special characters.

**Strip Size:** This item displays the strip value.

**RAID Level:** This item displays the RAID type.

**Capacity:** This item displays the capacity of RAID array.

**NOTE:** It is highly recommended to attach hard disks with the same model in reaching the RAID performance.

**Delete RAID Volume**

This item allows you to remove a RAID Array.

```

Intel(R) RAID for Serial ATA - RAID Configuration Utility
Copyright(C) 2003 Intel Corporation. All Rights Reserved. v3.5.0.2568

[ DELETE ARRAY MENU ]

Name      Level      Drives  Capacity  Status  Bootable
RAID Volume1  RAID0(Stripe)  2       57.2GB   Normal  Yes

[ HELP ]

Deleting a volume will destroy the volume data on the drive(s) and
cause any member disks to become available as non-RAID disks.

WARNING: EXISTING DATA WITHIN THIS VOLUME WILL BE LOST AND NON-RECOVERABLE

[F1]-Select [ESC]-Previous Menu [DEL]-Delete Volume
    
```

- Press <↑ ↓> (up, down arrow) to select the RAID array you want to delete.
- Press <Del> to delete the volume.
- Press <Esc> to return to previous menu.

**NOTE:** After you have made and confirmed this selection, all the data stored in the hard disk will be lost. (The entire partition configuration will be deleted too.)

**Reset Disks to Non-RAID**

This item allows you to reset all RAID data. Type <Y> if you want to reset all RAID data.

```

Intel(R) RAID for Serial ATA - RAID Configuration Utility
Copyright(C) 2003 Intel Corporation. All Rights Reserved. v3.5.0.2568

[ MAIN MENU ]

[ RESET ALL RAID DATA ]

Resetting all RAID data will remove any internal RAID structures
from all RAID disks, including disks with working volumes. These
structures are used to maintain the RAID volumes. By removing
these structures, the drive will revert back to a Non-RAID disk
that can be used or reallocated to a new RAID volume.

WARNING: Selecting "Yes" will cause all data on any RAID disk
(RAID Volume or other RAID Disk) to be lost.

Are you sure you want to reset all RAID data (Y/N):

Port Drive Model      Serial #          Size  Status  Bootable
0 Maxtor 6Y060MD      Y2Z0865P         57.2GB Normal  Yes
1 Maxtor 6Y060MD      Y2Z0865P         57.2GB Normal  Yes

[F1]-Select [ESC]-Exit [ENTER]-Select Menu
    
```

**Exit**

This item allows you to exit the Intel Serial ATA RAID Configuration Utility. Type <Y> if you want to exit.

```

Intel(R) RAID for Serial ATA - RAID Configuration Utility
Copyright(C) 2003 Intel Corporation. All Rights Reserved. v3.5.0.2568

[ MAIN MENU ]

1. Create RAID Volume
2. Delete RAID Volume
3. Reset Disks to Non-RAID
4. Exit

[ CONFIRM EXIT ]

Are you sure you want to exit? (Y/N):

RAID Volumes:
None defined.

Non-RAID Disks:
Port Drive Model      Serial #          Size  Status  Bootable
0 Maxtor 6Y060MD      Y2Z0865P         57.2GB Normal  Yes
1 Maxtor 6Y060MD      Y2Z0865P         57.2GB Normal  Yes

[F1]-Select [ESC]-Exit [ENTER]-Select Menu
    
```



## Appendix C. Install Audio Driver

The installation procedures and screen shots in this section are based on Windows XP operating system. For those of other OS, please follow its on-screen instruction.

Insert the Driver & Utility CD into CD-ROM drive, it should execute the installation program automatically. If not, double-click the execution file at the main directory of this CD to enter the installation menu.

After entering the installation menu, move your cursor to [Drivers] tab. Click [Audio Driver]. The following screen appears.

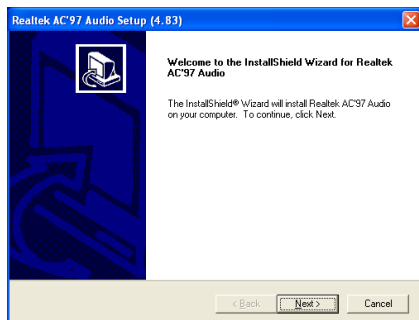

1. Click [Next].

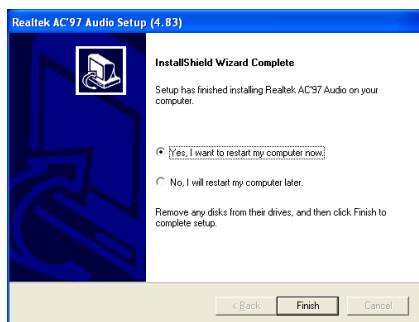

2. Choose [Yes, I want to restart my computer now.], and click [Finish] to complete setup.

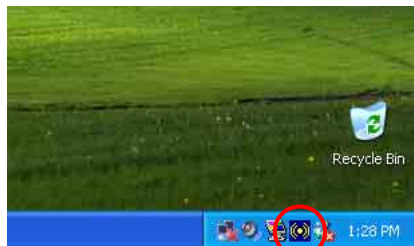

3. After the system restarted, a shortcut icon appears at the right corner of Windows task bar.



## Appendix D. Install LAN Driver

In spite of the various LAN chips that may be utilized on i865 (i848) series motherboard, the Driver & Utility CD came packed with this motherboard detects the one you have automatically.

To install the LAN driver, please insert the Driver & Utility CD into CD-ROM drive. It should execute the installation program automatically. If not, double-click the execution file at the main directory of this CD to enter the installation menu. The following screen appears.



Click [LAN Driver], and then follow the on-screen instruction to complete the driver installation.



## Appendix E. Install Silicon Serial ATA RAID Driver (IS7-G)

The installation procedures and screen shots in this section are based on Windows XP operating system. For those of other OS, please follow its on-screen instruction.

Insert the Driver & Utility CD into CD-ROM drive, it should execute the installation program automatically. If not, double-click the execution file at the main directory of this CD to enter the installation menu.

After entering the installation menu, move your cursor to [Drivers] tab. Click [Silicon Serial ATA RAID]. The following screen appears.

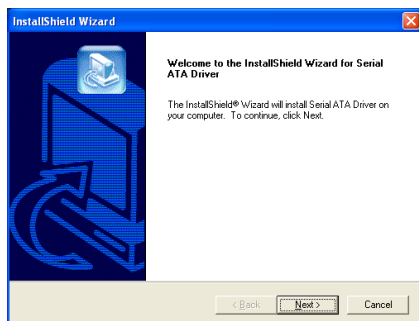

1. Click [Next].



2. Click [Continue Anyway].

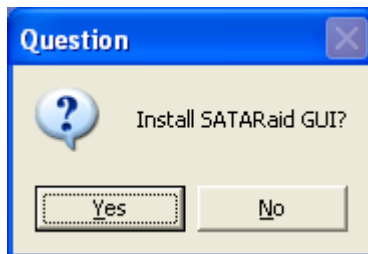

3. Click [Yes].

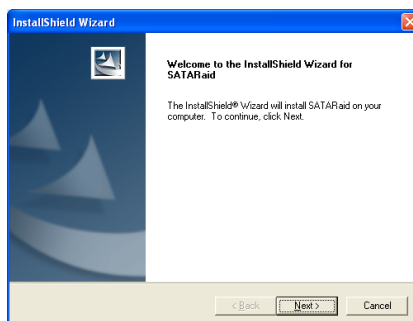

4. Click [Next].

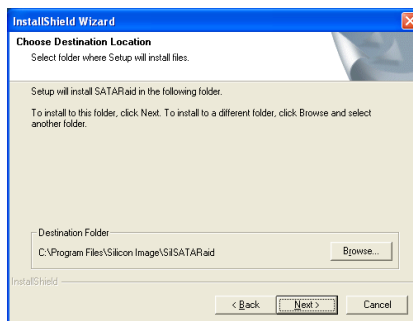

5. Click [Next].

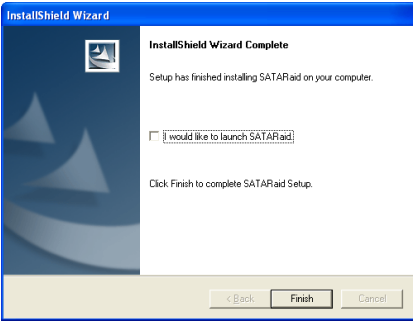

6. Click [Finish].

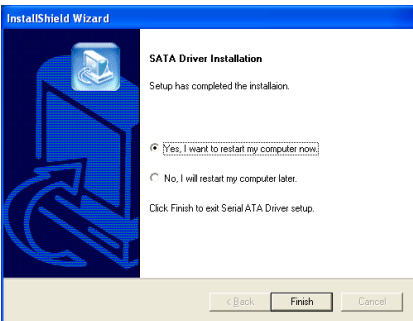

7. Choose [Yes, I want to restart my computer now.], and click [Finish] to complete setup.



8. Check [Device Manager]. [Silicon Image Sii 3112 SATARaid Controller] is successfully installed.

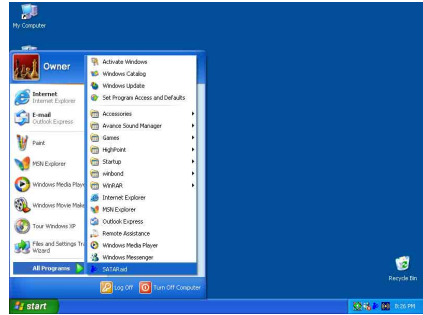

9. To run the [SATARaid] application, click [Start] → [All Programs] → [SATARaid].

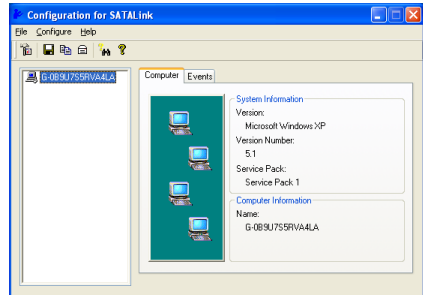

10. This is the SATALink configuration menu. For more information on how to operate, please refer to the “Help” menu.

## BIOS Setup for Serial ATA RAID (IS7-G)

The Silicon Serial ATA controller supports the RAID array of both Striped (RAID 0) and Mirrored (RAID 1). For the striped RAID set, the identical drives can read and write data in parallel to increase performance. The Mirrored RAID set creates a complete backup of your files. Striped and Mirrored RAID set requires 2 hard disks to do so.

## RAID Configuration Utility Menu

### Main Menu

Reboot your system. Press **<CTRL> + <S>** or **<F4>** key while booting up the system to enter the BIOS setting menu. The main menu of the BIOS Setting Utility appears as shown below:

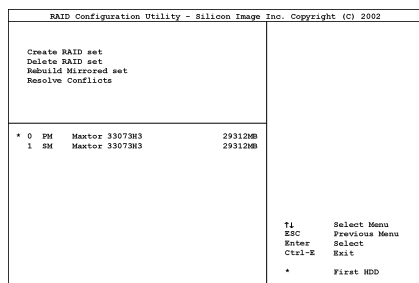

To select the option in this menu, you may:

- Press **<↑ ↓>** (up, down arrow) to choose the option you want to confirm or to modify.
- Press **<Enter>** to confirm the selection.
- Press **<Esc>** to return to previous menu.
- Press **<Ctrl-E>** to exit the RAID configuration utility.

**NOTE:** If you want to create a RAID 0 (striping) array, all the data stored in the hard disks will first be erased! Please backup the hard disk data before starting to create the RAID array.

If you want to create a RAID 1 (mirroring) array, please make sure which hard disk is the source disk and which one is the destination disk. If you make a mistake, you may copy the blank data to the source disk, which will result in both hard disks becoming blank!

### Option 1 Create RAID set

This item allows you to create a RAID array.

After you had selected the function from the main menu, press the **<Enter>** key to enter the sub menu as shown below:

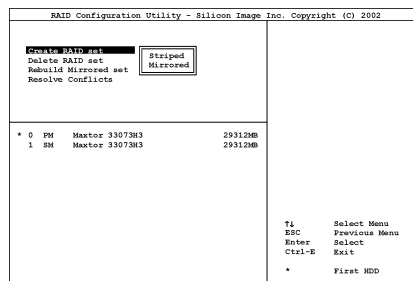

#### • Array Mode:

This item allows you to select the appropriate RAID mode for the desired array. There are two modes to choose. When you choose a “Striped” or “Mirrored” RAID set, the utility will ask “Are You Sure?” before the Creating RAID process. Press **<Y>** to confirm.

**NOTE:** It is highly recommended to attach hard disks with the same model in reaching the RAID performance.

**Striping (RAID 0):** This item is recommended for **high performance** usage. Requires at least 2 disks.

**Mirror (RAID 1):** This item is recommended for **data security** usage. Requires at least 2 disks.

**Option 2  
Delete RAID set**

This item allows you to remove a RAID Array on this onboard Serial ATA RAID controller.

**NOTE:** After you have made and confirmed this selection, all the data stored in the hard disk will be lost. (The entire partition configuration will be deleted too.)

**Option 3  
Rebuild Mirrored set**

This item allows you to rebuild only “Mirrored” RAID set.

You need to check which hard disk is the source disk and which one is the destination disk when you decide to rebuild mirrored RAID set.

**Option 4  
Resolve Conflicts**

When a RAID set is created, the metadata written to the disk includes drive connection information (Primary Channel, Secondary Channel).

If, after a disk failure, the replacement disk was previously part of a RAID set (or used in another system), it may have conflicting metadata, specifically in reference to the drive connection information. If so, this will prohibit the RAID set from being either created or rebuilt.

In order for the RAID set to function properly, this old metadata must be first overwritten with the new metadata. To resolve this, select “Resolve Conflict”. The correct metadata, including the correct drive connection information; will then be written to the replacement disk.

**NOTE:** For more information on RAID function, please refer to the RAID Management Software enclosed in the CD that came packed with this motherboard.



## Appendix F. Install VGA Driver (IS7-M)

The installation procedures and screen shots in this section are based on Windows XP operating system. For those of other OS, please follow its on-screen instruction.

Insert the Driver & Utility CD into CD-ROM drive, it should execute the installation program automatically. If not, double-click the execution file at the main directory of this CD to enter the installation menu.

After entering the installation menu, move your cursor to [Drivers] tab. Click [Intel Extreme Graphics Driver]. The following screen appears.

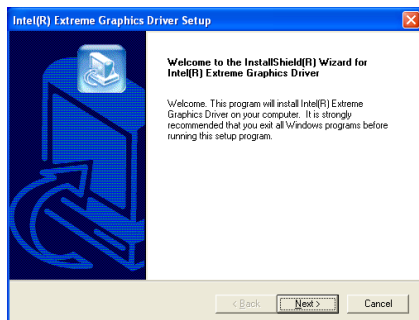

1. Click **“Next>”**.

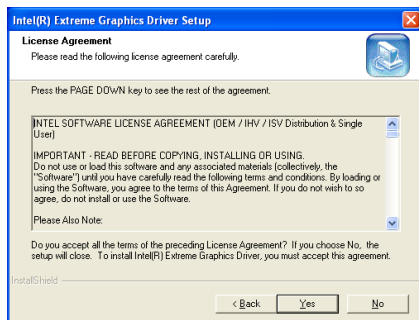

2. Click **“Yes”**.

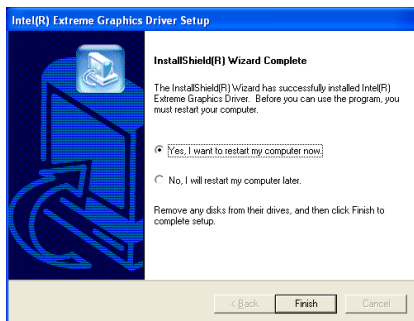

3. Choose **“Yes, I want to restart my computer now”**, and click **“Finish”** to end the installation.



## Appendix G. Install USB 2.0 Driver

**NOTE:** The “USB 2.0 Driver” packed in the “Driver & Utility CD” is currently available for Windows 9x and ME only. To install this driver for Windows XP or Windows 2000, you have to download their latest service pack first from Microsoft’s web site.

To install the USB 2.0 driver for Windows 9x and ME, please insert the Driver & Utility CD into CD-ROM drive. It should execute the installation program automatically. If not, double-click the execution file at the main directory of this CD to enter the installation menu. The following screen appears.



Click [USB 2.0 Driver], and then follow the on-screen instruction to complete the driver installation.



## Appendix H. ABIT EQ (The Hardware Doctor Utility)

ABIT EQ is a self-diagnostic system for PC based on motherboards designed and manufactured by ABIT Computer Corporation. It will protect PC Hardware by monitoring critical items of Power Supply Voltage, CPU & System Fans Speed, and CPU & System Temperature.

The installation procedures and screen shots in this section are based on Windows XP operating system. For those of other OS, please follow its on-screen instruction.

Insert the Driver & Utility CD into CD-ROM drive, it should execute the installation program automatically. If not, double-click the execution file at the main directory of this CD to enter the installation menu.

After entering the installation menu, move your cursor to [ABIT Utility] tab. Click [ABIT EQ]. The following screen appears.

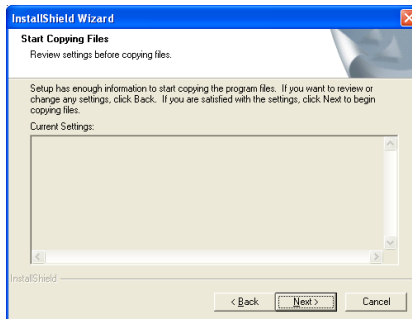

3. Click [Next].

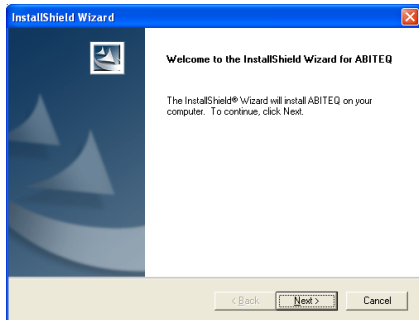

1. Click [Next].

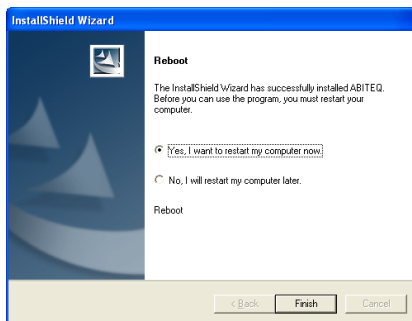

4. Choose [Yes, I want to restart my computer now.] and click [Finish] to complete setup.

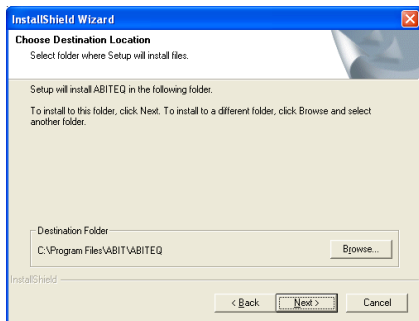

2. Click [Next].



5. Execute the ABIT EQ by entering the Windows Menu [Start] → [Programs] → [ABIT] → [ABIT EQ].



6. This screen appears. ABIT EQ shows you the status of Voltage, Fan Speed, and Temperature readings as well. (The item names in this screen shot are for reference only, may not be exactly the same as what you see on your monitor.)

## Appendix I. FlashMenu (BIOS Update Utility)

ABIT FlashMenu is the most stable Windows-based BIOS flash available. No more worries from crashing. With one click of BIOS updating, ABIT users can flash their BIOS more easily and in less time.

The installation procedures and screen shots in this section are based on Windows XP operating system. For those of other OS, please follow its on-screen instruction.

Insert the Driver & Utility CD into CD-ROM drive, it should execute the installation program automatically. If not, double-click the execution file at the main directory of this CD to enter the installation menu.

After entering the installation menu, move your cursor to [ABIT Utility] tab. Click [FlashMenu]. The following screen appears.

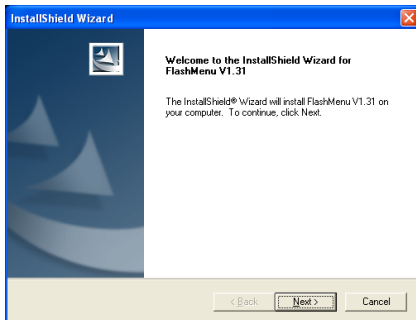

1. Click [Next].

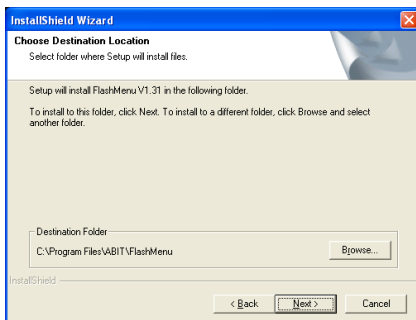

2. Click [Next].

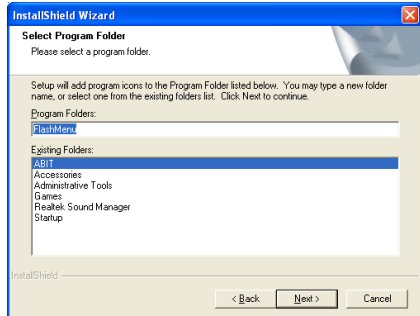

3. Click [Next].

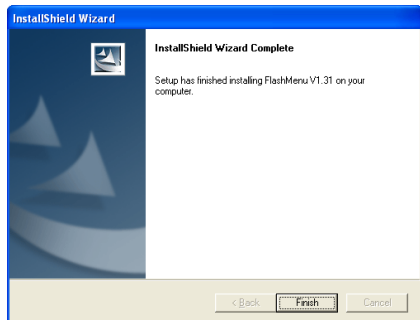

4. Click [Finish] to complete setup.

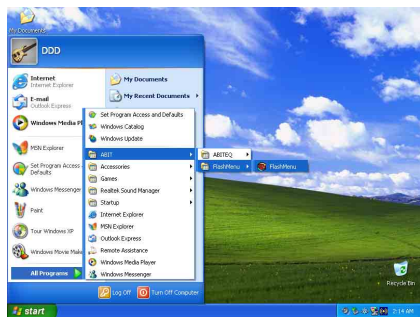

5. Execute the FlashMenu by entering the Windows Menu [Start] → [Programs] → [ABIT] → [FlashMenu].



6. This FlashMenu screen appears. You can easily update the BIOS from clicking [Update From File], [One Click LiveUpdate], or [LiveUpdate Step by Step] button.



---

## Appendix J. Troubleshooting (Need Assistance?)

---

### Q & A:

**Q: Do I need to clear the CMOS before I use a new motherboard to assemble my new computer system?**

A: Yes, we highly recommend that you clear the CMOS before installing a new motherboard. Please move the CMOS jumper from its default 1-2 position to 2-3 for a few seconds, and then back. When you boot up your system for the first time, follow the instructions in the user's manual to load the optimized defaults.

**Q: If my systems hang when I update the BIOS or set the wrong CPU parameters, what should I do?**

A: Whenever you update the BIOS or if the system hangs due to wrong CPU parameters setting, always clear CMOS jumper before booting up again.

**Q: Why the system failed to boot up and nothing was displayed on the screen after I did some over-clocking or non-standard settings inside the BIOS? Is the motherboard dead? Do I need to return it to where I bought from or go through an RMA process?**

A: It should not cause hardware or permanent damage to motherboard when BIOS settings were changed from default to over-clocking or non-standard status.

We suggest the following three troubleshooting methods to discharge CMOS data, recover the hardware default status, and then make the motherboard working again. No need to bother returning the motherboard to where you bought from or go through an RMA process.

**Step 1.** Switch off the power supply unit and then switch it on again after one minute. If there is no power switch on the power supply unit, disconnect its power cord for one minute and then connect it back.

Press and hold the <Insert> key on the keyboard, press the power-on button to boot up system. If it works, loose the <Insert> key and hit <Del> key to enter the BIOS setup page to do the correct settings.

If the situation remains the same, repeat the procedures in Step 1 for three times, or try Step 2.

**Step 2.** Switch off the power supply unit or disconnect the power cord. Open the chassis cover. Locate the CCMOS jumper near the button battery. Change the jumper position from default 1-2 to 2-3 for one minute to discharge the CMOS data, and then put it back to default 1-2 position.

Close the chassis and switch on the power supply unit or plug in the power cord. Press the power-on button to boot up system. If it works, hit <Del> key to enter the BIOS setup page to do the correct settings.

If the situation remains the same, try Step 3.

**Step 3.** The same procedure as Step 2, but in the meantime of discharging the CMOS data, pull out ATX power connectors from motherboard and remove the button battery during CMOS discharging.

**Q: How can I get a quick response to my request for technical support?**

A: Be sure to follow the guidelines as stated in the “Technical Support Form” section of this manual.

If you have a problem during operation, in order to help our technical support personnel quickly determine the problem with your motherboard and give you the answers you need, before filling in the technical support form, eliminate any peripheral that is not related to the problem, and indicate it on the form. Fax this form to your dealer or to the company where you bought the hardware in order to benefit from our technical support. (You can refer to the examples given below)

**Example 1:**

With a system including: motherboard (with CPU, DRAM, COAST...) HDD, CD-ROM, FDD, VGA CARD, MPEG CARD, SCSI CARD, SOUND CARD, etc. After the system is assembled, if you cannot boot up, check the key components of the system using the procedure described below. First remove all interface cards except the VGA card and try to reboot.

**If you still cannot boot up:** Try installing another brand/model VGA card and see if the system will start. If it still does not start, note the VGA card model, motherboard model, Bios identification number, CPU on the technical support form (refer to main instructions), and describe the problem in the problem description space provided.

**If you can boot up:** Insert the interface cards you have removed back into the system, one by one and try to start the system each time you insert a card, until the system will not start. Keep the VGA card and the interface card that caused the problem inserted on the motherboard, remove any other cards or peripheral, and start again. If you still cannot start, note the information related to both cards in the add-on Card space provided, and don't forget to indicate the motherboard model, version, BIOS identification number, CPU (refer to main instructions), and give a description of the problem.

**Example 2:**

With a system including the motherboard (with CPU, DRAM, COAST...) HDD, CD-ROM, FDD, VGA CARD, LAN CARD, MPEG CARD, SCSI CARD, SOUND CARD, after assembly and after having installed the Sound Card Driver, when you restart the system, when it runs the Sound Card Driver, it resets automatically. This problem may be due to the Sound Card Driver. During the Starting DOS... procedure, press SHIFT (BY-PASS) key, to skip CONFIG.SYS and AUTOEXEC.BAT; edit CONFIG.SYS with a text editor, and in function the line that loads the Sound Card Driver, add a remark REM, in order to disable the Sound Card Driver. See the example below.

```
CONFIG.SYS:
DEVICE=C:\DOS\HIMEM.SYS
DEVICE=C:\DOS\EMM386.EXE HIGHSCAN
DOS=HIGH, UMB
FILES=40
BUFFERS=36
REM DEVICEHIGH=C:\PLUGPLAY\DWCFMG.MSYS
LASTDRIVE=Z
```

Restart the system. If the system starts and does not reset, you can be sure that the problem is due to the Sound Card Driver. Write down the Sound Card model, motherboard model, BIOS identification number on the technical support file (refer to main instructions), and describe the problem in the space provided.

We will show you how to fill the “**Technical Support Form**”.

**Main instructions:**

To fill in this “**Technical Support Form**”, refer to the step-by-step instructions given below:

- 1\*. **MODEL:** Note the model number given in your user’s manual.  
Example: IS7-G, IS7, IS7-E, IS7-E2, IS7-E2G, IS7-E2V, IS7-M, IS7-V2
- 2\*. **Motherboard model number (REV):** Note the motherboard model number labeled on the motherboard as “REV:\*.\*\*”.  
Example: REV: 1.06
- 3\*. **BIOS ID and Part Number:** See the on screen message.
4. **DRIVER REV:** Note the driver version number indicated on the DEVICE DRIVER disk (if any) as “Release \*.\*”. For example:
 

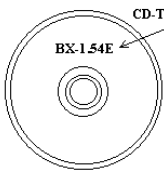

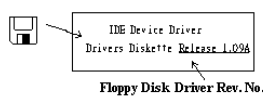
- 5\*. **OS/APPLICATION:** Indicate the operating system and applications you are running on the system.  
Example: MS-DOS® 6.22, Windows® 98 SE, Windows® 2000, etc....
- 6\*. **CPU:** Indicate the brand and the speed (MHz) of your CPU.  
Example:(A) In the “Brand” space, write “Intel”; in the “Specifications” space, write “Pentium® 4 1.9GHz”.
7. **HDD:** Indicate the brand and specifications of your HDD(s); specify if the HDD is using IDE1 or IDE2. If you know the disk capacity, indicate it and check (“✓”) “”; in case you give no indication, we will consider that your HDD is “IDE1” Master.  
Example: In the “HDD” space, check the box; in the Brand space, write “Seagate”; in the Specifications space, write “ST31621A (1.6GB)”.
8. **CD-ROM Drive:** Indicate the brand and specifications of your CD-ROM drive. Specify if it uses  IDE1 or IDE2 , and check (“✓”) “”; in case you give no indication, we will consider that your CD-ROM is “IDE2” Master.  
Example: In the “CD-ROM drive” space, check the box, in the Brand space, write “Mitsumi”, in the Specifications space, write “FX-400D”.
9. **System Memory (DDR SDRAM):** Indicate the brand and specifications (DDR DIMM) of your system memory. Such as Density, Description, Module Components, Module Part Number, CAS Latency, and Speed (MHz).  
For example: In the Brand space, write “**Micron**”; in the Specifications space, write: **Density:** 128MB, **Description:** SS 16 Megx72 2.5V ECC Gold, **Module Components:** (9) 16 Megx 8, **Module Part Number:** MT9VDDT1672AG, **CAS Latency:** 2, **Speed (MHz):** 200 MHz.  
Please give us the detailed information of your DDR SDRAM module; it will help us to simulate the problems you met.
10. **ADD-ON CARD:** Indicate which add-on cards you are *absolutely sure* are related to the problem. If you cannot identify the problem’s origin, indicate all the add-on cards inserted into your system.

**NOTE:** Items between the “\*” are absolutely necessary.



## Technical Support Form

**Company Name:**

**Phone Number:**

**Contact Person:**

**Fax Number:**

**E-mail Address:**

Model	*	BIOS ID #	*
Motherboard Model No.		DRIVER REV	
OS/Application	*		
Hardware Name	Brand	Specifications	
CPU	*		
HDD	<input type="checkbox"/> IDE1 <input type="checkbox"/> IDE2		
CD-ROM-Drive	<input type="checkbox"/> IDE1 <input type="checkbox"/> IDE2		
System Memory			
ADD-ON CARD			

Problem Description:

---



---



---



---



---



---



---



---



---



---



---



---

## Appendix K. How to Get Technical Support

---

(From our website) <http://www.abit.com.tw>

(In North America) <http://www.abit-usa.com>

(In Europe) <http://www.abit.nl>

Thank you for choosing ABIT products. ABIT sells all our products through distributors, resellers and system integrators; we have no direct sales to end-users. Before sending email for tech support please check with your resellers or integrators if you need any services, they are the ones who sold you your system and they should know best as to what can be done, how they serve you is a good reference for future purchases.

We appreciate every customer and would like to provide the best service to you. Providing fast service to our customers is our top priority. However we receive many phone calls and a huge amount of email from all over the world. At the present time it is impossible for us to respond to every single inquiry. Therefore it is quite possible that if you send an email to us that you may not receive a response.

We have done many compatibility tests and reliability tests to make sure our products have the best quality and compatibility. In case you need service or technical support, please understand the constraint we have and **always check with the reseller who sold the product to you first.**

To expedite service, we recommend that you follow the procedures outlined below before contacting us. With your help, we can meet our commitment to provide the best service to the **greatest number of ABIT customers:**

- 1. Check the Manual.** It sounds simple but we have taken a lot of care in making a well-written and thorough manual. It is full of information that doesn't only pertain to motherboards. The CD-ROM included with your board will have the manual as well as drivers. If you don't have either one, go to our Program Download Area of the Website or FTP server.
- 2. Download latest BIOS, software or drivers.** Please go to our Program Download area on our Website to check to see if you have the latest BIOS. They are developed over periods of time to fix bugs or incompatibilities. **Also please make sure you have the latest drivers from your peripheral cards makers!**
- 3. Check the ABIT Technical Terms Guide and FAQ on our Website.** We are trying to expand and make the FAQs more helpful and information rich. Let us know if you have any suggestions. For hot topics, check out our HOT FAQ!

4. **Internet Newsgroups.** They are a great source of information and many people there can offer help. ABIT's Internet News group, [alt.comp.periphs.mainboard.abit](mailto:alt.comp.periphs.mainboard.abit), is an ideal forum for the public to exchange information and discuss experiences they have had with ABIT products. Many times you will see that your question has already been asked before. This is a public Internet news group and it is reserved for free discussions. Here is a list of some of the more popular ones:

[alt.comp.periphs.mainboard.abit](mailto:alt.comp.periphs.mainboard.abit)

[comp.sys.ibm.pc.hardware.chips](mailto:comp.sys.ibm.pc.hardware.chips)

[alt.comp.hardware.overclocking](mailto:alt.comp.hardware.overclocking)

[alt.comp.hardware.homebuilt](mailto:alt.comp.hardware.homebuilt)

[alt.comp.hardware.pc-homebuilt](mailto:alt.comp.hardware.pc-homebuilt)

5. **Ask your reseller.** Your ABIT authorized distributor should be able to provide the fastest solution to your technical problem. We sell our products through distributors who sell to resellers and stores. Your reseller should be very familiar with your system configuration and should be able to solve your problem much more efficiently than we could. After all, your reseller regards you as an important customer who may purchase more products and who can urge your friends to buy from him or her as well. They integrated and sold the system to you. They should know best what your system configuration is and your problem. They should have reasonable return or refund policies. How they serve you is also a good reference for your next purchase.
6. **Contacting ABIT.** If you feel that you need to contact ABIT directly you can send email to the ABIT technical support department. First, please contact the support team for the branch office closest to you. They will be more familiar with local conditions and problems and will have better insight as to which resellers offer what products and services. Due to the huge number of emails coming in every day and other reasons, such as the time required for problem reproduction, we will not be able to reply to every email. Please understand that we are selling through distribution channels and don't have the resources to serve every end-user. However, we will try to do our best to help every customer. Please also remember that for many of our technical support team English is a second language, you will have a better chance of getting a helpful answer if your question can be understood in the first place. Be sure to use very, simple, concise language that clearly states the problem, avoid rambling or flowery language and always list your system components. Here is the contact information for our branch offices:
7. **RMA Service.** If your system has been working but it just stopped, but you have not installed any new software or hardware recently, it is likely that you have a defective component. Please contact the reseller from whom you bought the product. You should be able to get RMA service there.

**North America, South America**     **ABIT Computer (U.S.A.) Corporation**  
 45531 Northport Loop West, Fremont CA, 94538,  
 U.S.A.  
 Tel: 1-510-623-0500  
 Fax: 1-510-623-1092  
 Sales: [sales@abit-usa.com](mailto:sales@abit-usa.com)  
 Latin America Sales: [ventas@abit-usa.com](mailto:ventas@abit-usa.com)  
 Marketing: [marketing@abit-usa.com](mailto:marketing@abit-usa.com)  
 Web Site: <http://www.abit-usa.com>

**RMA Center**     46808 Lakeview Blvd. Fremont, CA 94538, U.S.A.

**UK and Ireland**     **ABIT Computer (U.K.) Corporation Ltd.**  
 Unit 3, 24-26 Boulton Road, Stevenage, Herts SG1  
 4QX, UK  
 Tel: 44-1438-228888  
 Fax: 44-1438-226333  
 E-mail: [sales@abitcomputer.co.uk](mailto:sales@abitcomputer.co.uk)

**Germany and Benelux (Belgium, Netherlands, Luxembourg), France, Italy, Spain, Portugal, Greece, Denmark, Norway, Sweden, Finland, and Switzerland**     **AMOR Computer B.V. (ABIT's European Office)**  
 Van Coehoornstraat 7, 5916 PH Venlo, The  
 Netherlands  
 Tel: 31-77-3204428  
 Fax: 31-77-3204420  
 Sales: [sales@abit.nl](mailto:sales@abit.nl)  
 Web Site: <http://www.abit.nl>

**Austria, Czech, Romania, Bulgaria, Slovakia, Croatia, Bosnia, Serbia, and Macedonia**     **Asguard Computer Ges.m.b.H**  
 Schmalbachstrasse 5, A-2201 Gerasdorf / Wien,  
 Austria  
 Tel: 43-1-7346709  
 Fax: 43-1-7346713  
 E-mail: [asguard@asguard.at](mailto:asguard@asguard.at)

**Shanghai**     **ABIT Computer (Shanghai) Co. Ltd.**  
 Tel: 86-21-6235-1829  
 Fax: 86-21-6235-1832  
 Web Site: <http://www.abit.com.cn>

**Russia and CIS**     **ABIT Computer (Russia) Co. Ltd.**  
 Sales: [sales@abit.ru](mailto:sales@abit.ru)  
 Info: [info@abit.ru](mailto:info@abit.ru)  
 Web Site: <http://www.abit.ru>

---

**Poland**     **ABIT Computer (Poland) Co. Ltd.**  
 Przedstawicielstwo w Polsce ul. Wita Stwosza 28  
 50-149 Wrocław  
 Tel: 48 71 780 78 65 / 66  
 Fax: 48 71 372 30 87

---

**Japan**     Web Site: <http://www.abit4u.jp>

---

**Taiwan Head Office**     **ABIT Computer Corporation**  
 (Serving all other territories  
 not listed above.  
 Taiwan is 8+ GMT time,  
 and may have different holiday  
 calendar from yours.)  
 No. 323, Yang Guang St., Neihu, Taipei, 114,  
 Taiwan  
 Tel: 886-2-8751-8888  
 Fax: 886-2-8751-3382  
 Sales: [sales@abit.com.tw](mailto:sales@abit.com.tw)  
 Marketing: [market@abit.com.tw](mailto:market@abit.com.tw)  
 Web Site: <http://www.abit.com.tw>

---

- 8. Reporting Compatibility Problems to ABIT.** Because of tremendous number of email messages we receive every day, we are forced to give greater weight to certain types of messages than to others. For this reason, any compatibility problem that is reported to us, giving detailed system configuration information and error symptoms will receive the highest priority. For the other questions, we regret that we may not be able to reply directly. But your questions may be posted to the Internet news group in order that a larger number of users can have the benefit of the information. Please check the news group from time to time.

**Thank You**

**ABIT Computer Corporation**

**<http://www.abit.com.tw>**



## Free Manuals Download Website

<http://myh66.com>

<http://usermanuals.us>

<http://www.somanuals.com>

<http://www.4manuals.cc>

<http://www.manual-lib.com>

<http://www.404manual.com>

<http://www.luxmanual.com>

<http://aubethermostatmanual.com>

Golf course search by state

<http://golfingnear.com>

Email search by domain

<http://emailbydomain.com>

Auto manuals search

<http://auto.somanuals.com>

TV manuals search

<http://tv.somanuals.com>