

Acesonic®

DGX-212

HDMI Multi-Format Karaoke Player

with 4X CDG to MP3G Converter with Digital Recording



User Manual v.1.0

NOTE: To ensure this system works safely and to its fullest potential, please read the User Manual carefully before use and keep it handy for future reference.

CAUTION:

To assure this player will work at its best, please read this user's manual carefully before operation and keep for future reference.

www.acesonic.com

Acesonic DGX-212

Thank you for purchasing Acesonic's DGX-212 HDMI Multi-Format Karaoke Player with Digital Recording. Acesonic takes pride in providing its customers with only the most advanced and highest quality products on the market.

With proper care and use you will get many years of satisfying use from your Acesonic product.

Be sure to keep original packaging in case re-shipping is required for returns or repairs.

Care and cleaning: Use a slightly damp cloth to clean the front panel and other surfaces of the DGX-212. Do not use the device in areas that are wet or prone to dampness. Always allow enough room below and around the device to provide sufficient air flow for cooling when it is being used.

First Things First

Included Accessories

Please check that you have all of the following accessories supplied to you. If anything is missing, please contact your dealer immediately.

- RCA Composite (Yellow/Red/White)
- Audio/Video Cable (1)
- Remote Control (1)
- User's Manual (1)

Table of Contents

First Things First	1
Important Information Before You Start...	2
Compatible Video Formats	3
Front Panel Functions and Operations...	4
Back Panel Functions and Operations ...	4
Remote Control Functions	5
Player Connections.....	7
Basic Operation: Playback.....	9
Playback from USB and SD Cards	9
Basic Operation: Karaoke.....	10
Basic Operation: System Setup	11
Basic Operation: Language Setup.....	12
Recording & CDG Disc Ripping	14
Ripping CDG Disc into MP3G files.....	15
Other Advanced Operations	16
Creating song list	17
Song Searching/Programing	17
Troubleshooting Chart 1.....	18
Troubleshooting Chart 2.....	19
Safety, Warnings and Precautions.....	20
Technical Specifications & Contact Information.....	22

NOTE

Your Acesonic DGX-212 HDMI Multi-Format Karaoke Player with Digital Recording arrives with everything you need to start making music and converting ("ripping") CD+G files to the MP3+G format. If you need speakers or other audio components, they can be obtained from Acesonic, or you can use any standard audio equipment that conforms to contemporary standards. If you are familiar with audio equipment, use the enclosed Quick Start Guide for setup. Please fill out your Warranty Registration Card and return it right away.

Before Operation

About This Manual

The display window information and On Screen Display (OSD) items are all in UPPER CASE letters.

Precautions

Power Cord: When you are away on travel or won't use the DGX-212 for an extended period of time, unplug the unit from the wall outlet.

When unplugging the player from the wall outlet, always pull the plug, not the cord.

Do NOT handle the power cord with wet hands.

Avoid moisture, water and dust

Do not place the player in a moist environment or in an area where there might be an excessive amount of dust build up (e.g. near a fan).

If water or any liquid should get into the unit, turn off the power and unplug the unit from the wall outlet immediately. Consult your dealer or an authorized repair station. Using the unit in this state may lead to fire or electrical shock.

Avoid high temperatures.

Do not expose the player to direct sunlight or place near any heating device.

Notes on Installation

Select a place where the unit will be level, dry, and not too cold or hot.

Do not use unit on its side or where subject to vibrations (e.g. speakers).

Leave sufficient distance between the TV and unit.

Do not leave heavy objects on top of unit.

Prevent Unit Malfunction

No parts in this unit are user-serviceable. If the unit no longer functions, unplug it from the wall outlet and contact your dealer for service options.

Never block the vents on the unit. Vents are used to circulate air and keep the temperature of the player down. Blocking the vents may result in damage of the unit.

Important Information Before You Start

Compatible Media and File Formats

This unit supports the following disc and file formats:

DVD, AVI, Video CD, Video CD 2.0

CD+Graphics, Audio CD, HDCD

MP3, MP3+G, JPEG, Kodak, MPEG

Above media is playable on the following discs:

DVD±R, DVD±RW, DVD±R DL, DVD±RW DL, CD-R/RW

Card reader compatible formats:

SD Memory Card (FAT32 format only).

Important Reminders

Any disc that is not listed above will cause the player to display NO DISC in the Display Window. Future media and disc formats maybe supported with firmware upgrades, when available.

Encoding methods of some media formats may affect playback, e.g., unable to fast forward, long load time, etc. Be sure that the encoding process conforms to the standards for that particular format.

Dirty, scratched, warped and defective discs may cause a considerable time delay during the loading and reading of data. In extreme cases, such conditions may render the disc completely unreadable by the player.

Video Signal Formats

This player accommodates both NTSC and PAL systems, with automatic detection and override settings.

Digital Audio Formats

This player accommodates stereo, analog and several high-resolution digital audio signals.

Note: Depending on AUDIO SETUP > SPDIF settings, digital audio signals may not be output as they are recorded on the disc.

Before Operation

Notes Regarding Discs

With some DVDs, the player starts playback automatically after inserting the disc, whether or not PLAYBACK CONTROL is on or off.

The image may be poor, noisy or grainy due to defects on the actual disc, and some functions as described in this manual may not be possible on all discs.

Maintenance of Discs

Handling

When handling discs, always hold them from their edges and/or by the circle in the center.

NEVER write on the any surface of the disc for it may render the disc unreadable.

Store discs in a clean and dry environment. Storing CDs vertically will also help prevent warping.

After use, insert CD into jacket or case to minimize wear and tear. DO NOT stack CDs on top of one another.

Do not bend or press the disc. Do not expose the disc to direct sunlight or any heat source.

Cleaning

Wipe the discs from time to time using a soft cloth. Always wipe from the center towards the edges, NOT in circular motions.

DO NOT clean with any other cleaning solution, unless it is specifically made for disc cleaning.

CDs revolve at very high speeds inside of players. Never attempt to play cracked or warped CDs, since doing so may cause the disc to shatter or the player to malfunction.

Power Cord

Handle the power cord only by its plug, and do not unplug it by yanking on the cord. Touching the cord while your hands are wet may lead to an electric shock or a short circuit.

If the cord becomes damaged or its wires become exposed, please replace the cord as soon as possible in order to prevent an electric fire or shock. Check the power cord every few months to ensure it is functioning properly.

Compatible Video Formats

Type	USB/SD Card Supported?	Disc Supported?
DivX 4.12 (AVI)	Yes	Yes
DivX 5.02 (AVI)	Yes	Yes
DivX 5.20 (AVI)	Yes	Yes
DivX 5.21 (AVI)	Yes	Yes
XVID (AVI)	Yes	Yes
DivX 6.0 (AVI)	Yes	Yes
DivX 5.11 (AVI)	Yes	Yes
DivX 3.11 (AVI)	No	No
DivX 7.0	No	No
MP4	Yes	Yes
MPEG-1	Yes	Yes
MPEG-2	Yes	Yes
VOB	No	Yes
DAT	Yes	Yes

FRONT PANEL FUNCTIONS AND OPERATION:

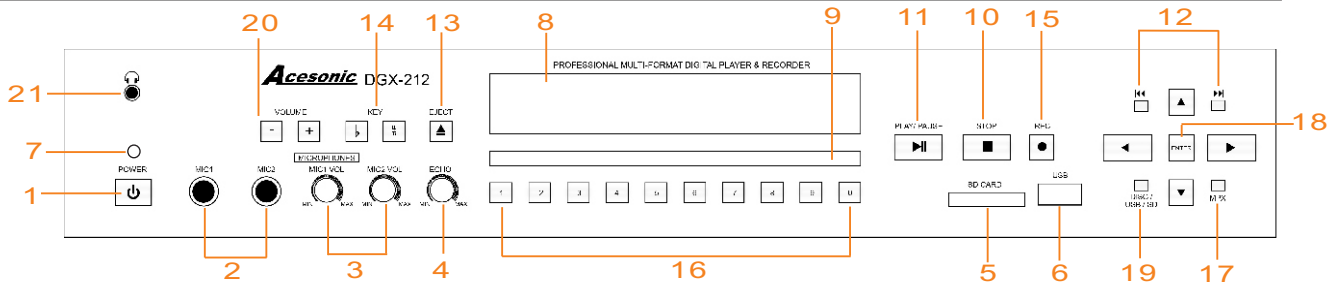

1. **POWER** - Press the button to turn the unit on or off.
2. **MIC 1 & 2 INPUT jacks** - Connects microphones with 1/4 in. plugs.
3. **MIC 1 & 2 VOL knob** - Control the volume output from MIC CHANNEL 1 and 2.
4. **ECHO Button** - Control the amount of ECHO(delay) applied to MIC CHANNELS 1 and 2.
5. **SD CARD READER** - Play or record MP3+G songs. We would recommend using high speed (class 4 or higher) SDHC (Secure Digital High Capacity) cards for smooth recording and playback. Note: Reader supports FAT32 format only.
6. **USB INTERFACE** - Connect USB devices such as flash drives or external hard drives. You can play MP3, VCD, MP3+G audio files. Note: USB connection supports FAT32 format only.
7. **REMOTE SENSOR window**- Receive signals from remote control.
8. **DISPLAY WINDOW** - Displays player status such as time, disc format and song number. If no disc is in the tray, the display window will display NO DISC. Detailed information will also be shown on the TV screen if connected.
9. **DISC TRAY** - Press to open tray. Press or to close the tray, it will play the disc automatically.
10. **STOP** - Stops playing and recording.
11. **PLAY/PAUSE** - Press to start playing the disc or temporarily suspend playing.
12. **PREV** or **NEXT** - Press to go to the previous or next track
13. **OPEN/CLOSE** - Used to open and close disc tray.
14. **KEY CONTROL Buttons**- The - button flattens by a half tone, while the + button sharpens by a half tone.
15. **RECORD Button** - Press this button to start recording singing (audio MP3 file only) from VCD or CD discs, or record MP3+G(A/V files) from CDG or MP3G disc files. See the following page for more information.
16. **NUMERIC KEYS 0-9**: Input track selections or programming commands. Note: In the Play Back Control (PBC) function operation, the number keys are also used to select menu items.
17. **Multiplex(MPX)**- Selects Left/Right, MONO, and Stereo audio output for CDs and audio track for DVDs.
18. **ENTER** - Confirm selections.
19. **DVD/USB** - Switches between DVD mode, USB mode and CARD mode.
20. **Master Volume Control** - Controls the overall music or audio volume of the player.
21. **Headphone Output Jack** - Listen to your music or movies in private.

BACK PANEL FUNCTIONS AND OPERATION:

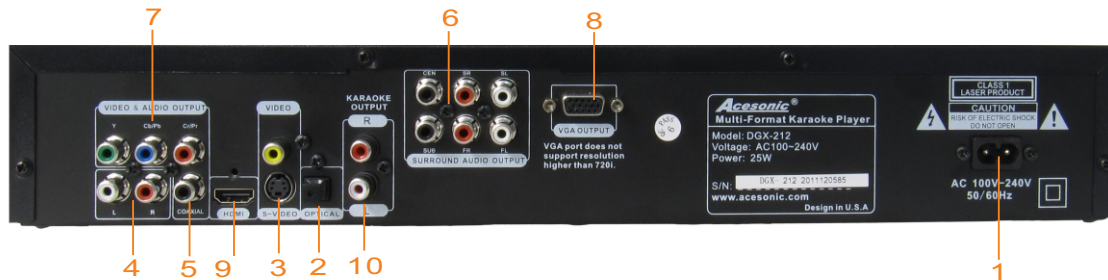

1. **ELECTRIC PLUG** - Connection to auto-detect AC power supply (100-240V,50-60 Hz).
2. **OPTICAL OUTPUT** - Connects to digital amplifier or receiver for surround sound. Change settings in the SETUP menu first, as follows: SETUP > AUDIO SETUP > SPDIF OUTPUT > SPDIF/RAM OR SPDIF/PCM. Note: Karaoke does not work with OPTICAL output.
3. **S-VIDEO OUTPUT** - Output for S-VIDEO.
4. **STEREO OUTPUTS** - Yellow RCA outputs for use in TVs with composite inputs.
5. **COAXIAL OUTPUT** - Connects to digital amplifier or receiver for surround sound. Change in the SETUP menu first, as follows: SETUP > AUDIO SETUP > SPDIF OUTPUT > SPDIF/RAM OR SPDIF/PCM. Note: Karaoke does not work with COAXIAL output.
6. **5.1 CHANNEL AUDIO OUTPUT** - RCA outputs for analog 5.1 digital output. To use 5.1 channels, press 5.1CH on the remote or change settings in the SETUP menu before using 5.1 channels. See below. SETUP> SPEAKER SETUP> DOWNMIX> OFF SUBWOOFER>ON
7. **COMPONENT VIDEO OUTPUT**- Video output for use Y,Pb,Pr component cables.
8. **VGA VIDEO OUTPUT**- Video output using VGA cables.
9. **HDMI AUDIO/VIDEO OUTPUT**- music A/V & karaoke vocal output by using HDMI cable.
10. **Karaoke Output** - Red and white RCA outputs for mixed vocals and music audio output. We recommend to use this output or HDMI output for karaoke experience.

Remote Functions



- 1. POWER BUTTON** - Turns the player on or off.
- 2. SD CARD** - Press to change to SD card mode.
- 3. MUSIC BUTTON** - In USB/SD Card mode, use this button to call out all the music files and display on the screen.
- 4. GUI SWITCH** - Press the button to switch between windows and playback display mode. See more detail on page 17.
- 5. SHARP BUTTON (#)** - Raises the key by a half tone.
LOW BUTTON (b) - Lower the key by a half tone
NATURAL BUTTON - Go back to original key tone.
- 6. TITLE BUTTON** - DVD's have an indication number which makes it easier to locate chapters.
- 7. MENU BUTTON** - Press MENU once to return to the root menu for DVD's.
- 8. PLAY BUTTON** - Press to begin playback or to close disc tray and begin playing automatically.
- 9. NUMBER KEY 0-9** - Input numbers for track selection or programming purposes. In the PBC function, the number keys are also used to select
- 10. CLOSE/EJECT BUTTON**
- 11. USB PORT** - Press to change to USB mode if a USB device is connected.
- 12. DVD DISC** - Press to change to disc mode.
- 13. NAME INDEX BUTTON** - Use this button to do song search by song name in the DISC/USB/SD mode. There must be a name in the song name (ex: love from 1001_love.mp3) to make this function work. See more detail on page 17.
- 14. NUMBER INDEX BUTTON** - Use this button to do song search by song-number in the DISC/USB/SD mode. There must be a song number in the song name (ex: 1001 from 1001_love.mp3) to make this function work. See more detail on page 17.
- 15. RECORD BUTTON** - Record singing (audio MP3 file only) from CD/VCD discs or record MP3+G (A/V files) from CDG/MP3G discs or files. * Ripping a single or multiple files from CDG disc, simply press DISC RIPPING(#45) button to start ripping process.
- 16. MUSIC VOL** - Adjust the volume of music audio output.
- 17. PLAYBACK BUTTON** - After recording your singing, you can use this button to playback right away.
- 18. ENTER & DIRECTION BUTTONS** - Use the direction buttons for navigation in selection menu and use the enter button to confirm entry or selection.
- 19. SETUP BUTTON** - Open SETUP menu, see the following pages for more detail .
- 20. SUBTITLE BUTTON** - With DVD discs, press SUBTITLE repeatedly until the desired language is

Remote Functions



21. STEP BUTTON- Press to play the frame step by step.

Press the PLAY button once to return to normal playback.

22. STOP BUTTON - Press to STOP playback.

23.RETURN BUTTON - This button is used to return to a menu screen while playing.

24. >>> SKIP FORWARD BUTTON - Press to go to the beginning of the next track. <<<< **SKIP BACKWARD BUTTON** - Press to go to the beginning of the current or previous track.

25. AUDIO: Select audio sound track options for DVD discs.

26. ZOOM BUTTON - Enlarge a section of video or picture currently being viewed.

27. CREATE SONGLIST BUTTON - If you have files in a Disc,SD CARD or USB MODE. You can use this function to scan songs in the storage device and create a song list into a text file for further use. Please redo this function whenever the content has been changed(song add/delete)

28. PHOTO BUTTON - In USB/SD Card mode, use this button to call out all the photo files and display on the screen.

29. MOVIE BUTTON - In USB/SD Card mode, use this button to call out all the movie files and display on the screen.

30. A-B BUTTON - A-B REPEAT function allows you to repeat a segment of a track until stopped. To use this function:

1. Set a starting point A. 2. Set an end point B. Afterwards, the unit plays from A to B.3. Press A-B again, till A-B disappears.

31. REPEAT BUTTON - Allows you to repeat a track or disc.

1. Repeat a track - Press REPEAT, the screen shows REP ONE, the unit plays the current track.

32.FWD>>> <<<< REW BUTTONS - Press FWD to shift the playing location forward quickly. Press REW to shift the playing location backwards quickly.

33. DISPLAY BUTTON - Show the elapsed or remaining time for single track or the entire disc.

34. PBC BUTTON - This function is only available for video-cd version 2.0 or higher. The function of PBC may differ by different discs. When PBC mode is on, users can select items in the menu by using the PREVIOUS/NEXT keys. When PBC mode is off, users can not select items in the menu, but you can use the numeral keys directly or the PREVIOUS/NEXT keys.

35. P/N BUTTON - PAL/NTSC switch.

2. Repeat all - Press REPEAT, the screen shows REP ALL, the unit plays all the tracks on the disc.

36. ANGLE BUTTON - With DVDs, select multi-angle views.

37. DISC RIPPING BUTTON - Used to rip whole CD+G disc or just one track into SD card or USB storage. see more details on page 12.

38. MPX - Switch between the left mono, the right mono or stereo sounds. Use to turn vocals on/off on multiplex CD+G or VCD disc. For DVD disc, use AUDIO button (#32) to switch audio channel.

Player Connections

USB & SD CARD

Note:
 Note: We cannot guarantee this machine will read and play all USB memory devices. See more information on page 9. For smooth recording and playback, we recommend using USB version 2.0 and SD cards that are Class 4 or higher. Please see page 3 for supported files and formats when using the USB/SD CARD MODE.

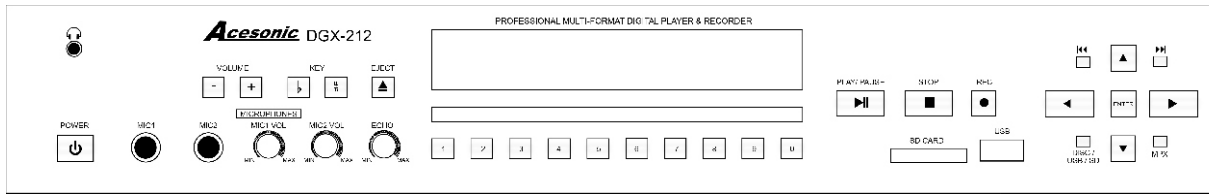

NOTE: Your DGX-212 has a variety of ways to provide you audio and video. The RCA Composite cable is included with the unit, and you can buy cables from Acesoic USA, Inc. to access the unit's HDMI, S-video, Component Video and digital output formats (coaxial and optical). In addition, you can employ a variety of USB flash drives as well as MMC, SD and SDHC memory cards. You can even use Mini- or Micro-SD cards if you use a SD-sized carrier as shown on page 10.

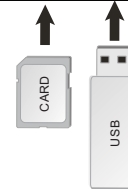

* Please see page 3 for supported files format when playback in the USB/SD card mode.

A/V Connection

Make sure all power is disconnected from each component before connecting. Plug all cords securely to prevent unwanted noise.

You cannot connect this player to a TV that does not contain a video input jack. The player must be connected to a TV, or an amplifier that is connected to a TV or monitor. The TV or amplifier must also contain RCA audio input jacks (left and right channel).

If you wish to use this player in karaoke mode, you must have your player connected as pictured below.

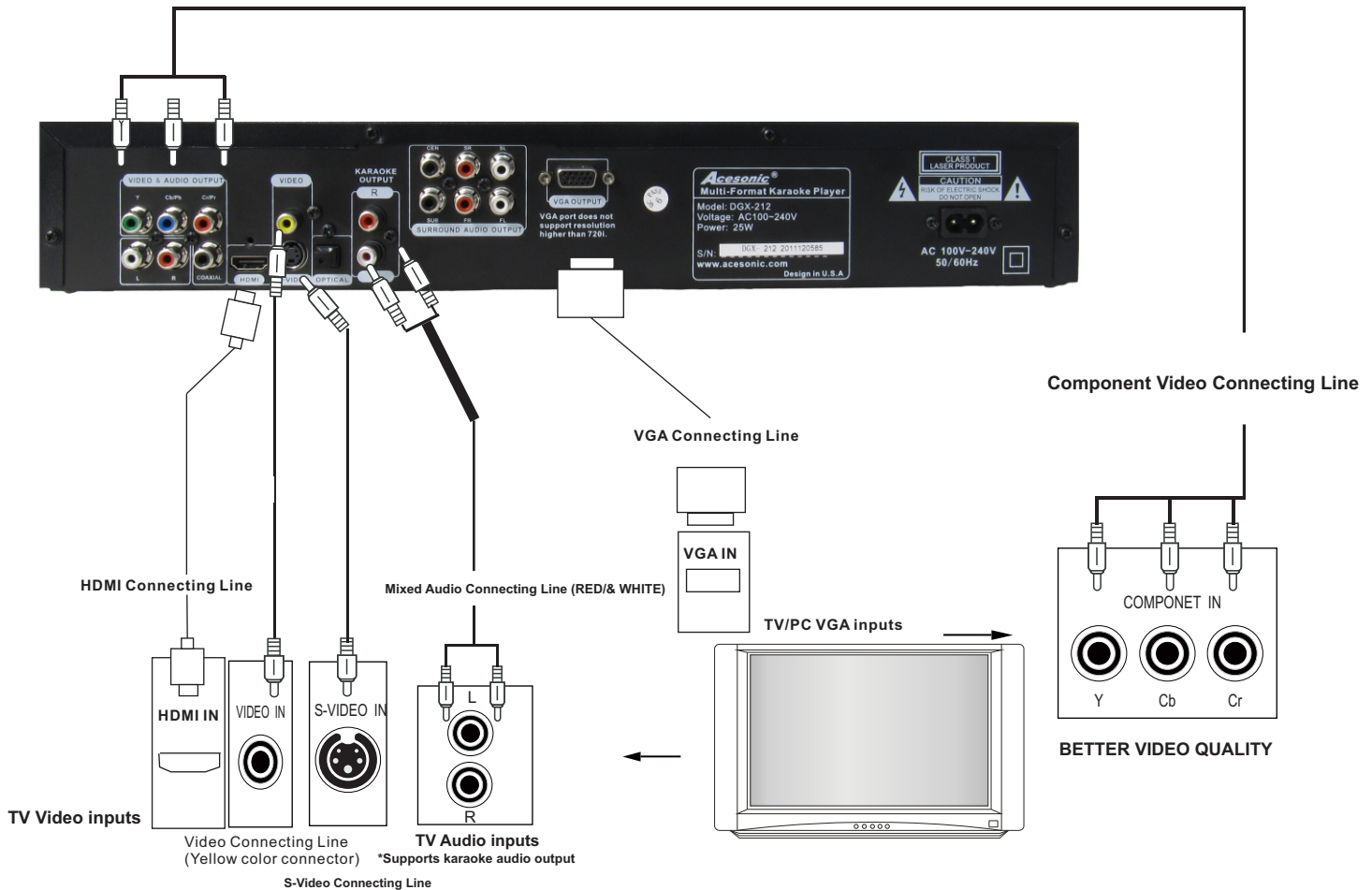

Player Connections

MAKING THE CONNECTION BETWEEN the PLAYER and 5.1 CH. SURROUND SOUND AMPLIFIERS

You can connect this player with 5.1 channel amplifiers as shown below:

***NO Microphone audio will be outputted in 5.1 Channel mode**

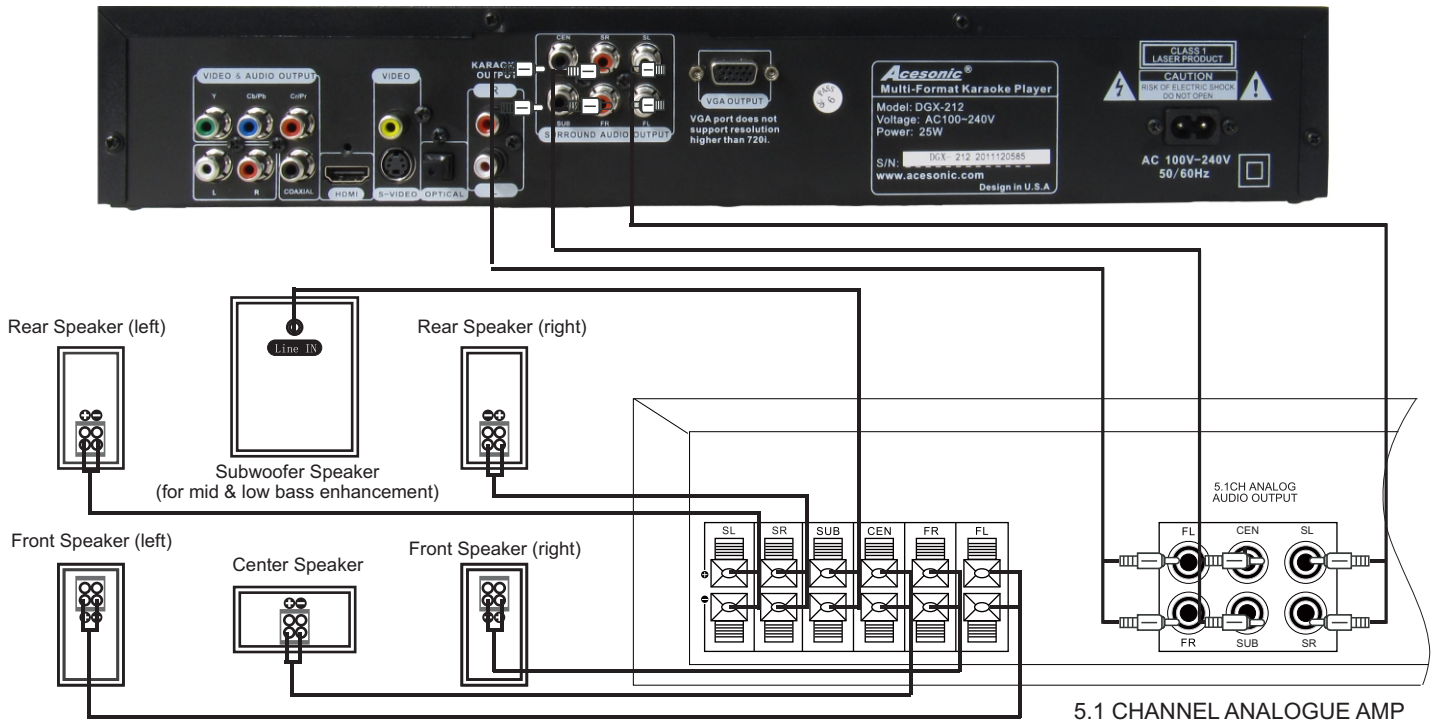

POWER CONNECTION

When you have completed all other connections, plug the power cord into an AC outlet.



Note:
Power supply: 100V-240V 50/60Hz.

This device complies with part 15 of the FCC Rules. Operation is subject to the following two conditions: (1) This device may not cause harmful interference, and (2) this device must accept any interference received, including interference that may cause undesired operation.

Caution: Make sure the voltage of the AC outlet matches the requirement of your karaoke system.

Basic Operation

Basic Playback

Turn on the machine



Loading A Disc

1. Press **EJECT** to open the disc tray.
2. Place a disc in the disc tray.
3. Press **EJECT** to close the disc tray.
4. The Disc will play automatically



If A Menu Is Shown On The TV Screen

When inserting a DVD or VCD disc, a menu may be displayed before playback. From the menu, you may select a desired item to be playback.

For DVD Video

1. Use the arrow keys to select the track desired
2. Press **ENTER** and the player will playback the selected track.

For Video CD

1. Press the numeric buttons to select a desired item. The player starts playback of the selected item.

NOTE

*Do NOT insert a damaged disc

If a disc takes more than usual to read or the DISPLAY WINDOW shows LOAD for an extended period of time, press EJECT on the remote or from the front of the unit and check disc for any dirt/fingerprints or defects.

To End Playback

Press STOP to end playback.

To Resume Playback

On DVDs and VCDs, you can resume playback by pressing the **PLAY** button.

To Stop Playback Completely

Press the **STOP** button twice. Now when you press the **PLAY** button, it will begin from the beginning of the disc. Also, if you eject the disc, playback completely stops and ejects the disc.

To Pause Playback

Press the **PAUSE** button to pause playback. To resume, press either the **PLAY** or **PAUSE** button.

To Advance Or Reverse Playback While Viewing

During playback on DVDs and VCDs, press **FAST FORWARD**>> or **FAST BACKWARD**<< on the remote unit. You can select from 2X, 4X, 8X, 20X the normal playback speed.

*During forward or reverse, the sound will be muted.

Play back from USB and SD card devices

NOTE

This player is not a computer system

and so it cannot support large external hard drives and any storage device containing more than **10,000 files**. For example, 2,000 MP3s files or 2,000 MP3G songs (each MP3G contains 2 files adding up to 4,000 files; .cdg + .mp3 = MP3G).

The DGX-212 may support 2.5" external hard drives that do not require an external power source but we cannot guarantee it will support all models. Acesonic recommends using a USB flash drive formatted to **FAT32** but due to the many different brands available, we cannot guarantee every USB flash drive will work. Please try another brand if you are experiencing compatibility issues.

USB port and operation

You can play your own video and audio files as the DGX-212 supports MP3, CD+G, MP3+G, DVD, AVI and DivX formats that are stored in external memory devices (flash drives, card readers). Note: These devices must be in FAT32 format to play content. See bottom of page 3 for compatible file formats

If no disc is being played, audio and video files from a connected external memory device (USB device or SD card) will automatically be selected and played.

Otherwise, switch to USB playback:

1. Press the STOP button.
2. Press USB PORT button to make the USB menu appear on the screen.
3. Select a song from the song list.
4. Press ENTER to play.
5. Press DVD DISC button to switch back to DVD playback.

SD card slots

You can play video and audio files (MP3, CD+G, MP3+G, DVD, AVI and DivX formats) stored on SD cards by inserting any one of such devices into the slots.

If no disc is being played, the unit will automatically select audio and video files from the external memory devices connected. Note: These devices have to be in FAT32 format to play content.

If you need to switch to memory card playback:

1. Press STOP.
2. Press SD CARD button to make the SD CARD menu appear on the screen.
3. Select a song from the window.
4. Press ENTER to play your selection.

Insert card as below

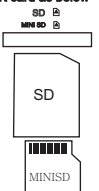

Basic Operation

Karaoke - USING MICROPHONE

The system has 2 microphone inputs for connecting up to 2 microphones at once.

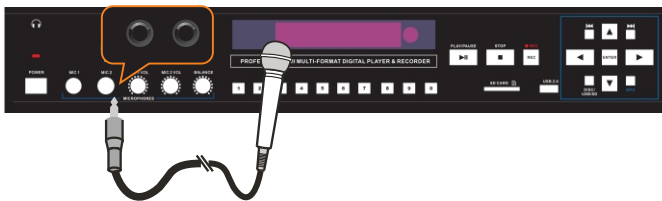

Karaoke - MICROPHONE MIXER

When a microphone is plugged into MIC1 or MIC2, the system mixes the music with your voice.

1. Press POWER to turn on the system.
2. Load a Karaoke Disc.
3. Press PLAY to start playing.
4. Adjust MASTER MUSIC VOLUME on the remote controller.
5. Adjust Microphone volume from front panel.
6. Starting singing while the song is playing.
7. Adjust ECHO level on the remote/front panel to the desired echo level.

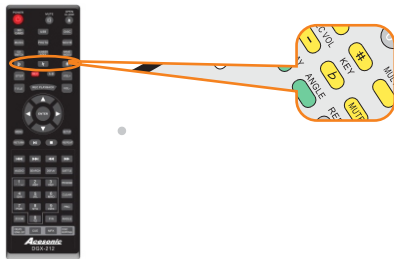

Karaoke - REMOTE CONTROL

The battery compartment is located on the back of the Remote control.

1. Open the lid of the Remote control battery compartment.
2. Insert two (2) AAA batteries. Make sure that the batteries are placed with the positive and negative terminals in the correct directions per the (+) and (-) marks inside the compartment.
3. Replace the lid of the Remote control battery compartment.

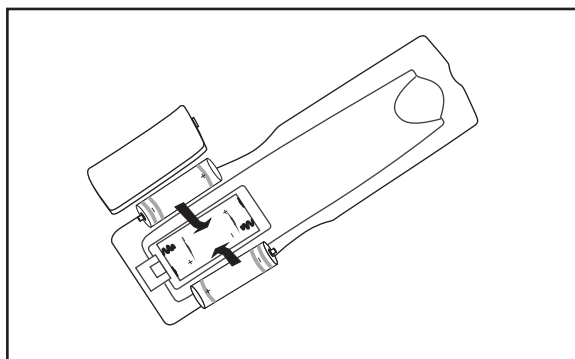

Karaoke - To recording singing(See Page12 -13):

1. Play MP3, CD, CDG, MP3G or VCD song from disc, or MP3, MP3G song from USB or SD card.
2. Insert SD card or USB as a file saving device if you play from disc.
3. Select the song you want to record, and play the song first. Then, press RECORD on the machine or remote to start recording. Will re-play from the beginning and start recording at the same time.
4. Press STOP or RECORD to stop recording, or when the song finishes. The process will automatically end.
5. Press PLAYBACK on the remote to immediately playback the last recorded song you have done.
6. Player will continue playing the next song unless you set CUE OFF from the remote controller.



Rip MP3G from CDG disc(See also Page12 -13):

1. Insert a CDG disc into the disc tray. Insert a SD card or USB device as MP3G file storage.
2. Press DISC RIPPING button on the remote
3. Select ripping speed (1 x or 4 x) and MP3 compression bit rate (higher bitrate results in better sound quality but has a bigger file size) from OPTIONS.
4. Select target tracks from TRACKS option. You can select one, all or specific tracks.
5. After selecting songs, go to START option to process the MP3G ripping.
6. After ripping, exit the window. You can find your ripped songs in Ripping_XX(XX= numbers) folder in SD card or USB storage drive

Scoring function

1. Turn on the scoring function in the setup menu, see page 12 for more detail.
2. When you sing with the scoring function on, the SCORE will show on screen. The score will be displayed at the end of the song.
3. This function only supports in CDG disc mode.

Basic Operation

SYSTEM SETUP

Unload the Disc then:

Press **SETUP KEY** to open the **Setup MENU**.

● TV SYSTEM

- 1) Press Direction KEY [▼] to choose "TV SYSTEM" .
- 2) Press Direction KEY [►] to show Sub-MENU.
- 3) Press Direction KEY [▼/▲] to select the from [NTSC/ PAL/PAL60/AUTO].

● POWER RESUME

- 1) Press Direction KEY [▼/▲] to choose "SCREEN SAVER".
- 2) Press Direction KEY [►] to show Sub-MENU.
- 3) Press Direction KEY [▼/▲] to select "ON" or " OFF".
- 4) Press **ENTER** to confirm it.

If "ON" option is selected, the machine show a screen saver while it stands by.

● VIDEO

- 1) Press Direction KEY [▼/▲] to choose "VIDEO".
- 2) Press Direction KEY [►] to show Sub-MENU.
- 3) Press Direction KEY [▼/▲] to select Video Output Mode.
- 4) Press **ENTER** to confirm it.

* **NOTE:** The Output Mode: PC-VGA/S-VIDEO/COMPONENT. Make sure TV and player is connected properly before making these settings. Beware! PC-VGA output mode does not support HD(720p and up) output! The video will become blurred/mosaics.

● RESOLUTION

- 1) Press Direction KEY [▼/▲] to choose "RESOLUTION".
- 2) Press Direction KEY [►] to show Sub-MENU.
- 3) Press Direction KEY [▼/▲] to select resolution Mode.
- 4) Press **ENTER** to confirm it.

* **NOTE:** The Resolution Output Mode: 480i/720p/1080i/1080p. Please make sure your TV supports the resolutions before making setting changes.

● TV TYPE

- 1) Press Direction KEY [▼/▲] to choose "TV TYPE".
- 2) Press Direction KEY [►] to show Sub-MENU.
- 3) Press Direction KEY [▼/▲] to select TV TYPE.
- 4) Press **ENTER** to confirm it.

* **NOTE:** TV TYPE: 4:3PS, 4:3LB or 16:9. Some discs can not be played as your selection because that disc was not recording in the same format.

● PASSWORD

- 1) Press Direction KEY [▼/▲] to choose "PASSWORD".
- 2) Press Direction KEY [►] to show Sub-MENU.
- 3) Press the **Numeric KEY** to input new password if necessary.
- 4) Press **ENTER** to confirm it.

* **NOTE:** The password should be four numbers. The default password is "0000".

● RATING

- 1) Press Direction KEY [▼/▲] to choose "RATING".
- 2) Press Direction KEY [►] to show Sub-MENU.
- 3) Press Direction KEY [▼/▲] to select the "RATING" if necessary.
- 4) Press **ENTER** to confirm it.

* **NOTE:** "RATING" can be set only in UNLOCK PASSWORD state. This function should be supported by the DISC.

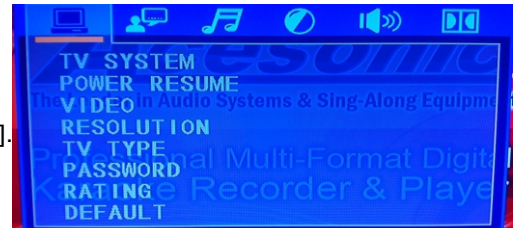

Basic Operation

LANGUAGE SETUP

Unload the Disc then:

Press **SETUP KEY** to open the **Setup MENU**.

Press **Direction KEY** [◀/▶] to select the “**LANGUAGE**

SETUP”. The **Sub-MENU**:

- OSD LANGUAGE
- AUDIO LANGUAGE
- SUBTITLE LANGUAGE
- MENU LANGUAGE

● **OSD LANGUAGE**

- 1) Press **Direction KEY** [▼/▲] to choose “**OSD LANGUAGE**”.
- 2) Press **Direction KEY** [▶] to show **Sub-MENU**.
- 3) Press **Direction KEY** [▼/▲] to select the language.
- 4) Press **ENTER** to confirm it.

● **AUDIO LANGUAGE**

- 1) Press **Direction KEY** [▼/▲] to choose “**AUDIO LANGUAGE**”.
- 2) Press **Direction KEY** [▶] to show **Sub-MENU**.
- 3) Press **Direction KEY** [▼/▲] to select the Language [CHINESE, ENGLISH, JAPANESE, FRENCH, SPANISH...].
- 4) Press **ENTER** to confirm it.

● **SUBTITLE LANGUAGE**

- 1) Press **Direction KEY** [▼/▲] to choose “**SUBTITLE LANGUAGE**”.
- 2) Press **Direction KEY** [▶] to show **Sub-MENU**.
- 3) Press **Direction KEY** [▼/▲] to select the Language [CHINESE, ENGLISH, JAPANESE, FRENCH, SPANISH...].
- 4) Press **ENTER** to confirm it.

● **MENU LANGUAGE**

- 1) Press **Direction KEY** [▼/▲] to choose “**MENU LANGUAGE**”.
- 2) Press **Direction KEY** [▶] to show **Sub-MENU**.
- 3) Press **Direction KEY** [▼/▲] to select the Language [CHINESE, ENGLISH, JAPANESE, FRENCH, SPANISH...].
- 4) Press **ENTER** to confirm it.

*NOTE: AUDIO LANGUAGE, SUBTITLE LANGUAGE, and MENU LANGUAGE should be supported by a DISC function.

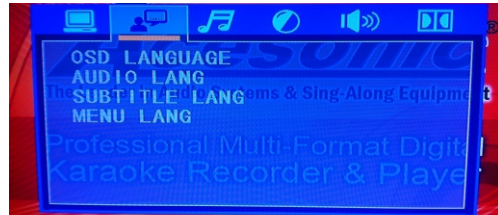

AUDIO SETUP

Unload the Disc then:

Press **SETUP KEY** to open the **Setup MENU**.

Press **Direction KEY** [◀/▶] to select “**AUDIO SETUP**”.

The **Sub-MENU** contains:

- AUDIO OUTPUT (SDIF-OFF/RAW/PCM)
- MIC SETTING
- KEY
- ECHO
- MIC VOL
- CUE
- SCORE

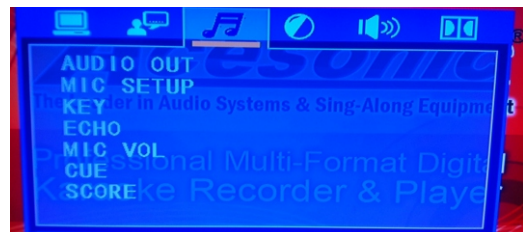

AUDIO OUT (DIGITAL) - SPDIF OFF / SPDIF RAW / SPDIF PGM

MIC SETTING - AUTO/OFF

KEY - Music tune settings

ECHO - Microphone echo level from 0~8

MIC VOL - Microphone volume setting from 0~8

CUE - Cue switching the mode between Karaoke and DVD. In Karaoke mode, the player will be paused after one track has finished playing. In DVD mode, all tracks will be played continually. * Karaoke mode= Cue on, DVD mode= Cue off.

SCORE - ON/OFF

1. Turn on the scoring function from the menu above
2. When you singing with scoring function on, you will see SCORE shows on the screen. At the end of the song, a score will be displayed base on performance.
3. This function only supports in CDG disc mode. any other file format like VCD, DVD, or MP3G etc wont works, even you turn on this function.

VIDEO SETUP

Unload the Disc then:

Press SETUP KEY to open the Setup MENU.

Press Direction KEY [◀/▶] to select the VIDEO SETUP.

The Sub-MENU:

BRIGHTNESS - Select from level 0 ~12

CONTRAST - Select from level 0~12

HUE - Select from level -6~+6

SATURATION - Select from level 0~12

SHARPNESS - Select from level 0~8

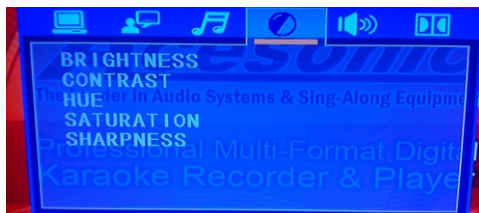

SPEAKER SETUP

Unload the Disc then:

Press SETUP KEY to open the Setup MENU.

Press Direction KEY [◀/▶] to select the SPEAKER SETUP.

The Sub-MENU:

DOWN MIX - Select from LT/RT,STERO,VSS & 5.1CH

SUBWOOFER - ON/OFF

CENTER DELAY - Select from 0,2 & 4ms

REAR DELAY - Select from ,6,12ms

FRONT - Select from LARGE and SMALL

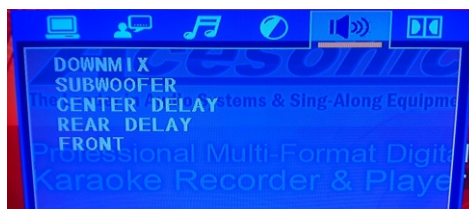

DIGITAL SETUP

Unload the Disc then:

Press SETUP KEY to open the Setup MENU.

Press Direction KEY [◀/▶] to select the SPEAKER SETUP.

The Sub-MENU:

OP MODE - Select from LINE OUT & RF REMO

DYNAMIC RANGE - Select from FULL,6/8,4/8,2/8 & OFF)

DUAL MONO - Select from STEREO, MONO L/R & MIX MONO



BASIC RECORDING OPERATION FOR MP3+G

WHAT IS MP3+G

An MP3+G file is a karaoke-based file format that consists of two parts, an audio file in MP3 format and a graphics file that displays on-screen lyrics. These two files combined are called an MP3+G file. An MP3+G file will occupy about the same disc space required for a standard CD+G track.

The recording function on this player offers two applications.

1. Record your vocal performance in MP3 (CD, VCD) or MP3+G(CDG,MP3G) format and share with your friends.
2. Transfer your existing CDG's to MP3+G format.

RECORDING A PERFORMANCE:

With a memory card already inserted, allow the this player to play a CDG in disc mode. You should hear audio and see graphics on your screen. (During this time, you will want to make any special changes that you want, (echo, key change, etc.....)

Next, simply press the "record" button on the player or the remote control. The player will re-start the song from the beginning with your users settings applied. There will be a record percentage symbol in the upper left corner of the screen letting you know the recording status. Now you can begin singing and the player will record your performance.

Now you have recorded a track and you want to hear it. With your memory card inserted, press the PLAYBACK button on the remote. A window will open displaying all files that are on the memory card and machine will automatically select the last file you just record for playback. The song should begin to play displaying the recorded graphic files on the screen too if you were using MP3+G or CDG format while recording. If you are using other format like Mp3, CD or VCD file to record your performance, only audio(music plus vocal) will be record, but no video will be recorded.

CDG DISC RIPPING TO MP3+G FILES:

This player can also be used to transfer CDG's to MP3+G recorded. Being that an MP3+G file only occupies about one eighth of the required space for a CDG, this is great way to back up your CDG's and protect your investment. Storing files as MP3+G gives you more options with your music. For karaoke jockeys and people that frequent karaoke venues, you can now leave your CDGs at home and only travel with your USB flash drive.

1. In disc mode, insert the CDG disc that you would like to rip. Make your sure your desired memory card or USB drive is also inserted.
2. Go ahead and allow the disc to play. Press DISC RIPPING button on the remote while the disc is playing.
3. In Options, select the ripping speed between 1x (real time) and 4x. You can also select the MP3 compression rate (bigger number, better sound quality, but also bigger file size, page 10).



BASIC RECORDING OPERATION FOR MP3+G

4. Next, go to TRACKS, to select one or few or all tracks which you desire to transfer to MP3+G format.

Click here if you want to check/uncheck all tracks



5. Go to START, you will see the ripping information. To start the ripping process, press ENTER.



There are two status bars showing the progress while ripping.

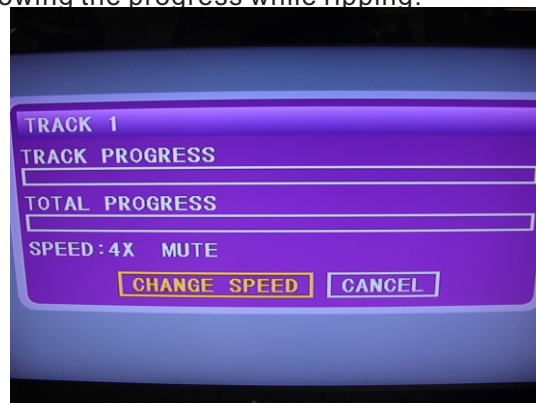

6. After ripping has finished, select QUIT to leave the window and go back to machine playback mode.

7. Ripped files will be stored in a folder named "RIPPING_XX(XX= number)" in your SD card or USB storage device.

Advanced Operations

Playing From A Specific Position

Locating a desired scene from the DVD menu

DVD discs generally have their own menus showing the contents of the disc. These menus contain various items such as the titles of movies, names of songs, or artist information, and display them on the TV screen. You can locate a desired scene using the DVD menu.

1. Insert a DVD disc into the tray.
2. Use the arrow keys to select a desired item and press **ENTER**

Locate A Desired Scene From The Video CD Menu With Playback Control

Some VCDs support the PBC function and have their own menus built in. You can locate a specific scene by using the PBC menu

1. Press **STOP** then press **PBC**. "PBC ON" should appear in the right corner of you screen.
2. Using the **NUMERIC KEYS 0-9**, enter the desired song number and press **ENTER** to begin playback.

To Locate A Desired Position In The Current Title Or Track Using Time Search

With Audio CDs, VCDs, and DVD Video Discs you can play the disc from a desired location by specifying the time during playback.

1. Press the **SEARCH** button (twice for DVDs).
2. Using the **NUMERIC KEYS 0-9**, enter the desired song number.

Example for DVD Video:

To play back from chapter 3 of a DVD
Press 3 then **ENTER**
TITLE 01/01 CHAPTER 003/11

To play back from 1 hour 21 minutes 00 seconds
Press **SEARCH** again then **121** or **12100** then
ENTER

TIME _ 1:21:00

Example for VCD or Audio CD:

To play back from 17 minutes 15 seconds
Press **1715** then **ENTER**

TIME 17:15

3. Press **ENTER** to begin playback. To dismiss the time search, press **SEARCH** again.

NOTE

*Some DVD Video discs do not contain time information and the time search function may not work.

*This function does not work when there are programmed tracks.

Zooming Into Pictures

During playback or paused playback, press **ZOOM**. Each time you press **ZOOM**, the magnification is changed 1.5, 2, and 3 times. You can use the arrow keys to move the zoomed position.

Repeating Playback

1. Press **REPEAT**. If you press **REPEAT** in stop mode, press **PLAY** to start playback. Each time you press **REPEAT**, the repeat mode cycles among REP-ALL, REP-ONE, and OFF. A window which indicates the current repeat mode will be displayed on the TV Screen.

To Stop Repeat Playback

Press **STOP**. The unit stops playback but does not quit repeat mode.

To Exit Repeat Playback

Press **REPEAT** until **REPEAT OFF** is displayed.

To Repeat A Desired Section (A-B Repeat)

By programming tracks, you can play up to 99 tracks in any order. You may also repeat the track by itself.

1. Press **A-B** once where you wish to begin repeating (Point A). **A-B SET A** appears on screen.
2. Press **A-B** again where you wish to end the repeat (Point B). **A-B SET B** appears on screen. The player will now begin to repeat playback between A and B.

To Exit A-B Repeat Playback

Press **A-B** a third time to turn off the A-B repeat mode.

NOTE

*The A-B points must be set within the same title/chapter/track.

*When you press **STOP** twice during DVD playback, **A-B** repeat is canceled.

NOTE

After 3 minutes of a static (still) picture displayed on the television screen (i.e. Karaoke DVD is paused half-way through playback or the menu), this unit will automatically activate the screen saver. This function is used to prevent any images from being "burned" on to the screen after a long period of time. To disable this function, go under **GENERAL SETUP> SCREEN SAVER** You have the option to enable or disable the screensaver.

Advanced Operations

Create Song List:

1. In the Disc/USB/SD Card mode, you can have a create your own song list from current MP3/MP3G songs in the disc/USB/SD Card. Press CREATE SONG LIST on the remote to start the process.

2. A song list will be created in a text file format and stored into either SD card or USB drive.

3. In the song list, the system will automatically assign a song number for each song. If the file has been deleted or added into the disc/USB/SD card, the previous song number might not work for all songs anymore. We strongly recommend recreating the SONG LIST again to update the song list.

4. With "sort song by song number" & "sort song by title" functions. This song list will be the database for song searching. Also, you can use this text file to print out your own song book from the PC.

Switch Between Two File Viewers (GUI SWITCH)

In the USB or SD card mode, there are two file viewers that you can choose. With the first one, you can see all the songs listed on the screen. With the second, you can see two windows on the screen – in the left window see all folders are listed, and in the right window all the songs in the selected folder are listed. You can only switch folders in Window 2 mode.



Window# 1

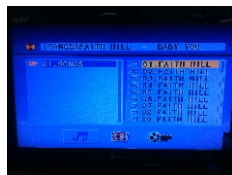

Window# 2

Song Searching:

Searching by numbers: You can search songs by inputting song number in USB/SD CARD mode after you create the song list file(see Page6, #43 for more detail)



Step by step:

1. Insert an SD card/USB drive into machine, and select the SD card/USB mode accordingly.
2. The machine will spend some time to load the content.
3. Once it has finished loading, press the CREATE SONG LIST button on the remote. Only need to do this step once when you put in a new SD card/USB drive or the content in the SD card/USB has been changed. As long as the song list file has been created and no content has been changed, you can skip this step.
4. Use NUMBER INDEX and NUMBER KEYS on the remote to search song by numbers
5. Press ENTER to start playing the desired song or press PROG to insert song into the waiting list(only works in Song listing mode, see below for more detail)

Searching by name:

You can search songs by inputting a song name in USB/SD CARD mode after you create the song list file (see Page6, #43 for more detail)

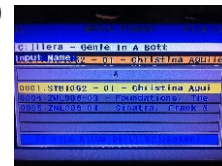

Step by step:

1. Insert an SD card/USB drive into machine, and select the SD card/ USB mode accordingly.
2. Stored machine will spend some time to load the content.
3. Once it has finished loading, press the CREATE SONG LIST button on the remote. Only need to do this step once when you put in a new SD card/USB drive or the content in the SD card/ USB has been changed. As long as the song list file has been created and no content has been changed, you can skip this step.
4. Use NAME INDEX and NUMBER KEYS on the remote to search song by name.
5. Press ENTER to start playing the desired song or press PROG to insert song in the waiting list (only work in Song listing mode, see below for more detail).

Programming the Playlist (only work in Window mode #1)

1. In USB/SD CARD mode, you can have a programmable song playlist. First, you need to press GUI SWITCH to switch window mode #1.



2. To add songs into the playlist, you can use either song searching by number or by title. After you find the song you want. Press PROG on the Remote to add the song into the PLAYLIST

3. Exit song searching window and back to window mode #1, then press PROG on the Remote to enter the Playlist window(see below)



4. Press PLAY on the Remote to start playing songs in the Playlist

5. To leave the PLAYLIST screen, press PROG button on the Remote while the PLAYLIST screen is open.

* The PLAYLIST will be erased after turning the player power off.

*Songs in the PLAYLIST won't disappear after the song plays.

Troubleshooting

Incorrect user operations are often mistaken for hardware/software problems and system malfunctions. If you suspect that something is wrong with the unit, check the comprehensive Troubleshooting Chart shown below, as sometimes the problems lie within other audio components and their individual settings.

Remember to troubleshoot your other connected components and any other electrical/electronic devices that you are using in concert with the DGX-212. If the trouble cannot be rectified even after exercising the steps listed in the Troubleshooting Charts (pages 18 and 19), call our Acesonic U.S.A. service center at (626) 820-0645 to inquire about technical support. We will make every effort to diagnose and repair your unit, restoring it to full operability. If a DGX-212 under warranty cannot be repaired, we will replace it per the warranty agreement.

	Symptom	Possible Causes
Reset to factory settings	Resetting the unit might solve more than 90% of all problems, try the steps below then reset the unit.	Press the SETUP button on the remote controller and then choose SYSTEM SETUP->DEFAULT->RESTORE then press ENTRY button. Your player is now set at it's original factory settings.
Operation	1. The disc automatically ejects back out even when the disc tray is closed.	* The disc is dirty or warped * The disc is not placed properly on the disc table * Region No. does not conform with the unit
	2. Cannot execute playback.	* Condensation has formed inside the player
	3. Picture disturbance during playback.	* This player is compatible with Macro-Vision System copy guard. Some discs include a copy prevention signal, and when this type of disc is played back, stripes etc., may appear on some sections of the picture depending on the TV. (This is not a malfunction.)
	4. When recorded on a VCR there is disturbance in the playback picture.	* This player is compatible with analog copy protect technology copy guard. Some discs include a copy prevention signal and the copy guard system will prevent proper playback.
	5. When STOP icon appears on screen.	* The selected function does not operate for that disc.
	6. Video playback stops and the operation button can not be used.	* First stop the disc, then start playback again.
Remote Control	7. Remote is not functioning.	* The remote control is too far from the player, or the angle with the remote sensor is too sharp. * The batteries are exhausted (dead). * The batteries are positioned incorrectly in the remote. * There is an object between the remote sensor or player.
	8. Improper operation of TV set, etc., occurs	* Some TVs that have wireless remote control functions may not operate properly with this remote control.
Audio	9. No audio or distorted sound.	* Digital signal is prohibited for some discs. * The connection plugs are not inserted all the way into the terminals or are not connected. * The connection plug or terminal is dirty. * Audio cable connection is incorrect. * Connection is made to the stereo amplifier's PHONO input terminal. * The pause mode is engaged. * Stereo amplifier operation is wrong. * Check input (CD, AUX etc.) selector.
	10. Noticeable difference in DVD and CD volume.	* Although you may notice a difference in volume between CDs and DVDs, this is the result of a difference in disc recording methods.

*Caution

Abnormal activity of the unit can be caused by static electricity, or other external interference. To restore normal operation, unplug the AC power cord and plug it in again.

Troubleshooting

	Symptom	Possible Causes
Karaoke Operations	11. There's no sound from the microphone	* Only HDMI & RCA mix output will support Karaoke Output. See page 6 * You need to adjust the volume of microphone.
	12. There's feedback and screeching	* The microphones are too close to the speakers.
Video	13. Screen is black & white, wavy, or contains static.	* Use the P/N button from remote to switch between NTSC and PAL. Press P/N then ENTER.
USB or SD card devices	14. The unit cannot read the devices.	* There are more than 2,000 files on the devices.
		* The device is not formatted to FAT32.
		* The device requires an external power source to power on
Recording performance	15. Function does not work	* Need to play the song first, then press the REC button on the remote or front panel.
	16. No voice after playback	* Didn't turn on the volume of microphone while recording
Convert CDG discs to MP3 files to USB/SD card	17. No graphic	* Only support CDG format.
	18. Cannot record	* The unit only supports recording from CDG, MP3G discs and only records audio from VCD discs.
HD video output	19. Video display not normal.	*By law, VGA output mode can't support high definition video output. If you select VGA output and choose 720p or higher resolution, the Video signal will become blurred or mosaics from ALL output, including VGA, HDMI, RCA etc. So please DO NOT use VGA output mode if you desire high definition resolution output (720p & up).
	20. Saving high resolution setting.	*To prevent accidental changes to HD resolutions your TV does not support, you will be prompted if you would like to save the selected resolution and use it after the player has been reboot. The resolution will be reset to 480p standard video output if you opted not to save. Simply turn the player off and power back on and wait for 10~15 seconds if you accidentally changed your video resolution setting causing no video to appear on your TV. The resolution will be reset to 480p standard video output.

Safety Warnings & Precautions



The lightning flash with arrowhead symbol, within an equilateral triangle is intended to alert the user to the presence of uninsulated dangerous voltage within the product's enclosure that may be of sufficient magnitude to constitute a risk of electric shock to persons.



The exclamation point within an equilateral triangle is intended to alert the user to the presence of important operating and maintenance (servicing) instructions in the literature accompanying the appliance.

CAUTION

To reduce the risk of electrical shocks, fire, and possible injuries, you should not remove screws, buttons, antennae, jacks, or any part of the enclosure; or expose the product to rain or moisture.

FCC ADVISORY (U.S.A.)

1. This equipment has been tested and found to comply with the limits for a Class B digital device, pursuant to part 15 of the FCC Rules. These limits are designed to provide reasonable protection against harmful interference in a residential installation.

This equipment generates, uses, and can radiate radio frequency energy and, if not installed and used in accordance with the instructions, may cause harmful interference to radio communications. However, there is no guarantee that interference will not occur in a particular installation. If this equipment does cause harmful interference to radio or television reception, which can be determined by turning the equipment off and on, the user is encouraged to try correcting the problem by one or more of the following measures:

- A) Reorienting and/or relocating the receiving antennae.
- B) Increasing the distance between the radio/TV equipment and the DGX-212.
- C) Connecting the radio/TV equipment to an outlet on a different circuit than the one into which the receiver is plugged.
- D) If necessary, consulting the dealer or an experienced radio/TV technician for help.

2. **IMPORTANT:** When connecting the DGX-212 to audio equipment, use only high-quality, shielded cables such as what is supplied with this product. Follow all installation instructions. Do not modify the equipment in any way, as this could void your FCC authorization to use the device in the U.S.

FOR CANADA/POUR LE CANADA

Caution: To prevent electric shock, match the wide blade of the plug to the wide slot, and fully insert.
Attention: *Pour éviter les chocs électriques, introduire la lame la plus large de la fiche dans la borne correspondante de la prise et pousser jusqu'au fond.*
This product does not exceed the Class B limits for radio noise emissions from digital devices as set out in the Canadian standard for interference-causing equipment ("Digital Apparatus, ICES-003" from the Department of Communications).

Cet appareil numérique respecte les limites de bruits radio électriques applicables aux appareils numériques de Classe B prescrites dans la norme sur le matériel brouilleur ("Appareils Numériques, NMB-003" édictée par le Ministre des Communications).

Important Safety Procedures

1. Read and follow these instructions, keep them handy for reference, familiarize yourself with the product's operation, and heed all safety warnings.
2. Do not use this product near water, on wet surfaces, or in places where moisture may accumulate. Do not expose the device to dripping or splashing, and do not place items filled with liquids – such as vases, beverages, etc. – on top. Clean only with a dry cloth.
3. Do not block any ventilation openings or set device on carpets or rugs. Maintain sufficient room on all sides for airflow.
4. Do not position the device on or near radiators, stoves, or other electrical equipment (such as amplifiers) that produce heat.
5. Do not defeat the safety purpose of a polarized or grounding-type plug. A polarized plug has two blades with one wider than the other, while a grounding-type plug has two blades and one prong. The wide blade and the prong are safety features. If the provided plug does not fit into your outlet, consult an electrician for replacement of the obsolete outlet.
6. Protect the power cord from being walked on or pinched, particularly where it is plugged in to an electrical socket and the point where it exits from the rear of the device.
7. Only use the attachments and accessories specified by the manufacturer.
8. Use only with a cart, stand, tripod, bracket or table specified by the manufacturer or sold with the device. When using a cart, use caution when moving the cart.
9. Unplug the product during lightning storms or when it will not be used for long periods of time.

Safety Warnings and Precautions

10. Refer all servicing to qualified service personnel. Servicing is required when the unit has been damaged in any way, such as when the power-supply cord or plug is damaged, liquids have been spilled or objects introduced into the enclosure, the device has been exposed to rain or moisture, the product does not operate normally or it has been dropped.

11. Never push objects of any kind into this product, through jacks or other openings, as they may contact dangerous voltage points or short-circuit components, thus causing fire or electrical shock.

12. This product should be operated only from the type of power source indicated on the product label and in this User Manual. If you are not sure of the type of power supplied to your home, consult your product dealer or local utility.

13. An outside antenna system should not be located in close proximity to overhead power lines, or other electric light or power circuits, or where it can fall into such power lines or circuits. When installing an outside antenna system, be extremely careful not to touch such power lines or circuits, as contact with them could be fatal.

14. Do not overload wall outlets or extension cord as this can increase the risk of fire, power outages or electrical shock.

15. When replacement parts are required, be sure the service technician has used replacement parts specified by the manufacturer or with the same characteristics as the original part. Unauthorized substitutions may result in fire, electric shock or other hazards.

16. Following any servicing or repair of this product, ask the service technician to perform the appropriate safety checks to ensure the product is in proper operating condition.

17. The product should not be mounted to walls or ceilings except as recommended by manufacturer, with mounting hardware approved by manufacturer.

18. If your product is not operating correctly or exhibits a marked change in performance, and you are unable to restore normal operation by following procedures in this User Manual, do not attempt to service it yourself. Opening the enclosure may expose you to dangerous voltage or other hazards. Refer all servicing to qualified service personnel.

Note: With the proper care and maintenance, your DGX-212 will give you years of dependable, enjoyable use. Make sure you are using proper power sources and good cables at all times.

Note: Any alterations or user repairs performed on the device voids your warranty.

SPECIFICATIONS

Power Source	100V-240V~, 50/60Hz
Power Consumption	≤ 14W
Video	HDMI(720p/1080i/1080p), Component (Y, Cb, Cr), Composite Video, Choice of Screen Ratio (16:9/4:3), PAL/NTSC Disc Compatible, Progressive Scan (500-p)
Audio	Output level: 0Vrms~1.5Vrms DA Converter: 24 bit, Frequency Response: DVD (PCM 96Khz): 2~44Khz(+/- 0.5 dB) S/N ratio: 100 dB (DVD), above 98dB (CD), Total Harmonic Distortion: 0.003%
Operating Temp	+5~+38 deg., 10%~75% (humidity)
Multimedia Source	MP3+G, CD+G, AVI, CD, VCD, MPEG, JPG
Interface	USB 2.0 Port for MP3/JPEG/ AVI playbacks and JPEG viewing.
Weight	2.5 Kg
Dimensions	430(W) X 125(D) X 80(H)mm

DGX-212: HDMI Multi-Format Karaoke Player with Digital Recording

One (1) Year Manufacturer Warranty

Lifetime Technical Support

Designed in U.S.A.

Technical Support: (626) 820-0645

techsupport@acesonic.com

Web site: www.acesonic.com

Acesonic USA, Inc.

161 S. 8th Avenue

City of Industry

CA 91746-3208

U.S.A.

© 2012 Acesonic USA, Inc. All rights reserved

Free Manuals Download Website

<http://myh66.com>

<http://usermanuals.us>

<http://www.somanuals.com>

<http://www.4manuals.cc>

<http://www.manual-lib.com>

<http://www.404manual.com>

<http://www.luxmanual.com>

<http://aubethermostatmanual.com>

Golf course search by state

<http://golfingnear.com>

Email search by domain

<http://emailbydomain.com>

Auto manuals search

<http://auto.somanuals.com>

TV manuals search

<http://tv.somanuals.com>