

AKAI
professional

EWI 4000s
ELECTRIC WIND INSTRUMENT

► REFERENCE MANUAL

WWW.AKAIPRO.COM

IMPORTANT SAFETY INSTRUCTIONS

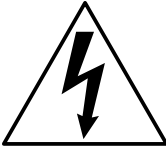

CAUTION
RISK OF ELECTRIC SHOCK
DO NOT OPEN



**CAUTION: TO REDUCE THE RISK OF ELECTRIC SHOCK
DO NOT REMOVE COVER (OR BACK).
NO USER-SERVICEABLE PARTS INSIDE.
REFER SERVICING TO QUALIFIED SERVICE PERSONNEL.**

THE SYMBOLS ARE RULED BY UL STANDARDS (U.S.A.)

1. Before you operate the EW14000s, read these instructions.
2. Keep these instructions.
3. Heed all warnings.
4. Follow all instructions.
5. Do not use this apparatus near water.
6. Clean only with a dry cloth.
7. Do not block any ventilation openings. Install in accordance with the manufacturer's instructions.
8. Do not install near any heat sources such as radiators, heat register, stoves, or other apparatus (including amplifiers) that produce heat.
9. Do not defeat the safety purpose of the polarized or grounding-type plug. A polarized plug has two blades with one wider than the other. A grounding type plug has two blades and a third grounding prong. The wide blade or the third prong is provided for your safety. If the provided plug does not fit into your outlet, consult an electrician for replacement of the obsolete outlet. Where the mains plug or an appliance coupler is used as the disconnect device, the disconnect device shall remain readily operable.
10. Protect the power cord from being walked on or pinched particularly at plugs, convenience receptacles, and the point where they exit from the apparatus.
11. Only use attachment/accessories specified by the manufacturer.
12. Use only the cart, stand, tripod, bracket or table specified by the manufacturer, or sold with the apparatus. When a cart is used, use caution when moving the cart/apparatus combination to avoid injury from tip-over.
13. Unplug this apparatus during lightning storms or when unused for long periods of time.
14. Refer all servicing to qualified service personnel. Servicing is required when the apparatus has been damaged in any way, such as power-supply cord or plug is damaged, liquid has been spilled or objects have fallen into the apparatus, the apparatus has been exposed to rain or moisture, does not operate normally, or has been dropped.
15. Do not expose this apparatus to dripping or splashing and ensure that no objects filled with liquids, such as vases, are placed on the apparatus.
16. Use only with the specified AC adapter.

PORTABLE CART WARNING



S3125A

WARNING:

The EWI4000s is designed to be used in a standard household environment. Power requirements for electrical equipment vary from area to area. Please ensure that your AC adapter supplied meets the power requirements in your area. If in doubt, consult a qualified electrician or AKAI Professional dealer.

FCC WARNING:

This equipment has been tested and found to comply with the limits for a Class B digital device pursuant to Part 15 of the FCC rules. These limits are designed which are designed to provide reasonable protection against such interference in a residential installation. There is no guarantee, however, that interference will not occur in a particular installation. If the unit does cause interference to any radio or television reception, try to reduce it by one or more of the following means:

- a) reposition the other unit and/or its antennae
- b) move this unit
- c) move this unit and the other unit(s) further apart
- d) plug this unit into a different AC outlet so that it is on a different circuit from the other equipment

CAUTION:

- To prevent electric shock, do not use this polarized AC power plug with an extension cord, receptacle, or other outlet unless the blades can be fully inserted to prevent blade exposure.
- Changes or modifications not expressly approved by the manufacturer for compliance could void the user's authority to operate the equipment.
- This appliance is not equipped with a main power switch. Even when the appliance is turned off, the power supply to the appliance is not completely turned off when the power cord is plugged in. Pull out the adapter when not using the appliance for long periods.
- This digital apparatus does not exceed the Class B limits for radio noise emissions from digital apparatus set out in the Radio Interference Regulations of the Canadian Department of Communications.

AVIS POUR LES ACHETEURS CANADIENS DU EWI4000s:

- Afin d'éviter tout risqué de décharge électrique, n'utilisez pas cette prise polarisée avec une rallonge, une prise de courant ou autre sortie à moins que les lames puissent être complètement insérées et qu'elles ne soient plus visibles.
- Le présent numérique n'émet pas de bruits radioélectriques dépassant les limites applicable aux appareils numériques de la Class B prescrites dans le Règlement sur le brouillage radioélectrique édicté par le ministère des Communications du Canada.

TABLE OF CONTENTS

CHAPTER 1: INTRODUCTION	4
FEATURES	4
PARTS & FUNCTIONS	5
POWER	9
CONNECTIONS	10
CHAPTER 2: BASIC OPERATION	11
ABOUT THE EWI4000s	11
BASIC OPERATION	11
HOW TO HOLD THE EWI4000s.....	11
OPERATING THE NOTE KEYS, OCTAVE SHIFT ROLLERS, & GROUNDING PLATES.....	11
USING THE MOUTHPIECE.....	12
USING THE PITCH BEND PLATES, GLIDE PLATES, & HOLD & OCTAVE BUTTONS.....	12
ADJUSTING THE SENSITIVITY OF THE SENSORS.....	13
FINGERING MODES.....	17
CHAPTER 3: INTERNAL SOUND	18
PROGRAM KEY FUNCTIONS	18
■ Selecting the Internal Sounds (Program Key).....	18
■ Assigning a Program Number to a Note Key.....	18
■ Setting Program Change Preferences.....	19
■ Recalling the Program Number Assigned to a Note Key.....	19
ALTERNATE WAY OF SELECTING THE PROGRAM NUMBER	20
■ Program Up with the Hold Button.....	20
■ Program Down with the Octave Button.....	20
ADJUSTING THE VOLUMES	21
■ Adjusting the Main Volume.....	21
■ Adjusting the Volume of Each Program.....	21
ADJUSTING THE EFFECTS VOLUMES	21
■ Adjusting the Reverb Volume.....	21
■ Adjusting the Reverb Effect Volume of Each Program.....	22
■ Adjusting the Delay Effect Volume of Each Program.....	22
■ Adjusting the Chorus Effect On/Off on Each Program.....	22
OCTAVE BUTTON FUNCTIONS	23
■ Assigning Functions to the Octave Button.....	23
■ Setting the Octave Button's Continuous Controller Preferences.....	24
HOLD BUTTON FUNCTIONS	24
■ Assigning Functions to the Hold Button.....	25
■ Setting the Hold Button's Continuous Controller Preferences.....	25
PITCH BEND PLATE FUNCTIONS	26
■ Assigning Functions to the Pitch Bend Plates.....	26
GLIDE PLATE FUNCTIONS	26
■ Assigning Functions to the Glide Plate.....	26
■ Setting the Glide Effect Time & Rate.....	27
ADJUSTING THE KEY DELAY	27
TRANSPOSE FUNCTION (TRANS BUTTON)	28
TUNING	28
EDITING THE INTERNAL SOUND WITH YOUR COMPUTER	28
CHAPTER 4: USING THE EWI4000s AS A MIDI CONTROLLER	29
ABOUT MIDI	29
USING THE EWI4000s AS A MIDI CONTROLLER (APPLICATION)	30
RESTORING THE FACTORY PRESETS	33
CHAPTER 5: MISCELLANEOUS NOTES	34
EVI FINGERINGS	34
SOFTWARE UPDATING	35
TROUBLESHOOTING	36
CHAPTER 6: FINGERING CHARTS	37
MIDI IMPLEMENTATION CHART	43
MENU STRUCTURE	44
SPECIFICATIONS	47

CHAPTER 1: INTRODUCTION

We greatly appreciate your purchase of the Akai Professional Electric Wind Instrument EWI4000s. The EWI4000s is an electric wind controller-equipped sound module. This manual includes detailed explanations of its functions, features, and operations and will show you how to use them to their fullest extent.

FEATURES

- Plays the same way as a woodwind instrument such as a saxophone
- Sensors detect breath intensity and mouthpiece pressure for responsive control of the pitch, tone, and volume
- Touch plates easily control Pitch Bend or Glide easily while Octave Shift rollers enable you to shift over an eight-octave range
- Analog-modeling synthesizer with 2 VCOs and 2 VCFs inside
- Equipped with an internal sound module and internal effects such as Reverb, Delay, and Chorus
- 1/4" line output or headphone jack, without need for an external sound/FX module
- Can be powered with 4 AA batteries
- User-changeable preset sound, output level, and effect level
- Can be used to trigger an external MIDI sound module via MIDI connections
- Free downloadable sound editing software from <http://www.akaipro.com>, allowing you to edit the internal preset sounds and effects parameters

PARTS & FUNCTIONS

TOP PANEL

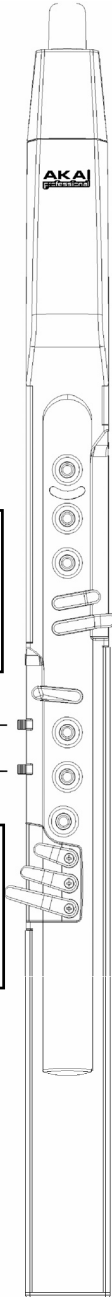

MOUTHPIECE – Hold the tip of the MOUTHPIECE and blow to play (like a traditional woodwind instrument). You can produce a vibrato effect by gently biting the MOUTHPIECE. *Do not bite too hard.*

HOLD BUTTON – Press this to enter Hold Mode. This button also functions as a Program Up button. In this case, pressing it turns the LED on and enables the specified function. It also works as “+” (Increase) button in Adjust Mode.

NOTE KEYS – Press these keys in different combinations while blowing into the MOUTHPIECE to change the note of the EW14000s. The position of the three low keys can be adjusted by loosening their screws.

OCTAVE BUTTON – Activates the Octave Mode. This button also functions as a Program Down button. In this case, pressing it turns the LED on and enables the specified function. It also works as “-” (Decrease) button in Adjust Mode.

SIDE / REAR PANEL

PROGRAM / DATA DISPLAY SECTION

SENSOR ADJUSTMENT KNOBS
PROGRAM / DATA DISPLAY
TRANS BUTTON
SETUP BUTTON

GLIDE PLATE SECTION

GLIDE PLATE
OCTAVE SHIFT ROLLERS
GROUNDING PLATE

BEND PLATE SECTION

NECK STRAP MOUNT
PROGRAM KEY
PITCH BEND UP PLATE
PITCH BEND DOWN PLATE
GROUNDING PLATE
FX BUTTON
LEVEL BUTTON
TOUCH SENSOR SENSITIVITY ADJUSTMENT KNOB

POWER / MIDI / AUDIO OUT SECTION

POWER SWITCH
DC IN
MIDI IN
MIDI OUT
PHONES
LINE OUT

CABLE CLUTCH SECTION

CABLE CLUTCH
BATTERY CASE COVER

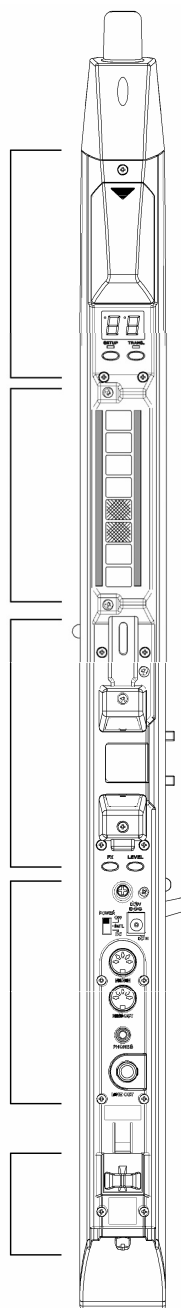

■ **Program / Data Display Section**

1. **SENSOR ADJUSTMENT KNOBS** – These seven knobs adjust the sensors for breath, glide, bend, and vibrato. (See the Sensor adjustment section for more information.)
2. **PROGRAM / DATA DISPLAY** – Shows the Program number or the setting value.
3. **TRANS (Transpose) BUTTON** – Turns the Transpose function on or off. The LED is lit if Transpose is on. You can set the transposition value by pressing the HOLD BUTTON or OCTAVE BUTTON while holding the TRANS BUTTON down.
4. **SETUP BUTTON** – Press this button to enter Adjust Mode. The LED will light up when you are in Adjust Mode.

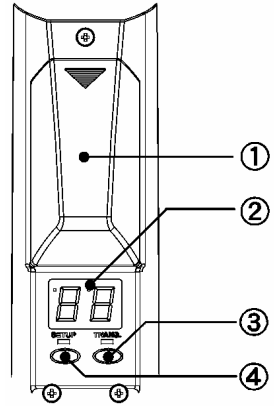

■ **Glide Plate Section**

1. **GLIDE PLATE** – Touching this plate when a note is being played produces a “glide” effect, smoothly and continuously sliding the pitch up or down (known as *portamento*).
2. **OCTAVE SHIFT ROLLERS** – Rolling your thumbs up or down over these rollers shifts the basic range played by the NOTE KEYS over eight octaves. Always touch these rollers while playing.
3. **GROUNDING PLATE** – Always keep a thumb on this plate while playing.

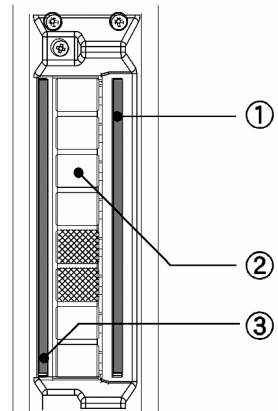

■ **Bend Plate Section**

1. **NECK STRAP MOUNT** – Connect a neck strap (included) to this mount and to the EW14000s.
2. **PROGRAM KEY** – Changes the Program (internal sound). If you touch this key without touching any NOTE KEYS, the selected Program number will be shown on the PROGRAM / DATA DISPLAY. You can then change the Program number by pressing the HOLD BUTTON or OCTAVE BUTTON.
3. **PITCH BEND UP PLATE** – Touching this key raises the pitch of the note being played. You can adjust the position of the plate by loosening its screw.
4. **PITCH BEND DOWN PLATE** – Touching this key lowers the pitch of the note being played. You can adjust the position of the plate by loosening its screw.
5. **GROUNDING PLATE** – Always keep a thumb on this plate while playing.
6. **FX (Effects) BUTTON** – Pressing this button shows the overall Reverb level on the PROGRAM / DATA DISPLAY. You can change the level by pressing the HOLD BUTTON or OCTAVE BUTTON.
7. **LEVEL BUTTON** – Pressing this button shows the Main Output level on the PROGRAM / DATA DISPLAY. You can change the level by pressing the HOLD BUTTON or OCTAVE BUTTON.
8. **TOUCH SENSOR SENSITIVITY ADJUSTMENT KNOB** – Adjustment knob for the touch sensor keys. (See the “Adjusting the Touch Sensor Sensitivity” section to set this up properly.)

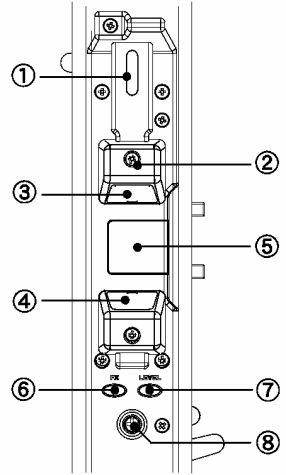

■ **Power / MIDI / Audio Out Section:**

1. **POWER SWITCH** – Selects the power source for the EW14000s. Select “BATT” when using the batteries, “DC” when using an AC adapter, or “OFF” when the EW14000s is not in use.
2. **DC IN** – Connect an AC adapter (MP-9, Optional) here.
3. **MIDI IN** – Plug a standard 5-pin MIDI cable from the MIDI OUT of your computer to this jack to edit the EW14000s’s internal sounds with the sound editor software.
4. **MIDI OUT** – Plug a standard 5-pin MIDI cable from the MIDI IN of the external sound module to this jack to use the EW14000s as a MIDI controller. You can also plug a MIDI cable from the MIDI IN of your computer to this jack to edit the EW14000s’s internal sounds with the sound editor software.
5. **PHONES** – Connect headphones here with a stereo 1/8” cable.
6. **LINE OUT** – Connect the EW14000s to the input of a mixer or amplifier here.

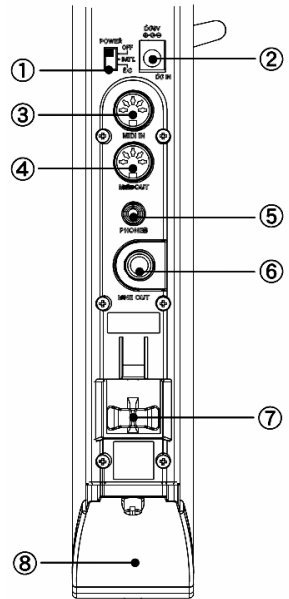

■ **Cable Clutch Section:**

7. **CABLE CLUTCH** – Clip a cable an audio or MIDI cable here.
8. **BATTERY CASE COVER** – Loosen the screw of this cover to install batteries in the EW14000s.

POWER

Before operating the EW14000s, please be careful of the following:

- Do not bite the MOUTHPIECE too hard as this may damage the vibrato sensor. Use the mouthpiece cover after using or while carrying the EW14000s.
- Always touch the GROUNDING PLATE and OCTAVE SHIFT ROLLERS when playing and editing sounds. Each of touch sensors uses the performer's body as the ground.
- Keep the MOUTHPIECE clean before, during, and after using the EW14000s. You can clean its outer surface with disinfectant alcohol.

■ Using Battery Power

- Please use four (4) AA batteries (alkaline or rechargeable) only. Be sure to install them with their poles (+/-) at the proper ends. Refer to the drawing for correct battery installation.
- Select "BATT" on the POWER SWITCH when using batteries. To prolong battery life, select the "OFF" position on the Power Switch when you're finished playing.
- When the battery power is low, an LED on the PROGRAM / DATA DISPLAY will start blinking at which point you should change the batteries.
- Remove the batteries when you are not going to be using your EW14000s for an extended period time. Don't use different types of batteries at the same time.

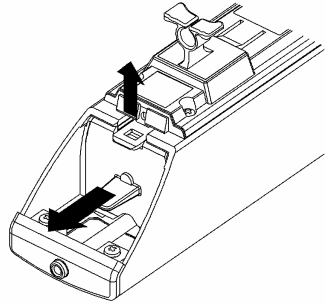

■ AC adapter

You can use an AC adapter (MP-9) instead of batteries. Connect adapter to the DC IN jack of the EW14000s and select DC on the Power Switch.

CONNECTIONS

■ Connection from Line Out of the EW14000s to a mixer or keyboard amplifier

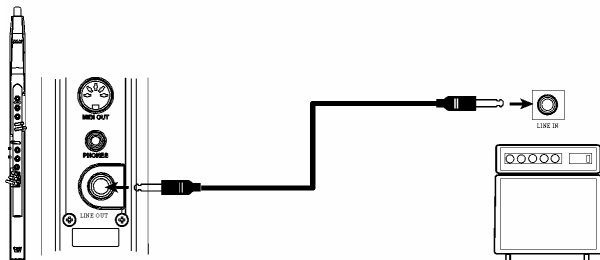

■ Connection from Headphone Out of the EW14000s to the Headphones

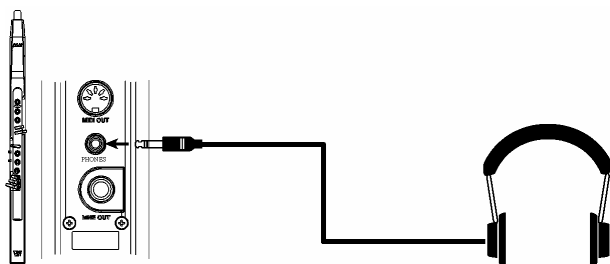

■ Removing the Cable Clutch

The CABLE CLUTCH can be removed (as shown here) if it interferes with using a wireless system.

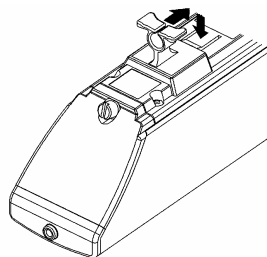

CHAPTER 2: BASIC OPERATION

ABOUT THE EWI4000s

The EWI4000s is a woodwind instrument-type MIDI controller with an internal sound module and built-in effects. It allows you to perform with the articulation of an acoustic instrument but also with the character of an electronic instrument with a wide variety of sounds and tonal colorings. The EWI4000s has an internal sound module and effects, so you can enjoy playing it simply by connecting the EWI4000s to an amplifier or headphones. To get the most out of your EWI4000s, study this manual to learn about its features and functions.

The EWI4000s has two modes: Play Mode and Adjust Mode. When you turn the EWI4000s on, it will be in Play Mode. If you wish to adjust the sensors' sensitivity or MIDI settings, you can change to the Adjust Mode by pressing the SETUP BUTTON.

Please take some time to read this Basic Operation section before playing the EWI4000s.

BASIC OPERATION

This section explains the basic operation of the EWI4000s and how to adjust its settings.

HOW TO HOLD THE EWI4000s

Hold the EWI4000s the same way as you would hold a saxophone or clarinet. The EWI4000s's NOTE KEYS are sensors that respond to your touch. They are useful for playing fast passages, but they are different from the key action of an ordinary wind instrument. Be sure to use a neck strap so you can move your fingers freely.



OPERATING THE NOTE KEYS, OCTAVE SHIFT ROLLERS, & GROUNDING PLATES

■ Note Keys

The NOTE KEYS allow you to produce sound with just a light touch. The EWI4000s has several different fingerings available, including saxophone, flute, and oboe. Please refer to the FINGERING CHARTS section for details. You can also change the EWI4000s's fingering configuration, designing your own unique fingerings that could not exist on an acoustic sound instrument.

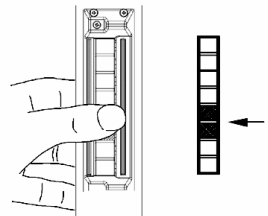

■ Octave Shift Rollers

Place your left thumb on the back side of the EWI4000s, between any two OCTAVE SHIFT ROLLERS. While playing, keep your left thumb touching the rollers. The position between the two knurled rollers will give you standard pitch.

■ Grounding Plates

There are two GROUNDING PLATES for your right and left hands. Always keep either of your thumbs on its GROUNDING PLATE while playing.

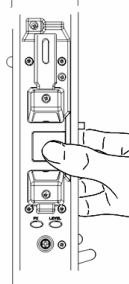

USING THE MOUTHPIECE

■ Mouthpiece

Hold the mouthpiece gently in your mouth with your teeth, and exhale so the breath is passed through both ends of your mouth. The EW14000s detects this wind pressure with the breath sensor and expresses the change in sound volume and character. The EW14000s unique breathing structure is designed so that very little breath is required to pass through the instrument. You can use various breathing techniques to sustain or shape notes for powerfully expressive performances.

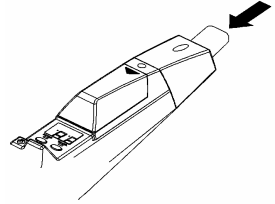

■ Vibrato

There is a vibrato sensor in the MOUTHPIECE. You can produce a vibrato effect by gently biting the MOUTHPIECE. Do not bite too hard as this may damage the vibrato sensor or the MOUTHPIECE itself.

■ Tonguing

You can create small bursts of air by tonguing the mouthpiece for even more expressive control.

Note: Adjust the S (Sense) SENSOR ADJUSTMENT KNOB to create different tonguing nuances.

USING THE PITCH BEND PLATES, GLIDE PLATES, & HOLD & OCTAVE BUTTONS

■ Pitch Bend Plates

By touching the PITCH BEND UP PLATE or PITCH BEND DOWN PLATE with your thumb (while also touching a GROUNDING PLATE), you can raise or lower the pitch of the note being played. Adjust the pitch bend range with the W (Width) SENSOR ADJUSTMENT KNOB.

Note: Before you get accustomed to using these plates, you may produce unexpected sounds by touching them accidentally. You can adjust the position of each plate by loosening its screw.

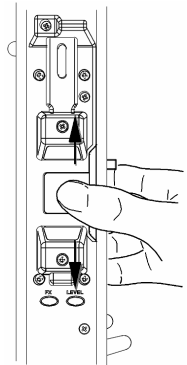

■ Glide Plate

By moving your thumb across the OCTAVE SHIFT ROLLERS while touching the GLIDE PLATE, you can achieve a “glide” effect, which will smoothly and continuously slide the pitch being played up or down. This is known as *portamento*. Adjust the glide time using the T (Time) knob on the GL (Glide) section of the EW14000s.

Note: Before you get used to controlling this plate, you may produce unexpected sounds by touching them accidentally.

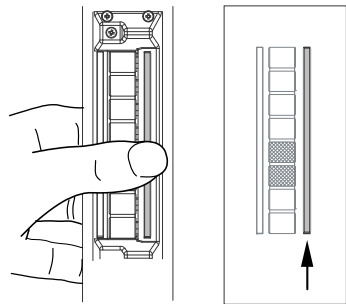

■ **Hold Button and Octave Button**

Pressing the HOLD BUTTON will engage or disengage the EWI4000s's Hold Mode (see the HOLD MODE section) or serve as a Program Up button while in Play Mode. While in Adjust Mode, the HOLD BUTTON serves as a "+" (Increase) button.

Pressing the OCTAVE BUTTON will let you engage or disengage the Octave function (see the OCTAVE FUNCTION section) or serve as a Program Down button while in Play Mode. While in Adjust Mode, the OCTAVE BUTTON serves as a "-" (Decrease) button.

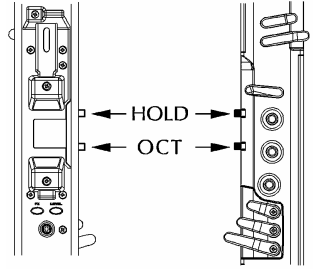

ADJUSTING THE SENSITIVITY OF THE SENSORS

To fully use the EWI4000s's various performance features, you should properly adjust the breath, glide, bend, and vibrato sensors to your own performing requirements. Each sensor has been set properly in the factory, but we recommend adjusting them on your own before playing the EWI4000s. The SENSOR ADJUSTMENT KNOBS are located under the cover above the PROGRAM / DATA DISPLAY. Remove the cover as shown in the drawing.

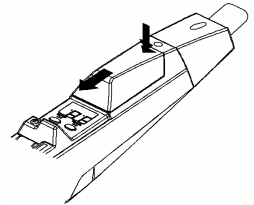

The function of each knob is shown below:

GL: Glide

- A: Glide Sensor Adjustment
- T: Glide Time Setting

PB: Pitch Bend

- A: Pitch Bend Sensor Adjustment
- W: Pitch Bend Width

VB: Vibrato

- A: Vibrato Depth Adjustment

BR: Breath

- A: Breath Sensor Adjustment
- S: Breath Sensitivity

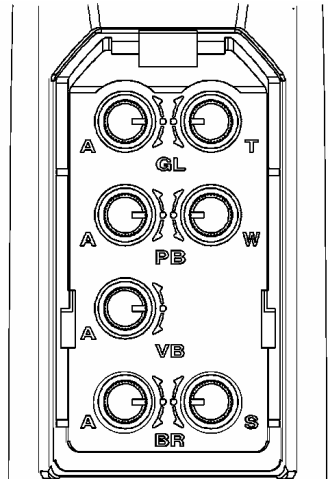

To adjust a sensor's sensitivity, press the SETUP BUTTON to enter Adjust Mode. The PROGRAM / DATA DISPLAY will indicate the sensor being adjusted.

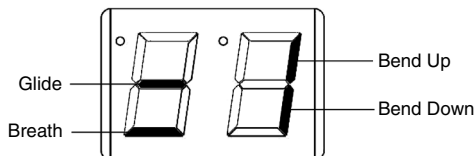

■ Adjusting the Breath Sensor

The breath sensor translates the strength of your breath into the volume and character of the note you're playing. It's important to set the sensor's sensitivity so it suits your style of playing.

1. Set the "S" (Sensitivity) knob in the "BR" (Breath) section to the center position, and then turn the "A" (Adjust) knob clockwise. The "Breath" indicator should light up on the PROGRAM / DATA DISPLAY. If you turn the "A" (Adjust) knob counterclockwise, it should go off.

Note: If the "Breath" indicator is lit, the EWI4000s will produce sound. Be careful of the volume settings on any connected equipment while adjusting the breath sensor.

2. Turn the "A" (Adjust) knob slowly counterclockwise from the position where the indicator is lighting up, and set it to the position where the indicator goes off.
3. Blow into the MOUTHPIECE. The breath sensor is properly adjusted if the sound starts when you blow (and stops when you stop blowing).
4. To adjust the "S" (Sense) knob for breath sensitivity, blow into the MOUTHPIECE with various breath strengths to confirm that the output sound volume changes depending on your breath strength. To change this setting, turn the "S" (Sense) knob. For greater sensitivity, turn the knob clockwise. For less, turn it counterclockwise. At a higher sensitivity, you may have less available articulation but not need to blow as hard. At a lower sensitivity, you will need to blow harder to produce a sound, but you can be more expressive with it.

Note: After adjusting the S (Sense) knob, you need to adjust the A (Adjust) knob again.

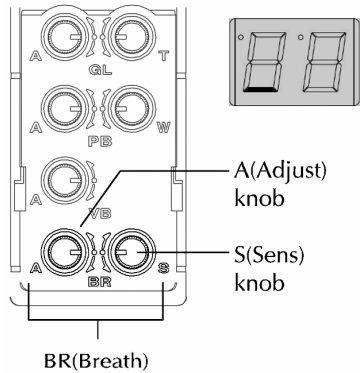

■ Adjusting the Pitch Bend Sensors

This section explains how to adjust the sensors for the Pitch Bend Up and Down functions and sets the width of these bends.

1. Set the "W" (Width) knob in the "PB" (Pitch Bend) section to the right-most (fully clockwise) position.
2. While touching your thumb only to the GROUNDING PLATE (without touching the PITCH BEND UP PLATE or PITCH BEND DOWN PLATE), adjust the "A" (Adjust) knob in the "PB" (Pitch Bend) section so that both the UP and DOWN indicators on the PROGRAM / DATA DISPLAY turn off.

3. Play the EWI4000s and use the PITCH BEND UP PLATE and PITCH BEND DOWN PLATE. The bend sensor is properly adjusted if a note's pitch raises or lowers (and the upper or lower indicator LED lights up) appropriately when you touch either of the bend plates. If you still want to adjust the settings, experiment more with the "W" (Width) knob. The range becomes narrower as you turn it counterclockwise (and wider as you turn it clockwise).

The overall change in pitch varies by how much of the plate your thumb is touching as well how it is touching the plate. You'll need to experiment with the bend plates and sensor adjustment for the best results.

Note: After adjusting the W (Width) knob, you will need to adjust the A (Adjust) knob again.

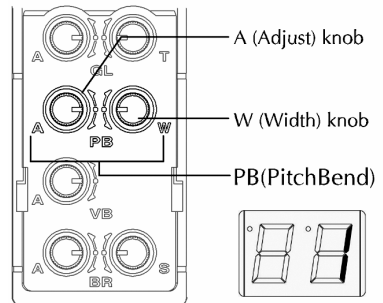

■ Adjusting the Vibrato Sensor

By gently biting on the MOUTHPIECE, you can produce a vibrato effect. This section explains how to adjust the vibrato sensor.

1. Set the "A" (Adjust) knob in the "VB" (Vibrato) section to the center position.
2. While playing a long tone on the EWI4000s, bite the MOUTHPIECE lightly. The sensor is properly adjusted if you get the vibrato effect while biting the MOUTHPIECE.
3. If you feel the vibrato is not set for your particular playing style, turn the "A" (Adjust) knob clockwise and try it again.

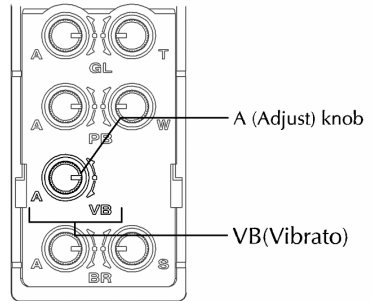

Note: The vibrato effect is obtained by biting the Mouthpiece many times rather than a single steady bite.

■ Adjusting the Glide Sensor

This section explains how to adjust the glide sensor.

1. Set the "T" (Time) knob in the "GL" (Glide) section to the center position. If you turn the "A" (Adjust) knob clockwise, the Glide indicator should light up. If you turn the "A" (Adjust) knob counterclockwise, the indicator should go off.
2. When the Glide indicator's LED is lit, turn the "A" (Adjust) knob slightly counterclockwise until the indicator LED goes off.
3. Play the EWI4000s and move your thumb across the Glide plate (while touching the OCTAVE SHIFT ROLLERS). You should hear the glide (or *portamento*) effect when you change from one note to another.
4. To confirm the proper glide sensor setting, change the octave with the OCTAVE SHIFT ROLLERS while playing. The pitch of the sound should slide slowly, not quickly. If you wish to make the slide time longer, turn the "T" (Time) knob clockwise. To shorten the slide time, turn it counterclockwise. You can set the "Time" or "Rate" of the glide's pitch shift. (See SETTING THE GLIDE EFFECT TIME & RATE for more information.)

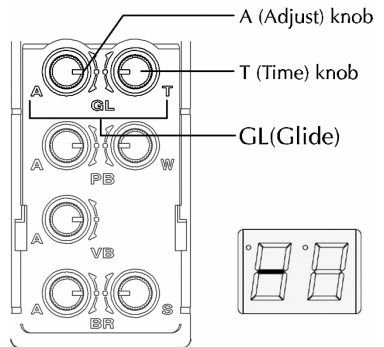

Note: After adjusting the "T" (Time) knob, you will need to adjust the "A" (Adjust) knob again.

■ Adjusting the Touch Sensors

The EWI4000s uses Touch Sensor keys, not mechanical switches. Typically, there is no need to adjust the Touch Sensor sensitivity because it is adjusted at the factory. If there are significant changes in temperature or humidity (or static electricity), though, the sensors may not respond correctly (e.g. the PROGRAM / DATA DISPLAY may show other numbers while in Play Mode instead of showing the correct Program number). In these cases, you may need to adjust the touch sensor sensitivity.

1. While in Play Mode, touch the NOTE KEYS K1, K2, and K3 (see the FINGERING CHART for details), the GROUNDING PLATE, and the OCTAVE SHIFT ROLLERS. *Do not touch the PROGRAM KEY.*
2. If there are numbers shown on the PROGRAM / DATA DISPLAY, turn the TOUCH SENSOR SENSITIVITY ADJUSTMENT KNOB clockwise until the numbers disappear. If there are no numbers on the PROGRAM / DATA DISPLAY, turn the knob counterclockwise until numbers are shown, then turn it clockwise until they disappear, and then turn it slightly clockwise again. Be sure that no number is shown on the PROGRAM / DATA DISPLAY if you touch several NOTE KEYS simultaneously.

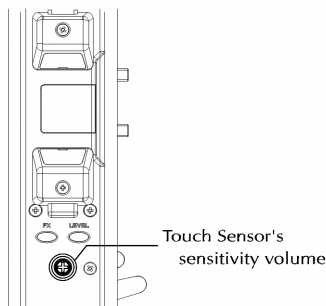
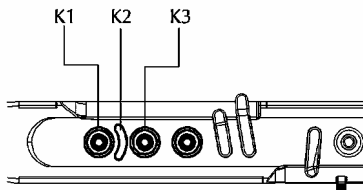

■ A Note About Adjusting Your Sensors

Though adjusting the sensors is seemingly complicated, proper key sensitivity is essential to the EWI4000s's functionality. Plus, you can play with much more expression and precision if you adjust the sensors to match your style. Once you adjust the sensors to your liking, you won't need to adjust them every time you play unless its sensitivity is changed by circumstances such as temperature. In this case, simply adjust the sensors again.

If you are just beginning with the EWI4000s, you may want to set the breath sensor lightly (by turning the "S" (Sense) knob in the clockwise direction) for easier blowing. With practice, you can set this control at a "heavier" setting for a more expressive performance. The EWI4000s is a musical instrument much like other acoustic instruments, so the more you practice, the better you will play. At first, you may find playing the EWI4000s challenging, but we believe you will find it to be a fantastic instrument with unlimited possibilities. There are no hard and fast rules for playing it, and we encourage you to find your own playing style.

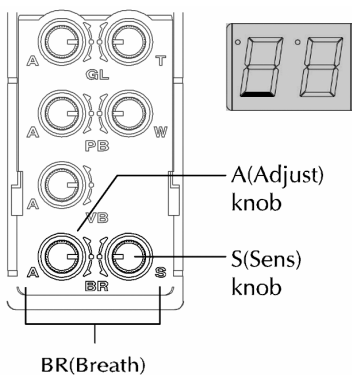

FINGERING MODES

The EWI4000s offers several different fingering modes to accommodate different styles of playing. The following steps explain how to set or change the fingering mode of the EWI4000s to suit your needs.

1. Press and hold the SETUP BUTTON.
2. Press the HOLD BUTTON or OCTAVE BUTTON to scroll through the options until "Fn" (Fingering) is shown in the PROGRAM DATA / DISPLAY. 
3. Release the SETUP BUTTON. The PROGRAM / DATA DISPLAY will display the current mode. Use the HOLD BUTTON or OCTAVE BUTTON to select any of the following options:

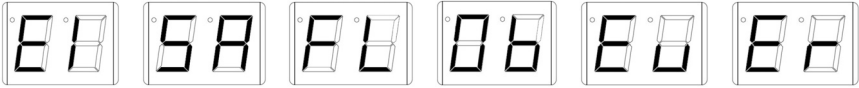

- a. **"EI"** (standard EWI fingering): This is the standard fingering system for the EWI4000s. This is based on the fingering of conventional woodwind instruments.
 - b. **"SA"** (Saxophone fingering): This fingering closely represents the fingerings of a standard saxophone. (In this mode, the EWI will ignore fingers that are two notes below the highest note.)
 - c. **"FL"** (Flute fingering): This fingering closely represents the fingerings of a standard C flute. There are, however, a couple new fingerings that flutists will have to familiarize themselves with to properly adapt their performance to the EWI4000s.
 - d. **"Ob"** (Oboe fingering): This fingering closely represents the fingerings of a standard oboe.
 - e. **"EV"** (EVI fingering): "EVI" stands for "electric valve instrument." This fingering may be useful to players who wish to use fingerings closer to those of a brass instrument.
 - f. **"ER"** (EVI fingering with reversed OCTAVE SHIFT ROLLERS): This fingering most closely duplicates the movement of the left wrist on an actual EVI. We recommend this mode for experienced EVI players.
4. Press the SETUP BUTTON. The EWI4000s will return to Play Mode.

Please refer to the FINGERING CHARTS section to see the differences between the various fingering modes.

CHAPTER 3: INTERNAL SOUND

PROGRAM KEY FUNCTIONS

■ Selecting the Internal Sounds (Program Key)

The EWI4000s has 100 internal preset sounds called Programs. You can switch between Programs by selecting Program numbers.

- Without touching any NOTE KEYS, press and hold the PROGRAM KEY. The current Program number is displayed on the PROGRAM / DATA DISPLAY as you are touching the PROGRAM KEY. (If you release the PROGRAM KEY, the PROGRAM / DATA DISPLAY will return to its previous state.)

Note: If you touch any NOTE KEYS, the PROGRAM / DATA DISPLAY will show the Program number assigned to that specific NOTE KEY, not the currently selected Program number.

- While holding in the PROGRAM KEY, you can select a new Program number by pressing the HOLD BUTTON, which works as “+” (increase) button, or the OCTAVE BUTTON, which works as “-” (decrease) button.
- The sound will change to match the currently displayed Program number after you release the PROGRAM KEY.

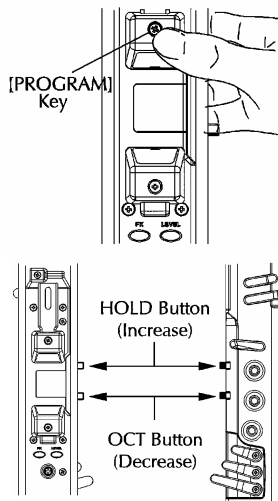

■ Assigning a Program Number to a Note Key

You can change the Program number directly by touching the NOTE KEYS after assigning a Program number to the NOTE KEYS. Instead of increasing/decreasing the Program numbers with the HOLD BUTTON or OCTAVE BUTTON, this feature allows you to access other Programs quickly during live performances.

- Select the Program number you wish to assign to the NOTE KEY as described in “Selecting the Internal Sounds (Program)” section above.
- While holding in the PROGRAM KEY, press the SETUP BUTTON. The selected Program number will blink on the PROGRAM / DATA DISPLAY.
- Touch the NOTE KEY you wish to assign to the selected program.
- Blow into the MOUTHPIECE. The selected Program will be assigned to the NOTE KEY you are touching.

This feature can be used a few different ways, which are explained in the SETTING PROGRAM CHANGE PREFERENCES section below.

■ Setting Program Change Preferences

This section explains how to set the EWI4000s to access your program changes in various ways.

1. Press and hold the SETUP BUTTON.
2. Press the HOLD BUTTON or OCTAVE BUTTON to scroll through the options until "PC" (Program Change) is shown in the PROGRAM DATA / DISPLAY.
3. Release the SETUP BUTTON. The PROGRAM / DATA DISPLAY will display the current mode. Use the HOLD BUTTON or OCTAVE BUTTON to select any of the following options:

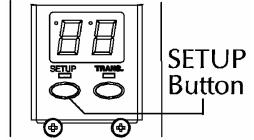

- a. "dP" (Direct Program Change): This setting will let you assign program changes to the notes of only one octave. That is, you can have a total of 12 program changes available to you on the 12 NOTE KEYS, regardless of the octave in which you are playing.
 - b. "AL" (All): This setting will let you assign program changes to every note playable. That is, you can have a total of 96 program changes available to you on the 12 NOTE KEYS, with each NOTE KEY having a different program change assignment in each octave (8 total octaves).
 - c. "Et" (MIDI Program Change): This setting will enable the sending of MIDI Program Change messages. (See "Program Change" under the ABOUT MIDI section in Chapter 4.)
4. Press the SETUP BUTTON. The EWI4000s will return to Play Mode.

■ Recalling the Program Number Assigned to a Note Key

This explains how to recall a Program number that is assigned to a NOTE KEY.

1. While touching the PROGRAM KEY, touch the NOTE KEY you wish to recall. The PROGRAM / DATA DISPLAY will show the Program number currently assigned to that NOTE KEY.
2. Blow into the MOUTHPIECE. The Program number will be changed.

Note: While touching the PROGRAM KEY, no sound will when blowing into the Mouthpiece.

ALTERNATE WAY OF SELECTING THE PROGRAM NUMBER

Selecting Programs is usually done by touching the PROGRAM KEY, but the EWI4000s also allows you to change Programs by pressing the HOLD BUTTON or OCTAVE BUTTON with the following settings. It may be convenient when you need to change the Program number while playing a song. While doing this, the HOLD BUTTON and OCTAVE BUTTON will increase or decrease the Program number, instead of the entering Hold Mode or Octave Mode.

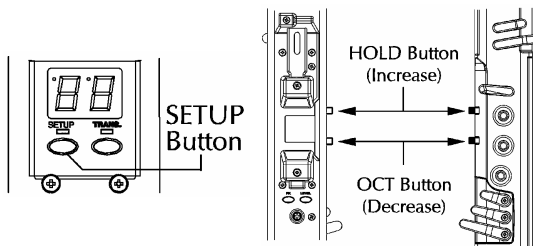

■ Program Up with the Hold Button

Note: While going through these steps, you cannot enter Hold Mode.

1. Press and hold the SETUP BUTTON.
2. Press the HOLD BUTTON or OCTAVE BUTTON until "Ho" (Hold) is shown on the PROGRAM / DATA DISPLAY.
3. Release the SETUP BUTTON.
4. Select "UP" by pressing the HOLD BUTTON or OCTAVE BUTTON. While "UP" is selected, pressing the HOLD BUTTON will increase the Program number.
5. Press the SETUP BUTTON. The EWI4000s will return to Play Mode.



■ Program Down with the Octave Button

Note: While going through these steps, you cannot enter Octave Mode.

1. Press and hold the SETUP BUTTON.
2. Press the HOLD BUTTON or OCTAVE BUTTON until "Oc" (Hold) is shown on the PROGRAM / DATA DISPLAY.
3. Release the SETUP BUTTON.
4. Select "dn" (down) by pressing the HOLD BUTTON or OCTAVE BUTTON. While "dn" is selected, pressing the OCTAVE BUTTON will decrease the Program number.
5. Press the SETUP BUTTON. The EWI4000s will return to Play Mode.



With the above settings, you can change the Program number only with the HOLD BUTTON or OCTAVE BUTTON without touching the PROGRAM KEY. When you press the HOLD BUTTON or OCTAVE BUTTON, the current Program number will be shown on the PROGRAM / DATA DISPLAY. Pressing the HOLD BUTTON will increase the Program number, and pressing the OCTAVE BUTTON will decrease the Program number.

If the HOLD BUTTON is functioning as a "Program Up" button and the OCTAVE BUTTON is serving its normal function, the OCTAVE BUTTON will decrease the Program number if you are holding down the HOLD BUTTON. Similarly, if the OCTAVE BUTTON is functioning as a "Program Down" button and the HOLD BUTTON is serving its normal function, the HOLD BUTTON will increase the Program number if you are holding down the OCTAVE BUTTON.

Example: When selecting the Program number "10", if you press the HOLD BUTTON, the Program will be changed to "11." If you then press the OCTAVE BUTTON while still pressing the HOLD BUTTON, the Program will be changed to "10," and pressing the OCTAVE BUTTON yet again will decrease the Program to "9."

ADJUSTING THE VOLUMES

■ Adjusting the Main Volume

This procedure adjusts the EW14000s's main output volume value (01-30).

1. Press and hold the LEVEL BUTTON. The current volume value will be shown on the PROGRAM / DATA DISPLAY.
2. While holding the LEVEL BUTTON, adjust the volume by pressing the HOLD BUTTON (which increases the volume value) or OCTAVE BUTTON (which decreases the volume value).

■ Adjusting the Volume of Each Program

This procedure adjusts the output volume of each Program individually, as opposed to the main output volume. The volume setting of each Program is stored in the EW14000s.

1. Select the Program whose volume you want to adjust.
2. While holding the LEVEL BUTTON, press the SETUP BUTTON. The current volume value will be shown on the PROGRAM / DATA DISPLAY.
3. Adjust the volume by pressing the HOLD BUTTON (which increases the volume value) or OCTAVE BUTTON (which decreases the volume value).
4. Press the SETUP BUTTON. The EW14000s will return to Play Mode, and your settings will be stored internally.

ADJUSTING THE EFFECTS VOLUMES

In addition to adjusting the normal volume of the EW14000s, you can also adjust the volume levels of its effects, including Reverb, Delay, and Chorus.

The controls involved in these procedures are shown here.

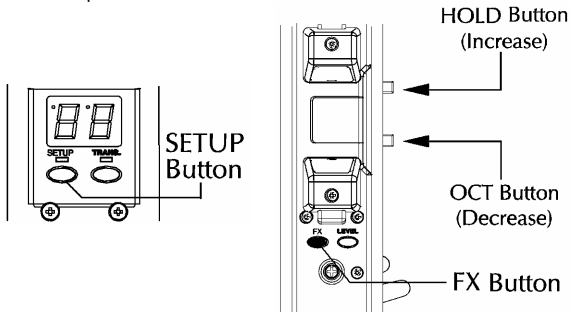

■ Adjusting the Reverb Volume

This procedure adjusts the overall volume of the EW14000s's Reverb effect.

1. Press and hold the FX BUTTON. The current Reverb effect volume will be shown on the PROGRAM / DATA DISPLAY.
2. While holding the FX BUTTON, adjust the volume by pressing the HOLD BUTTON (which increases the volume value) or OCTAVE BUTTON (which decreases the volume value).

■ Adjusting the Reverb Effect Volume of Each Program

This procedure adjusts the volume of the Reverb effect for each Program individually, as opposed to the overall Reverb effect volume. The Reverb effect volume of each program is stored in the EWI4000s.

1. Select the program whose Reverb effect volume you want to adjust.
2. While holding the FX BUTTON, press the SETUP BUTTON. While pressing both these buttons, "rb" will be shown in the PROGRAM / DATA DISPLAY.
3. Release both buttons. The current Reverb effect volume of the selected program will be displayed.
4. Adjust the Reverb effect volume by pressing the HOLD BUTTON (which increases the volume value) or OCTAVE BUTTON (which decreases the volume value).
5. Press the SETUP BUTTON. The EWI4000s will return to Play Mode.



■ Adjusting the Delay Effect Volume of Each Program

This procedure adjusts the Delay effect volume for each Program. The Delay effect volume setting of each program is stored in the EWI4000s.

1. Select the program you wish to adjust the Delay effect volume.
2. While holding the FX BUTTON, press the SETUP BUTTON. While pressing both these buttons, "rb" will be shown in the PROGRAM / DATA DISPLAY.
3. While pressing the SETUP BUTTON, release the FX BUTTON, then press the HOLD BUTTON so the PROGRAM / DATA DISPLAY now shows "dL."
4. Release the SETUP BUTTON and HOLD BUTTON. The current Delay volume of the selected Program will be displayed.
5. Adjust the Delay volume by pressing the HOLD BUTTON (which increases the volume value) or OCTAVE BUTTON (which decreases the volume value).
6. Press the SETUP BUTTON. The EWI4000s will return to Play Mode.



■ Adjusting the Chorus Effect On/Off on Each Program

This procedure selects whether the Chorus effect is set on or off for each Program. The Chorus effect setting of each Program is stored in the EWI4000s.

1. While holding the FX BUTTON, press the SETUP BUTTON. While pressing both these buttons, "rb" will be shown in the PROGRAM / DATA DISPLAY.
2. While pressing the SETUP BUTTON, release the FX BUTTON, then press the HOLD BUTTON so the PROGRAM / DATA DISPLAY now shows "CH."
3. Release the SETUP BUTTON and HOLD BUTTON. The current Chorus setting of the selected program will be displayed.
4. Set the Chorus to either "on" or "OF" by pressing the HOLD BUTTON or OCTAVE BUTTON.
5. Press the SETUP BUTTON. The EWI4000s will return to Play Mode.



OCTAVE BUTTON FUNCTIONS

By assigning the Octave function to the OCTAVE BUTTON and pressing it, you will add a note one octave lower the one you are currently playing.

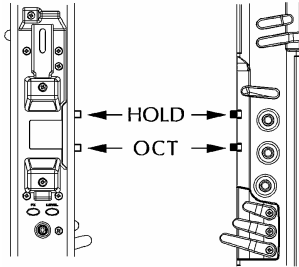

■ Assigning Functions to the Octave Button

1. Press and hold the SETUP BUTTON.
2. Press the HOLD BUTTON or OCTAVE BUTTON to scroll through the options until "Oc" is shown in the PROGRAM DATA / DISPLAY.
3. Release the SETUP BUTTON. The PROGRAM / DATA DISPLAY will display the current mode. Use the HOLD BUTTON or OCTAVE BUTTON to select any of the following options:



- a. **"Of"** (Off): The OCTAVE BUTTON will have no affect if you press it while you are playing.
 - b. **"oc"** (Octave): Pressing the OCTAVE BUTTON will play a second note an octave below the note you are playing.
 - c. **"In"** (Interval): Pressing the OCTAVE BUTTON will play a second note at the specified interval from the note you are currently playing. To assign this note (1) play a note and hold it, (2) press the OCTAVE BUTTON, and (3) play another note. The interval between the two notes will be the interval used for the second voice when you press the OCTAVE BUTTON.
 - d. **"dn"** (Down): The OCTAVE BUTTON will function as a "Preset Down" button.
 - e. **"CC"** (Continuous Controller): The OCTAVE BUTTON will transmit MIDI Continuous Controller (CC) data. You can set the CC number, the value it will transmit, and whether the OCTAVE BUTTON will function as a toggle or momentary button. (See the "Setting the OCTAVE BUTTON's Continuous Controller Preferences" section.)
4. Press the SETUP BUTTON. The EWI4000s will return to Play Mode.
 5. Press the OCTAVE BUTTON. The assigned function is on when the OCTAVE LED is lit. Press the OCTAVE BUTTON again. The assigned function is off when the OCTAVE LED is unlit.

■ Setting the Octave Button's Continuous Controller Preferences

When you choose to use the OCTAVE BUTTON to send Continuous Controller (CC) data, you will need to set your preferences to determine what data you send.

1. When you assign "CC" as the OCTAVE BUTTON's function, the LEDs under the SETUP BUTTON and TRANS BUTTON will flash. Press and hold the TRANS BUTTON.
2. While holding down the TRANS BUTTON, use the HOLD BUTTON and OCTAVE BUTTON to toggle between the following options:



- a. "Cn" (Controller Number): The number of the Controller that the OCTAVE BUTTON will use to send MIDI messages. This number should match the Controller number of the parameter you want to control.
 - b. "dA" (Data): The value that will be transmitted via the Controller number when the OCTAVE BUTTON is pressed while playing. The EWI4000s can transmit standard MIDI values 00-127. (Values over 99 will be shown as the last two digits with a dot between them on the PROGRAM / DATA DISPLAY.)
 - c. "LA" (Latching): If Latching is on, pressing the OCTAVE BUTTON while playing will act as a toggle button, continuously transmitting the Data value when it is pressed once and ceasing transmission when it is pressed a second time. If Latching is off, the Data value will be transmitted only when the OCTAVE BUTTON is held down while playing.
3. When you have selected the parameter you want to edit, release the TRANS BUTTON.
 4. You will see the value for that parameter in the PROGRAM / DATA DISPLAY. Press the HOLD BUTTON (which increases the value) or OCTAVE BUTTON (which decreases the value).
 5. Press and hold the TRANS BUTTON to return to the menu in Step #2. From here, you may repeat the process and edit other parameters.
 6. To exit this menu, press the SETUP BUTTON.

HOLD BUTTON FUNCTIONS

When you press the HOLD BUTTON, the EWI4000s will enter Hold Mode, which allows you to play and hold a note then play a line over that held note. The note will hold as long as you are playing a *legato* phrase. The EWI4000s will sustain the first note you play then allow you to play a melody over it. When you end the phrase or articulate a new phrase, the held note will end and the new note will become the held note.

Note: If the Hold function is assigned to the HOLD BUTTON, the overall output level will be decreased to eliminate distortion.

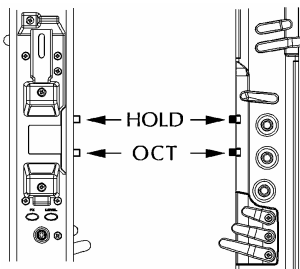

■ Assigning Functions to the Hold Button

1. Press and hold the SETUP BUTTON.
2. Press the HOLD BUTTON or OCTAVE BUTTON to scroll through the options until “Ho” is shown in the PROGRAM DATA / DISPLAY. 
3. Release the SETUP BUTTON. The PROGRAM / DATA DISPLAY will display the current mode. Use the HOLD BUTTON or OCTAVE BUTTON to select any of the following options:



- a. “OF” (Off): The HOLD BUTTON will have no affect if you press it while you are playing.
 - b. “LE” (Hold Mode, *Legato*): Pressing the HOLD BUTTON **before** playing a note will engage Hold Mode. The first note of a phrase you are playing (after pressing the HOLD BUTTON) will be held even as you play different notes after that. Starting a new phrase will result in a new held note. You can disengage Hold Mode by pressing the HOLD BUTTON again.
 - c. “nL” (Hold Mode, Non-*Legato*): Pressing the HOLD BUTTON **after** playing a note will engage Hold Mode. The first note of a phrase you are playing (after pressing the HOLD BUTTON) will be held even as you play different notes after that. Starting a new phrase will result in a new held note. You can disengage Hold Mode by pressing the HOLD BUTTON again.
 - d. “Su” (Hold Mode, Sustain): Pressing the HOLD BUTTON **before** playing a note will engage Hold Mode. The first note of a phrase you are playing (after pressing the HOLD BUTTON) will be held even as you play different notes after that. Starting a new phrase will result in a new held note. You can disengage Hold Mode by pressing the HOLD BUTTON again. (**Note:** This is different from *Legato Hold Mode* only in that it transmits MIDI Sustain pedal data – CC #64 – to your external sound module.)
 - e. “UP” (Up): The HOLD BUTTON will function as a “Preset Down” button.
 - f. “CC” (Continuous Controller): The HOLD BUTTON will transmit MIDI Continuous Controller (CC) data. You can set the CC number, the value it will transmit, and whether the HOLD BUTTON will function as a toggle or momentary button. (See the “Setting the HOLD BUTTON’s Continuous Controller Preferences” section.)
4. Press the SETUP BUTTON. The EW4000s will return to Play Mode.
 5. Press the HOLD BUTTON. The assigned function is on when the HOLD LED is lit. Press the HOLD BUTTON again. The assigned function is off when the HOLD LED is unlit.

■ Setting the Hold Button’s Continuous Controller Preferences

When you choose to use the HOLD BUTTON to send Continuous Controller (CC) data, you will need to set your preferences to determine what data you send.

1. When you assign “CC” as the OCTAVE BUTTON’s function, the LEDs under the SETUP BUTTON and TRANS BUTTON will flash. Press and hold the TRANS BUTTON.
2. While holding down the TRANS BUTTON, use the HOLD BUTTON and OCTAVE BUTTON to toggle between the following options:



- a. “Cn” (Controller Number): The number of the Controller that the OCTAVE BUTTON will use to send MIDI messages. This number should match the Controller number of the parameter you want to control.
- b. “dA” (Data): The value that will be transmitted via the Controller number when the OCTAVE BUTTON is pressed while playing. The EW4000s can transmit standard MIDI values 00-127. (Values over 99 will be shown as the last two digits with a dot between them on the PROGRAM / DATA DISPLAY.)
- c. “LA” (Latching): If Latching is on, pressing the OCTAVE BUTTON while playing will act as a toggle button, continuously transmitting the Data value when it is pressed once and ceasing transmission when it is pressed a second time. If Latching is off, the Data value will be transmitted only when the OCTAVE BUTTON is held down while playing.

3. When you have selected the parameter you want to edit, release the TRANS BUTTON.
4. You will see the value for that parameter in the PROGRAM / DATA DISPLAY. Press the HOLD BUTTON (which increases the value) or OCTAVE BUTTON (which decreases the value).
5. Press and hold the TRANS BUTTON to return to the menu in Step #2. From here, you may repeat the process and edit other parameters.
6. To exit this menu, press the SETUP BUTTON.

PITCH BEND PLATE FUNCTIONS

When you press either of the PITCH BEND PLATES, the EWI4000s will bend the pitch of the note you are playing, allowing you to be more expressive with your performance. Alternately, you can set the PITCH BEND PLATES to transmit data for individual MIDI Continuous Controllers.

■ Assigning Functions to the Pitch Bend Plates

1. Press and hold the SETUP BUTTON.
2. Press the HOLD BUTTON or OCTAVE BUTTON to scroll through the options until **"PU"** (Pitch Bend Up) or **"Pd"** (Pitch Bend Down) is shown in the PROGRAM DATA / DISPLAY. 
3. Release the SETUP BUTTON. The PROGRAM / DATA DISPLAY will display the current mode. Use the HOLD BUTTON or OCTAVE BUTTON to select any of the following options:



- a. **"Pb"** (Pitch Bend): Press the TRANS BUTTON to engage the Pitch Bend function, which will let you bend the pitch of the note you are playing while pressing the PITCH BEND PLATE. A dot LED will light up on the PROGRAM / DATADISPLAY to indicate Pitch Bend is enabled. Press the TRANS BUTTON again to disable it.
 - b. **"CC"** (Continuous Controller): Press the TRANS BUTTON to enable the transmission of MIDI CC data whenever you press the PITCH BEND PLATE. A dot LED will light up on the PROGRAM / DATA DISPLAY to indicate this function is enabled. Press the TRANS BUTTON again to disable it. You can adjust the CC number by holding down the TRANS BUTTON and pressing the HOLD BUTTON or OCTAVE BUTTON to decrease or increase the number, respectively.
4. Press the SETUP BUTTON. The EWI4000s will return to Play Mode.

See ADJUSTING THE PITCH BEND SENSORS for more information.

GLIDE PLATE FUNCTIONS

The EWI4000s's GLIDE PLATE lets you use portamento or a glide effect to move between notes for greater expressiveness in your performance. Alternately, you can set the GLIDE PLATE to transmit data for individual MIDI Continuous Controllers.

■ Assigning Functions to the Glide Plate

1. Press and hold the SETUP BUTTON.
2. Press the HOLD BUTTON or OCTAVE BUTTON to scroll through the options until **"Po"** (Portamento) is shown in the PROGRAM DATA / DISPLAY. 
3. Release the SETUP BUTTON. The PROGRAM / DATA DISPLAY will display the current mode. Use the HOLD BUTTON or OCTAVE BUTTON to select any of the following options:



- a. **"PS"** (Pedal Switch): Press the TRANS BUTTON to engage the Pedal Switch function, which enables the sending of MIDI CC #65 (Portamento On/Off). Some modules may need this message to enable or disable portamento, though the EWI4000s and most modules do not need this. A dot LED will light up on the PROGRAM / DATA DISPLAY to indicate Pedal Switch is enabled. Press the TRANS BUTTON again to disable it.

- b. **“CC”** (Continuous Controller): Press the TRANS BUTTON to enable the transmission of MIDI CC data whenever you touch the GLIDE PLATE. A dot LED will light up on the PROGRAM / DATA DISPLAY to indicate this function is enabled. Press the TRANS BUTTON again to disable it. You can adjust the CC number by holding down the TRANS BUTTON and pressing the HOLD BUTTON or OCTAVE BUTTON to decrease or increase the number, respectively. In order to use the GLIDE PLATE to create the glide effect, however, this must be set to CC #5.
4. Press the SETUP BUTTON. The EWI4000s will return to Play Mode.

■ Setting the Glide Effect Time & Rate

This section explains how to set either the Time or Rate as constant during pitch shifting with the GLIDE PLATE.

When Rate is selected, the speed of the pitch shift will remain constant, regardless of the range of the pitch shift. If the pitch shift range is narrow, it shifts the pitch for a short time. If the pitch shift range is wide, it shifts the pitch for a long time.

When Time is selected, the time of the pitch shift will remain constant, regardless of the range of the pitch shift. If the pitch shift range is narrow, it shifts the pitch slowly. If the pitch shift range is wide, it shifts the pitch quickly.

1. Press and hold the SETUP BUTTON.
2. Select **“GL”** (Glide) by pressing the HOLD BUTTON.
3. After selecting **“GL”**, release the SETUP BUTTON.
4. Select either **“r”** (Rate) or **“t”** (Time) by pressing the HOLD BUTTON or OCTAVE BUTTON.
5. Press the SETUP BUTTON. The EWI4000s will return to Play Mode.

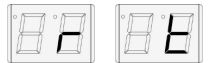

ADJUSTING THE KEY DELAY

The Key Delay function adjusts the response of the keys. The EWI4000s's key response is preset to accommodate rather quick fingering. As a result, you may occasionally produce unexpected sounds. In this case, you may find that you can play more smoothly by adjusting the Key Delay.

1. Press and hold the SETUP BUTTON.
 2. Select **“dL”** (Key Delay) by pressing the HOLD BUTTON.
 3. Release the SETUP BUTTON. The currently selected Key Delay value will be displayed on the PROGRAM / DATA DISPLAY.
 4. Set your desired value by pressing the HOLD BUTTON (which increases the value) or OCTAVE BUTTON (which decreases the value).
- Note:** You can play notes more smoothly with a larger Key Delay value, but it may prevent you from playing quickly. We recommend setting as small a value as possible.
5. Press the SETUP BUTTON. The EWI4000s will return to Play Mode.



Note: If you press a button other than the SETUP BUTTON, HOLD BUTTON, or OCTAVE BUTTON, your Key Delay value will be ignored and return to the original value.

TRANPOSE FUNCTION (TRANS BUTTON)

The Transpose function allows you to play the EWI4000s in a transposed key. If you use the Transpose function, the standard "C" position will be transposed to the note you have defined with this setting. (When the EWI4000s is set to the key of C, the PROGRAM / DATA DISPLAY will be blank, as shown below.)

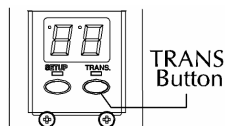

Pressing the TRANS BUTTON will turn the Transpose function on or off.

While holding the TRANS BUTTON, the current transposition will be shown on the PROGRAM / DATA DISPLAY. At this time, you can adjust the transposition by pressing the HOLD BUTTON (which raises the key) or OCTAVE BUTTON (which lowers the key).

The lowest possible transposition is E. The highest possible transposition is Eb.

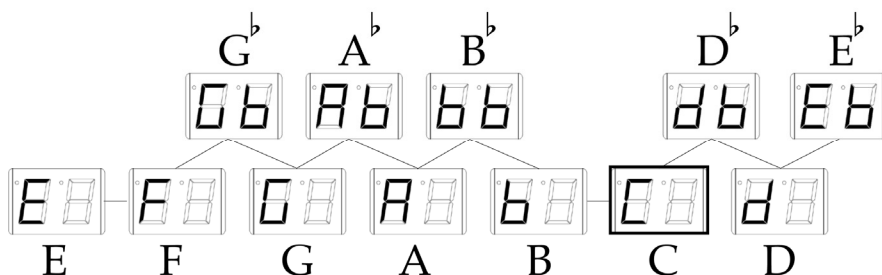

TUNING

This section explains how to adjust the tuning of the EWI4000s. This is useful if you ever need to tune to match the EWI4000s's pitch to other musicians' instruments.

1. Press and hold the SETUP BUTTON.
2. Select "tu" (Tuning) by pressing the HOLD BUTTON.
3. Release the SETUP BUTTON. The number "40" will be shown on the PROGRAM / DATA DISPLAY. This means the EWI4000s's tuning system is set to A440 (i.e., the note "A" is set to 440Hz).
4. Set your desired value by pressing the HOLD BUTTON (which increases the value) or OCTAVE BUTTON (which decreases the value). The EWI4000s's tuning range is 416Hz – 465Hz.
5. Press the SETUP BUTTON. The EWI4000s will return to Play Mode.

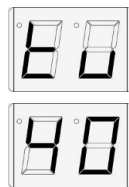

Note: If you press a button other than the SETUP BUTTON, HOLD BUTTON, or OCTAVE BUTTON, your Tuning setting will be ignored and return to the original setting.

EDITING THE INTERNAL SOUND WITH YOUR COMPUTER

Parameters of the EWI4000s's internal sounds and effects cannot be edited or adjusted by the EWI4000s itself, but you can do so by connecting to your computer and using the Sound Editor software for the EWI4000s. The edited sounds and effects will be stored in the EWI4000s.

To edit your internal sounds, connect the EWI4000s to your computer with MIDI cables and download the Sound Editor for the EWI4000s from our web site (<http://www.akaipro.com>). Refer to our website for more details about this program.

CHAPTER 4: USING THE EWI4000s AS A MIDI CONTROLLER

Because the EWI4000s has internal sounds and effects, you can play it on its own, but you can also use it as a MIDI controller for an external MIDI sound module/synth.

ABOUT MIDI

MIDI is a standard for transferring the performance data between electronic instruments regardless of the manufacturer. Devices are connected using a 5-pin MIDI cable. When you connect the EWI4000s' MIDI OUT to the MIDI IN of a MIDI sound module, the EWI4000s's performance data will be sent to the module, which plays the sound. MIDI data is not actual sound – just data which tells the module what sound to produce and how to manipulate it.

MIDI data can be sent over 16 MIDI channels in one MIDI cable. If you are using an external module, you must set the same MIDI channels for both the EWI4000s and the sound module (whether or not you are using the EWI4000s's sounds or effects). For example, if the EWI4000s's output channel is set to "1," the sound module's input channel should also be "1."

When sending MIDI data, the EWI4000s transmits the Note Number, Velocity, and some Controller Changes such as Breath Controller, Portamento, Sustain, etc.

1. Connect the MIDI OUT of the EWI4000s to the MIDI IN of your external MIDI sound module using a standard 5-pin MIDI cable.
2. Set the external sound model so that it responds to the incoming MIDI signal.
3. Set the received MIDI channel to "1." (The EWI4000s is set so that it transfers the MIDI signal with its initial setting.)
4. Select the sound library you wish to play.

Note: Refer to your external MIDI sound module's manual for more information.

Transmitted Information from the EWI4000s MIDI OUT:

- Breath strength is transmitted as MIDI Control Change (CC) #2 (Breath Controller). If the external sound module accepts this information, you can control the output volume of the sound module with your breath. Depending on the sound module, your breath strength can change not only the output volume but also the character of the sound. For example, if you set the cut-off frequency of the sound module with MIDI CC #2, your breath strength can change the sound character by changing the cut-off frequency of the sound. Refer to your sound module's manual for more information.
- BEND PLATE information is transmitted as MIDI Pitch Bend data. If the external sound module accepts this information (i.e., if Pitch Bend is a registered parameter), you can control the sound module's Pitch Bend with the BEND PLATE of the EWI4000s. (The vibrato information is also transmitted as MIDI Pitch Bend data.)
- GLIDE PLATE information is transmitted as MIDI Control Change #65 (Portamento) and #5 (Portamento Time). If the external sound module accepts them, you can control the sound module's Portamento with the GLIDE PLATE of the EWI4000s.

■ MIDI Program Change

You can change the sound program of an external sound module by sending MIDI Program Change information from the EWI4000s. The operation for a Program Change is the same as "Selecting the Internal Sounds (Program Key)." When the Program of the EWI4000s is changed, the MIDI Program Change of the same number is transmitted.

USING THE EWI4000s AS A MIDI CONTROLLER (APPLICATION)

■ Changing the MIDI Channel

This section explains how to set the MIDI OUT channel of the EWI4000s.

1. Press and hold the SETUP BUTTON.
2. Select "CH" (Channel) by pressing the HOLD BUTTON.
3. Release the SETUP BUTTON. The current MIDI channel number will be shown on the PROGRAM / DATA DISPLAY.
4. Select the MIDI channel number you want by pressing the HOLD BUTTON (which increases the value) or OCTAVE BUTTON (which decreases the value).
5. Press the SETUP BUTTON. The EWI4000s will return to the Play Mode.



Note: If you press a button other than the SETUP BUTTON, HOLD BUTTON, or OCTAVE BUTTON, your MIDI channel setting will be ignored and return to the original setting.

■ Changing the Breath Sensor Output

This section explains how to change the EWI4000s's Breath Sensor output to transmit MIDI Control Change data. You can select several MIDI Control Changes at the same time.

1. Press and hold the SETUP BUTTON.
2. Select "bS" (Breath Sensor) by pressing the HOLD BUTTON.
3. Release the SETUP BUTTON. The currently selected Breath Sensor setting will be shown on the PROGRAM / DATA DISPLAY. The selectable MIDI events are as follows:



- a. "vo" : Volume (07)
 - b. "EP" : Expression (11)
 - c. "AF" : Aftertouch
 - d. "br" : Breath control (02)
 - e. "vE" : Velocity data
4. Select the MIDI event you want by pressing the HOLD BUTTON or OCTAVE BUTTON.
 5. Press the TRANS BUTTON. This will select whether the MIDI event will be transmitted or not. If you choose to transmit it, an LED in the PROGRAM / DATA DISPLAY will light up. If the LED is not lit, the EWI4000s will not transmit the MIDI event. You can select several MIDI events to transmit simultaneously. If you select "vE," your breath strength will control the MIDI Velocity data.
 6. Press the SETUP BUTTON. The EWI4000s will return to the Play Mode.

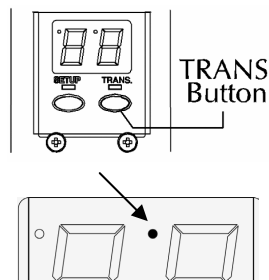

Note: If you press a button other than the SETUP BUTTON, TRANS BUTTON, HOLD BUTTON, or OCTAVE BUTTON, your MIDI event setting will be ignored and return to the original setting.

■ Setting the MIDI Velocity Value

If “vE” is selected as the Breath Sensor output, the EWI4000s will transmit the MIDI Velocity data, which is controlled by your breath strength. If “vE” is not selected, the EWI4000s will have a fixed MIDI Velocity value. You can set a fixed MIDI Velocity as follows:

1. Press and hold the SETUP BUTTON.
2. Select “vE” (Velocity) by pressing the HOLD BUTTON.
3. Release the SETUP BUTTON. The current MIDI Velocity value will be shown on the PROGRAM / DATA DISPLAY. You can select a MIDI velocity between 1 and 127. Only the lower two digits are displayed. A lit LED on the display means the value shown is over 100. **(Example: If the number “20” is shown and the LED on the display is lit, the MIDI Velocity value is “120.”)**
4. Adjust the fixed MIDI velocity you want by pressing the HOLD BUTTON (which increases the value) or OCTAVE BUTTON (which decreases the value).
5. Press the TRANS BUTTON.
6. Press the SETUP BUTTON. The EWI4000s will return to the Play Mode.

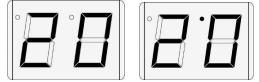

■ Changing the Vibrato Sensor Output to Another MIDI Event

Because the Vibrato Sensor information is mixed with the Pitch Bend information, you can create a pitch-bending Vibrato effect by biting the Vibrato Sensor in the MOUTHPIECE. Alternately, by mixing the Vibrato Sensor information with the Breath Sensor information, the Vibrato effect can be created by changing the sound's volume and/or character.

1. Press and hold the SETUP BUTTON.
2. Select “vS” (Vibrato Sensor) by pressing the HOLD BUTTON.
3. Release the SETUP BUTTON. “Pb” will be shown on the PROGRAM / DATA DISPLAY.
4. Select either “Pb” or “bo” by pressing the HOLD BUTTON or OCTAVE BUTTON. “Pb” indicates the Vibrato Sensor information will be mixed with the Pitch Bend information. “bo” indicates the Vibrato Sensor information will be mixed with the Breath Sensor information.
5. Press the TRANS BUTTON. This will select whether the MIDI event will be transmitted or not. If you choose to transmit it, an LED in the PROGRAM / DATA DISPLAY will light up.
6. Press the SETUP BUTTON. The EWI4000s will return to the Play Mode.

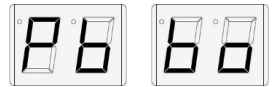

Note: If you press a button other than the SETUP BUTTON, TRANS BUTTON, HOLD BUTTON, or OCTAVE BUTTON, your MIDI event setting will be ignored and return to the original setting.

■ Setting the Octave Function (Octave Button) on MIDI Transmit

The Octave function is available while the EWI4000s is being used as MIDI controller. While the Octave function is on, the EWI4000s transmits a note one octave lower than the actual note being played (in addition to the actual note being played). To use the Octave function on MIDI Transmit, set the OCTAVE BUTTON to the Octave function. This is described in “Assigning the Octave Function to the Octave Button” in Chapter 3.

■ Setting the Hold Function (Hold Button) on MIDI Transmit

The Hold function is available while the EW4000s is being used as MIDI controller. The Hold function on MIDI Transmit is a little different than using the internal sound module. The Hold function is transmitted via MIDI in one of two ways, which you can select in the Adjust Mode:



1. Press and hold the SETUP BUTTON. "Ad" will be shown on the PROGRAM / DATA DISPLAY. 
2. Select "Ho" (Hold) by pressing the HOLD BUTTON.
3. Release the SETUP BUTTON. The PROGRAM / DATA DISPLAY will display the current mode. Use the HOLD BUTTON or OCTAVE BUTTON to select any of the following options:



- a. "So" (Sostenuto): Transmits a MIDI Control Change #66. (Sostenuto). When playing *legato* notes with the EW4000s, the MIDI Control Change #66 (Sostenuto) will be transmitted just after the first note. Only the first note will be held – later notes won't be held. When you stop blowing, the Sostenuto will cease.
 - b. "Su" (Sustain): Transmits a MIDI Control Change #64 (Sustain). When playing *legato* notes with the EW4000s, all notes will be held. When you stop blowing, the Sustain will cease.
 - c. "Of" (off): The Hold function is off.
4. Press the SETUP BUTTON. The EW4000s will return to the Play Mode.

■ Setting the Glide Plate Function on MIDI Transmit

The EW4000s converts the Portamento information to MIDI Control Change #65 (Portamento) and #5 (Portamento Time) when you touch the GLIDE PLATE. However, when some sound modules receive this information, they may change the sound undesirably. In this case, turn Portamento off, so you do not transmit Portamento information even when touching the GLIDE PLATE.

1. Press and hold the SETUP BUTTON. "Ad" will be shown on the PROGRAM / DATA DISPLAY. 
2. Select "Po" (Portamento) by pressing the HOLD BUTTON.
3. Release the SETUP BUTTON. "On" will be shown on the PROGRAM / DATA DISPLAY. 
4. Select "on" or "Of" by pressing the HOLD BUTTON or OCTAVE BUTTON. "on" will allow the EW4000s to transmit Portamento information. "Of" will not allow the EW4000s to transmit Portamento information, disabling the GLIDE PLATE. 
5. Press the SETUP BUTTON. The EW4000s will return to the Play Mode.

Note: If you press a button other than the SETUP BUTTON, HOLD BUTTON, or OCTAVE BUTTON, your MIDI event setting will be ignored and return to the original setting.

■ Sending an "All Notes Off" Message

Press the SETUP BUTTON at any time to transmit an "All Notes Off" message, which will stop all notes being played by the EW4000s. This is especially useful if you start encountering "stuck" notes.

■ Sending a MIDI Panic Message to Reset All Controllers

By pressing the FX BUTTON and LEVEL BUTTON simultaneously, you can send a MIDI Panic message, which will reset all controllers and send an "All Notes Off" message on the current MIDI channel.

RESTORING THE FACTORY PRESETS

By turning the EWI4000s on while holding the LEVEL, FX, SETUP, and TRANS BUTTONS, the EWI4000s, you can restore the EWI4000s's factory preset configuration.

The following global settings are stored in the EWI4000s:

- dL:** Key delay: 07
- CH:** Midi channel: 01
- tu:** Tune: 40
- bS:** Breath Sensor: Aftertouch, breath, and velocity enabled
- vS:** Vibrato Sensor: Pitch Bend enabled
- vE:** Velocity: 120
- Po:** Portamento: CC #5 (Pedal Switch off)
- Oc:** Octave key: oc
- Ho:** Hold key: OF
- GL:** Glide: r

Level master: 30

Level preset: 30

Reverb master: 21

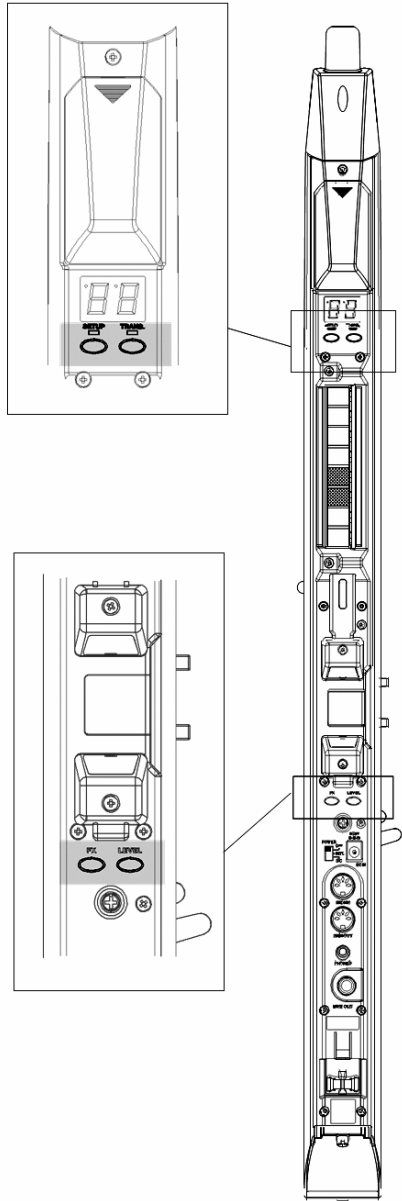

CHAPTER 5: MISCELLANEOUS NOTES

This section contains various notes on the EWI4000s features and functions that may be helpful as you familiarize yourself with this unique instrument.

EVI FINGERINGS

The EVI (electric valve instrument) fingerings may be well suited for brass players or reed players who wish to experiment more with “brass-like” fingerings. This section explains some important points about how these fingerings work.

■ The Right Hand

The right hand controls the three “valves” as well as the first Trill Key and third Trill Key (see THE TRILL KEYS section for more information). The right hand thumb also controls the PITCH BEND BUTTONS. Vibrato is created by gently biting the MOUTHPIECE with your teeth.

The right hand index, middle, and ring fingers activate the three “valve” keys (Keys 8, 9, and 10) as one would on a trumpet or similar valved brass instrument:

- Key 8 lowers the pitch two half steps (-2) when touched.
- Key 9 lowers the pitch a half step (-1) when touched.
- Key 10 lowers the pitch three half steps (-3) when touched.

The other right-hand keys function differently:

- Key 7 acts as the first Trill Key which raises the pitch two half steps (+2) when touched.
- Keys 11 and 12 are non-functioning and provide a place to rest the right hand pinky finger.
- Key 13 functions as the third Trill Key on the EVI. It raises the pitch +4 half steps when touched.

EVI players may be wondering where the second Trill Key is. The equivalent of the second Trill Key is activated by the left hand in several ways as explained below.

■ The Left Hand

The left hand controls the octave, half octave, and second Trill Key. The left hand thumb also controls the GLIDE PLATE. Grip the EWI4000s with the left hand and keep your fingers on Keys 3 and 4. This should provide a firm, comfortable grip.

The left-hand keys function in the following ways:

- Key 1 represents the canister index finger button on an actual EVI. Touching it lowers the pitch a fourth (-5 half steps). Think of this key as the 4th valve on some brass instruments or the left hand thumb attachment on a trombone.
- Keys 2 and 5 are non-functioning keys and acts as “barriers” to help prevent glitches.
- Key 6 acts as the second Trill Key, which raises the pitch a half step (+1/2) when touched. Lifting your fingers of Key 3 or 4 or touching Key 6 (or any combination of these three keys) raises the pitch a maximum of a half step (+1/2).

■ Trill Keys

With only seven right hand fingering combinations and 12 chromatic notes to cover, one must “crossover” to the next half-octave halfway through the current octave.

There are two crossover points where both the right and left hands change at the same time. One is in the middle of the octave between G and G#. The other is between C and C#, which is difficult as it requires five finger changes. Since multiple fingers on both hands are changing simultaneously, these crossover points can be tricky to play or trill between consistently without glitching. This is why the EVI fingering has the three Trill Keys.

The Trill Keys make several note transitions easier and smoother to play since they actually raise the pitch. So, instead of having to move five fingers at exactly the same time to trill from C to C#, you can simply finger a C and use the second Trill Key to play the C#. Trill Keys can also be used in combination with other Trill Keys or “valve” keys for alternate fingerings, making difficult musical passages easier to play.

■ Basic EVI Fingerings

Here are a few fingerings to get you started:

- Place your left thumb between two OCTAVE SHIFT ROLLERS. C is played by touching only Keys 3 and 4. (Note that Keys 3 and 4 are normally held down at all times so because there are no “valve” keys held down, this is considered the “open” fingering.)
- Now touch your left index finger to Key 1 and you have a G.
- Use the three right hand “valve” Keys 8, 9, and 10 to “finger downwards” from C or G.
- When fingering down from C, proceed until you get to Ab. To go from Ab to G, touch your left index finger to Key 1 and release your right hand fingers at the same time.
- Now proceed to finger down to C#. To go from C# down to C, release your left index finger and all your right hand fingers and roll your left thumb to the next OCTAVE SHIFT ROLLER all at the same time.

All fingerings are the same for every octave, though you will have to move along the OCTAVE SHIFT ROLLERS in different positions. Right hand fingerings are the same as a trumpet in the lower octave from middle C up to the C on the staff (e.g., C# is always played with Keys 8, 9, 10. D is always played with Keys 8, 10, etc.). You only need to learn this one octave and you will have mastered the entire range of the instrument!

*** Special thanks to Matt Traum of Patchman Music (www.patchmanmusic.com) for the development of EVI fingering.*

SOFTWARE UPDATING

The EW14000s's software is easy to upgrade. When a new version of software is available, follow these simple steps to load the new software to the EW14000s and take advantage of any new features and functions we've added.

You will need a computer with a MIDI interface and some type of MIDI player:

- **Windows:** You can use Windows Media Player 10.
- **Mac OS X:** We recommend downloading SysEx Librarian, a free program available at <http://www.snoize.com/SysExLibrarian/>.

1. Make sure you have your MIDI interface selected in your computer's controls.
2. Start by hooking the MIDI OUT from your computer (or MIDI interface connected to your computer) to the MIDI IN of the EW14000s using a standard 5-pin MIDI cable.
3. Press and hold the SETUP BUTTON, then press the HOLD BUTTON to scroll through the menu until the PROGRAM / DATA DISPLAY reads “UP.”
4. Release the SETUP BUTTON. The PROGRAM / DATA DISPLAY will show the current software version.
5. Open the EW14000s-vX.Y.mid” file in the MIDI player software on your computer. (“X.Y” simply denotes the software version you are uploading.)
6. When the file is finished transmitting, the EW1 will update its software. When it is finished, the number of the new software version (“XY”) will flash on the PROGRAM / DATA DISPLAY.
7. Turn the EW14000s off. When you turn it on again, you will be ready to play the EW14000s with the latest software!

If the PROGRAM / DATA DISPLAY flashes “Er” during the above update procedure, this means there was an error during the transmission of the file. In some cases – especially when using lower quality MIDI cables or MIDI interfaces – you may need to retry the procedure a few times before it completes.

If the problem is related to the MIDI player:

- Windows Media Player users should select the option to play the MIDI file slowly.

Sysex Librarian users should set the “Pause between played messages” (in the “Preferences” window) between 200ms and 300ms.

TROUBLESHOOTING

■ **EWI4000s produces no sound**

- Check that the amplifier, mixer, headphones, etc. are properly connected to the EWI4000s. Refer to the CONNECTIONS section of this manual for more information.
- Check that the EWI4000s is powered on, and that the instrument's batteries are correctly inserted, or that the AC adapter is properly connected to the wall outlet and the EWI4000s. Refer to the POWER section of this manual for more information.
- Check that the Main Volume level is not set to zero. Refer to the ADJUSTING THE VOLUMES section of this manual for more information.
- Check that the Breath Sensor is properly adjusted. Refer to the ADJUSTING THE BREATH SENSOR section of this manual for more information.

■ **Cannot change EWI4000s's pitch**

- Check that the Touch Sensor sensitivity is appropriately adjusted. Refer to the ADJUSTING THE TOUCH SENSOR SENSITIVITY section of this manual for more information.

■ **Encountering a "stuck" note**

- Press the SETUP BUTTON. This will send an "All Notes Off" message, which will stop any sound output from the EWI4000s.
- Check that the Breath Sensor is properly adjusted. Refer to the ADJUSTING THE BREATH SENSOR section of this manual for more information.

■ **EWI4000s is playing out of tune**

- Check that the EWI4000s's tuning is appropriately set. Refer to the TUNING section of this manual for more information.
- Check that the Bend Sensor is appropriately adjusted. Refer to the ADJUSTING THE PITCH BEND SENSORS section of this manual for more information.

■ **Cannot control the EWI4000s's volume**

- Check that the Breath Sensor is properly adjusted. Refer to the ADJUSTING THE BREATH SENSOR section of this manual for more information.

■ **Difficult to use EWI4000s's Portamento effect**

- Check that the Glide Sensor is appropriately adjusted. Refer to the ADJUSTING THE GLIDE EFFECT section of this manual for more information.

CHAPTER 6: FINGERING CHARTS

NOTE KEYS

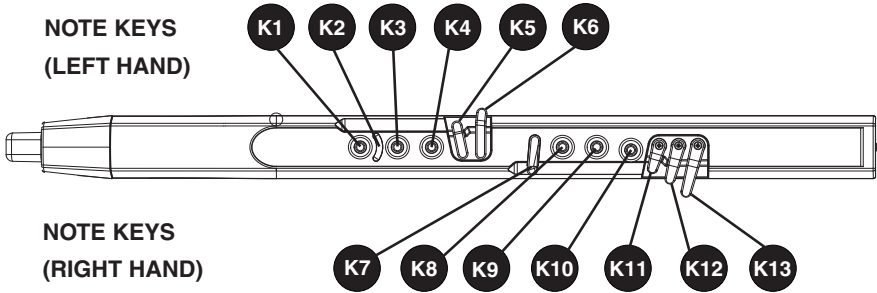

OCTAVE SHIFT ROLLERS



The "0" position produces the standard pitch. The EWI4000s transmits MIDI note number information from its MIDI OUT terminal within the following ranges (in the table) depending on the combination of pressed NOTE KEYS and the position of the OCTAVE SHIFT ROLLERS.

You can play other MIDI compatible instruments through the EWI4000s with the lowest note being A# (Note #22) and the highest being D# (Note #111).

Note: MIDI note number #60 is Middle "C."

















EWI FINGERINGS

NOTE	NOTE KEYS (LEFT)						NOTE KEYS (RIGHT)							OCTAVE SHIFT ROLLERS
	K1	K2	K3	K4	K5	K6	K7	K8	K9	K10	K11	K12	K13	
	●)	●	●	○	▬	○	●	●	●	○	▬	▬	
	●)	●	●	○	▬	○	●	●	●	○	○	▬	
	●)	●	●	○	○	○	●	●	●	○	○	▬	
	●)	●	●	▬	○	○	●	●	●	○	○	▬	
	●)	●	●	○	○	○	●	●	●	○	○	○	
	●)	●	●	○	○	○	●	●	●	▬	○	○	
	●)	●	●	○	○	○	●	●	○	○	○	○	
	●)	●	●	○	○	○	●	○	○	○	○	○	
	●)	●	●	○	○	○	○	●	○	○	○	○	
	●)	●	●	○	○	○	○	○	○	○	○	○	
	●)	●	●	○	○	○	○	○	○	○	○	○	
	●)	●	○	○	○	○	○	○	○	○	○	○	
	●)	●	○	○	▬	○	○	○	○	○	○	○	
	●)	○	○	○	○	○	○	○	○	○	○	○	
	●)	○	○	○	○	○	○	○	○	○	○	○	
	○)	●	○	○	○	○	○	○	○	○	○	○	
	○)	○	○	○	○	○	○	○	○	○	○	○	
	○)	○	○	▬	○	○	○	○	○	○	○	○	

SAXOPHONE FINGERINGS

NOTE	NOTE KEYS (LEFT)						NOTE KEYS (RIGHT)						OCTAVE SHIFT ROLLERS	
	K1	K2	K3	K4	K5	K6	K7	K8	K9	K10	K11	K12		K13
	●	☺	●	●	○	▬	○	●	●	●	○	▬	▬	
	●	☺	●	●	○	▬	○	●	●	●	○	○	▬	
	●	☺	●	●	○	○	○	●	●	●	○	▬	▬	
	●	☺	●	●	○	○	○	●	●	●	○	○	▬	
	●	☺	●	●	○	▬	○	●	●	●	○	▬	○	
	●	☺	●	●	▬	○	○	●	●	●	○	○	▬	
	●	☺	●	●	○	○	○	●	●	●	○	▬	○	
	●	☺	●	●	○	○	○	●	●	●	○	○	○	
	●	☺	●	●	○	○	○	●	●	●	▬	○	○	
	●	☺	●	●	○	○	○	●	●	○	○	○	○	
	●	☺	●	●	○	○	○	●	○	○	○	○	○	
	●	☺	●	●	○	○	○	○	●	○	○	○	○	
	●	☺	●	●	○	○	○	○	○	○	○	○	○	
	●	☺	●	●	▬	○	○	○	○	○	○	○	○	
	●	☺	●	○	○	○	○	○	○	○	○	○	○	
	●	☺	●	○	○	○	▬	○	○	○	○	○	○	
	●	☺	○	○	○	○	○	●	○	○	○	○	○	
	●	☺	○	○	○	○	○	○	○	○	○	○	○	
	●	☺	○	○	○	○	○	○	○	○	○	○	○	
	○	☺	●	○	○	○	○	○	○	○	○	○	○	
	○	☺	○	○	○	○	○	○	○	○	○	○	○	
	○	☺	○	○	○	▬	○	○	○	○	○	○	○	

FLUTE FINGERINGS

NOTE	NOTE KEYS (LEFT)						NOTE KEYS (RIGHT)							OCTAVE SHIFT ROLLERS
	K1	K2	K3	K4	K5	K6	K7	K8	K9	K10	K11	K12	K13	
 C	●	☺	●	●	○	○	○	●	●	●	○	○	▬	
 C [♯]	●	☺	●	●	○	○	○	●	●	●	○	▬	○	
 D	●	☺	●	●	○	○	○	●	●	●	○	○	○	
 D [♯]	●	☺	●	●	○	○	○	●	●	●	▬	○	○	
 E	●	☺	●	●	○	○	○	●	●	○	○	○	○	
 F	●	☺	●	●	○	○	○	●	○	○	○	○	○	
 F [♯]	●	☺	●	●	○	○	○	○	○	●	○	○	○	
 F [♯] alt.	●	☺	●	●	○	○	○	○	●	○	○	○	○	
 G	●	☺	●	●	○	○	○	○	○	○	○	○	○	
 G [♯]	●	☺	●	●	▬	○	○	○	○	○	○	○	○	
 A	●	☺	●	○	○	○	○	○	○	○	○	○	○	
 A alt.	●	☺	○	○	▬	○	○	●	○	○	○	○	○	
 B [♭]	●	☺	○	○	○	○	○	●	○	○	○	○	○	
 B [♭] alt.	●	☺	○	○	○	▬	○	○	○	○	○	○	○	
 B	●	☺	○	○	○	○	○	○	○	○	○	○	○	
 C	○	☺	●	○	○	○	○	○	○	○	○	○	○	
 C [♯]	○	☺	○	○	○	○	○	○	○	○	○	○	○	



UP 0 DOWN















If any 1 or more of the K7, K8, or K9 keys are pressed, the note should stay B[♭].

This is the only non-flute fingering that flute players will need to get used to.

OBOE FINGERINGS

NOTE	NOTE KEYS (LEFT)						NOTE KEYS (RIGHT)						OCTAVE SHIFT ROLLERS	
	K1	K2	K3	K4	K5	K6	K7	K8	K9	K10	K11	K12		K13
 B ^b	●	☺	●	●	○	▬	○	●	●	●	▬	○	○	 UP 0 DOWN
 B	●	☺	●	●	▬	○	○	●	●	●	▬	○	○	
 C	●	☺	●	○	○	○	●	●	●	▬	○	○		
 C [#]	●	☺	●	○	○	○	●	●	●	○	▬	○		
 D	●	☺	●	○	○	○	●	●	●	○	○	○		
 D ^b	●	☺	●	○	○	○	●	●	●	○	○	▬		
 D [#] alt.	●	☺	●	○	▬	○	●	●	●	○	○	○		
 E	●	☺	●	○	○	○	●	●	○	○	○	○		
 F	●	☺	●	○	○	▬	●	●	○	○	○	○		
 F alt.	●	☺	●	○	○	○	●	○	●	○	○	○		
 F alt.	●	☺	●	○	▬	○	●	●	○	○	○	○		
 F [#]	●	☺	●	○	○	○	●	○	○	○	○	○		
 G	●	☺	●	○	○	○	○	○	○	○	○	○		
 G [#]	●	☺	●	○	▬	○	○	○	○	○	○	○		
 G [#] alt.	●	☺	●	○	○	▬	○	○	○	○	○	○		
 A	●	☺	●	○	○	○	○	○	○	○	○	○		
 B ^b	●	☺	●	○	○	○	●	○	○	○	○	○		
 B	●	☺	○	○	○	○	○	○	○	○	○	○		
 C	●	☺	○	○	○	○	●	○	○	○	○	○		
 C [#]	●	☺	●	○	○	○	●	●	●	○	▬	○		
 C [#] alt.	●	☺	○	○	▬	○	○	○	○	○	○	○		
 D	●	☺	●	○	○	○	●	●	●	○	○	○		
 D ^b	●	☺	●	○	○	○	●	●	●	○	○	▬		
 D [#] alt.	●	☺	●	○	▬	○	●	●	●	○	○	○		

EVI FINGERINGS

NOTE	NOTE KEYS (LEFT)						NOTE KEYS (RIGHT)							OCTAVE SHIFT ROLLERS
	K1	K2	K3	K4	K5	K6	K7	K8	K9	K10	K11	K12	K13	
 C [♯]	●)	●	●	○	○	○	●	●	●	○	○	○	 UP 0 DOWN 
 D	●)	●	●	○	○	○	●	○	●	○	○	○	
 D [♯]	●)	●	●	○	○	○	○	●	●	○	○	○	
 E	●)	●	●	○	○	○	●	●	○	○	○	○	
 F	●)	●	●	○	○	○	●	○	○	○	○	○	
 F [♯]	●)	●	●	○	○	○	○	●	○	○	○	○	
 G	●)	●	●	○	○	○	○	○	○	○	○	○	
 G [♯]	○)	●	●	○	○	○	○	●	●	○	○	○	
 A	○)	●	●	○	○	○	●	●	○	○	○	○	
 A [♯]	○)	●	●	○	○	○	●	○	○	○	○	○	
 B	○)	●	●	○	○	○	○	●	○	○	○	○	
 C	○)	●	●	○	○	○	○	○	○	○	○	○	

MIDI IMPLEMENTATION CHART

Manufacturer: Akai Professional		Model: EWI4000s		Version: 2.0		Date: 11.03.2008	
		Transmit/Export	Recognize/Import	Remarks			
1. Basic Information							
MIDI channels		1-16	1-16				
Note numbers		14-113	0-127				
Program change		00-99	00-99				
Bank Select response? (Yes/No) If yes, list banks utilized in remarks column		NO	NO				
Modes supported: Mode 1: Omni-On, Poly (Yes/No) Mode 2: Omni-On, Mono (Yes/No) Mode 3: Omni-Off, Poly (Yes/No) Mode 4: Omni-Off, Mono (Yes/No) Multi Mode (Yes/No)							
Note-On Velocity (Yes/No)		YES	YES				
Note-Off Velocity (Yes/No)		NO	NO				
Channel Aftertouch (Yes/No)		YES	YES				
Poly (Key) Aftertouch (Yes/No)		NO	NO				
Pitch Bend (Yes/No)		YES	YES				
Active Sensing (Yes/No)		NO	NO				
System Reset (Yes/No)		NO	NO				
Tune Request (Yes/No)		NO	NO				
Universal System Exclusive: Sample Dump Standard (Yes/No) Device Inquiry (Yes/No) File Dump (Yes/No) MIDI Tuning (Yes/No) Master Volume (Yes/No) Master Balance (Yes/No) Notation Information (Yes/No) Turn GM1 System On (Yes/No) Turn GM2 System On (Yes/No) Turn GM System Off (Yes/No) DLS-1 (Yes/No) File Reference (Yes/No) Controller Destination (Yes/No) Key-based Instrument Ctrl (Yes/No) Master Fine/Coarse Tune (Yes/No) Other Universal System Exclusive		NO	NO				
Manufacturer or Non-Commercial System Exclusive		YES	YES				
NRPNs (Yes/No)		NO	NO				
RPN 00 (Pitch Bend Sensitivity) (Yes/No) RPN 01 (Channel Fine Tune) (Yes/No) RPN 02 (Channel Coarse Tune) (Yes/No) RPN 03 (Tuning Program Select) (Yes/No) RPN 04 (Tuning Bank Select) (Yes/No) RPN 05 (Modulation Depth Range) (Yes/No)		NO TO ALL	NO TO ALL				
2. MIDI Timing and Synchronization							
MIDI Clock (Yes/No)		NO	NO				
Song Position Pointer (Yes/No)		NO	NO				
Song Select (Yes/No)		NO	NO				
Start (Yes/No)		NO	NO				
Continue (Yes/No)		NO	NO				
Stop (Yes/No)		NO	NO				
MIDI Time Code (Yes/No)		NO	NO				
MIDI Machine Control (Yes/No)		NO	NO				
MIDI Show Control (Yes/No) If yes, MSC Level supported		NO	NO				
3. Extensions Compatibility							
General MIDI compatible? (Level(s)/No) Is GM default power-up mode? (Level/No)		NO	NO				
DLS compatible? (Levels(s)/No) (DLS File Type(s)/No)		NO	NO				
Standard MIDI Files (Type(s)/No)		NO	NO				
XMF Files (Type(s)/No)		NO	NO				
SP-MIDI compatible? (Yes/No)		NO	NO				

MENU STRUCTURE

Below is the structure of menus and submenus that can be accessed on the EWI4000s and viewed in the PROGRAM / DATA DISPLAY. This "map" of the menus may help you familiarize yourself with navigating the EWI4000s's various controls.

Menu items:

Submenu items:

Submenu options:

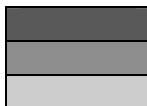

PARAMETER	RANGE	DEFAULT
AD ADJUST		
DL KEY DELAY	0-15	7
CH MIDI CHANNEL	1-16	1
EO TUNING	16-65	40
BS BREATH SEND		
VO VOLUME		
AF AFTERTOUCH		ENABLED
BR BREATH		ENABLED
EP EXPRESSION		
VE VELOCITY		ENABLED
BS BITE SENSOR		
BB BREATH		
PB PITCH BEND		ENABLED
VE VELOCITY - STATIC	1-127	120
PO PORTAMENTO		
PS PEDAL SWITCH	0-99	OFF, CONTROLLER #65
CC CONTINUOUS CONTROLLER	0-99	CONTROLLER #5
OC OCTAVE		
OF OFF		
OC OCTAVE		DEFAULT
IN INTERVAL		
DN PRESET DOWN/DECREMENT		
CC CONTINUOUS CONTROLLER		CC #69
EN CONTROLLER NUMBER	0-99	
DA MIDI VALUE	0-127	
LA LATCHING	ON/OFF	ON

PARAMETER	RANGE	DEFAULTS
H0 HOLD		
0F OFF		
LE LEGATO		DEFAULT
nL NON-LEGATO		
S0 SUSTAIN		
UP PRESET UP/INCREMENT		
CC CONTINUOUS CONTROLLER		CC #64
Cn CONTROLLER NUMBER	0-99	
DR MIDI VALUE	0-127	
LR LATCHING	ON/OFF	OFF
GL GLIDE		
RR RATE		DEFAULT
ET TIME		
PU PITCH BEND UP		
Pb PITCH BEND ENABLE	ON/OFF	ON
CC CONTINUOUS CONTROLLER	0-99	CC #48, DISABLED
Pd PITCH BEND DOWN		
Pb PITCH BEND ENABLE	ON/OFF	ON
CC CONTINUOUS CONTROLLER	0-99	CC #49, DISABLED
DP KEY PROGRAM		
0F OFF		
00 OCTAVE		DEFAULT
AL ALL		
Fn FINGERING		
EW EWING		DEFAULT
SA SAXOPHONE		
FL FLUTE		
06 OBOE		
EV EVI		
ER EVI REVERSED		

PARAMETER	RANGE	DEFAULTS
UP UPDATE		
CP CONTROL PROTOCOL *		
ON ON		DEFAULT
OFF OFF		

* **“CP”** (Control Protocol) is set by default to **“on,”** which adds an extra check to the SysEx data. If you experience problems with SysEx communications, press and hold the SETUP BUTTON, press the HOLD BUTTON or OCTAVE BUTTON until **“CP”** appears on the PROGRAM / DATA DISPLAY, then release the SETUP BUTTON. Press the HOLD BUTTON or OCTAVE BUTTON so the PROGRAM / DATA DISPLAY reads **“OF,”** then press the SETUP BUTTON again.

SPECIFICATIONS

EWI4000s

Type	Wind-instrument type controller with sound module
Fingerings	EWI, saxophone, flute, oboe, EVI, and EVI reversed
Sensors	Note Keys: touch sensors Mouthpiece: air pressure level sensor Lip: pressure level sensor Bend Up/Down Plates: touch sensors Glide Plate: touch sensor Octave Shift Rollers: touch sensors Program Key: touch sensor
Keys	LEVEL, FX, SETUP, TRANSPOSE, OCT, HOLD
Sensor Adjustment	Breath Sense, Breath Adjustment, Bend Width, Bend Adjustment, Glide Time, Glide Adjustment, Vibrato Adjustment
Terminals	1 line out (1/4") 1 headphone out (dual mono/stereo mini jack) (Recommended min. headphone impedance: 32Ω) 1 MIDI in (5-pin DIN) 1 MIDI out (5-pin DIN) 1 DC in (for optional AC adaptor MP-9II)
Other	Removal cable clutch
Power Requirement	4 AA batteries (alkaline or rechargeable) (Approx. 8 hrs. continuous use by batteries except with headphones) 9VDC/200mA AC-adaptor MP-9II (optional)
Dimensions	670.5mm (L) x 61mm (W) x 69mm (D)
Weight	874g (without batteries)
Accessories	Neck strap, 4 AA batteries, cleaning cloth, mouthpiece cover, Operator's Manual

SOUND MODULE

Sound type	Analog modeling synthesizer
Voices	2 (only with Octave & Hold function)
Control Range	8 octaves
Sound Source	2 Oscillators, 2 Filters Waveforms: Saw Tooth, Triangle, Pulse Noise Generator, Formant filter
Effect	Reverb, Delay, Chorus
Sound Capacity	100 (50 preset sounds x 2)
Display	2 7-segment LEDs
Function	Transpose, Tune, Note Hold, Octave, Program Change, Key Delay
Other	Sound Editor software for EWI4000s is available from our Web site (http://www.akaipro.com)

All specifications are subject to change without notice.

8-22-768X-D

AKAI
professional

WWW.AKAIPRO.COM

Free Manuals Download Website

<http://myh66.com>

<http://usermanuals.us>

<http://www.somanuals.com>

<http://www.4manuals.cc>

<http://www.manual-lib.com>

<http://www.404manual.com>

<http://www.luxmanual.com>

<http://aubethermostatmanual.com>

Golf course search by state

<http://golfingnear.com>

Email search by domain

<http://emailbydomain.com>

Auto manuals search

<http://auto.somanuals.com>

TV manuals search

<http://tv.somanuals.com>