

# INSTALLATION & OPERATION MANUAL



Digital Video Recorder  
DVR-3024M / DVR-3024MD

  
  
**APPRO**<sup>®</sup>

Before trying to connect or operate this product, please read this manual completely



# SAFETY PRECAUTIONS









All the following safety and operated instructions which will prevent harm or damage to the operator and other persons should be read before the unit is operated.

## INFORMATION



This equipment has been tested and found to comply with the limits for a Class A digital device, pursuant to Part 15 of the FCC Rules. These limits are designed to provide reasonable protection against harmful interference when the equipment is operated in a commercial environment. This equipment generates, uses, and can radiate radio frequency energy and, if not installed and used in accordance with the instruction manual, may cause harmful interference with radio communications.

Operation of this equipment in a residential area is likely to cause harmful interference in which case the user will be required to correct the interference at his own expense.

## WARNING

-  To reduce the risk of fire or electric shock, do not expose this appliance to rain or moisture.
-  Do not block ventilation openings.
-  Do not place anything on top of the unit that might spill or fall into it.
-  Do not attempt to service this unit yourself as opening or removing covers may expose you to dangerous voltage or other hazards. Please refer all servicing to qualified service personnel.
-  Do not use liquid cleaners or aerosols for cleaning.
-  This installation should be by a qualified service person and should conform to all local codes.
-  To prevent fire or electric shock, do not overload wall outlets or extension cords.
-  This unit must be grounded to reduce the risk of electric shock hazard.

## CAUTION

-  Danger of explosion if battery( RTC Battery ) is incorrectly replaced. Replace only with the same or equivalent type recommended by the manufacturer. Dispose of used batteries according to the manufacturer's instructions.
-  Risk of explosion if replaced by an incorrect type. Dispose of used batteries according to the instructions.

# CONTENTS

<b>1. INTRODUCTION .....</b>	<b>3</b>		
1.1 Product Introduction.....	3		
1.2 Product Features .....	3		
1.3. FRONT / REAR VIEW .....	4		
1.3.1 Front View.....	4		
1.3.2 Rear View.....	7		
1.4 ALARM In / Out.....	8		
<b>2. INSTALLATION .....</b>	<b>9</b>		
2.1 Basic Connection.....	9		
2.2 Hard-disk Drive Installation.....	10		
2.3 System Information and .....	12		
Channel Selection.....	12		
2.3.1 System information .....	12		
2.3.2 Channel Selection.....	12		
2.4 Updating System Software .....	13		
<b>3. OPERATIONS .....</b>	<b>14</b>		
3.1 Configuring Recording Settings .....	14		
3.2 Recording Operations.....	15		
3.2.1 Manual Recording .....	15		
3.2.2 Timer Recording.....	15		
3.2.3 Alarm / Motion Recording.....	16		
3.2.4 Externally Triggered Recording.....	17		
3.3 Playback Operations.....	18		
3.3.1 Normal Playback .....	18		
3.3.2 Fast Forward/Backward .....	18		
3.3.3 Slow Forward/Reverse.....	18		
3.3.4 Play back Picture-by-picture.....	19		
3.3.5 Playback Recorded Video from an HDD of the mobile rack (for removable HDD model only) .....	19		
3.3.6 Picture in Picture ( PinP ) Display Mode.....	19		
3.4 Search Operations.....	20		
3.4.1 FULL LIST Search.....	20		
3.4.2 ALARM LIST Search.....	20		
3.4.3 TIME Search .....	20		
3.4.4 THUMBNAIL Search.....	21		
3.4.5 SD CARD Search.....	22		
3.4.6 CD MENU .....	22		
3.5 Backup Operations .....	24		
3.5.1 CD Rewritable unit Backup Operations (FOR CD-ROM MODEL ONLY).....	24		
3.5.2 Mobile Rack HD Backup Operations.....	25		
3.5.3 SD Card Backup Operations .....	26		
3.6 Key Lock Operation .....	27		
<b>4. MENU SETUP .....</b>	<b>28</b>		
4.1 REC Setting .....	28		
4.2 ALARM / MOTION Setting .....	29		
4.3 TIMER / SEQ / TITLE Setting .....	30		
4.4 COMMUNICATION Setting.....	32		
4.5 DISK Setting .....	33		
4.6 SYSTEM Setting .....	34		
<b>5. NETWORK.....</b>	<b>37</b>		
5.1 Network Configuration .....	37		
5.1.1 Cable Connections.....	37		
5.1.2 Configure Your DVR Network Settings.....	38		
5.1.3 TCP/IP Communication Setup .....	40		
5.1.4 Connection Testing.....	42		
5.2 TRIPLEX 4 CH DVR VIEWER SOFTWARE: Introduction .....	43		
5.2.1 Software installation .....	43		
5.2.2 Short introduction .....	44		
5.2.3 Operation.....	45		
5.3 Microsoft Internet Explorer .....	50		
5.3.1 Connecting the DVR .....	50		
5.3.2 Change Record / Alarm Setting .....	51		
5.3.3 Change Timer Record Setting.....	52		
<b>6. MISCELLANEOUS .....</b>	<b>53</b>		
6.1 RS-232 & RS-485 Setup & Protocol .....	53		
6.1.1 RS232 & RS485 Setup .....	53		
6.1.2 Communication Protocol.....	53		
6.2 Hard Disk Installation .....	56		
6.2.1 Built-in hard disk.....	56		
6.2.2 Mobile Rack (FOR REMOVABLE HDD MODEL).....	57		
6.3 O.S.D Message.....	59		
6.4 Time Index Table .....	60		
6.5 Specifications .....	61		
6.6 ScanIP .....	62		
<b>APPENDIX 1. – Using CD Discs (FOR CD-RW MODEL ONLY) .....</b>	<b>64</b>		

# 1. INTRODUCTION

## 1. INTRODUCTION

### 1.1 Product Introduction

The four channel Digital Video Recorder (DVR) of MPEG4 format provides high quality storage of up to four video sources. The MPEG4 is a very small size file, so it can save more images over a longer time and can be sent extremely fast. Equipped with a range of comprehensive features, such as video motion detection, pre-alarm recording, thumbnail search, jog/shuttle function, hard drive expansion, and TCP/IP connectivity, this DVR will make your applications far more flexible and effective than ever before.

### 1.2 Product Features

- Non-PC base DSP hardware with proprietary system firmware.
- Full triplex operation allows live viewing/ video recording/ playback and network access simultaneously.
- Pre-alarm image recording.
- Compression: MPEG4.
- Recording Rate: NTSC: 120 IPS total (30 IPS per channel); PAL: 100 IPS total (25 IPS per channel)
- Quick search.
- Fast and slow playback of recorded video at various speeds.
- Single-picture playback.
- Motion detection.
- Remote control via the RS-232, RS-485 and Ethernet ports.
- Auto power recovery after any interruption.
- Remote viewing of live and recorded images through the TCP/IP network environment.
- Audio function included (16 bits, 11 / 22 kHz,  $\mu$ -law).
- Built-in SD memory card slot to save JPEG/AVI image(s) to an SD memory card.
- Daylight saving setting.
- Controls multiple brand Pan/Tilt/Zoom cameras through the network.
- Image Size: Best (5.0 Mbps) / High (4.0 Mbps) / Standard (3.0 Mbps) / Basic (2.0 Mbps)
- Playback Speeds: Frame stepping (forward only).  
slow: 1/16 X, 1/8 X, 1/4 X, 1/2 X (forward only); fast: 1X, 2X, 4X, 8X, 16X, 30X, 100X.

# INTRODUCTION ( continued )

## 1.3. FRONT / REAR VIEW

### 1.3.1 Front View

#### DVR-3024MD

(FOR CD-ROM MODEL)

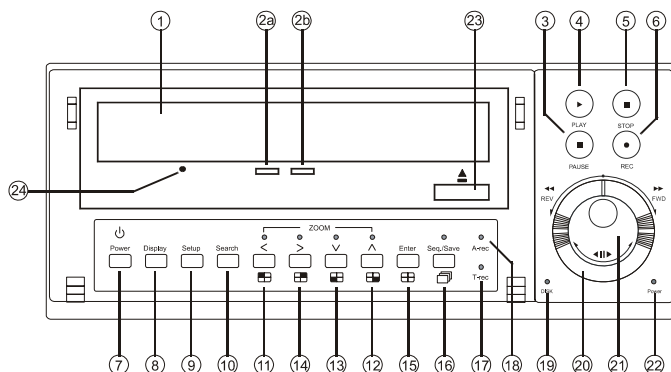

#### DVR-3024M

(FOR REMOVABLE HDD MODEL)

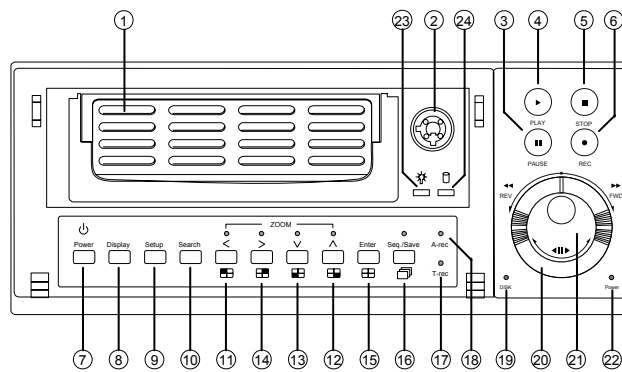

① **CD-RW device compartment:**

The compartment allows you to burn the data mostly for backup purposes. This tray is for loading the CD disc. It will accept 120 mm and 80 mm discs. Please place the discs in the exact center of the tray.

②a **Writing Display Light:**

When a disc is being burnt, the display light will be a red flash.

②b **Power Supply / Reading Light:**



When a disc has been ejected, the display light will be green. When a disc is unable to be read, or the device is being repaired, the display light will flash.

① **Hard-disk drive compartment:**

The compartment allows you to install a hard disk drive mostly for backup purposes. Make sure the drive is well secured with the mounting screws in the mobile rack before you put the rack into the compartment. And remember to turn on the power of the compartment by locking it.

② **Hard disk compartment lock:**

The key lock secures a hard disk in place. Unlock the compartment before you remove the hard disk from the slot without turning off the device.

- ③ **PAUSE** button:  
In a playback display, press this to freeze the display. During the freeze, press it to display one frame/field of a picture at a time in the forward direction. (Illuminate green in PAUSE mode.)
- ④ **PLAY** button:  
Press to play back a recorded video from the hard disk. (Illuminate green in PLAY mode.)
- ⑤ **STOP** button:  
Press to stop playing back a recorded video. (Illuminate green in STOP mode.)
- ⑥ **REC** button:  
Push to start recording video into a hard disk while in the live display mode. (Illuminate red in REC mode.)
- ⑦ **POWER** button:  
Press this button for at least 3 seconds to power off. Press again to activate the device.
- ⑧ **DISPLAY** button:  
Press to show the system operation status on the screen.
- ⑨ **Setup** button:  
Press this to enter the setup menu. Press again to exit the setup mode.
- ⑩ **Search** button:  
Press to enter the search mode to access the recorded video.
- ⑪⑭ **Left / Right (CH1 / CH2 )** buttons:  
Press the two buttons to highlight desired items in the menu setup mode. In live mode, use these buttons to select channel 1 or 2 for display.  
In play mode, use these buttons to select channel 1 or 2 as well as zoom in on the desired channel.
- ⑫⑬ **Up / Down ( CH4 / CH3 )** buttons:  
Press these two buttons to select the desired contents for programming in the setup menu mode.  
In live mode, use these buttons to select channel 4 or 3 for display.  
In play mode, use these buttons to select a channel 4 or 3 as well as zoom in on the desired channel.
- ⑮ **Enter /  (Quad)** button:  
Press to enter a selected item and save the setting in the menu setup mode.
- ⑯ **Seq./Save ** button:  
In live mode, press to enter the sequential jumping mode. The live picture will sequentially switch to different channels according to the sequencer setting in the setup menu. In the SD card backup mode, press to save the desired still image to an SD card.
- ⑰ **T-rec Indicator:**  
This indicator of the timer recording mode lights up to signal the scheduled record setting is on.
- ⑱ **A-rec Indicator:**  
This indicator of the alarm-recording mode lights up to indicate the alarm record setting is on.
- ⑲ **DISK Indicator:**  
The indicator shows the operation status of the unit's hard-disk drives. The green light indicates

the hard-disk drive is storing or retrieving data. The red light signals the hard-disk drive is filling up. The orange light indicates the hard-disk is retrieving at disk-full status.

⑳ **Shuttle Ring:**

The shuttle can be moved forward and backward for playback in either direction. Turn this left to play a recorded video in the reverse direction at faster or slower speeds than the recorded speed. Turn this right to play a recorded video in the forward direction at faster or slower speeds than the recorded speed.

㉑ **Jog Dial:**

The Jog Dial can be used to step frame by frame in the forward direction.

㉒ **POWER Indicator:**

Indicates the power status of the unit. The green light indicates the hard disk drive is activating. The orange light signals the hard disk drive's power is on stand by.

㉓ **Eject button:**

Pressing this controls the insertion and ejection of the tray.

㉔ **Emergency Eject Button:**

When the power supply has been interrupted, or it is impossible to eject a disc, please use a pin to press the emergency eject button so that the caddy will eject the disc.

㉓ **Mobile Rack Power LED:**

Indicates the power status of the Mobile Rack. The green light indicates the Mobile Rack is activating.

㉔ **Mobile Rack HDD LED:**

Indicates the HDD status of the Mobile Rack. The orange light indicates the HDD is storing or retrieving data.



### 1.3.2 Rear View

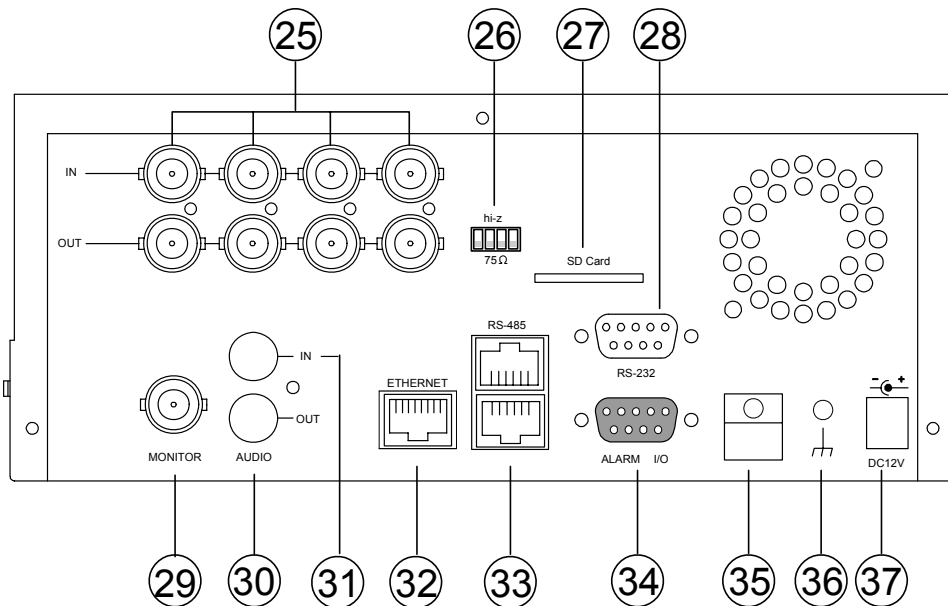

- ②5 **VIDEO IN** Connector: These 4 BNC connectors are used to connect the video output from a camera
- ②6 **Hi-Z/75 Ω Individual termination:** These 4 switches are used to set the impedance of each loop between **75Ω** and **Hi-Z**.
- ②7 **SD CARD** Slot: This is used for system software updating and archiving/accessing critical images.
- ②8 **RS-232** Port: The RS-232 communication port functions as a connector to an external control device.
- ②9 **MONITOR** Connector: The connector links the unit's composite video to a display device.
- ③0 **AUDIO OUT:** This connector is used to link the device's audio input.
- ③1 **AUDIO IN** Connector: This connector is used to connect the audio output from a camera or other devices to the DVR.
- ③2 **ETHERNET 10/100** Connector: This is one standard RJ-45 connector for 10/100 Mbps Ethernet networks.
- ③3 **RS-485** Port: The RS-485 communication ports function as connectors when two or more units are serially connected to an external control device.
- ③4 **ALARM I/O:** This is a 9-PIN D-SUB

connector including **SWITCH OUT, GROUND, ALARM OUT, DISK FULL, RECORD IN, ALARM RESET,** and **ALARM IN** for connecting with external devices. Please refer to the next section for details.

- ③5 **Wire Catch:** The wire catch secures the power cord and keeps it in place (so that it does not droop or hang loosely).
- ③6 **Ground Screw:** The ground screw is for the chassis terminal.
- ③7 **Plug Inlet:** The inlet connects to an external power supply. Connect 12 V DC UL Listed Class 2 Power Supply.

## 1.4 ALARM In / Out

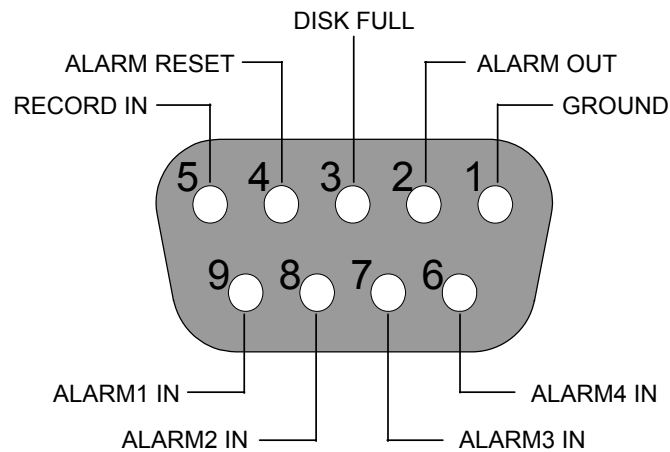

The above figure is the rear view.

1. **GND:** Ground Contact.
2. **ALARM OUT (OUTPUT):** This is an alarm output trigger. Connect this to external devices such as buzzers or lights.



3. **DISK FULL (OUTPUT):** This is a disk full output trigger. Connect this to external devices such as buzzers or lights.



4. **ALARM RESET (INPUT):** This pin connects to an alarm-clear device for clearing an alarm.



5. **RECORD IN (INPUT):** This pin connects to a record trigger device for starting a record.

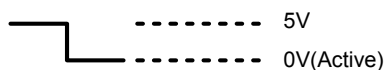

6. **ALARM4 IN (INPUT):** This is an alarm input (for CH 4), which can be programmed in the menu system to Normally Open or Normally Closed.



7. **ALARM3 IN (INPUT):** same as the above, for CH 3
8. **ALARM2 IN (INPUT):** same as the above, for CH 2
9. **ALARM1 IN (INPUT):** same as the above, for CH 1

# 2. INSTALLATION

## 2. INSTALLATION

Please follow the instruction and the diagram below to set up the system.

### 2.1 Basic Connection

#### A. CONNECTING WITH 1 to 4 CAMERAS

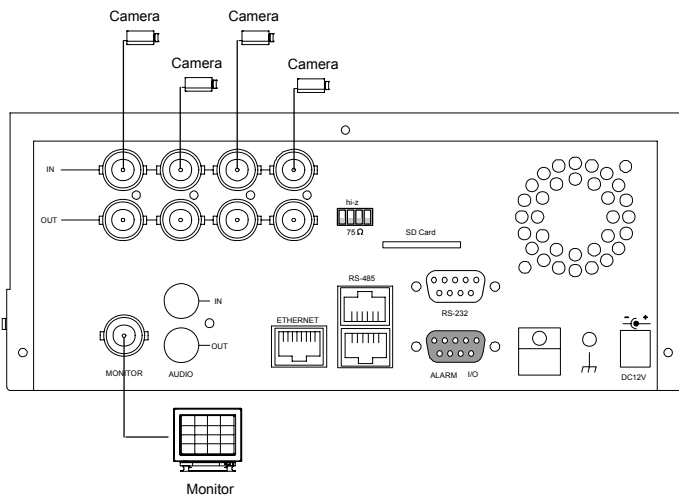

#### B. ATTACHING AN EXTERNAL DEVICE TO DVR

Connect an alarm out, alarm input, and a peripheral device as shown in the diagram below.

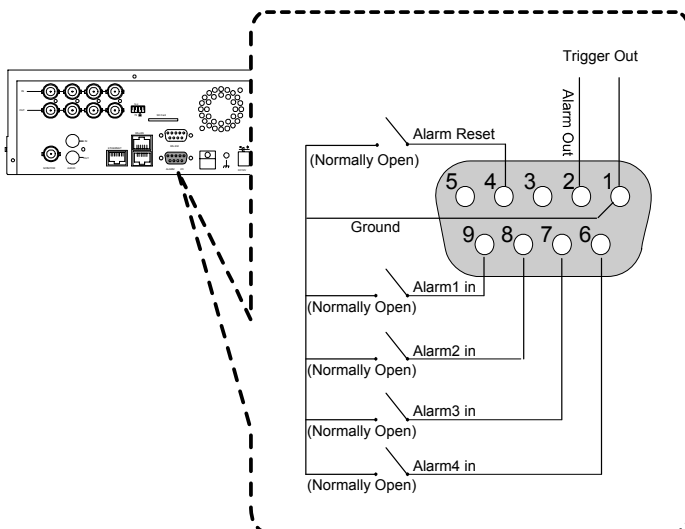

# INSTALLATION ( continued )

## 2.2 Hard-disk Drive Installation

The DVR is equipped with two compartments of hard disk drive (**for removable model only**). The unit usually comes with one hard-disk drive installed in the compartment of HD1, which is default- configured as a master. If you need a second hard-disk drive to be installed in the compartment of HD2 (Mobile), please contact your distributors or installers for specific instructions on how to install it. Please don't serve yourself before consulting your installers. If there is only one hard-disk drive in the mobile compartment, please set the **HD2 USAGE** option to **REC** (please refer to section **4.5**) before

proceeding with the recording function. The jumper-setting arrangement of installed hard-disk drives for the system (Table 3.2 A.) is shown in the tables below.

Note: The **CD-RW model** is equipped with a fixed hard- disk and a CD-RW drive. The unit usually comes with one hard-disk drive installed in the compartment of HD1, which is default-configured as a master.

Table 3.2 A. The jumper settings of hard disk drives in the system

	Location	Jumper
IDE 1	Compartment HD 1	Master (Default)
IDE 2	Compartment HD 2	Master



**Table 3.2 B. Compatible hard-disk drives**

Manufacturer	Model	Capacity	Rotation
Seagate	ST340810A	40G	5400 RPM
	ST380020A	80G	5400 RPM
	ST320014A	20G	5400 RPM
	ST340015A	40G	5400 RPM
	ST380012ACE	80G	5400 RPM
	ST3120025ACE	120G	5400 RPM
	ST340014A	40G	7200 RPM
	ST380011A	80G	7200 RPM
	ST380013A	80G	7200 RPM
	ST3120026A	120G	7200 RPM
	ST3160023A	160G	7200 RPM
	ST3200822A	200G	7200 RPM
	ST3250823A	250G	7200 RPM
	ST3400832A	400G	7200 RPM
	Maxtor	4A160J0-1A	160G
4R080L0-1		80G	5400 RPM
5A300J0-1A		300G	5400 RPM
6Y080L0		80G	7200 RPM
6Y080L0-3		80G	7200 RPM
6Y120L0-1		120G	7200 RPM
6Y200P0-1A		200G	7200 RPM
6Y250P0-1A		250G	7200 RPM
6B300R0		300G	7200 RPM
6L080P0 (RoHS)		80G	7200 RPM
6L100P0 (RoHS)		100G	7200 RPM
6L120P0 (RoHS)		120G	7200 RPM
6L160P0 (RoHS)		160G	7200 RPM
6L200P0 (RoHS)		200G	7200 RPM
6L250R0 (RoHS)		250G	7200 RPM
6L300R0 (RoHS)		300G	7200 RPM
Western Digital	WD800AB	80G	5400 RPM
	WD1200AB	120G	5400 RPM
	WD800BB	80G	7200 RPM
	WD1200BB	120G	7200 RPM
	WD1800BB	180G	7200 RPM
	WD2000BB	200G	7200 RPM
	WD2500JB	250G	7200 RPM
Samsung	SV0802N	80G	5400 RPM
	SV1203N	120G	5400 RPM

**NOTE: Hard-disk drives not shown on this list have not been tested by the engineering team and are not recommended for use with this product. For the latest updated list on the recommended hard disk drives, please contact your dealers or distributors.**

## 2.3 System Information and Channel Selection

### 2.3.1 System information

You can display system settings information as shown in **FIGURE 3.3 A** below at any time by pressing the **Display** button . In the playback mode, the recorded video information is displayed. In the live or recording mode, the Manual Recording information is displayed. Each sequential press of the **Display** button  displays a different message detailed in the following example. By default, the unit displays time, date, and an indicating bar of capacity status on a monitor as shown.

#### Default Display



CH1	CH2
CH3	CH4 01/01/2005 12:00:00

**CH1, CH2, CH3, CH4** are titles for the corresponding channels, changeable in the setup menu.

#### Capacity Status:

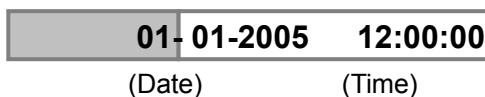
(Capacity Used) (Capacity Remaining)



Press the **Display** button  once; the DVR will display the following sample message plus the default display. Press the **Display** button  again; the unit will not display any OSD message. Press the button one more time to go back to the default display.

**FIGURE 3.3 A**

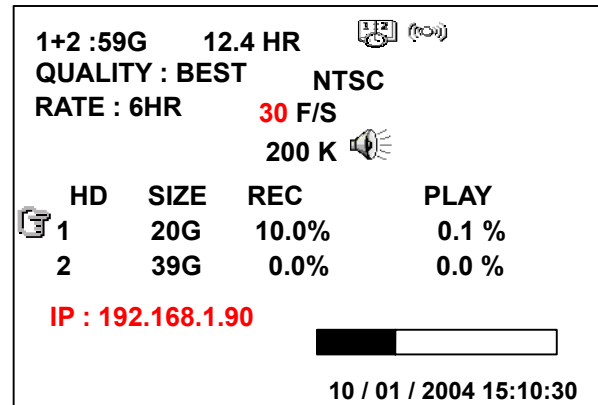

**(1+2: 59G):** Total capacity of installed hard disk, 59 GB.

**(12.4 HR):** Total 12.4 hour recording time available.

(): Timer record activated.

(): Alarm record activated.

**(QUALITY: BEST):** Record quality setting, BEST.

**(NTSC):** NTSC system.

**(RATE: 6 HR):** Setting of Record time mode, 6 hours.

**(30 F/S):** Record speed setting, 30 fields/sec.

(): Audio function activated.

(): Indicates which HDD is activated.

**(200K):** The image file size.

(**HD**): Hard disk compartment.

**(SIZE 20G):** The capacity of the installed hard disk.

**(REC):** Percentage of system recording.

**(PLAY):** Percentage of system playback.

**(IP : 192 . 168 . 1 . 90):** Network IP Address





192.168.1.90

(): External signal.

( X): Cannot operate now.

### 2.3.2 Channel Selection

CH1, CH2, CH3, CH4, Quad() , and the Seq./Save button are used to select the video channel and zoom in factor. The following table shows the functions in a different mode.

Mode	Key	Result Display
Live / Record	Quad (  )	
	CH1/ CH2/ CH3/ CH4	<input type="checkbox"/> ( Single channel )
	Seq./ Save	<input type="checkbox"/> <input type="checkbox"/> <input type="checkbox"/> <input type="checkbox"/>  then loop back
Playback	Quad (  )	
	CH1/ CH2/ CH3/ CH4	<input type="checkbox"/> ( Single channel )

5. Restart the unit when the device sounds a tone twice and displays the message “**PLEASE RESTART**”. The process is complete.

(If you have already followed the procedures 1~5, and the unit is still unable to switch on, please first check if the SD card you are using is functioning and the file is intact. And then start procedures 1 ~ 5 all over again.)

6. Verify the version of the system software. (Please refer to the section **4.6 VERSION** option.)



### Caution:

1. Before carrying out the updating procedures, please ensure the SD card is working and the file of the system software is intact.
2. Don't interrupt the process while the unit is updating itself, as this would cause the unit to hang on.

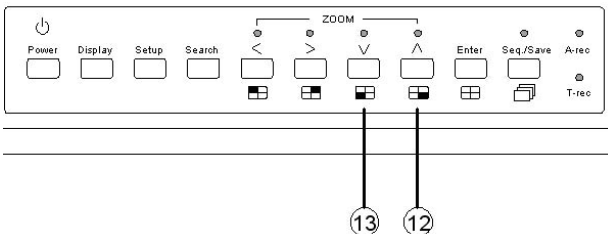
## 2.4 Updating System Software



Please take the following steps to safely update it.

1. Turn off the DVR.
2. Insert the SD card into the built-in SD slot of the unit.
3. Hold down the Up  and Down  buttons simultaneously, and then turn on the unit.
4. Keep holding down the buttons until the DVR sounds a tone and displays the message “ **XXXXXX BYTES READ**”. Now the DVR is updating the system software, which will take approximately 90 seconds to process.

# 3. OPERATIONS

## 3. OPERATIONS

This section shows you how to operate and manage the DVR when it gets in the way.

### 3.1 Configuring Recording Settings

Recording time will vary depending on the image size, recording rate, and the capacity of the hard-disk drives. Generally, the DVR comes with a built-in hard-disk drive for continuous recording from one to four weeks under most recording conditions. The table below shows the possible recording times based on a 20GB hard-disk drive at certain refresh rates and the corresponding image quality. With one or more hard-disk drives in operation, please calculate the recording time using the table below in accordance with your requirements. For an NTSC unit, for example, if the unit is set to record images with the **BEST** quality at a **30 Frame/Sec** record rate, normally a

80GB hard-disk drive will be filled in 41 hours (see the gray area in the table). If the total capacity of 240GB hard-disk drives is in use under the same refresh rate and picture quality, it will be filled in 123 hours (3 times the rate of a 80GB hard-disk drive).

**NOTE:**

1. Recording times on the tables below are estimated. For the actual available recording time of a recording configuration, refer to the system information of the DVR. (Please refer to section 2.3 system information for more details.)
2. There is no audio function at the refresh rate in NTSC: 1.2 fields/sec ~ 1 fields/ 16 sec. There is no audio function at the refresh rate in PAL: 1.4 fields/sec ~ 1 fields / 16 sec.

Record Setting		Possible Recording Time HDD=80GB ( hour )			
		NTSC		PAL	
Image Quality	BEST	41	57.3	41	57.3
	HIGH	47.8	71.6	47.8	71.6
	STANDARD	57.3	95.4	57.3	95.4
	BASIC	71.6	127	71.6	127
Refresh Rate (Frame/Sec)		30	15	25	12.5



## 3.2 Recording Operations

This section details the way to record video into hard-disk drives. Before commencing with the recording function, please configure the recording setting properly according to your needs.

### 3.2.1 Manual Recording

Take the following steps to start and stop recording:

- (1) Press the **REC** button <sup>⑥</sup> to record video into a hard disk drive with the corresponding programmed recording settings. The **REC** button <sup>⑥</sup> will light up indicating the DVR is in the recording status.
- (2) Press the **REC** button <sup>⑥</sup> for 3 seconds to stop recording any time.
- (3) To access just recorded video, please refer to section 3.4 for more details.

### 3.2.2 Timer Recording

Timer recording provides 2 periods of time each day in a weekly table which programs the DVR to turn on and off at specified times. This way the DVR will start/ stop recording according to the programmed schedule.

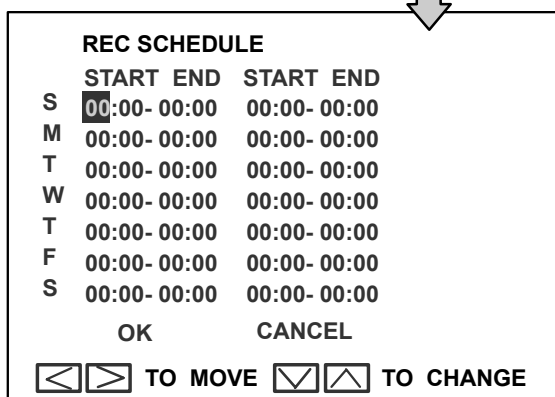
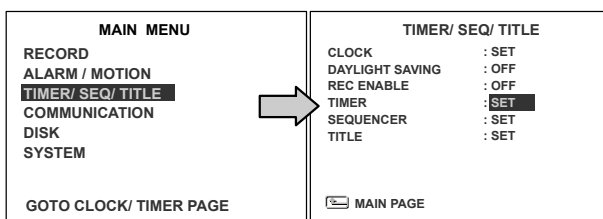

- (1) Press the **Setup** button <sup>⑨</sup> to enter the **MAIN MENU**.

- (2) Select the **CLOCK / TIMER** and press the **Enter** button <sup>⑮</sup> to enter the **CLOCK / TIMER** page.
- (3) Select the **TIMER – SET**.
- (4) Press the **Enter** button <sup>⑮</sup> to enter the **REC SCHEDULE** table.
- (5) You can set up by using the “<” button <sup>⑪</sup> and the “>” button <sup>⑭</sup> to locate the specific day/hour/minute and use the “^” button <sup>⑫</sup> and the “v” button <sup>⑬</sup> to set the day/hour/minute you wish.  
You can also set up by using the **Shuttle Ring** and the **Jog Dial**. is the equal of the “<” button <sup>⑪</sup>, is the equal of the “>” button <sup>⑭</sup>, is the equal of the “^” button <sup>⑫</sup> and is the equal of the “v” button <sup>⑬</sup>.  
The time is displayed in a 24-hour clock format.
- (6) After scheduling is completed, press the **Enter** button <sup>⑮</sup> and set **OK** to save the setting or select **CANCEL** to leave the page without saving.
- (7) To activate/ deactivate the programmed recording schedule, set the **REC ENABLE** to **ON/ OFF**. As the scheduled recording is on, the red indicator of the Timer Record <sup>⑰</sup> will be on as well.

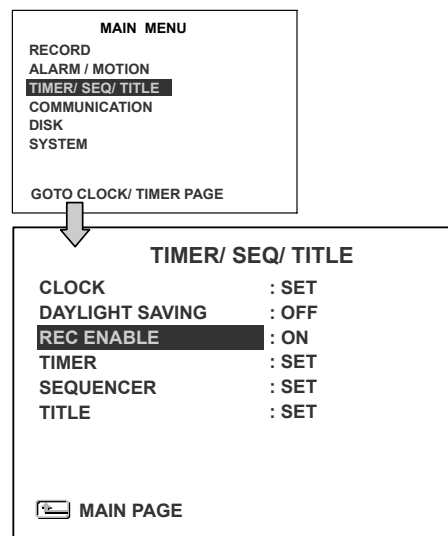

(8) Press the **REC** button **6** for 3 seconds during the scheduled recording to stop it any time. If you wish to continue the scheduled recording, press the **REC** button **6** to proceed.

**Note:** You can proceed to start the scheduled recording from the current time if it is in the scheduled interlude as soon as setting is completed, and come out from the menu to start recording.

**Note:** If you activate the recording function before the scheduled recording, the unit will operate recording as shown in the diagram below and keep those images in different files.

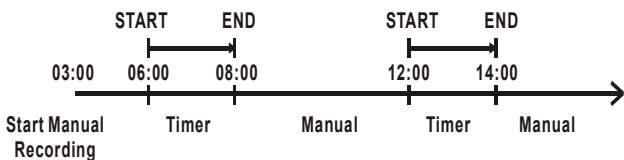

### 3.2.3 Alarm / Motion Recording

Take the following steps to activate the programmed alarm recording. For the **ALM OPERATION**, **AUDIO**, **ALM TYPE**, **ALM DURATION**, and **PRE-ALARM** settings, please refer to section 5.2 for more details.

- (1) Press the **Setup** button **9** to enter the **MAIN MENU**.
- (2) Select **ALARM / MOTION** and press the **Enter** button **15** to enter the **ALARM / MOTION**.
- (3) Set the desired **ALM TYPE**, and **ALM DURATION** for use. If the audio capability is required, set **AUDIO** to **ON**. If pre-alarm recording is required, set **PRE-ALARM** to **ON**.
- (4) To activate/deactivate the alarm recording, set **ALM OPERATION** to **ON/ OFF**.

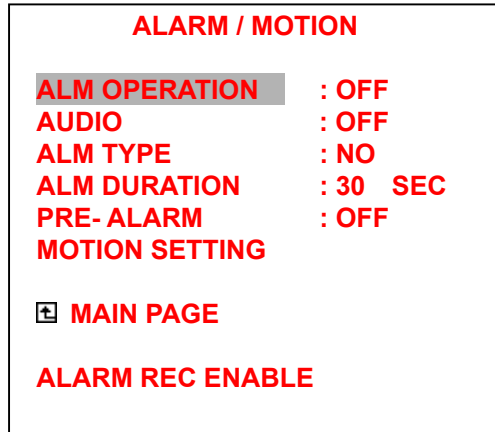
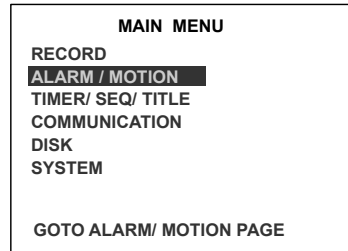

- (5) To active the motion alarm recording, select **MOTION SETTING** and press the **Enter** button **15** to enter the **MOTION SETTING** page, set **MOTION ENABLE** TO **ON**, and set a suitable **SENSITIVITY** and **REGION** according to the video sources.

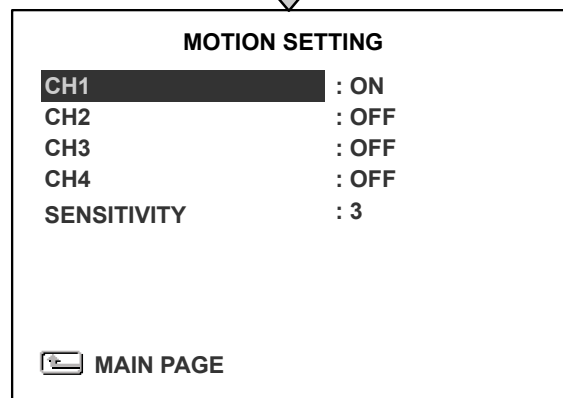
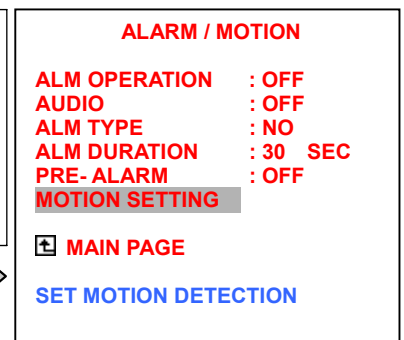
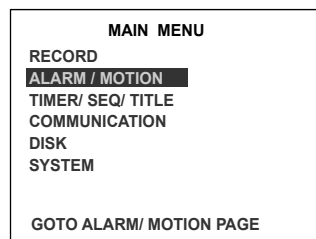

### 3.2.4 Externally Triggered Recording

By connecting the **RECORD IN** of ALARM I/O on the rear panel of the DVR, you can activate/deactivate the recording function of a DVR. The file will be kept with a prefixed **"R"**.

**NOTE: The status of recording operations when an alarm takes place is shown in the diagrams below.**

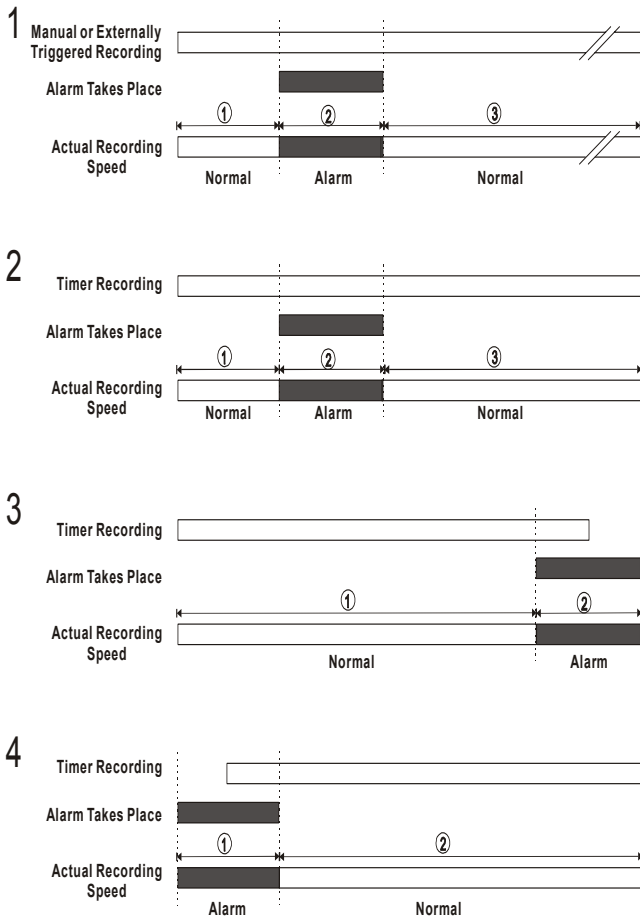

## 3.3 Playback Operations

This section shows you how to operate the fast, slow, and single-picture playback functions, and details how the unit is to playback a file in a different operation status. Please refer to the following paragraphs specifying the relevant details. When playing a file, the monitor should display a flashing **PLAY** message and the **PLAY** button (4) will light up indicating that the DVR is in the playback status.

To switch between channels 1-4 and quad view in the playback mode, please press the (11) **CH1** (14) **CH 2** (13) **CH 3** (12) **CH4** and (15)  buttons.

### 3.3.1 Normal Playback

Once the user presses the **PLAY** button, the DVR would start playing back the recorded data at the recorded speed. The starting position of a play back depends on different operation sequences.

**A. Play back from the latest playback STOP position.**

[ **PLAY** ] - [ **STOP** ] - [ **PLAY** ]

**B. Play back from the latest recorded video.**

[ **REC** ] - [ **PLAY** ] or

[ **REC** ] - [ **REC Stop** ] - [ **PLAY** ]

**C. Play back from a video clip in the Search List.**

[ **Search** ] - [ **PLAY** ]

**D. Play back from the beginning of a hard disk's recorded data.**

[ **STOP** - press the key for 3 sec. ] - **PLAY**

Once playback reaches the end of an HDD's recorded data, the DVR will show the ending

message ( use **SEARCH** functions or rewind to replay the file if required )

### 3.3.2 Fast Forward/Backward

There are **7** speeds available for playback: 1x, 2x, 4x, 8x, 16x, 30x and 100x.

While playing back recorded video at the recorded speed:

**Forward:** Turn the **Shuttle** dial (20) to the right to view the recorded video in the forward direction at a speed faster than the recorded speed. Each subsequent turn of the shuttle to the right increases the forward rate, as 2x, 4x, 8x, 16x, 30x and 100x.

**Backward:** Turn the **Shuttle** dial (20) to the left to view the recorded video in the reverse direction at a speed faster than the recorded speed. Each subsequent turn of the shuttle to the left increases the reverse rate, as -1x, -2x, -4x, -8x, -16x, -30x and -100x.

**Normal:** Release the **Shuttle** dial (20) to return to the normal speed of playback.

### 3.3.3 Slow Forward/Reverse

There are 4 speeds available for a slow playback: 1/2, 1/4, 1/8, 1/16.

While playing back recorded video at the recorded speed:

(1) Press the **PAUSE** button (3) for the slow playback mode.

(2) **Forward:** Turn the **Shuttle** dial (20) to the right to view the recorded video in the

forward direction at a speed slower than the recorded speed. Each subsequent turn of the shuttle to the right increases the forward rate, as 1/2, 1/4, 1/8, and 1/16.

- (3) **Normal:** Release the **Shuttle** dial (20) and then press the **PLAY** button (4) to return to the normal speed of playback.

### 3.3.4 Play back Picture-by-picture

While playing back recorded video at the recorded speed:

- (1) Press the **PAUSE** button (3) for the picture-by-picture mode.
- (2) There are two ways available, by PAUSE button or by JOG, to play in the picture-by-picture mode.

By PAUSE button (3) :

Press the **PAUSE** button (3) to display one frame of a picture at a time in the forward direction.

By JOG dial (21) :

Turn the **JOG** dial (21) clockwise to display one frame of a picture at a time in the forward direction.

- (3) Press the **PLAY** button (4) to return to the normal speed of playback.

### 3.3.5 Playback Recorded Video from an HDD of the mobile rack (for removable HDD model only)

To play back a recorded video from an HD2, take the following steps:

- (1) Press the **Search** button (10) to enter the search mode.
- (2) Press the “**▲**” (12) and (13) “**▼**” buttons to select a video; press the (11) “**<**” and (14) “**>**” buttons to flip over a page.
- (3) Use the search function to access desired

recorded video. For specific operation details please refer to the next section 3.4 (Search Operations).

### 3.3.6 Picture in Picture ( PinP ) Display Mode

When pressing the **Display** button in the play mode, any one of 5 statuses can result: (1) No information; (2) Quad view with titles and date. (3) PinP status 1. (4) PinP status 2. (5) Full information.

While playing back recorded video, the display mode can be switched to 2 different PinP modes by pressing the **DISPLAY** button (8).

**PinP Status 1**

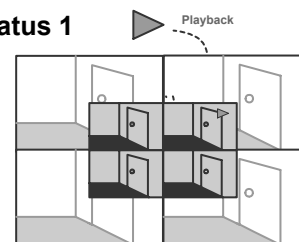

**PinP Status 2**

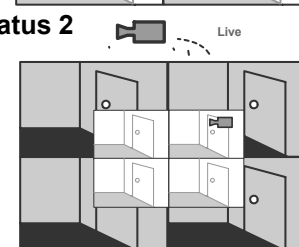

## 3.4 Search Operations

This section shows you how to access recorded video.

### 3.4.1 FULL LIST Search

Take the following steps to proceed with the full-list search function.

- (1) Press the **Search** button <sup>(10)</sup> to enter the search mode.
- (2) Select the **FULL LIST** and press the **Enter** button <sup>(15)</sup> to access the complete list of recorded video.
- (3) Highlight the specific recorded video of your requirement and press the **Enter** button <sup>(15)</sup> to display the selected video.

**(Key Operation: Press the “^” <sup>(12)</sup> and “v” <sup>(13)</sup> buttons to select a video; press the <sup>(11)</sup> “<” and <sup>(14)</sup> “>” buttons to flip over a page.)**

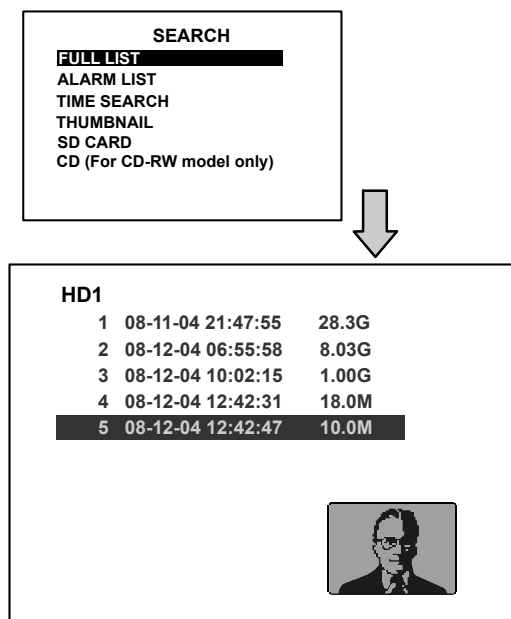

**NOTE: T: Timer recording; R: External trigger recording; A: Alarm recording.**

**NOTE: The maximum number of indexes in the list, for an HDD, is 3000.**

### 3.4.2 ALARM LIST Search

Take the following steps to proceed with the alarm-list search function.

- (1) Press the **Search** button <sup>(10)</sup> to enter the search mode.
  - (2) Select the **ALARM LIST** and press the **Enter** button <sup>(15)</sup> to access the complete list of alarm-event recorded video.
  - (3) Highlight the specific recorded video of your requirement and press the **Enter** button <sup>(15)</sup> to display the selected video.
- (Key Operation: Press the “^” <sup>(12)</sup> and “v” <sup>(13)</sup> buttons to select a video; press the <sup>(11)</sup> “<” and <sup>(14)</sup> “>” buttons to flip over a page.)**

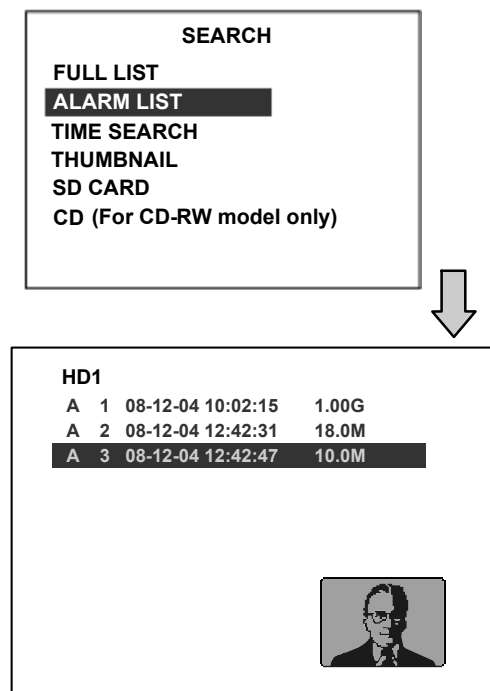

### 3.4.3 TIME Search

Take the following steps to proceed with the time-list search function.

- (1) Press the **Search** button <sup>(10)</sup> to enter the search mode.
- (2) Select the **TIME SEARCH** and press the **Enter** button <sup>(15)</sup> to access the time-setting page.

- (3) Set the time period you wish to search for the recorded video.
- (4) Press the **Enter** button <sup>⑮</sup> to start searching for and displaying the concerned image.
- (5) If no video is found, please return to the time-setting page and repeat steps (3) and (4) again for another search.

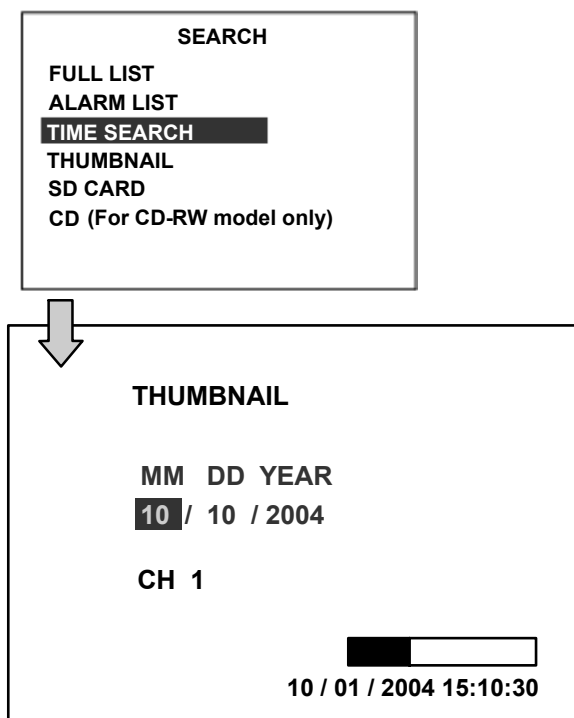

### 3.4.4 THUMBNAIL Search

Take the following steps to proceed with the thumbnail search function.

- (1) Press the **Search** button <sup>⑩</sup> to enter the search mode.
- (2) Select the **THUMBNAIL** and press the **Enter** button <sup>⑮</sup> to access the thumbnail page.
- (3) Set the date you wish to search for the recorded video.
- (4) Press the **Enter** button <sup>⑮</sup> to start searching for and displaying the concerned image.
  - You can set up by using the “<” <sup>⑪</sup>, “>” <sup>⑭</sup>, “^” <sup>⑫</sup>, and “v” <sup>⑬</sup> buttons to move focus.

- You can also set up by using the **Shuttle Ring** and the **Jog Dial** to move eye focus. <sup>⓪</sup> is the equal of the “<” button <sup>⑪</sup>, <sup>Ⓛ</sup> is the equal of the “>” button <sup>⑭</sup>, <sup>Ⓜ</sup> is the equal of the “^” button <sup>⑫</sup> and <sup>Ⓨ</sup> is the equal of the “v” button <sup>⑬</sup>.
- (5) There are **5** levels of recording range modes to choose from: **1 Hour, 10 Minutes, 1 Minute, 10 Seconds** and **1 Second**. Select the specific field of your requirement and press the **Enter** button <sup>⑮</sup> to enter the next level. If you want to return to the previous level, please press the **Setup** button <sup>⑨</sup>.
  - (6) On reaching the critical point at any level, the user can start playback by just clicking the **PLAY** button <sup>④</sup>.

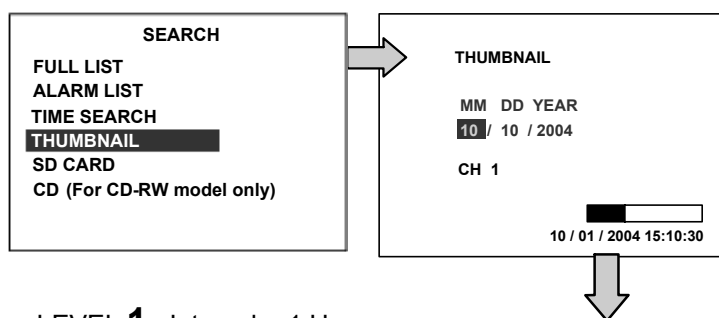

#### LEVEL 1 : Interval = 1 Hour

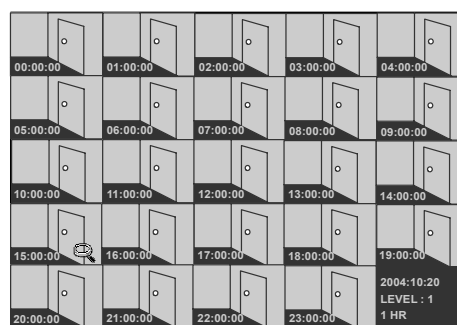

#### LEVEL 2 : Interval = 10 Min.



LEVEL 3 : Interval = 1 Min



LEVEL 4 : Interval = 10 Sec.



LEVEL 5 : Interval = 1 Sec.



### 3.4.5 SD CARD Search

Take the following steps to proceed with the SD card search function.

- (1) Insert an SD Card into the SD card slot of the rear unit.
- (2) Press the **Search** button <sup>(10)</sup> to enter the search mode.
- (3) Select the **SD CARD** and press the **Enter** button <sup>(15)</sup> to access the complete list of JPG files.
- (4) Highlight the specific JPG file of your

requirement and press the **Enter** button <sup>(15)</sup> to display the image.

- (5) If you need another, please return to the SD card JPG file list page and repeat steps 3 and 4 again for another search.

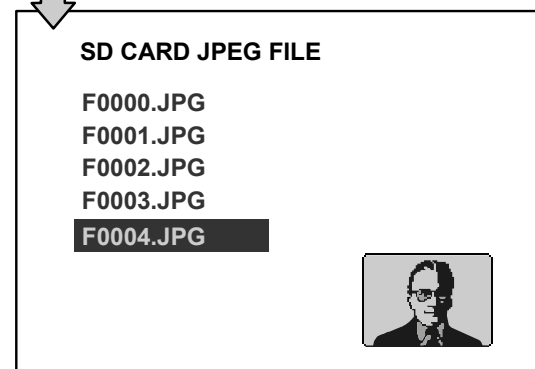
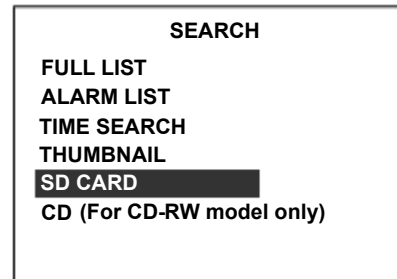

**NOTE:** To delete a JPG file in the SD card, please return to the SD CARD JPG FILE list page, highlight the specific JPG file and press the **Setup** button <sup>(9)</sup>; then select "Yes" to delete the image.

### 3.4.6 CD MENU

#### 3.4.6.1 CD Menu (FOR CD-ROM MODEL ONLY)

Take the following steps to proceed with the CD search function.

- (1) Place the disc in the tray.
- (2) Press the **Search** button <sup>(10)</sup> to enter the search mode.
- (3) Select the **CD** option and press the **Enter** button <sup>(15)</sup> to access the complete list of JPEG files.
- (4) Highlight the specific JPEG file of your



requirement and press the **Enter** button <sup>15</sup> to display the image.  
(5) If you need another, please press the **Enter** button <sup>15</sup> to return to the **CD MENU** page and repeat step (4) again for another search.

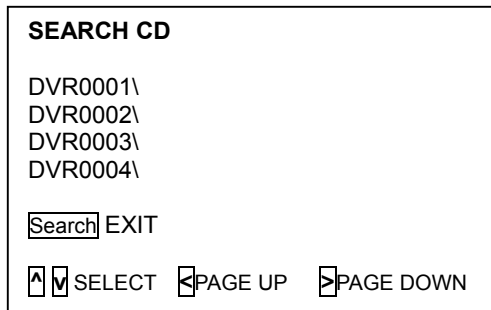
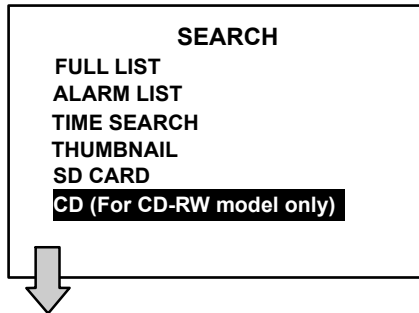

(“CD” STANDS FOR THE CD-ROM MODEL AND “BACKUP” INDICATES THE REMOVABLE HDD MODEL ONLY IN ITEM 6.)

**NOTE:** If by accident one selects a CD item and forgets to insert it: See the picture below for this status and please insert a CD or press the search button to exit the CD menu.

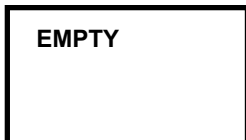

### 3.4.6.2 BACKUP Menu (FOR HARD-DISK MODEL ONLY)

Please refer to section 4.4.2 “**Mobile Rack HD Backup Operations**” for more details.

### 3.5 Backup Operations

#### 3.5.1 CD Rewritable unit Backup Operations (FOR CD-ROM MODEL ONLY)

This device now includes a CD-RW unit.

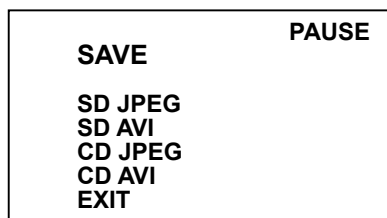

- (1) **SD JPEG:** Archive single image clips into an SD card. (Please refer to section 3.5.3)
- (2) **SD AVI:** Archive video of AVI clips into an SD card. (Please refer to section 3.5.3)
- (3) **CD JPEG:** You can archive a lot of single images in a CD disc by entering this item. Please follow the steps given below.
  - i ) Please insert the CD disc in its tray. You'll hear a signaling beep to tell you the disc is ready.
  - ii ) Play the video back to find your desired item. Press **PAUSE** when you find it.
  - iii ) Press the **Enter** button and select # 3 ( "**CD JPEG**" ) and enter.
  - iv ) You've entered the **CD JPEG** menu.
  - v ) Select item 1 ( "**ADD**" ) to add your image into the buffer.

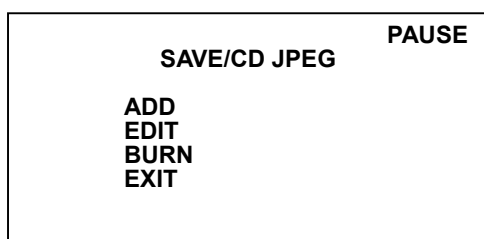

- vi ) Turn the jog dial or Play button to find the next image you want. Now repeat the last step again to add this image to the buffer. You can continue in this way

indefinitely.

- vii ) If you now wish to edit your buffer, select item 2 ( "**EDIT**" ) in the **CD JPEG** menu. Now in the **EDIT jpeg** page, press " < ", " > ", " v " and " ^ " buttons to review your selected images. As the images move, you can decide to delete or not delete any image you find unnecessary or not by pressing the "**Setup**" buttons to "**NO**" ( meaning no deletions ) or "**YES**" ( meaning you're deleting a particular image ). Press the "**Search**" button to exit this page.
- viii ) If your selection is complete, enter item 3 ( "**BURN**" ) in the **CD JPEG** menu. Give the device some time to complete this process.
- ix ) Press the eject button to open the CD tray, take out the CD disc, and enter it in a PC to view your selections.

- (4) **CD AVI:** You can archive a video in the CD disc by entering this item.

Please follow the steps given below.

- i ) Please insert the CD disc in its tray. Hear that beeping signal to confirm your disc is ready.
- ii ) Play the video back to find your desired item. Press **PAUSE** when you want to start.
- iii ) Press the **Enter** button and select # 4 ( "**CD AVI**" ) and enter.
- iv ) You're in the **CD AVI** menu now.

v )

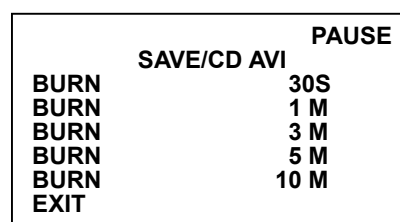

Use the " v " and " ^ " buttons to select

the time length of your saved recording between “30 seconds”, “1M”, “3M”, “5M” and “10M”. Then enter this item to start burning your video in the CD disc.

- vi) Press the eject button to open the CD tray, take out the CD disc, and enter it in a PC to view your video.

### 3.5.2 Mobile Rack HD Backup

#### Operations

There are **3** ways available to duplicate the recorded video from HD 1 (Fixed HD) to HD 2 (Mobile Rack HD). Please take the following steps to proceed.

- (1) **Set HD 2 to BACKUP first. Take the following steps.**

Press the **Setup** button <sup>9</sup> to enter the setup mode and select the **DISK**. Highlight **DISK** and press the **Enter** button <sup>15</sup> to enter the **DISK SETTING** page.

Then set **HD 2 USAGE** to **BACKUP**.

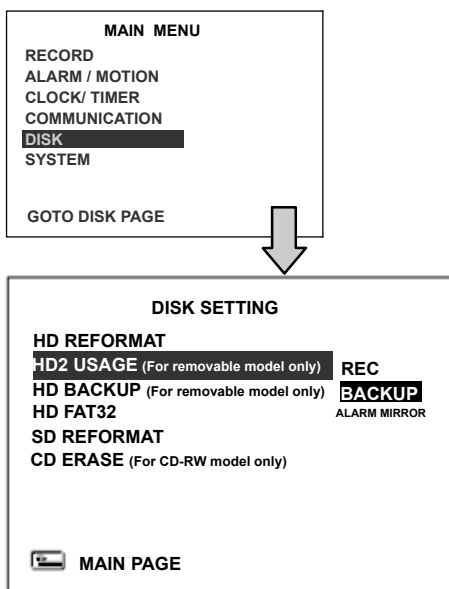

- (2) **FULL:** Duplicate all the recorded video from HD1 to HD2.

On the **DISK SETTING** page, use the “**^**” <sup>12</sup> and “**v**” buttons and button <sup>13</sup> to highlight **BACKUP**, select **FULL**, then press the **Enter** button <sup>15</sup> to proceed.

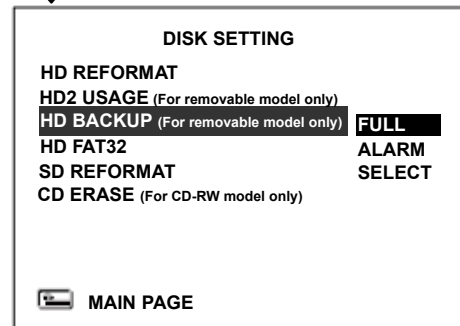
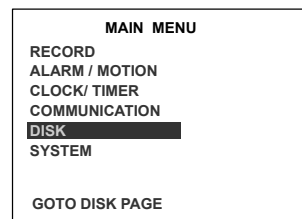

**ALARM:** Duplicate all the alarm-event recorded video from HD 1 to HD2.

Stay on the **DISK SETTING** page.

Use the “**^**” <sup>12</sup> and “**v**” buttons and button <sup>13</sup> to highlight **BACKUP**; select **ALARM**, then press the **Enter** button <sup>15</sup> to proceed.

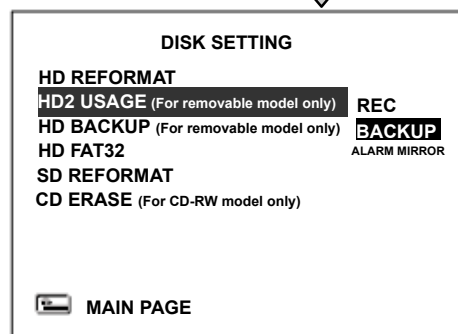
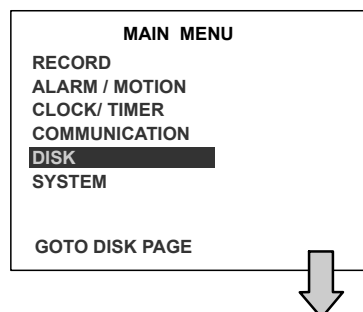

**SELECT:** Duplicate a particular recorded video from HD1 to HD2.

Stay on the **DISK SETTING** page.

Use the “**^**” <sup>12</sup> and “**v**” buttons <sup>13</sup>, to highlight **HD BACKUP**, choose the “**SELECT**” item and then press the

Enter button **(15)** to list all the recorded video.

Press the “**^**” **(12)** and “**v**” **(13)** buttons to select the desired clip and press the **Search** button **(9)** to mark it.

After completing the selection, press the **Enter** button **(15)** to proceed.

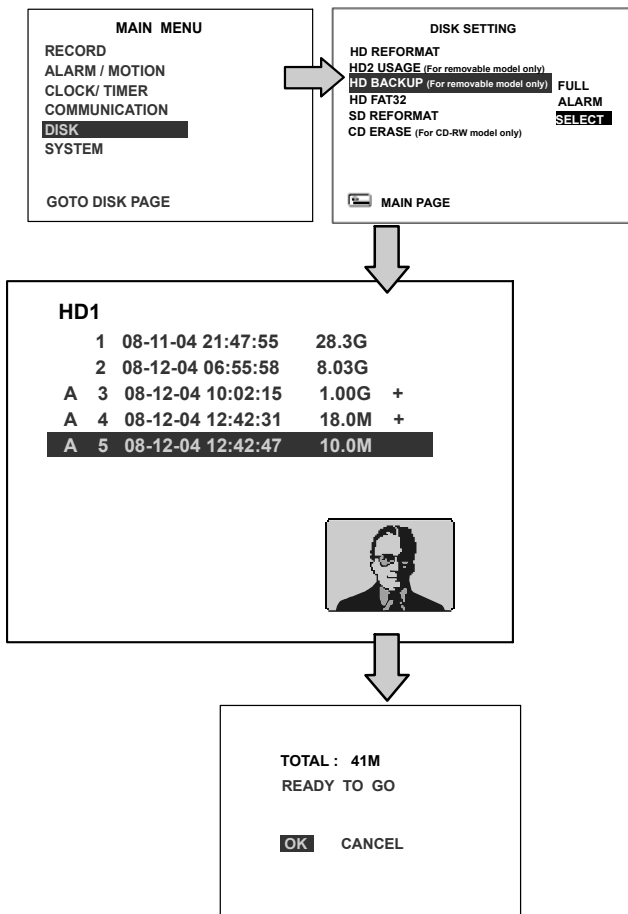

**NOTE:** If the capacity of HD 2 is not sufficient to store all selected video, a warning message “**HD2 SPACE NOT ENOUGH**” will be displayed on the screen. Please, insert a larger capacity of hard-disk drive and start the process all over again.

### 3.5.3 SD Card Backup Operations

The SD card slot of the rear unit has four functions as shown below:

#### 3.5.3.1 Archive Single image Clips into an SD Card

Please take the following steps to archive a critical image in an SD card.

- (1) Insert an SD Card into the SD card slot of the rear unit.
- (2) Start playing back the recorded video.
- (3) Press the **PAUSE** button **(3)** to freeze the desired pictures.
- (4) Press the **Seq./Save** button **(15)** to save the image in the SD Card.

The quantity of pictures which can be stored depends on the SD card capacity. You can have the saved images printed out in any computer. The image is stored in the JPEG compressed format. If more than one clip is stored in an SD card, file names will be assigned in sequence as shown below.

**SAVE TO F000.JPG**  
**SAVE TO F0001.JPG**  
 ...  
**SAVE TO F000N.JPG**

- (5) If you have already saved the current picture on your screen. Please click the corresponding channel and then press **Seq./Save** **(16)** button to save.

#### 3.5.3.2 Archive video of AVI clips into an SD card

Please take the following steps to archive a critical video in an SD card.

- (1) Insert an SD Card into the SD card slot of the rear unit.
- (2) Start playing back the recorded video.
- (3) Press the **PAUSE** button **(3)** to freeze the desired pictures.
- (4) Press the **Seq./Save** **(16)** button to save the video in the SD Card.

The quantity of video which can be stored depends on the SD card’s capacity. The image is stored in the AVI compressed format. If more than one clip is stored in an SD card, file names will be assigned in sequence as shown below.

SAVE TO M0000.AVI  
 SAVE TO M0001.AVI  
 ...  
 SAVE TO M000N.AVI

**NOTE:**

- The JPEG file format can be played and deleted in the DVR. Please refer to section 3.4.5.
- The AVI file format cannot be played and deleted in the DVR. It can only be played in a card reader connected to a computer.
- The file format can be selected from the “SD FILE” item in the Setup Menu. Please refer to section 4.5 for more detail.

**Backup the System setting info into an SD card.**

The DVR offers a quick setup method by using the SD card. If a user wants to set many DVR devices with the same settings, the DVR could save the whole setting in the SD card, then transfer it to another DVR.

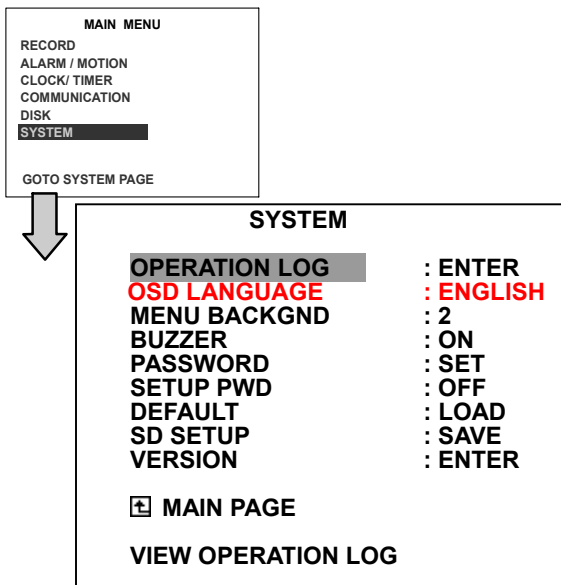

**Save the whole setting into the SD card:**

Insert an SD card into the SD card slot.

Press the **Setup** button (9) to enter the setup mode.

Highlight **SYSTEM** and press the **Enter** button (15) to enter the **SYSTEM SETTING** page.

Set **SD SETUP** to **SAVE**. Then the system

setting info will auto save into SD card.

**Transfer the system setting info of DVR to another:**

Insert the SD card which has stored the system setting info into the DVR.

Press the **Setup** button (9) to enter the setup mode and select the **SYSTEM**.

Highlight **SYSTEM** and press the **Enter** button (15) to enter the **SYSTEM SETTING** page.

Then set **SD SETUP** to **LOAD**.

**3.5.3.4 Updating System Software**

Please refer to section 4.6 for more details.

**3.6 Key Lock Operation**

The Key Lock operation protects the unit against unauthorized use by disabling the entire front panel controls. Please press the **Enter** button (15) (as shown below) for at least 3 seconds to lock the unit; to release the **Key Lock**, press this button again.

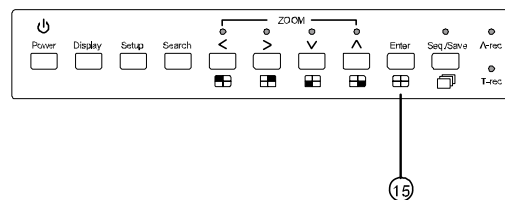

# 4. MENU SETUP

## 4. MENU SETUP

There are **6** categories for operation setting in the menu setup system as shown below. The following sections will instruct you step by step how to configure the operation setting and state each menu's purpose and options. Press the **Setup** button **9** to access the setup menu. Once inside the menu system, the on-screen menu allows you to set up the key features of the unit. The functions of various buttons within the menu-setup mode are described in the paragraphs below.

### KEY FUNCTIONS

**Setup** button **9** :

Press to enter the setup menu. Press again to exit the setup mode.

“**▲**” **12** and “**▼**” **13** buttons :

Press to select the desired item or entry for setting.

“**<**” **11** and “**>**” **14** buttons

Press to highlight the desired option or to select the context for setting.

**Enter** **15** button :

Press to enter the selected item and to save the setting.

**Shuttle Ring** **20** :

Turn to highlight the desired option or to select the context for setting.

**Jog Dial** **21** :

Turn to select the desired item or entry for setting.

## 4.1 REC Setting

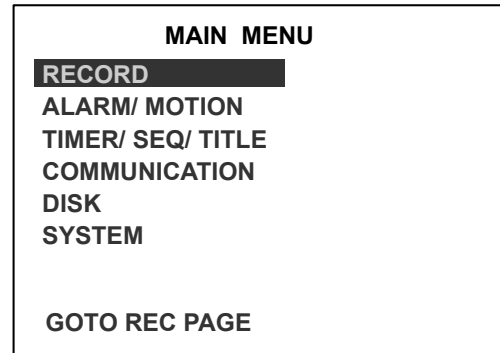

This page allows you to set the recording rate and recording quality, and enables you to continue recording when the disk is full.

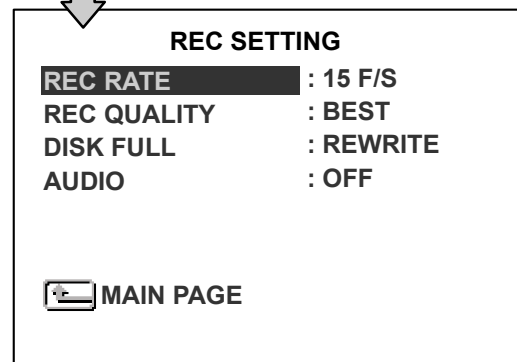
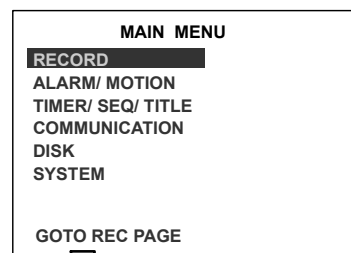

### REC RATE :

This option is for adjusting the number of pictures recorded every second into a storage disk. The recording rate controls the frequency at which the number of video pictures can be recorded.

- For an NTSC unit, there are 2 different recording rates you can select from: **30F/S (30 frames per second) and 15F/S**
- For a PAL unit, there are 2 different recording rates you can select from: **25F/S (25 frames per second) and 12.5F/S**. Please refer to the table in section 4.1 for details.

**NOTE: The 30 F/S (25 F/S for a PAL unit) recording rate can only function in a 352x240 (352x288 for a PAL unit) resolution.**

**REC QUALITY:**

This option determines the image quality to be recorded. The DVR stores images in the compressed format and allows the image quality to be altered by the image size. There are 4 levels of image quality you can select from: **BEST**, **HIGH**, **STANDARD**, and **BASIC**. Selecting the BEST image for use provides higher-resolution recorded images, and normally takes up more storage space than a HIGH, STANDARD or BASIC image does.

**DISK FULL:**

This option determines the way to utilize storage media in case of a full disk.

**REWRITE:** When the hard-disk is full, the device continues recording by displacing the old data.

**STOP:** When the hard-disk is full, the device will stop recording.

**AUDIO:** This option determines the way to record sound if necessary.

**ON:** Enables AUDIO recording.

**OFF:** Disables AUDIO recording.

## 4.2 ALARM / MOTION Setting

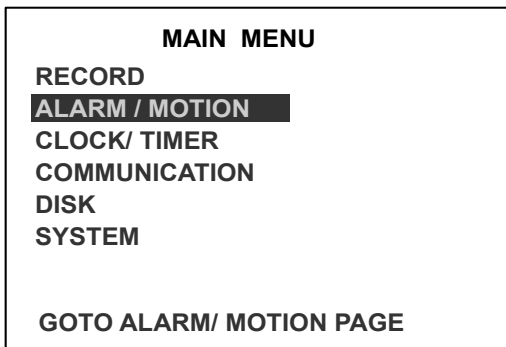

This menu allows users to program the configuration of alarm recording only when an alarm input is activated. The device will record as long as the alarm input is activated.

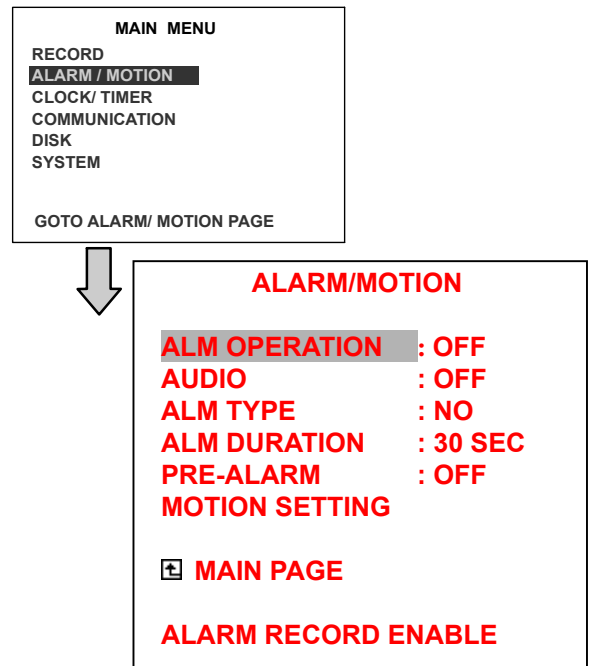

**ALM OPERATION:**

This option determines whether to activate/deactivate the alarm recording when it detects an alarm input.

**ON:** The device activates the alarm recording when it detects an alarm input.

**OFF:** The device ignores the alarm signal when it detects an alarm input.

**AUDIO:**

This option determines the way to record sound if necessary.

**OFF:** Disables AUDIO recording.

**ON:** Enables AUDIO recording.

**ALM TYPE:**

This option allows users to set a type of alarm input corresponding to the sensor signal in use.

**NO:** Normally Open. This is to be used with the type of alarm sensor whose contact remains open in normal conditions and

closes in case of activation.

**NC:** Normally Closed. This is to be used with the type of alarm sensor whose contact remains closed in normal conditions and opens in case of activation.

#### ALM DURATION:

This option allows users to set alarms for a certain duration. You can select one of the six following options: **0 SEC, 30SEC, 1 MIN, 5 MIN, 10 MIN,** and **NON-STOP.**

**NOTE: Recording may be interrupted during Alarm-in or Alarm-out.**

#### PRE-ALARM:

This option determines that images prior to an alarm occurs will be recorded in the hard-disk drive. When an alarm is triggered the device will record the image prior to the alarm for 5 seconds (10 frame / sec).

**ON:** Enables this function.

**OFF:** Disables this function.

**NOTE: If the device is already under recording mode before an alarm occurs, the pre-alarm recording will not take effect.**

#### MOTION SETTING:

The motion detection function is convenient for people without an alarm trigger input, but the function can be used with an alarm trigger input at the same time. If this function is enabled, the object movement will trigger the alarm recording just like the outside trigger signal. Before using the motion detection function, please turn the **CH1/ CH2/ CH3/ CH4** options at **ON**, and set **SENTIVITY** (1 ~ 5) to a suitable value.

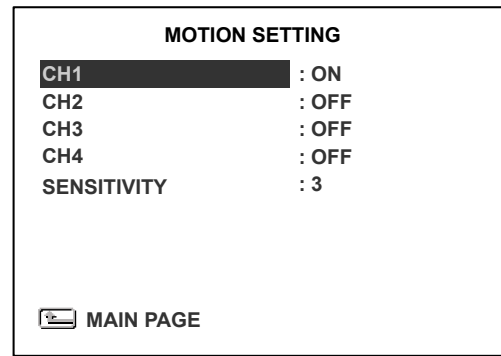

#### CH1/ CH2/ CH3/ CH4 :

These options enable/disable the motion detection.

**ON:** Enables the motion detection.

**OFF:** Disables the motion detection.

#### SENSITIVITY(1 ~ 5):

This option allows users to set the motion sensitivity. **1** is the most sensitive setting. **5** is the least sensitive setting.

### 4.3 TIMER / SEQ / TITLE Setting

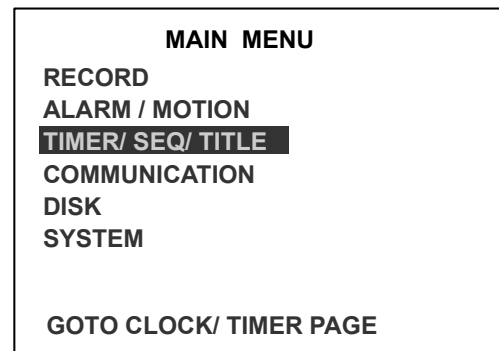

The DVR provides a weekly table consisting of two periods of time each day for scheduled recording. This option allows you to set the time each day when the DVR will start and stop recording.

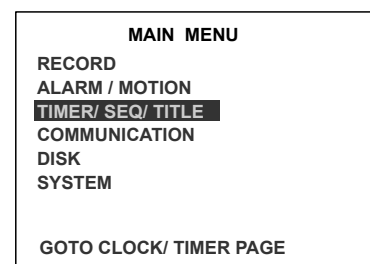



TIMER/ SEQ/ TITLE	
CLOCK	: SET
DAYLIGHT SAVING	: OFF
REC ENABLE	: OFF
TIMER	: SET
SEQUENCER	: SET
TITLE	: SET
<input type="checkbox"/> MAIN PAGE	
TIMER REC ENABLE	

**CLOCK:**

This entry allows users to set the system time.

**NOTE:** Clock data is retained for about 3 months after the 15-hour power supply is used up (the Operate On mode).

**DAYLIGHT SAVING:**

This entry allows users to set the daylight saving time.

**OFF:** Disables the daylight saving time.

**US:** Daylight saving time begins at 1:00 a.m. on the first Sunday of April. The measurement of reverts to standard time at 2:00 a.m. on the last Sunday of October.

**EUROPE:** Daylight saving time begins at 1:00 a.m. on the last Sunday of March. The measurement of reverts to standard time at 2:00 a.m. on the last Sunday of October.

**SET:** Sets the daylight saving time.

**REC ENABLE:**

This option enables/disables the programmed scheduled recording.

**ON:** Enables the scheduled recording.

**OFF:** Disables the scheduled recording.

**TIMER:**

This entry allows users to program the time each day when the DVR will start and stop recording. There are **2** time periods each day available for scheduling. The time is displayed in a 24-hour clock format. If there is a time overlapping showing between two continual time period settings, the device will automatically combine the two time-period settings into one.

REC SCHEDULE			
	START	END	START END
S	00:00-00:00	00:00-00:00	00:00-00:00
M	00:00-00:00	00:00-00:00	00:00-00:00
T	00:00-00:00	00:00-00:00	00:00-00:00
W	00:00-00:00	00:00-00:00	00:00-00:00
T	00:00-00:00	00:00-00:00	00:00-00:00
F	00:00-00:00	00:00-00:00	00:00-00:00
S	00:00-00:00	00:00-00:00	00:00-00:00
OK		CANCEL	
<input type="checkbox"/> <input type="checkbox"/> TO MOVE		<input type="checkbox"/> <input type="checkbox"/> TO CHANGE	

**SEQUENCER:**

This entry allows users to set the DWELL time (time interval) for CH1, CH2, CH3, CH4, and quad view(). The valid values are 01 ~ 99 seconds; if the dwell time is set to 00, it will disable the corresponding channels, while the sequential jumping is proceeding. In the live mode, press the **Seq./Save** button to switch the screen to the sequential jumping is proceed. In live mode, press the **Seq./Save** button to switch the screen to the sequential jumping mode.

SEQUENCER					
CHANNEL	1	2	3	4	<input type="checkbox"/>
DWELL	03	03	03	03	03

## TITLE:

This entry allows users to set the titles for each video source or camera, in live or recording mode. Press the DISPLAY button to switch the display status and show the titles. The maximum length for each title is 24.

TITLE	
CH1	[ FRONT DOOR ]
CH2	[ KITCHEN ]
CH3	[ BACKYARD ]
CH4	[ ROOM ]

◀▶ TO MOVE    ◻◻ TO CHANGE

## 4.4 COMMUNICATION Setting

MAIN MENU
RECORD
ALARM / MOTION
CLOCK/ TIMER
<b>COMMUNICATION</b>
DISK
SYSTEM

GOTO COMM PAGE

This option allows you to configure the status of the RS-232 / RS485 communication when connected to external devices, and the Ethernet communications settings. Please refer to sections 6.1 RS-232/RS485 Protocols and 5. Network Functions for more details.

MAIN MENU
RECORD
ALARM / MOTION
CLOCK/ TIMER
<b>COMMUNICATION</b>
DISK
SYSTEM

GOTO COMM PAGE

↓

COMM SETTING	
<b>COMM ID</b>	: 01
<b>RS232</b>	: ON
<b>RS485</b>	: ON
<b>NET ENABLE</b>	: OFF
<b>NET DHCP</b>	: OFF
<b>NET IP</b>	: SET
<b>NET ACCOUNT</b>	: SET

⏪ MAIN PAGE  
SET RS232 / RS485 ID

## COMM ID:

Communication ID is for RS232 and RS485 communication. After the DVR receives a RS232 or RS485 command, it checks if the <Dest ID> within the code is the same as the COMM ID, in which case the particular command can be accepted.

## RS-232:

The RS-232 communication port can be either in an importing or exporting mode according to your applications.

**ON:** Enables the RS-232 communication port. When you wish the unit to be controlled by an external device, please select this entry for use.

**OFF:** Disables the RS-232 communication port.

## RS-485:

The RS-485 communication port can be either in an importing or exporting mode according to your applications.

**ON:** Enables the RS-485 communication port. When you wish the unit to be controlled by an external device, please select this entry for use.

**OFF:** Disables the RS-485 communication port.

## NET ENABLE:

This option selects either enable or disable for the Ethernet communication port.

**OFF:** Disables it.

**ON:** Enables it.

## NET DHCP:

This option selects enable or disable for the DHCP communication function.

**OFF:** Disables it.

**ON:** Enables it.

**NOTE:** If provided with a DHCP server, the DVR can get an IP automatically by setting this option to ON.

**NET IP:**

This option is used to configure the Ethernet communication settings. This is required for the purpose of making a network connection. Please consult with a qualified MIS professional to configure it.

**IP:**                XXX.XXX.XXX.XXX  
**MASK:**           XXX.XXX.XXX.XXX  
**GATEWAY:**      XXX.XXX.XXX.XXX  
**HTTP PORT:**    XXXX

**NET ACCOUNT:**

When accessing the DVR via the Microsoft Internet Explorer, users have to login by entering the user name and password. The user who accesses with the admin name and password has the full power to even change the settings of the DVR. However, a user who accesses with just the viewer name and password has only the limited power to view.

**ADMIN:** [admin                ] [9999]  
**VIEW:**    [view                     ] [0000]

**4.5 DISK Setting**

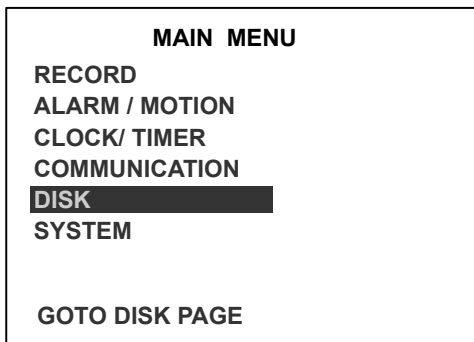

**REFORMAT:**

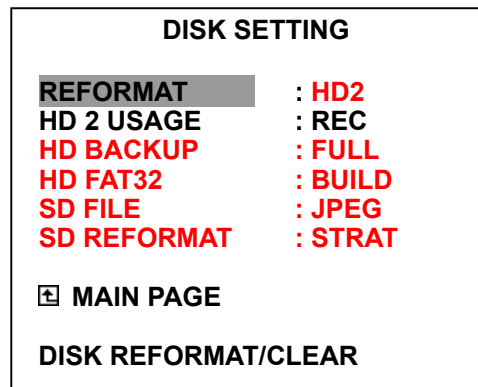
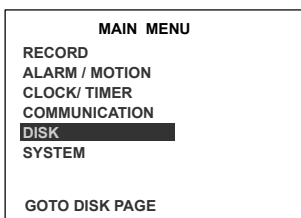

This option allows you to clear out all the data in the hard-disk drive. You will be required to enter the pre-set password before proceeding with clearing out the data. Enter the standard password "9999" if you don't set your individual password. To set your individual password, please refer to section 4.6 System Setting - PASSWORD option.

**HD 1 / 2:** Clears out all the data stored in HD 1 and HD 2.

**BACKUP HD:** Clears out all the data stored in HD 2, which is set to backup purpose only. (This function has to be proceeded with when the HD 2 USAGE option is set to BACKUP.)

**HD2 USAGE:**

This option determines the way to utilize the hard-disk drive in the mobile compartment.

**REC:** Used for the regular recording hard-disk drives.

**BACKUP:** Used for data backup only, which will not be part of regular recording hard-disk drive.

**ALARM MIRROR:** The mirror function serves HD1. As HD1 records alarm data, that data is simultaneously written to HD2.

**HD BACKUP:**

This function allows you to duplicate data from HD 1 to HD 2. Please set HD 2 as BACKUP first. (For operation details, please refer to section 3.5)

**FULL:** Duplicates all the recorded video from HD1 to HD2.

**ALARM:** Duplicates all the alarm-event recorded video from HD 1 to HD2

**SELECT:** Duplicates a particular recorded video from HD1 to HD2.

#### HD FAT32:

This function builds the FAT32 file system a the hard-disk, enabling the data in it to be played back on the PC.

#### SD FILE:

This option determines the format to save the important image files in an SD card.

**JPEG:** Archives images in the JPEG format to save a single picture in every file.

**AVI:** Archives images in the AVI format to save a sequence of images in a file, the maximum limit being 300 images for every file. You can stop recording whenever you want, and if you don't, recording will automatically stop at the optimum of **300** images.

**NOTE:** To save images, please refer to section 3.5.3 for more details.

**SD REFORMAT:** This option allows you to clear out all the data in the SD card.

## 4.6 SYSTEM Setting

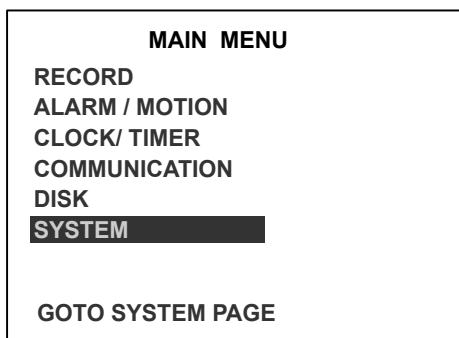

This page is used for accessing the history of the operation status, setting the password, resuming factory default, and determining the menu display background.

## OPERATION LOG:

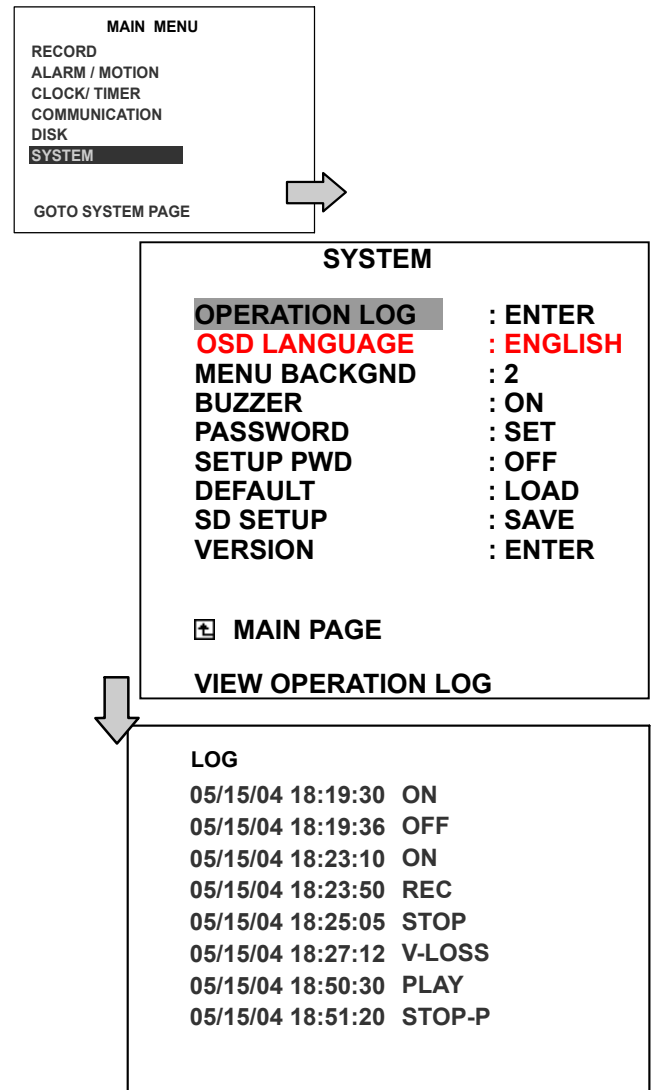

This log shows the history of your operations status, in chronological order. What the following entries represent is detailed below.

**ON:** Powers up the device.

**OFF:** Powers off the device.

**REC:** Starts recording.

**STOP:** Ceases recording.

**STOP-P:** Ceases playback.

**PLAY:** Shows recorded video.

**V-IN:** Video input is connected.

**V-LOSS:** Video loss occurs.

**P-LOSS:** Power interruption occurs.

**A-IN:** Detects an alarm input.

**LOCK:** Disables the entire front panel controls.

**UNLOCK:** Releases the key lock.

**UPDATE:** Updates system software.

**Note:** The log keeps history of the operations statuses on a revolving basis because of a limit of 4000. When the log is full, the newly registered record of an operation will replace the existing records from the oldest one.

**OSD LANGUAGE:**

This option allows you to select the OSD language display as **English** or **Chinese**.

**MENU BACKGND:**

There are **3** levels of background color transparencies you can choose from: level 1 is totally transparent, level 3 is opaque, and level 2 is between levels 1 and 3. The background color is used in the setup menu and the search functions.

**BUZZER:**

This option determines the embedded buzzer will sound a tone to signal the following situations. A tone lasts about two seconds long.

**ON:** Enables buzzer.

**OFF:** Disables buzzer.

---

**Situation**

---

Alarm occurs  
Video loss occurs  
Disk is full  
Load factory default  
Buzzer set to ON  
Enable/disable key lock function  
Power on /off mobile rack HDD  
Backup operation complete  
Timer activate/deactivate  
Recording switching between HDDs

---

**PASSWORD:**

This option allows you to set a password to prevent any unauthorized re-formatting of the hard disk drives or use by the Viewer Software. The standard password is "9999".

**OLD PASSWORD:** Enter the pre-set password (or the standard password if this is the initial setting) to access the password setting system.

**NEW PASSWORD:** Enter a 4-digit-number password of your choosing which will replace the pre-set password (or the standard password "9999").

**SETUP PWD:**

When this option is on, the user must pass the password check before entering the setup menu.

**ON:** Enables pass protection for the setup menu.

**OFF:** Disables pass protection for the setup menu.

**DEFAULT:**

This option allows you to reload the factory default setting. Please do note that the password will not be changed in the factory default setting.

**SD SETUP:**

The DVR offers a quick setup method by using an SD card. If the user wants to set up many of the same devices with the same settings, he can save the whole settings to an SD card, then transfer them to another DVR.

**SAVE:** Saves the whole settings to the SD card.

**LOAD:** Loads the whole setting from the SD card.

**VERSION:**

This item is in the setup menu-revealing the network MAC, the BIOS version, the software version, and the last updated date.

```
MAC : 00 : 0C : 0C : 00 : E1 : A0  
BIOS : 1.00  
SW : 1.00  
DATE : Sep 10 2004
```

# 5. NETWORK

## 5. NETWORK

### 5.1 Network Configuration

#### 5.1.1 Cable Connections

Please follow the instructions below to connect your DVR to a computer or a network and to choose a proper RJ-45 cable configuration for connections.

Physical Spec. of RJ-45 Cable for Ethernet

<b>Wire Type</b>	Cat. 5
<b>Connector Type</b>	RJ-45
<b>Max. Cable Length</b>	30 m
<b>Hub Wiring Configuration</b>	Straight Through
<b>PC Wiring Configuration</b>	Cross Over

#### A. Connect to a PC

Use a crossover LAN cable to connect directly to a **PC**.

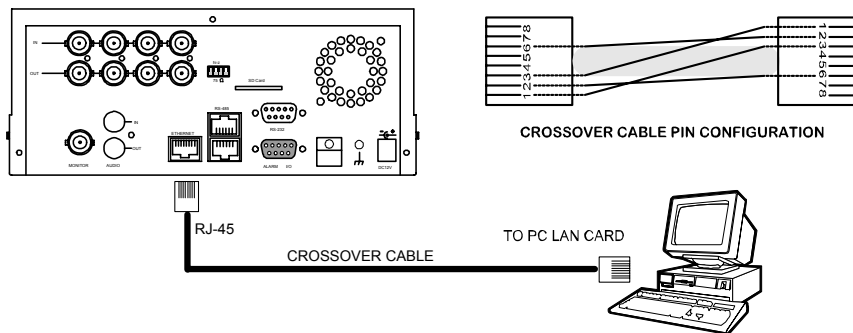

#### B. Connect to a LAN Hub (Intranet)

The RJ-45 PIN configuration for connecting with a LAN Hub is shown below.

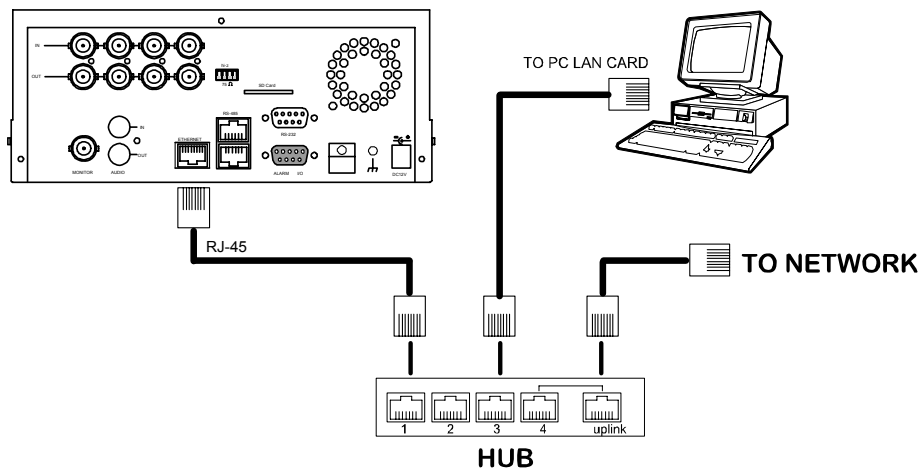

#### C. Connect to WAN (Internet)

The RJ-45 PIN configuration for connecting to a WAN is the same as that for connecting to a LAN.

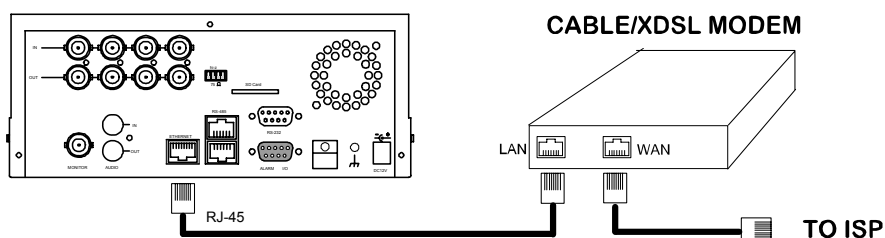

# NETWORK ( continued )

PIN NO.	PIN Assignment
1.	TX +
2.	TX -
3.	RX +
4.	Not Connected
5.	Not Connected
6.	RX -
7.	Not Connected
8.	Not Connected

RJ-45 socket

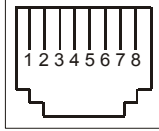

RJ-45 PIN configuration for LAN Hub

## 5.1.2 Configure Your DVR Network Settings

Upon network hardware connection, you need to activate the network function and configure the proper network settings of the DVR.

### 5.1.2.1 Enable DVR Network Function

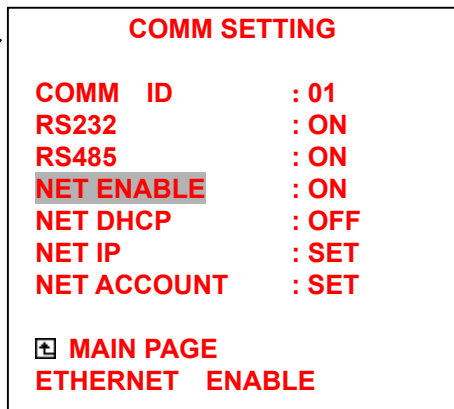
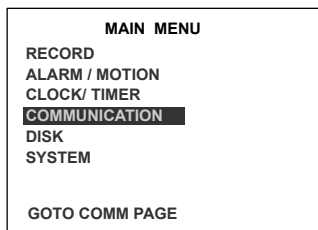

Press the **Setup** button to enter the OSD MAIN MENU. Please use the “<” <sup>(11)</sup> and “>” <sup>(14)</sup> buttons to highlight COMMUNICATION; then press the **Enter** button to enter the COMM SETTING page.

Use the “^” <sup>(12)</sup> and “v” <sup>(13)</sup> buttons to

highlight “NET ENABLE”; select ON. Then press the **Enter** button to proceed.

### 5.1.2.2 Enable DHCP Function

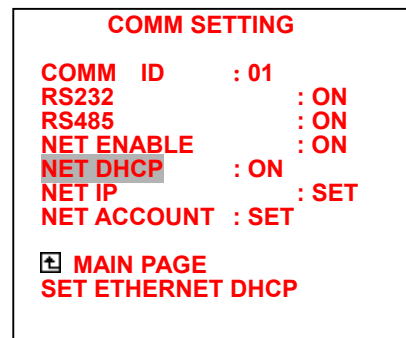
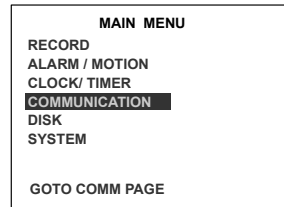

Use the “^” <sup>(12)</sup> and “v” <sup>(13)</sup> buttons to highlight “NET DHCP”; select ON.

**NOTE:** This function can only work if the LAN to, which the unit is connected to has a DHCP server. If the DHCP server is working, the DVR will obtain an IP address automatically from the DHCP server. In that case please skip section 5.1.2.3 (Set IP address) and follow section 5.1.3 (TCP/IP Communication Software).

### 5.1.2.3 Set IP Address

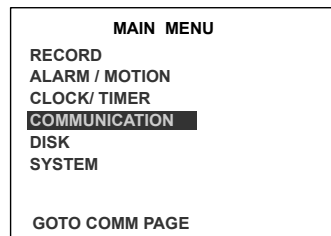



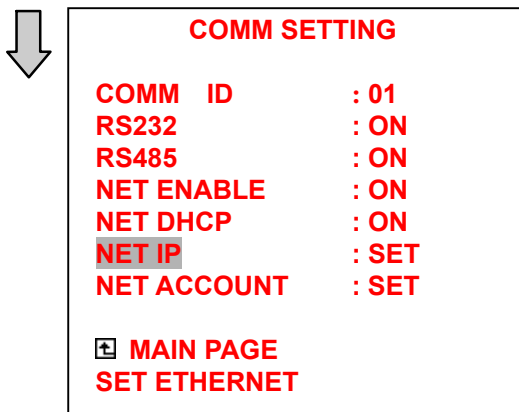

You don't need to set a NET IP for the unit if the LAN, which the unit is connected to, has a **DHCP server**. Otherwise, please follow the instructions given below:

Enter the NET IP page and set the IP, MASK and GATEWAY. Then press the **Enter** button to proceed. The following is a sample setting.

**IP: 192.168.1.100**  
**MASK: 255.255.255.0**  
**GATEWAY: 0.0.0.0**  
**HTTP PORT: 80**

**NOTE:**

1. When only one unit of the DVR is connected to a computer or LAN, you can freely assign an IP address for the DVR. For example, there is a range of DVR IP addresses from 192.168.1.1 to 192.168.1.255. You can pick one for use from the range of the IP. It's not necessary to set MASK and GATEWAY; leave the settings as default.

When a DVR is connected to a WAN, you must acquire a unique, permanent IP address and correctly configure the MASK and GATEWAY settings according to your network architecture. If you have any questions regarding those settings, please contact a qualified MIS professional or your ISP.

2. Connecting to a network, each connected DVR must be assigned a unique IP, which

must be in the same class type as your network address. IP addresses are written as four sets of numbers separated by periods; for example, 192.168.0.1. Therefore, if the connected network is identified as Class C, for example, the first three sets of numbers of the DVR IP address must be the same as the network address. If the connected network is identified as Class B, the first two sets of numbers of the DVR IP address must be the same as the network address. If you have any questions regarding these settings, please contact a qualified MIS professional or your ISP.

### 5.1.3 TCP/IP Communication Setup

Follow the instructions below to install the TCP/IP communication program into your computer.

1. Click the **Start** Menu from your computer, and point to the **Control panel**.



2. Click the **Network Connections** icon twice to enter the Network setting windows.

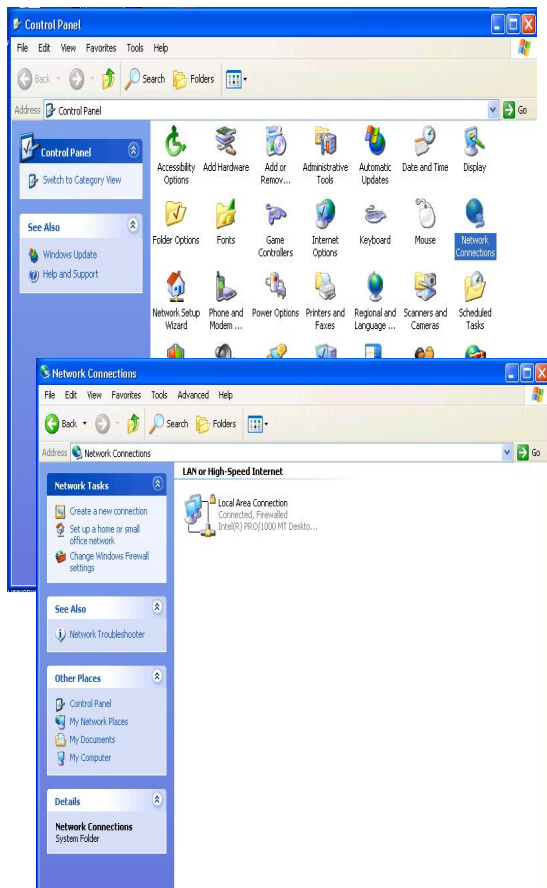

Point to the **Local Area Connection** and click the right bottom of the mouse. Click the **Properties** to enter the **Local Area Connection**.

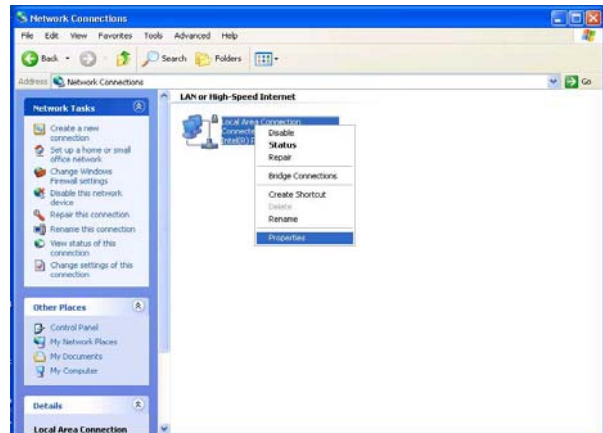

3. Click the **Configuration** tag; check if the TCP/IP is included among the network component list. If the TCP/IP is included, please process step 5. If it is not included, please follow step 4 to install the TCP/IP.

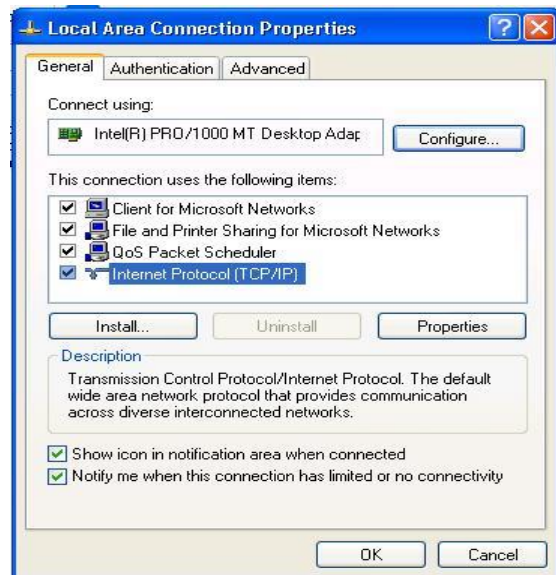

4. TCP/IP installation

During the installation, you will be requested to insert the windows XP CD ROM. After installation, the PC will be restarted.

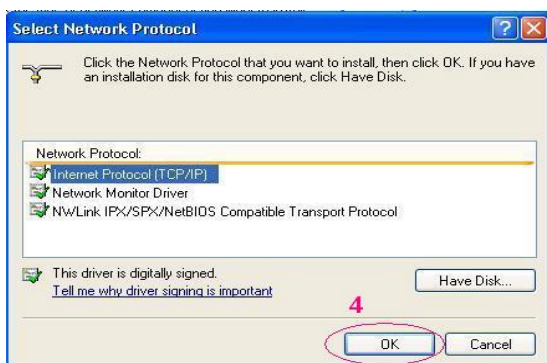
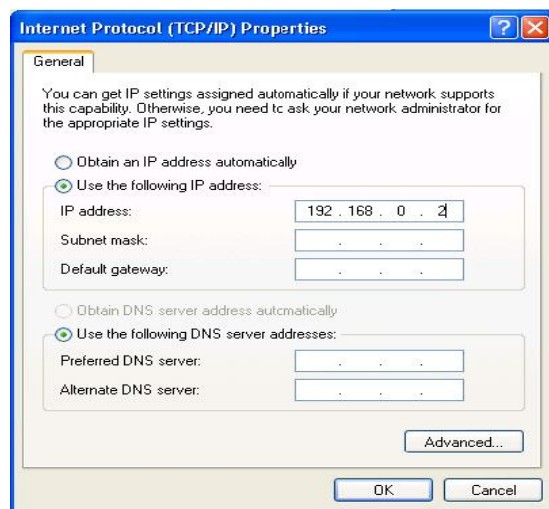
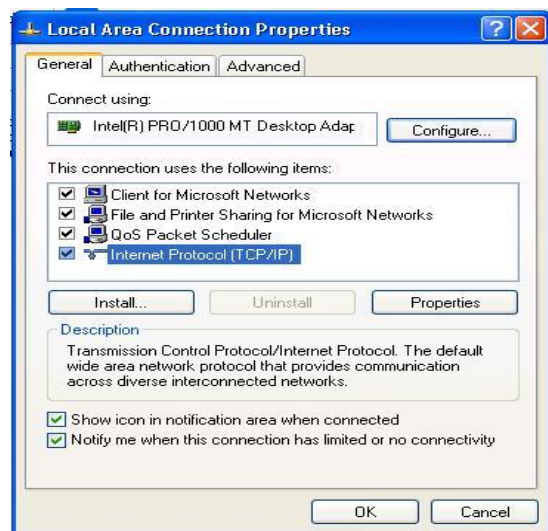
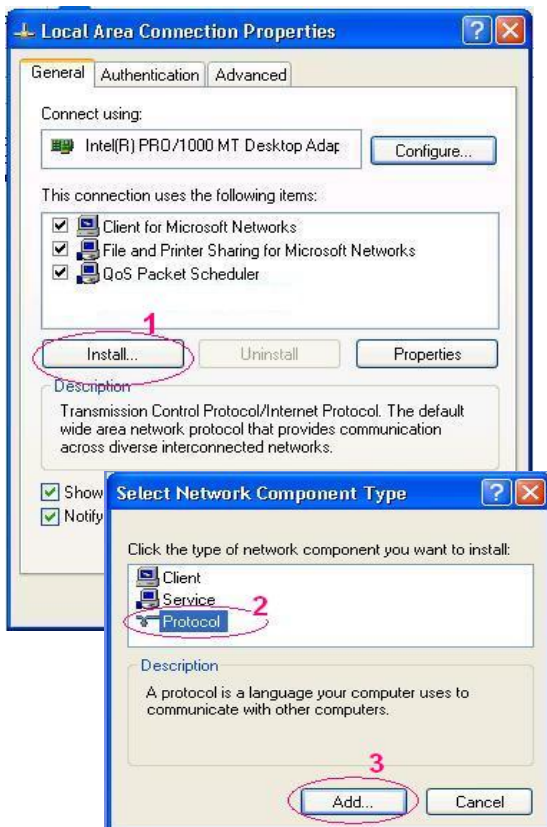

## 5 TCP/IP Configuration setting

Click **Start** **Control Panel**  
**Network.Connections** **Local**  
**Area Connection**

Select **Internet Protocol (TCP/IP)**,  
and then click **Properties**.

Before processing the DVR installation in a WAN, please make sure the Internet connection works properly. If not, please contact your ISP provider.

If you are using a DHCP server, please select Obtain an IP address automatically. Any assigned IP address for the connected DVRs must be in the same class type as the server. If there is no DHCP server, please select specify an IP address and type in the IP address of your PC. This IP address must be different from the DVR IP but in the same class type.

**NOTE: The IP address of a DVR in a network must be unique to itself as opposed to those of the other chosen PCs, but in the same class type.**

## 5.1.4 Connection Testing

With the previous settings, follow the instructions below to ensure whether you have established the connection successfully.

### 1. Click **Start** **Command Programs**



### 2. Type in **ping 192.168.1.1** then Enter. (See the sample screen below)

\*\* This IP is the DVR IP address which is assigned for the connected DVR.

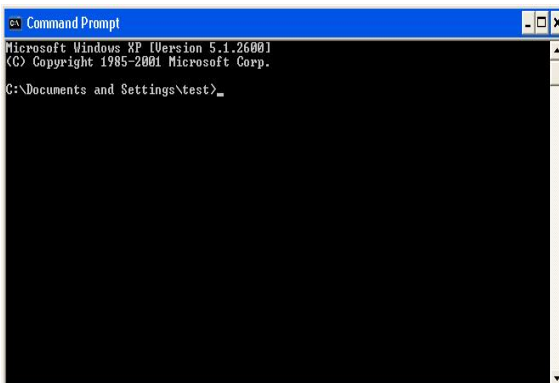

3. If you receive a response as in the sample screen below, the connection hasn't been successfully established. Please re-check all the hardware and software installations by repeating steps 1 to 5. If you still can't establish the connection after rechecking, please contact your dealer.

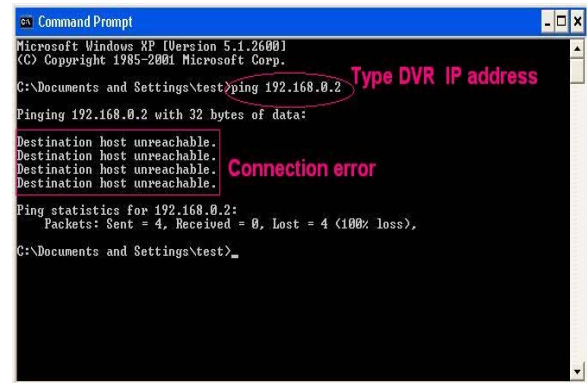

4. If you receive a response as in the sample screen below, you have successfully made the connection.

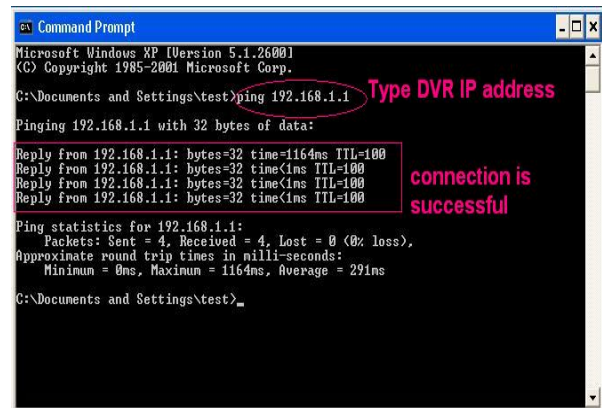

## 5.2 TRIPLEX 4 CH DVR VIEWER SOFTWARE: Introduction

This version of the TRIPLEX 4 CH DVR Viewer Software uses the Microsoft .Net Framework version. The .Net Framework performs the XML Web Services, which applies this operation system. The .Net Framework provides a very high performance environment to solve the network program. Therefore, please use our Viewer Software to connect the TRIPLEX 4 CH DVR. It will satisfy our users as being safer, faster, and more stable and reliable than other software. See below for the chief features of this Viewer Software :

- This software supports the multiple functions of the network.
- It can search as many DVRs as necessary.
- It can support four display modes and help you control your favorite screen sizes.
- It has an extremely powerful search mode to help you search recorded data for the event / time you want.
- It supports your local PC simultaneously with the DVR backup data.

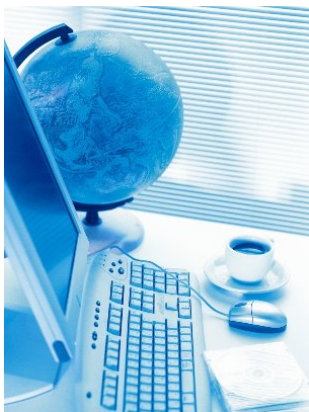

The programs can be operated by a selected PC equipped with the following requirements :

- Intel Pentium III 750MHz (at least).
- 128 MB RAM
- Windows 98, NT, ME, 2000 and XP.
- 4 MB Video card capable of 24-bit true color display.
- 160 MB free hard-disk space for software installation.
- 10-base T network for LAN operation.

### 5.2.1 Software installation

**Step 1 :** Exit all applications currently running in the selected PC.

**Step 2:** Insert the supported PC in the CD - ROM device. The program will execute the installation of the .Net Framework automatically after you click the "**Setup.exe**" file.

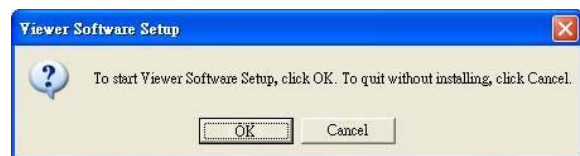

※**Note:** If you choose "**Yes**" in the above window, the installation will be completed automatically. You may need to wait 3 - 5 minutes during the installation.

**Step 3:** After you have completed installing the "**.Net 1.0 Framework Viewer**", you'll automatically enter the "**Viewer Software**" installation screen. Please see the screen below.



※**Note:** Please choose the **"Next"** button to continue.

**Step 4:** The installation screen will show the message **" C:\Program Files\ Viewer Software"**. Or you can select the path you want.



※**Note:** Click **"Next"** to continue the installation.

**Step 5 :** The window below tells you the process is complete.

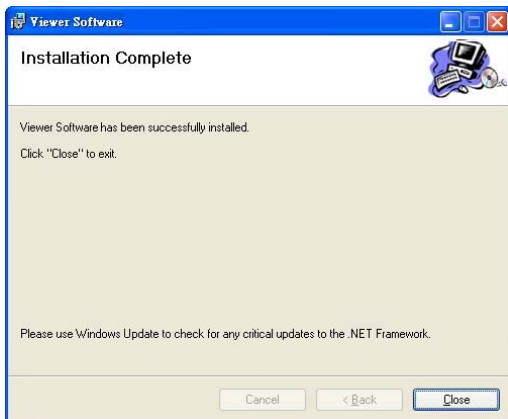

※**Note:** Click the **"Close"** button to complete the installation process.

**Step 6 :** After completing installation, you can double - click the file shown below. Or click the **"Start Menu"** in the computer and select **"Programs"** to open the **"Program Selection"** page. Then click the **"Viewer Software"** tag to start the 4 - channel DVR Viewer Software Program.



## 5.2.2 Short introduction

Now the **"Login"** page appears. Enter the default **"User name : admin"** and the **"Password : 9999"** in their respective entries, and click the **"Login"** button to log into the application.



## 5.2.2.1 Program introduction

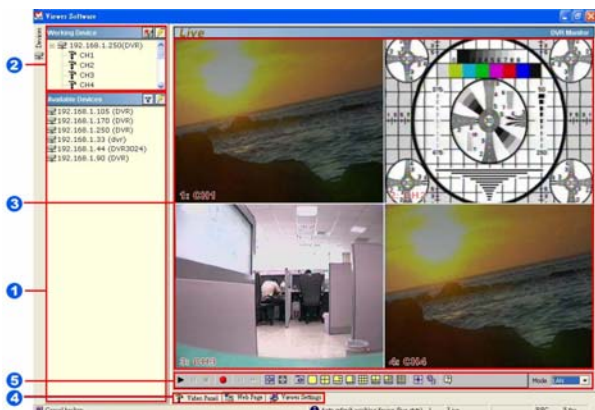

- 1 **【 Available Devices 】** : Here the whole DVR list is shown. You can connect with your selection. Double click any of them to open the screen below. Please enter the correct "Username" and "Password" to log into this DVR. The default "Username" and "Password" are "admin" and "9999" respectively.

**Login DVR :192.168.1.104**

Please type Username and Password fields to login DVR.

Username  Login

Password  Cancel

- 2 **【 Working Device 】** : After you enter the DVR, the section in the upper left margin will show the information in all the cameras.
- 3 **【 Multiscreen 】** : Here all the videos of the cameras will show.
- 4 **【 Multiscreen Buttons 】** : You can interchange between three buttons here : the "Video Panel", "Web Page" and the "Viewer Settings" buttons.

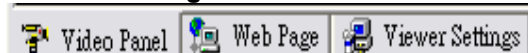



- 5 **【 Function Key 】** : Click each of these buttons to execute its functions.



## 5.2.3 Operation

### 5.2.3.1 Remote Control

✂ **Step 1:** After entering the "Viewer Software", please click the  button to select "4 Channels DVR (Enhanced)" and then click the  "Available Devices" button. The software will automatically

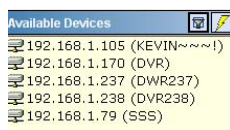

search the whole local LAN 4 - channel DVR device to see a list.

**NOTE:** If you want to create a new DVR connection via the Internet, please press the



button. Enter the DVR's Host name or IP address and its port, then press "OK" to add the DVR connection. (The default of the port is 80.)

**Add New DVR**

Please type DVR IP address

New DVR

IP address :  Port :

Ok Cancel

✂ **Step 2:** Double click your selected device to see a window as on the right. Enter the "Username" and "Password" -- the default name and password are "admin" and "9999".

**Login DVR :192.168.1.104**

Please type Username and Password fields to login DVR.

Username  Login

Password  Cancel

✂ **Step 3:** The default multi-screen is the 4 - channel mode you see now.

✂ **Step 4 :** The Viewer Software helps you see any display mode you want.

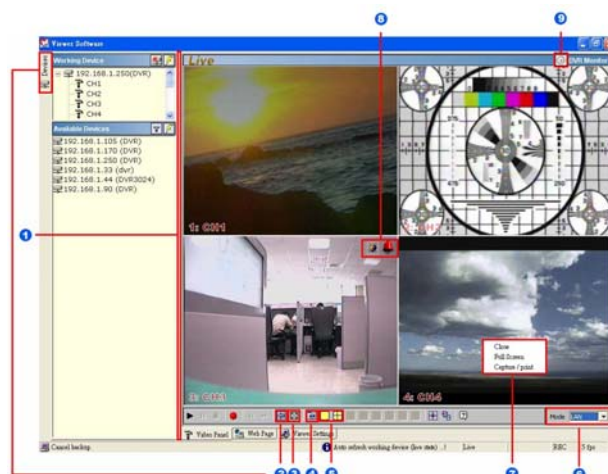

1. **Adjust the screen size:** Move the mouse to the vertical bar on the right side of the "Working Devices" / "Available Devices" box on the left margin of the screen. This bar runs from the top to the bottom of the screen, and when you move the mouse to this bar, it shows like this: . You can move this bar to the left to narrow the "Working Devices" / "Available Devices" box and to the right to widen it.
2. **Hide Device Panel:** Click this button to hide the "Available Devices" / "Working Devices" box from view behind the video display screen.

3. **Full Screen:** Click this button to show the full screen for surveillance. All the setting buttons will be hidden in this mode. If you want to return to the previous mode, use the mouse to click the right key, and choose **"Close"**.
4. **Re-arrange the divisions:** Click this button to see the following channels.
5. **Screen divisions:** Choose any of the buttons you want.
6. **LAN or Internet mode:** Click this button to enter the **"LAN"** and **"Internet"** modes alternately.
7. **Pop-menu:** You can use the mouse to move to each channel. Click the right key of the mouse to show a window. You can select **"Close"**, **"Full Screen"**, or **"Capture / Print"**.
  - ※ **Close:** Stops the channel's display.
  - ※ **Full Screen:** Enlarges the display to **"Full Screen"**.

※ **Capture / Print:**

**"Capture":**

See the **"Image Preview"** page for the **"Preview Setting"** which has two choices : **"Mark Date and Time"** and **"Dimension"**. Mark the item **"Mark Date and Time"** to set the date and time stamp on a chosen picture. Choose an appropriate dimension before saving the image. To save the image, click **"Save"** at the bottom to enter the **"Save Page"** window. Give the file name. If you want to exit, click **"Cancel"**.

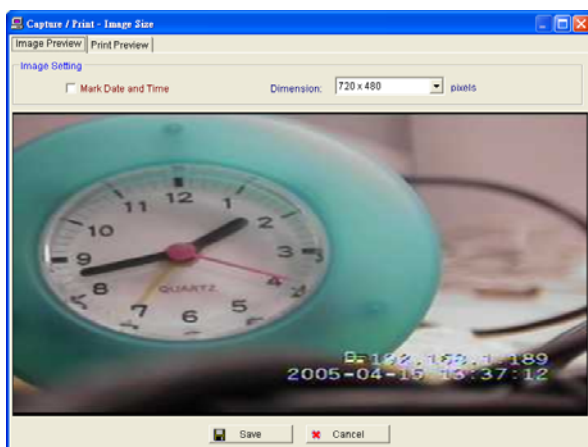

**"Print":** Click the **"Print Preview"** button and go to the **"Preview"** option to adjust the image size. Go to the **"Print Settings"** area and then go to **"Mark Date and Time"** if you wish to stamp the date and time of the image on the image itself. Select **"Dimension"** to scroll the **"Original Image Size"** from the drop - down list. Click **"Print"** to start the printing. Click **"Cancel"** to exit.

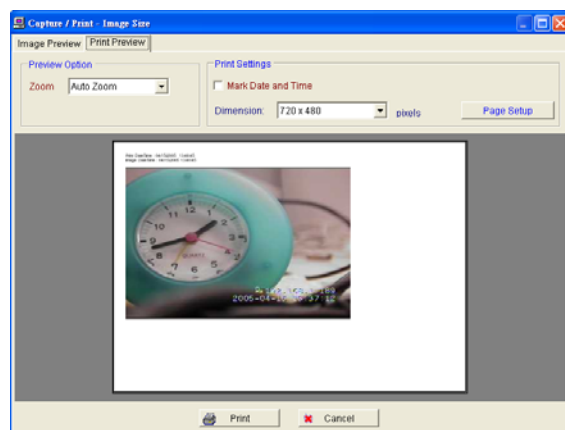

8. **Motion on/ Alarm on:** The warning icons.

 **Motion on icon:** When there is a detection of motion in any channel, it will display this icon on the right upper corner on that channel to warn the user.

 **Alarm on icon:** When there is a detection of external devices such as a sensor, it will display this icon on the right upper corner on that channel to warn the user.

9. **Remind the condition of recording:**

 When the user start to record, it will show this icon on the screen, and it will disappear when stop the recording.

### 5.2.3.2 Remote play and PTZ control.

This device has the full triplex so you can use the Viewer Software in the remote without affecting the performance of the 4 - channel DVR. You can also use the Viewer Software to play and back up. If you have a PTZ camera,



the Viewer Software can also control it.

### 5.2.3.2.1 Remote play

This device has the full triplex so you can use the Viewer Software in the remote without affecting the performance of the 4 - channel DVR. You can also use the Viewer Software to play and back up. If you have a PTZ camera, the Viewer Software can also control it.



**▶ "Play"**: Click it to see the DVR play window. Use the **"Previous page"** and **"Next page"** buttons to find the record you want from the record list. Click the **"Time Search"** page to use the time and date search entries to help your search.

**⏸ "Pause"**: Click to freeze the image.

**■ "Stop"**: Click to stop playing back the recorded video.

**● "REC"**: Click to control the recording of the DVR. Press the button to start or stop the recording.

**⏮ "REV"**: Click to play a recorded video in the reverse direction at speeds, which are faster than the recorded speed.

**⏭ "FWD"**: Click to play a recorded video in the forward direction at speeds, which are faster than the recorded speed.

### 5.2.3.2.2 Change Pan/Tilt/Zoom Setting

Click the  button on the home page to open the Speed Dome Controller.

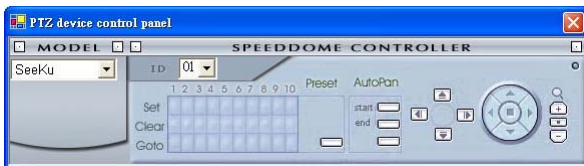

1. Click the  button to control the Zoom setting on the Speed Dome Controller.



2. The right-hand set, , has four buttons, each of which, upon being clicked,

will turn the camera all the way, without stopping, in one of the four designated directions. The fifth button, in the center, will stop the camera at any point you prefer.



The left-hand set of buttons, , has four buttons, each of which, upon being clicked, will move one short step only in any of the four designated directions.

3. Select a Speed Dome device Model



from the drop-down list on the Speed Dome Controller. The Controller will be able to display the listed Models by turn.

4. Select a Speed Dome device ID

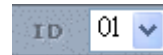

from the drop-down list on the Speed Dome Controller. The Controller will be able to display the listed IDs by turn.

5.



Each of the ten buttons under 'Set' is connected with a specific position and angle of either panning or tilting of the camera. Click each button to activate its particular position and angle. Press the button under 'Preset' to turn the camera angle by angle in the set positions.

Each of the ten buttons under 'Clear' can be clicked to delete the corresponding 'Set' button above it. For example, if you wish to de-activate 'Set' button #4, please click 'Clear' button #4 to delete its corresponding 'Set' counterpart.

Each of the ten buttons designated 'Go to' can be clicked to view the particular corresponding angle of the position in which

it is set.

6.



The 'AutoPan' section has three buttons. The 'Start' and 'End' buttons fix the two points of any panning movement you select. The third or bottom button sets the chosen movement in the play mode.

### 5.2.3.3 Backup and video edit

Use the  button to see the "Backup" window.

#### 【Backup up to AVI】:

##### Backup Settings :

- **File Path** : To set the backup file path and the file name, click the "Browser" button on the right.
- **Frame Rate** : Sets the backup record file speed.
- **Maximum File Size** : Sets the maximum file size.
- **Frame dimension** : Sets the resolution.
- **Mark Day and Time** : Sets the date and time stamp.

##### Play Options :

- **Time to play**: To search the date and time you want.
- **Channel ID**: To choose the camera.

##### Play Monitor :

- Use the panel below to play or stop, etc.



- If you already want to back up, click the "Start backup" button. If you want to

stop, click the "Stop backup" button.

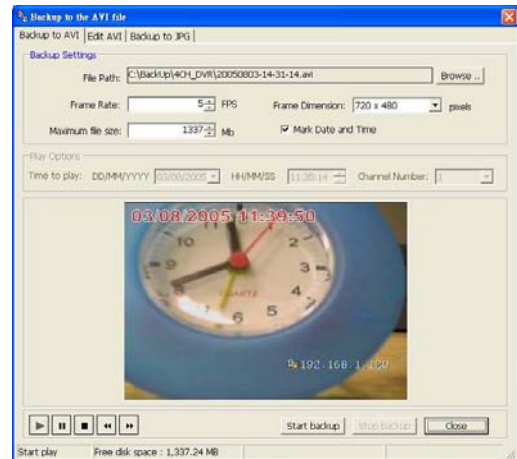

#### 【Edit AVI】:

- **File Path**: To set the backup file and the file name, check the "Browser" button on the right. Click "Edit Selected File" to start editing.
- **Frame Rate Modification**: To see the total number of frames, modify your frame rate.
- **File Preview**: Click the "Start" button to start your setting component. You can also use the "Start" button to interrupt the code. You can click the "Save to new file" button to save a new file after the edit code.

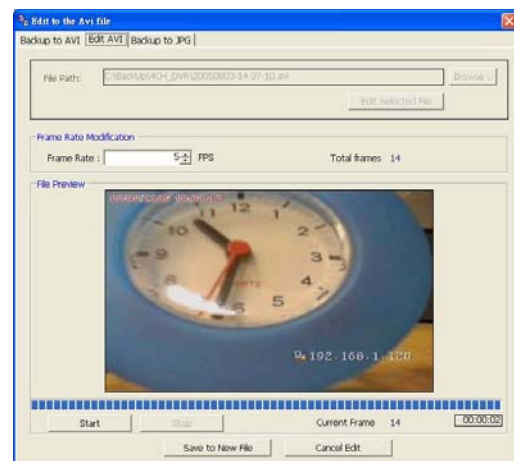

#### 【Backup to JPG】:

- **Folder Path**: To set the backup file path, click the "Browser" button on the right.
- **Maximum Frames**: Sets the maximum amount of the frames which to backup.

- **Frame Dimension** : Sets the resolution.
- **Mark Day and Time** : Sets the date and time stamp.

**Play Options :**

- **Time to play:** To search the date and time you want.
- **Channel Number:** To choose the camera.

**Play Monitor :**

- Use the panel below to play or stop, etc.



If you already want to back up, click the **"Start backup"** button. If you want to stop, click the **"Stop backup"** button.

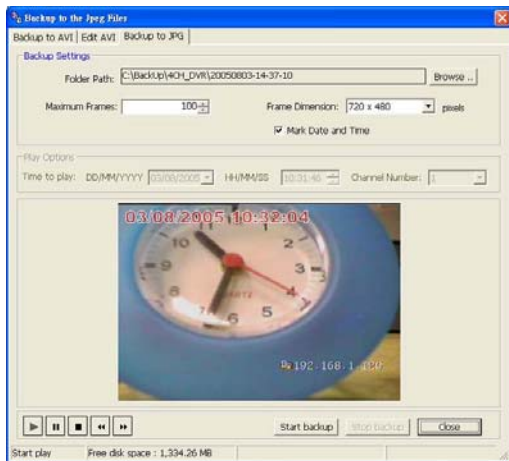

**5.2.3.4 Web Page Viewer**

This device also provides the IE Browser function. Open the browser and view the images directly via the browser. Please refer to section 5.3 for more details.

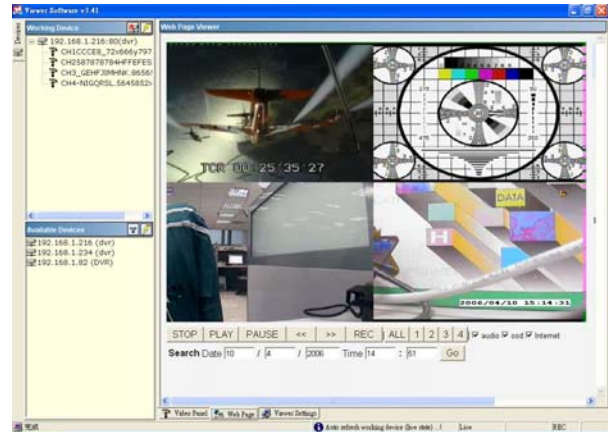

### 5.2.3.5 Viewer setting

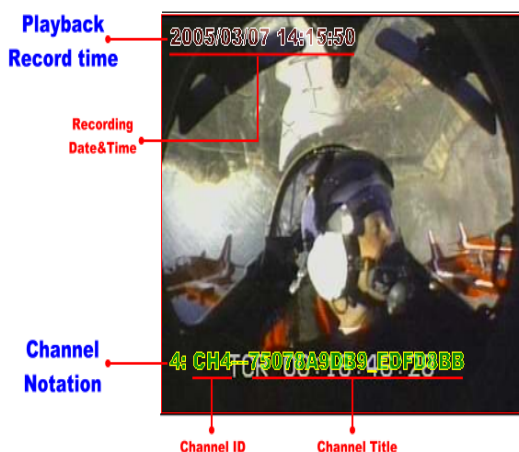
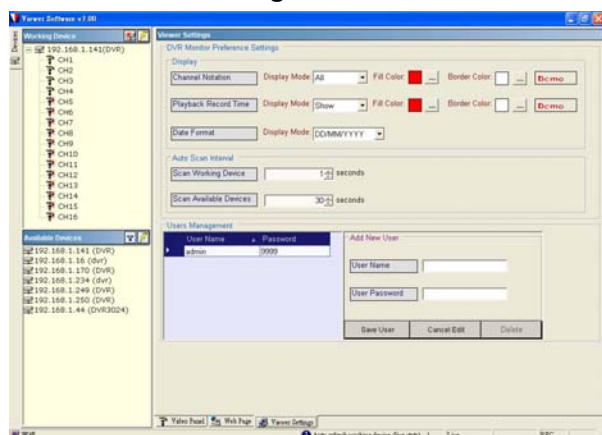

#### 1. "Channel Notation".

If you wish to change the "Display Mode", open its drop - down list and select any of the four items there. Your choice will automatically appear in the relevant blank space. Similarly you can enter the "Fill Color" and "Border Color" entries to open their respective color tables. Click "OK" in each case to set your choice.

#### 2. "Playback Record Time".

Click the "Display Mode" to select from a drop - down list of two choices, "Hide" and "Show". Your choice will decide whether the images will display their date and time or not.

#### 3. "Auto Scan Interval".

Here you have two entries, "Scan Working Devices" and "Scan Available Devices". Set the time in seconds for both entries as per your requirements. The "Scan Working Devices" entry has a time span of 1 to 5 seconds only. The "Scan Available Devices" time range covers 30 to 1000 seconds.

#### 4. "Users Management".

Click the "Save User" button to add the new user's name and password under "Add New User": Enter the "User Name" and "Password" and click "Save User" again. Your new user and his password will appear on the "User Name & Password" list to the left. If you proceed to enter a new user and then click "Cancel Edit", no new name will be added to your list. If you wish to delete any user, click his name and click "Delete" to effect the change.

## 5.3 Microsoft Internet Explorer

This section provides instructions for using the Microsoft Internet Explorer.

### 5.3.1 Connecting the DVR

Start up the Microsoft Internet Explorer, and then follow the steps given below to connect the DVR:

1. Type in the URL address of the DVR into the URL block and press the "Enter" button to enter the login page. The default user name and password are **admin** and **9999** respectively.
2. Enter the **User name** and **Password**.
3. Click the "Login" button and enter the home page of the DVR: both the user name and password must be provided correctly.

## Browsing images from the DVR

The images from the DVR will be displayed on the home page while going online with the DVR. There are some buttons provided at the bottom of the home page for further setting.

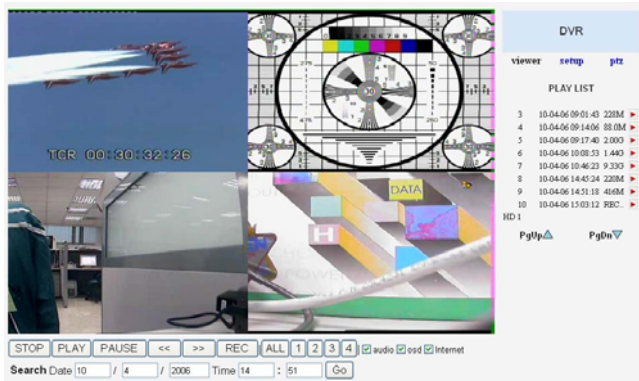

Function Buttons	Description
	Click to stop playing back the recorded video or to cease recording.
	Click to a recorded video from the PLAY LIST.
	Click to freeze the image.
	Click to play a recorded video in the forward direction at speeds which are faster than the recorded speed.
	Click to play a recorded video in the reverse direction at speeds which are faster than the recorded speed.
	Click to activate or stop the recording function of the device.
	Press to enter the SETUP window, and open the device setting page in order to add more devices for viewing. This allows you to program the Record Setting and Record Schedule.
	Press to enter the IMAGE window and open the device home page for viewing.
	Click to open the control panel and remote control the pan/tilt/zoom function camera live over a local area network or the Internet

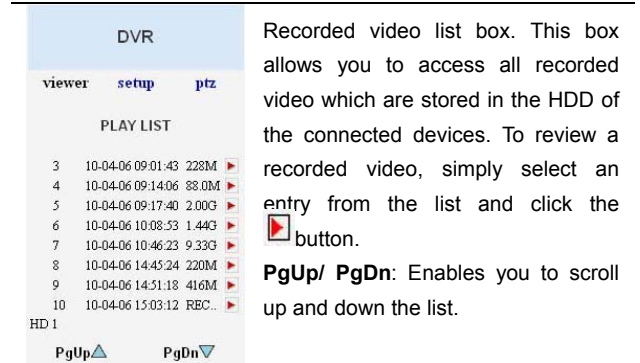

Recorded video list box. This box allows you to access all recorded video which are stored in the HDD of the connected devices. To review a recorded video, simply select an entry from the list and click the button.

**PgUp/ PgDn:** Enables you to scroll up and down the list.

**2006/01/17** 4CH DVR Time Box. This box indicates the selected device status.

This allows you to search a recorded video stored in the D of the device. Enter the YEAR/ MONTH/DAY HOUR: MINUTE you wish to search and click the GO button to proceed.

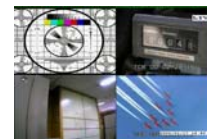

Image display area: Displays images from the 4ch cameras.

## 5.3.2 Change Record / Alarm Setting

Please follow the steps given below to change the Record / Alarm setting through the network as and when necessary.

1. Click the button on the home page to enter the Record / Alarm setting page.



2. Adjust the Record / Alarm setting, including "REC rate", "REC quality", "ALARM REC enable", "ALARM REC rate", and "ALARM REC quality" as and when necessary.

3. Click the **Send** button to submit the new Record / Alarm setting.
4. Click the **ptz** button to return to the home page while the new image setting acts on the images to effect the desired changes instantly. (If the setting has not been changed by the above steps, any (re)entry to the home page will find images in their earlier or original setting. )

### 5.3.3 Change Timer Record Setting

1. Click the **setup** button on the home page to enter the Record / Alarm setting page.
2. Click the **•Timer Record** connection on the Record / Alarm setting page to enter the Timer Record setting page.

Timer Enable: ON

DVR

viewer setup ptz

	Start		End		Start		End	
Sunday	0	00	0	00	0	00	0	00
Monday	0	00	0	00	0	00	0	00
Tuesday	0	00	0	00	0	00	0	00
Wednesday	0	00	0	00	0	00	0	00
Thursday	0	00	0	00	0	00	0	00
Friday	14	30	14	40	0	00	0	00
Saturday	0	00	0	00	0	00	0	00

•Record/Alarm  
•Timer Record

Send Clear

3. Set the **TIMER RECORD** to **ON** to enable the TIMER RECORD function.
4. There are two time-periods available for scheduling each day. The Timer Record setting page allows users to program the time each day that the DVR will start and stop recording. The time is displayed in a 24-hour clock format. If there is a time overlap showing between two continual time-period settings, the device will automatically combine the two time-period settings into one combined time-period setting.
5. Click the **Send** button to submit the new Timer Record setting.
6. Click the **viewer** button to return to the home page while the new image setting acts on the images to effect the desired changes instantly. (If the setting has not been changed by the above steps, any (re)entry onto the home page will find images in their earlier or original setting. )

# 6. MISCELLANEOUS

## 6. MISCELLANEOUS

### 6.1 RS-232 & RS-485 Setup & Protocol

#### 6.1.1 RS232 & RS485 Setup

Use a Null Modem cable (the standard RS-232 9 Pin Cable with Pin 2 and Pin 3 exchanged, see pin configuration chart below for details) to connect the COM 1 on the rear panel of the DVR to a PC.

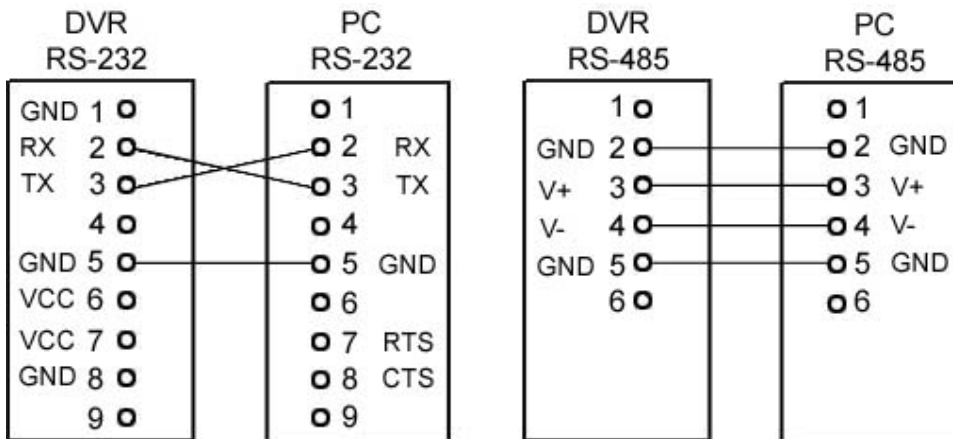

Set the **RS-232** option to **ON** in the **COMMUNICATION** page of the setup menu.

Set the PC communication parameters: 9600 bps, No Parity, 8 Data Bits, 1 Stop Bit.

#### 6.1.2 Communication Protocol

##### 6.1.2.0 General Command Format

<Lead Code = 0x41>, < Dest ID >, < Src ID >, <Main category >, <Second category >, {<Number of parameters>, <Parameter 1>, <Parameter 2> ...} <End Code= 0x4f>

Lead Code = 0x41  
Dest ID = 0x01  
Src ID = 0x20  
Main Category = 0x01 Keys and Signals  
= 0x02 Command  
Second Category = 0x01 Handshake  
= 0x02 Request Time/Set Time  
= 0x06 Request System State  
= 0x0b Time Search  
= 0x10 Request HDD Info  
= 0x11 Request REC Position  
= 0x12 Playback Immediately  
End Code= 0x4f

**The different command types and their corresponding parameters are as follows:**

# MISCELLANEOUS ( continued )

## 6.1.2.1 Keys and signals ( Main Category = 0x01 )

PC Send: <0x41>, <0x01>, <0x20>, <0x01>, <Key Value>, <0x4f>

< The value of a specific front panel key >

	DEC	HEX	
KEY_PLAY	1	0x01	
KEY_STOP	3	0x 03	
KEY_PAUSE	4	0x 04	
KEY_REC	6	0x 06	
KEY_SETUP	7	0x 07	
KEY_ENTER	8	0x 08	
KEY_SEARCH	10	0x 0A	
KEY_DISPLAY	11	0x 0B	
KEY_UP	13	0x 0D	
KEY_DOWN	14	0x 0E	
KEY_LEFT	15	0x 0F	
KEY_RIGHT	16	0x 10	
KEY_MONITOR	36	0x 24	
JOG_L	128	0x 80	
JOG_R	129	0x 81	
KEY_SHUTTLE_L8	130	0x 82	( -100x, -1/16x )
KEY_SHUTTLE_L7	131	0x 83	( -100x, -1/16x )
KEY_SHUTTLE_L6	132	0x 84	( -30x, -1/8x )
KEY_SHUTTLE_L5	133	0x 85	( -16x, -1/8x )
KEY_SHUTTLE_L4	134	0x 86	( -8x, -1/4x )
KEY_SHUTTLE_L3	135	0x 87	( -4x, -1/4x )
KEY_SHUTTLE_L2	136	0x 88	( -2x, -1/2x )
KEY_SHUTTLE_L1	137	0x 89	( -1x, -1/2x )
KEY_SHUTTLE_CT	138	0x 8A	
KEY_SHUTTLE_R1	139	0x 8B	( 2x, 1/2x )
KEY_SHUTTLE_R2	140	0x 8C	( 4x, 1/2x )
KEY_SHUTTLE_R3	141	0x 8D	( 8x, 1/4x )
KEY_SHUTTLE_R4	142	0x 8E	( 16x, 1/4x )
KEY_SHUTTLE_R5	143	0x 8F	( 30x, 1/8x )
KEY_SHUTTLE_R6	144	0x 90	( 100x, 1/8x )
KEY_SHUTTLE_R7	145	0x 91	( 100x, 1/16x )
SIGNAL_REC_IN	163	0x A3	
SIGNAL_ALARM_RESET	165	0x A5	
SIGNAL_REC_OUT	169	0x A9	
SIGNAL_ALARM_IN	189	0x BD	
SIGNAL_ALARM_OUT	209	0x D1	

## 6.1.2.2 COMMAND (Main Category=0x02)

### A. Handshake (Second Category=0x01)

PC request: <0x41>, <0x01>, <0x20>, <0x02>, <0x01>, <0x00>, <0x4f>

DVR response: <0x41>, <0x20>, <0x01>, <0x02>, <0x08>, <0x00>, <0x4f>

### B. Request Time (Second Category=0x02)

PC request: <0x41>, <0x01>, <0x20>, <0x02>, <0x02>, <0x00>, <0x4f>

DVR response: <0x41>, <0x20>, <0x01>, <0x02>, <0x02>, <0x07>, <7 Time Value >, <0x4f>

The following case is an illustration of < 7 Time Value >

2004/06/20 17:05:00 = <0xD4>, <0x07>, <0x06>, <0x14>, <0x11>, <0x05>, <0x00>

### C. Set Time (Second Category=0x02)

PC request: <0x41>, <0x01>, <0x20>, <0x02>, <0x02>, <0x07>, < 7 Time Value >, <0x4f>

The following case is an illustration of < 7 Time Value >



2004/06/20 17:05:00 = <0xD4>, <0x07>, <0x06>, <0x14>, <0x11>, <0x05>, <0x00>  
DVR Act: Changing the time and date.

#### D. Request State (Second Category=0x06)

PC Request: <0x41>, <0x01>, <0x20>, <0x02>, <0x06>, <0x00>, <0x4f>  
DVR Response: <0x41>, <0x20>, <0x01>, <0x02>, <0x06>, <0x01>, <System  
State = 0..>, <0x4f>

##### Description of <System State>:

STATE_STOP	0
STATE_PLAY	3
STATE_SETUP	6
STATE_SEARCH	7
STATE_BACKUP	15

#### E. Time Search (Second Category=0x0b)

PC message: <0x41>, <0x01>, <0x20>, <0x02>, <0x0b>, <0x06>, <6 Bytes Date/Time>, <0x4f> where < 6 bytes Date/Time >, = year (2 bytes, =LowByte + HighByte\*256), month (1 byte), day (1 byte), hour (1 byte), min (1 byte)

Example: to search 06/12/2004 17:00 the Date/Time = <0xd4>, <0x07>, <0x06>, <0x0c>, <0x11>, <0x00> where 2004= 212(=0xd4) + 7(=0x07) \*256

#### F. Request HDD Info (Second Category=0x10)

PC message: <0x41>, <0x01>, <0x20>, <0x02>, <0x10>, <0x00>, <0x4f>  
DVR Response: <0x41>, <0x20>, <0x01>, <0x02>, <0x10>, <0x32>, <0x00>, <0x00>, <48 Bytes Data> <0x4f>  
<48 Bytes Data>=4 HDD Status( Primary Master/Slave, Secondary Master/Slave )  
Every HDD uses 12 Bytes=

#0 :HDD Exists ( if = 1 )  
#1 :Active HDD ( if = 1 )  
#2 :Current HDD for REC ( if = 1 )  
#3 :Current HDD for PLAY ( if = 1 )  
#4..#7 :Capacity  
#8.. #11 :REC/PLAY Position

#### G. Request REC Position (Second Category=0x11)

PC message: <0x41>, <0x01>, <0x20>, <0x02>, <0x11>, <0x00>, <0x4f>

##### REC Mode

DVR Response: <0x41>, <0x20>, <0x01>, <0x02>, <0x11>, <0x08>, <HDD#>, <0x0>, <4 Bytes REC Position>, <2 Bytes Image NO.>, <0x4f>

Get HDD#, REC Position and Image NO. used in **Playback Immediately** command

##### Non REC Mode

DVR Response ERROR: <0x41>, <0x20>, <0x01>, <0x02>, <0x11>, <0x01>, <0x45>, <0x4f>

#### H. Playback Immediately (Second Category=0x12)

PC message: <0x41>, <0x01>, <0x20>, <0x02>, <0x12>, <0x0a>, <HDD#>, <0x0>, <0x0>, <0x0>, <4 Bytes REC Position>, <2 Bytes Image NO.>, <0x4f>

##### On Success

DVR Response: <0x41>, <0x20>, <0x01>, <0x02>, <0x12>, <0x00>, <0x4f>

##### On Error

DVR Response ERROR: <0x41>, <0x20>, <0x01>, <0x02>, <0x12>, <0x01>, <0x45>, <0x4f>

## 6.2 Hard Disk Installation

Usually, the unit comes with one hard-disk drive installed in compartment HD 1, which is default-configured as a master. The jumper settings configuration of the installed hard-disk drives for the unit and compatible drives which can be used with this unit are listed in the table below. To install two hard disk drives in the compartments for HD 1 and HD 2, please take the following steps.

**The jumper settings of hard-disk drives for the system**

	Location	Jumper
IDE 1	Compartment HD 1	Master
IDE 2	Compartment HD 2	Master

### 6.2.1 Built-in hard disk

1.



Unscrew all the 4 mounting screws on the mobile rack of the unit and detach it.

2.



Carefully lift the mobile rack to a vertical position.

3.

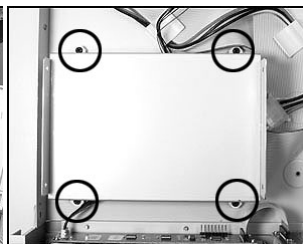

Unscrew the secured screws to detach the hard disk rack.

4.



Setting the jumper of your hard disk driver. The way to set the jumper of the drive varies between manufacturers; please refer to the instructions on the driver to set the jumpers in the **master** position.

5.



Place the hard disk in the rack.

6.

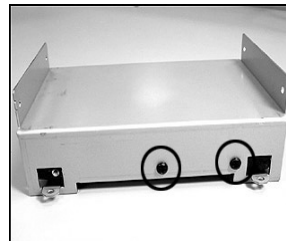

Secure the driver in the rack using 4 mounting screws in the side-mounting holes. Please don't tighten the screws too much, otherwise that may damage the driver.

7.

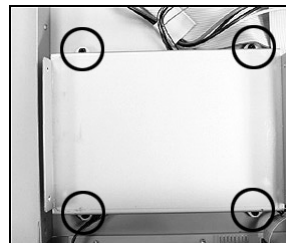

Screw the rack into the device, screwing in all the 4 screws.

8.

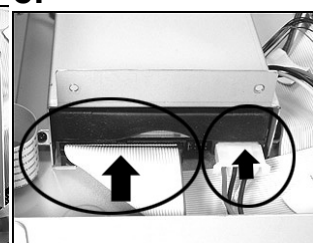

Attach the interface connector and the power connector to the drive. Please note the red lining of the IDE cable and the red wire of power cable must line up side by side.

---

**9.**

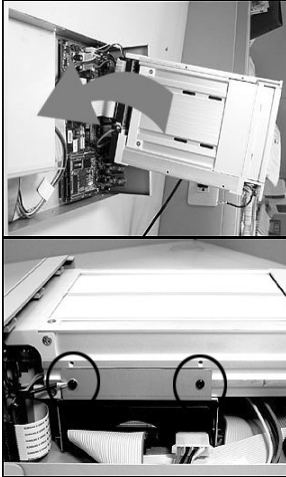

Place the mobile rack back onto the device and screwing in all the **4** screws.

---

### **6.2.2 Mobile Rack (FOR REMOVABLE HDD MODEL)**

1.



Make sure that the key is unlocked.

2.

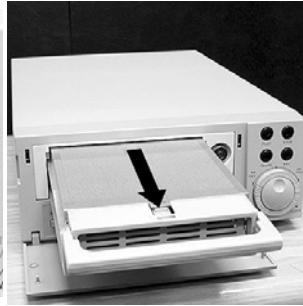

Pull the active-handle outward to detach the carrier body from the mobile rack.

7.

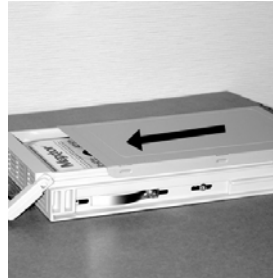

Place the top cover back to the carrier body by sliding forward to secure.

8.

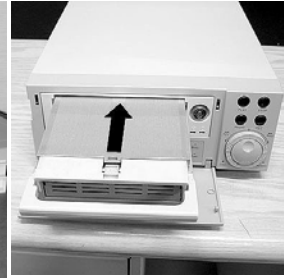

Slide the carrier body back in the mobile rack.

3.



Slide the top cover backward and remove.

4.



Setting the jumper of your hard disk driver. The way to set the jumper of the drive varies between manufacturers; please refer to the instructions on the driver to set the jumpers in the master position.

9.



Push the carrier body further into the mobile rack until fully inserted.

10.



Push the active-handle inward.

5.

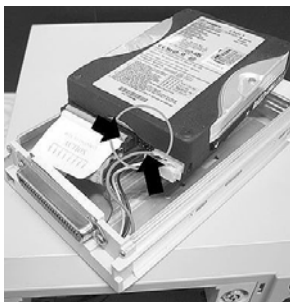

Attach the interface connector and the power connector to the drive. Please note the red lining of the IDE cable and the red wire of power cable must line up side by side.

6.

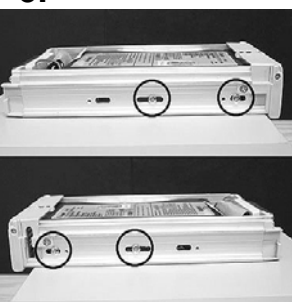

Place the HDD inside mobile rack. Use four of the provided screws.

11.



Lock the Key.

## 6.3 O.S.D Message

No.	O.S.D Message	Meanings
1	NO DISK	No hard-disk detected after power activated
2	BATTERY LOW	Suggest change the battery and reset the system time
3	LOADING	System Boot up
4	VIDEO LOSS	Video loss
5	VIDEO IN	Video input source
6	KEY LOCKED	Key lock function is on
7	KEY UNLOCKED	Key lock function is off
8	n1 OF n2 ITEMS PROGRESS n3 %	BACKUP n1/n2 NOW
9	BACKUP COMPLETE	Backup complete
10	HD2 SPACE NOT ENOUGH	HD2 has not enough space for backup
11	NO ENTRY FOR BACKUP	No backup is possible.
12	BACKUP INCOMPLETE	Backup incomplete, since the user has pressed the STOP button to stop it
13	NOT FOUND	The system cannot find a video in the Search function.
14	END	Playback of recorded video has reached the end point
15	DISK FULL	Hard-disks are full; this happens only when the DISK FULL item in the setup menu is set to STOP.
16	EMPTY	The user presses the PLAY button or uses the SEARCH function, but no video can be played.
17	SET TO NTSC, PLS RESTART	System has to be set to NTSC, please reboot (PAL is similar)
18	SOFTWARE UPDATE	Software update
19	PLEASE RESTART	The system should be rebooted after the software has been updated
20	NO DISK	The user has pressed the Save key without putting in an SD card, or there is a disk error.
21	DATA NOT CONTINUOUS	The system finds data in installed HDs cannot be used contiguously. Suggest you remove HD2 from the system.
22	DISK ATTACHED	HD2 has been attached.
23	DISK REMOVED	HD2 has been removed.
24	FAN STOPPED	The chassis fan has stopped for over 30 seconds.
25	HDn ERROR AT xxxxx	There has been a hard-disk error during recording, where n is the hard-disk number and xxxxx is the hexadecimal location.
26	NOT PRESENT	When the user tries to clear a disk that was not attached in the setup menu.
27	SAVE TO DISK	Start saving to the JPEG file.
28	SAVE TO Fnnn. JPG	Save to Fnnn. JPG (where nnn= 0..999)
29	SAVE OK	Saving to the JPEG is ok.
30	SD CARD WRITE PROTECTION	An SD card is write-protected; or, there is an error

## 6.4 Time Index Table

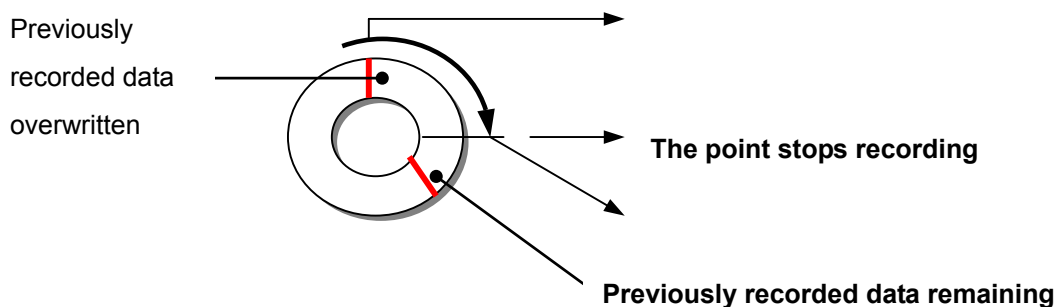
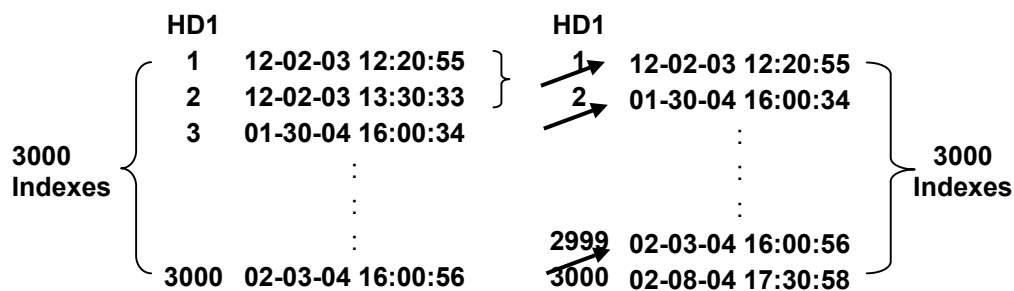

The DVR will generate a **Time Index Table** indicating recorded data is kept in a particular HDD. This allows the user to individually selecting recorded data to be displayed via the alarm list search and full list search. The maximum number of lists for a given HDD is **3000**. When the list of any given HDD is used up and the disk is not full, the unit will still use the rest of the space for recording. In such a case, an index for the recent recorded data will be generated and the index of the next oldest data will be erased so that the list does remain 3000 in total. And the next oldest data will be kept in the index of the corresponding oldest

data. For any newly-recorded data, this approach will be applied until the disk becomes full.

In the rewrite recording mode, when the archived hard disk drive is full, the DVR will start overwriting the oldest data recorded. As the previous recorded data is being overwritten by the recent recording, the indicating time index of that data will be changed corresponding to the starting time of the remaining session. The index of the session will be deleted from the table when it is fully overwritten.

## 6.5 Specifications

Model Number	DVR-3024M	DVR-3024MD
Image System	NTSC/PAL	
Resolution	NTSC: 720 x 480 pixels / PAL: 720 x 576 pixels	
Operation	Triplex(Recording、Playing and Viewing)	
Video In	Composite Video In (BNC) x 4	
Video Out	Composite Video Out (BNC) x 4, Monitor Out (BNC) x 1	
Audio In/Out	Line in / out (RCAx2), 8kHz	
Storage Media	> 600 GB / 1 Fixed HDD, 1 Removable HDD	> 300 GB / 1 Fixed HDD
Compression	MPEG4	
Memory Card	SD Card	
Archive	Hot Swappable Removable HD/ SD Card	CD-RW / SD Card
Watermark	Digital Signature	
Recording Rate	NTSC: 120 IPS total (30 IPS per channel for NTSC); PAL: 100 IPS total (25 IPS per channel for PAL)	
Image Size	Best (5.0 Mbps) / High (4.0Mbps) / Standard (3.0 Mbps) / Basic (2.0 Mbps)	
Recording Mode	Schedule / Manual / Alarm / Circular	
Alarm Recording	Event / Pre-Alarm / Post-Alarm	
Pre-Alarm Recording	6 sec	
Playback Speeds	Frame Stepping (Forward only), Slow: 1/16 X, 1/8 X, 1/4 X, 1/2 X (Forward only), Fast: 1X, 2X, 4X, 8X, 16X, 30X, 100X	
Record Search	Alarm / Time / Event list / Filter(thumbnail) / SD card	
OSD Language	English / Chinese(T)	
Set-up Menu	Multi-layer / Network setting	
Log list	2000 records	
Alarm In/Out	4 Alarm Inputs / 1 Alarm Output	
Built-in Buzzer	Yes	
Motion Detection	Yes	
Communication Port	RS-232, RS-485, and Ethernet Port	
Network Interface	Ethernet (RJ-45 10/100 base-Tx) x 1	
Network Protocol	TCP/IP, DHCP, HTTP, UDP	
Software Upgrade	Upgrade via Memory Card(SD Card)	
Password Protection	Operation / Menu Setup / Remote Access	
Network Capabilities	Archives images as JPEG formats, Remote live or recorded images	
Power Supply (AC adapter)	Input: 100V-240V, 50 Hz/60 Hz; Output: DC12V max 5A	
Dimensions	Half Size mountable 220 mm x 94 mm x 340 mm EIA 19" 2U	
Weight	About 3.9 kg	
Operation Temperature	5° C ~ 40° C (41° F ~ 104° F)	
Regulation	FCC, CE	
Provided Accessories	AC Adapter x 1	
	Instruction manual x 1	
	Power cord x 1	
	CD x 1	
	Screw x 4	N/A
	Key x 2	N/A

\*Design and specifications subject to change without notice.

## 6.6 ScanIP

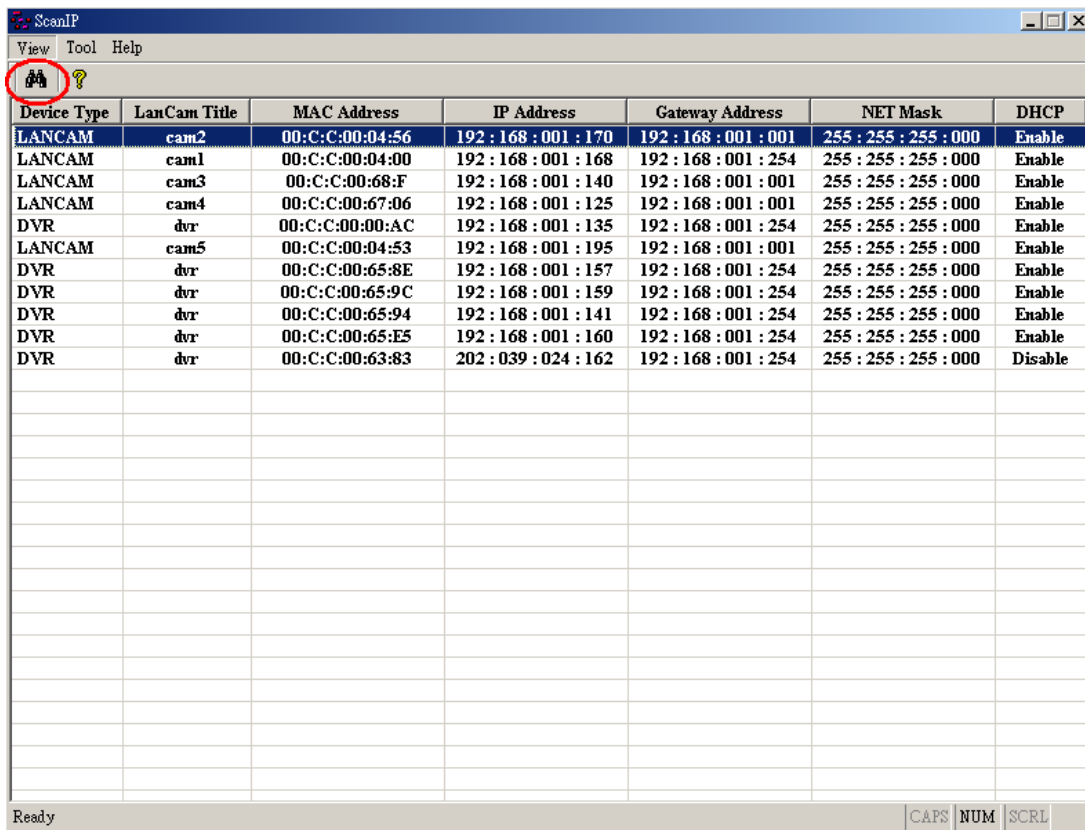

The screenshot shows the ScanIP application window with a menu bar (View, Tool, Help) and a toolbar containing a red circle around a network icon and a question mark. Below is a table listing discovered devices.

Device Type	LanCam Title	MAC Address	IP Address	Gateway Address	NET Mask	DHCP
LANCAM	cam2	00:C:C:00:04:56	192:168:001:170	192:168:001:001	255:255:255:000	Enable
LANCAM	cam1	00:C:C:00:04:00	192:168:001:168	192:168:001:254	255:255:255:000	Enable
LANCAM	cam3	00:C:C:00:68:F	192:168:001:140	192:168:001:001	255:255:255:000	Enable
LANCAM	cam4	00:C:C:00:67:06	192:168:001:125	192:168:001:001	255:255:255:000	Enable
DVR	dvr	00:C:C:00:00:AC	192:168:001:135	192:168:001:254	255:255:255:000	Enable
LANCAM	cam5	00:C:C:00:04:53	192:168:001:195	192:168:001:001	255:255:255:000	Enable
DVR	dvr	00:C:C:00:65:8E	192:168:001:157	192:168:001:254	255:255:255:000	Enable
DVR	dvr	00:C:C:00:65:9C	192:168:001:159	192:168:001:254	255:255:255:000	Enable
DVR	dvr	00:C:C:00:65:94	192:168:001:141	192:168:001:254	255:255:255:000	Enable
DVR	dvr	00:C:C:00:65:E5	192:168:001:160	192:168:001:254	255:255:255:000	Enable
DVR	dvr	00:C:C:00:63:83	202:039:024:162	192:168:001:254	255:255:255:000	Disable

Follow the instructions below to use the ScanIP software to search the DVR devices in a local network.

1. Click the  button to discover the connection of the all-type device in the LAN. The **Device List** will display the connection of the all-type device.
2. Select the desired device of the DVR from the **Device List**.
3. Click the desired device to show the window while the DVR information acts to display the desired changes instantly.
4. Do you want to execute an automatic search for free IP?

If and when you want to auto search the free IP, select "Yes" or "No". If clicked "Yes", the software will provide the "Free IP Address" boxes to the right of the window. If you click "No", these address boxes will not show.



5. Manual insertion of "Free IP Address".

If you have clicked "No", please manually type in insertions as required against the "Free IP Address", "Gateway Address", and "NET Mask". Follow each insertion you make by typing in the "Login Name" and "Password", and click "UPDATE" to send your alterations to the DVR.



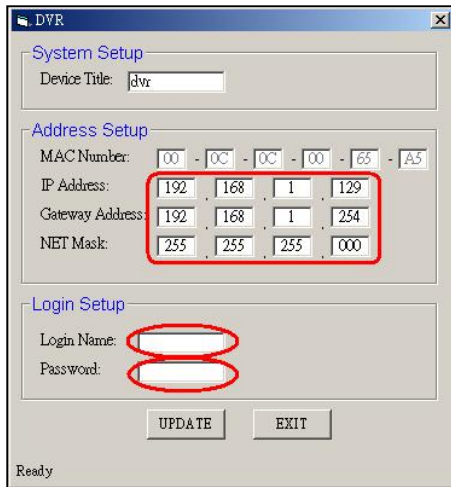

6. Auto search "Free IP Address".

If you clicked "Yes" the "Free IP Address" box will appear on the right.

2. To change any IP address, type in the new address in the "Free IP Address" box on the right as well as the device "Login Name" and "Password" in their respective blanks at bottom left, then click "UPDATE", and the new address will automatically be sent to the device.

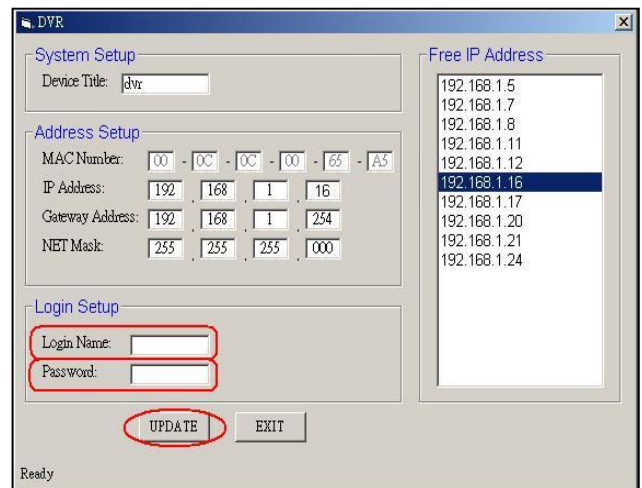

1. Select and double click any of the addresses in the "Free IP Address" box on the right to enter it into an IP Address on the left.

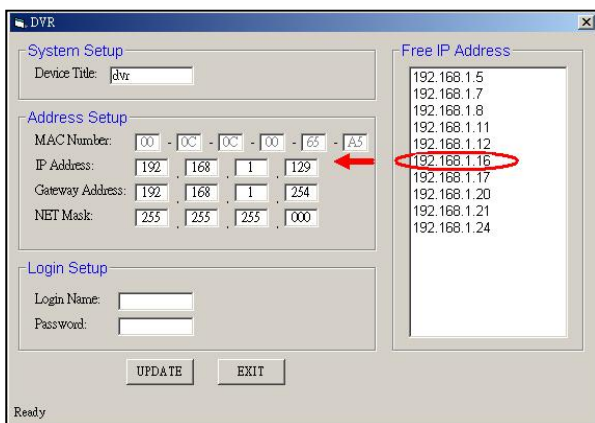

9. Click "Exit" at bottom right to shut the device.

## APPENDIX 1. – Using CD Discs (FOR CD-RW MODEL ONLY)

Please note that when using CD-ROM, CD-R or CD-RW discs, do not write or stick anything on the surface as this could cause an error in recording or the data on the disc may be damaged.

### Inserting Disc

1. Please press the eject button.
2. Please place the disc in the tray.

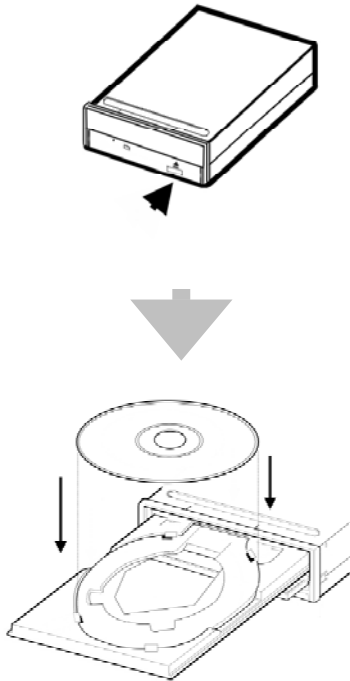

**NOTE: When using a 12 cm disc, please place it in the center of the caddy where you are able to see the larger position specifically for the 12 cm disc. When using an 8 cm disc, please place it in the center of the caddy where you can see the position for the 8 cm disc. Please place the printed side up. Never place two discs in the caddy at the same time.**

3. Please do not touch the surface of the disc where it has been recorded.
4. To insert the caddy please press the insert / eject button and hold the caddy lightly at the middle of its front and push gently to insert.

### Ejecting The Disc

1. Press the eject button.
2. Carefully lift out the disc.
3. Press the eject button, or lightly touch the center of the tray and the tray will automatically reenter its position within the CD - RW recorder.

**Caution: After the tray has been ejected and the disc has been retrieved from the caddy or put in the caddy, insert the tray in its original position to avoid the accumulation of dust or miscellaneous items inside the caddy, which may affect the pick up head when it needs to remain clean for effective reading of the data.**

### Emergency Eject Button

The device has an emergency eject button which allows for manual retrieval of the disc in case the machine needs repair, or there is a cut in the power supply. In the above circumstances use the following method to eject the disc.

1. The power supply has been cut.
2. Press the emergency eject button with a needle ( a paper clip, etc. can also be used ) and the tray will immediately eject.

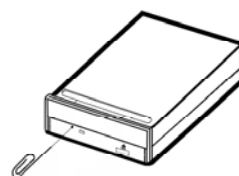

3. Press the front of the tray or lightly and gently pull the tray out with two fingers.

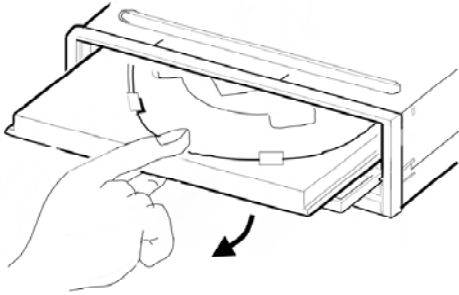

### **Caution**

When you use either a CD-RW or a CD-ROM, please pay heed to the following.

1. At the time of installation: As suggested in your specifications, please do not install in an unstable position or in one that causes vibrations.
2. Do not install in high humidity, direct sunlight, or damp conditions.
3. Do not use near magnetic fields, or place near a television or a radio signal as the performance of the device may be affected.
4. Do not open to try to repair, as the laser may be harmful.

## Free Manuals Download Website

<http://myh66.com>

<http://usermanuals.us>

<http://www.somanuals.com>

<http://www.4manuals.cc>

<http://www.manual-lib.com>

<http://www.404manual.com>

<http://www.luxmanual.com>

<http://aubethermostatmanual.com>

Golf course search by state

<http://golfingnear.com>

Email search by domain

<http://emailbydomain.com>

Auto manuals search

<http://auto.somanuals.com>

TV manuals search

<http://tv.somanuals.com>