

Aspire 6930/6930G Series Service Guide

Service guide files and updates are available on the ACER/CSD web; for more information, please refer to <http://csd.acer.com.tw>

PRINTED IN TAIWAN

Revision History

Please refer to the table below for the updates made on Aspire 6930/6930G Series service guide.

Date	Chapter	Updates

Copyright

Copyright © 2008 by Acer Incorporated. All rights reserved. No part of this publication may be reproduced, transmitted, transcribed, stored in a retrieval system, or translated into any language or computer language, in any form or by any means, electronic, mechanical, magnetic, optical, chemical, manual or otherwise, without the prior written permission of Acer Incorporated.

Disclaimer

The information in this guide is subject to change without notice.

Acer Incorporated makes no representations or warranties, either expressed or implied, with respect to the contents hereof and specifically disclaims any warranties of merchantability or fitness for any particular purpose. Any Acer Incorporated software described in this manual is sold or licensed *as is*. Should the programs prove defective following their purchase, the buyer (and not Acer Incorporated, its distributor, or its dealer) assumes the entire cost of all necessary servicing, repair, and any incidental or consequential damages resulting from any defect in the software.

Acer is a registered trademark of Acer Corporation.

Intel is a registered trademark of Intel Corporation.

Pentium and Pentium II/III are trademarks of Intel Corporation.

Other brand and product names are trademarks and/or registered trademarks of their respective holders.

Conventions

The following conventions are used in this manual:

SCREEN MESSAGES	Denotes actual messages that appear on screen.
NOTE	Gives bits and pieces of additional information related to the current topic.
WARNING	Alerts you to any damage that might result from doing or not doing specific actions.
CAUTION	Gives precautionary measures to avoid possible hardware or software problems.
IMPORTANT	Reminds you to do specific actions relevant to the accomplishment of procedures.

Preface

Before using this information and the product it supports, please read the following general information.

1. This Service Guide provides you with all technical information relating to the BASIC CONFIGURATION decided for Acer's *global* product offering. To better fit local market requirements and enhance product competitiveness, your regional office MAY have decided to extend the functionality of a machine (e.g. add-on card, modem, or extra memory capability). These LOCALIZED FEATURES will NOT be covered in this generic service guide. In such cases, please contact your regional offices or the responsible personnel/channel to provide you with further technical details.
2. Please note WHEN ORDERING FRU PARTS, that you should check the most up-to-date information available on your regional web or channel. If, for whatever reason, a part number change is made, it will not be noted in the printed Service Guide. For ACER-AUTHORIZED SERVICE PROVIDERS, your Acer office may have a DIFFERENT part number code to those given in the FRU list of this printed Service Guide. You MUST use the list provided by your regional Acer office to order FRU parts for repair and service of customer machines.

System Specifications	1
Features	1
System Block Diagram	4
Your Acer Notebook tour	5
Front View	5
Closed Front View	6
Left View	7
Right View	8
Rear View	8
Bottom View	9
Indicators	10
Easy-Launch Buttons	10
Touchpad Basics (with fingerprint reader)	11
Using the Keyboard	12
Lock Keys and embedded numeric keypad	12
Windows Keys	13
Hot Keys	14
Special Key	15
Using the System Utilities	16
Acer GridVista (dual-display compatible)	16
Hardware Specifications and Configurations	18
 System Utilities	 33
BIOS Setup Utility	33
Navigating the BIOS Utility	33
Information	34
Main	35
Security	36
Boot	39
Exit	40
BIOS Flash Utility	41
Remove HDD/BIOS Utility	43
 Machine Disassembly and Replacement	 47
Disassembly Requirements	47
General Information	48
Pre-disassembly Instructions	48
Disassembly Process	48
External Module Disassembly Process	49
External Modules Disassembly Flowchart	49
Removing the Battery Pack	50
Removing the SD dummy card	51
Removing the ExpressCard dummy card	52
Removing the Lower Covers	53
Removing the DIMM Modules	54
Removing the VGA Module	55
Removing the TV Tuner Module	56
Removing the Main Hard Disk Drive Module	59
Removing the Optical Disk Drive Module	61
Removing the Secondary Hard Disk Drive Module	63
Main Unit Disassembly Process	65
Main Unit Disassembly Flowchart	65
Removing the Switch Cover	66
Removing the Power Board	67

Table of Contents

Removing the Keyboard	69
Removing the Speaker Module	70
Removing the Antenna Cables	71
Removing the LCD Module	73
Removing the Upper Base	74
Removing the Finger Print Reader	77
Removing the USB Board	78
Removing the Modem Module	79
Removing the Bluetooth Module	80
Removing the Mainboard	82
Removing the Thermal Module	84
Removing the CPU	85
LCD Module Disassembly Process	86
LCD Module Disassembly Flowchart	86
Removing the LCD Bezel	87
Removing the Inverter Board	90
Removing the Camera Module	91
Removing the LCD Panel	92
Removing the LCD Brackets and FPC Cable	93
LCD Module Reassembly Procedure	95
Replacing the LCD Panel	95
Replacing the LCD Bezel	99
Main Module Reassembly Procedure	101
Replacing the CPU	101
Replacing the Thermal Module	101
Replacing the Mainboard	103
Replacing the Bluetooth Board	105
Replacing the Modem Module	105
Replacing the Finger Print Reader	107
Replacing the Upper Cover	108
Replacing the LCD Module	110
Replacing the Speaker Module	113
Replacing the Keyboard	113
Replacing the Power Board	114
Replacing the Switch Cover	115
Replacing the Second Hard Disk Drive Module	117
Replacing the ODD Module	117
Replacing the Main Hard Disk Drive Module	118
Replacing the WLAN Module	119
Replacing the TV Tuner Module	120
Replacing the VGA Module	120
Replacing the DIMM Modules	121
Replacing the Lower Covers	121
Replacing the ExpressCard and SD Card Dummy Trays	122

Troubleshooting

123

Common Problems	123
Power On Issue	124
No Display Issue	125
Random Loss of BIOS Settings	126
LCD Failure	127
Built-In Keyboard Failure	127
Touchpad Failure	128
Internal Speaker Failure	128
Internal Microphone Failure	130

Table of Contents

HDD Not Operating Correctly	131
USB Failure (Rightside)	134
External Mouse Failure	135
Other Failures	135
Intermittent Problems	136
Undetermined Problems	136
POST Codes Tables	137
Chipset POST Codes	137
Core POST Code Table	139
Jumper and Connector Locations	147
Top View	147
Bottom View	148
Clearing Password Check and BIOS Recovery	149
Clearing Password Check	149
BIOS Recovery by Crisis Disk	150
FRU (Field Replaceable Unit) List	151
Aspire 6930/6930G Exploded Diagrams	152
Main Module	152
LCD Module	153
Aspire 6930/6930G FRU List	154
Screw List	163
Model Definition and Configuration	164
Aspire 6930/6930G Series	164
Test Compatible Components	215
Microsoft® Windows® Vista Environment Test	216
Peripheral Tests	220
Online Support Information	225
Index	227

Table of Contents

System Specifications

Features

Below is a brief summary of the computer's many feature:

NOTE: Items marked with * denote only selected models.

Operating System

- Genuine Windows® Vista™

Platform

- Intel® Centrino® 2 processor technology, featuring:
 - Intel® Core™ 2 Duo processor
 - Mobile Intel® PM45/GM45 Express Chipset*
 - Intel® Wireless WiFi Link 5100/5300*
- Intel® Pentium® dual-core processor*
- Mobile Intel® PM45/GM45 Express Chipset*

System Memory

- Dual-Channel SDRAM support
- Up to 2 GB of DDR2 667 MHz memory, upgradeable to 4 GB using two soDIMM modules

TV Tuner

- Digital TV-tuner supporting DVB-T*

Display and graphics

- 16:9 aspect ratio
- 16" Full HD 1920 x 1080
- 16" HD 1366 x 768
- Mobile Intel® GM45 Express Chipset*
- NVIDIA® GeForce® 9300M GS*
- NVIDIA® GeForce® 9600M GS*
- NVIDIA® GeForce® 9600M GT*

NOTE: Nvidia VGA chipsets apply to Aspire 6930G. The Intel VGA chipset applies to Aspire 6930.

Storage subsystem

- 2.5" hard disk drive
- Intel® Turbo Memory supported*
- Optical drive options:
 - Blu-ray Disc™ /DVD-Super Multi double-layer drive*
 - DVD-Super Multi double-layer drive*
- 5-in-1 card reader

Audio

- Dolby®-epitomized surround sound system with two built-in stereo speakers and one subwoofer* supporting low-frequency effects
- True5.1-channel surround sound output
- High-definition audio support
- S/PDIF (Sony/Philips Digital Interface) support for digital speakers
- Acer PureZone technology with two built-in stereo microphones
- MS-Sound compatible

Communication

- Acer Video Conference, featuring:
 - Integrated Acer Crystal Eye webcam*
 - Acer PureZone technology*
 - Optional Acer Xpress VoIP phone*
- WLAN: Intel® Wireless WiFi Link 5100/5300*
- WPAN: Bluetooth® 2.0+Enhanced Data Rate (EDR)*
- LAN: Gigabit Ethernet; Wake-on-LAN ready
- Modem: 56K ITU V.92

Dimensions and Weight

- 385 (W) x 277.5 (D) x 41/43.9 (H) mm (15.71 x 11.49 x 1.61/1.73 inches)
- 3.50 kg (7.71 lbs.) with 2 HDDs and 8-cell battery pack
- 3.40 kg (7.49 lbs.) with 2 HDDs and 6-cell battery pack

Privacy control

- Acer Bio-Protection fingerprint solution*
- BIOS user, supervisor, HDD passwords
- Kensington lock slot

Power subsystem

- ACPI 3.0
- 71 W 4800 mAh*
- 48.8 W 4400 mAh*
- 3-pin 90 W AC adapter*
- 3-pin 65 W AC adapter*
- ENERGY STAR® 4.0

Special keys and controls

- 105/106-key keyboard
- Touchpad pointing device

I/O interface

- Acer EasyPort IV connector*
- ExpressCard™/54 slot
- Acer Bio-Protection fingerprint reader*
- 5-in-1 card reader (SD/MMC/MS/MS PRO/xD)
- 3 USB 2.0 ports
- USB 2.0 / eSATA port *

NOTE: If you plug an eSATA device you will have three USB ports available in the mean time.

- HDMI™ port with HDCP support*
- External display (VGA) port
- Consumer infrared (CIR) port
- RF-in jack*
- Headphones/speaker/line-out jack with S/PDIF support*
- Microphone-in jack
- Line-in jack
- Ethernet (RJ-45) port
- Modem (RJ-11) port
- DC-in jack for AC adapter

Environment

- Temperature:
 - Operating: 5 °C to 35 °C
 - Non-operating: -20 °C to 65 °C
- Humidity (non-condensing):
 - Operating: 20% to 80%
 - Non-operating: 20% to 80%



NOTE: Items marked with * denote only selected models. The specifications listed above are for reference only. The exact configuration of your PC depends on the model purchased.

Your Acer Notebook tour

After knowing your computer features, let us show you around your new computer.

Front View





No.	Icon	Item	Description
1		Acer Crystal Eye webcam	Web camera for video communication (only for certain models).
2		Microphone	Internal microphone for sound recording.
3		Display screen	Also called Liquid-Crystal Display (LCD), displays computer output (Configuration may vary by models).
4		Power button	Turns the computer on and off.
5		Status indicators	Light-Emitting Diodes (LEDs) that light up to show the status of the computer's functions and components.

No.	Icon	Item	Description
6		Keyboard	For entering data into your computer.
7		Palmrest	Comfortable support area for your hands when you use the computer.
8		Click buttons (left, center* and right)	The left and right buttons function like the left and right mouse buttons. *The center button serves as Acer Bio-Protection fingerprint reader supporting Acer FingerNav 4-way control function (only for certain models).
9		Touchpad	Touch-sensitive pointing device which functions like a computer mouse.
10	VOL +	Volume Up	Increase system volume/decrease system volume.
	VOL -	Volume Down	
11		Acer MediaTouch keys	For use with Acer Arcade and other media playing programs.
12		Easy-launch buttons	Buttons for launching frequently used programs.
13		Empowering key	Launch Acer Empowering Technology.
14		Speakers	Left and right speakers deliver stereo audio output.







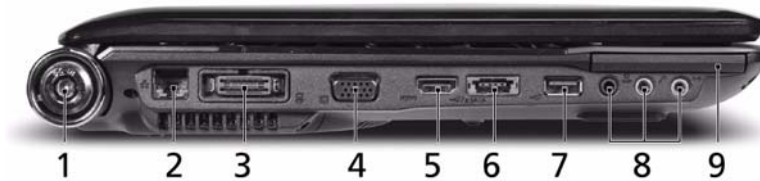

Closed Front View



No.	Icon	Item	Description
1		5-in-1 card reader	Accepts Secure Digital (SD), MultiMediaCard (MMC), Memory Stick (MS), Memory Stick PRO (MS PRO), xD-Picture Card (xD). Note: Push to remove/install the card. Only one card can operate at any given time.
2		CIR receiver	Receives signals from a remote control





Left View

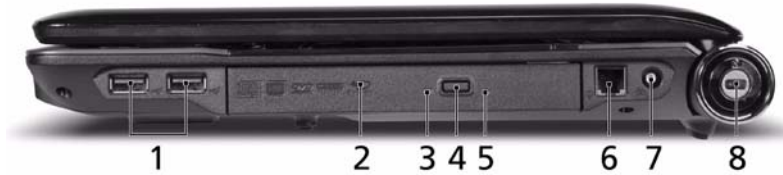

No.	Icon	Item	Description
1		DC in jack	Connects to an AC adapter
2		Ethernet (RJ-45) port	Connects to an Ethernet 10/100/1000-based network.
3		Acer EasyPort IV connector	Connects to Acer EasyPort IV (only for certain models).
4		External display (VGA) port	Connects to a display device (e.g. external monitor, LCD projector).
5	HDMI	HDMI port	Supports high definition digital video connections (only for certain models).
6		USB 2.0 / eSATA port	Connects to USB 2.0 or eSATA devices (only for certain models). Note: If you plug an eSATA device you will have three USB ports available in the mean time.
7		USB 2.0 port	Connect to USB 2.0 devices (e.g. USB mouse, USB camera).
8		Headphones/speaker/line-out jack with S/PDIF support	Connects to audio line-out devices (e.g., speakers, headphones).
		Microphone jack	Accepts inputs from external microphones.
		Line-in jack	Accepts audio line-in devices (e.g., audio CD player, stereo walkman, mp3 player).
9	ExpressCard / 54	ExpressCard/54 slot	Accepts one ExpressCard/54 module.

Right View



No.	Icon	Item	Description
1		USB 2.0 port	Connect to USB 2.0 devices (e.g. USB mouse, USB camera).
2		Optical drive	Internal optical drive; accepts CDs or DVDs.
3		Optical disk access indicator	Lights up when the optical drive is active.
4		Optical drive eject button	Ejects the optical disk from the drive.
5		Emergency eject hole	Ejects the optical drive tray when the computer is turned off. Note: Insert a paper clip into the emergency eject hole to eject the optical drive tray when the computer is off.
6		Modem (RJ-11) port	Connects to a phone line.
7		RF-in port	Accepts input signals from digital TV Tuner devices (only for certain models).
		Kensington lock slot	Connects to a Kensington-compatible computer security lock.







Rear View

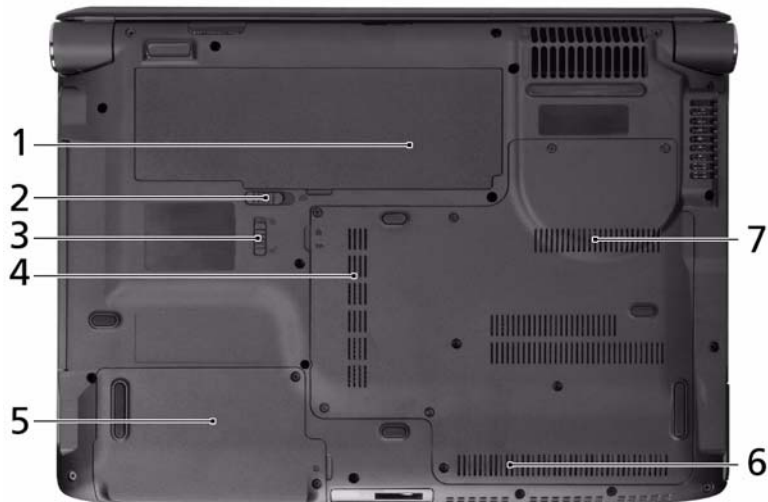

No.	Item	Description
1	Tuba	The dedicated Tuba CineBass subwoofer pumps out earthshaking movie-house audio.
2	Ventilation slots	Enable the computer to stay cool, even after prolonged use.

Bottom View









No.	Icon	Item	Description
1		Battery bay	Houses the computer's battery pack.
2		Battery release latch	Releases the battery for removal.
3		Battery lock	Locks the battery in position.
4		Hard disk bay-Main	Houses the computer's hard disk (secured with screws).
5		Hard disk bay-Secondary	Houses the computer's hard disk (secured with screws) (only for certain models).
6		Memory compartment	Houses the computer's main memory.
7		Ventilation slots and cooling fan	Enable the computer to stay cool, even after prolonged use. Note: Do not cover or obstruct the opening of the fan.

Indicators

The computer has several easy-to-read status indicators:

The front panel indicators are visible even when the computer cover is closed.





Icon	Function	Description
	Bluetooth	Indicates the status of Bluetooth communication.
	WLAN	Indicates the status of wireless LAN communication.
	Power	Indicates the computer's power status.
	Battery	Indicates the computer's battery status.
	HDD	Indicates when the hard disk drive is active.
	Num Lock	Lights up when Num Lock is activated.
	Caps Lock	Lights up when Caps Lock is activated.

NOTE: 1. **Charging:** The battery light shows amber when the battery is charging. 2. **Fully charged:** The light shows green when in AC mode.

Easy-Launch Buttons

Located beside the keyboard are application buttons. These buttons are called easy-launch buttons. They are: WLAN, Internet, email, Bluetooth, Arcade and Acer Empowering Technology.

The mail and Web browser buttons are pre-set to email and Internet programs, but can be reset by users. To set the Web browser, mail and programmable buttons, run the Acer Launch Manager.

Icon	Function	Description
	Empowering Technology	Launch Acer Empowering Technology. (user-programmable)
	Web browser	Internet browser (user-Programmable)
	Mail	Email application (user-Programmable)
	Bluetooth communication switch	Enables/disables the Bluetooth function.
	Wireless communication switch	Enables/disables the wireless function.

Touchpad Basics (with fingerprint reader)

The following items show you how to use the touchpad with Acer Bio-Protection fingerprint reader:

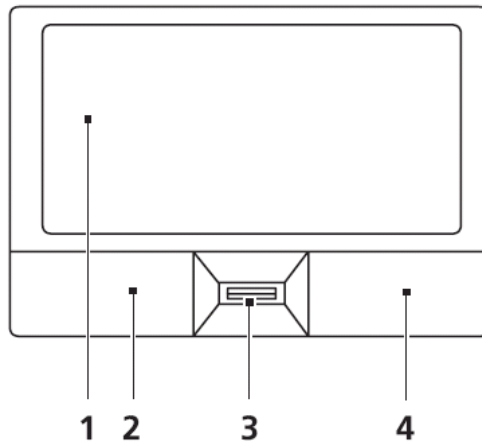

- Move your finger across the touchpad (2) to move the cursor.
- Press the left (1) and right (4) buttons located beneath the touchpad to perform selection and execution functions. These two buttons are similar to the left and right buttons on a mouse. Tapping on the touchpad is the same as clicking the left button.
- Use Acer Bio-Protection fingerprint reader (3) supporting Acer FingerNav 4-way control function (only for certain models) or the 4-way scroll (3) button (only for certain models) to scroll up or down and move left or right a page. This fingerprint reader or button mimics your cursor pressing on the right scroll bar of Windows applications.

Function	Left Button (1)	Right Button (3)	Main touchpad (2)
Execute	Quickly click twice.		Tap twice (at the same speed as double-clicking a mouse button).
Select	Click once.		Tap once.
Drag	Click and hold, then use finger on the touchpad to drag the cursor.		Tap twice (at the same speed as double-clicking a mouse button); rest your finger on the touchpad on the second tap and drag the cursor.
Access context menu		Click once.	

NOTE: When using the touchpad, keep it - and your fingers - dry and clean. The touchpad is sensitive to finger movement; hence, the lighter the touch, the better the response. Tapping too hard will not increase the touchpad's responsiveness.

Using the Keyboard

The keyboard has full-sized keys and an embedded numeric keypad, separate cursor, lock, Windows, function and special keys.

Lock Keys and embedded numeric keypad

The keyboard has three lock keys which you can toggle on and off.





















Lock key	Description
Caps Lock	When Caps Lock is on, all alphabetic characters typed are in uppercase.
Num Lock <Fn> + <F11>	When Num Lock is on, the embedded keypad is in numeric mode. The keys function as a calculator (complete with the arithmetic operators +, -, *, and /). Use this mode when you need to do a lot of numeric data entry. A better solution would be to connect an external keypad.
Scroll Lock <Fn> + <F12>	When Scroll Lock is on, the screen moves one line up or down when you press the up or down arrow keys respectively. Scroll Lock does not work with some applications.

The embedded numeric keypad functions like a desktop numeric keypad. It is indicated by small characters located on the upper right corner of the keycaps. To simplify the keyboard legend, cursor-control key symbols are not printed on the keys.

Desired access	Num Lock on	Num Lock off
Number keys on embedded keypad	Type numbers in a normal manner.	
Cursor-control keys on embedded keypad	Hold <Shift> while using cursor-control keys.	Hold <Fn> while using cursor-control keys.
Main keyboard keys	Hold <Fn> while typing letters on embedded keypad.	Type the letters in a normal manner.

Windows Keys

The keyboard has two keys that perform Windows-specific functions.

Key	Description
 Windows key	<p>Pressed alone, this key has the same effect as clicking on the Windows Start button; it launches the Start menu. It can also be used with other keys to provide a variety of functions:</p> <ul style="list-style-type: none"> <  >: Open or close the Start menu <  > + <D>: Display the desktop <  > + <E>: Open Windows Explore <  > + <F>: Search for a file or folder <  > + <G>: Cycle through Sidebar gadgets <  > + <L>: Lock your computer (if you are connected to a network domain), or switch users (if you're not connected to a network domain) <  > + <M>: Minimizes all windows <  > + <R>: Open the Run dialog box <  > + <T>: Cycle through programs on the taskbar <  > + <U>: Open Ease of Access Center <  > + <X>: Open Windows Mobility Center <  > + <BREAK>: Display the System Properties dialog box <  > + <SHIFT+M>: Restore minimized windows to the desktop <  > + <TAB>: Cycle through programs on the taskbar by using Windows Flip 3-D <  > + <SPACEBAR>: Bring all gadgets to the front and select Windows Sidebar <CTRL> + <  > + <F>: Search for computers (if you are on a network) <CTRL> + <  > + <TAB>: Use the arrow keys to cycle through programs on the taskbar by using Windows Flip 3-D <p>Note: Depending on your edition of Windows Vista, some shortcuts may not function as described.</p>
 Application key	<p>This key has the same effect as clicking the right mouse button; it opens the application's context menu.</p>

Hot Keys

The computer employs hotkeys or key combinations to access most of the computer's controls like screen brightness, volume output and the BIOS utility.

To activate hot keys, press and hold the <Fn> key before pressing the other key in the hotkey combination.



Hotkey	Icon	Function	Description
<Fn> + <F1>	?	Hotkey help	Displays help on hotkeys.
<Fn> + <F2>		Acer eSettings Management	Launches Acer eSettings Management in Acer Empowering Technology.
<Fn> + <F3>		Acer ePower Management	Launches Acer ePower Management in Acer Empowering Technology.
<Fn> + <F4>	Z ^z	Sleep	Puts the computer in Sleep mode.
<Fn> + <F5>		Display toggle	Switches display output between the display screen, external monitor (if connected) and both.
<Fn> + <F6>		Screen blank	Turns the display screen backlight off to save power. Press any key to return.
<Fn> + <F7>		Touchpad toggle	Turns the internal touchpad on and off.
<Fn> + <F8>		Speaker toggle	Turns the speakers on and off.
<Fn> + <D>		Brightness up	Increases the screen brightness.
<Fn> + <D>		Brightness down	Decreases the screen brightness.

Special Key

You can locate the Euro symbol and the US dollar sign at the upper-center and/or bottom-right of your keyboard.



The Euro symbol

1. Open a text editor or word processor.
2. Hold <Alt Gr> and then press the <5> key at the upper-center of the keyboard.

NOTE: Note: Some fonts and software do not support the Euro symbol. Please refer to www.microsoft.com/typography/faq/faq12.htm for more information.

The US dollar sign

1. Open a text editor or word processor.
2. Hold <Shift> and then press the <4> key at the upper-center of the keyboard.

NOTE: This function varies by the operating system version.

Using the System Utilities

Acer Bio-Protection (only for certain models) Acer Bio-Protection Fingerprint Solution is a multi-purpose fingerprint software package integrated with the Microsoft Windows operating system. Utilizing the uniqueness of one's fingerprint features, Acer Bio-Protection Fingerprint Solution has incorporated protection against unauthorized access to your computer with centralized password management with Password Bank, easy music player launching with Acer MusicLaunch, secure Internet favorites via Acer MyLaunch, and fast application/website launching and login with Acer FingerLaunch, while Acer ProfileLaunch can launch up to three applications/websites from a single finger swipe.

Acer Bio-Protection Fingerprint Solution also allows you to navigate through web browsers and documents using Acer FingerNav. With Acer Bio-Protection Fingerprint Solution, you can now enjoy an extra layer of protection for your personal computer, as well as the convenience of accessing your daily tasks with a simple swipe of your finger!

For more information refer to the Acer Bio-Protection help files.



Acer GridVista (dual-display compatible)

NOTE: This feature is only available on certain models.

To enable the dual monitor feature of the notebook, first ensure that the second monitor is connected, then select **Start, Control Panel, Display** and click on **Settings**. Select the secondary monitor (**2**) icon in the display box and then click the check box **Extend my windows desktop onto this monitor**. Finally, click **Apply** to confirm the new settings and click **OK** to complete the process.

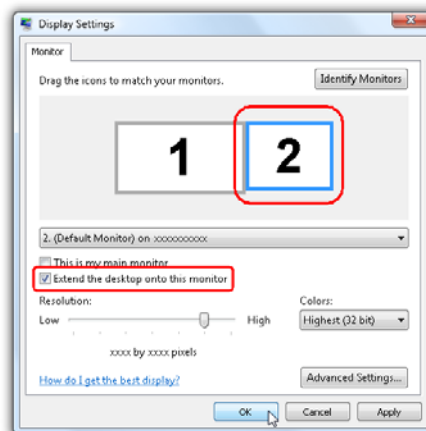

Acer GridVista is a handy utility that offers four pre-defined display settings so you can view multiple windows on the same screen. To access this function, please go to **Start → All Programs** and click on **Acer GridVista**. You may choose any one of the four display settings indicated below:



Double (vertical), Triple (primary at left), Triple (primary at right), or Quad Acer Gridvista is dual-display compatible, allowing two displays to be partitioned independently.

Acer Gridvista is dual-display compatible, allowing two displays to be partitioned independently.

AcerGridVista is simple to set up:

1. Run Acer GridVista and select your preferred screen configuration for each display from the task bar.
2. Drag and drop each window into the appropriate grid.
3. Enjoy the convenience of a well-organized desktop.

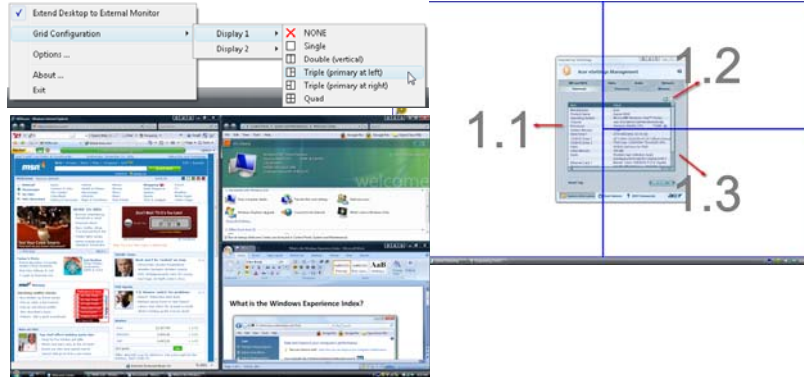

NOTE: Please ensure that the resolution setting of the second monitor is set to the manufacturer's recommended value.

Hardware Specifications and Configurations

Processor

Item	Specification
CPU type	Intel Penryn (dual core)
CPU Features	<ul style="list-style-type: none"> • Supports Intel architecture with Dynamic execution • On-die, primary 32-KB instruction cache and 32-KB write-back data cache • On-die, up to 6MB second level shared cache with advanced transfer cache architecture • Streaming SIMD Extensions 2 (SSE2), Streaming SIMD Extensions 3 (SSE3) • Supplemental streaming SIMD extensions 3 (SSSE3) and SSE4.1 instruction sets • 1066MHz source-synchronous front side bus (FSB) • Advanced power management features including Enhanced Intel SpeedStep® • Technology and dynamic FSB frequency switching • Digital thermal sensor (DTS) • Execute disable bit support for enhanced security • Intel® Dynamic Acceleration Technology and Enhanced Multi Threaded • Thermal Management (EmTTM) • Support enhanced Intel Virtualization Technology
Power	VCC-CORE: voltage for the future processor will depend on VID0- 6 for battery mode and setting via software for adapter mode for the future processor
CPU package	Intel 479 pin Micro-FCPGA

Northbridge

Item	Specification
Chipset	Intel Crestline PM45/GM45
Features	<ul style="list-style-type: none"> • Processor host bus supports, 667/800/1066MHz FSB support • Supports Dual Channel DDR2 SDRAM at 667/800 MHz • Supports Dual Channel DDR3 SDRAM at 800/1066 MHz • Integrated SDRAM controller up to 8GB (2 SODIMM support) • External Graphics interface for PCI Express Architecture support • DMI x2 and DMI x 4 for connection between GMCH and ICH9M • Supports ACPI 3.0
Power	1.05V core, 1.5V,VCCSM(DDR2 = 1.8V/DDR3=1.5V),2.5V,3.3V
Package	FCBGA 1329 balls

Southbridge

Item	Specification
Chipset	ICH9M
Features	<ul style="list-style-type: none"> Upstream accelerated Hub architecture interface for access to GMCH PCI Express Base Specification, Revision 1.1 support PCI 2.3 interface. (4 PCI Request/Grant pairs) ACPI Power Management Logic Support Enhanced DMA controller, interrupt controller, timers functions Integrated Serial ATA host controllers with independent DMA operation on six ports and AHCI support USB 1.1 & USB 2.0 Host controllers Supports Intel High Definition Audio (Intel HD Audio) Interface Supports Intel® Matrix Storage Technology Supports Intel® Active Management Technology Low Pin Count (LPC) interface 6 PCIe ports
Power	1.05V core,1.5V,3.3V,5V CMOS I/O
Package	BGA 676 balls

System Board major Chips

Item	Specifications
Core logic	Penryn, Cantiga (GM45/ PM45), ICH9M
VGA	UMA and MXM
LAN	Atheros AR8121
USB	2.0 Integrated with ICH9M
Super I/O controller	N/A
MODEM	<ul style="list-style-type: none"> Foxconn Conexant -Unizion 1.5_3.3v T60M955.02 Foxconn Conexant -Unizion 1.5_3.3v AUS T60M955.0x Lite-On Conexant -Unizion 1.5_3.3v AUS RD02-D330
Wireless LAN	<ul style="list-style-type: none"> Intel WLAN 512AN_HMWG Shirley Peak 5100 MM#895373 Intel WLAN 512AN_MMWG Shirley Peak 5100 MM#895361 Intel WLAN 533AN_HMWG Shirley Peak MM#895401 Intel WLAN 533AN_MMWG Shirley Peak MM#895362 QMI Wireless LAN Atheros AR5B91 1x2 BGN Foxconn Wireless LAN Wireless LAN Ralink RT2700E 1x2 BGN Intel WLAN 512AG_MMWG Shirley Peak 5100 MM#897004 Intel WLAN 533ANXMMWG Echo Peak 5350 MM#895365
Bluetooth	Foxconn Bluetooth FOX_BRM_2.0 F/W 300
Media Card Reader	Realtek RTS5158E
Audio Codec	Realtek ALC888S
Clock Generator	Seligo SLG8SP512K05

CPU Fan True Value Table

Level	Fan On Temp.	Fan Off Temp.	RPM Throttling	dB(A)
0	50	45	2300	31
1	60	55	2600	34
2	70	65	2800	37
3	80	75	3100	40

- Throttling 50%: On =93C; Off=85C
- OS Shut down: 105C
- H/W Shut down: 110C

Fan default: 3.5V

BIOS ROM

Item	Specification
BIOS Vendor	Phoenix
BIOS Version	3120
BIOS ROM Type	W25X16AVSSIG
BIOS ROM Size	16 MB
BIOS Package	8 PIN SOIC
Supported Protocols	SPI
BIOS Password control	Set by setup manual

System Clock

Item	Specification
Chipset	Silego SLG8SP512K05
Features	<ul style="list-style-type: none"> • 200/166Mhz for CPU, GMCH • 100MHz clock buffer for GMCH, ICH8M and PCI-E device, SATA, Docking station • 96MHz GMCH • 48Mhz for USB clock inside ICH8M • 33Mhz PCI clock for PCI device, LPC • 14.31818Mhz for ICH8M • Support spread spectrum function, for reducing EMI • Support SM bus interface.
Power	3.3V
Package	64 pin TSSOP

Crystal and Oscillator

Item	Specification
Features	<ul style="list-style-type: none"> • 14.31818Mhz crystal for clock chip • 32.768Khz crystal for RTC inside ICH9M and EC/ WPC775LDG • 25MHZ crystal for Atheros LAN controller AR8121

System Memory

Item	Specifications
Memory Controller	Integrated with GMCH (GM45/ PM45)
Memory Size	0MB (No on-board Memory)
DIMM socket number	2 sockets
Supports Memory size per socket	2 GB
Support maximum memory size	4 GB for 64bit OS (with two 2GB SO-DIMM)
Support DIMM type	DDR2 Synchronous DRAM
Support DIMM Speed	533/667 MHz
Support DIMM voltage	1.8V
Support DIMM package	200-pin DDR2-533/667 SO-DIMM
Memory module combinations	You can install memory modules in any combination as long as they match the above specifications

Memory Combinations

Slot 1	Slot 2	Total Memory
0MB	512MB	512MB
0MB	1024MB	1024MB
0MB	2048MB	2048MB
512MB	512MB	1024MB
512MB	1024MB	1536MB
512MB	2048MB	2560MB
1024MB	0MB	1024MB
1024MB	512MB	1536MB
1024MB	1024MB	2048MB
1024MB	2048MB	3072MB
2048MB	0MB	2048MB
2048MB	512MB	2560MB
2048MB	1024MB	3072MB
2048MB	2048MB	4096MB

NOTE: Above table lists some system memory configurations. You may combine DIMMs with various capacities to form other combinations. On above table, the configuration of slot 1 and slot 2 could be reversed.

Hard Disk Drive Interface

Item	Specification				
Vendor & Model Name	Seagate ST9250827AS ST9120817AS	Seagate ST9320320AS ST9160310AS	Toshiba MK3252GSX MK2552GSX MK1652GSX MK1252GSX	WD WD3200BEVT WD2500BEVS	HGST 5K320-320 5K320-250 5K320-160 5K320-120
Capacity (MB)	250, 120	320, 160	320, 250, 160, 120	320, 250	320, 250, 160, 120
Bytes per sector	512	512	512	512	512
Data heads	4, 2	4, 2	4, 4, 2, 2	4	4, 4 or 3, 2, 2
Drive Format					
Disks	2, 1	2 or 1, 1	2, 2, 1, 1	2	2, 2, 1, 1
Spindle speed (RPM)	5400	5400	5400	5400	5400
Performance Specifications					
Buffer size	8 MB	8 MB	8 MB	8 MB	8 MB
Interface	SATA	SATA	SATA	SATA	SATA
Internal transfer rate (Mbits/sec, max)	778	352	400 ~ 794 typical	850 Mbits/s maximum	674~729 typical
I/O data transfer rate (Mbytes/sec max)	300	150	300	300/150 maximum	300
DC Power Requirements					
Voltage tolerance	5V ±5%	5V ±5%	5V ±5%	5V ±5%	5V ±5%

Super-Multi Combo Module

Item	Specification
Manufacturer and Model	Pioneer DVR-TD08RS
Type	Drawer loading
Interface	Serial ATA Revision 2.6
Data Transfer Mode	Gen1i 1.5Gbits / sec
Buffer Memory Size	2 MB
Maximum Write Speed	<ul style="list-style-type: none"> 8X Zone CLV at DVD-R / +R, DVD+RW 6X Zone CLV at DVD-R DL / +R DL, DVD-RW 5X Zone CLV at DVD-RAM 24X Zone CLV at CD-R / RW
Maximum Read Speed	<ul style="list-style-type: none"> 8X CAV at DVD-ROM SL, DVD-R / +R, -RW / +RW, DVD-ROM DL, DVD-R DL / +R DL 5X Zone CLV at DVD-RAM 24X CAV at CD-ROM, CD-R / RW

Item	Specification
Formats Supported	<ul style="list-style-type: none"> • KODAK Photo CD Single and Multi-session • CD Extra (CD PLUS) • Video CD • CD text data (Read / Write) • CD-R discs (Read / Write) • CD-RW discs (Read / Write) • DVD-ROM • DVD-R Ver.2.0 & 2.1 for General (Read / Write) • DVD-R DL Ver.3.0 (Read/Write) • DVD-RW Ver.1.0 & 1.1 & 1.2 (Read / Write) • DVD+R Ver.1.3 (Read/Write) • DVD+R DL Ver1.0 & 1.1 (Read / Write) • DVD+RW Ver.1.3 (Read/Write) • DVD+RW high speed Ver.1.0 (Read/Write) • DVD-RAM Ver.2.0 & 2.1 & 2.2
Power Supply	5V
Voltage Allowance	±5% (operating) -8% (startup)

Item	Specification
Vendor & model name	HLDS/GSA-T50N, Philips DS-8A2S, Sony/AD-7560S
Performance Specification	With CD Diskette With DVD Diskette
Transfer rate (MB/sec)	Sustained: Max 3.5 Mbytes/sec Sustained: Max 10 Mbytes/sec
Buffer Memory	2MB
Interface	SATA
Applicable disc format	<p>Applicable media types:</p> <p>Writing:</p> <p>Confirms to DVD+R Version 1.2 and DVD+RW Version 1.3 / DVD+R DL Version 1.0 / DVD-R Version 2.0 / DVD-RW Version 1.2 / DVD-R DL Version 3.0.</p> <p>Reading:</p> <p>DVD single/dual layer (PTP, OTP), DVD-R single/dual layer DVD+R single/double layer DVD-RW DVD+RW CD-DA CD-ROM CD-ROM/XA Photo-CD, Multi-session, Video CD CD-I FMV, CD Extra, CD Plus, CD-R, and CD-RW</p>
Loading mechanism	Drawer (Solenoid Open) Tact SW (Open) Emergency Release (draw open hole)
Power Requirement	
Input Voltage	DC 5 V +/- 5%

Combo Drive Module

Item	Specification
Manufacturer and Model	Sony NEC Optiarc BC-5500S-AR
Type	Drawer loading
Interface	SATA
Data Transfer Modes	<ul style="list-style-type: none"> • PIO mode • DMA • Ultra DMA33
Buffer Memory Size	4.5 MB
Maximum Write Speed	11 Mbytes/sec
Maximum Read Speed	9 Mbytes/sec
Formats Supported	<p>Read</p> <ul style="list-style-type: none"> • BD-Video (12cm, Single and Dual Layer), BD-ROM (12cm, Single and Dual Layer) • DVD-Video (8cm/12cm, Single and Dual Layer), DVD-ROM (8cm/12cm, Single and Dual Layer), Multi-Boarder, Multi-Session <p>CD Write</p> <ul style="list-style-type: none"> • CD-R Media (48x/40x/32x/24x/16x/8x) Mitsubishi (Verbatim), Taiyo-Yuden, Mitsui, Ricoh, Fuji film, Sony, Hitachi Maxell, Memorex, RITEK, CMC, P.V.C, JVC, SKC, ACER, Prime Disc, TDK • CD-RW Media (10x/4x) Ricoh, Mitsubishi (Verbatim), ACER, OPTROM, Memorex, P.V.C, RITEK, CMC, LEADDATA, GigaStorage, Prodisc, Fornex, Samsung, Philips <p>DVD Write</p> <ul style="list-style-type: none"> • DVD+R Media (16x/8x/4x/2.4x) Taiyo-Yuden, Mitsubishi (Verbatim), Ricoh, TDK • DVD+R Double Layer Media (8x/2.4x) Mitsubishi (Verbatim) • DVD+RW Media (8x/4x/2.4x) Mitsubishi (Verbatim), Ricoh, TDK • DVD-R Media (16x/8x/4x/2x) Mitsubishi (Verbatim), TDK, Taiyo-Yuden, PVC, Fuji Film, Ritek • DVD-R DL Media (8x/4x) Mitsubishi (Verbatim) • DVD-RW Media (6x/4x/2x/1x) JVC, PVC, Mitsubishi (Verbatim), TDK • DVD-RAM Ver2.2 Media (5x/3x/2x) Panasonic, Hitachi Maxell
Power Supply	+5V (DC)
Voltage Allowance	+5V (DC) ±5%

Thermal Control

Item	Specification
Type	MS LM95245 & Winboard
Features	<ul style="list-style-type: none"> • Thermal sensor control • Interface I2C bus, address: 98h
Power	3.3V
Package	8 pin MSOP

LCD 16"

Item	Specification			
Vendor/model name	SAMSUNG 16" WXGA Glare LTN160AT01-A02 SAMSUNG 16" WUXGA Glare LTN160HT01-A02 SAMSUNG 16" WXGA Glare LTN160AT01-A01 SAMSUNG 16" WUXGA None Glare LTN160HT01-001 SAMSUNG 16" WXGA+ None Glare LTN160AT01-1 LF			
Screen Diagonal (mm)	406.4 (16.0")			
Display Area (mm)	353.45 (H) x 198.72(V)			
Display resolution (pixels)	AT: 1366 x 768 HT: 1920 x 1080			
Pixel Pitch	AT: 0.25875 (H) x 0.25875 (V) (TYP.) HT: 0.184 (H) x 0.184 (V) (TYP.)			
Display Mode	Normally white			
Typical White Luminance (cd/m ²) (also called Brightness)	AT: 220 cd/m2 HT: 250 cd/m2			
Contrast Ratio	600			
Response Time (Optical Rise Time/Fall Time) msec	Typical 8 ms			
Input Voltage	3.3V			
Typical Power Consumption (watt)	4.5W			
Weight (with inverter)	AT: 530g HT: 580g			
Physical Size (mm)	365 (W) x 214 (H) x 6.2 (D)			
Electrical Interface	AT: Single LVDS HT: Dual LVDS			
Support Color	262,144			
Viewing Angle (degree)		Min.	Typ.	
	Horizontal	CR => 10	40	45
			40	45
	Vertical	CR => 10	10	15
			25	30
	Horizontal	CR => 100	20	25
			20	25
	Vertical	CR => 100	5	7
5			10	
Temperature Range (°C) Operating Storage (shipping)	0 to 50°C -20 to 60°C			

VGA Subsystem

Item	Specification
Type	Nvidia NB9M-GS
Features	<ul style="list-style-type: none">• Unified Shader Architecture• Support Microsoft® DirectX® 10 Shader Model 4• Geometry Instancing 2.0• SGI OpenGL® 2.0 Optimizations and support• Adaptive PCI Express Interface• High efficiency integrated adaptable and programmable Video Processor (VP2)• Integrated Bit Stream Processor (BSP)• NVIDIA PureVideo/Pure Video HD Technology• Industry Video codec standard hardware acceleration• Advanced Spatial Temporal De-Interlacing• Vibrant Color Temperature Correction• LCD Overdrive• High-Quality Real-Time Video Recording• Best quality 10-bit display pipeline• NVIDIA nView Multi Display Technology• SmartDimmer Technology• Integrated HDMI Support• Support for integrated HDCP• NVIDIA Digital Vibrance Control Technology• Integrate HDTV Encoder• Dual 400MHz RAMDACs
Power	1.0V core, 1.2V, 3.3V, 2.5V, 1.8V
Package	MXM

MXM Video Memory

Item	Specification
nVidia NB9M-GS	DDRII 256M
nVidia NB9P-GE2	DDRII 512M
nVidia NB9P-GS	GDDRIII 512M

EC/KBC

Item	Specification
Type	WINBOND WPCE775CA0DG

Item	Specification
Features	<ul style="list-style-type: none"> • Host interface, base on Intel's LPC Interface specification Revision 1.0 • PC01 REV 1.0 and ACPI 3.0 compliant • Supports Microsoft® Advanced Power Management (APM) Specifications Rev 1.2 • Share BIOS flash memory • Support for SPI flash memories • Host-controlled CIR Port • High-accuracy, high-speed ADC • Up to 84 GPIO ports (including keyboard scanning) with a variety of wake-up events • 16-bit RISC core, with up to 4 Mbytes of external address space, and running at up to 25 MHZ
Power	3.3V
Package	128 pin LQFP package

Keyboard

Item	Specification
Keyboard Controller	Winbond WPC775LDG
Total number of keypads	US: 105 UK: 106 JP: 109
Windows logo key	Yes
Internal & external keyboard work simultaneously	Plug USB keyboard to the USB port directly: Yes

Media Card Reader

Item	Specification
Type	Realtek RTS5158E
Features	<ul style="list-style-type: none"> • Support 5-in-1 Card Reader (MS, MS pro, SD, MMC, xD) • Compliant with SD Memory Card Specification Version 2.0 • Compliant with Multimedia Card Specification Version 4.1 • Compliant with Memory Stick Standard Format Specification Version 1.4 • Compliant with Memory Stick PRO Format Specification Version 1.00 • Compliant with xD Picture Card Specification Version 1.20 • Compliant with xD Picture Card Host Guideline Version 1.20
Power	3.3V
Package	LQFP48

Audio Interface

Item	Specification
Audio Controller	Realtek ALC888S Azalia Codec Amplifier GMT G1412 + G1411
Audio onboard or option	Build-in
Mono or Stereo	Stereo
Resolution	7.1
Compatibility	<ul style="list-style-type: none"> • Headphone-out with S/PDIF, Line-In and Microphone-In • 2 stereo ADCs support 16/20/24-bit PCM format recording simultaneously

Item	Specification
Sampling Rate	All DACs supports 16/20/24-bit, 44.1k/48k/96k/192kHz sample rate. All ADCs supports 16/20/24-bit, 44.1k/48k/96k/192kHz sample rate. Two independent S/PDIF-OUT converters support 16/20/24-bit, 44.1k/48k/88.2k/96k/192kHz sample rate. One for normal S/PDIF output, the other one output an independent digital stream to HDMI transmitter
Internal Microphone	Digital MICRO PHONE ZK2(HFM-M101-006-L19-G) Digital MICRO PHONE ZK2(A-OA2408FM-018)
Internal speaker/ Quantity	Two Med-High Speakers (2W/4 ohm) and one Subwoofer (3W/4 ohm)

LAN

Item	Specification
Type	Atheros AR8121
Features	<ul style="list-style-type: none"> High performance, low cost, fully integrated 10/100/1000 Mbps Ethernet controller targeting desktop and embedded applications 10/100/1000BASE-T GbE media access controller (MAC), triple-speed Ethernet physical layer transceiver (PHY), a PCI Express bus interface, and embedded buffer memory in a single device
Power	3.3V
Package	48pin QFN

CIR

Item	Specification
Type	Everlight IRM-V538/TR1
Features	<ul style="list-style-type: none"> High shielding against electric field disturbance Circular lens to improve the receive characteristic Line-up for various center carrier frequencies Low voltage and low power consumption High immunity against ambient light Photodiode with integrated circuit TTL and CMOS compatibility Side-received SMD Suitable burst length =>10 pulses/burst
Power	3.3V
Package	External dimensions 5.3(L)*3.8(W)*2.65(H)mm

Bluetooth

Item	Specification
Type	FOXCON T60H928.11 Bluetooth miniUSB module
Features	<ul style="list-style-type: none"> Chipset: Broadcom BCN2045NMD Internal Mini USB solution with antenna Bluetooth 2.0+EDR 8 wires connector for system
Power	3.3V

MDC Module

Item	Specification
Features	<ul style="list-style-type: none">• ITU-T V.92, V.90 Data Mode with auto-fallback to, V.34, V.32terbo, and V.32bis• V.42 LAPM and MNP 2-4 error correction• V.44, V.42bis and MNP 5 data compression• Send and receive rates up to 14400bps, support ITU-T V.17, V.29, V.27ter, and V.21 Ch2 fax• TIA/EIA 602 Standard for AT command set, and Fax TIA/EIA 578 Class 1 command set• DTMF and call progress monitor

Finger Print Reader

Item	Specification
Features	<ul style="list-style-type: none">• CMOS active-pixel capacitive sensing• Finger swipe speeds up to 20 cm/s• Highest image quality:<ul style="list-style-type: none">• Grayscale image depth: Full 8-bit• Sensor strip (image) width: 7.2 mm• Array size: 144 x 4 pixels• Array pitch: 50 microns• Image resolution: Up to 508 DPI • EEPROM memory interface• Advanced security features:<ul style="list-style-type: none">• Image data encryption/signing• Sensor to host authentication• Embedded unique ID number for each sensor• Robust packaging:<ul style="list-style-type: none">• Lifetime: > 10 million swipes• Protective coating on sensor surface• RoHS compliant• ESD tolerant: IEC 61000-4-2 Level 4• USB1.1 full speed I/F
Power	3.3V
Package	BGA 3 x 9, 1 mm pitch 4.75 mm x 14 mm x 1.5 mm

WLAN

Item	Specification
Chipset	<ul style="list-style-type: none">• Intel WLAN 512AN_HMWG Shirley Peak 5100 MM#895373• Intel WLAN 512AN_MMWG Shirley Peak 5100 MM#895361• Intel WLAN 533AN_HMWG Shirley Peak MM#895401• Intel WLAN 533AN_MMWG Shirley Peak MM#895362• QMI Wireless LAN Atheros AR5B91 1x2 BGN• Foxconn Wireless LAN Wireless LAN Ralink RT2700E 1x2 BGN• Intel WLAN 512AG_MMWG Shirley Peak 5100 MM#897004• Intel WLAN 533ANXMMWG Echo Peak 5350 MM#895365• Foxconn Broadcom BCM970010 Media Processor Mini-card• Link w/ H.264/VC1/MPEG2 decode Rev 1.0
Protocol	802.11a/b/g
Interface	PCI-Express

Item	Specification
Antenna	3 x3 or 2x2

Battery

Item	Specifications (3S2P)
Vendor & model name	<ul style="list-style-type: none"> SANYO AS-2007B Li-Ion 3S2P SONY AS-2007B Li-Ion 3S2P PANASONIC AS-2007B Li-Ion 3S2P SIMPLO AS-2007B Li-Ion 3S2P
Battery Type	Li-ion
Pack capacity	<ul style="list-style-type: none"> SANYO 6 cell 4400 mAh SONY 6 cell 4400 mAh PANASONIC 6 cell 4400 mAh
Number of battery cell	6
Package configuration	3 cells in series, 2 series in parallel
Normal voltage	11.1V
Charge voltage	12.6V

Item	Specifications (4S2P)
Vendor & model name	<ul style="list-style-type: none"> SANYO AS-2007B Li-Ion 4S2P SONY AS-2007B Li-Ion 4S2P PANASONIC AS-2007B Li-Ion 4S2P
Battery Type	Li-ion
Pack capacity	<ul style="list-style-type: none"> SANYO 8 cell 4800 mAh SONY 8 cell 4800 mAh PANASONIC 8 cell 4800 mAh
Number of battery cell	8
Package configuration	4 cells in series, 2 series in parallel
Normal voltage	14.8V
Charge voltage	16.8V

Subwoofer

Item	Specification
Type	MAX9763B
Features	<ul style="list-style-type: none"> Spread-Spectrum Modulation Enables Low EMI Solution Passes CE EMI Limits with Low-Cost Ferrite Bead/Capacitor Filter High 67dB PSRR at 1kHz Reduces Supply Cost 88% Efficiency Eliminates Heatsink Thermal and Output Current Protection < 1µA Shutdown Mode Mute Function
Power	Wide 8V to 28V Supply Voltage Range
Package	7mm x 7mm x 0.8mm, 32-Pin TQFN

USB Interface

Item	Specification
Chipset	Integrated with ICH9M (South Bridge)

Item	Specification
USB Compliance Level	2.0
USB Configuration	Two EHCI and Six UHCI
Number of ZK2 USB I/O ports	Two right side, one left side. One combines with eSATA

System Power Management

Item	Specification
Mech. Off (G3)	All devices in the system are turned off completely.
Soft Off (G2/S5)	OS initiated shutdown. All devices in the system are turned off completely.
Working (G0/S0)	Individual devices such as the CPU and hard disc may be power managed in this state.
Suspend to RAM (S3)	<ul style="list-style-type: none"> • CPU set power down • VGA Suspend • PCMCIA Suspend • Audio Power DownHard Disk Power Down • CD-ROM Power Down • Super I/O Low Power mode
Save to Disk (S4)	Also called Hibernation Mode. System saves all system states and data onto the disc prior to power off the whole system.

System Utilities

BIOS Setup Utility

The BIOS Setup Utility is a hardware configuration program built into your computer's BIOS (Basic Input/Output System).

Your computer is already properly configured and optimized, and you do not need to run this utility. However, if you encounter configuration problems, you may need to run Setup. Please also refer to Chapter 4 Troubleshooting when problem arises.

To activate the BIOS Utility, press **F2** during POST (when "Press <F2> to enter Setup" message is prompted on the bottom of screen).

Press **F2** to enter setup. The default parameter of F12 Boot Menu is set to "disabled". If you want to change boot device without entering BIOS Setup Utility, please set the parameter to "enabled".

Press <F12> during POST to enter multi-boot menu. In this menu, user can change boot device without entering BIOS SETUP Utility.

Navigating the BIOS Utility

There are six menu options: Information, Main, Advanced, Security, Boot, and Exit.

Follow these instructions:

- To choose a menu, use the left and right arrow keys.
- To choose an item, use the up and down arrow keys.
- To change the value of a parameter, press **F5** or **F6**.
- A plus sign (+) indicates the item has sub-items. Press **Enter** to expand this item.
- Press **Esc** while you are in any of the menu options to go to the Exit menu.
- In any menu, you can load default settings by pressing **F9**. You can also press **F10** to save any changes made and exit the BIOS Setup Utility.

NOTE: You can change the value of a parameter if it is enclosed in square brackets. Navigation keys for a particular menu are shown on the bottom of the screen. Help for parameters are found in the Item Specific Help part of the screen. Read this carefully when making changes to parameter values. **Please note that system information is subject to different models.**

Information

The Information screen displays a summary of your computer hardware information.

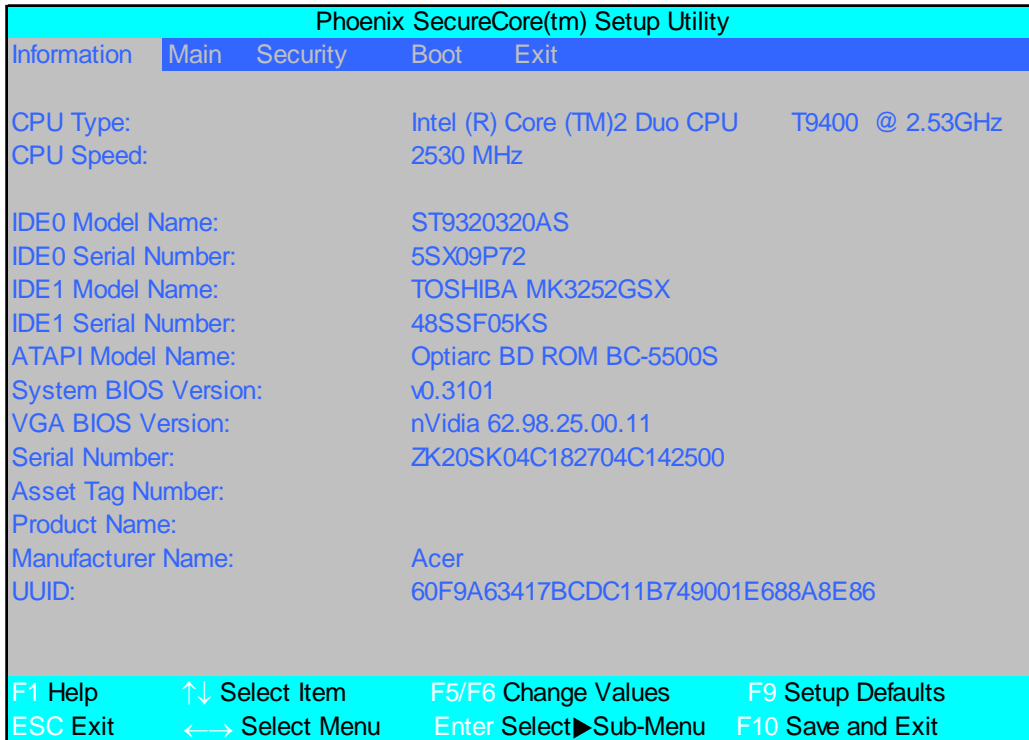

NOTE: The system information is subject to different models.

Parameter	Description
CPU Type	This field shows the CPU type and speed of the system.
CPU Speed	This field shows the speed of the CPU.
IDE0 Model Name	This field shows the model name of device installed on primary IDE master.
IDE0 Serial Number	This field displays the serial number of device installed on primary IDE master.
IDE1 Model Name	This field shows the model name of device installed on secondary IDE master.
IDE1 Serial Number	This field displays the serial number of device installed on secondary IDE master.
ATAPI Model Name	This field shows the model name of the Optical device installed in the system.
System BIOS Version	Displays system BIOS version.
VGA BIOS Version	This field displays the VGA firmware version of the system.
Serial Number	This field displays the serial number of this unit.
Asset Tag Number	This field displays the asset tag number of the system.
Product Name	This field shows product name of the system.
Manufacturer Name	This field displays the manufacturer of this system.
UUID Number	Universally Unique Identifier (UUID) is an identifier standard used in software construction, standardized by the Open Software Foundation (OSF) as part of the Distributed Computing Environment (DCE).

Main

The Main screen allows the user to set the system time and date as well as enable and disable boot option and recovery.

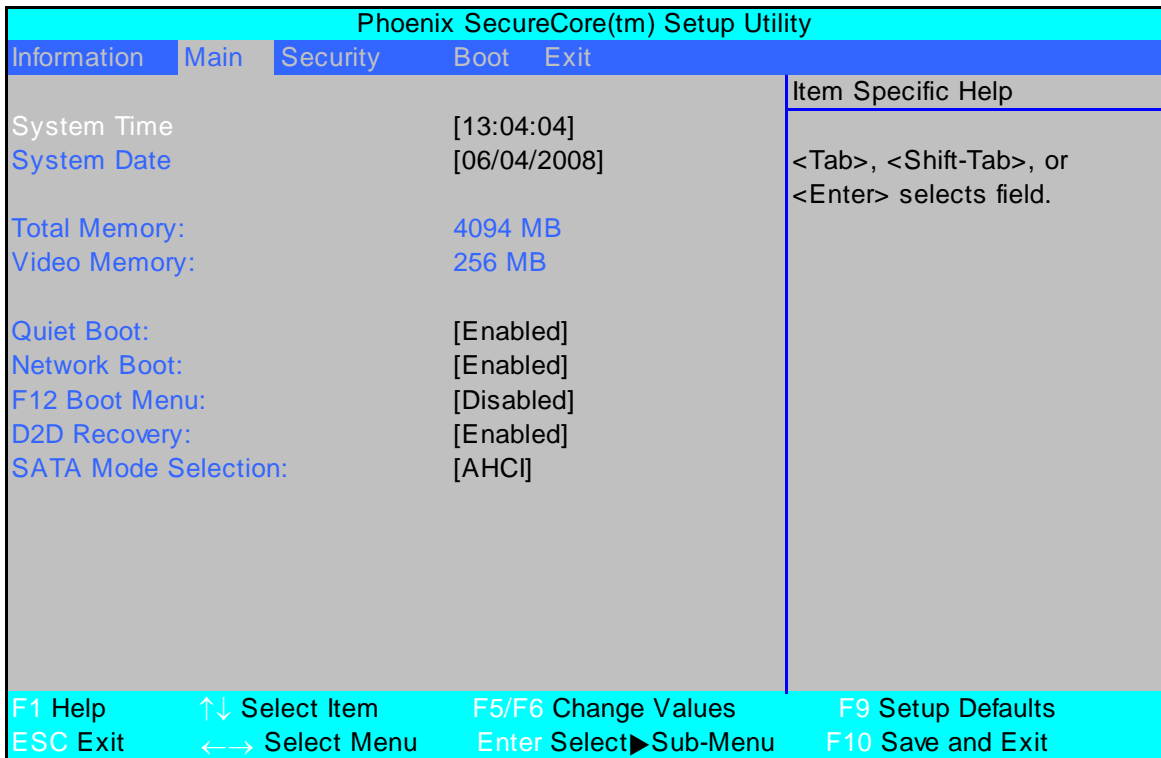

NOTE: The screen above is for your reference only. Actual values may differ.

Settings in **boldface** are the default and suggested parameter settings.

Parameter	Description	Format/Option
System Time	Sets the system time. The hours are displayed with 24-hour format.	Format: HH:MM:SS (hour:minute:second)
System Date	Sets the system date.	Format MM/DD/YYYY (month/day/year)
Total Memory	This field reports the memory size of the system. Memory size is fixed to 4094 MB.	N/A
Video Memory	Shows the Video memory size. Video Memory size is fixed to 256 MB	N/A
Quiet Boot	Select whether to display the logo screen during boot.	Option: Enabled or Disabled
Network Boot	Enables, disables the system boot from LAN (remote server).	Option: Enabled or Disabled
F12 Boot Menu	Enables, disables Boot Menu during POST.	Option: Disabled or Enabled
D2D Recovery	Enables, disables the Acer D2D Recovery function during POST by pressing Alt-F10 .	Option: Enabled or Disabled
SATA Mode Selection	Control the mode in which the SATA controller should operate.	Option: AHCI or IDE Mode

Security

The Security screen contains parameters that help safeguard and protect your computer from unauthorized use.

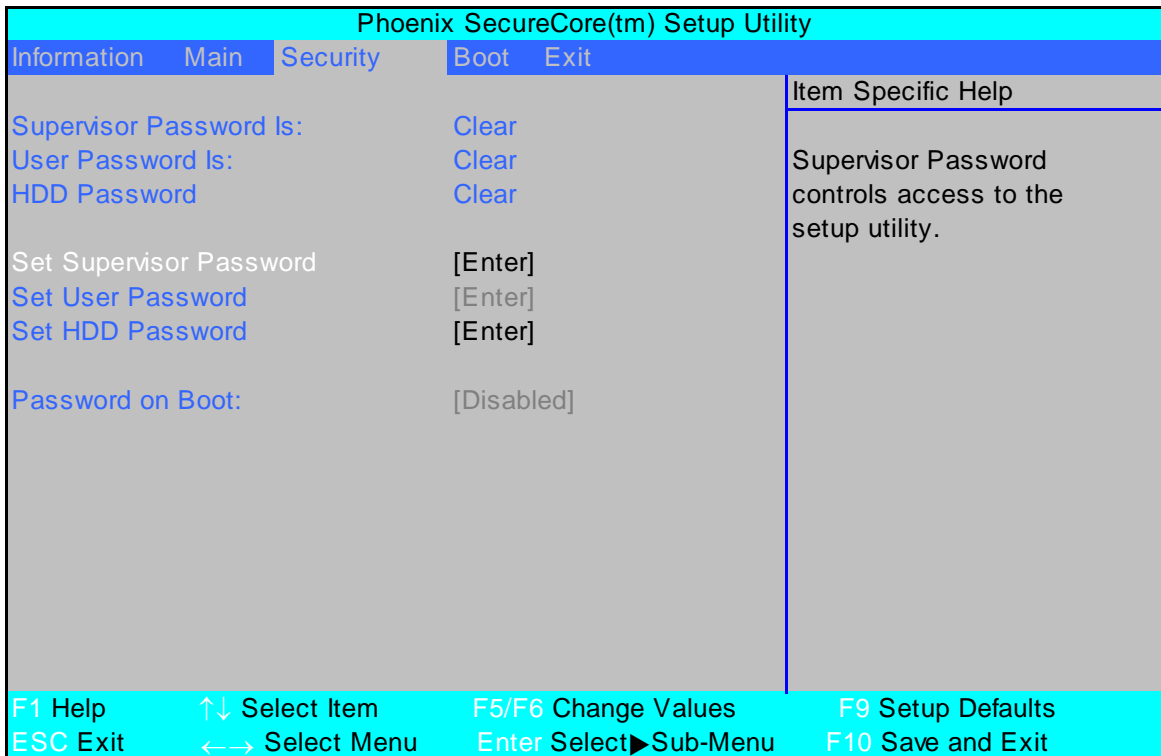

The table below describes the parameters in this screen. Settings in **boldface** are the default and suggested parameter settings.

Parameter	Description	Option
Supervisor Password Is	Shows the setting of the Supervisor password	Clear or Set
User Password Is	Shows the setting of the user password.	Clear or Set
HDD Password	Shows the setting of the hard disk password.	Clear or Set
Set Supervisor Password	Press Enter to set the supervisor password. When set, this password protects the BIOS Setup Utility from unauthorized access. The user can not either enter the Setup menu nor change the value of parameters.	
Set User Password	Press Enter to set the user password. When user password is set, this password protects the BIOS Setup Utility from unauthorized access. The user can enter Setup menu only and does not have right to change the value of parameters.	
Set HDD Password	Enter HDD Password.	
Password on Boot	Defines whether a password is required or not while the events defined in this group happened. The following sub-options are all requires the Supervisor password for changes and should be grayed out if the user password was used to enter setup.	Enabled or Disabled

NOTE: When you are prompted to enter a password, you have three tries before the system halts. Don't forget your password. If you forget your password, you may have to return your notebook computer to your dealer to reset it.

Setting a Password

Follow these steps as you set the user or the supervisor password:

1. Use the ↑ and ↓ keys to highlight the Set Supervisor Password parameter and press the **Enter** key. The Set Supervisor Password box appears:

Set Supervisor Password		
Enter New Password	[]
Confirm New Password	[]

2. Type a password in the “Enter New Password” field. The password length can not exceeds 8 alphanumeric characters (A-Z, a-z, 0-9, not case sensitive). Retype the password in the “Confirm New Password” field.

IMPORTANT: Be very careful when typing your password because the characters do not appear on the screen.

3. Press **Enter**. After setting the password, the computer sets the User Password parameter to “Set”.
4. If desired, you can opt to enable the Password on boot parameter.
5. When you are done, press F10 to save the changes and exit the BIOS Setup Utility.

Removing a Password

Follow these steps:

1. Use the ↑ and ↓ keys to highlight the Set Supervisor Password parameter and press the **Enter** key. The Set Password box appears:

Set Supervisor Password		
Enter current password	[]
Enter New Password	[]
Confirm New Password	[]

2. Type the current password in the Enter Current Password field and press **Enter**.
3. Press **Enter** twice **without** typing anything in the Enter New Password and Confirm New Password fields. The computer then sets the Supervisor Password parameter to “Clear”.
4. When you have changed the settings, press u to save the changes and exit the BIOS Setup Utility.

Changing a Password

1. Use the ↑ and ↓ keys to highlight the Set Supervisor Password parameter and press the **Enter** key. The Set Password box appears.

Set Supervisor Password		
Enter current password	[]
Enter New Password	[]
Confirm New Password	[]

2. Type the current password in the Enter Current Password field and press **Enter**.
3. Type a password in the Enter New Password field. Retype the password in the Confirm New Password field.
4. Press **Enter**. After setting the password, the computer sets the User Password parameter to “Set”.
5. If desired, you can enable the Password on boot parameter.
6. When you are done, press F10 to save the changes and exit the BIOS Setup Utility.

If the verification is OK, the screen will display as following.

Setup Notice
Changes have been saved.
[continue]

The password setting is complete after the user presses **Enter**.

If the current password entered does not match the actual current password, the screen will show you the Setup Warning.

Setup Warning
Invalid password
Re-enter Password
[continue]

If the new password and confirm new password strings do not match, the screen will display the following message.

Setup Warning
Password do not match
Re-enter Password

Boot

This menu allows the user to decide the order of boot devices to load the operating system. Bootable devices includes the USB diskette drives, the onboard hard disk drive and the DVD drive in the module bay.

Phoenix SecureCore(tm) Setup Utility				
Information	Main	Security	Boot	Exit
Boot priority order:			Item Specific Help	
1: IDE HDD: ST9320320AS			Keys used to view or configure devices:	
2: IDE CD: Optiarc BD ROM BC-5500S-(S)			Up and Down arrows select a device.	
3: PCI LAN: Atheros Boot Agent			<> and <> moves the device up or down.	
4: USB HDD:			<f> and <r> specifies the device fixed or removable.	
5: USB CDROM:			<x> exclude or include the device to boot.	
6: USB FDC:			<Shift + 1> enables or disables a device.	
7: USB KEY:			<1 - 4> Loads default boot sequence.	
8:				
Excluded from boot order:				
: IDE HDD: TOSHIBA MK3252GSX-(S5)				
F1 Help	↑↓ Select Item	F5/F6 Change Values	F9 Setup Defaults	
ESC Exit	←→ Select Menu	Enter Select	▶ Sub-Menu	F10 Save and Exit

Exit

The Exit screen allows you to save or discard any changes you made and quit the BIOS Utility.

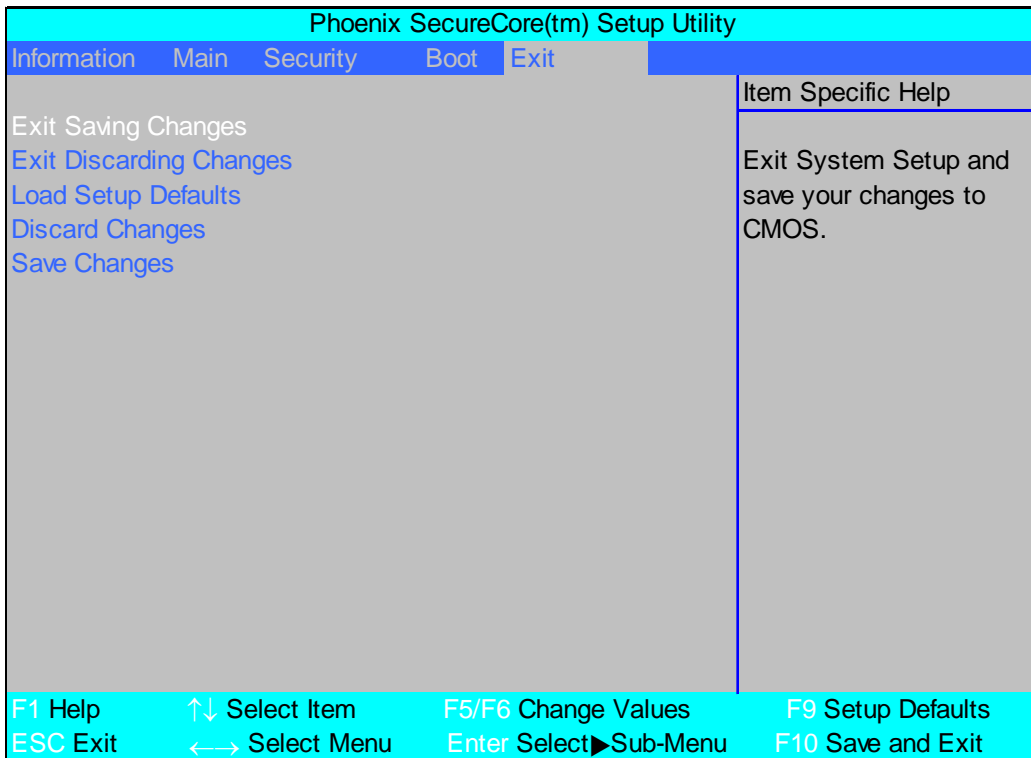

The table below describes the parameters in this screen.

Parameter	Description
Exit Saving Changes	Exit System Setup and save your changes to CMOS.
Exit Discarding Changes	Exit utility without saving setup data to CMOS.
Load Setup Default	Load default values for all SETUP item.
Discard Changes	Load previous values from CMOS for all SETUP items.
Save Changes	Save Setup Data to CMOS.

BIOS Flash Utility

The BIOS flash memory update is required for the following conditions:

- New versions of system programs
- New features or options
- Restore a BIOS when it becomes corrupted.

Use the Phlash utility to update the system BIOS flash ROM.

NOTE: Create a **Crisis Recovery Media** (such as USB HDD) before you use the Phlash utility.

NOTE: Do not install memory-related drivers (XMS, EMS, DPMI) when you use the Phlash.

NOTE: Please use the AC adaptor power supply when you run the Phlash utility. If the battery pack does not contain enough power to finish BIOS flash, the system will not boot as the BIOS is not loaded.

Perform the following steps to use the Flash Utility:

1. Press F2 during boot to enter the Setup Menu.
2. Select **Boot Menu** to modify the boot priority order, for example, if using USB HDD to Update BIOS, move USB HDD to position 1.

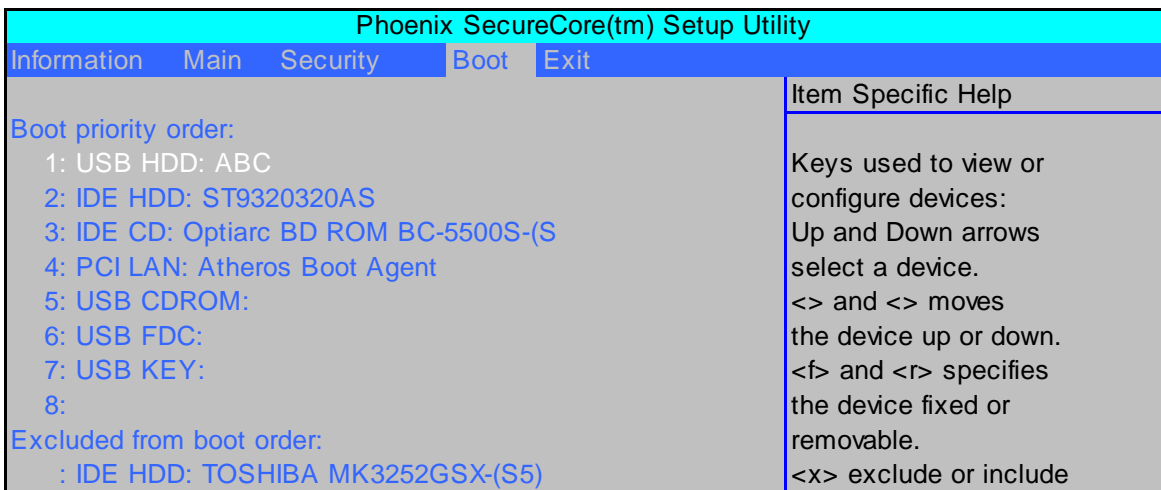

3. Execute the **IFLASH.BAT** batch file to update BIOS (Read xxxxx.fd to Memory).



4. In flash BIOS, the message **Please do not remove AC Power Source** displays.

NOTE: If the AC power is not connected, the following message displays.

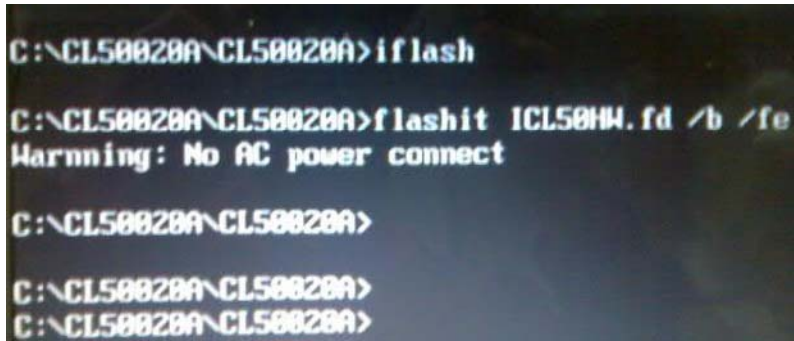

```
C:\CL50020A\CL50020A>iflash
C:\CL50020A\CL50020A>flashit ICL50HW.fd /b /fe
Warning: No AC power connect
C:\CL50020A\CL50020A>
C:\CL50020A\CL50020A>
C:\CL50020A\CL50020A>
```

Plug in the AC power to continue.

5. Flash is complete when the following message displays.



```
File loading 100 %
Current BIOS Model name :
New BIOS Model name :
Current BIOS version: V0.18.T04
New BIOS version: V0.20
Updating Block at FFFF0000
Flash complete !
```

6. Shutdown or reboot base on iflash.bat command.

Remove HDD/BIOS Utility

This section provide you with removing HDD/BIOS method:

Remove HDD Password:

- If you key in wrong HDD password three times, Hdd password error code displays. See the image below.

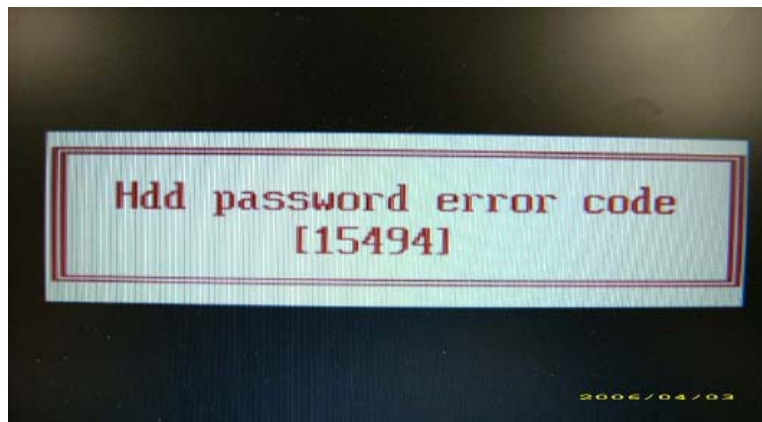

To reset the HDD password, run HDD_PW.EXE as follows:

1. Key in **hdd_pw 15494 0**
2. Press 2.
3. Select one upper-case string from the list.

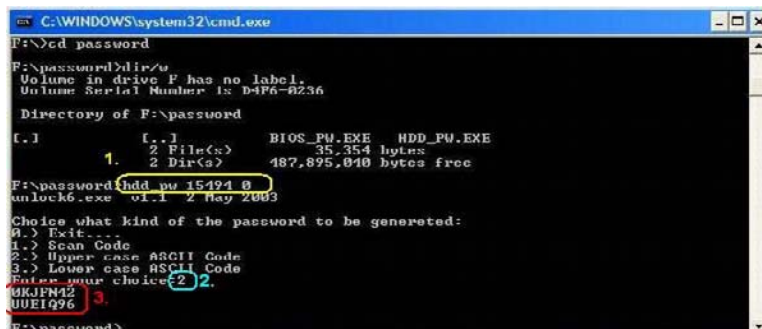

4. Reboot system and key in the selected string (0KJFN42 or UVEIQ96) on the HDD User Password screen.



Remove BIOS Password:

If you key in the wrong Supervisor Password three times, System Disabled displays on the screen. See the image below.

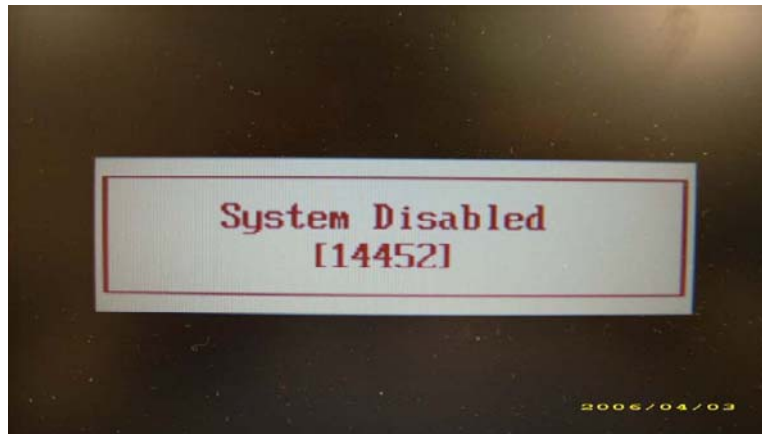

To reset the BIOS password, run BIOS_PW.EXE as follows:

1. Key in **bios_pw 14452 0**
2. Select one string from the list.

```
C:\WINDOWS\system32\cmd.exe
Microsoft Windows XP [Version 5.1.2600]
Copyright 1985-2001 Microsoft Corp.
C:\Documents and Settings\M54>d:
D:\>bios_pw 14452 0 1.
unlock6.exe v1.0 1 July 1997
qj119900
0?yqmjd
c.jl14tm
6mbzjaj 2.
D:\>_
```

-
3. Reboot the system and key in the selected string (qjig9vy, 07yqmjd etc.) for the BIOS user password.



Machine Disassembly and Replacement

This chapter contains step-by-step procedures on how to disassemble the notebook computer for maintenance and troubleshooting.

Disassembly Requirements

To disassemble the computer, you need the following tools:

- Wrist grounding strap and conductive mat for preventing electrostatic discharge
- Flat screwdriver
- Philips screwdriver
- Plastic flat screwdriver
- Plastic tweezers

NOTE: The screws for the different components vary in size. During the disassembly process, group the screws with the corresponding components to avoid mismatch when putting back the components.

General Information

Pre-disassembly Instructions

Before proceeding with the disassembly procedure, make sure that you do the following:

1. Turn off the power to the system and all peripherals.
2. Unplug the AC adapter and all power and signal cables from the system.



3. Place the system on a flat, stable surface.
4. Remove the battery pack.

Disassembly Process

The disassembly process is divided into the following stages:

- External module disassembly
- Main unit disassembly
- LCD module disassembly

The flowcharts provided in the succeeding disassembly sections illustrate the entire disassembly sequence. Observe the order of the sequence to avoid damage to any of the hardware components. For example, if you want to remove the main board, you must first remove the keyboard, then disassemble the inside assembly frame in that order.

Main Screw List

Screw	Quantity	Part Number
M2.5*6.5-I (BZN)(NYLOK-RED))	42	86.ARE07.001
M2.0*3.0-I (BKAG)(NYLOK) IRON	10	86.ARE07.002
M2.0*3.0-I-NI-NYLOK	13	86.A08V7.005
M3*0.5+3.5I	8	86.TDY07.003
M2.5*2.5-I (NI)(NYLOK)	6	86.T25V7.010
M2.5*4.0-I (NI)(NYLOK)	7	86.D01V7.001
M2.5*5-I (BNI)(NYLOK)	4	86.A03V7.003
M2.5*8-I BNI NYLOK	4	86.T48V7.001

External Module Disassembly Process

External Modules Disassembly Flowchart

The flowchart below gives you a graphic representation on the entire disassembly sequence and instructs you on the components that need to be removed during servicing. For example, if you want to remove the main board, you must first remove the keyboard, then disassemble the inside assembly frame in that order.

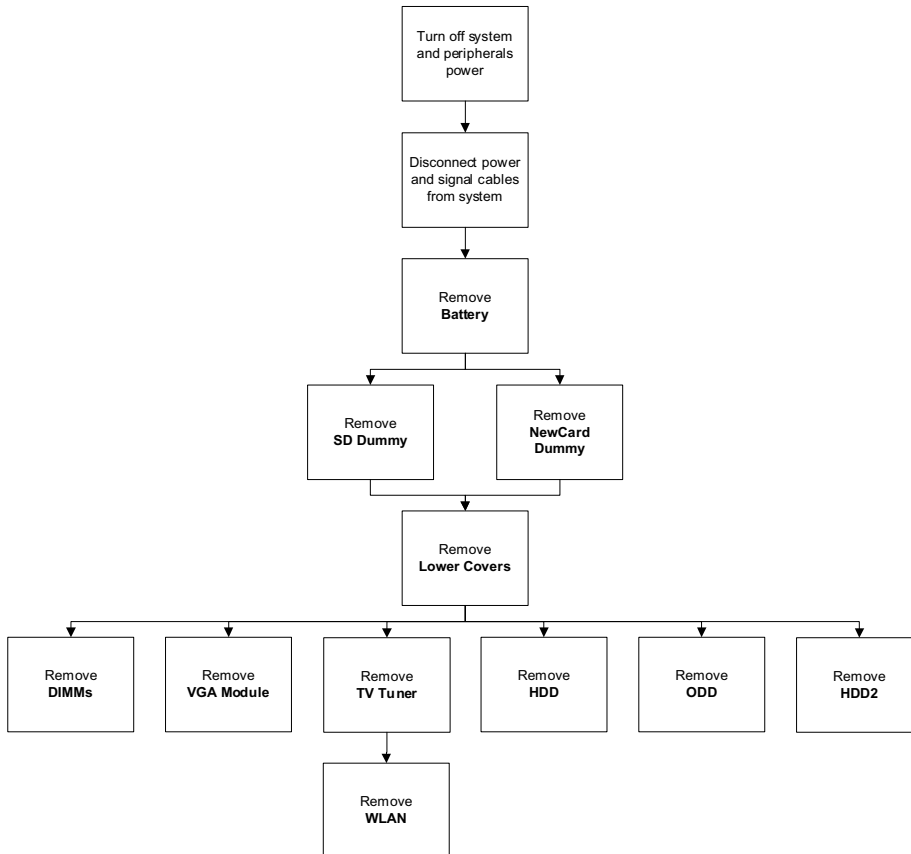

Screw List

Step	Screw	Quantity	Part No.
VGA Module	M2.5*8-I BNI NYLOK	4	86.T48V7.001
TV Tuner	M2.0*3.0-I (BKAG) (NYLOK) IRON	2	86.ARE07.002
WLAN Module	M2.0*3.0-I-NI-NYLOK	2	86.A08V7.005
Main HDD Carrier	M3*0.5+3.5I	4	86.TDY07.003
ODD Module	M2.5*6.5-I (BZN(NYLOK-RED)	1	86.ARE07.001
ODD Bracket	M2.0*3.0-I (BKAG) (NYLOK) IRON	2	86.ARE07.002
HDD2 Module	M2.0*3.0-I (BKAG) (NYLOK) IRON	2	86.ARE07.002
HDD2 Carrier	M3*0.5+3.5I	4	86.TDY07.003

Removing the Battery Pack

1. Turn computer over.
2. Slide the battery lock/unlock latch to the unlock position.



3. Slide and hold the battery release latch to the release position (1), then slide out the battery pack from the main unit (2).

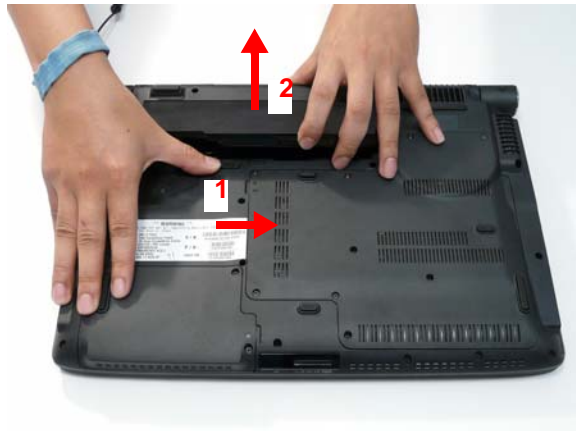

Removing the SD dummy card

1. Push the SD dummy card all the way in to eject it.



2. Pull it out from the slot.



Removing the ExpressCard dummy card

1. Push the ExpressCard all the way in to eject the ExpressCard dummy.



2. Pull it out from the slot.



Removing the Lower Covers

1. See "Removing the Battery Pack" on page 50.
2. See "Removing the SD dummy card" on page 51.
3. See "Removing the ExpressCard dummy card" on page 52.
4. Loosen the captive screws in the covers as shown.

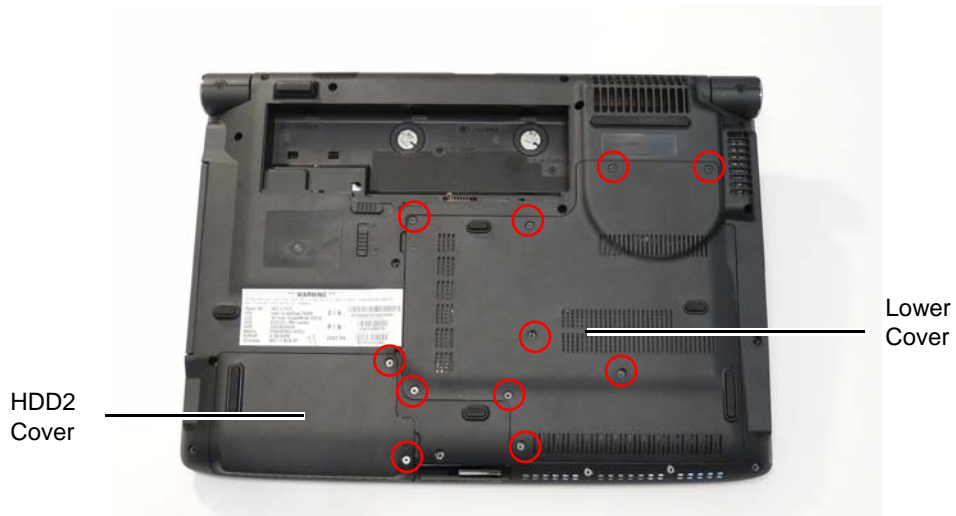

5. Carefully open the Lower Cover.



6. Remove the HDD2 Cover as shown.



Removing the DIMM Modules

1. See "Removing the Battery Pack" on page 50.
2. Remove the Lower Cover See "Removing the Lower Covers" on page 53.
3. Push out the release latches on both sides of the DIMM socket to release the DIMM module.



4. Remove the DIMM module.

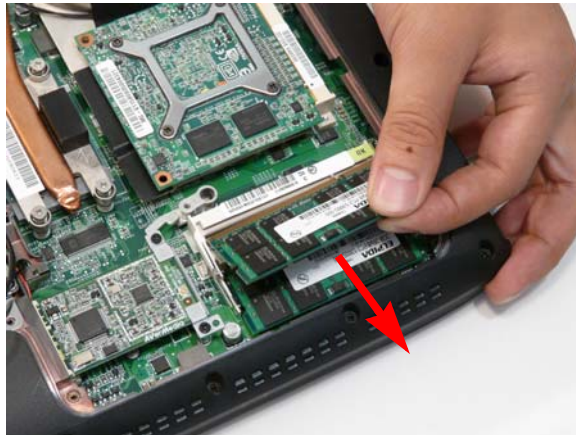

5. Repeat steps for the second DIMM module.

Removing the VGA Module

1. Remove Lower Cover. See "Removing the Lower Covers" on page 53.
2. Remove the four securing screws from the VGA Module.

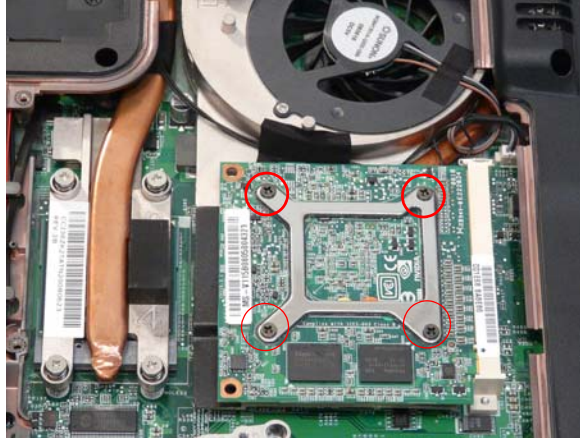

Step	Size	Quantity	Screw Type
VGA Module	M2.5*8-I BNI NYLOK	4	

3. Grasp the VGA module and pull to remove.

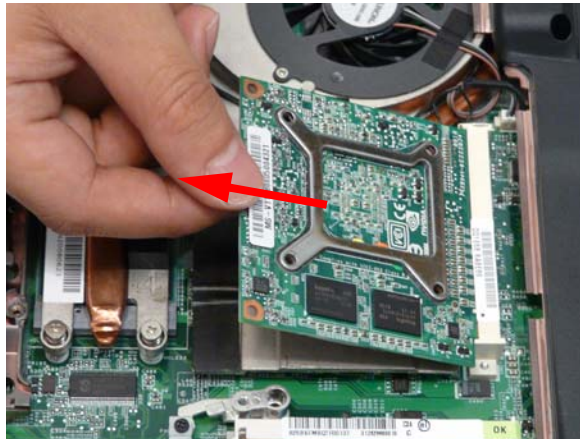

Removing the TV Tuner Module

1. See "Removing the Battery Pack" on page 50.
2. Remove the Lower cover. See "Removing the Lower Covers" on page 53.
3. Disconnect the antenna cable from the TV Tuner board as shown.

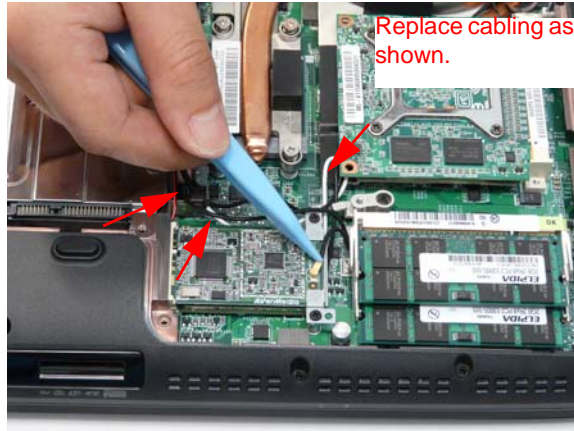

NOTE: To ensure proper assembly, the antenna cable must be installed as shown.

4. Move the antenna cables away and remove the two screws to release the TV Tuner module and bracket assembly.

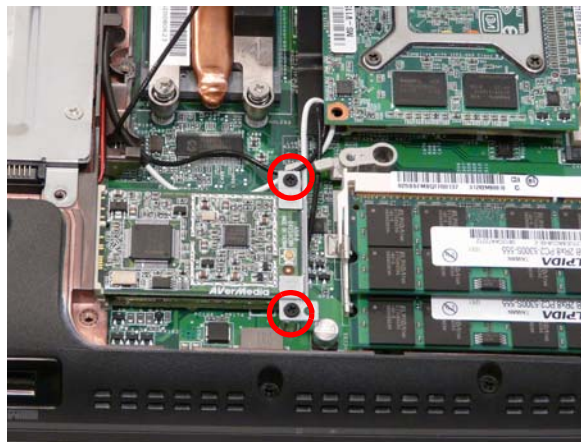

Step	Size	Quantity	Screw Type
TV Tuner Module	M2.0*3.0-I(BKAG)(NYLOK) IRON	2	

5. Detach the TV Tuner module by grasping the assembly and pulling away as shown.

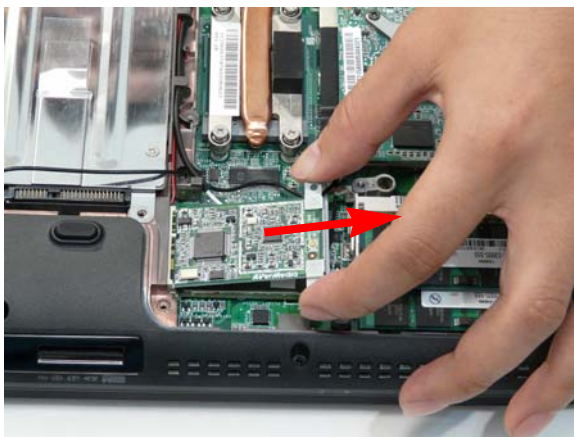

6. Grasp the module and pull the bracket away.

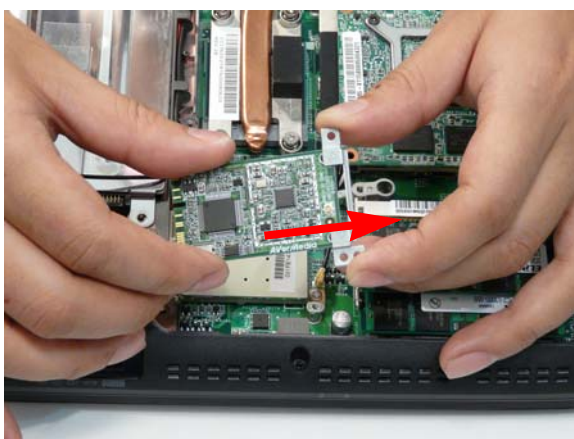

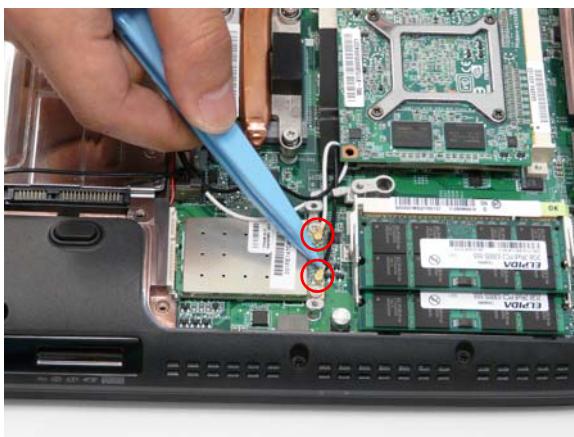

Removing the WLAN Module

1. Remove the TV Tuner module. See "Removing the TV Tuner Module" on page 56.
2. Disconnect the two antenna cables.

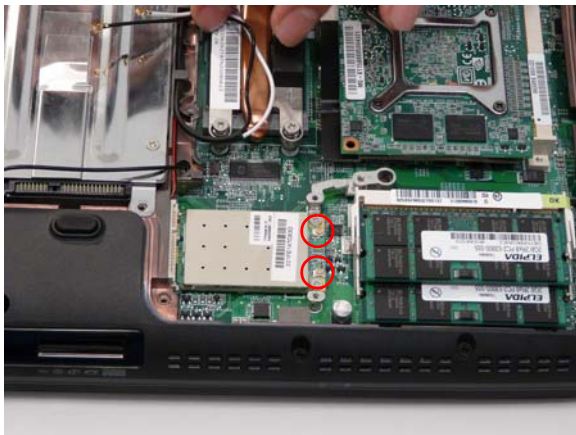

3. Remove the two securing screws.



Step	Size	Quantity	Screw Type
WLAN Module	M2.0*3.0-I-NI-NYLOK	2	

4. Remove the WLAN module as shown.

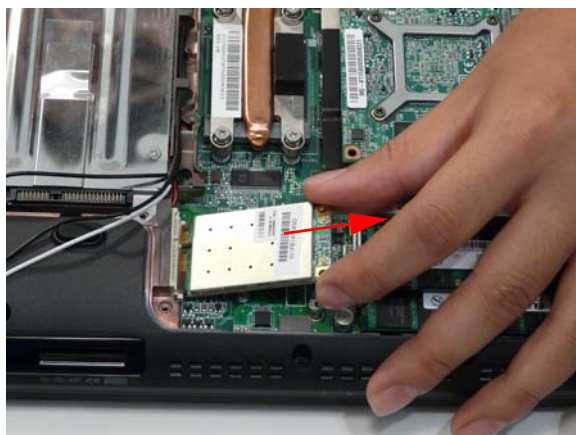

Removing the Main Hard Disk Drive Module

1. See "Removing the Battery Pack" on page 50.
2. Remove the Lower Cover. See "Removing the Lower Covers" on page 53.
3. Hold the Pull Tab and slide the HDD away from the connector. Pull the HDD up as shown to remove.

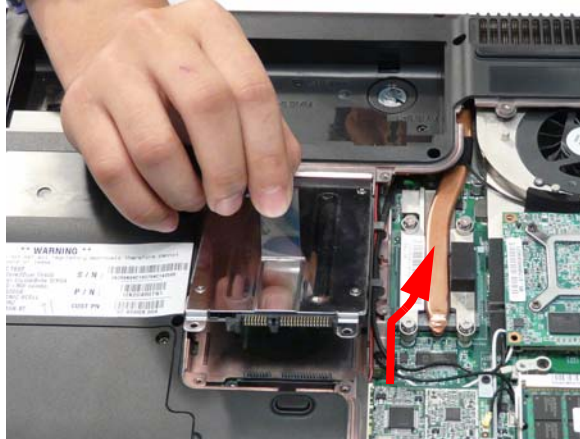

NOTE: To prevent damage to HDD, avoid pressing down on it or placing heavy objects on top of it.

4. Remove the four screws securing the HDD to the carrier.

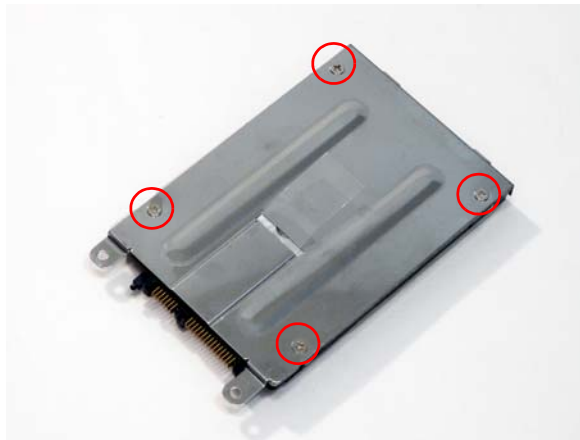

Step	Size	Quantity	Screw Type
HDD Carrier	M3*0.5+3.5l	4	

5. Lift the HDD carrier to remove.



6. Grasp the HDD connector and pull firmly to remove.

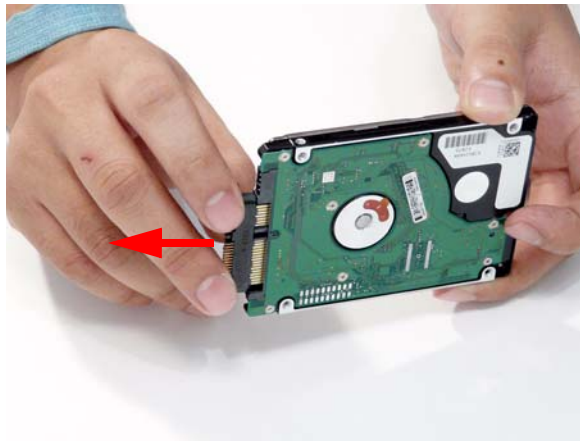

Removing the Optical Disk Drive Module

1. See "Removing the Battery Pack" on page 50.
2. Remove the Lower Cover. See "Removing the Lower Covers" on page 53.
3. Remove the screw securing the ODD module.



Step	Size	Quantity	Screw Type
ODD Module	M2.5*6.5-I (BZN(NYLOK-RED))	1	

4. Grasp the ODD module as shown and pull out of the bay.



5. Remove the two screws securing the ODD bracket and remove the ODD bracket from the optical disk drive module.



Step	Size	Quantity	Screw Type
ODD Bracket	M2.0*3.0-I (BKAG) (NYLOK) IRON	2	

6. Insert a pin in the eject hole of the ODD to eject the ODD tray.

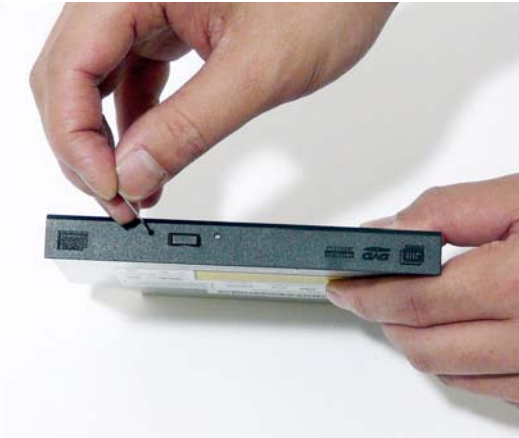

7. Press down on the locking catch to release the ODD cover and remove.

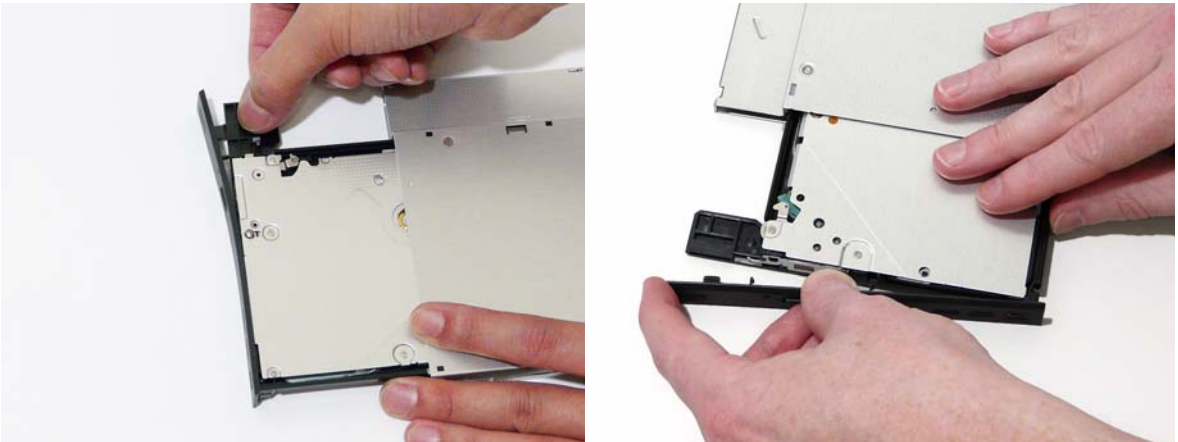

Removing the Secondary Hard Disk Drive Module

1. Remove the Battery. See "Removing the Battery Pack" on page 50.
2. Remove the HDD2 Cover. See "Removing the Lower Covers" on page 53.
3. Remove the two securing screws from the HDD.



Step	Size	Quantity	Screw Type
HDD2 Carrier	M2.0*3.0-I (BKAG) (NYLOK) IRON	2	

4. Grasp the Pull Tab and pull the HDD out of the bay as shown.



5. Remove the four screws securing the HDD to the carrier.



Step	Size	Quantity	Screw Type
HDD2 Carrier	M3*0.5+3.5l	4	

6. Lift the HDD carrier to remove.

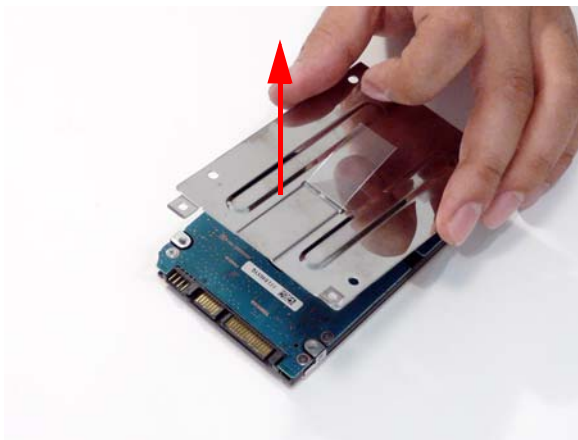

Main Unit Disassembly Process

Main Unit Disassembly Flowchart

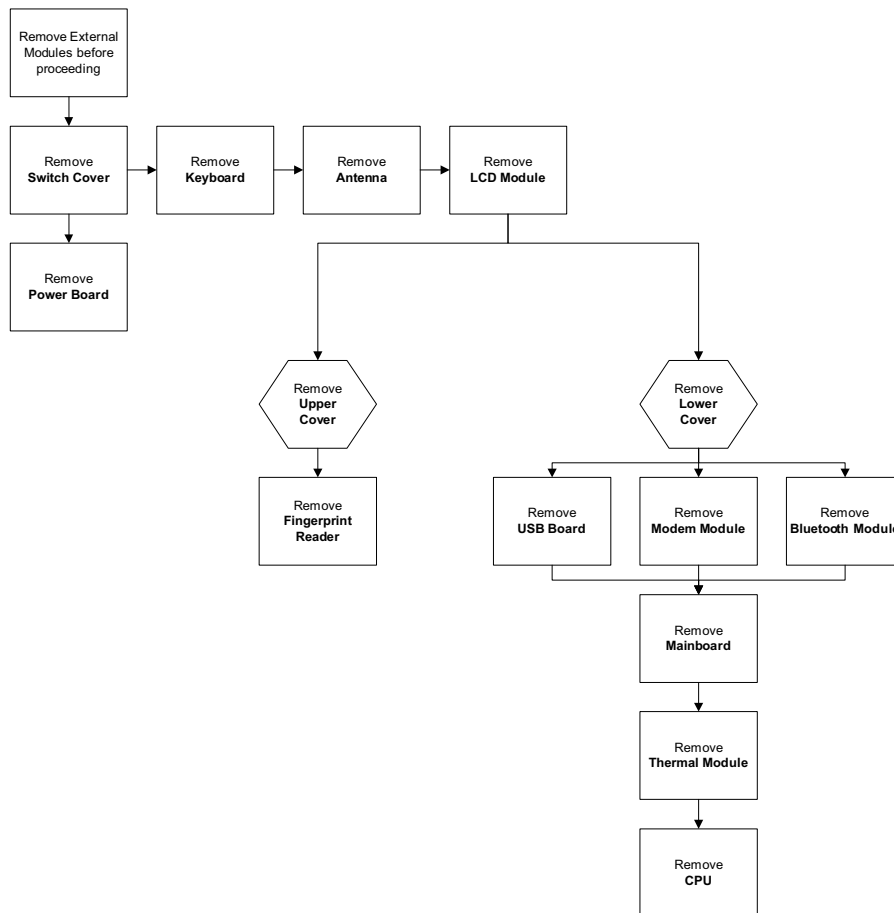

Screw List

Step	Screw	Quantity	Part No.
Switch Cover	M2.5*6.5-I (BZN)(NYLOK-RED)	10	86.ARE07.001
Power Board	M2.0*3.0-I (BKAG) (NYLOK) IRON	3	86.ARE07.002
Speaker Module	M3*3 (not available for order)	3	N/A
	M2.5*4.0-I (NI)(NYLOK)	2	86.D01V7.001
LCD Module	M2.5*5-I (BNI)(NYLOK)	4	86.A03V7.003
Upper Cover	M2.0*3.0-I-NI-NYLOK	5	86.A08V7.005
	M2.5*6.5-I (BZN)(NYLOK-RED)	11	86.ARE07.001
	M2.5*6.5-I (BZN)(NYLOK-RED)	10	86.ARE07.001
F/P Reader	M2.0*3.0-I-NI-NYLOK	3	86.A08V7.005
USB Board	M2.0*3.0-I (BKAG) (NYLOK) IRON	1	86.ARE07.002
Modem Module	M2.0*3.0-I-NI-NYLOK	2	86.A08V7.005
Bluetooth Module	M2.0*3.0-I-NI-NYLOK	1	86.A08V7.005
Mainboard	M2.5*4.0-I (NI)(NYLOK)	3	86.D01V7.001
Thermal Module	M2.5*4.0-I (NI)(NYLOK)	2	86.D01V7.001

Removing the Switch Cover

CAUTION: Using tools to remove the Switch Cover may cause damage to the outer casing. It is recommended that only fingers are used to remove the Switch Cover.

1. See "Removing the Battery Pack" on page 50.
2. Place the computer on a clean dry surface.
3. Locate and remove the ten securing screws on the bottom of the computer.



Step	Size	Quantity	Screw Type
Switch Cover	M2.5*6.5-I (BZN(NYLOK-RED))	10	

4. Turn the computer over and open the LCD module to expose the Switch Cover.

IMPORTANT:The LCD module does not fully extend. Damage will occur if you attempt to extend the LCD module beyond the manufacturer's design.

5. Lift the Switch Cover as shown, and place over the keyboard.

IMPORTANT:Do not remove at this point. FFC cables are still attached on the underside.



6. Disconnect the two FFC cables as shown.

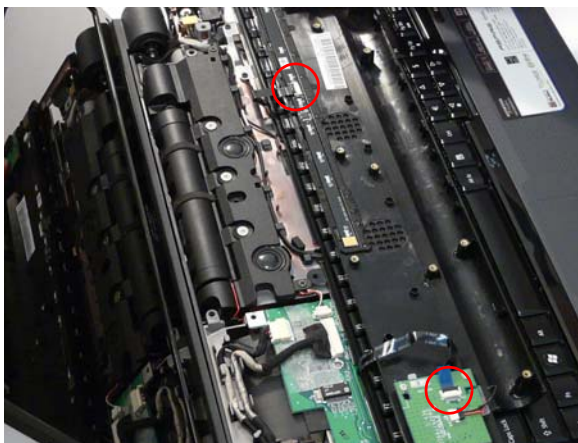

7. Lift the Switch Cover clear of the chassis.

Removing the Power Board

1. See "Removing the Battery Pack" on page 50.
2. Expose the bottom side of the Switch Cover. See "Removing the Switch Cover" on page 66.
3. Unlock the connector to remove the FFC cable.

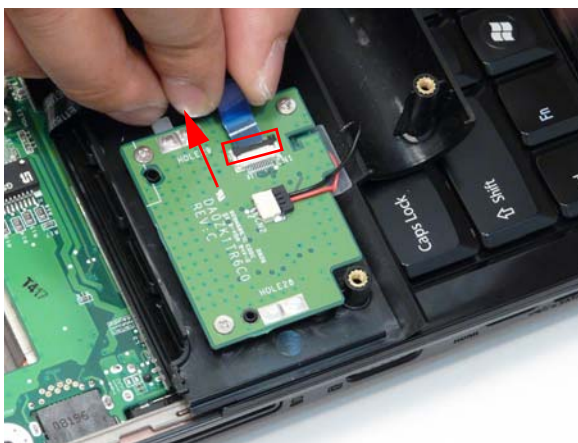

4. Grasp the cable and disconnect from the Power Board.

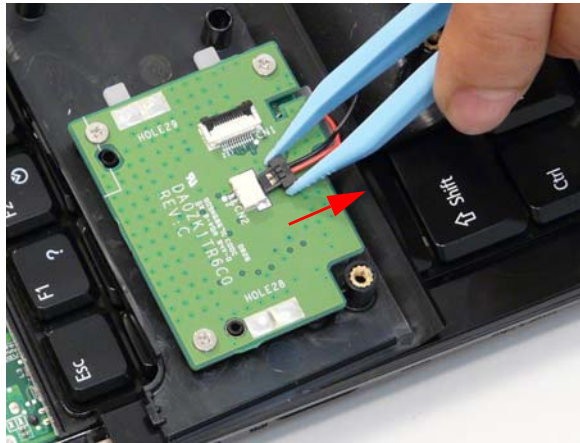

5. Remove the three securing screws from the Power Board.

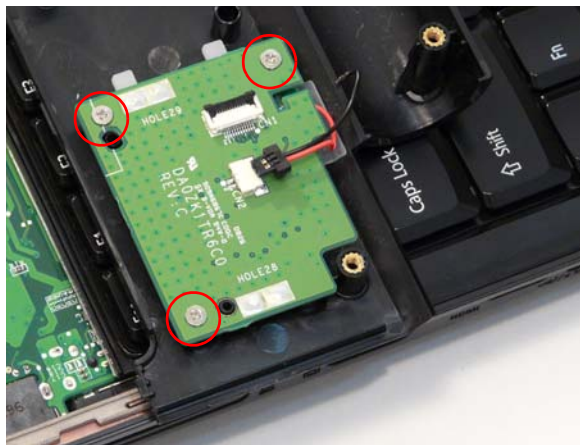

Step	Size	Quantity	Screw Type
Power Board	M2.0*3.0-I (BKAG) (NYLOK) IRON	3	

6. Hold the module by the sides and lift to remove.

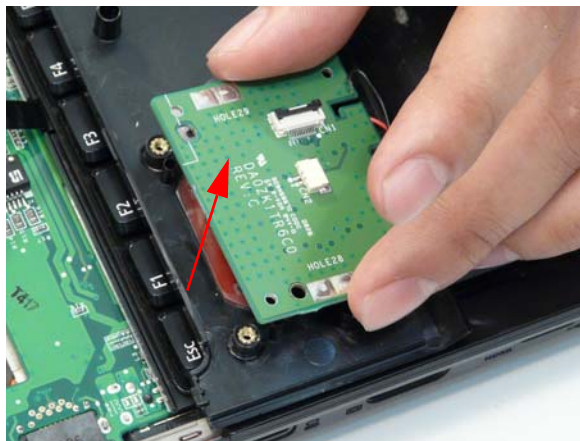

Removing the Keyboard

1. Remove the Switch Cover. See “Removing the Switch Cover” on page 66.
2. Lift and turn the keyboard over (as shown) to expose the FFC.



3. Unlock the connector and pull the FFC to remove.

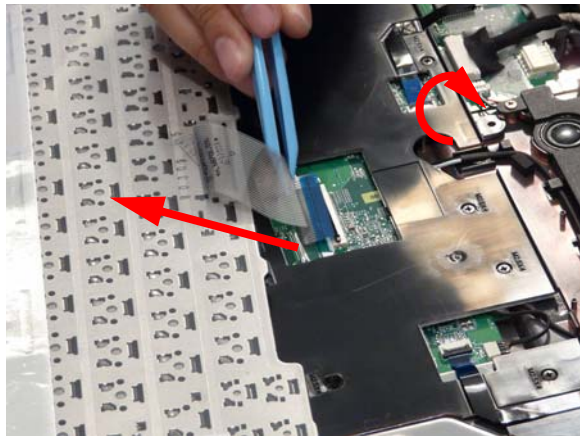



4. Remove the keyboard from the chassis.

Removing the Speaker Module

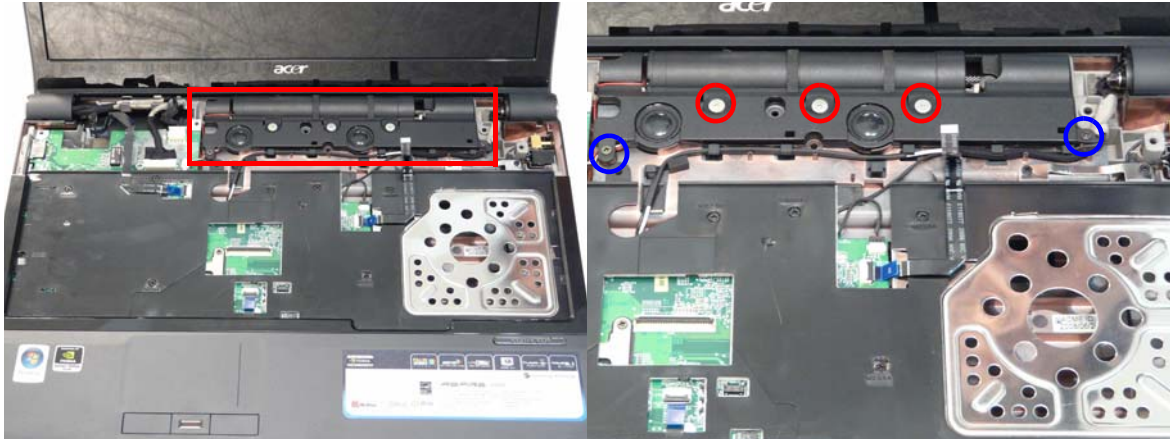
1. Remove the Keyboard. See "Removing the Keyboard" on page 69.
2. Remove the three securing screws (red in the following image) from the Subwoofer Module.
3. Remove the two securing screws (blue in the following image) the Speaker Module.



Step	Size	Quantity	Screw Type
Subwoofer Module (red callout)	M3*3 (not available for order)	3	
Speaker Module (blue callout)	M2.5*4.0-I (NI)(NYLOK)	2	

4. Disconnect the speaker cable as shown.

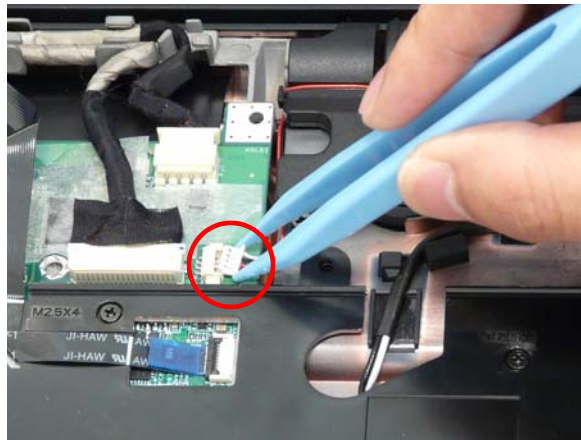

5. Grasp the Subwoofer Module from the RIGHT side as shown and tilt over and to the left, as shown.

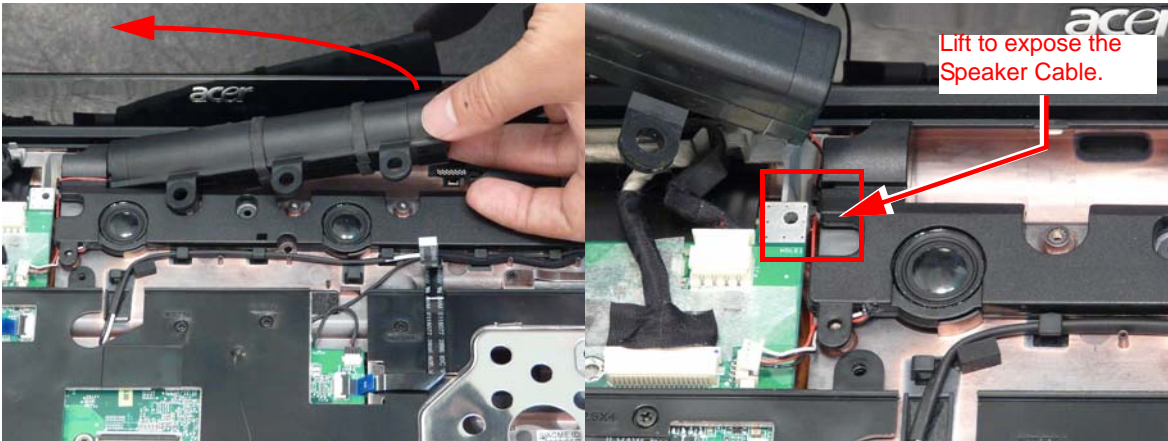

NOTE: The Subwoofer Module is not a replaceable part. Do NOT remove from the computer.

6. Grasp the Speaker Module by the right side and tilt up to remove.

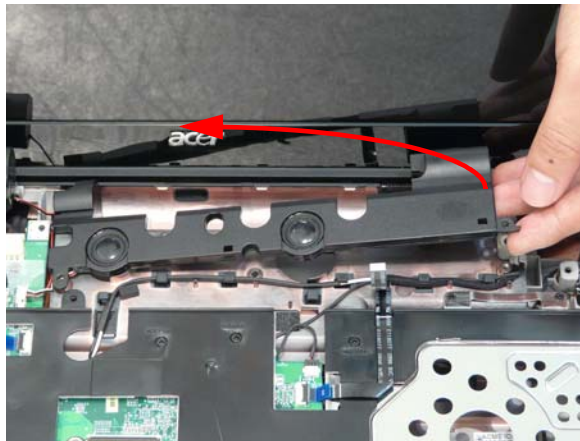

Removing the Antenna Cables

1. Remove the Lower Cover. See "Removing the Lower Covers" on page 53.
1. Remove the Speaker Module. See "Removing the Speaker Module" on page 70.
2. Turn the computer upside down, and disconnect the Antenna Cables from the WLAN module.

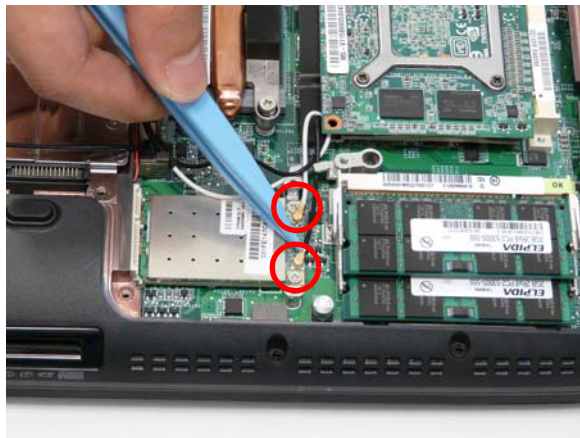

3. Pull back the cables away and out of the housing well.

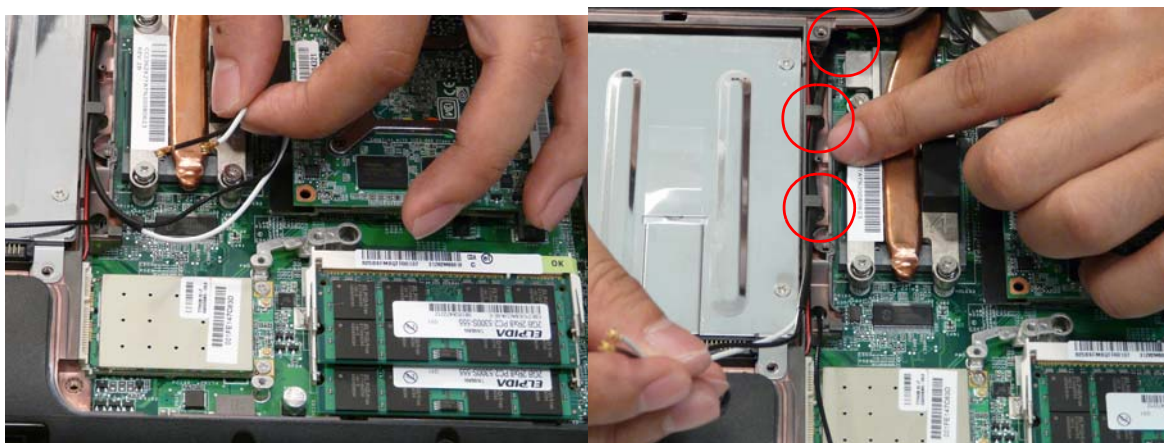

4. Turn the computer over (upper base facing up) to expose the Antenna cables.

5. After removing the Speaker Modules, grasp the Antenna cables sitting underneath. Pull through.

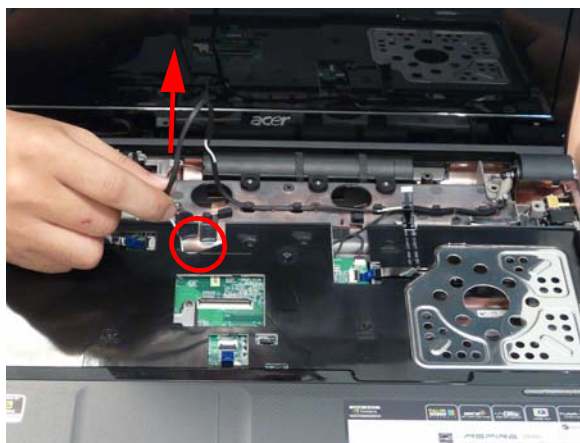

6. Continue to remove the cables until they are completely out of the housing well.

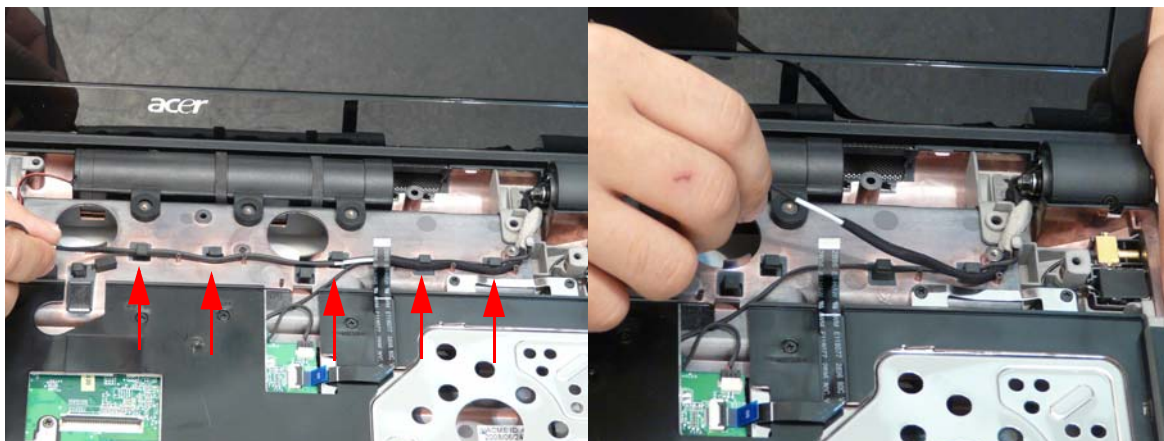

NOTE: Place the cables to one side to avoid damage.

Removing the LCD Module

1. Disconnect the Antenna cables. See "Removing the Antenna Cables" on page 71.
2. Disconnect the LCD and Power cables.

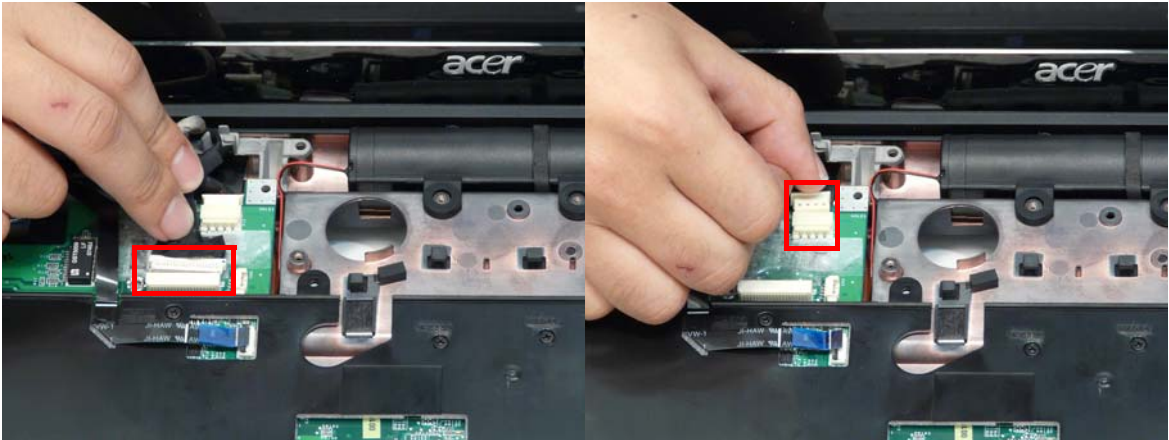

3. Remove the four securing screws (two on each hinge) from the LCD hinges.

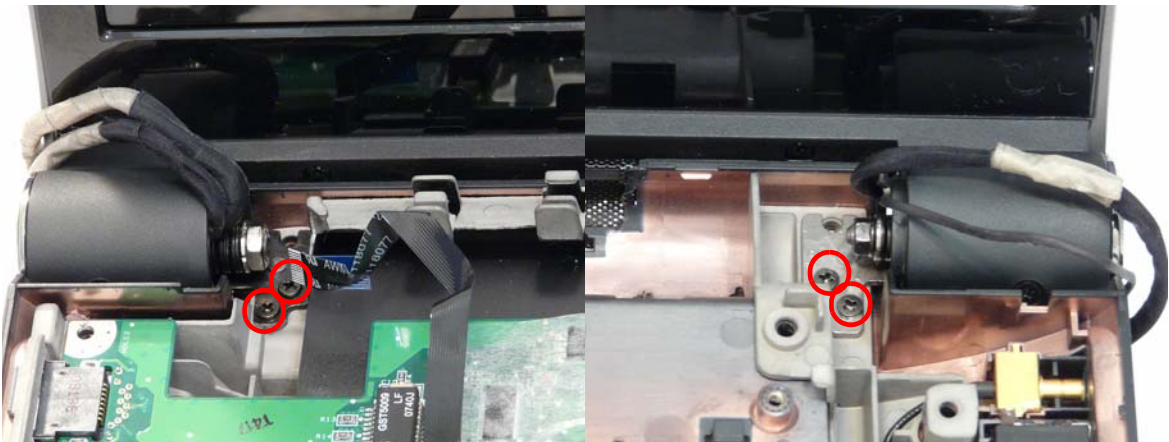

Step	Size	Quantity	Screw Type
LCD Module	M2.5*5-I (BNI)(NYLOK)	4	

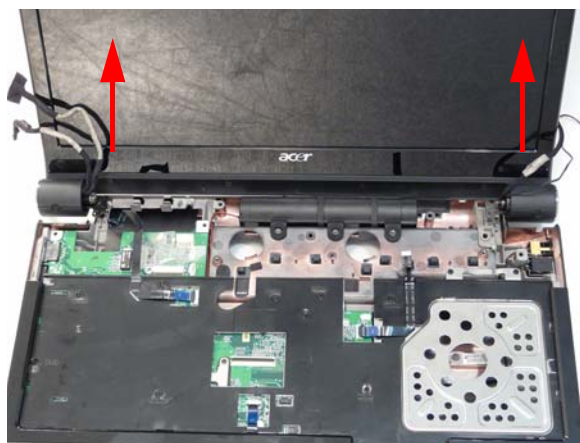

4. Carefully remove the LCD module from the chassis.



Removing the Upper Base

1. Remove the LCD module. See "Removing the LCD Module" on page 73.
2. Turn the computer over. Remove the ten screws on the bottom panel.



Step	Size	Quantity	Screw Type
Upper Cover (Red call out)	M2.0*3.0-I-NI-NYLOK	2	
Upper Cover (Blue call out)	M2.5*6.5-I (BZN(NYLOK-RED))	11	

3. Turn the computer over and disconnect the three FFC cables from the mainboard.



Unlock the connector and disconnect A as shown.

Unlock the connector and disconnect B as shown.

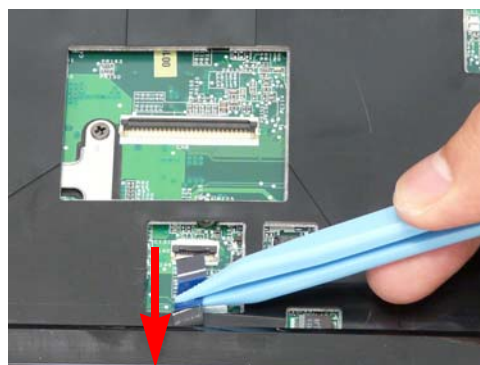
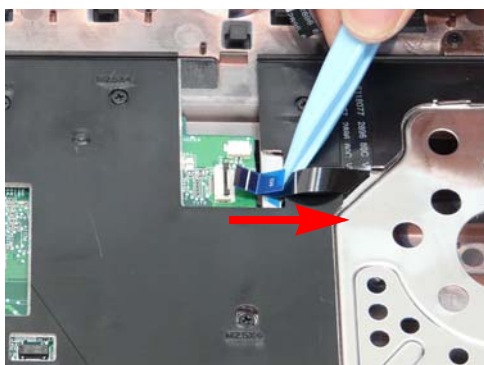

Unlock the connector and disconnect C as shown.

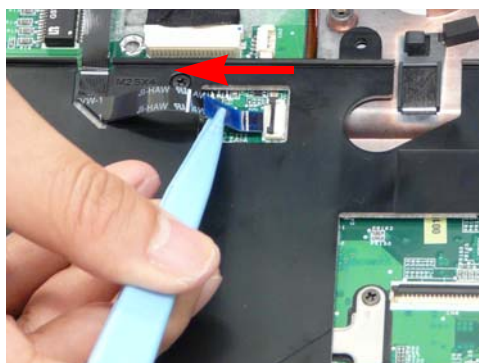

4. Remove the ten securing screws on the top panel.

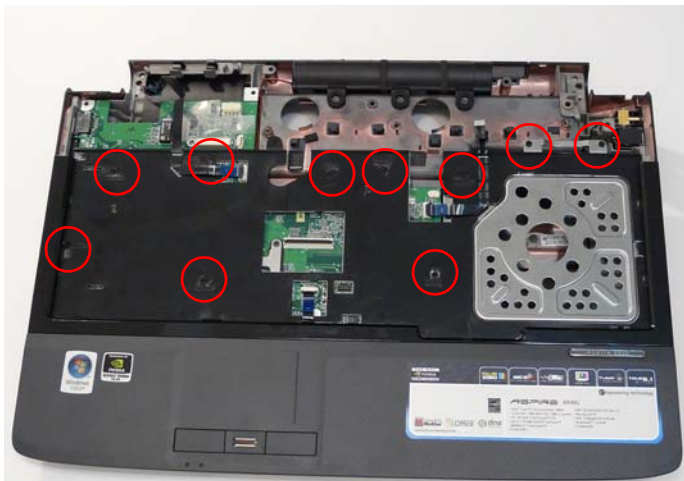

Step	Size	Quantity	Screw Type
Upper Cover	M2.5*6.5-I (BZN(NYLOK-RED))	10	

WARNING: Care must be taken when removing the Upper Base from the Lower Base to prevent damage or stress to the surface.

5. Grasp the upper base by the sides and gently lift to remove.



Removing the Finger Print Reader

1. Remove the Upper Base. See “Removing the Upper Base” on page 74.
2. Unlock the securing latch and disconnect the Touch Pad FFC.

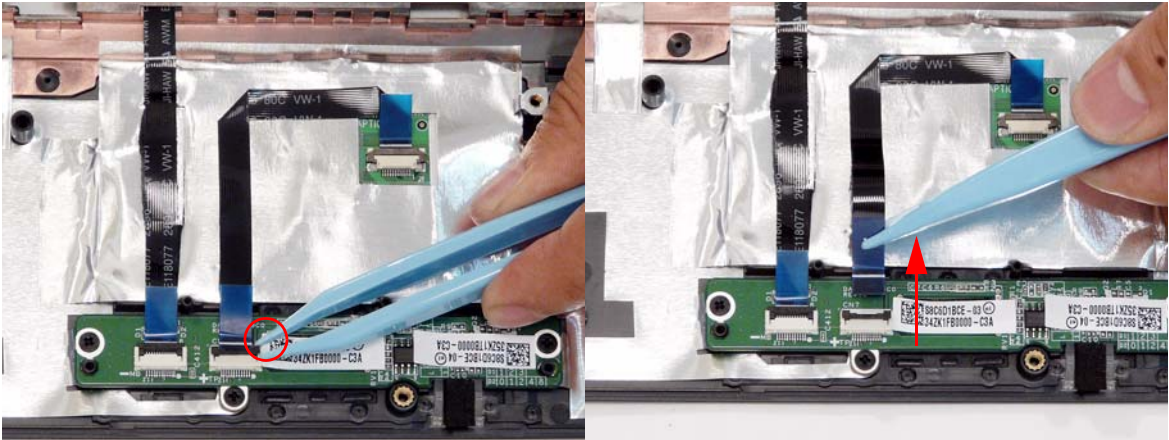

3. Unlock the securing latch and disconnect the Finger Print Reader FFC.

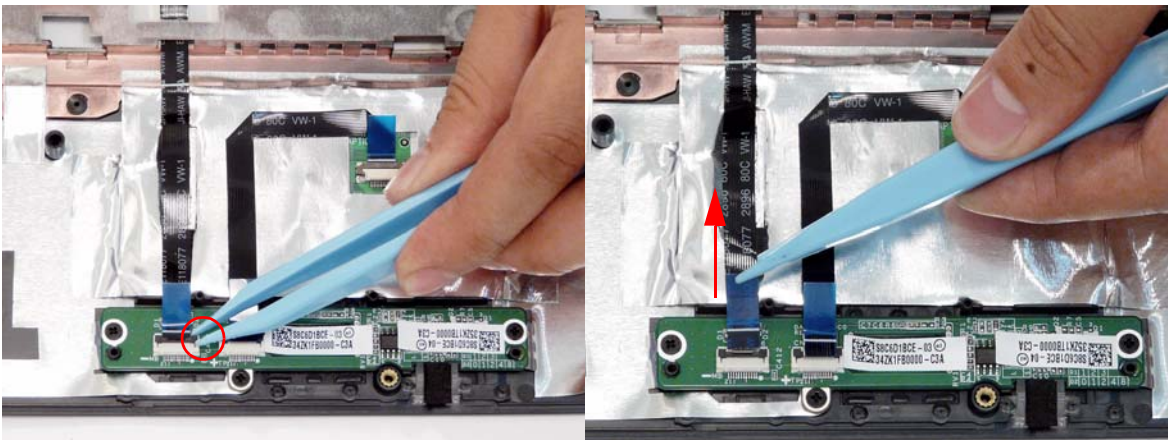

4. Remove the three securing screws.

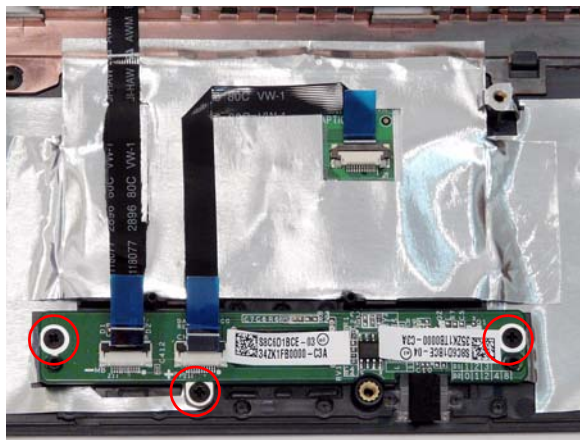

Step	Size	Quantity	Screw Type
Finger Print Reader	M2.0*3.0-I-NI-NYLOK	3	

5. Using your fingers, gently lift the Finger Print Reader board from the Upper Base.

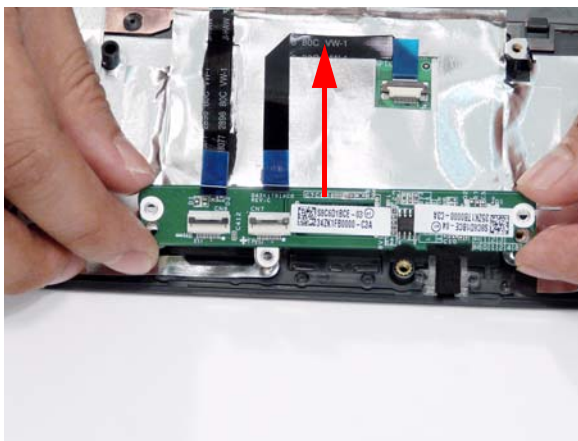

Removing the USB Board

1. Remove the Upper Base. See “Removing the Upper Base” on page 74.
2. Grasp the cable connector and pull to remove from the bottom base.

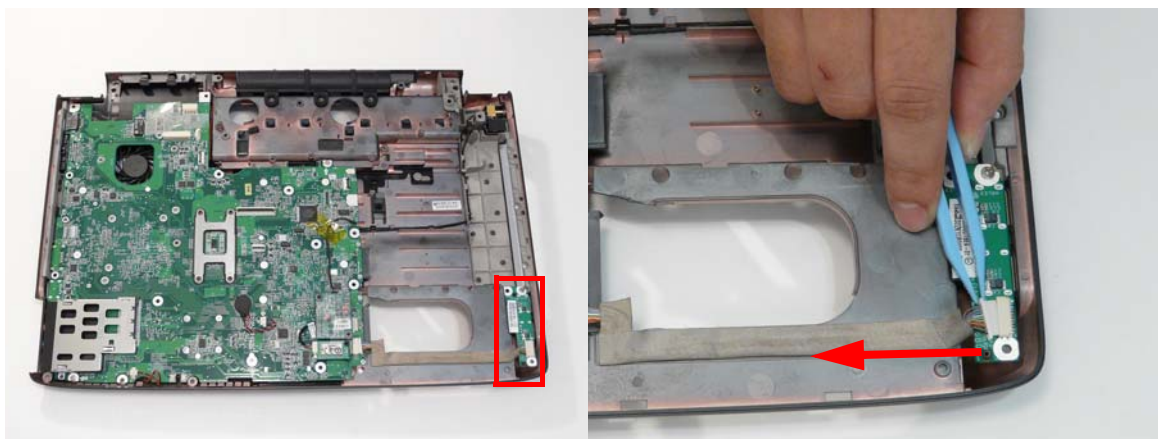

3. Remove the single securing screw from the USB board.



Step	Size	Quantity	Screw Type
USB Board	M2.0*3.0-I (BKAG) (NYLOK) IRON	1	

4. Hold the USB board by the edges and pull up to remove.

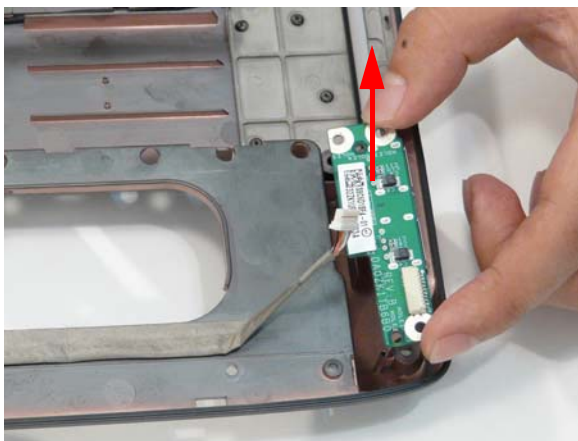

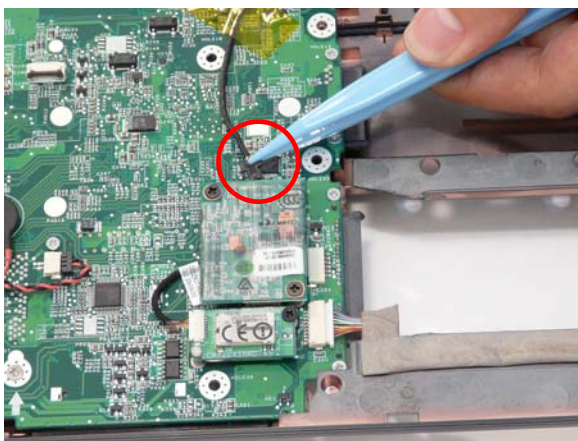

Removing the Modem Module

1. Remove the Upper Base. See “Removing the Upper Base” on page 74.
2. Disconnect the RJ-11 cable from the modem as shown.

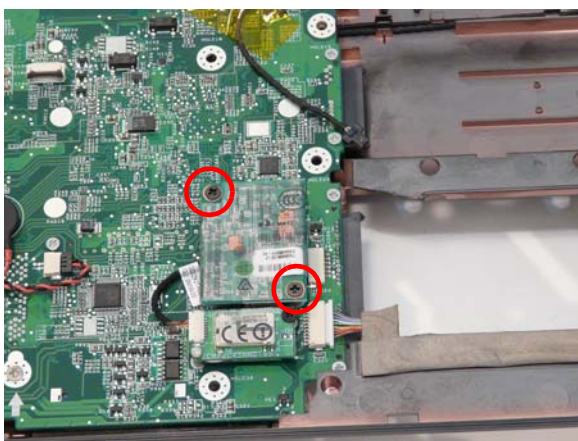

3. Remove the two (2) securing screws.



Step	Size	Quantity	Screw Type
Modem Module	M2.0*3.0-I-NI-NYLOK	2	

4. Lift the module and remove from the lower cover as shown.

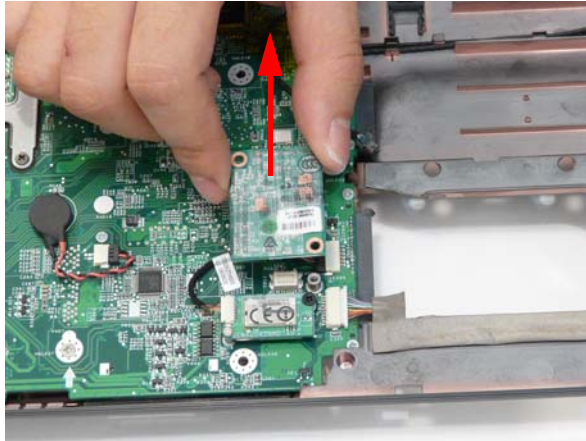

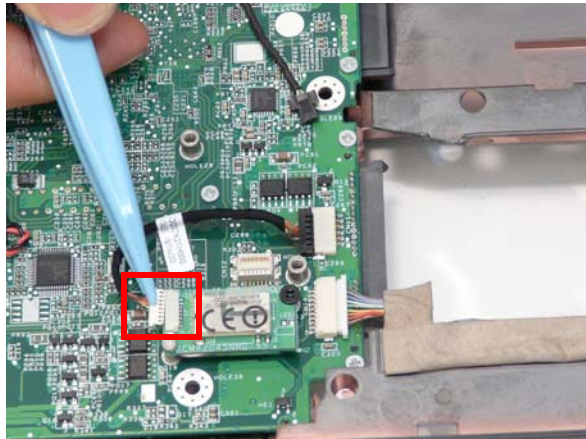

Removing the Bluetooth Module

1. Remove the Modem Module. See "Removing the Modem Module" on page 79.
2. Grasp the cable as shown and pull to disconnect from the Bluetooth module.

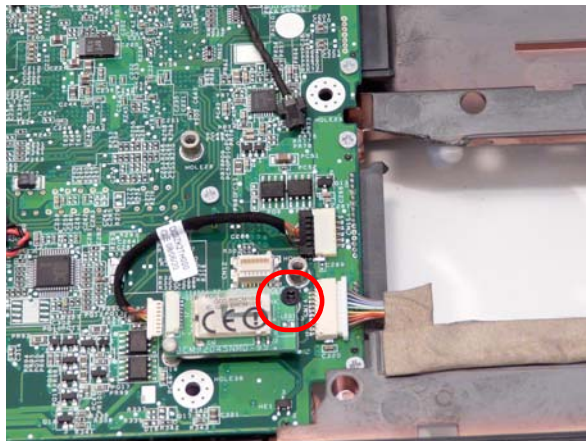

3. Remove the single securing screw.



Step	Size	Quantity	Screw Type
Bluetooth Module	M2.0*3.0-I-NI-NYLOK	1	

4. Grasp the module by the right side and lift up to remove.

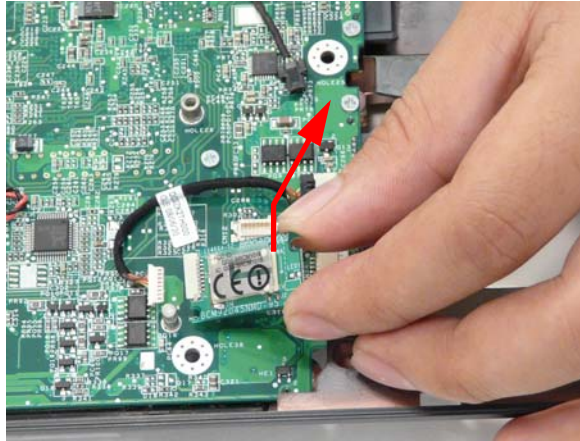

Removing the Mainboard

1. Remove the LCD Module. See “Removing the LCD Module” on page 73.
2. Remove the Upper Base. See “Removing the Upper Base” on page 74.
3. Remove the See “Removing the Modem Module” on page 79.
4. Remove the Bluetooth Module. See “Removing the Bluetooth Module” on page 80.
5. Disconnect the USB and Bluetooth cables remaining on the mainboard.

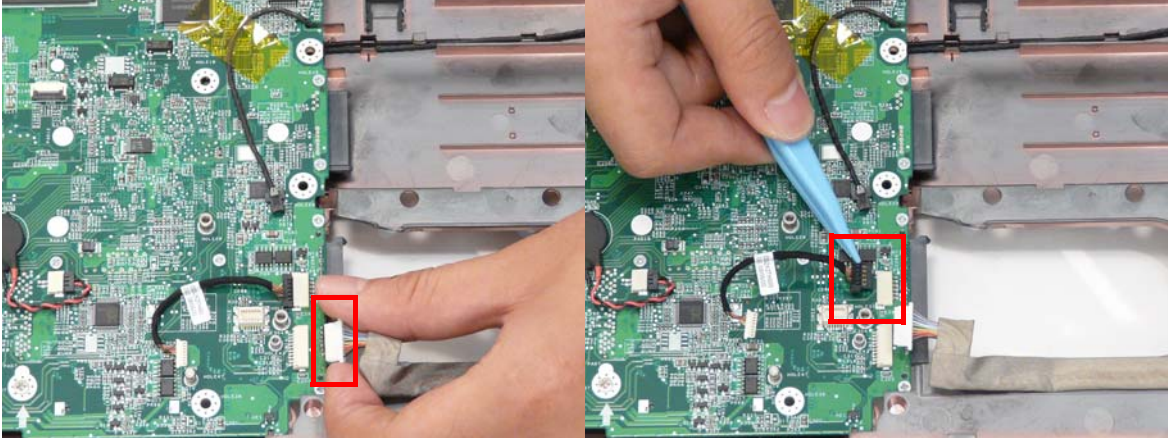

6. Grasp the RJ-11 cable and remove it from the mainboard as shown.

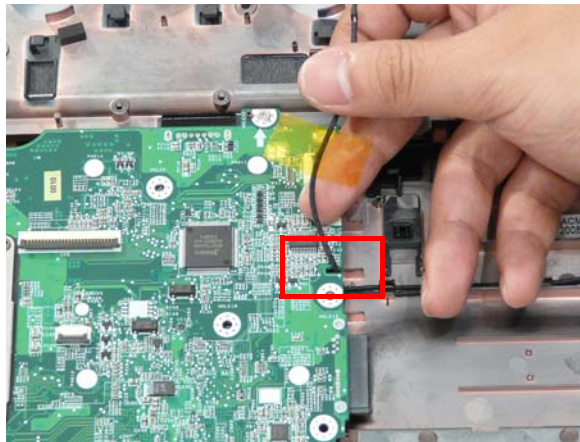

7. Disconnect the Subwoofer cable attached to the mainboard.

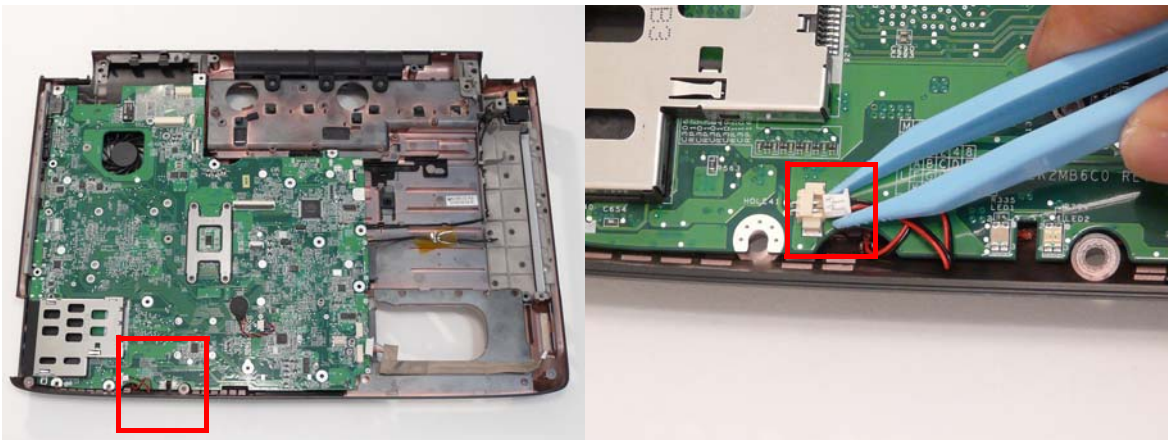

8. Remove the three securing screws.

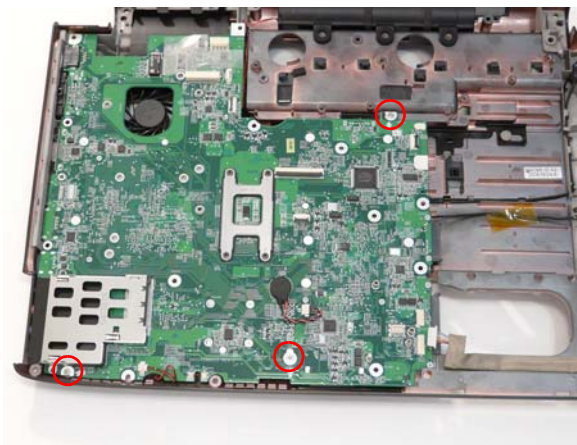

Step	Size	Quantity	Screw Type
Mainboard	M2.5*4.0-I (NI)(NYLOK)	3	

9. While holding the left side of the Lower Base, lift and pivot the mainboard to remove from the base.

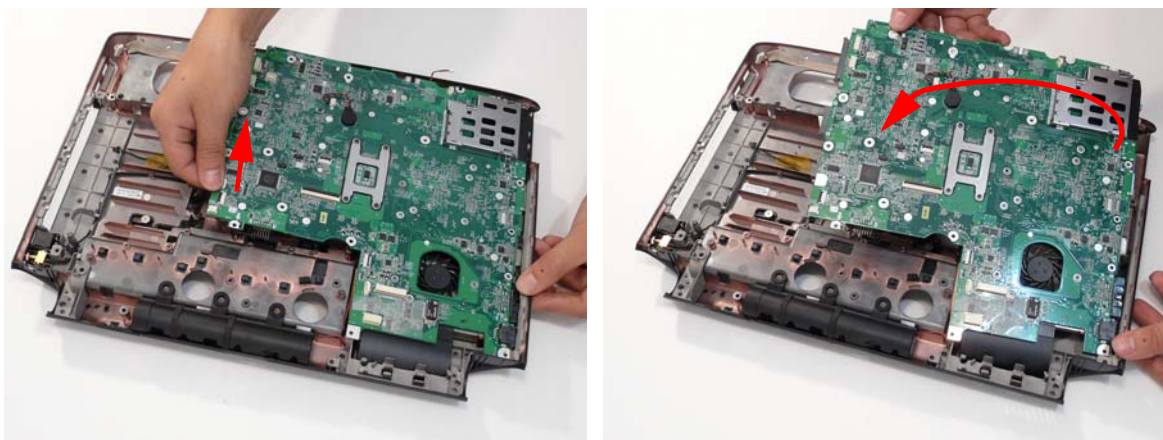

10. Grasp the mainboard by both sides and pivot upwards to remove.

Removing the Thermal Module

1. Remove the Mainboard. See “Removing the Mainboard” on page 82.
2. Turn the Mainboard over and place on a clean surface.
3. Hold the cable connector and lift to disconnect from the mainboard.

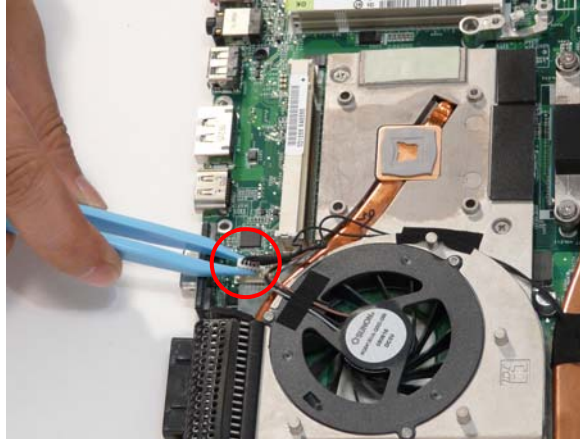

4. Remove the two securing screws (red) and loosen the four captive screws (blue) found on the Thermal Module.

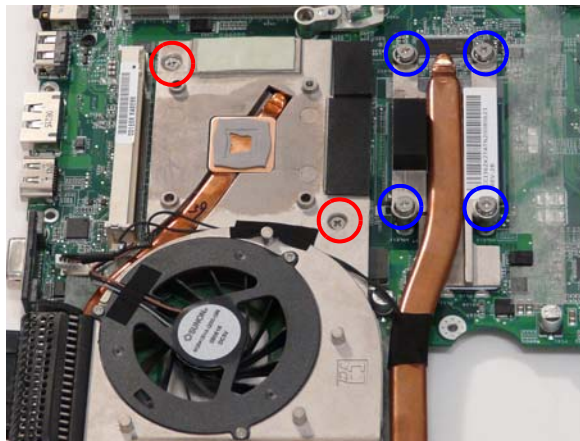

Step	Size	Quantity	Screw Type
CPU Thermal Module (red call out)	M2.5*4.0-I (NI)(NYLOK)	2	

WARNING: To prevent damage to the Thermal Module or the CPU, hold and lift the Thermal Module by lifting both ends up and away at the same time.

5. Hold the module on both sides and lift it clear of the Mainboard.

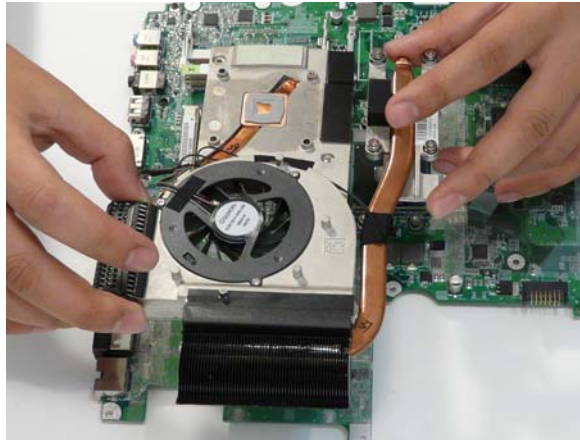

Removing the CPU

1. Remove the Thermal Module. See "Removing the Thermal Module" on page 84.
2. Using a flat screwdriver, turn the CPU socket latch counter-clockwise 180° to release the CPU.

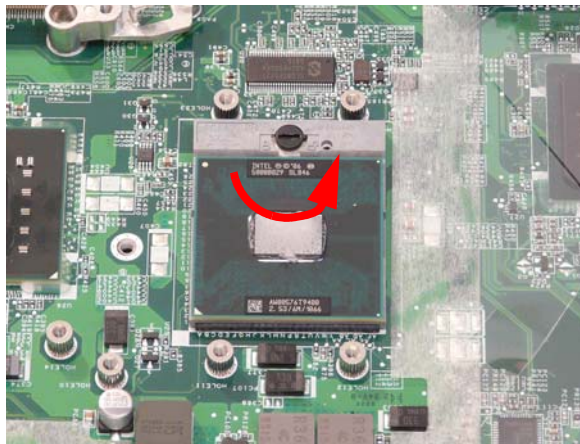

3. Lift the CPU clear of the Mainboard.

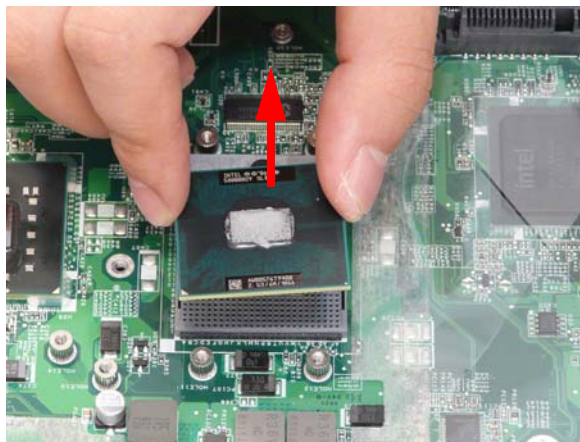

LCD Module Disassembly Process

LCD Module Disassembly Flowchart

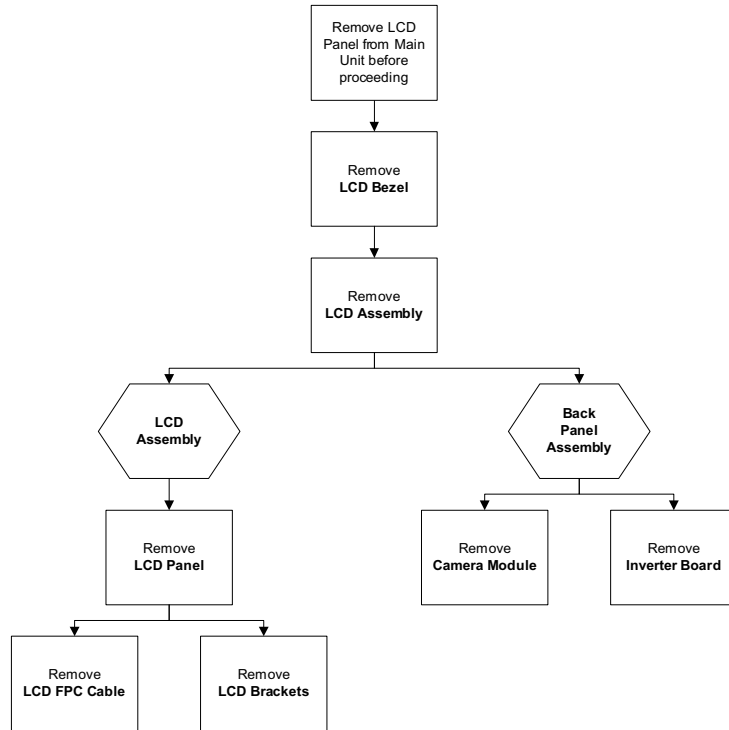

Screw List

Step	Screw	Quantity	Part No.
LCD Bezel	M2.5*6.5-I (BZN)(NYLOK-RED)	10	86.ARE07.001
LCD Panel	M2.5*2.5-I (NI)(NYLOK)	6	86.T25V7.010
LCD Brackets	M2.0*3.0-I (BKAG) (NYLOK) IRON	8	86.ARE07.002

Removing the LCD Bezel

1. Remove the LCD module. See "Removing the LCD Module" on page 73.
2. Remove the four upper screw caps and screws, and the six remaining lower securing screws.



Step	Size	Quantity	Screw Type
LCD Bezel	M2.5*6.5-I (BZN(NYLOK-RED))	10	

3. Lift up the bezel, topside first, and remove it from the LCD Module.



4. Turn the bezel and pry the left side upwards, followed by the right side.



5. After removing the top part of the bezel, grasp the bottom corners and continue lifting up the bezel as shown.



6. Lift the bezel away from the panel and lay it flat to expose the Mic cable.



7. Disconnect the Mic cable and remove the LCD bezel.

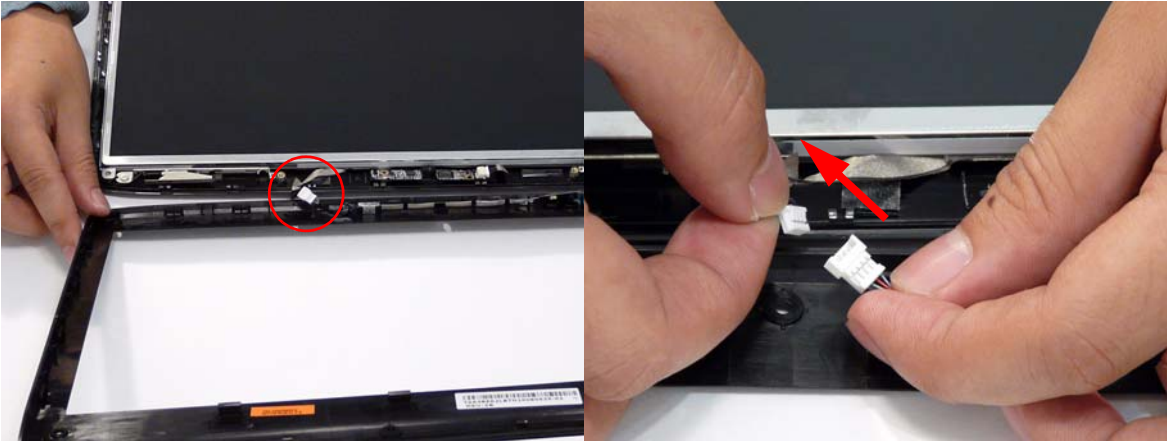

Removing the Inverter Board

1. Remove the LCD Bezel. See "Removing the LCD Bezel" on page 87.
2. Disconnect both cables from the Inverter Board.

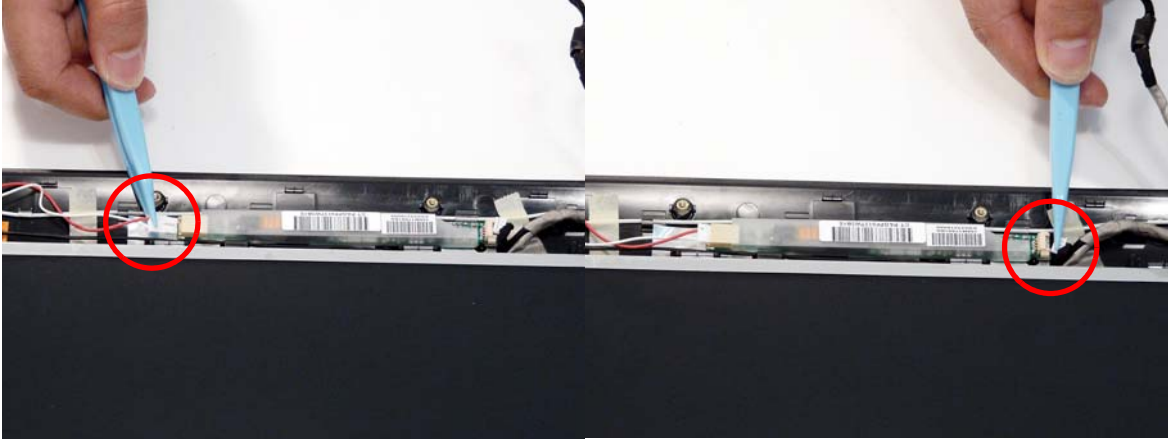

NOTE: If you are having difficulty removing the cables, first lift the Inverter Board from the back cover before disconnecting the cables.

3. Remove the Inverter board from the LCD Module.



Removing the Camera Module

1. Remove the LCD Bezel. See "Removing the LCD Bezel" on page 87.
2. Disconnect the Camera Module cable as shown.



NOTE: If necessary lift the camera module to provide better access to the cables.

3. Place your finger on the ends of the module and pry it away from the cover.

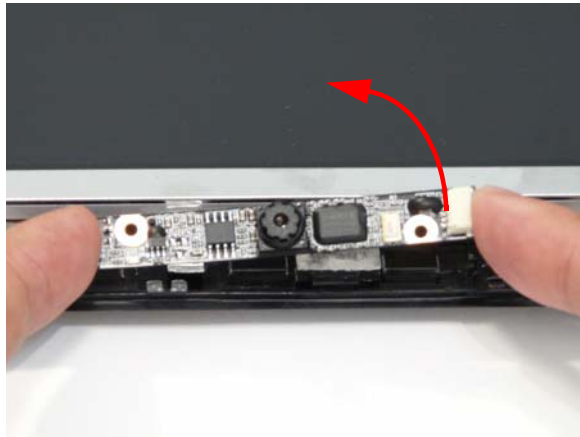

Removing the LCD Panel

1. Remove the LCD Bezel. See "Removing the LCD Bezel" on page 87.
2. Remove the six securing screws from the LCD hinges.

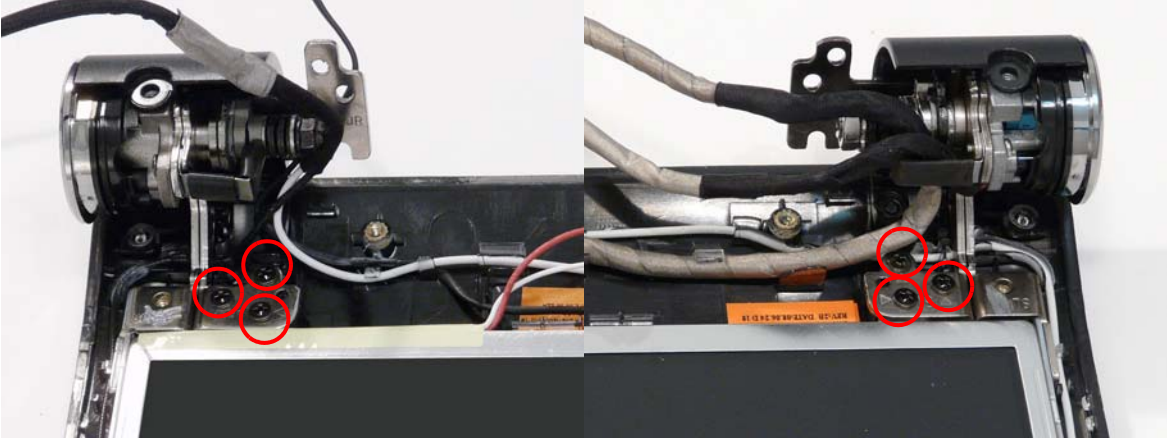

Step	Size	Quantity	Screw Type
LCD Panel	M2.5*2.5-I (NI)(NYLOK)	6	

3. Grasp the top of the LCD Panel and pivot upwards to a 90 degree angle.

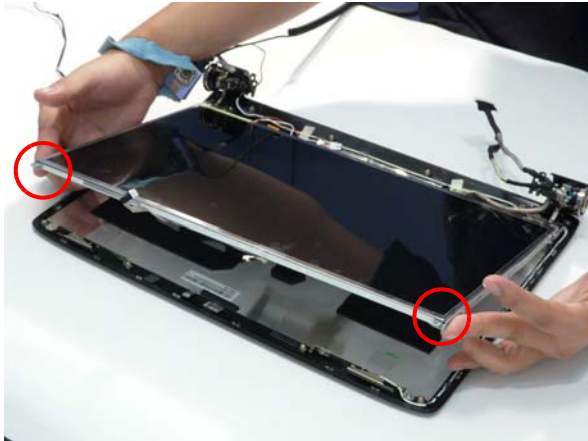

4. Once the panel is upright, lift the panel upwards taking care of the cables located in the hinges.

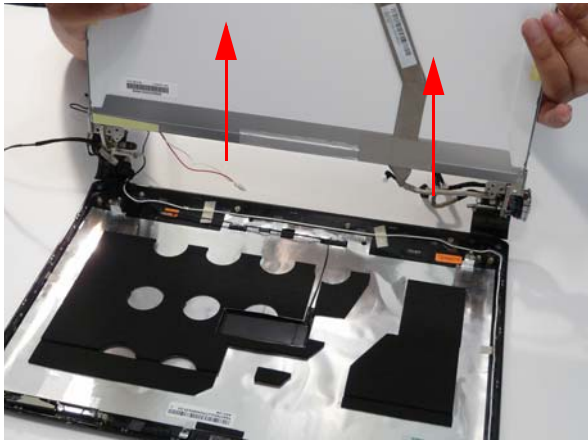

Removing the LCD Brackets and FPC Cable

1. Remove the LCD panel. See “Removing the LCD Panel” on page 92.
2. Dislodge the LCD cable from the left LCD hinge as shown in the following image.

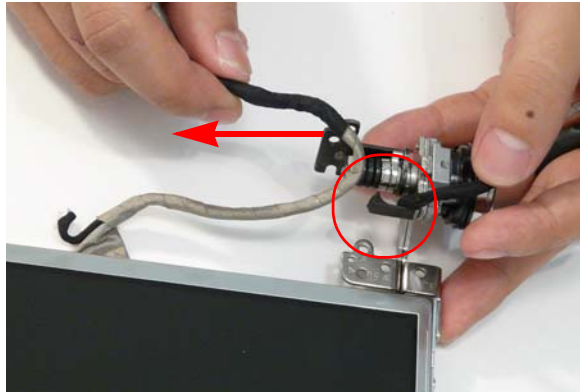

3. Turn the LCD Panel over on a clean surface, and grip the LCD cable by both ends and pull it back.

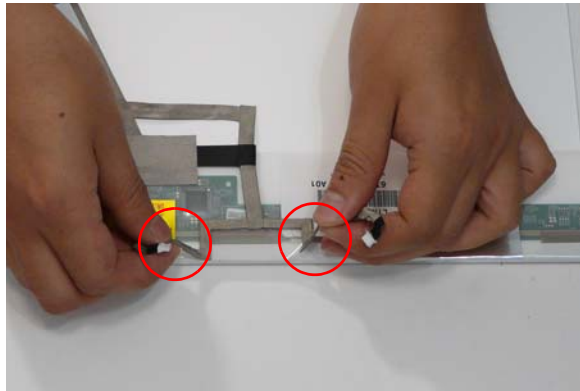

4. Grip the adhesive strip and pull it back.

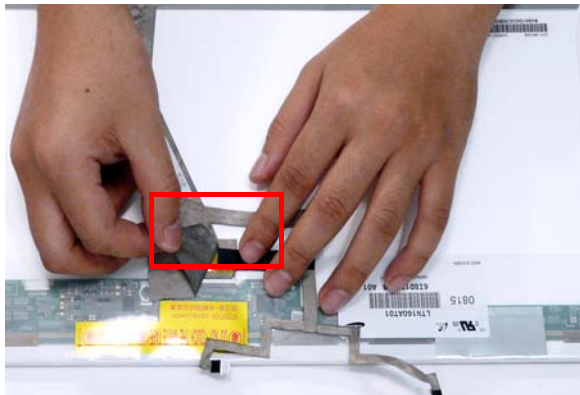

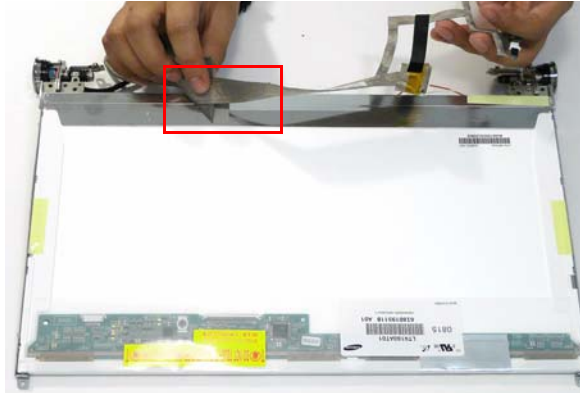

5. Continue to pull back the LCD cable.

6. Peel back the adhesive strip holding the cable to the bottom.

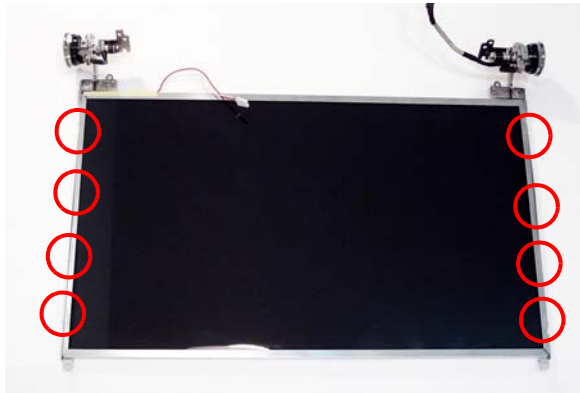

7. Remove the eight securing screws (four on each side) from the LCD Panel brackets.



Step	Size	Quantity	Screw Type
LCD Brackets	M2.0*3.0-I (BKAG) (NYLOK) IRON	8	

8. Remove the LCD brackets by pulling them away from the LCD Panel.

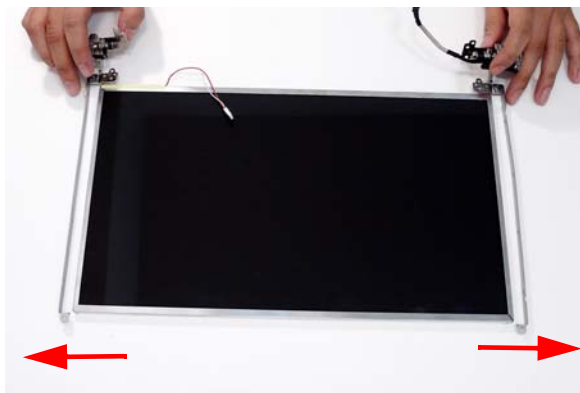

LCD Module Reassembly Procedure

Replacing the LCD Panel

1. Align the LCD brackets with the eight screw holes (four on each side) on the LCD Panel as shown.

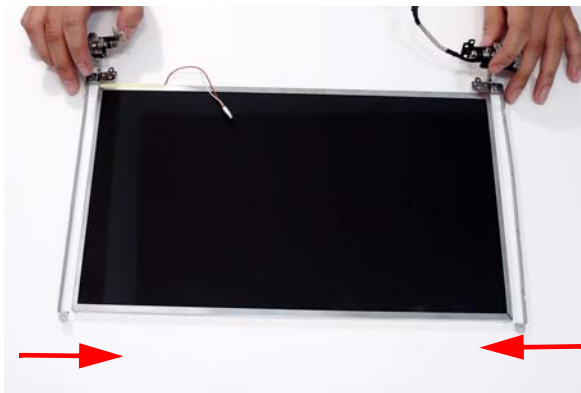

2. Secure the LCD brackets to the LCD panel.

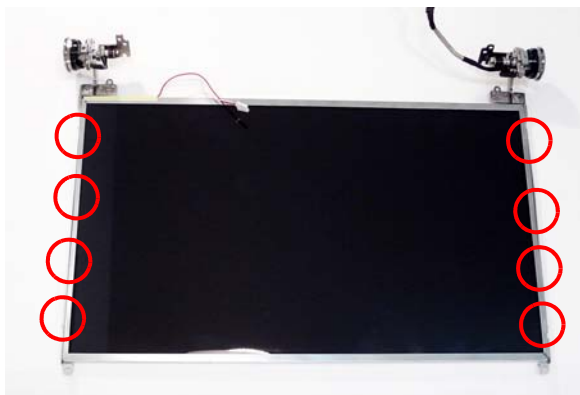

3. Turn the panel over. Insert the LCD Panel cable into the LCD Panel as shown. Secure the cable by replacing the securing strip.

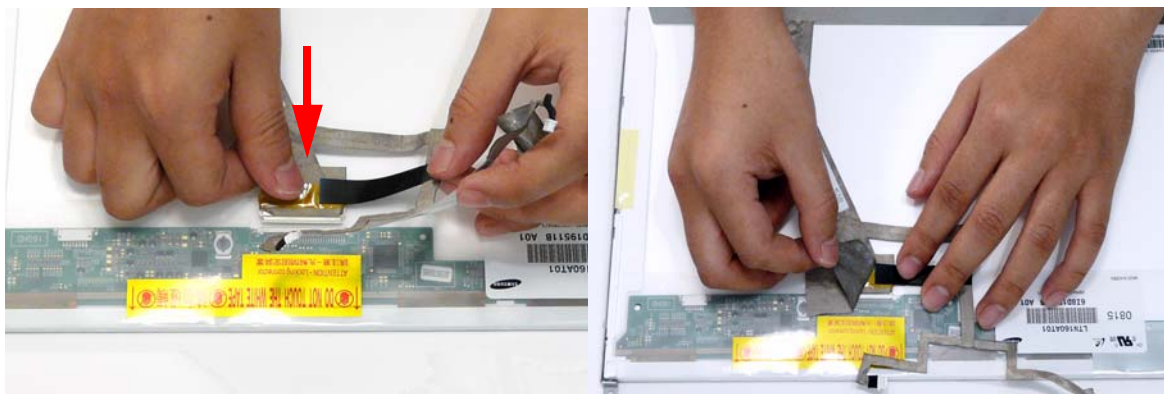

4. Replace the remaining securing strips and press down along the length of the cable to secure it in place ensuring the cable ends are in line with the edge of the panel.

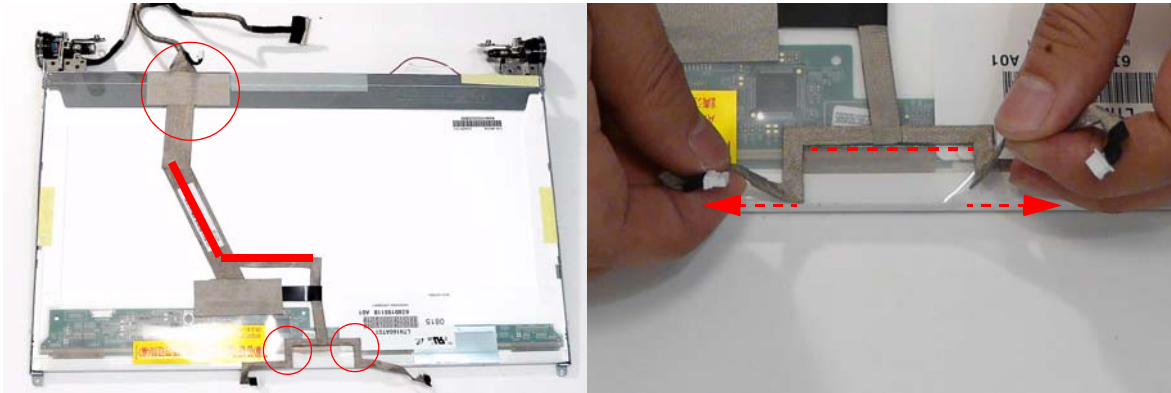

5. Turn the LCD Panel over and re-insert the LCD cable into the hinge retainer.

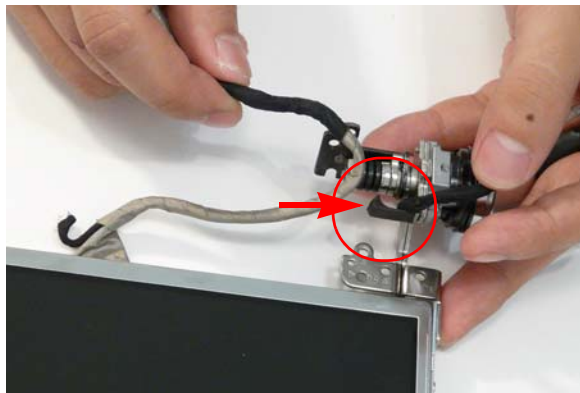

6. Align the brackets with the alignment wells in the back panel and lower the LCD brackets into the bracket wells as shown.

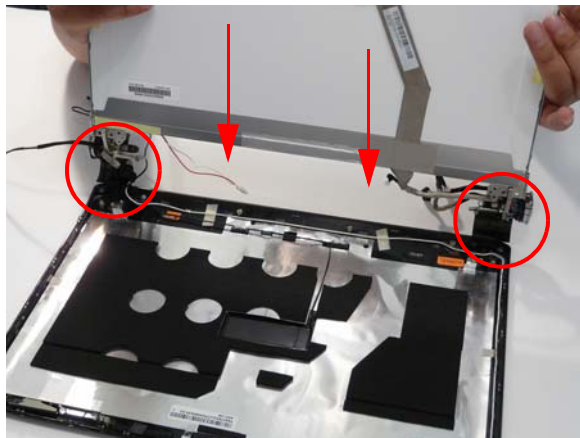

7. Pivot the LCD Panel down in place.

NOTE: Ensure the CMOS and Inverter cables are not under the LCD Panel and correctly aligned.

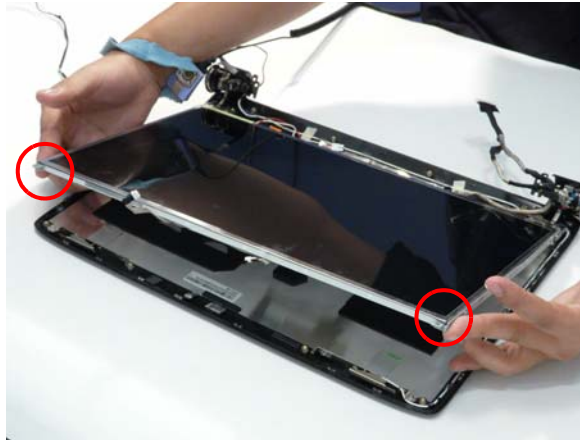

8. Replace the six screws to secure the panel within the LCD module.

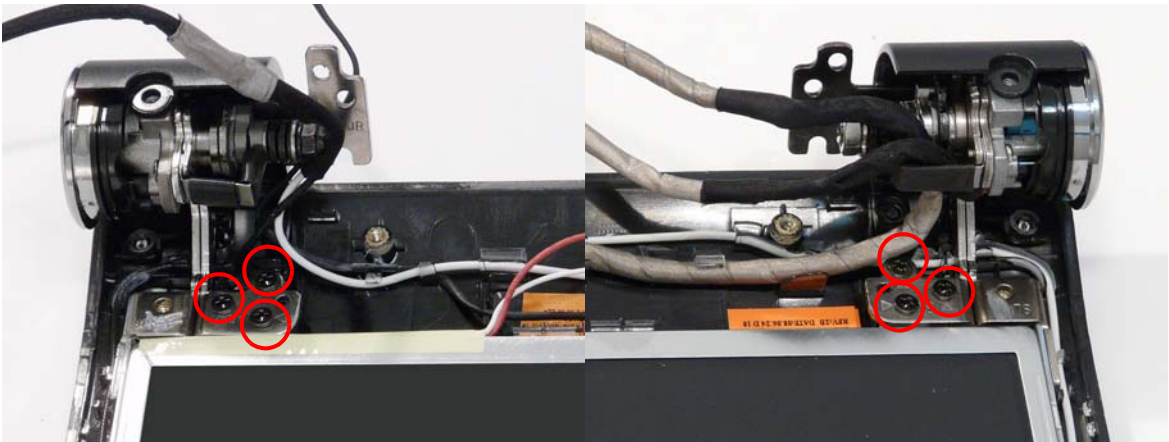

9. Locate the alignment pins (2) and replace the Camera Board taking care the pins protrude through the sockets.

10. Connect the Camera Module cable as shown.

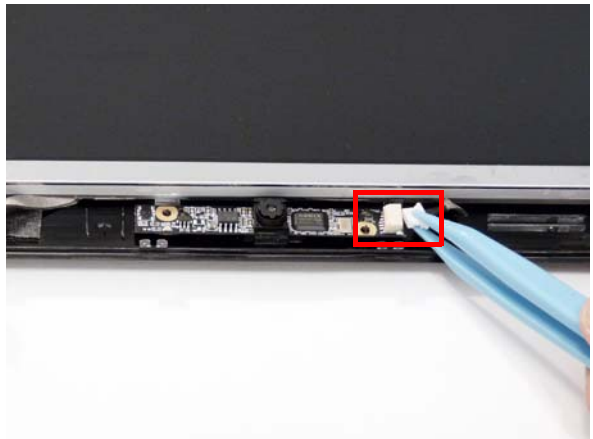
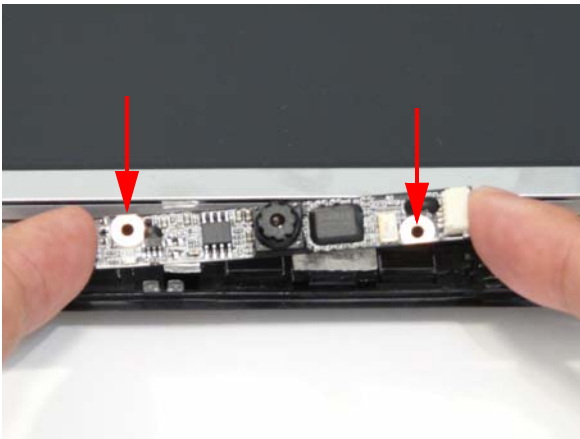

11. Connect the right Inverter board cable as shown.

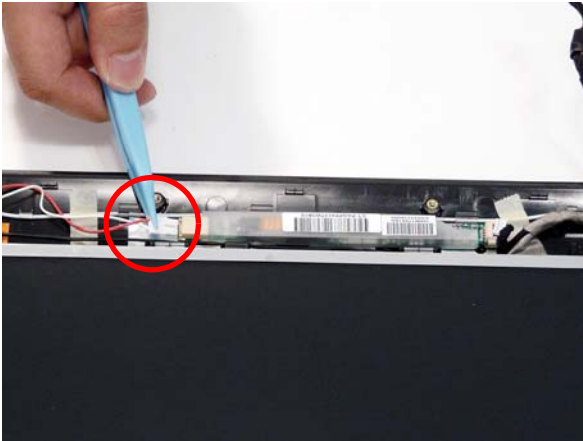

12. Connect the left Inverter board cable as shown.

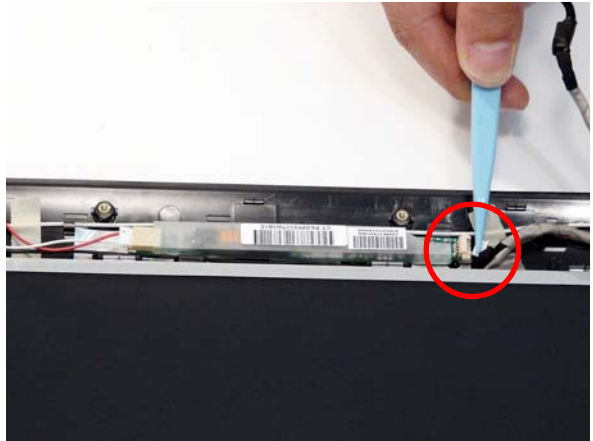

13. Replace the Inverter board as shown and press down to secure in place.

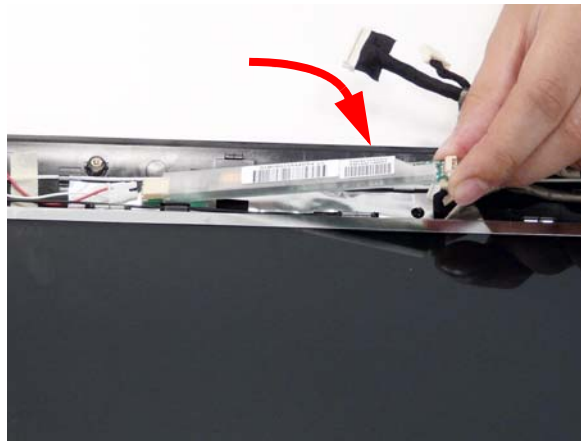

NOTE: Tuck the cables securely to prevent damage to the cables or module.

Replacing the LCD Bezel

1. Align the edge of the bezel with the bottom cover and reconnect the Mic Cable.



2. Align the hinge covers taking care to tuck in all cabling, and lower the bezel down in place.



3. Continue to press the bezel down in place to lock the upper and lower covers in place.



4. Replace the ten securing screws and screw caps on the LCD bezel.



Main Module Reassembly Procedure

Replacing the CPU

1. Carefully turn the mainboard upside down (CPU side up), and insert the CPU into the CPU bracket as shown.
2. Using a flat-tipped screw driver, lock the CPU in the socket as shown.

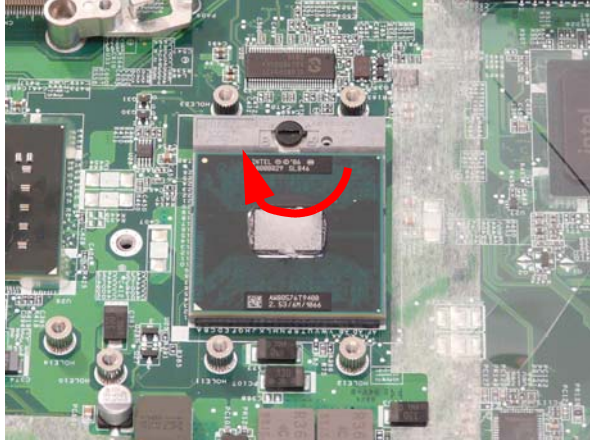
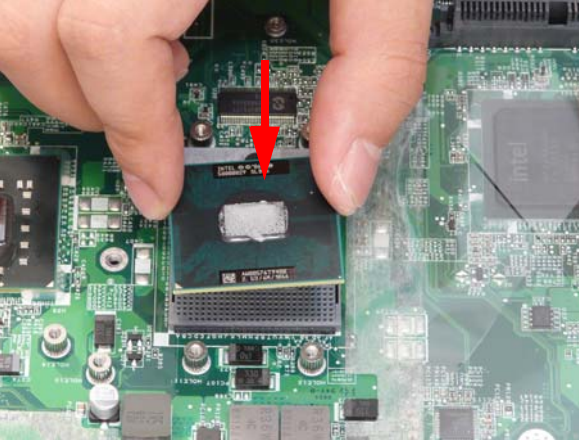

Replacing the Thermal Module

WARNING: To prevent damage to the Thermal Module or the CPU, hold the Thermal Module by both ends at the same time.

1. Align and place the Thermal Module in the on the mainboard as shown.
2. Replace the two securing screws (red) and tighten the four captive screws (blue) found on the Thermal Module.

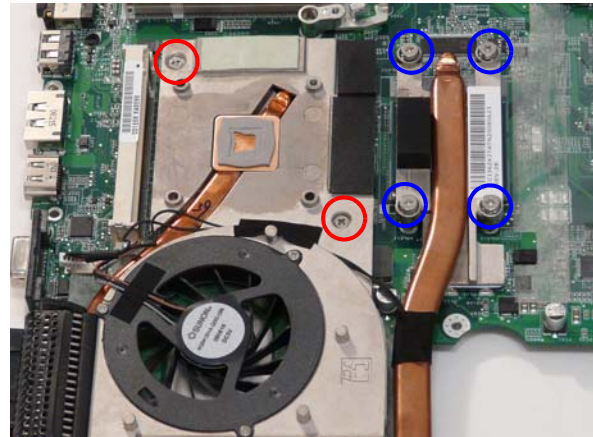
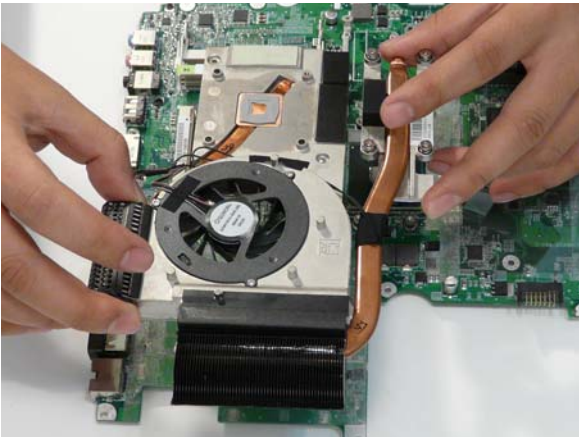

3. Connect fan cable to the mainboard as shown.

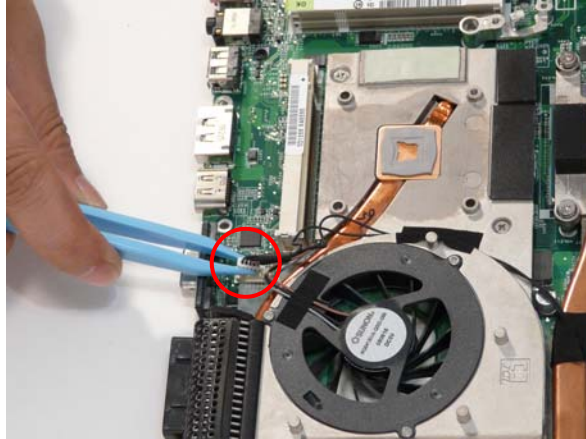

Replacing the Mainboard

1. Ensure that the Mainboard is face up. Place the Mainboard in the chassis, left hand rear edge first.
2. While holding the left side of the Lower Base, lower and pivot the mainboard in to the base.

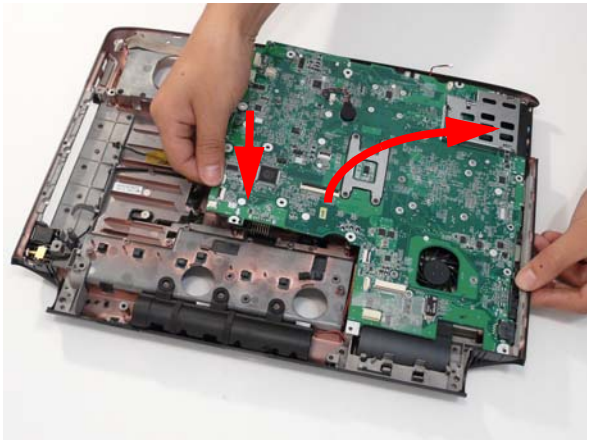
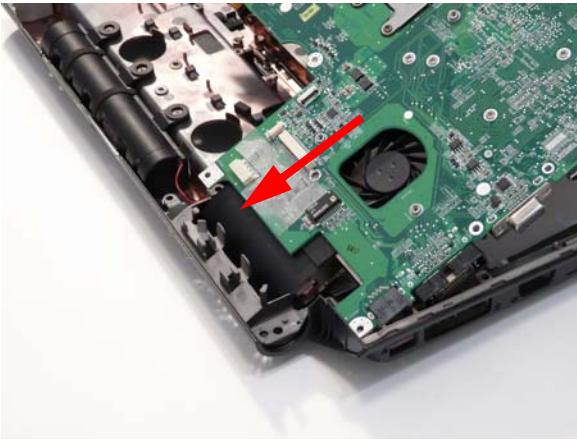

3. Ensure the screw sockets are aligned. Replace the three securing screws as shown.

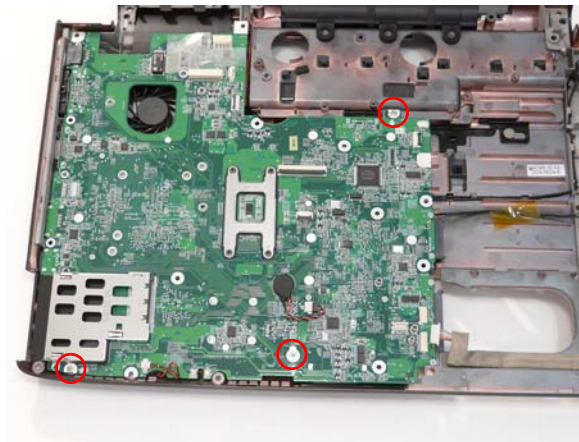

NOTE: Make sure the I/O ports are positioned correctly through the lower cover, and the screw sockets are visible through the mainboard.

4. Reconnect the subwoofer cable to the mainboard.

IMPORTANT: Ensure that the cable passes through the mainboard, as shown, and is inserted into the retaining clip to avoid trapping when the upper case is replaced.

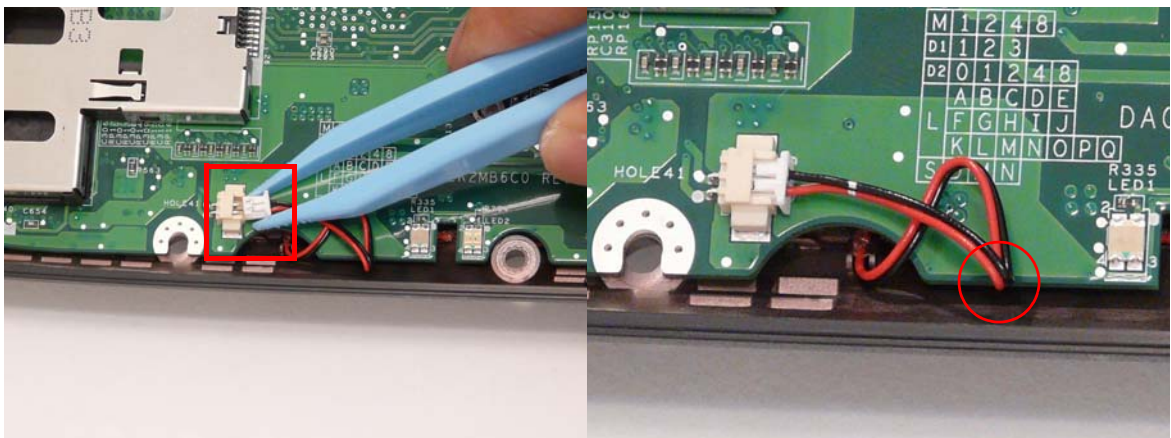

5. Replace the RJ-11 cable in the retaining clip on the mainboard and stick it in place using the adhesive strip.

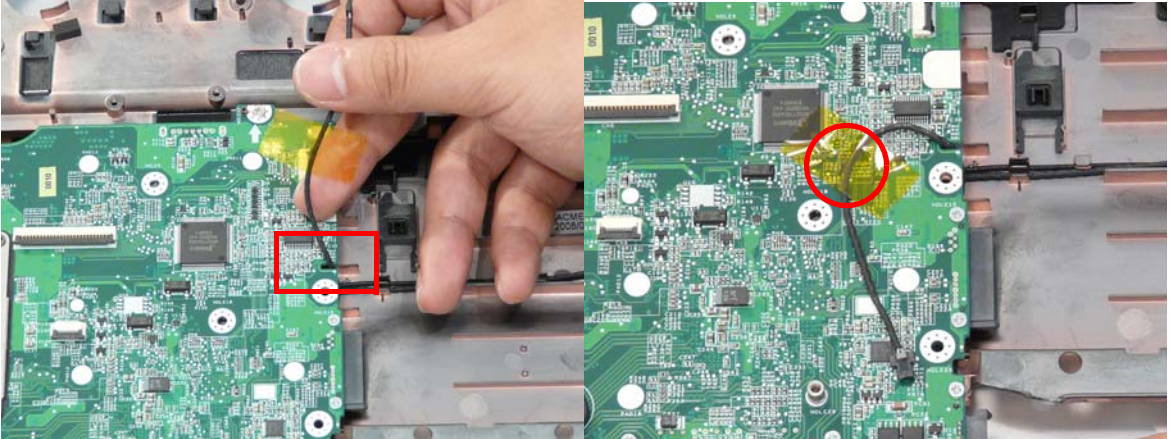

6. Reconnect the Bluetooth and USB cables to the mainboard.

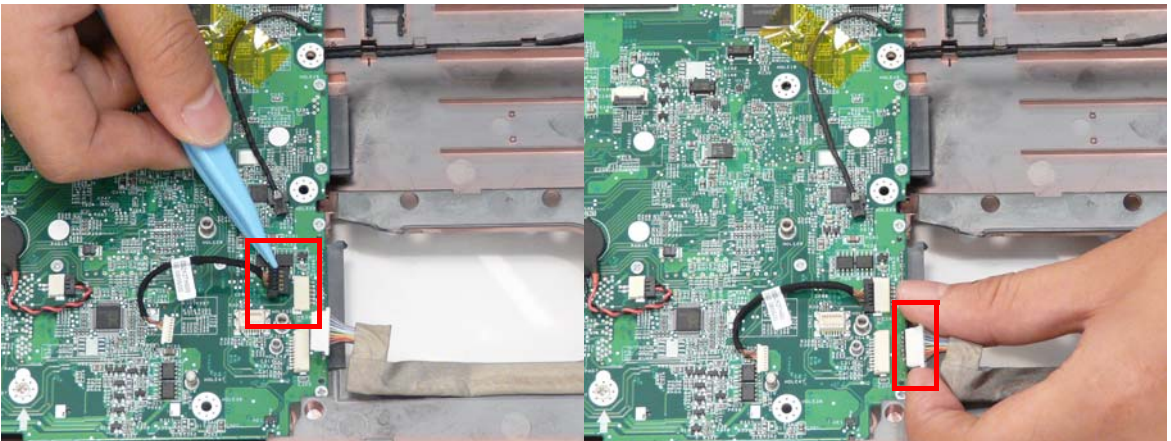

Replacing the Bluetooth Board

1. Position the module over the aligning pins and insert in place.
2. Replace the bluetooth cable as shown.

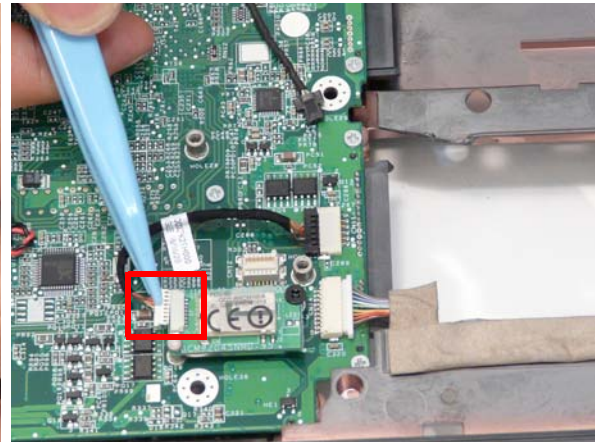
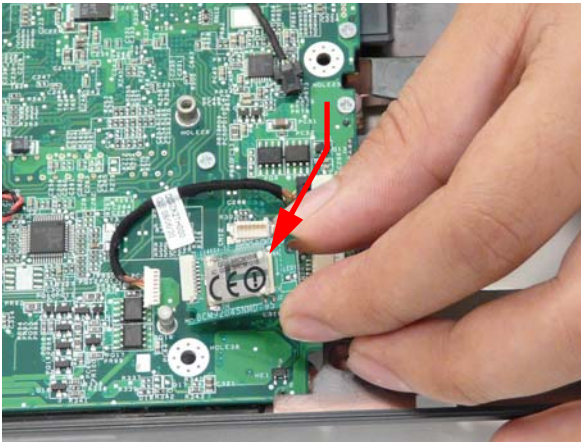

3. Replace the single screw to secure the board.

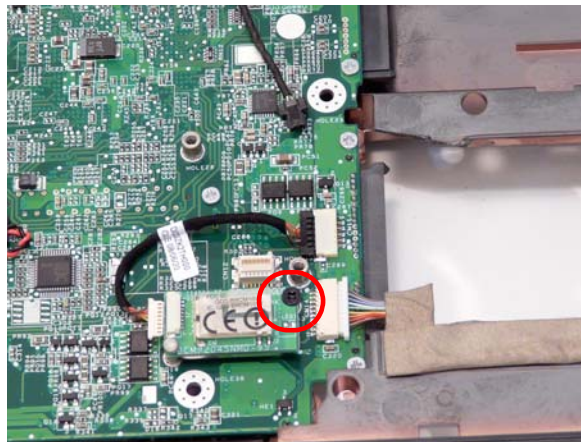

Replacing the Modem Module

1. Align the screw sockets and press the modem module down to connect to the mainboard.
2. Replace the two securing screws.

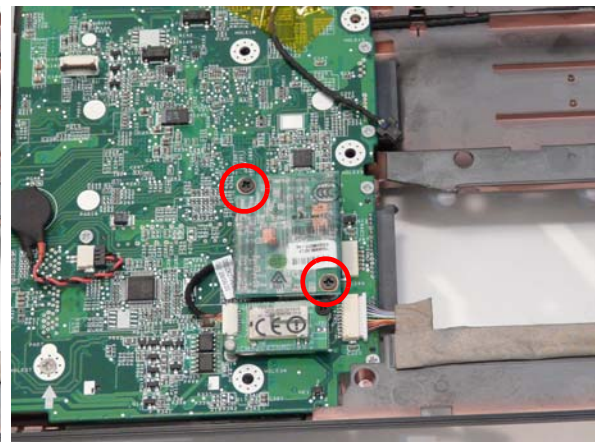
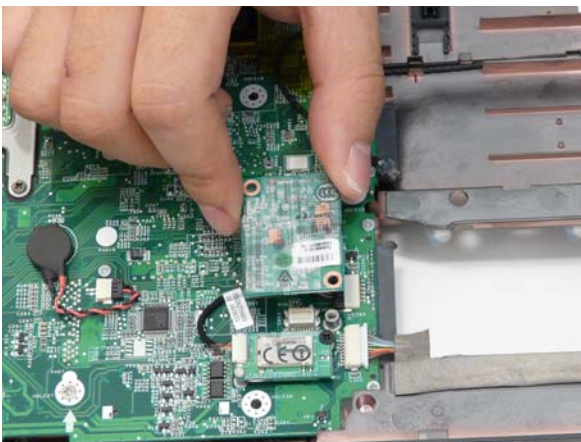

3. Connect the modem cable as shown



Replacing the USB Board

1. Replace the USB board on the lower base and secure with the single screw (provided).

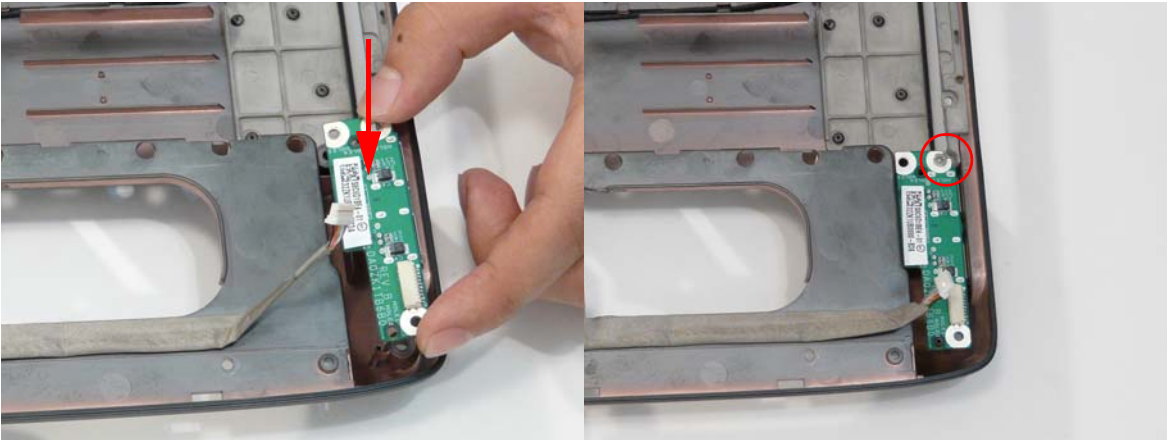

2. Reconnect the USB cable as shown.

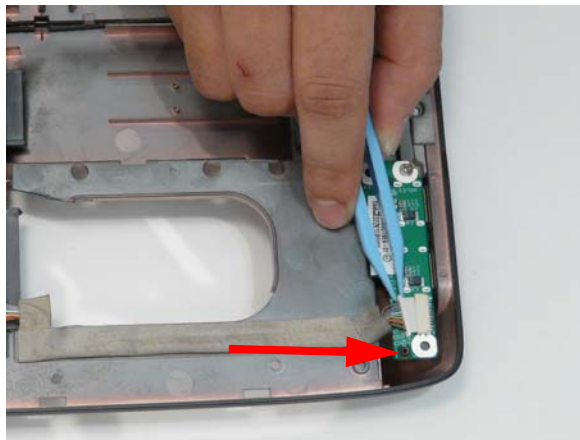

Replacing the Finger Print Reader

1. Replace the Finger Print Reader board in the upper cover and secure with the three screws as shown.

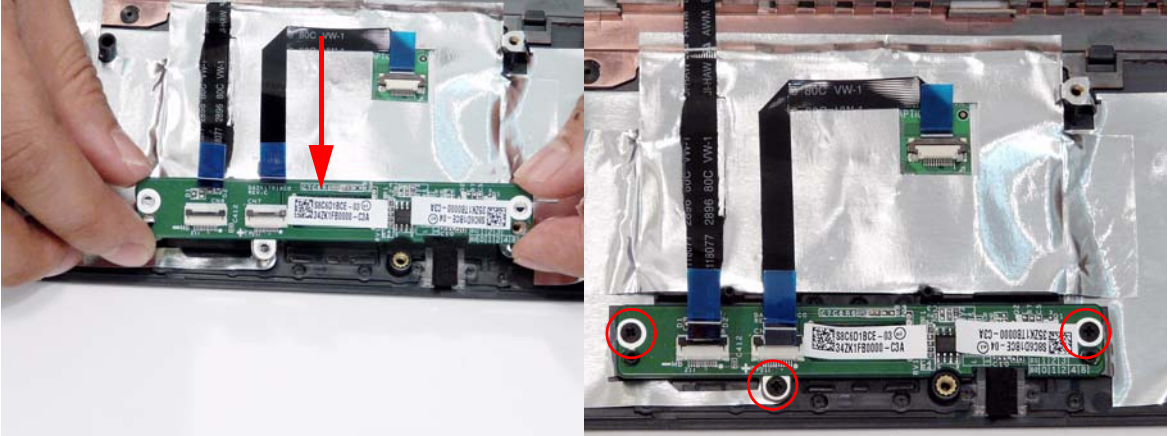

2. Reconnect the TouchPad and Finger Print Reader FFCs as shown.

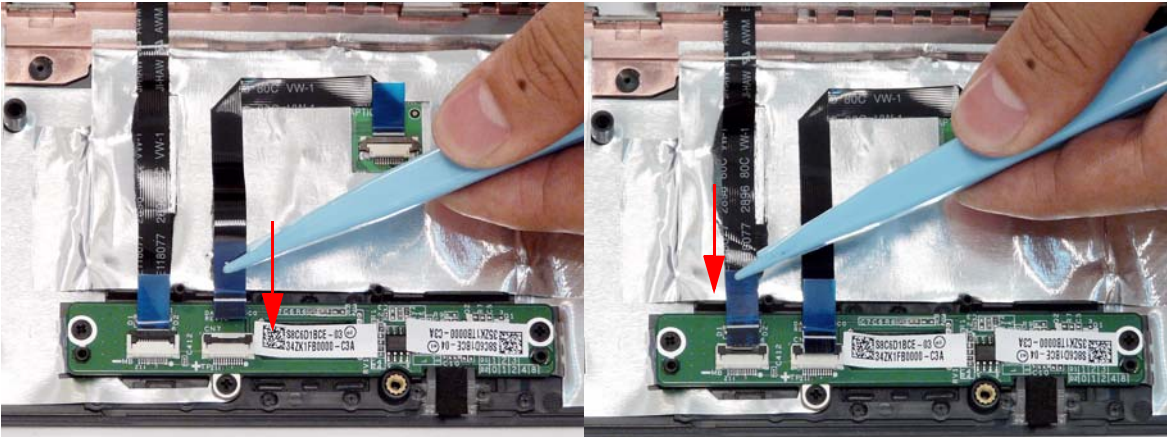

Replacing the Upper Cover

WARNING: Care must be taken when replacing the Upper Case to prevent damage or stress to the surface.

1. Starting with the rear, align the upper cover with the lower cover, taking care to not force in place.

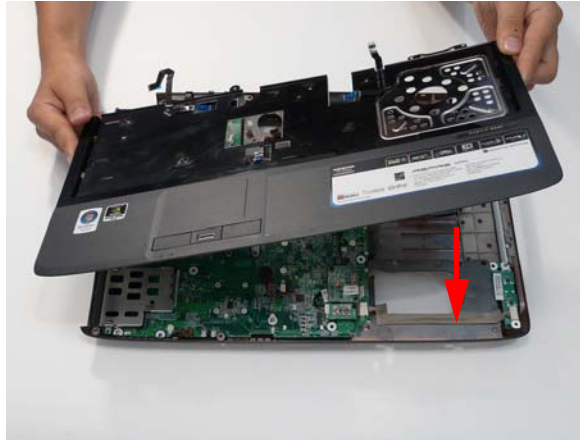

2. Replace the ten securing screws on the top panel.

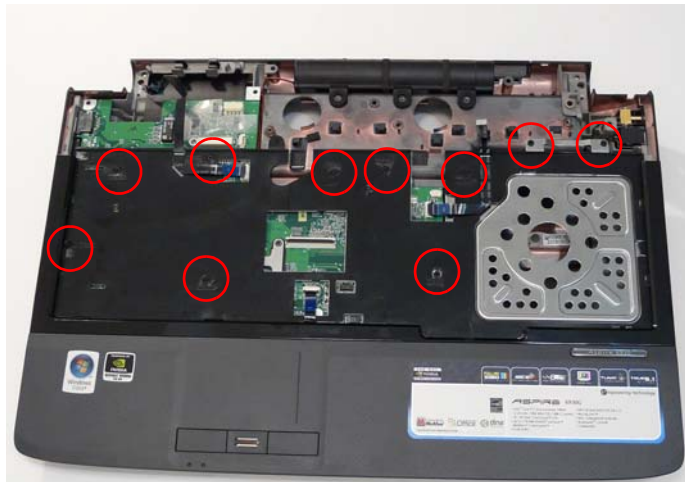

3. Reconnect the three FFC cables to the mainboard.



Reconnect A as shown, and close the locking latch. Reconnect B as shown, and close the locking latch.

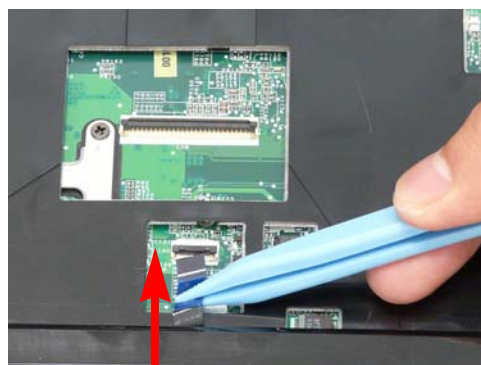
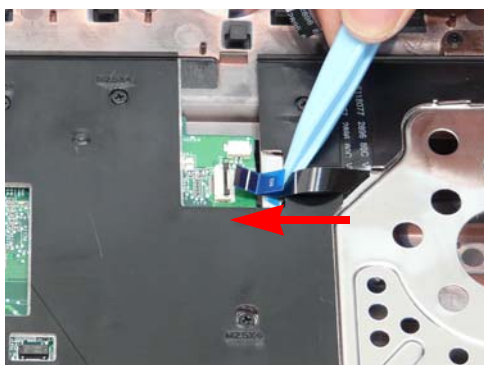

Reconnect C as shown, and close the locking latch.

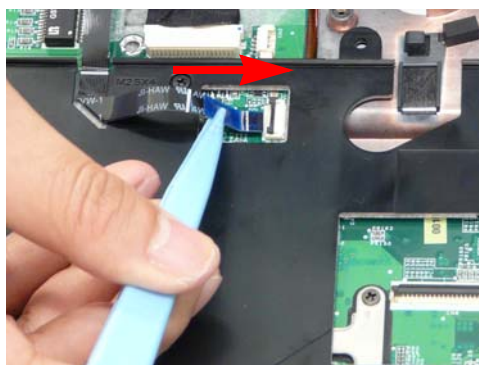

4. Turn the computer over. Replace the ten screws on the bottom panel.



Replacing the LCD Module

1. Carefully align the LCD module over the hinge sockets and lower the module into the chassis, taking care not to trap the LCD cables.

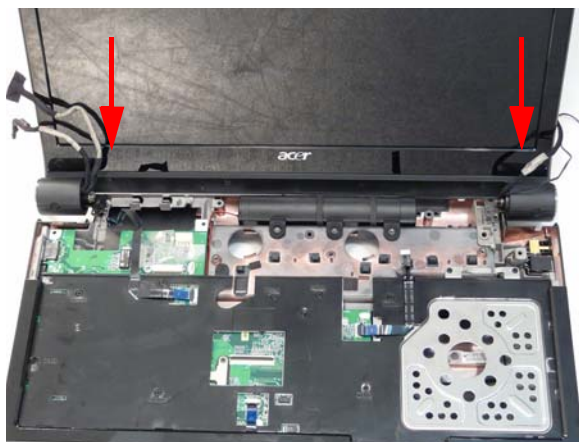

2. Replace the four securing screws (two on each side) securing the LCD module.

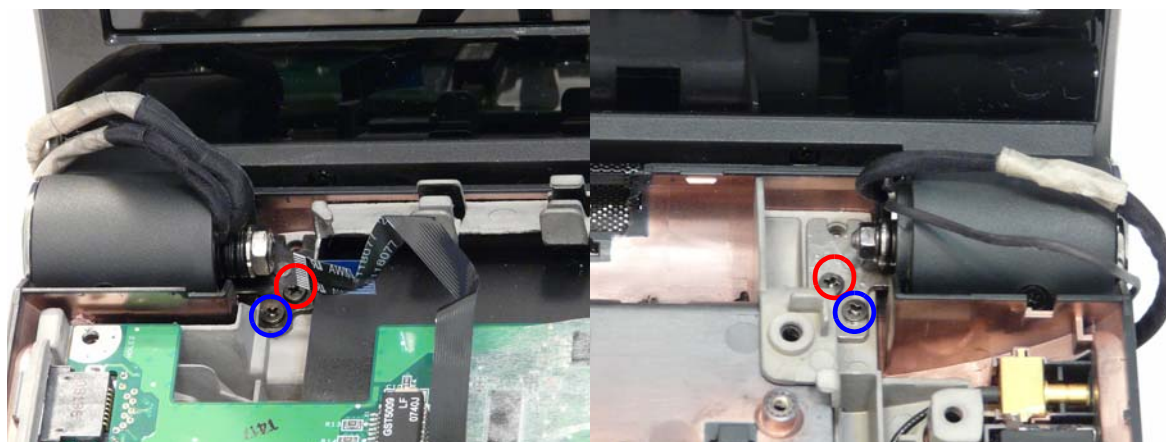

3. Replace the LCD power cable and AC power cable in the cable guides and clips as shown.

NOTE: There are two cable channels. The upper channel holds the AC power cable and the lower channel holds the LCD power cable.

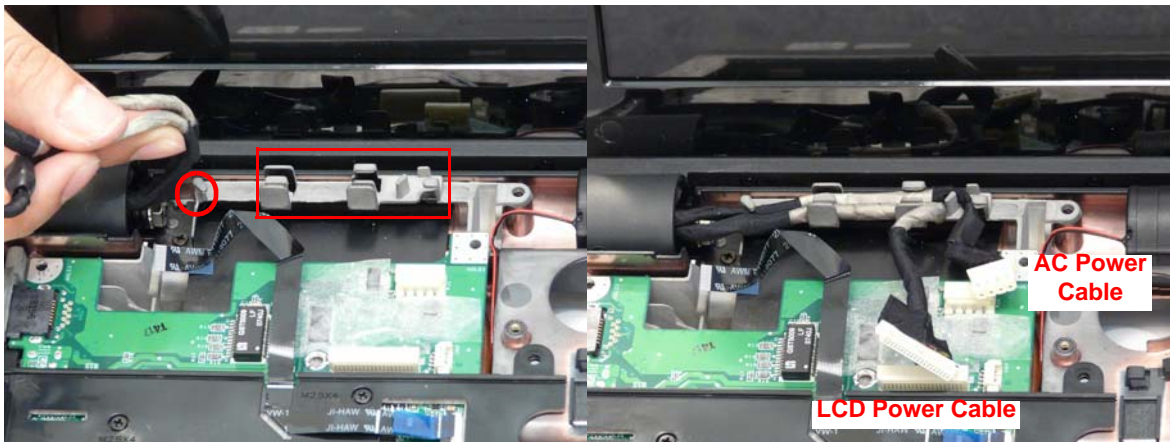

4. Reconnect the cables as shown.

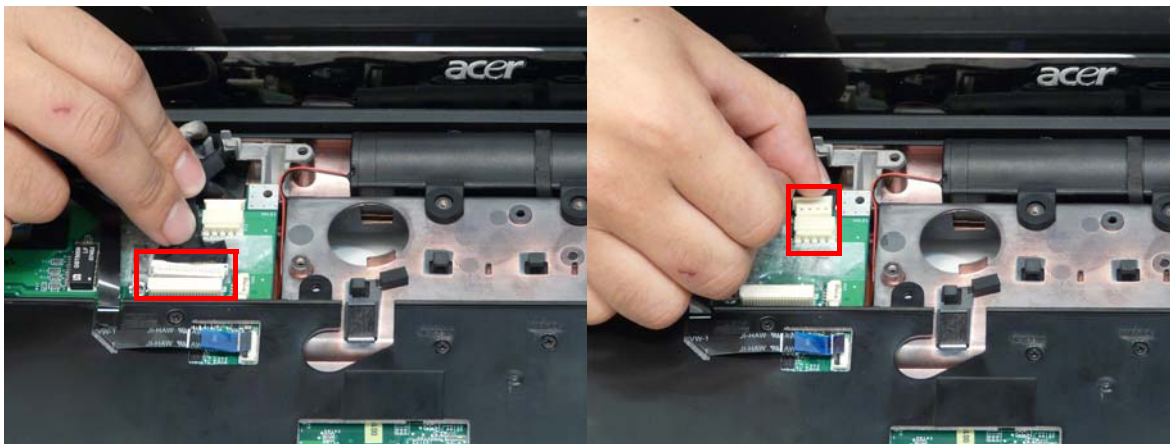

5. Replace the antenna and backlight cables as shown, taking care to follow the cable guides and clips.

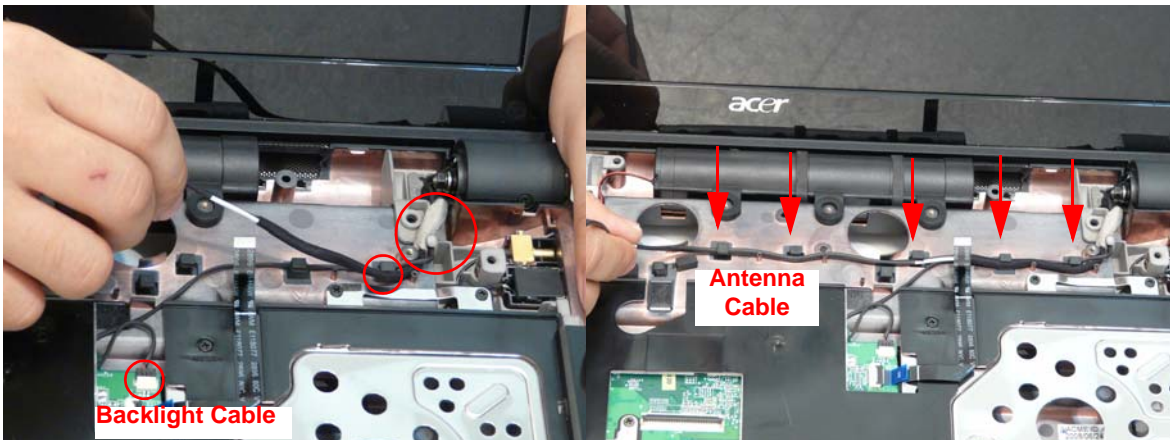

6. Push the antenna cables through the chassis and pull through from the other side.

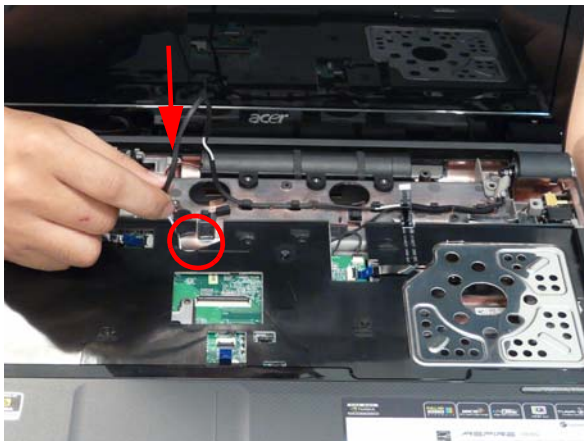

7. Turn the computer over and replace the antenna cables as shown, taking care to follow the cable guides and clips.

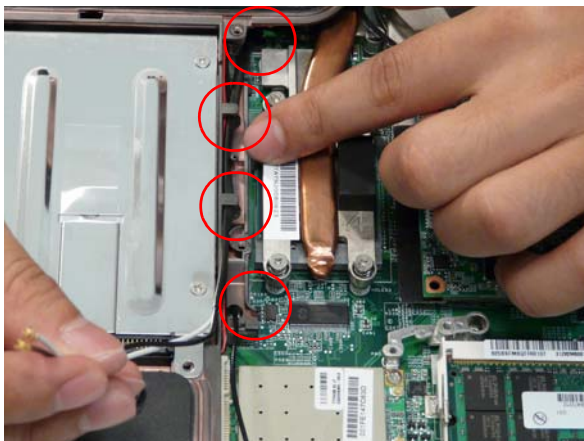

Replacing the Speaker Module

1. Align and replace the Speaker Module in the lower case.
2. Reconnect the speaker cable as shown.

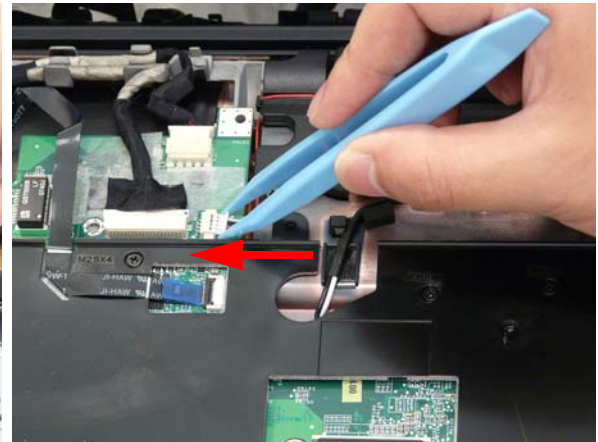

3. Place subwoofer module in to the lower case and replace the five securing screws.

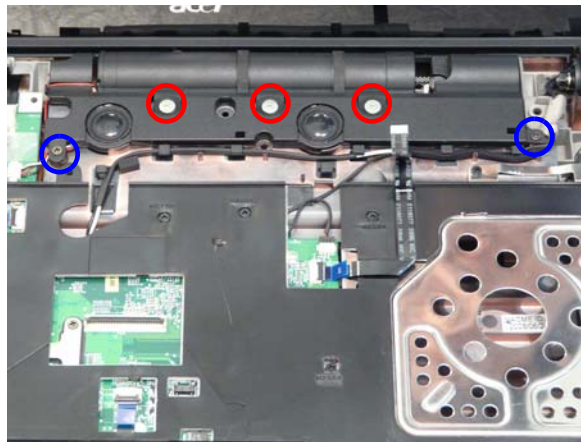

Replacing the Keyboard

1. Align the FFC with the connector and press the latch down to secure.
2. Turn the keyboard over and press down to secure.

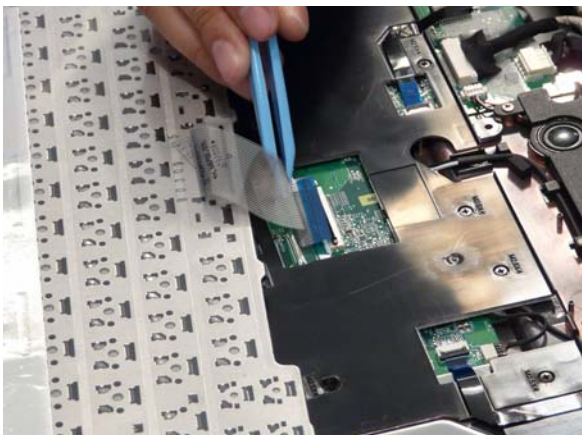

Replacing the Power Board

1. Place the power board in the switch cover as shown.

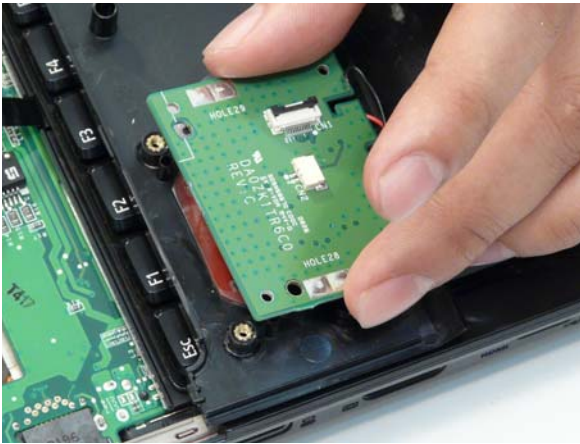

2. Replace the three securing screws.

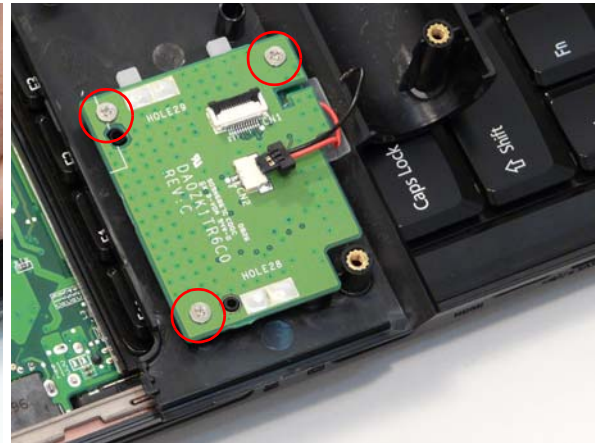

3. Reconnect the cable and FFC as shown.

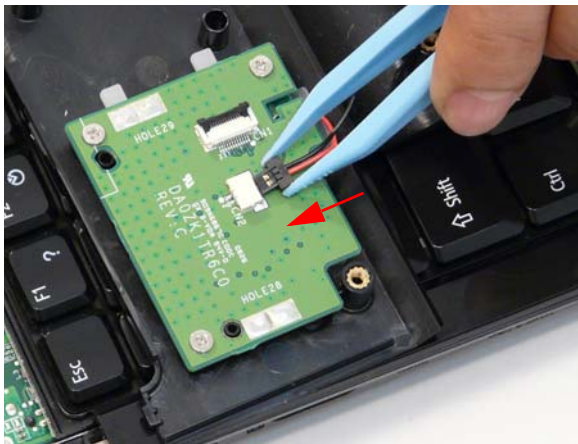

Replacing the Switch Cover

1. Locate the following FFC cables.



2. Reconnect the Power Board FFC.



3. Reconnect the Launch Board FFC.



4. Turn the switch board over.



5. Press down on the edges of the Switch Cover first.



6. Snap the Switch Cover in to place by pressing down in the centre of the cover.



7. Turn the computer over and replace the ten screws as shown.



Replacing the Second Hard Disk Drive Module

1. Place the HDD in the HDD carrier.

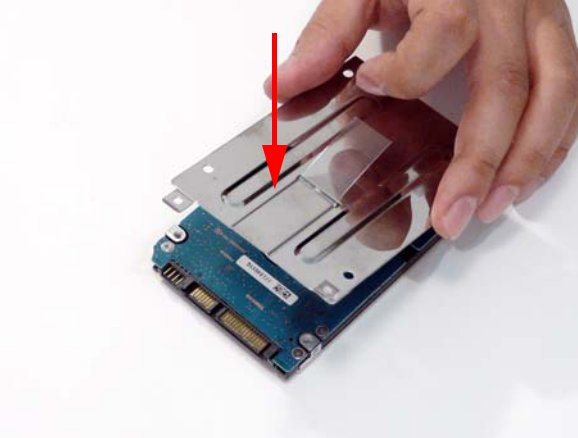

2. Replace the four screws to secure the carrier.

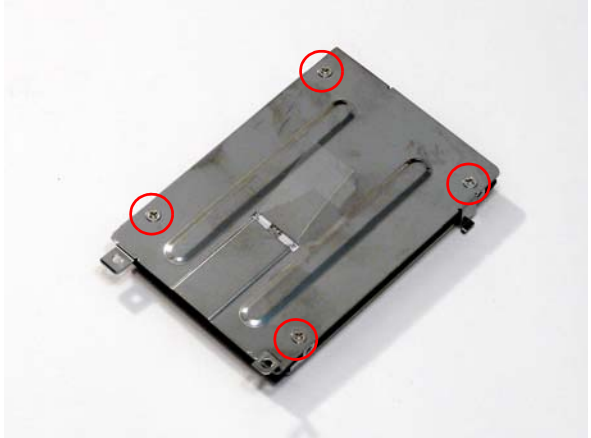

3. Replace the HDD and slide to the right to connect the HDD interface.



4. Replace the two securing screws as shown.



Replacing the ODD Module

1. With the ODD tray in the eject position, replace the ODD cover on the ODD Module.



2. Turn the ODD over and replace the ODD bracket.



3. Slide the module in to the chassis and press until module is flush with the chassis.



4. Replace the single securing screw as shown.



Replacing the Main Hard Disk Drive Module

1. Replace the HDD connector.



2. Place the HDD in the HDD carrier.



3. Replace the four screws to secure the carrier.

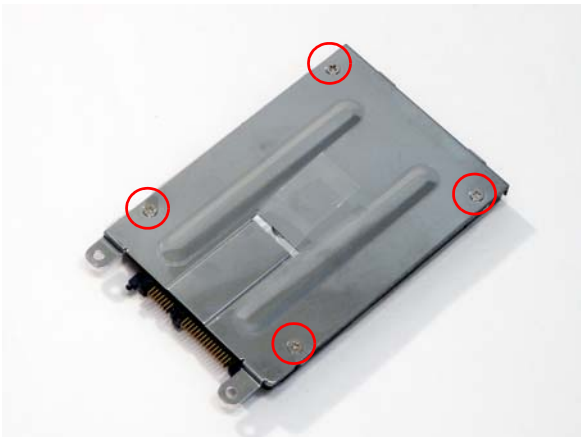

4. Insert the back first and angle the HDD in place. Push down to connect the HDD interface.

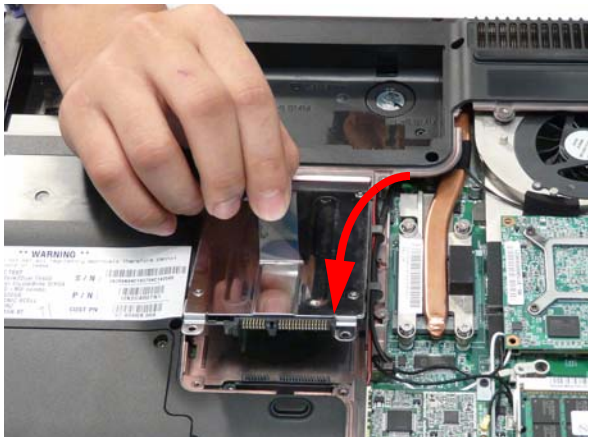

Replacing the WLAN Module

1. Insert the WLAN board into the WLAN socket.

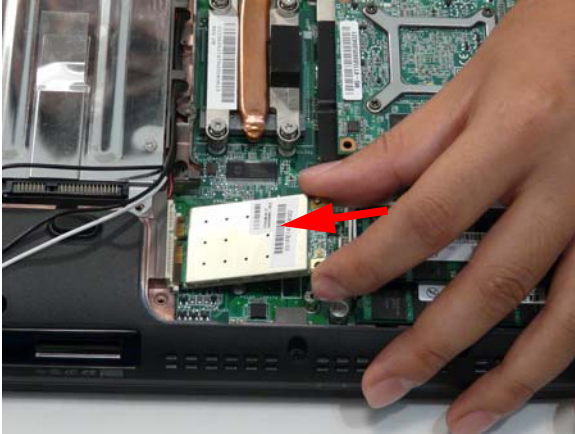

2. Replace the two screws to secure the module.

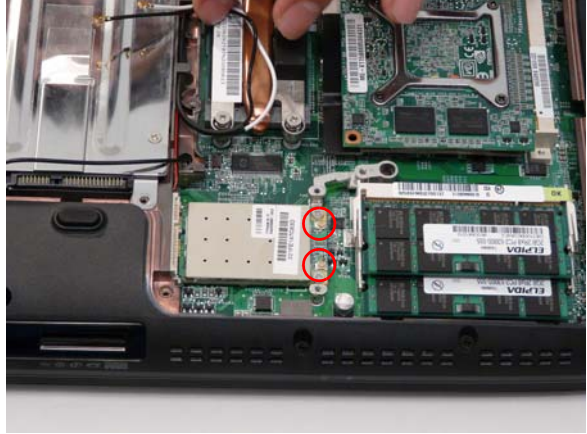

3. Connect the two antenna cables to the module.
NOTE: The White cable goes to the upper terminal and the black cable to the lower terminal.

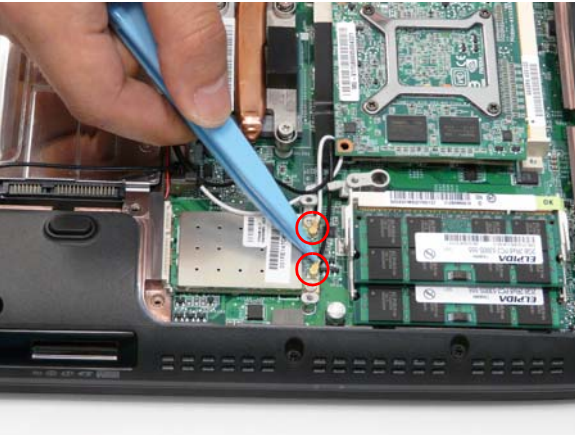

4. Ensure that the cabling is replaced as shown to avoid trapping when the covers are replaced.

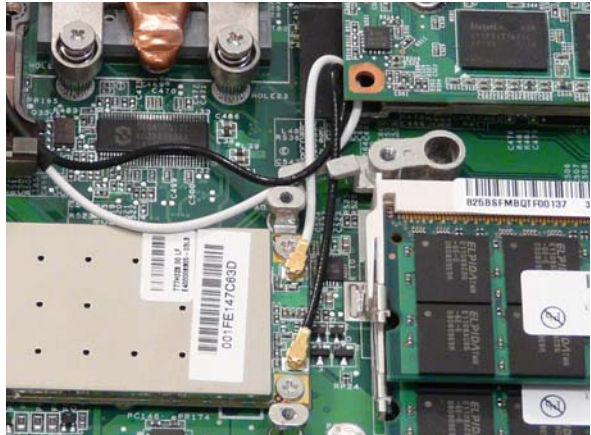

Replacing the TV Tuner Module

1. Insert the TV Tuner into the bracket as shown.
2. Insert the TV Tuner in to the socket.

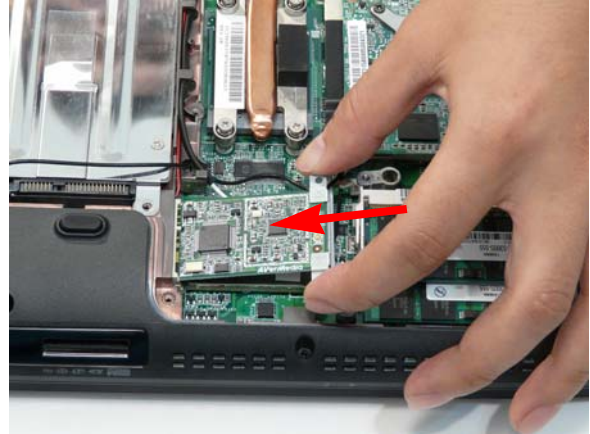
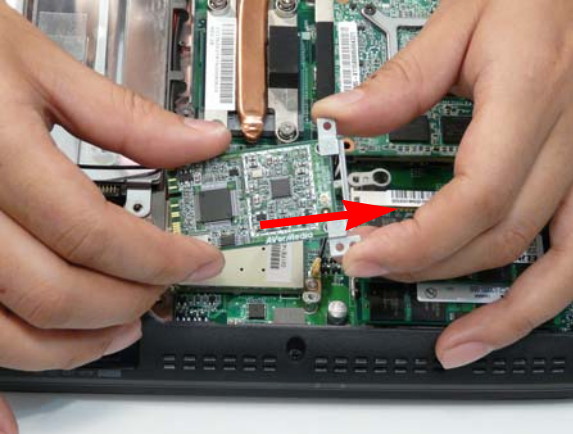

3. Replace the two securing screws.
4. Attach the cable as shown, ensuring that the TV Tuner antenna follows the installation pattern of the LCD antenna cables.

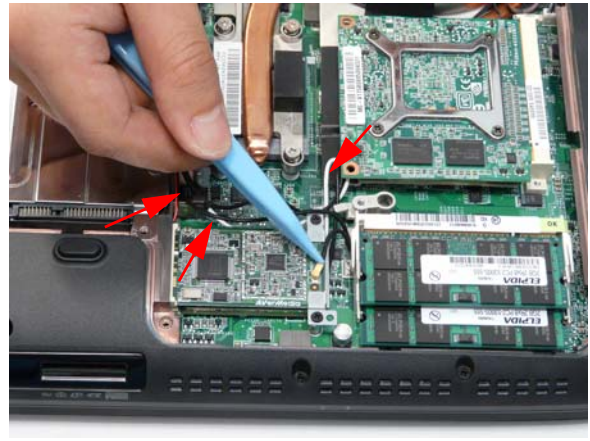
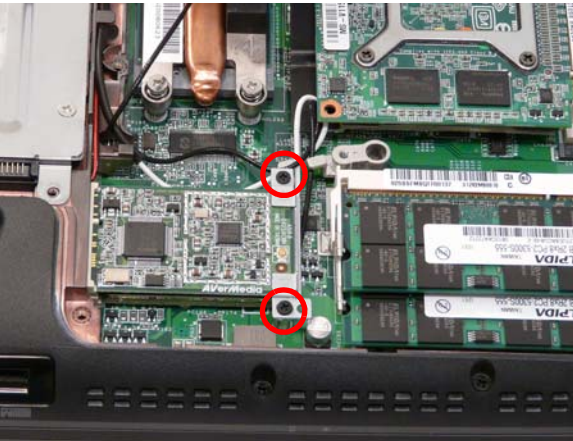

Replacing the VGA Module

1. Insert the VGA module into the socket as shown.
2. Replace the four securing screws.

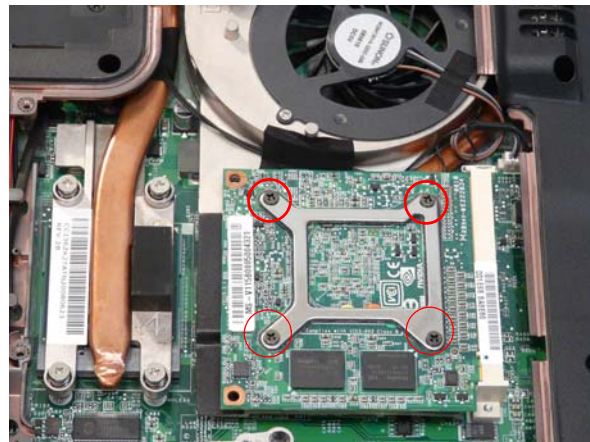
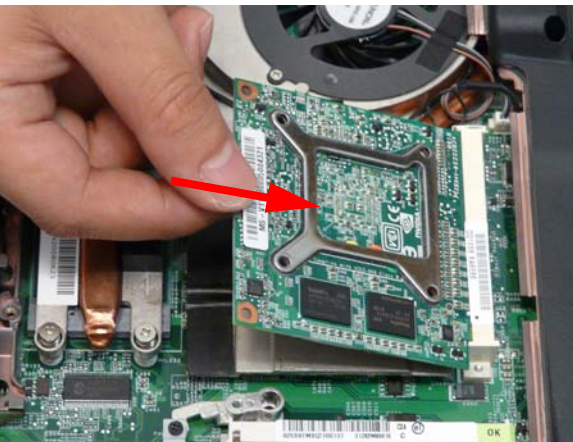

Replacing the DIMM Modules

NOTE: To replace DIMM Module 2, first remove DIMM Module 1. In this procedure, only DIMM Module 1 is shown.

1. Insert the DIMM Module flush with the connector and press down to lock in place.

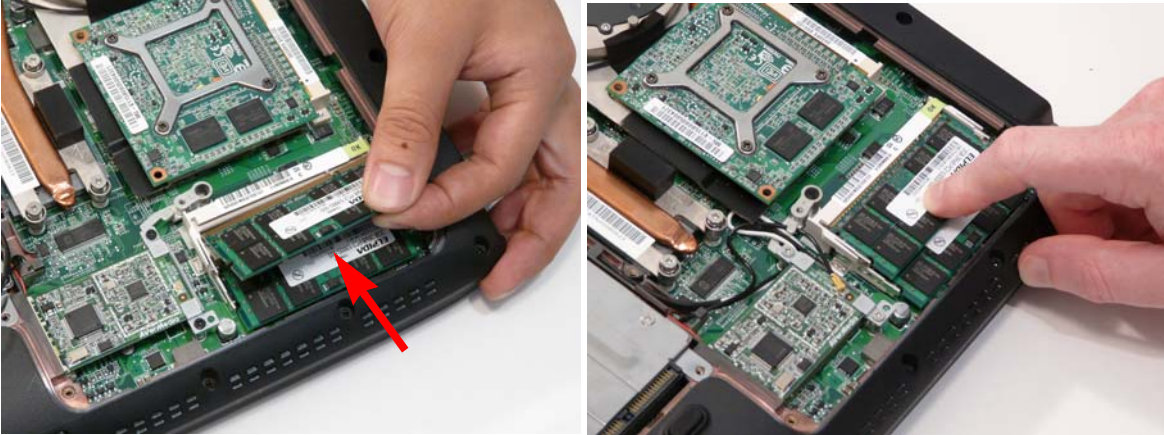

Replacing the Lower Covers

1. Replace the HDD2 and Lower Covers and secure the captive screws.

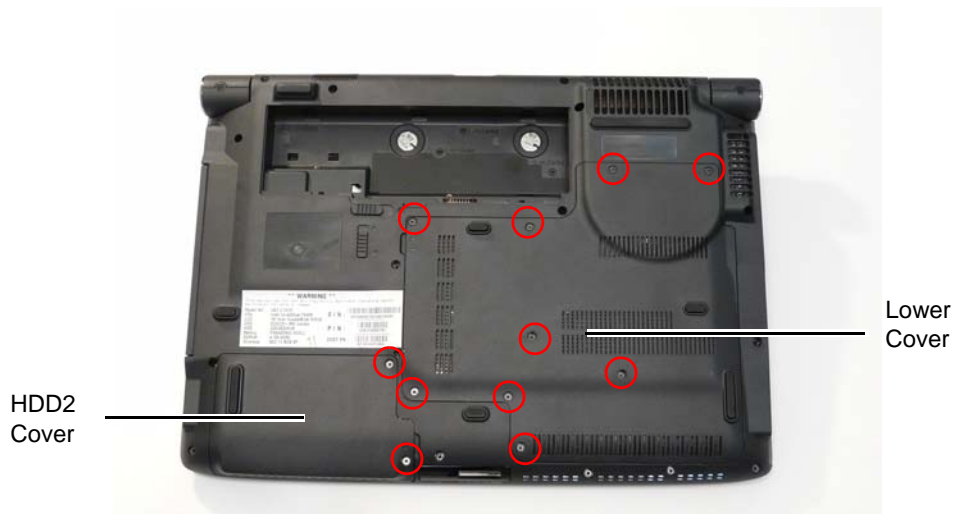

Replacing the ExpressCard and SD Card Dummy Trays

1. Insert the ExpressCard and push into the slot until flush with the chassis cover.
2. Insert the SD Card and push into the slot until flush with the chassis cover.

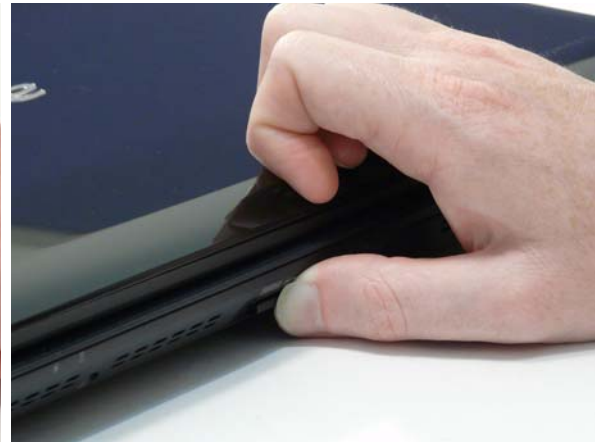

Troubleshooting

Common Problems

Use the following procedure as a guide for computer problems.

NOTE: The diagnostic tests are intended to test only Acer products. Non-Acer products, prototype cards, or modified options can give false errors and invalid system responses.

1. Obtain the failing symptoms in as much detail as possible.
2. Verify the symptoms by attempting to re-create the failure by running the diagnostic test or by repeating the same operation.
3. Use the following table with the verified symptom to determine which page to go to.

Symptoms (Verified)	Go To
Power On Issue	Page 124
No Display Issue	Page 125
LCD Failure	Page 127
Internal Keyboard Failure	Page 127
Touchpad Failure	Page 128
Internal Speaker Failure	Page 128
Internal Microphone Failure	Page 130
Rightside USB Failure	Page 134
Other Functions Failure	Page 135
Intermittent Failures	Page 136
Undetermined Failures	Page 136

4. If the Issue is still not resolved, see "Online Support Information" on page 225.

Power On Issue

If the system doesn't power on, perform the following actions one at a time to correct the problem. Do not replace a non-defective FRUs:

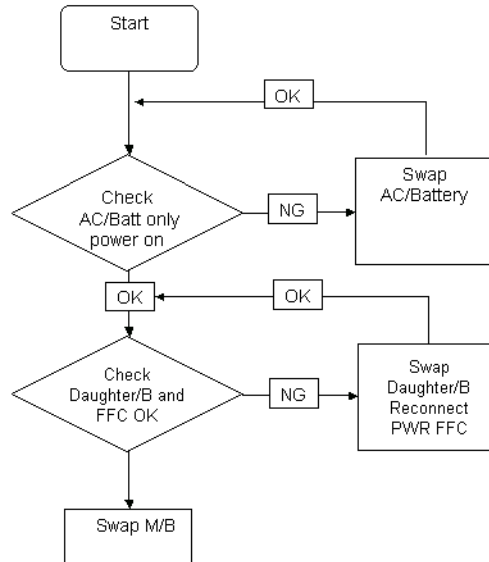

Computer Shutdown Intermittently

If the system powers off at intervals, perform the following actions one at a time to correct the problem.

1. Check the power cable is properly connected to the computer and the electrical outlet.
2. Remove any extension cables between the computer and the outlet.
3. Remove any surge protectors between the computer and the electrical outlet. Plug the computer directly into a known good electrical outlet.
4. Disconnect the power and open the casing to check the Thermal Unit and fan airways are free of obstructions.
5. Remove all external and non-essential hardware connected to the computer that are not necessary to boot the computer to the failure point.
6. Remove any recently installed software.
7. If the Issue is still not resolved, see "Online Support Information" on page 225.

No Display Issue

If the **Display** doesn't work, perform the following actions one at a time to correct the problem. Do not replace a non-defective FRUs:

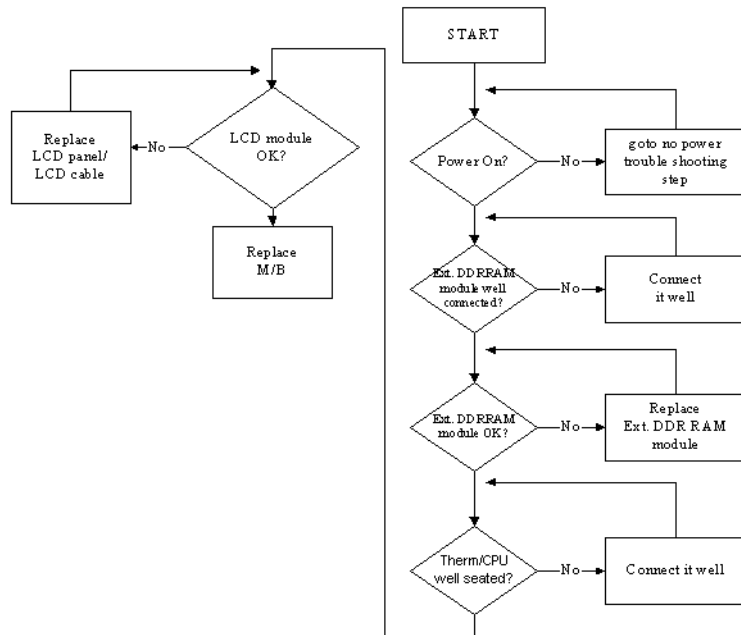

No POST or Video

If the POST or video doesn't display, perform the following actions one at a time to correct the problem.

1. Make sure that the internal display is selected. On this notebook model, switching between the internal display and the external display is done by pressing **Fn+F5**. Reference Product pages for specific model procedures.
2. Make sure the computer has power by checking at least one of the following occurs:
 - Fans start up
 - Status LEDs light up

If there is no power, see "Power On Issue" on page 124.

3. Drain any stored power by removing the power cable and battery and holding down the power button for 10 seconds. Reconnect the power and reboot the computer.
4. Connect an external monitor to the computer and switch between the internal display and the external display is by pressing **Fn+F5** (on this model).

If the POST or video appears on the external display, see "LCD Failure" on page 127.

5. Disconnect power and all external devices including port replicators or docking stations. Remove any memory cards and CD/DVD discs. Restart the computer.

If the computer boots correctly, add the devices one by one until the failure point is discovered.

6. Reseat the memory modules.
7. Remove the drives (see "Disassembly Process" on page 48).
8. If the Issue is still not resolved, see "Online Support Information" on page 225.

Abnormal Video Display

If video displays abnormally, perform the following actions one at a time to correct the problem.

1. Reboot the computer.
2. If permanent vertical/horizontal lines or dark spots display in the same location, the LCD is faulty and should be replaced. See "Disassembly Process" on page 48.
3. If extensive pixel damage is present (different colored spots in the same locations on the screen), the LCD is faulty and should be replaced. See "Disassembly Process" on page 48.
4. Adjust the brightness to its highest level. See the User Manual for instructions on adjusting settings.
NOTE: Ensure that the computer is not running on battery alone as this may reduce display brightness.
If the display is too dim at the highest brightness setting, the LCD is faulty and should be replaced. See "Disassembly Process" on page 48.
5. Check the display resolution is correctly configured:
 - a. Minimize or close all Windows.
 - b. If display size is only abnormal in an application, check the view settings and control/mouse wheel zoom feature in the application.
 - c. If desktop display resolution is not normal, right-click on the desktop and select **Personalize**→ **Display Settings**.
 - d. Click and drag the Resolution slider to the desired resolution.
 - e. Click **Apply** and check the display. Readjust if necessary.
6. Roll back the video driver to the previous version if updated.
7. Remove and reinstall the video driver.
8. Check the Device Manager to determine that:
 - The device is properly installed. There are no red Xs or yellow exclamation marks.
 - There are no device conflicts.
 - No hardware is listed under Other Devices.
9. If the Issue is still not resolved, see "Online Support Information" on page 225.
10. Run the Windows Memory Diagnostic from the operating system DVD and follow the onscreen prompts.
11. If the Issue is still not resolved, see "Online Support Information" on page 225.

Random Loss of BIOS Settings

If the computer is experiencing intermittent loss of BIOS information, perform the following actions one at a time to correct the problem.

1. If the computer is more than one year old, replace the CMOS battery.
2. Run a complete virus scan using up-to-date software to ensure the computer is virus free.
3. If the computer is experiencing HDD or ODD BIOS information loss, disconnect and reconnect the power and data cables between devices.
If the BIOS settings are still lost, replace the cables.
4. If HDD information is missing from the BIOS, the drive may be defective and should be replaced.
5. Replace the Motherboard.
6. If the Issue is still not resolved, see "Online Support Information" on page 225.

LCD Failure

If the **LCD** fails, perform the following actions one at a time to correct the problem. Do not replace a non-defective FRUs:

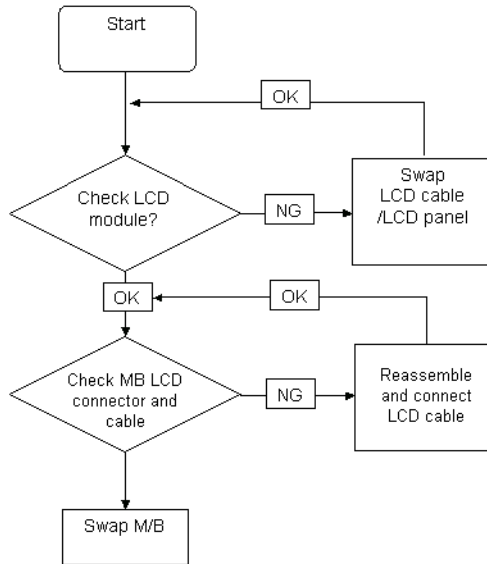

Built-In Keyboard Failure

If the built-in **Keyboard** fails, perform the following actions one at a time to correct the problem. Do not replace a non-defective FRUs:

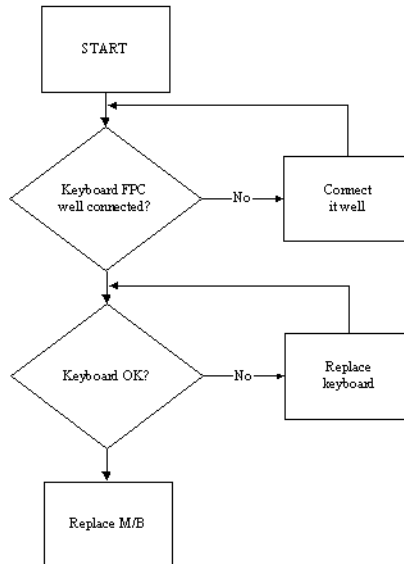

Touchpad Failure

If the **Touchpad** doesn't work, perform the following actions one at a time to correct the problem. Do not replace a non-defective FRUs:

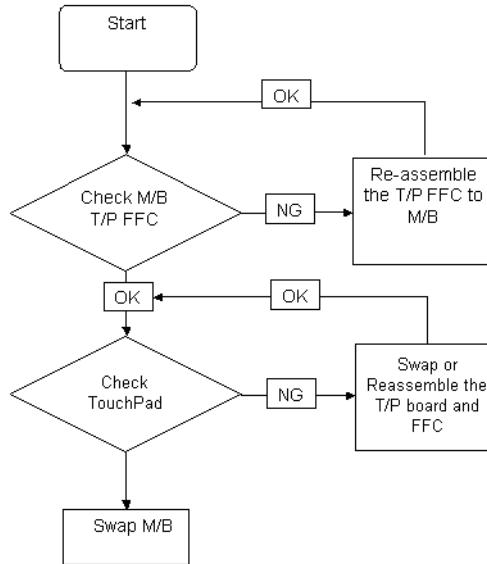

Internal Speaker Failure

If the internal **Speakers** fail, perform the following actions one at a time to correct the problem. Do not replace a non-defective FRUs:

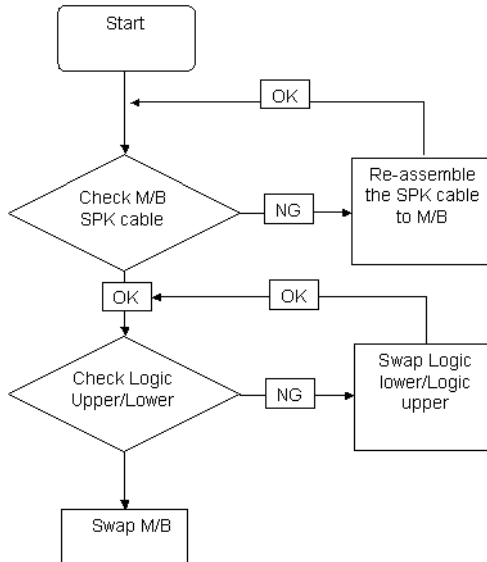

Sound Problems

If sound problems are experienced, perform the following actions one at a time to correct the problem.

1. Reboot the computer.
2. Navigate to **Start** → **Control Panel** → **System and Maintenance** → **System** → **Device Manager**. Check the Device Manager to determine that:
 - The device is properly installed.
 - There are no red Xs or yellow exclamation marks.
 - There are no device conflicts.
 - No hardware is listed under Other Devices.
3. Roll back the audio driver to the previous version, if updated recently.
4. Remove and reinstall the audio driver.
5. Ensure that all volume controls are set mid range:
 - a. Click the volume icon on the taskbar and drag the slider to 50. Ensure that the volume is not muted.
 - b. Click Mixer to verify that other audio applications are set to 50 and not muted.
6. Navigate to **Start** → **Control Panel** → **Hardware and Sound** → **Sound**. Ensure that Speakers are selected as the default audio device (green check mark).

NOTE: If Speakers does not show, right-click on the **Playback** tab and select **Show Disabled Devices** (clear by default).
7. Select Speakers and click **Configure** to start **Speaker Setup**. Follow the onscreen prompts to configure the speakers.
8. Remove and recently installed hardware or software.
9. Restore system and file settings from a known good date using **System Restore**.

If the issue is not fixed, repeat the preceding steps and select an earlier time and date.
10. Reinstall the Operating System.
11. If the Issue is still not resolved, see "Online Support Information" on page 225.

Internal Microphone Failure

If the internal **Microphone** fails, perform the following actions one at a time to correct the problem. Do not replace a non-defective FRUs:

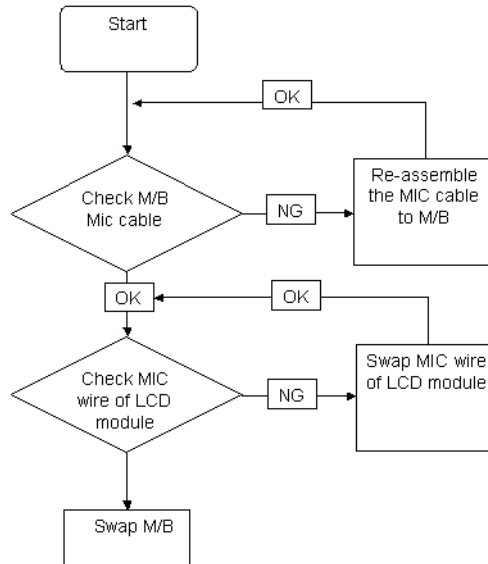

Microphone Problems

If internal or external **Microphones** do not operate correctly, perform the following actions one at a time to correct the problem.

1. Check that the microphone is enabled. Navigate to **Start** → **Control Panel** → **Hardware and Sound** → **Sound** and select the **Recording** tab.
2. Right-click on the **Recording** tab and select **Show Disabled Devices** (clear by default).
3. The microphone appears on the **Recording** tab.
4. Right-click on the microphone and select **Enable**.
5. Select the microphone then click **Properties**. Select the **Levels** tab.
6. Increase the volume to the maximum setting and click **OK**.
7. Test the microphone hardware:
 - a. Select the microphone and click **Configure**.
 - b. Select **Set up microphone**.
 - c. Select the microphone type from the list and click **Next**.
 - d. Follow the onscreen prompts to complete the test.
8. If the Issue is still not resolved, see "Online Support Information" on page 225.

HDD Not Operating Correctly

If the **HDD** does not operate correctly, perform the following actions one at a time to correct the problem.

1. Disconnect all external devices.
2. Run a complete virus scan using up-to-date software to ensure the computer is virus free.
3. Run the Windows Vista Startup Repair Utility:
 - a. insert the Windows Vista Operating System DVD in the ODD and restart the computer.
 - b. When prompted, press any key to start to the operating system DVD.
 - c. The **Install Windows** screen displays. Click **Next**.
 - d. Select **Repair your computer**.
 - e. The **System Recovery Options** screen displays. Click **Next**.
 - f. Select the appropriate operating system, and click **Next**.

NOTE: Click **Load Drivers** if controller drives are required.

- g. Select **Startup Repair**.
- h. Startup Repair attempts to locate and resolve issues with the computer.
- i. When complete, click **Finish**.

If an issue is discovered, follow the onscreen information to resolve the problem.

4. Run the Windows Memory Diagnostic Tool. For more information see Windows Help and Support.
5. Restart the computer and press F2 to enter the BIOS Utility. Check the BIOS settings are correct and that CD/DVD drive is set as the first boot device on the Boot menu.
6. Ensure all cables and jumpers on the HDD and ODD are set correctly.
7. Remove any recently added hardware and associated software.
8. Run the Windows Disk Defragmenter. For more information see Windows Help and Support.
9. Run Windows Check Disk by entering **chkdsk /r** from a command prompt. For more information see Windows Help and Support.
10. Restore system and file settings from a known good date using **System Restore**.
If the issue is not fixed, repeat the preceding steps and select an earlier time and date.
11. Replace the HDD. See "Disassembly Process" on page 48.

ODD Not Operating Correctly

If the **ODD** exhibits any of the following symptoms it may be faulty:

- Audio CDs do not play when loaded
- DVDs do not play when loaded
- Blank discs do not burn correctly
- DVD or CD play breaks up or jumps
- Optical drive not found or not active:
 - Not shown in My Computer or the BIOS setup
 - LED does not flash when the computer starts up
 - The tray does not eject
- Access failure screen displays
- The ODD is noisy

Perform the following general solutions one at a time to correct the problem.

1. Reboot the computer and retry the operation.

-
2. Try an alternate disc.
 3. Navigate to **Start**→ **Computer**. Check that the ODD device is displayed in the **Devices with Removable Storage** panel.
 4. Navigate to **Start**→ **Control Panel**→ **System and Maintenance**→ **System**→ **Device Manager**.
 - a. Double-click **IDE ATA/ATAPI controllers**. If a device displays a down arrow, right-click on the device and click **Enable**.
 - b. Double-click **DVD/CD-ROM drives**. If the device displays a down arrow, right-click on the device and click **Enable**.
 - c. Check that there are no yellow exclamation marks against the items in **IDE ATA/ATAPI controllers**. If a device has an exclamation mark, right-click on the device and uninstall and reinstall the driver.
 - d. Check that there are no yellow exclamation marks against the items in **DVD/CD-ROM drives**. If a device has an exclamation mark, right-click on the device and uninstall and reinstall the driver.
 - e. If the exclamation marker is not removed from the item in the lists, try removing any recently installed software and retrying the operation.

Discs Do Not Play

If discs do not play when inserted in the drive, perform the following actions one at a time to correct the problem.

1. Check that the disc is correctly seated in the drive tray and that the label on the disc is visible.
2. Check that the media is clean and scratch free.
3. Try an alternate disc in the drive.
4. Ensure that **AutoPlay** is enabled:
 - a. Navigate to **Start**→ **Control Panel**→ **Hardware and Sound**→ **AutoPlay**.
 - b. Select **Use AutoPlay for all media and devices**.
 - c. In the Audio CD and DVD Movie fields, select the desired player from the drop down menu.
5. Check that the Regional Code is correct for the selected media:

IMPORTANT:Region can only be changed a limited number of times. After Changes remaining reaches zero, the region cannot be changed even Windows is reinstalled or the drive is moved to another computer.

- a. Navigate to **Start**→ **Control Panel**→ **System and Maintenance**→ **System**→ **Device Manager**.
- b. Double-click **DVD/CD-ROM drives**.
- c. Right-click **DVD drive** and click **Properties**, then click the **DVD Region** tab.
- d. Select the region suitable for the media inserted in the drive.

Discs Do Not Burn Properly

If discs can not be burned, perform the following actions one at a time to correct the problem.

1. Ensure that the default drive is record enabled:
 - a. Navigate to **Start**→ **Computer** and right-click the writable ODD icon. Click **Properties**.
 - b. Select the **Recording** tab. In the **Desktop disc recording** panel, select the writable ODD from the drop down list.
 - c. Click **OK**.
2. Ensure that the software used for burning discs is the factory default. If using different software, refer to the software's user manual.

Playback is Choppy

If playback is choppy or jumps, perform the following actions one at a time to correct the problem.

1. Check that system resources are not running low:

-
- a. Try closing some applications.
 - b. Reboot and try the operation again.
 2. Check that the ODD controller transfer mode is set to DMA:
 - a. Navigate to **Start** → **Control Panel** → **System and Maintenance** → **System** → **Device Manager**.
 - b. Double-click **IDE ATA/ATAPI controllers**, then right-click ATA Device 0.
 - c. Click **Properties** and select the **Advanced Settings** tab. Ensure that the **Enable DMA** box is checked and click **OK**.
 - d. Repeat for the other ATA Devices shown if applicable.

Drive Not Detected

If Windows cannot detect the drive, perform the following actions one at a time to correct the problem.

1. Restart the computer and press F2 to enter the BIOS Utility.
2. Check that the drive is detected in the **ATAPI Model Name** field on the Information page.
NOTE: Check that the entry is identical to one of the ODDs specified in “Hardware Specifications and Configurations” on page 18.
3. Turn off the power and remove the cover to inspect the connections to the ODD. See “Disassembly Process” on page 48.
 - a. Check for broken connectors on the drive, motherboard, and cables.
 - b. Check for bent or broken pins on the drive, motherboard, and cable connections.
 - c. Try an alternate cable, if available. If the drive works with the new cable, the original cable should be replaced.
4. Reseat the drive ensuring and all cables are connected correctly.
5. Replace the ODD. See “Disassembly Process” on page 48.

Drive Read Failure

If discs cannot be read when inserted in the drive, perform the following actions one at a time to correct the problem.

1. Remove and clean the failed disc.
2. Retry reading the CD or DVD.
 - d. Test the drive using other discs.
 - e. Play a DVD movie
 - f. Listen to a music CD

If the ODD works properly with alternate discs, the original disc is probably defective and should be replaced.

3. Turn off the power and remove the cover to inspect the connections to the ODD. See “Disassembly Process” on page 48.
 - a. Check for broken connectors on the drive, motherboard, and cables.
 - b. Check for bent or broken pins on the drive, motherboard, and cable connections.
 - c. Try an alternate cable, if available. If the drive works with the new cable, the original cable should be replaced.
4. Replace the ODD. See “Disassembly Process” on page 48.

USB Failure (Rightside)

If the rightside **USB** port fails, perform the following actions one at a time to correct the problem. Do not replace a non-defective FRUs:

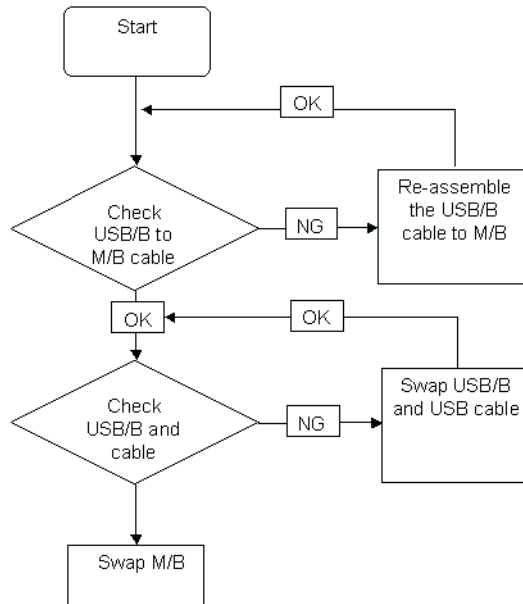

External Mouse Failure

If an external **Mouse** fails, perform the following actions one at a time to correct the problem.

1. Try an alternative mouse.
2. If the mouse uses a wireless connection, insert new batteries and confirm there is a good connection. See the mouse user manual.
3. If the mouse uses a USB connection, try an alternate USB port.
4. Try an alternative program to verify mouse operation. Reinstall the program experiencing mouse failure.
5. Restart the computer.
6. Remove any recently added hardware and associated software.
7. Remove any recently added software and reboot.
8. Restore system and file settings from a known good date using **System Restore**.
If the issue is not fixed, repeat the preceding steps and select an earlier time and date.
9. Run the Event Viewer to check the events log for errors. For more information see Windows Help and Support.
10. Roll back the mouse driver to the previous version if updated recently.
11. Remove and reinstall the mouse driver.
12. Check the Device Manager to determine that:
 - The device is properly installed. There are no red Xs or yellow exclamation marks.
 - There are no device conflicts.
 - No hardware is listed under Other Devices.
13. If the Issue is still not resolved, see "Online Support Information" on page 225.

Other Failures

If the CRT Switch, Dock, LAN Port, external MIC or Speakers, PCI Express Card, 5-in-1 Card Reader or Volume Wheel fail, perform the following general steps to correct the problem. Do not replace a non-defective FRUs:

1. Check Drive whether is OK.
2. Check Test Fixture is ok.
3. Swap M/B to Try.

Intermittent Problems

Intermittent system hang problems can be caused by a variety of reasons that have nothing to do with a hardware defect, such as: cosmic radiation, electrostatic discharge, or software errors. FRU replacement should be considered only when a recurring problem exists.

When analyzing an intermittent problem, do the following:

1. Run the advanced diagnostic test for the system board in loop mode at least 10 times.
2. If no error is detected, do not replace any FRU.
3. If any error is detected, replace the FRU. Rerun the test to verify that there are no more errors.

Undetermined Problems

The diagnostic problems does not identify which adapter or device failed, which installed devices are incorrect, whether a short circuit is suspected, or whether the system is inoperative.

Follow these procedures to isolate the failing FRU (do not isolate non-defective FRU).

NOTE: Verify that all attached devices are supported by the computer.

NOTE: Verify that the power supply being used at the time of the failure is operating correctly. (See "Power On Issue" on page 124.):

1. Power-off the computer.
2. Visually check them for damage. If any problems are found, replace the FRU.
3. Remove or disconnect all of the following devices:
 - Non-Acer devices
 - Printer, mouse, and other external devices
 - Battery pack
 - Hard disk drive
 - DIMM
 - CD-ROM/Diskette drive Module
 - PC Cards
4. Power-on the computer.
5. Determine if the problem has changed.
6. If the problem does not recur, reconnect the removed devices one at a time until you find the failing FRU.
7. If the problem remains, replace the following FRU one at a time. Do not replace a non-defective FRU:
 - System board
 - LCD assembly

POST Codes Tables

These tables describe the POST codes, drivers, and keys for the POST.

Chipset POST Codes

The following table details the Chipset POST codes and components used in the POST.

POST Code	Function	Phase	Component
0xA0	MRC Entry	PEI	chipset/MRC
0x01	Enable MCHBAR	PEI	chipset/MRC
0x02	Check ME existence	PEI	chipset/MRC
0x03	Check for DRAM initialization interrupt and reset fail	PEI	chipset/MRC
0x04	Determine the system Memory type based on first populated socket	PEI	chipset/MRC
0x05	Verify all DIMMs are DDR2 and SO-DIMMS, which are unbuffered	PEI	chipset/MRC
0x06	Verify all DIMMs are Non-ECC	PEI	chipset/MRC
0x07	Verify all DIMMs are single or double sided and not mixed	PEI	chipset/MRC
0x08	Verify all DIMMs are x8 or x16 width	PEI	chipset/MRC
0x09	Calculate number of Row and Column bits	PEI	chipset/MRC
0x10	Calculate number of banks for each DIMM	PEI	chipset/MRC
0x11	Determine raw card type	PEI	chipset/MRC
0x12	Find a common CAS latency between the DIMMS and the MCH	PEI	chipset/MRC
0x13	Determine the memory frequency and CAS latency to program	PEI	chipset/MRC
0x14	Determine the smallest common timing value for all DIMMS	PEI	chipset/MRC
0x17	Power management resume	PEI	chipset/MRC
0x18	Program DRAM type (DDR2/DDR3) and Power up sequence	PEI	chipset/MRC
0x19	Program the correct system memory frequency	PEI	chipset/MRC
0x20	Program the correct Graphics memory frequency	PEI	chipset/MRC
0x21	Early DRC initialization	PEI	chipset/MRC
0x22	Program the DRAM Row Attributes and DRAM Row Boundary registers PRE JEDEC.	PEI	chipset/MRC
0x23	Program the RCOMP SRAM registers	PEI	chipset/MRC
0x24	Program DRAM type (DDR2/DDR3) and Power up sequence	PEI	chipset/MRC
0x25	Program the DRAM Timing	PEI	chipset/MRC
0x26	Program the DRAM Bank Architecture register	PEI	chipset/MRC
0x27	Enable all clocks on populated rows	PEI	chipset/MRC
0x28	Program MCH ODT	PEI	chipset/MRC
0x29	Program tRD	PEI	chipset/MRC
0x30	Miscellaneous Pre JEDEC steps	PEI	chipset/MRC
0x31	Program clock crossing registers	PEI	chipset/MRC
0x32	Program the Egress port timings	PEI	chipset/MRC
0x33	Program the Memory IO registers	PEI	chipset/MRC
0x34	Perform steps required before JEDEC	PEI	chipset/MRC
0x35	Perform JEDEC memory initialization for all memory rows	PEI	chipset/MRC

POST Code	Function	Phase	Component
0x36	Setup DRAM control register for normal operation and enable	PEI	chipset/MRC
0x37	Do ZQ calibration for DDR3	PEI	chipset/MRC
0x38	Perform final Dra/Drb programming, Set the mode of operation for the memory channels	PEI	chipset/MRC
0x39	Set Enhanced addressing mode for each channel	PEI	chipset/MRC
0x40	Perform steps required after JEDEC init	PEI	chipset/MRC
0x41	Program the receive enable reference timing control register	PEI	chipset/MRC
0x42	Post receive enable initialization	PEI	chipset/MRC
0x43	Enable sense amps. Reset read/write DQS pointers	PEI	chipset/MRC
0x44	Perform ME steps	PEI	chipset/MRC
0x45	Clear DRAM initialization bit in the ICH.	PEI	chipset/MRC
0x46	Program Thermal Management	PEI	chipset/MRC
0x47	Program TS on DIMM	PEI	chipset/MRC
0x48	Program TS on Board	PEI	chipset/MRC
0xAF	Exit MRC	PEI	chipset/MRC
0xE0	#define MEM_ERR_BAD_DIMM (S11)	PEI	chipset/MRC
0xE1	#define MEM_ERR_ECC_DIMM (S06)	PEI	chipset/MRC
0xE2	#define MEM_ERR_SIDES (S07)	PEI	chipset/MRC
0xE3	#define MEM_ERR_WIDTH (S08, S10)	PEI	chipset/MRC
0xE4	#define MEM_ERR_TRFC (FindTrasTrpTrcd)	PEI	chipset/MRC
0xE5	#define MEM_ERR_CAS_LATENCY (S12, S13)	PEI	chipset/MRC
0xE6	#define MEM_ERR_REFRESH (ProgDrt)	PEI	chipset/MRC
0xE7	#define MEM_ERR_BL8 (S14)	PEI	chipset/MRC
0xE9	#define MEM_ERR_FREQUENCY (findTCLTacTCIk, S13, S12, ProgramGraphicsFrequency, ProgMchOdt, GetPlatformData)	PEI	chipset/MRC
0xEA	#define MEM_ERR_SIZE (S14)	PEI	chipset/MRC
0xEC	#define MEM_ERR_TRAS (FindTrasTrpTrcd)	PEI	chipset/MRC
0xED	#define MEM_ERR_TRP (FindTrasTrpTrcd)	PEI	chipset/MRC
0xEE	#define MEM_ERR_TRCD (FindTrasTrpTrcd)	PEI	chipset/MRC
0xEF	#define MEM_ERR_TWR (FindTrasTrpTrcd)	PEI	chipset/MRC
0xF0	#define MEM_ERR_RCVEN_FINDLOW (CalibrateRcvenForGroup)	PEI	chipset/MRC
0xF1	#define MEM_ERR_RCVEN_FINDEGE (CalibrateRcvenForGroup)	PEI	chipset/MRC
0xF2	#define MEM_ERR_RCVEN_FINDPREAMBLE (CalibrateRcvenForGroup)	PEI	chipset/MRC
0xF6	#define MEM_ERR_RCVEN_PREAMBLEEDGE (CalibrateRcvenForGroup)	PEI	chipset/MRC
0xF3	#define MEM_ERR_RCVEN_FINDCENTER (CalibrateRcvenForGroup)	PEI	chipset/MRC
0xF4	#define MEM_ERR_TYPE (S11, S04)	PEI	chipset/MRC
0xF5	#define MEM_ERR_RAWCARD (S11)	PEI	chipset/MRC
0xFA	#define MEM_ERR_SFF (ProgWrioDII)	PEI	chipset/MRC
0xFB	#define MEM_ERR_THERMAL (ProgramThrottling)	PEI	chipset/MRC

POST Code	Function	Phase	Component
0xA0xx	Launch BIOS ACMSclean	PEI	chipset/MRC
0xA4xx	Launch BIOS ACMScheck	PEI	chipset/MRC
0xE5	Wait for ME ready	DXE	HECI/iAMT
0xE6	ME Ready	DXE	HECI/iAMT

Core POST Code Table

The following table details the core POST codes and functions used in SecureCore.

POST Code	Function	Phase	Component
0x00	Early Microcode update for CAR	CEI / SEC	Core
0x01	Enable CAR	CEI / SEC	Core
0x02	CAR Done, initial stack	CEI / SEC	Core
0xEE	unknown CPU ID to load uCode	CEI / SEC	CPU
0xEF	unknown DT CPU to load uCode	CEI / SEC	CPU
0xnn	File count found in a volume	PEI	Core
0x11	Debug Test driver for debug test PPI 1 (If install debugTest driver)	PEI	Core
0x22	Debug Test driver for debug test PPI 2 (If install debugTest driver)	PEI	Core
0x33	Debug Test driver for debug test PPI 3 (If install debugTest driver)	PEI	Core
0x44	Entry point of loadfile	PEI	Core
0x88	Entry point of apMuLoader	PEI	Core
0x80	A PEIM found	PEI	Core
0x82	PEIM not dispatched yet	PEI	Core
0x84	PEIM satisfies depex	PEI	Core
0x86	Image loaded but fail on security	PEI	Core
0x88	Executing a PEIM	PEI	Core
0x8A	Processing notify event for newly installed PPI	PEI	Core
0x8C	Handing off to next phase (DXE)	PEI	Core
0x8F	Fail to hand off to next phase, system halt	PEI	Core
0x90	All PEIM dispatched! Going to DxeIpl	PEI	Core
0xCC	AP Micro-code update	PEI	Core
0x20	S3 resume entry	S3 resume	Core
0x21	Start running Boot-time bootscripts	S3 resume	Core
0x22	Start running Run-time bootscripts	S3 resume	Core
0x23	End of S3 resume, jump back to Waking vector	S3 resume	Core
0x80	Initialize the chipset	Crisis Recovery	Core
0x81	Initialize the bridge	Crisis Recovery	Core
0x82	Initialize the CPU	Crisis Recovery	Core
0x89	Set Huge Segment	Crisis Recovery	Core
0x83	Initialize system timer	Crisis Recovery	Core
0x84	Initialize system I/O	Crisis Recovery	Core
0x88	Initialize Multi Processor	Crisis Recovery	Core

POST Code	Function	Phase	Component
0x8A	Initialize OEM special code	Crisis Recovery	Core
0x8B	Initialize PIC and DMA	Crisis Recovery	Core
0x8C	Initialize Memory type	Crisis Recovery	Core
0x8D	Initialize Memory size	Crisis Recovery	Core
0x8F	Initialize SMM	Crisis Recovery	Core
0x90	System memory test	Crisis Recovery	Core
0x91	Initialize interrupt vectors	Crisis Recovery	Core
0x92	Initialize Run Time Clock	Crisis Recovery	Core
0x99	Initialize security	Crisis Recovery	Core
0x93	Initialize video	Crisis Recovery	Core
0x94	Output one beep	Crisis Recovery	Core
0x98	USB Initialization	Crisis Recovery	Core
0x95	Initialize the installed boot devices	Crisis Recovery	Core
0x96	Clear Huge segment	Crisis Recovery	Core
0x97	Boot Crisis Disk	Crisis Recovery	Core
0x20	DXE starts	DXE	Core
0x30	BIOSPSM	DXE	Core
0x02	BIOSBlockIO	DXE	Core
0x00	BIOSPSM Exception Handler / Divide error	BIOSPSM	Core
0x38	Cannot locate LegacyRegion DXE	BIOSPSM	Core
0xB1	ACPI Support driver Installed	DXE	Core
0xE0	BDS Entry	DXE	Core
0x07	IA32 variable driver entry	DXE	Core
0x0D	consplitter driver entry	DXE	Core
0x10	partition driver entry	DXE	Core
0x49	pciRootBridge driver entry	DXE	Core
0xC6	pciBusDriver entry	DXE	Core
0xE0	Go to legacy BIOS or BDS Entry Point	DXE	Core
0x90	Start Image	DXE	Core
0x90	Start Image Successfully	DXE	Core
0x90	Start Image Failed	DXE	Core
0x33	Debug Test driver for debug test PPI 1	DXE	Core
0x22	Debug Test driver for debug test PPI 2	DXE	Core
0x11	Debug Test driver for debug test PPI 3	DXE	Core
0x02	Invalid event # for measuring Separator Event	DXE	TCG
0x02	Invalid event # for measuring Separator Event	DXE	TCG
0x02	PCR Index over limit (PCR > 23)	DXE	TCG
0x02	TCG copy memory failed	DXE	TCG
0x09	TCG log event failed	DXE	TCG
0x09	Setup event log failed	DXE	TCG
0x12	TIS set active locality failed	DXE	TCG
0x12	TIS relinquish active locality failed	DXE	TCG

POST Code	Function	Phase	Component
0x12	TIS wait command ready failed (prepare to send)	DXE	TCG
0x12	TIS abort 'send 'command due to timeout	DXE	TCG
0x12	TIS abort 'sendAndGo 'command due to timeout	DXE	TCG
0x04	TIS wait bit set failed before send last byte	DXE	TCG
0x12	TIS abort command due to timeout before send last byte	DXE	TCG
0x04	TIS wait bit clear failed when sending last byte	DXE	TCG
0x22	TCG Physical Presence execution	DXE	TCG
0xB1	TCG DXE common pass through	DXE	TCG
0xE3	First Legacy BIOS Task table for legacy reset	LBT	Core
0x20	Verify that DRAM refresh is operating by polling the refresh bit in PORTB.	LBT	Core
0xDA	Dummy PCIE Init entry, now handled by driver	LBT	Core
0x29	PMM (POST Memory Manager) init	LBT	Core
0xE5	WHEA init	LBT	Core
0x33	PDM (Post Dispatcher Manager) init	LBT	Core
0x01	IPMI init	LBT	Core
0xD8	ASF Init	LBT	Core
0x09	Set in-POST flag in CMOS that indicates we are in POST. If this bit is not cleared by postClearBootFlagJ(AEh), the TrustedCore on next boot determines that the current configuration caused POST to fail and uses default values for configuration.	LBT	Core
0x2B	Enhanced CMOS init	LBT	Core
0xE0	EFI Variable Init	LBT	Core
0xC1	PEM (Post Error Manager) init	LBT	Core
0x3B	Debug Service Init (ROM Polit)	LBT	Core
0xDC	POST Update Error	LBT	Core
0x3A	Autosize external cache and program cache size for enabling later in POST.	LBT	Core
0x0B	Enable CPU cache. Set bits in cmos related to cache.	LBT	Core
0x0F	Enable the local bus IDE as primary or secondary depending on other drives detected.	LBT	Core
0x10	Initialize Power Management.	LBT	Core
0x14	Verify that the 8742 keyboard controller is responding. Send a self-test command to the 8742 and wait for results. Also read the switch inputs from the 8742 and write the keyboard controller command byte.	LBT	Core
0x1A	Initialize DMA command register with these settings: 1. Memory to memory disabled 2. Channel 0 hold address disabled 3. Controller enabled 4. Normal timing 5. Fixed priority 6. Late write selection 7. DREQ sense active 8. DACK sense active low. Initialize	LBT	Core

POST Code	Function	Phase	Component
0x22	Reset the keyboard.	LBT	Core
0x40	Test A20 line	LBT	Core
0x67	Quick initialization of all Application Processors in a multi-processor system	LBT	Core
0x32	Compute CPU speed.	LBT	Core
0x69	Initialize the handler for SMM.	LBT	Core
0x6B	If CMOS is bad, load Custom Defaults from flash into CMOS. If successful, reboot.	LBT	Core
0x3C	If CMOS is valid, load chipset registers with values from CMOS, otherwise load defaults and display Setup prompt. If Auto Configuration is enabled, always load the chipset registers with the Setup defaults (Rel 6.0).	LBT	Core
0x3D	Load alternate registers with CMOS values	LBT	Core
0x42	Initialize interrupt vectors 0 thru 77h	LBT	Core
0x46	Verify the ROM copyright notice	LBT	Core
0x45	Initialize all motherboard devices.	LBT	Core
0x49	<ol style="list-style-type: none"> 1. Size the PCI bus topology and set bridge bus numbers. 2. Set the system max bus number. 3. Write a 0 to the command register of every PCI device. 4. Write a 0 to all 6 base registers in every PCI device. 5. Write a -1 to the status register of every PC 	LBT	Core
0xC6	Initialize note dock	LBT	Core
0xC5	PnPnd dual CMOS (optional)	LBT	Core
0x48	Verify that the equipment specified in the CMOS matches the hardware currently installed. If the monitor type is set to 00 then a video ROM must exist. If the monitor type is 1 or 2 set the video switch to CGA. If monitor type 3, set the video switch to m	LBT	Core
0xD1	Initialize BIOS stack	LBT	Core
0xD3	Setup E820h and WAD memory map	LBT	Core
0x24	Set segment-register addressability to 4 GB	LBT	Core
0xCC	Redirect Int 10h to enable target board to use a remote serial video (PICO BIOS).	LBT	Core
0x8A	Initialize Extended BIOS Data Area and initialize the mouse.	LBT	Core
0x9D	Initialize Security Engine.	LBT	Core
0x55	USB Initialization	LBT	Core
0x52	Verify keyboard reset.	LBT	Core
0x54	Initialize keystroke clicker if enabled in Setup.	LBT	Core
0x76	Check status bits for keyboard-related failures. Display error messages on the screen.	LBT	Core
0x4A	Initialize all video adapters in system	LBT	Core
0x4C	Shadow video BIOS ROM if specified by Setup, and CMOS is valid and the previous boot was OK.	LBT	Core
0x59	Register POST Display Services, fonts, and languages with the POST Dispatch Manager.	LBT	Core
0x57	Initialize 1394 Firewire	LBT	Core

POST Code	Function	Phase	Component
0xD6	Initialize PC card	LBT	Core
0x58	Test for unexpected interrupts. First do an STI for hot interrupts. Secondly, test the NMI for an unexpected interrupt. Thirdly, enable the parity checkers and read from memory, checking for an unexpected interrupt.	LBT	Core
0x3F	ROMPolit memory init	LBT	Core
0xC4	Install the IRQ vectors (Sever Hotkey)	LBT	Core
0x7C	Initialize the hardware interrupt vectors from 08 to 0F and from 70h to 77H. Also set the interrupt vectors from 60h to 66H to zero.	LBT	Core
0x41	ROM Pilot Init	LBT	Core
0x4B	Initialize QuietBoot if it is installed. Enable both keyboard and timer interrupts (IRQ0 and IRQ1). If your POST tasks require interrupts off, preserve them with a PUSHF and CLI at the beginning and a POPF at the end. If you change the PIC, preserve the e	LBT	Core
0xDE	Initialize and UNDI ROM (fro remote flash)	LBT	Core
0xC6	Initial and install console for UCR	LBT	Core
0x4E	Display copyright notice.	LBT	Core
0xD4	Get CPU branding string	LBT	Core
0x50	Display CPU type and speed	LBT	Core
0xC9	pretask before EISA init	LBT	Core
0x51	EISA Init	LBT	Core
0x5A	Display prompt "Press F2 to enter SETUP"	LBT	Core
0x5B	Disable CPU cache.	LBT	Core
0x5C	Test RAM between 512K and 640K.	LBT	Core
0x60	Determine and test the amount of extended memory available. Determine if memory exists by writing to a few strategic locations and see if the data can be read back. If so, perform an address-line test and a RAM test on the memory. Save the total extended	LBT	Core
0x62	The amount of memory available. This test is dependent on the processor, since the test will vary depending on the width of memory (16 or 32 bits). This test will also use A20 as the skew address to prevent corruption of the system memory.	LBT	Core
0x64	Jump to UserPatch1.	LBT	Core
0x66	Set cache registers to their CMOS values if CMOS is valid, unless auto configuration is enabled, in which case load cache registers from the Setup default table.	LBT	Core
0x68	Enable external cache and CPU cache if present. Configure non-cacheable regions if necessary.	LBT	Core
0x6A	Display external cache size on the screen if it is non-zero.	LBT	Core
0x6C	Display shadow message	LBT	Core
0xCA	post EISA init	LBT	Core
0x70	Check flags in CMOS and in the TrustedCore data area for errors detected during POST. Display error messages on the screen.	LBT	Core

POST Code	Function	Phase	Component
0x72	Check status bits to see if configuration problems were detected. If so, display error messages on the screen.	LBT	Core
0x4F	Initialize MultiBoot. Allocate memory for old and new MultiBoot history tables.	LBT	Core
0xCD	Reclaim console vector after HW vectors initialized.	LBT	Core
0x7D	Initialize Intelligent System Monitoring.	LBT	Core
0x7E	The Coprocessor initialization test. Use the floating point instructions to determine if a coprocessor exists instead of the ET bit in CR0.	LBT	Core
0xC1	Check Boot Type (Server BIOS)	LBT	Core
0x80	Disable onboard COM and LPT ports before testing for presence of external I/O devices.	LBT	Core
0xCA	Redirect Int 15h to enable target board to use remote keyboard (PICO BIOS).	LBT	Core
0x88	Initialize interrupt controller.	LBT	Core
0x81	Run late device initialization routines.	LBT	Core
0x87	Initialize motherboard configurable devices.	LBT	Core
0x85	Display any ESCD read errors and configure all PnP ISA devices.	LBT	Core
0x82	Test and identify RS232 ports.	LBT	Core
0x84	Test and identify parallel ports.	LBT	Core
0x86	Initialize onboard I/O and BDA according to CMOS and presence of external devices.	LBT	Core
0x83	Configure Fisk Disk Controller.	LBT	Core
0xCE	Initialize digitizer device and display installed message if successful.	LBT	Core
0x89	Enable non-maskable interrupts.	LBT	Core
0x8C	Initialize both of the floppy disks and display an error message if failure was detected. Check both drives to establish the appropriate diskette types in the TrustedCore data area	LBT	Core
0xCB	Redirect Int 13h to Memory Technologies Devices such as ROM, RAM, PCMCIA, and serial disk (PICO BIOS).	LBT	Core
0xCD	Remap I/O and memory address space for PCMCIA (PICO BIOS).	LBT	Core
0x90	Initialize hard-disk controller. If the CMOS ram is valid and intact, and fixed disks are defined, call the fixed disk init routine to initialize the fixed disk system and take over the appropriate interrupt vectors.	LBT	Core
0x8B	Setup interrupt vector and present bit in Equipment byte.	LBT	Core
0x95	<ol style="list-style-type: none"> 1. Check CMOS for CD-ROM drive present 2. Activate the drive by checking for media present 3. Check sector 11h (17) for Boot Record Volume Descriptor 4. Check the boot catalog for validity 5. Pick a boot entry 6. Create a Specification Packet 	LBT	Core
0x92	Jump to UserPatch2.	LBT	Core

POST Code	Function	Phase	Component
0xB6	If password on boot is enabled, a call is made to Setup to check password. If the user does not enter a valid password, Setup does not return.	LBT	Core
0x98	Search for option ROMs. Rom scan the area from C800h for a length of BCP_ROM_Scan_Size (or to E000h by default) on every 2K boundary, looking for add on cards that need initialization.	LBT	Core
0x93	Build the MPTABLE for multi-processor boards	LBT	Core
0xD9	IPMI late init	LBT	Core
0x9C	Set up Power Management. Initiate power -management state machine.	LBT	Core
0xC7	Late note dock init	LBT	Core
0x9E	Enable hardware interrupts	LBT	Core
0xA0	Setup time tick for current date/time	LBT	Core
0xA2	Setup Numlock indicator. Display a message if key switch is locked.	LBT	Core
0xA4	Initialize typematic rate	LBT	Core
0xDB	StrongROM Test	LBT	Core
0xE2	OEM security key test	LBT	Core
0xC2	Write PEM errors.	LBT	Core
0xBA	Initialize the SMBIOS header and sub-structures.	LBT	Core
0xC3	Display PEM errors.	LBT	Core
0xA8	Overwrite the "Press F2 for Setup" prompt with spaces, erasing it from the screen.	LBT	Core
0xAA	Scan the key buffer to see if the F2 key was struck after keyboard interrupts were enabled. If an F2 keystroke is found, set a flag.	LBT	Core
0xE1	Start Periodic Timer (TC Subscribe)	LBT	Core
0xAC	Check if "Enter SETUP" is pressed.	LBT	Core
0x8F	Count the number of ATA drives in the system and update the number in bdaFdiskcount.	LBT	Core
0x91	Configure the local bus IDE timing register based on the drives attached to it.	LBT	Core
0x9F	Check the total number of Fast Disks (ATA and SCSI) and update the bdaFdiskCount.	LBT	Core
0xD7	Check if FirstWare HPA exists	LBT	Core
0xAE	Clear ConfigFailedBit and InPostBit in CMOS.	LBT	Core
0xB0	Check for errors and decide if needs to run Setup.	LBT	Core
0xB2	Change status bits in CMOS and/or the TrustedCore data area to reflect the fact that POST is complete.	LBT	Core
0xB5	Fade out OEM Logo or post string	LBT	Core
0xC5	End hotkey detection (Server BIOS)	LBT	Core 16
0xBE	If BCP option is enabled, clear the screen before booting.	LBT	Core
0xB6	If password on boot is enabled, a call is made to Setup to check password. If the user does not enter a valid password, Setup does not return.	LBT	Core
0xBC	Clear parity-error latch	LBT	Core

POST Code	Function	Phase	Component
0xB7	Initialize ACPI BIOS.	LBT	Core
0x9B	Enable CPU management (Geyserville I)	LBT	Core
0xBD	Display Boot First menu if MultiBoot is installed and hotkey pressed.	LBT	Core
0xBF	Check virus and backup reminders.	LBT	Core
0x97	Create pointer to MP table in Extended BDA.	LBT	Core
0x99	Check support status for Self-Monitoring Analysis Reporting Technology (disk-failure warning).	LBT	Core
0xB1	Unload ROM Pilot	LBT	Core
0xDD	Perform remote flash if requested	LBT	Core
0xC7	If UCR redirection is installed, remove display manager and unhook INT10	LBT	Core
0XDF	Shutdown the PXE UNDI code	LBT	Core
0xB3	Store enhanced CMOS values in non-volatile area	LBT	Core
0xE4	Last Legacy BIOS Task before hand off to UEFI/DXE	LBT	Core
0xB9	Clear all screen graphics before booting.	bootLegacy	Core
0xC0	INT19 entry for legacy boot	bootLegacy	Core
0xEF	Invalid AP #	SDXE	Core
0xEF	Non-Yohna and non-Modem class CPU found for SDXE (getTSCFreq)	SDXE	Core
0xEE	AP cannot synch BSP in SDXE (syncWithBSP)	SDXE	Core
0xEE	BSP cannot synch w/ AP in SDXE (syncWithAP)	SDXE	Core

Jumper and Connector Locations

Top View

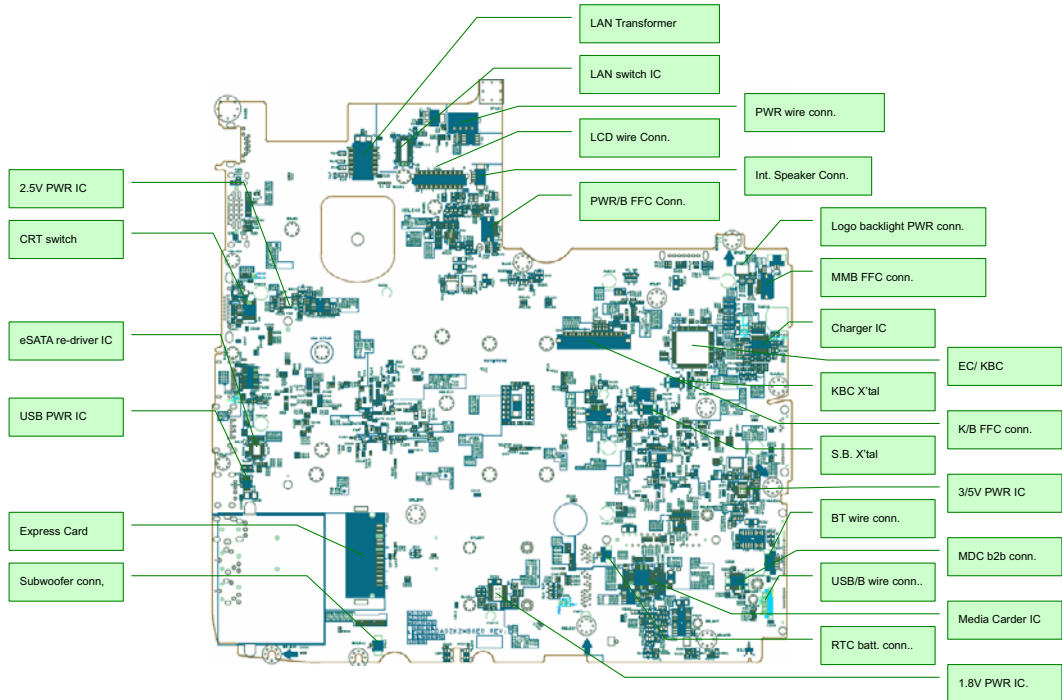

Bottom View

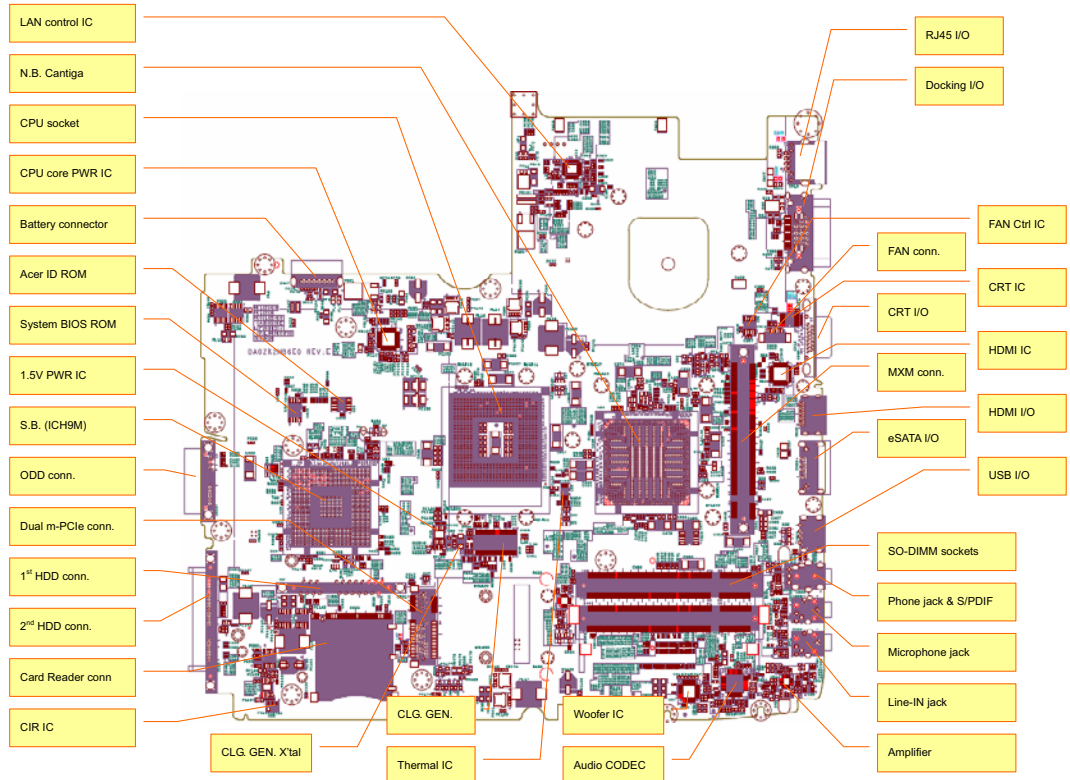

Clearing Password Check and BIOS Recovery

This section provide you the standard operating procedures of clearing password and BIOS recovery for Aspire 6930/6930G. Aspire 6930/6930G provides one Hardware Open Gap on main board for clearing password check, and one Hotkey for enabling BIOS Recovery.

Clearing Password Check

Hardware Open Gap Description

Item	Description	Location
G1 and G2	Clear CMOS Jumper	Main HDD bay

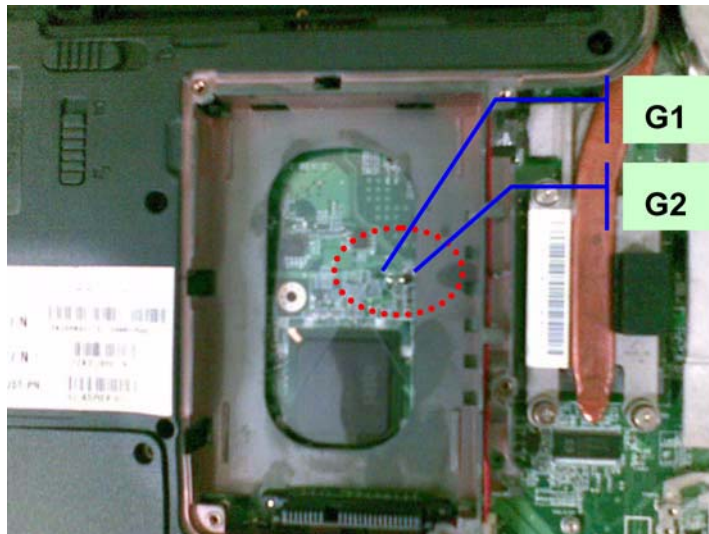

Steps for Clearing BIOS Password Check

If users set BIOS Password (Supervisor Password and/or User Password) for a security reason, BIOS will ask the password during systems POST or when systems enter to BIOS Setup menu. However, once it is necessary to bypass the password check, users need to short the HW Gap to clear the password by the following steps:

- Power Off a system, and remove HDD, AC and Battery from the machine.
- Open the back cover of the machine, and find out the HW Gap on M/B as picture.
- Use an electric conductivity tool to short the two points of the HW Gap.
- Plug in AC, keep the short condition on the HW Gap, and press Power Button to power on the system till BIOS POST finish. Then remove the tool from the HW Gap.
- Restart system. Press F2 key to enter BIOS Setup menu.
- If there is no Password request, BIOS Password is cleared. Otherwise, please follow the steps and try again.

NOTE: The steps are only for clearing BIOS Password (Supervisor Password and User Password).

BIOS Recovery by Crisis Disk

BIOS Recovery Boot Block:

BIOS Recovery Boot Block is a special block of BIOS. It is used to boot up the system with minimum BIOS initialization. Users can enable this feature to restore the BIOS firmware to a successful one once the previous BIOS flashing process failed.

BIOS Recovery Hotkey:

The system provides a function hotkey: **Fn+Esc**, for enable BIOS Recovery process when system is powered on during BIOS POST. To use this function, it is strongly recommended to have the AC adapter and Battery present. If this function is enabled, the system will force the BIOS to enter a special BIOS block, called Boot Block.

Steps for BIOS Recovery by Crisis Disk:

Before doing this, one Crisis Disk should be prepared ready in hand. The Crisis Disk could be made by executing the Crisis Disk program in another system with Windows XP OS.

Follow the steps below:

1. Power Off failed system.
2. Attach a USB floppy drive to the failed system.
3. Insert the Crisis Disk in to the USB floppy drive attached to the BIOS flash failed system.
4. In the power-off state, press and hold **Fn+Esc** then press the Power button.

The system powers on and the Crisis BIOS Recovery process begins.

BIOS Boot Block begins restoring the BIOS code from the Crisis floppy disk to BIOS ROM on the failed systems.

When the Crisis flash process is finished, the system restarts with a workable BIOS.

5. Update to the latest version BIOS for the system using the regular BIOS flashing process.

FRU (Field Replaceable Unit) List

This chapter gives you the FRU (Field Replaceable Unit) listing in global configurations of Aspire 6930/6930G. Refer to this chapter whenever ordering for parts to repair or for RMA (Return Merchandise Authorization).

Please note that WHEN ORDERING FRU PARTS, you should check the most up-to-date information available on your regional web or channel. For whatever reasons a part number change is made, it will not be noted on the printed Service Guide. For ACER AUTHORIZED SERVICE PROVIDERS, your Acer office may have a DIFFERENT part number code from those given in the FRU list of this printed Service Guide. You MUST use the local FRU list provided by your regional Acer office to order FRU parts for repair and service of customer machines.

NOTE: To scrap or to return the defective parts, you should follow the local government ordinance or regulations on how to dispose it properly, or follow the rules set by your regional Acer office on how to return it.

Aspire 6930/6930G Exploded Diagrams

Main Module

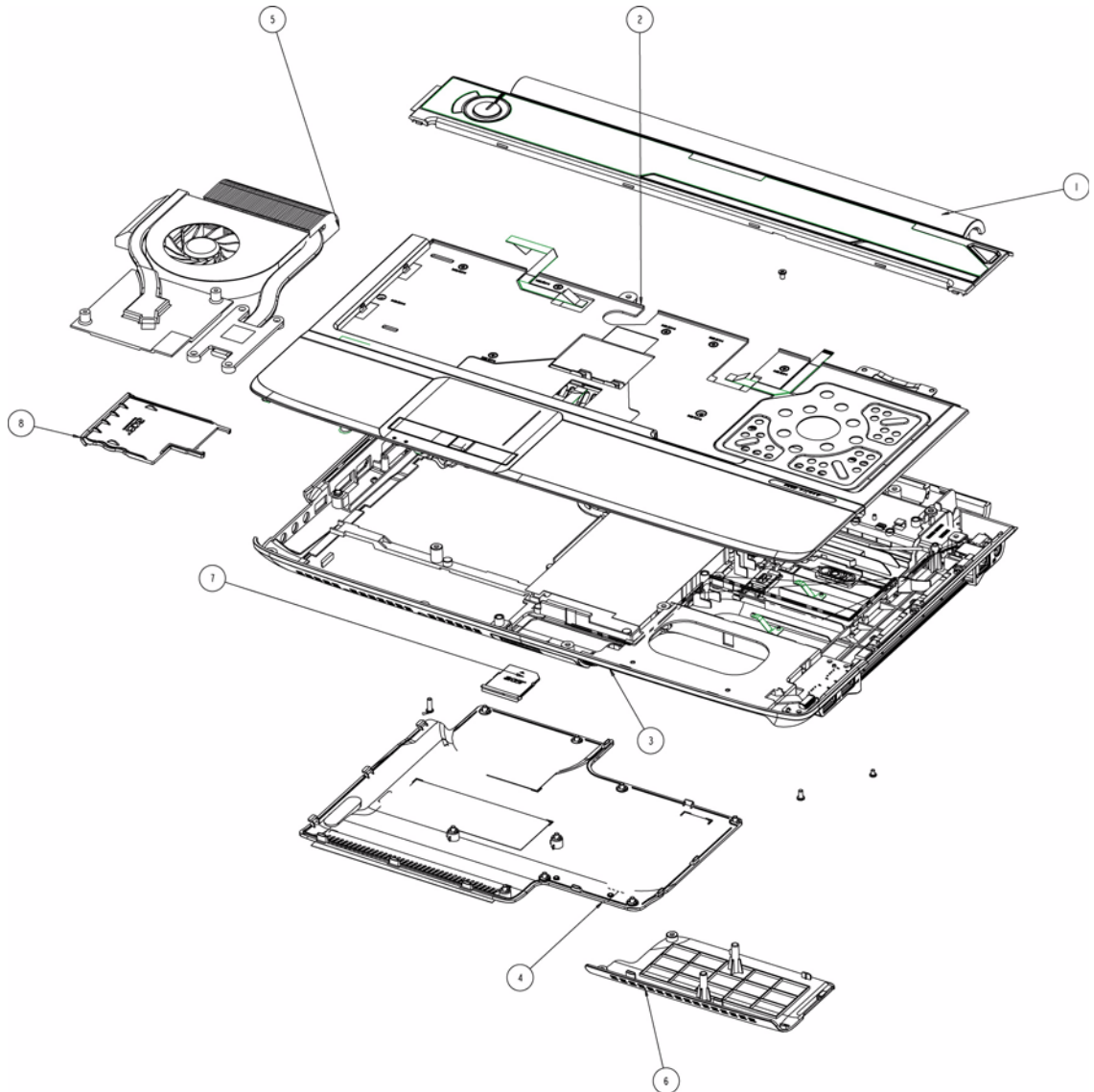

Item	Description	Part No.	Item	Description	Part No.
1	Middle Cover	42.ASR07.001	5	Thermal Unit	60.AVB07.003
2	Upper Case Assy	60.AVB07.001	6	HDD2 Cover	42.AVB07.001
3	Lower Case Assy	60.AVL07.001	7	SD Dummy	TBD
4	Base Cover	42.ASR07.002	8	ExpressCard Dummy	42.ASR07.003



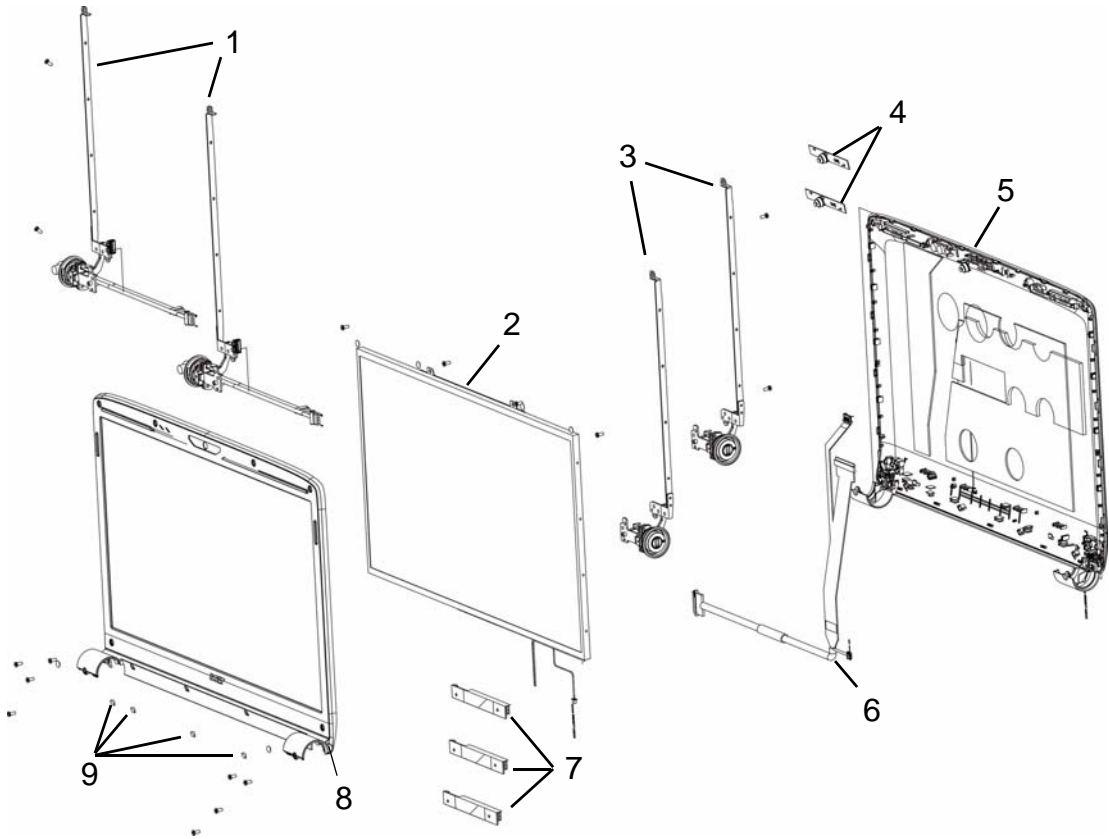



LCD Module

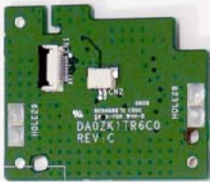

Item	Description	Part No.	Item	Description	Part No.
1	Left Bracket	33.ASR07.005	6	LCD Cable	50.ASR07.002
2	LCD Panel	LK.16006.001	7	Inverter	19.ASR07.001
3	Right Bracket	33.ASR07.004	8	LCD Bezel	60.ASR07.005
4	Camera	57.ARE07.001	9	Screw Cap	47.ASR07.002
5	LCD Assy	60.AVB07.002			

Aspire 6930/6930G FRU List

Category	Description	Acer Part No.
Adapter		
	ADAPTER 65W 3PIN DELTA SADP-65KB DFA	AP.06501.013
	ADAPTER 65W LITEON PA-1650-02AC LF	AP.06503.016
	ADAPTER 65W 3PIN HIPRO AC-OK065B13	AP.0650A.010
	Adapter DELTA 65W SADP-65KB BFJA LV4 LF for OBL	AP.06501.014
	ADAPTER DELTA 90W ADP-90SB BBEA LF	AP.09001.013
	ADAPTER LITE-ON 90W 19V BLUE PA-1900-24AR LED LF	AP.09003.011
	ADAPTER HIPRO 90W 19V BLUE HP-OL093B13P LED LF LEVEL 4	AP.0900A.001
	Adapter DELTA 90W ADP-90SB BBEN (for OBL Spec.) LV4 LF	AP.09001.014
Battery		
	Battery SANYO AS-2007B Li-Ion 3S2P SANYO 6 cell 4400mAh Main COMMON Normal Type	BT.00603.042
	Battery SONY AS-2007B Li-Ion 3S2P SONY 6 cell 4400mAh Main COMMON Normal Type	BT.00604.025
	Battery PANASONIC AS-2007B Li-Ion 3S2P PANASONIC 6 cell 4400mAh Main COMMON PSS	BT.00605.021
	Battery SIMPLO AS-2007B Li-Ion 3S2P PANASONIC 6 cell 4400mAh Main COMMON PSS	BT.00607.016
	Battery SANYO AS-2007B Li-Ion 4S2P SANYO 8 cell 4800mAh Main COMMON	BT.00803.024
	Battery SONY AS-2007B Li-Ion 4S2P SONY 8 cell 4800mAh Main COMMON	BT.00804.020
	Battery PANASONIC AS-2007B Li-Ion 4S2P PANASONIC 8 cell 4800mAh Main COMMON	BT.00805.011
Board		
	Foxconn Conexant -Unizion 1.5_3.3v AUS T60M955.04	FX.22500.025
	MODEM BOARD T60M955.02	54.AGW07.001
	Lite-On Conexant -Unizion 1.5_3.3v AUS RD02-D330 B85247600G	FX.22500.021
	BLUETOOTH MODULE (T60H928.11)	BT.21100.005
	Lan Intel WLAN 512AN_MMWG Shirley Peak 5100 MM#895361	KI.SPM01.003





Category	Description	Acer Part No.
	MSI VGA Card nVidia NB9M-GS DDRII 256M 400MHz 32*16 MXM I w/ HDCP w/ Intersil PowerIC	VG.9MG06.001
	Yuan VGA Card nVidia NB9M-GS DDRII 256M 400MHz 32*16 MXM I w/ HDCP w/ Intersil PowerIC	VG.9MG0Y.001
	MSI VGA Card nVidia NB9P-GE2 DDRII 512M 400MHz 32*16 MXM II w/ HDCP w/ MPS PowerIC	VG.9PG06.003
	Yuan VGA Card nVidia NB9P-GE2 DDRII 512M 400MHz 32*16 MXM II w/ HDCP w/ MPS PowerIC	VG.9PG0Y.004
	MSI VGA Card nVidia NB9P-GS GDDRIII 512M 800MHz 32*32 MXM II w/ HDCP w/ Intersil PowerIC w/DP support Ver. A3	VG.9PG06.006
	Yuan VGA Card nVidia NB9P-GS GDDRIII 512M 800MHz 32*32 MXM II w/ HDCP w/ MPS PowerIC w/DP support Ver. A3	VG.9PG0Y.005
	TOUCHPAD BOARD W/FP	55.AVB07.001
	TOUCHPAD BOARD W/O FP	55.ASR07.001
	POWER BOARD	55.ASR07.002
	USB BOARD	55.ASR07.003
Cable		
	PWR CORD V943B30001218008 DANISH 3P	27.A03V7.006
	PWR CORD(ISR)1.8M 3PBLK FZ0I0008-038	27.TATV7.005
	PWR CORD V50CB3T3012180QD TW-110V,3P	27.A99V7.002
	POWER CORD(SWI)1.8M 3PBLACK FZ010008-011	27.A99V7.004
	POWER CORD(IT) 1.8M 3PBLACK FZ010008-008	27.A99V7.005
	POWER CORD(S.A) 1.8M 3BLACK FZ010008-006	27.T48V7.001
	POWER CORD US 3PIN ROHS	27.TAXV7.001
	POWER CORD(EU) 1.8M 3PBLACK FM010008-010	27.TATV7.001
	POWER CORD(UK) 1.8M 3PBLACK FP010008-013	27.TATV7.003
	BLUETOOTH CABLE	50.ASR07.001
Case/Cover/Bracket Assembly		
	MIDDLE COVER W/MMB BOARD, EKEY BOARD	42.ASR07.001
	UPPER CASE ASSY W/FFC, TP FOR FP	60.AVB07.001
	UPPER CASE ASSY W/FFC, TP FOR NON FP	60.ASR07.001









Category	Description	Acer Part No.
	LOWER CASE ASSY W/SPEAKER,SUB-WOOFER,RJ11, USB/TV CABLE FOR TV	60.AVL07.001
	LOWER CASE ASSY W/SPEAKER,SUB-WOOFER,RJ12, USB CABLE FOR NON TV	60.ASR07.002
	LOWER CASE ASSY W/SPEAKER,SUB-WOOFER,RJ11, USB/TV CABLE FOR TV W/O E SATA	60.ASR07.003
	LOWER CASE ASSY W/SPEAKER,SUB-WOOFER,RJ12, USB CABLE FOR NON TV W/O E SATA	60.ASR07.004
	BASE COVER	42.ASR07.002
	DUMMY EXPRESS CARD	42.ASR07.003
	MINI CARD BRACKET	42.ASR07.004
	VGA SUPPORT BRACKET	33.AHS07.007
CPU/Processor		
	CPU Intel Core2Dual P8400 PGA 2.26G 3M 1066 25W	KC.84001.DPP
	CPU Intel Core2Dual P8600 PGA 2.4G 1066 25W 3M	KC.86001.DPP
	CPU Intel Core2Dual T9400 PGA 2.53G 6M 1066 35W	KC.94001.DTP
	CPU INTEL CORE2DUAL P9500 PGA 2.53G 6M 1066 25W	KC.95001.DPP
	CPU Intel Core2Dual T9600 PGA 2.8G 6M 1066 35W	KC.96001.DTP
Multi Drive		
	DVD/RW SUPER MULTI SATA MODULE	6M.ASR07.001
	PIONEER Super-Multi DRIVE Tray DL 8X DVR-TD08RS LF W/O bezel SATA	KU.00805.044
	HLDS Super-Multi DRIVE Tray DL 8X GSA-T50N LF W/O bezel SATA Malaysia	KU.0080D.034
	ODD HLDS Super-Multi DRIVE Tray DL 8X GSA-T50N LF W/O bezel SATA FW:RP05	KU.0080D.029
	ODD SONY Super-Multi DRIVE Tray DL 8X AD-7560S LF W/O bezel SATA	KU.0080E.009
	ODD PLDS Super-Multi DRIVE Tray DL 8X DS-8A2S LF W/O bezel SATA	KU.0080F.001
	ODD BEZEL - SUPER MULTI	42.ASR07.005







Category	Description	Acer Part No.
	OPTICAL BRACKET	33.ASR07.001
Combo Drive		
	BLUE RAY COMBO MODULE	6M.ASR07.002
	BLUE RAY COMBO TRAY 2X SONY BC-5500S-AR	KO.0020E.002
	ODD BEZEL - BLUE RAY	42.ASR07.006
	OPTICAL BRACKET	33.ASR07.001

Category	Description	Acer Part No.
HDD		
	HDD SEAGATE 2.5" 5400rpm 120GB ST9120817AS Corsair SATA LF F/W:3.AAA	KH.12001.032
	HDD TOSHIBA 2.5" 5400rpm 120GB MK1252GSX Virgo BS SATA LF F/W:LV010J	KH.12004.008
	HDD HGST 2.5" 5400rpm 120GB HTS543212L9A300 Falcon-B SATA LF F/W:C40C	KH.12007.016
	HDD SEAGATE 2.5" 5400rpm 160GB ST9160310AS Crockett SATA LF F/W:0303	KH.16001.034
	HDD TOSHIBA 2.5" 5400rpm 160GB MK1652GSX Virgo - BS SATA LF F/W:LV010J	KH.16004.003
	HDD HGST 2.5" 5400rpm 160GB HTS543216L9A300 Falcon-B SATA LF F/W:C40C	KH.16007.019
	HDD SEAGATE 2.5" 5400rpm 250GB ST9250827AS Corsair SATA LF F/W:3.AAA	KH.25001.011
	HDD TOSHIBA 2.5" 5400rpm 250GB MK2552GSX Virgo BS SATA LF F/W:LV010J	KH.25004.002
	HDD HGST 2.5" 5400rpm 250GB HTS543225L9A300 Falcon-B SATA LF F/W:C40C	KH.25007.013
	HDD WD 2.5 IN. 5400rpm 250GB WD2500BEVS-22UST0 ML125 SATA LF F/W:01.01A01	KH.25008.018
	HDD SEAGATE 2.5" 5400rpm 320GB ST9320320AS Crockett SATA LF F/W:0303	KH.32001.008
	HDD TOSHIBA 2.5" 5400rpm 320GB MK3252GSX Virgo BS SATA LF F/W:LV010J	KH.32004.001
	HDD HGST 2.5" 5400rpm 320GB HTS543232L9A300 Falcon-B SATA LF F/W:C40C	KH.32007.004
	HDD WD 2.5" 5400rpm 320GB WD3200BEVT-22ZCT0 ML160 SATA LF F/W:11.01A11	KH.32008.013
	HDD BRACKET ASSY	33.ASR07.002
	HDD CONNECTOR	20.TPK07.001

Category	Description	Acer Part No.
	2nd HDD BRACKET	33.ASR07.003
	2nd HDD COVER FOR 2nd HDD SKU	42.AVB07.001
	2nd HDD COVER FOR NON 2nd HDD SKU	42.ASR07.007
Keyboard		
	Keyboard 17_18KB-FV1 Teton Internal Standard 105KS Black US International (glossy)	KB.INT00.297
	Keyboard 17_18KB-FV1 Teton Internal Standard 105KS Black US International Hebrew (glossy)	KB.INT00.298
	Keyboard 17_18KB-FV1 Teton Internal Standard 106KS Black UK (glossy)	KB.INT00.299
	Keyboard 17_18KB-FV1 Teton Internal Standard 106KS Black Turkish (glossy)	KB.INT00.300
	Keyboard 17_18KB-FV1 Teton Internal Standard 105KS Black Thailand (glossy)	KB.INT00.301
	Keyboard 17_18KB-FV1 Teton Internal Standard 106KS Black Swiss/G (glossy)	KB.INT00.302
	Keyboard 17_18KB-FV1 Teton Internal Standard 106KS Black Swedish (glossy)	KB.INT00.303
	Keyboard 17_18KB-FV1 Teton Internal Standard 106KS Black Spanish (glossy)	KB.INT00.304
	Keyboard 17_18KB-FV1 Teton Internal Standard 106KS Black Slovak (glossy)	KB.INT00.305
	Keyboard 17_18KB-FV1 Teton Internal Standard 106KS Black SLO/CRO (glossy)	KB.INT00.306
	Keyboard 17_18KB-FV1 Teton Internal Standard 105KS Black Russian (glossy)	KB.INT00.307
	Keyboard 17_18KB-FV1 Teton Internal Standard 106KS Black Portuguese (glossy)	KB.INT00.308
	Keyboard 17_18KB-FV1 Teton Internal Standard 106KS Black Polish (glossy)	KB.INT00.309
	Keyboard 17_18KB-FV1 Teton Internal Standard 106KS Black Norwegian (glossy)	KB.INT00.310
	Keyboard 17_18KB-FV1 Teton Internal Standard 105KS Black Korean (glossy)	KB.INT00.312
	Keyboard 17_18KB-FV1 Teton Internal Standard 109KS Black Japanese (glossy)	KB.INT00.313
Keyboard 17_18KB-FV1 Teton Internal Standard 106KS Black Italian (glossy)	KB.INT00.314	

Category	Description	Acer Part No.
	Keyboard 17_18KB-FV1 Teton Internal Standard 106KS Black Hungarian (glossy)	KB.INT00.317
	Keyboard 17_18KB-FV1 Teton Internal Standard 105KS Black Greek (glossy)	KB.INT00.318
	Keyboard 17_18KB-FV1 Teton Internal Standard 106KS Black German (glossy)	KB.INT00.319
	Keyboard 17_18KB-FV1 Teton Internal Standard 106KS Black French (glossy)	KB.INT00.320
	Keyboard 17_18KB-FV1 Teton Internal Standard 106KS Black Danish (glossy)	KB.INT00.323
	Keyboard 17_18KB-FV1 Teton Internal Standard 106KS Black Czech (glossy)	KB.INT00.324
	Keyboard 17_18KB-FV1 Teton Internal Standard 105KS Black Traditional Chinese (glossy)	KB.INT00.325
	Keyboard 17_18KB-FV1 Teton Internal Standard 106KS Black Canadian French (glossy)	KB.INT00.326
	Keyboard 17_18KB-FV1 Teton Internal Standard 106KS Black Brazilian Portuguese (glossy)	KB.INT00.327
	Keyboard 17_18KB-FV1 Teton Internal Standard 106KS Black Belgium (glossy)	KB.INT00.328
	Keyboard 17_18KB-FV1 Teton Internal Standard 105KS Black Arabic/English (glossy)	KB.INT00.329
	Keyboard 17_18KB-FV1 Teton Internal Standard 106KS Black Arabic/French (glossy)	KB.INT00.330
	Keyboard 17_18KB-FV1 Teton Internal Standard 106KS Black Nordic (glossy)	KB.INT00.331
	Keyboard 17_18KB-FV1 Teton Internal Standard 106KS Black Luxembourgian (glossy)	KB.INT00.311
	Keyboard 17_18KB-FV1 Teton Internal Standard 105KS Black Israel (glossy)	KB.INT00.315
	Keyboard 17_18KB-FV1 Teton Internal Standard 106KS Black Irish (glossy)	KB.INT00.316
	Keyboard 17_18KB-FV1 Teton Internal Standard 106KS Black Finnish (glossy)	KB.INT00.321
	Keyboard 17_18KB-FV1 Teton Internal Standard 106KS Black Dutch (glossy)	KB.INT00.322
	Keyboard 17_18KB-FV1 Teton Internal Standard 106KS Black English/Canadian French (glossy)	KB.INT00.332
	LCD	
	LCD MODULE 16 IN. WXGA W/CCD WLAN UMA	6M.ASR07.003
	LCD SAMSUNG 16" WXGA Glare LTN160AT01-A01 LF 220nit 8ms 600:1 60%, 16:9	LK.16006.001
	LCD SAMSUNG 16" WXGA Glare LTN160AT01-A02 LF 220nit 8ms	LK.16006.003
	INVERTER BOARD	19.ASR07.001
	LCD CABLE	50.ASR07.002

Category	Description	Acer Part No.
	LCD COVER ASSY IMR W/BACKLIGHT MIC ANTENNA	60.AVB07.002
	LCD BEZEL 16 IN. FOR CCD	60.ASR07.005
	LCD HINGE- R 16 IN.	33.ASR07.004
	LCD HINGE- L 16 IN. FOR UMA	33.ASR07.005
	CCD MODULE 0.3M	57.ARE07.001
	CCD MODULE 0.3M BN30V4O7-030	57.ASR07.001
	LCD MODULE 16 IN. WXGA W/CCD WLAN MXM	6M.AVB07.001
	LCD SAMSUNG 16" WUXGA Glare LTN160HT01-A02 LF 250nit 8ms	LK.16006.004
	INVERTER BOARD	19.ASR07.001
	LCD CABLE	50.ASR07.002
	LCD COVER ASSY IMR W/BACKLIGHT MIC ANTENNA	60.AVB07.002
	LCD BEZEL 16 IN. FOR CCD	60.ASR07.005
	LCD HINGE- R 16 IN.	33.ASR07.004
	LCD HINGE- L 16 IN. FOR MXM	33.AVB07.001
	CCD MODULE 0.3M	57.ARE07.001
	CCD MODULE 0.3M BN30V4O7-030	57.ASR07.001
	LCD MODULE 16 IN. WXGA W/CCD WLAN FOR NON BEZEL	6M.AVL07.001
	LCD SAMSUNG 16" WXGA+ None Glare LTN160AT01-1 LF 220nit 8ms 600:1	LK.16006.005
	INVERTER BOARD	19.ASR07.001
	LCD CABLE 16 IN. FOR NON BEZEL	50.AVL07.001

Category	Description	Acer Part No.
	LCD COVER ASSY IMR W/BACKLIGHT MIC ANTENNA FOR NON BEZEL	60.AVL07.002
	LCD BEZEL W/FILM 16 IN. FOR CCD	60.AVL07.003
	LCD HINGE- R 16 IN. FOR NON BEZEL	33.AVL07.001
	LCD HINGE- L 16 IN. FOR NON BEZEL	33.AVL07.002
	LCD HINGE COVER	42.AVL07.001
	CCD MODULE 0.3M	57.ARE07.001
	CCD MODULE 0.3M BN30V4O7-030	57.ASR07.001
Mainboard		
	MAINBOARD GM45 ICH9 UMA W/CARD READER, EXPRESS CARD W/O CPU RAM	MB.ASR06.001
	MAINBOARD PM45 ICH9 DIS W/CARD READER, EXPRESS CARD W/O CPU RAM	MB.ASR06.002
Memory		
	Memory SAMSUNG SO-DIMM DDRII 667 1GB M470T2864QZ3-CE6 LF	KN.1GB0B.016
	Memory HYNIX SO-DIMM DDRII 667 1GB HYMP112S64CP6-Y5 LF	KN.1GB0G.012
	Memory MICRON SO-DIMM DDRII 667 2GB MT16HTF25664HY-667E1 LF	KN.2GB04.001
	Memory SAMSUNG SO-DIMM DDRII 667 2GB M470T5663QZ3-CE6 LF	KN.2GB0B.003
	MEMORY HYNIX SO-DIMM DDRII 667 2GB HYMP125S64CP8-Y5 LF	KN.2GB0G.004
	Memory NANYA SO-DIMM DDRII 667 2GB NT2GT64U8HD0BN-3C LF	KN.2GB03.011
	Memory ELPIDA SO-DIMM DDRII 667 1GB EBE11UE6ACUA-6E-E LF 64*16 0.065um	KN.1GB09.008
	Memory ELPIDA SO-DIMM DDRII 667 2GB EBE21UE8ACUA-6E-E LF	KN.2GB09.001
Heatsink		
	THERMAL MODULE - DIS	60.AVB07.003
	THERMAL MODULE - UMA	60.ASR07.006

Category	Description	Acer Part No.
Miscellaneous		
	NAME PLATE - AS6930	47.ASR07.001
	LCD BEZEL RUBBER	47.ASR07.002
	RUBBER FOOT -A	47.ASR07.003
	RUBBER FOOT -C	47.ASR07.004
	RUBBER FOOT - REAR	47.ASR07.005

Screw List

Category	Description	Acer Part No.
SCREW	M2.5*6.5-I (BZN)(NYLOK-RED)	86.ARE07.001
SCREW	M2.0*3.0-I (BKAG)(NYLOK) IRON	86.ARE07.002
SCREW	M2.0*3.0-I-NI-NYLOK	86.A08V7.005
SCREW	M3*0.5+3.5I	86.TDY07.003
SCREW	M2.5*2.5-I (NI) (NYLOK)	86.T25V7.010
SCREW	M2.5*4.0-I (NI) (NYLOK)	86.D01V7.001
SCREW	M2.5*5-I (BNI) (NYLOK)	86.A03V7.003
SCREW	M2.5*8-I BNI NYLOK	86.T48V7.001

Model Definition and Configuration

Aspire 6930/6930G Series

Model	RO	Country	Acer Part No	Description	CPU
AS6930-732G25Mn	AAP	Vietnam	LX.ASR0X.024	AS6930-732G25Mn EM VHP32ATVN1 MC UMACO 2*1G/250/BT/6L/5R/ CB_n3_0.3D_HG_EN13	C2DP7350
AS6930-843G25Mn	AAP	Japan	LX.ASR0X.023	AS6930-843G25Mn VHP32AJP1 MC UMACO 2G+1G/250/BT/6L/5R/ CB_n2_0.3D_HG_JA12_A25F	C2DP8400
AS6930-583G32Mn	AAP	Japan	LX.ASR0X.005	AS6930-583G32Mn VHP32ATJP1 MC UMACO 2G+1G/320/6L/5R/ CB_n2_0.3D_HG_JA11	C2DT5800
AS6930-583G32Mn	PA	Canada	LX.ASR0X.022	AS6930-583G32Mn VHP32ATCA2 MC UMACO 2G+1G/320/6L/5R/ CB_n2_0.3D_HG_FR35	C2DT5800
AS6930-583G32Mn	PA	Canada	LX.ASR0X.021	AS6930-583G32Mn VHP32ATCA2 MC UMACO 2G+1G/320/6L/5R/ CB_n2_0.3D_HG_FR33	C2DT5800
AS6930-583G32Mn	PA	Canada	LX.ASR0X.020	AS6930-583G32Mn VHP32ATCA2 MC UMACO 2G+1G/320/6L/5R/ CB_n2_0.3D_HG_FR32	C2DT5800
AS6930-583G32Mn	PA	Canada	LX.ASR0X.019	AS6930-583G32Mn VHP32ATCA2 MC UMACO 2G+1G/320/6L/5R/ CB_n2_0.3D_HG_FR31	C2DT5800
AS6930-583G32Mn	PA	Canada	LX.ASR0X.018	AS6930-583G32Mn VHP32ATCA2 MC UMACO 2G+1G/320/6L/5R/ CB_n2_0.3D_HG_FR34	C2DT5800
AS6930-583G32Mn	PA	USA	LX.ASR0X.017	AS6930-583G32Mn VHP32ATUS1 MC UMACO 2G+1G/320/6L/5R/ CB_n2_0.3D_HG_EN33	C2DT5800
AS6930-583G32Mn	PA	USA	LX.ASR0X.016	AS6930-583G32Mn VHP32ATUS1 MC UMACO 2G+1G/320/6L/5R/ CB_n2_0.3D_HG_EN35	C2DT5800
AS6930-583G32Mn	PA	USA	LX.ASR0X.015	AS6930-583G32Mn VHP32ATUS1 MC UMACO 2G+1G/320/6L/5R/ CB_n2_0.3D_HG_EN32	C2DT5800
AS6930-583G32Mn	PA	USA	LX.ASR0X.014	AS6930-583G32Mn VHP32ATUS1 MC UMACO 2G+1G/320/6L/5R/ CB_n2_0.3D_HG_EN34	C2DT5800
AS6930-583G32Mn	PA	ACLA-Portuguese	LX.ASR0X.013	AS6930-583G32Mn VHP32ATXC2 MC UMACO 2G+1G/320/6L/5R/ CB_n2_0.3D_HG_XC22	C2DT5800
AS6930-583G32Mn	PA	ACLA-Portuguese	LX.ASR0X.012	AS6930-583G32Mn EM VHP32ATXC2 MC UMACO 2G+1G/320/6L/5R/ CB_n2_0.3D_HG_XC21	C2DT5800
AS6930-583G32Mn	PA	ACLA-Portuguese	LX.ASR0X.011	AS6930-583G32Mn EM VHP32ATXC1 MC UMACO 2G+1G/320/6L/5R/ CB_n2_0.3D_HG_XC22	C2DT5800
AS6930-583G32Mn	PA	ACLA-Portuguese	LX.ASR0X.010	AS6930-583G32Mn VHP32ATXC1 MC UMACO 2G+1G/320/6L/5R/ CB_n2_0.3D_HG_XC21	C2DT5800

Model	RO	Country	Acer Part No	Description	CPU
AS6930-583G32Mn	PA	ACLA-Spanish	LX.ASR0X.009	AS6930-583G32Mn VHP32ATEA3 MC UMACO 2G+1G/320/6L/5R/ CB_n2_0.3D_HG_ES21	C2DT5800
AS6930-583G32Mn	PA	ACLA-Spanish	LX.ASR0X.008	AS6930-583G32Mn EM VHP32ATEA3 MC UMACO 2G+1G/320/6L/5R/ CB_n2_0.3D_HG_ES22	C2DT5800
AS6930-583G32Mn	PA	ACLA-Spanish	LX.ASR0X.007	AS6930-583G32Mn EM VHP32ATEA1 MC UMACO 2G+1G/320/6L/5R/ CB_n2_0.3D_HG_ES22	C2DT5800
AS6930-583G32Mn	PA	ACLA-Spanish	LX.ASR0X.006	AS6930-583G32Mn VHP32ATEA1 MC UMACO 2G+1G/320/6L/5R/ CB_n2_0.3D_HG_ES21	C2DT5800
AS6930-583G32Mn	AAP	Australia/New Zealand	LX.ASR0X.004	AS6930-583G32Mn VHP32ATAU1 MC UMACO 2G+1G/320/6L/5R/ CB_n2_0.3D_HG_EN12	C2DT5800
AS6930-942G25Mn	CHINA	China	LX.ASR0X.003	AS6930-942G25Mn VHP32ATCN1 MC UMACO 1*2G/250/BT/6L/ CB_n2_0.3D_HG_SC11	C2DT9400
AS6930-942G25Mn	CHINA	Hong Kong	LX.ASR0X.002	AS6930-942G25Mn VHP32ATHK2 MC UMACO 1*2G/250/BT/6L/ CB_n2_0.3D_HG_ZH31	C2DT9400
AS6930-942G25Mn	TWN	GCTWN	LX.ASR0X.001	AS6930-942G25Mn VHP32ATTW1 MC UMACO 1*2G/250/BT/6L/ CB_n2_0.3D_HG_TC11	C2DT9400
AS6930-844G16Mn	WW	WW	S2.ASR0X.002	AS6930-844G16Mn VHP32AWW1 MC UMACO 2*2G/160/BT/6L/ CB_n2_0.3D_HG_EN11	C2DP8400
AS6930-842G12Mn	WW	WW	S2.ASR0X.001	AS6930-842G12Mn VHP32AWW1 MC UMACO 2*1G/120/BT/6L/ CB_n2_0.3D_HG_EN11	C2DP8400
AS6930-584G32Mn	PA	USA	LX.ASR0X.037	AS6930-584G32Mn VHP64ATCA2 MC UMACO 2*2G/320/BT/6L/5R/ CB_n2_0.3D_HG_EN11	C2DT5800
AS6930-584G32Mn	PA	USA	LX.ASR0X.036	AS6930-584G32Mn VHP64ATCA2 MC UMACO 2*2G/320/BT/6L/5R/ CB_n2_0.3D_HG_EN12	C2DT5800
AS6930-584G25Mn	PA	USA	LX.ASR0X.035	AS6930-584G25Mn VHP64ATCA2 MC UMACO 2*2G/250/6L/5R/ CB_n2_0.3D_HG_EN11	C2DT5800
AS6930-584G25Mn	PA	USA	LX.ASR0X.034	AS6930-584G25Mn VHP64ATCA2 MC UMACO 2*2G/250/6L/5R/ CB_n2_0.3D_HG_EN12	C2DT5800
AS6930-732G16Mn	AAP	Singapore	LX.ASR0X.033	AS6930-732G16Mn VHP32ATSG1 MC UMACO 1*2G/160/BT/6L/5R/ CB_n2_0.3D_HG_ZH31	C2DP7350
AS6930-732G16Mn	AAP	Vietnam	LX.ASR0X.032	AS6930-732G16Mn EM VHP32ATVN1 MC UMACO 1*2G/160/BT/6L/5R/ CB_n2_0.3D_HG_EN13	C2DP7350
AS6930-732G32Mn	AAP	Singapore	LX.ASR0X.031	AS6930-732G32Mn VHP32ATSG1 MC UMACO 1*2G/320/BT/6L/5R/ CB_n2_0.3D_HG_ZH31	C2DP7350
AS6930-582G32Mn	AAP	Singapore	LX.ASR0X.030	AS6930-582G32Mn VHP32ATSG1 MC UMACO 1*2G/320/BT/6L/5R/ CB_n2_0.3D_HG_ZH31	C2DT5800
AS6930-842G32Mn	CHINA	China	LX.ASR0X.025	AS6930-842G32Mn VHP32ATCN1 MC UMACO 1*2G/320/6L/5R/ CB_n2_0.3D_HG_SC11	C2DP8400

Model	RO	Country	Acer Part No	Description	CPU
AS6930-731G25Mn	CHINA	China	LX.ASR0X.026	AS6930-731G25Mn VHP32ATCN1 MC UMACO 1*1G/250/6L/5R/ CB_n2_0.3D_HG_SC11	C2DP7350
AS6930-582G16Mn	AAP	Singapore	LX.ASR0X.029	AS6930-582G16Mn VHP32ATSG1 MC UMACO 1*2G/160/BT/6L/5R/ CB_n2_0.3D_HG_ZH31	C2DT5800
AS6930-592G32Mn	AAP	Singapore	LX.ASR0X.027	AS6930-592G32Mn VHP32ATSG1 MC UMACO 1*2G/320/BT/6L/5R/ CB_n2_0.3D_HG_ZH31	C2DT5900
AS6930-592G16Mn	AAP	Singapore	LX.ASR0X.028	AS6930-592G16Mn VHP32ATSG1 MC UMACO 1*2G/160/BT/6L/5R/ CB_n2_0.3D_HG_ZH31	C2DT5900
AS6930G-944G64Bn	WW	WW	S2.ASH0X.002	AS6930G-944G64Bn VHP32AWW1 MC 9MGSHM256TCOF 2*2G/320+320/BT/ 8L/CB_n3_DVBT FP_0.3D_HG_EN11	C2DT9400
AS6930G-944G64B	WW	WW	S2.ASH0X.004	AS6930G-944G64BVHP32AWW1 MC 9MGSHM256TCOF 2*2G/320+320/BT/ 8L/CB_DVBT U/ VHF_FP_0.3D_HG_EN11	C2DT9400
AS6930G-962G28B	WW	WW	S2.ASH0X.005	AS6930G-962G28BVHP32AWW1 MC 9MGSHM256TCOF 2*1G/120+160/BT/ 8L/CB_DVBT U/ VHF_FP_0.3D_HG_EN11	C2DT9600
AS6930G-734G32Mn	EMEA	Spain	LX.ASH0X.001	AS6930G-734G32Mn VHP32ATES1 MC 9MGSHM256TCOF 2*2G/320/6L/5R/ CB_n2_DVBT U/ VHF_FP_0.3D_HG_ES22	C2DP7350
AS6930G-844G64Mn	EMEA	Belgium	LX.AVB0X.079	AS6930G-844G64Mn VHP32ATBE1 MC 9PGE2HM512COF 2*2G/320+320/6L/ 5R/CB_n2_FP_0.3D_HG_NL13	C2DP8400
AS6930G-844G64Mn	EMEA	Holland	LX.AVB0X.076	AS6930G-844G64Mn VHP32ATNL1 MC 9PGE2HM512COF 2*2G/320+320/6L/ 5R/CB_n2_FP_0.3D_HG_NL12	C2DP8400
AS6930G-844G64Mn	EMEA	Luxembourg	LX.AVB0X.077	AS6930G-844G64Mn VHP32ATLU1 MC 9PGE2HM512COF 2*2G/320+320/6L/ 5R/CB_n2_FP_0.3D_HG_IT42	C2DP8400
AS6930G-844G64Mn	EMEA	Norway	LX.AVB0X.078	AS6930G-844G64Mn VHP32ATNO1 MC 9PGE2HM512COF 2*2G/320+320/6L/ 5R/CB_n2_FP_0.3D_HG_NO12	C2DP8400
AS6930G-844G64Mi	EMEA	Russia	LX.AVB0X.075	AS6930G-844G64Mi VHP32ATRU1 MC 9PGE2HM512COF 2*2G/320+320/6L/ 5R/CB_abg_FP_0.3D_HG_RU11	C2DP8400
AS6930G-844G64Mn	EMEA	Sweden/ Finland	LX.AVB0X.074	AS6930G-844G64Mn VHP32ATSE1 MC 9PGE2HM512COF 2*2G/320+320/6L/ 5R/CB_n2_FP_0.3D_HG_FI12	C2DP8400
AS6930G-844G64Mn	EMEA	Czech	LX.AVB0X.073	AS6930G-844G64Mn VHP32ATCZ2 MC 9PGE2HM512COF 2*2G/320+320/6L/ 5R/CB_n2_FP_0.3D_HG_SK11	C2DP8400
AS6930G-844G64Mn	EMEA	Eastern Europe	LX.AVB0X.069	AS6930G-844G64Mn VHP32ATEU7 MC 9PGE2HM512COF 2*2G/320+320/6L/ 5R/CB_n2_FP_0.3D_HG_ENG1	C2DP8400
AS6930G-844G64Mn	EMEA	Eastern Europe	LX.AVB0X.070	AS6930G-844G64Mn VHP32ATEU6 MC 9PGE2HM512COF 2*2G/320+320/6L/ 5R/CB_n2_FP_0.3D_HG_CS21	C2DP8400
AS6930G-844G64Mn	EMEA	Eastern Europe	LX.AVB0X.071	AS6930G-844G64Mn VHP32ATEU3 MC 9PGE2HM512COF 2*2G/320+320/6L/ 5R/CB_n2_FP_0.3D_HG_RU11	C2DP8400

Model	RO	Country	Acer Part No	Description	CPU
AS6930G-844G64Mn	EMEA	Eastern Europe	LX.AVB0X.072	AS6930G-844G64Mn VHP32ATEU1 MC 9PGE2HM512COF 2*2G/320+320/6L/5R/CB_n2_FP_0.3D_HG_CS21	C2DP8400
AS6930G-844G64Mn	EMEA	Eastern Europe	LX.AVB0X.066	AS6930G-844G64Mn VHP32ATEU4 MC 9PGE2HM512COF 2*2G/320+320/6L/5R/CB_n2_FP_0.3D_HG_F112	C2DP8400
AS6930G-844G64Mn	EMEA	Eastern Europe	LX.AVB0X.067	AS6930G-844G64Mn VHP32ATEU3 MC 9PGE2HM512COF 2*2G/320+320/6L/5R/CB_n2_FP_0.3D_HG_RU21	C2DP8400
AS6930G-844G64Mn	EMEA	Eastern Europe	LX.AVB0X.068	AS6930G-844G64Mn VHP32ATEU5 MC 9PGE2HM512COF 2*2G/320+320/6L/5R/CB_n2_FP_0.3D_HG_PL11	C2DP8400
AS6930G-844G64Mn	EMEA	Hungary	LX.AVB0X.065	AS6930G-844G64Mn VHP32ATHU1 MC 9PGE2HM512COF 2*2G/320+320/6L/5R/CB_n2_FP_0.3D_HG_HU11	C2DP8400
AS6930G-844G64Mn	EMEA	Slovenia/Croatia	LX.AVB0X.064	AS6930G-844G64Mn VHP32ATS11 MC 9PGE2HM512COF 2*2G/320+320/6L/5R/CB_n2_FP_0.3D_HG_EN12	C2DP8400
AS6930G-844G64Mn	EMEA	Portugal	LX.AVB0X.063	AS6930G-844G64Mn VHP32ATPT1 MC 9PGE2HM512COF 2*2G/320+320/6L/5R/CB_n2_FP_0.3D_HG_PT12	C2DP8400
AS6930G-844G64Mn	EMEA	Spain	LX.AVB0X.059	AS6930G-844G64Mn VHP32ATES1 MC 9PGE2HM512COF 2*2G/320+320/6L/5R/CB_n2_FP_0.3D_HG_ES22	C2DP8400
AS6930G-844G64Mn	EMEA	Greece	LX.AVB0X.056	AS6930G-844G64Mn VHP32ATGR1 MC 9PGE2HM512COF 2*2G/320+320/6L/5R/CB_n2_FP_0.3D_HG_EL32	C2DP8400
AS6930G-844G64Mn	EMEA	Greece	LX.AVB0X.055	AS6930G-844G64Mn VHP32ATGR1 MC 9PGE2HM512COF 2*2G/320+320/6L/5R/CB_n2_FP_0.3D_HG_EL22	C2DP8400
AS6930G-844G64Mn	EMEA	Israel	LX.AVB0X.054	AS6930G-844G64Mn VHP32ATIL1 MC 9PGE2HM512COF 2*2G/320+320/6L/5R/CB_n2_FP_0.3D_HG_HE11	C2DP8400
AS6930G-844G64Mn	EMEA	Italy	LX.AVB0X.053	AS6930G-844G64Mn VHP32ATIT1 MC 9PGE2HM512COF 2*2G/320+320/6L/5R/CB_n2_FP_0.3D_HG_IT12	C2DP8400
AS6930G-844G64Mn	EMEA	Turkey	LX.AVB0X.049	AS6930G-844G64Mn EM VHP32ATTR1 MC 9PGE2HM512COF 2*2G/320+320/6L/5R/CB_n2_FP_0.3D_HG_TR32	C2DP8400
AS6930G-844G64Mn	EMEA	Middle East	LX.AVB0X.050	AS6930G-844G64Mn EM VHP32ATME9 MC 9PGE2HM512COF 2*2G/320+320/6L/5R/CB_n2_FP_0.3D_HG_FR22	C2DP8400
AS6930G-844G64Mn	EMEA	Middle East	LX.AVB0X.051	AS6930G-844G64Mn EM VHP32ATME2 MC 9PGE2HM512COF 2*2G/320+320/6L/5R/CB_n2_FP_0.3D_HG_AR13	C2DP8400
AS6930G-844G64Mn	EMEA	Middle East	LX.AVB0X.052	AS6930G-844G64Mn EM VHP32ATME3 MC 9PGE2HM512COF 2*2G/320+320/6L/5R/CB_n2_FP_0.3D_HG_FR23	C2DP8400
AS6930G-844G64Mn	EMEA	Middle East	LX.AVB0X.046	AS6930G-844G64Mn EM VHP32ATME6 MC 9PGE2HM512COF 2*2G/320+320/6L/5R/CB_n2_FP_0.3D_HG_EN15	C2DP8400
AS6930G-844G64Mn	EMEA	Middle East	LX.AVB0X.047	AS6930G-844G64Mn EM VHP32ATME2 MC 9PGE2HM512COF 2*2G/320+320/6L/5R/CB_n2_FP_0.3D_HG_AR23	C2DP8400
AS6930G-844G64Mn	EMEA	Middle East	LX.AVB0X.048	AS6930G-844G64Mn EM VHP32ATME4 MC 9PGE2HM512COF 2*2G/320+320/6L/5R/CB_n2_FP_0.3D_HG_EN11	C2DP8400

Model	RO	Country	Acer Part No	Description	CPU
AS6930G-844G64Mn	EMEA	Switzerland	LX.AVB0X.045	AS6930G-844G64Mn VHP32ATCH1 MC 9PGE2HM512COF 2*2G/320+320/6L/5R/CB_n2_FP_0.3D_HG_IT42	C2DP8400
AS6930G-844G64Mn	EMEA	UK	LX.AVB0X.044	AS6930G-844G64Mn VHP32ATGB1 MC 9PGE2HM512COF 2*2G/320+320/6L/5R/CB_n2_FP_0.3D_HG_EN14	C2DP8400
AS6930G-844G64Mn	EMEA	Middle East	LX.AVB0X.043	AS6930G-844G64Mn EM VHP32ATME2 MC 9PGE2HM512COF 2*2G/320+320/6L/5R/CB_n2_FP_0.3D_HG_EN15	C2DP8400
AS6930G-844G64Mn	EMEA	South Africa	LX.AVB0X.061	AS6930G-844G64Mn EM VHP32ATZA2 MC 9PGE2HM512COF 2*2G/320+320/6L/5R/CB_n2_FP_0.3D_HG_EN16	C2DP8400
AS6930G-844G64Mn	EMEA	South Africa	LX.AVB0X.062	AS6930G-844G64Mn EM VHP32ATZA1 MC 9PGE2HM512COF 2*2G/320+320/6L/5R/CB_n2_FP_0.3D_HG_FR23	C2DP8400
AS6930G-844G64Mn	EMEA	Denmark	LX.AVB0X.060	AS6930G-844G64Mn VHP32ATDK1 MC 9PGE2HM512COF 2*2G/320+320/6L/5R/CB_n2_FP_0.3D_HG_NO13	C2DP8400
AS6930G-844G64Mn	EMEA	France	LX.AVB0X.058	AS6930G-844G64Mn VHP32ATFR1 MC 9PGE2HM512COF 2*2G/320+320/6L/5R/CB_n2_FP_0.3D_HG_FR23	C2DP8400
AS6930G-844G64Mn	EMEA	Germany	LX.AVB0X.057	AS6930G-844G64Mn VHP32ATDE1 MC 9PGE2HM512COF 2*2G/320+320/6L/5R/CB_n2_FP_0.3D_HG_DE13	C2DP8400
AS6930G-733G25Mn	EMEA	South Africa	LX.AVB0X.037	AS6930G-733G25Mn EM VHP32ATZA2 MC 9PGE2HM512COF 2G+1G/250/6L/5R/CB_n2_FP_0.3D_HG_EN16	C2DP7350
AS6930G-733G25Mn	EMEA	South Africa	LX.AVB0X.036	AS6930G-733G25Mn EM VHP32ATZA1 MC 9PGE2HM512COF 2G+1G/250/6L/5R/CB_n2_FP_0.3D_HG_FR23	C2DP7350
AS6930G-733G25Mn	EMEA	Denmark	LX.AVB0X.035	AS6930G-733G25Mn VHP32ATDK1 MC 9PGE2HM512COF 2G+1G/250/6L/5R/CB_n2_FP_0.3D_HG_NO13	C2DP7350
AS6930G-733G25Mn	EMEA	France	LX.AVB0X.034	AS6930G-733G25Mn VHP32ATFR1 MC 9PGE2HM512COF 2G+1G/250/6L/5R/CB_n2_FP_0.3D_HG_FR23	C2DP7350
AS6930G-733G25Mn	EMEA	Germany	LX.AVB0X.033	AS6930G-733G25Mn VHP32ATDE1 MC 9PGE2HM512COF 2G+1G/250/6L/5R/CB_n2_FP_0.3D_HG_DE13	C2DP7350
AS6930G-733G25Mn	EMEA	Belgium	LX.AVB0X.032	AS6930G-733G25Mn VHP32ATBE1 MC 9PGE2HM512COF 2G+1G/250/6L/5R/CB_n2_FP_0.3D_HG_NL13	C2DP7350
AS6930G-733G25Mn	EMEA	Holland	LX.AVB0X.031	AS6930G-733G25Mn VHP32ATNL1 MC 9PGE2HM512COF 2G+1G/250/6L/5R/CB_n2_FP_0.3D_HG_NL12	C2DP7350
AS6930G-733G25Mn	EMEA	Luxembourg	LX.AVB0X.030	AS6930G-733G25Mn VHP32ATLU1 MC 9PGE2HM512COF 2G+1G/250/6L/5R/CB_n2_FP_0.3D_HG_IT42	C2DP7350
AS6930G-733G25Mn	EMEA	Norway	LX.AVB0X.029	AS6930G-733G25Mn VHP32ATNO1 MC 9PGE2HM512COF 2G+1G/250/6L/5R/CB_n2_FP_0.3D_HG_NO12	C2DP7350
AS6930G-733G25Mi	EMEA	Russia	LX.AVB0X.028	AS6930G-733G25Mi VHP32ATRU1 MC 9PGE2HM512COF 2G+1G/250/6L/5R/CB_abg_FP_0.3D_HG_RU11	C2DP7350
AS6930G-733G25Mn	EMEA	Sweden/ Finland	LX.AVB0X.027	AS6930G-733G25Mn VHP32ATSE1 MC 9PGE2HM512COF 2G+1G/250/6L/5R/CB_n2_FP_0.3D_HG_FI12	C2DP7350

Model	RO	Country	Acer Part No	Description	CPU
AS6930G-733G25Mn	EMEA	Eastern Europe	LX.AVB0X.026	AS6930G-733G25Mn VHP32ATEU7 MC 9PGE2HM512COF 2G+1G/250/6L/5R/CB_n2_FP_0.3D_HG_ENG1	C2DP7350
AS6930G-733G25Mn	EMEA	Eastern Europe	LX.AVB0X.025	AS6930G-733G25Mn VHP32ATEU6 MC 9PGE2HM512COF 2G+1G/250/6L/5R/CB_n2_FP_0.3D_HG_CS21	C2DP7350
AS6930G-733G25Mn	EMEA	Eastern Europe	LX.AVB0X.024	AS6930G-733G25Mn VHP32ATEU3 MC 9PGE2HM512COF 2G+1G/250/6L/5R/CB_n2_FP_0.3D_HG_RU11	C2DP7350
AS6930G-733G25Mn	EMEA	Eastern Europe	LX.AVB0X.023	AS6930G-733G25Mn VHP32ATEU1 MC 9PGE2HM512COF 2G+1G/250/6L/5R/CB_n2_FP_0.3D_HG_CS21	C2DP7350
AS6930G-733G25Mn	EMEA	Eastern Europe	LX.AVB0X.022	AS6930G-733G25Mn VHP32ATEU4 MC 9PGE2HM512COF 2G+1G/250/6L/5R/CB_n2_FP_0.3D_HG_FI12	C2DP7350
AS6930G-733G25Mn	EMEA	Eastern Europe	LX.AVB0X.021	AS6930G-733G25Mn VHP32ATEU3 MC 9PGE2HM512COF 2G+1G/250/6L/5R/CB_n2_FP_0.3D_HG_RU21	C2DP7350
AS6930G-733G25Mn	EMEA	Eastern Europe	LX.AVB0X.020	AS6930G-733G25Mn VHP32ATEU5 MC 9PGE2HM512COF 2G+1G/250/6L/5R/CB_n2_FP_0.3D_HG_PL11	C2DP7350
AS6930G-733G25Mn	EMEA	Czech	LX.AVB0X.019	AS6930G-733G25Mn VHP32ATCZ2 MC 9PGE2HM512COF 2G+1G/250/6L/5R/CB_n2_FP_0.3D_HG_SK11	C2DP7350
AS6930G-733G25Mn	EMEA	Hungary	LX.AVB0X.018	AS6930G-733G25Mn VHP32ATHU1 MC 9PGE2HM512COF 2G+1G/250/6L/5R/CB_n2_FP_0.3D_HG_HU11	C2DP7350
AS6930G-733G25Mn	EMEA	Slovenia/Croatia	LX.AVB0X.017	AS6930G-733G25Mn VHP32ATS11 MC 9PGE2HM512COF 2G+1G/250/6L/5R/CB_n2_FP_0.3D_HG_EN12	C2DP7350
AS6930G-733G25Mn	EMEA	Portugal	LX.AVB0X.016	AS6930G-733G25Mn VHP32ATPT1 MC 9PGE2HM512COF 2G+1G/250/6L/5R/CB_n2_FP_0.3D_HG_PT12	C2DP7350
AS6930G-733G25Mn	EMEA	Spain	LX.AVB0X.015	AS6930G-733G25Mn VHP32ATES1 MC 9PGE2HM512COF 2G+1G/250/6L/5R/CB_n2_FP_0.3D_HG_ES22	C2DP7350
AS6930G-733G25Mn	EMEA	Greece	LX.AVB0X.014	AS6930G-733G25Mn VHP32ATGR1 MC 9PGE2HM512COF 2G+1G/250/6L/5R/CB_n2_FP_0.3D_HG_EL32	C2DP7350
AS6930G-733G25Mn	EMEA	Greece	LX.AVB0X.013	AS6930G-733G25Mn VHP32ATGR1 MC 9PGE2HM512COF 2G+1G/250/6L/5R/CB_n2_FP_0.3D_HG_EL22	C2DP7350
AS6930G-733G25Mn	EMEA	Israel	LX.AVB0X.012	AS6930G-733G25Mn VHP32ATIL1 MC 9PGE2HM512COF 2G+1G/250/6L/5R/CB_n2_FP_0.3D_HG_HE11	C2DP7350
AS6930G-733G25Mn	EMEA	Italy	LX.AVB0X.011	AS6930G-733G25Mn VHP32ATIT1 MC 9PGE2HM512COF 2G+1G/250/6L/5R/CB_n2_FP_0.3D_HG_IT12	C2DP7350
AS6930G-733G25Mn	EMEA	Middle East	LX.AVB0X.010	AS6930G-733G25Mn EM VHP32ATME9 MC 9PGE2HM512COF 2G+1G/250/6L/5R/CB_n2_FP_0.3D_HG_FR22	C2DP7350
AS6930G-733G25Mn	EMEA	Middle East	LX.AVB0X.009	AS6930G-733G25Mn EM VHP32ATME2 MC 9PGE2HM512COF 2G+1G/250/6L/5R/CB_n2_FP_0.3D_HG_AR13	C2DP7350
AS6930G-733G25Mn	EMEA	Middle East	LX.AVB0X.008	AS6930G-733G25Mn EM VHP32ATME2 MC 9PGE2HM512COF 2G+1G/250/6L/5R/CB_n2_FP_0.3D_HG_EN15	C2DP7350

Model	RO	Country	Acer Part No	Description	CPU
AS6930G-733G25Mn	EMEA	Middle East	LX.AVB0X.007	AS6930G-733G25Mn EM VHP32ATME3 MC 9PGE2HM512COF 2G+1G/250/6L/5R/CB_n2_FP_0.3D_HG_FR23	C2DP7350
AS6930G-733G25Mn	EMEA	Middle East	LX.AVB0X.006	AS6930G-733G25Mn EM VHP32ATME6 MC 9PGE2HM512COF 2G+1G/250/6L/5R/CB_n2_FP_0.3D_HG_EN15	C2DP7350
AS6930G-733G25Mn	EMEA	Middle East	LX.AVB0X.005	AS6930G-733G25Mn EM VHP32ATME2 MC 9PGE2HM512COF 2G+1G/250/6L/5R/CB_n2_FP_0.3D_HG_AR23	C2DP7350
AS6930G-733G25Mn	EMEA	Turkey	LX.AVB0X.004	AS6930G-733G25Mn EM VHP32ATTR1 MC 9PGE2HM512COF 2G+1G/250/6L/5R/CB_n2_FP_0.3D_HG_TR32	C2DP7350
AS6930G-733G25Mn	EMEA	Middle East	LX.AVB0X.003	AS6930G-733G25Mn EM VHP32ATME4 MC 9PGE2HM512COF 2G+1G/250/6L/5R/CB_n2_FP_0.3D_HG_EN11	C2DP7350
AS6930G-733G25Mn	EMEA	Switzerland	LX.AVB0X.002	AS6930G-733G25Mn VHP32ATCH1 MC 9PGE2HM512COF 2G+1G/250/6L/5R/CB_n2_FP_0.3D_HG_IT42	C2DP7350
AS6930G-733G25Mn	EMEA	UK	LX.AVB0X.001	AS6930G-733G25Mn VHP32ATGB1 MC 9PGE2HM512COF 2G+1G/250/6L/5R/CB_n2_FP_0.3D_HG_EN14	C2DP7350
AS6930G-733G32Mn	AAP	Singapore	LX.AVB0X.042	AS6930G-733G32Mn VHP32ATSG1 MC 9PGE2HM512COF 2G+1G/320/BT/8L/5R/CBU_n2_FP_0.3D_HG_ZH31	C2DP7350
AS6930G-583G32Mn	AAP	Singapore	LX.AVB0X.041	AS6930G-583G32Mn VHP32ATSG1 MC 9PGE2HM512COF 2G+1G/320/BT/8L/5R/CBU_n2_FP_0.3D_HG_ZH31	C2DT5800
AS6930G-593G32Mn	AAP	Singapore	LX.AVB0X.040	AS6930G-593G32Mn VHP32ATSG1 MC 9PGE2HM512COF 2G+1G/320/BT/8L/5R/CBU_n2_FP_0.3D_HG_ZH31	C2DT5900
AS6930G-734G32Bn	EMEA	France	LX.AVB0X.038	AS6930G-734G32Bn VHP32ATFR1 MC 9PGE2HM512COF 2*2G/320/BT/6L/5R/CB_n2_FP_0.3D_HG_FR23	C2DP7350
AS6930G-734G32Mn	EMEA	France	LX.AVB0X.121	AS6930G-734G32Mn VHP32ATFR1 MC 9PGE2HM512COF 2*2G/320/6L/5R/CB_n2_FP_0.3D_HG_FR23	C2DP7350
AS6930G-844G64Mn	EMEA	South Africa	LX.AVB0X.120	AS6930G-844G64Mn EM VHP32ATZA2 MC 9PGE2HM512COF 2*2G/320+320/BT/6L/5R/CB_n2_FP_0.3D_HG_EN16	C2DP8400
AS6930G-844G64Mn	EMEA	South Africa	LX.AVB0X.119	AS6930G-844G64Mn EM VHP32ATZA1 MC 9PGE2HM512COF 2*2G/320+320/BT/6L/5R/CB_n2_FP_0.3D_HG_FR23	C2DP8400
AS6930G-844G64Mn	EMEA	Denmark	LX.AVB0X.115	AS6930G-844G64Mn VHP32ATDK1 MC 9PGE2HM512COF 2*2G/320+320/BT/6L/5R/CB_n2_FP_0.3D_HG_NO13	C2DP8400
AS6930G-844G64Mn	EMEA	France	LX.AVB0X.116	AS6930G-844G64Mn VHP32ATFR1 MC 9PGE2HM512COF 2*2G/320+320/BT/6L/5R/CB_n2_FP_0.3D_HG_FR23	C2DP8400
AS6930G-844G64Mn	EMEA	Germany	LX.AVB0X.117	AS6930G-844G64Mn VHP32ATDE1 MC 9PGE2HM512COF 2*2G/320+320/BT/6L/5R/CB_n2_FP_0.3D_HG_DE13	C2DP8400
AS6930G-844G64Mn	EMEA	Belgium	LX.AVB0X.118	AS6930G-844G64Mn VHP32ATBE1 MC 9PGE2HM512COF 2*2G/320+320/BT/6L/5R/CB_n2_FP_0.3D_HG_NL13	C2DP8400
AS6930G-844G64Mn	EMEA	Holland	LX.AVB0X.112	AS6930G-844G64Mn VHP32ATNL1 MC 9PGE2HM512COF 2*2G/320+320/BT/6L/5R/CB_n2_FP_0.3D_HG_NL12	C2DP8400

Model	RO	Country	Acer Part No	Description	CPU
AS6930G-844G64Mn	EMEA	Luxembourg	LX.AVB0X.113	AS6930G-844G64Mn VHP32ATLU1 MC 9PGE2HM512COF 2*2G/320+320/BT/6L/5R/CB_n2_FP_0.3D_HG_IT42	C2DP8400
AS6930G-844G64Mn	EMEA	Norway	LX.AVB0X.114	AS6930G-844G64Mn VHP32ATNO1 MC 9PGE2HM512COF 2*2G/320+320/BT/6L/5R/CB_n2_FP_0.3D_HG_NO12	C2DP8400
AS6930G-844G64Mi	EMEA	Russia	LX.AVB0X.111	AS6930G-844G64Mi VHP32ATRU1 MC 9PGE2HM512COF 2*2G/320+320/BT/6L/5R/CB_abg_FP_0.3D_HG_RU11	C2DP8400
AS6930G-844G64Mn	EMEA	Sweden/ Finland	LX.AVB0X.110	AS6930G-844G64Mn VHP32ATSE1 MC 9PGE2HM512COF 2*2G/320+320/BT/6L/5R/CB_n2_FP_0.3D_HG_FI12	C2DP8400
AS6930G-844G64Mn	EMEA	Czech	LX.AVB0X.109	AS6930G-844G64Mn VHP32ATCZ2 MC 9PGE2HM512COF 2*2G/320+320/BT/6L/5R/CB_n2_FP_0.3D_HG_SK11	C2DP8400
AS6930G-844G64Mn	EMEA	Eastern Europe	LX.AVB0X.105	AS6930G-844G64Mn VHP32ATEU7 MC 9PGE2HM512COF 2*2G/320+320/BT/6L/5R/CB_n2_FP_0.3D_HG_ENG1	C2DP8400
AS6930G-844G64Mn	EMEA	Eastern Europe	LX.AVB0X.106	AS6930G-844G64Mn VHP32ATEU6 MC 9PGE2HM512COF 2*2G/320+320/BT/6L/5R/CB_n2_FP_0.3D_HG_CS21	C2DP8400
AS6930G-844G64Mn	EMEA	Eastern Europe	LX.AVB0X.107	AS6930G-844G64Mn VHP32ATEU3 MC 9PGE2HM512COF 2*2G/320+320/BT/6L/5R/CB_n2_FP_0.3D_HG_RU11	C2DP8400
AS6930G-844G64Mn	EMEA	Eastern Europe	LX.AVB0X.108	AS6930G-844G64Mn VHP32ATEU1 MC 9PGE2HM512COF 2*2G/320+320/BT/6L/5R/CB_n2_FP_0.3D_HG_CS21	C2DP8400
AS6930G-844G64Mn	EMEA	Eastern Europe	LX.AVB0X.102	AS6930G-844G64Mn VHP32ATEU4 MC 9PGE2HM512COF 2*2G/320+320/BT/6L/5R/CB_n2_FP_0.3D_HG_FI12	C2DP8400
AS6930G-844G64Mn	EMEA	Eastern Europe	LX.AVB0X.103	AS6930G-844G64Mn VHP32ATEU3 MC 9PGE2HM512COF 2*2G/320+320/BT/6L/5R/CB_n2_FP_0.3D_HG_RU21	C2DP8400
AS6930G-844G64Mn	EMEA	Eastern Europe	LX.AVB0X.104	AS6930G-844G64Mn VHP32ATEU5 MC 9PGE2HM512COF 2*2G/320+320/BT/6L/5R/CB_n2_FP_0.3D_HG_PL11	C2DP8400
AS6930G-844G64Mn	EMEA	Hungary	LX.AVB0X.101	AS6930G-844G64Mn VHP32ATHU1 MC 9PGE2HM512COF 2*2G/320+320/BT/6L/5R/CB_n2_FP_0.3D_HG_HU11	C2DP8400
AS6930G-844G64Mn	EMEA	Slovenia/ Croatia	LX.AVB0X.099	AS6930G-844G64Mn VHP32ATSI1 MC 9PGE2HM512COF 2*2G/320+320/BT/6L/5R/CB_n2_FP_0.3D_HG_EN12	C2DP8400
AS6930G-844G64Mn	EMEA	Portugal	LX.AVB0X.098	AS6930G-844G64Mn VHP32ATPT1 MC 9PGE2HM512COF 2*2G/320+320/BT/6L/5R/CB_n2_FP_0.3D_HG_PT12	C2DP8400
AS6930G-844G64Mn	EMEA	Spain	LX.AVB0X.094	AS6930G-844G64Mn VHP32ATES1 MC 9PGE2HM512COF 2*2G/320+320/BT/6L/5R/CB_n2_FP_0.3D_HG_ES22	C2DP8400
AS6930G-844G64Mn	EMEA	Greece	LX.AVB0X.095	AS6930G-844G64Mn VHP32ATGR1 MC 9PGE2HM512COF 2*2G/320+320/BT/6L/5R/CB_n2_FP_0.3D_HG_EL32	C2DP8400
AS6930G-844G64Mn	EMEA	Greece	LX.AVB0X.096	AS6930G-844G64Mn VHP32ATGR1 MC 9PGE2HM512COF 2*2G/320+320/BT/6L/5R/CB_n2_FP_0.3D_HG_EL22	C2DP8400
AS6930G-844G64Mn	EMEA	Israel	LX.AVB0X.097	AS6930G-844G64Mn VHP32ATIL1 MC 9PGE2HM512COF 2*2G/320+320/BT/6L/5R/CB_n2_FP_0.3D_HG_HE11	C2DP8400

Model	RO	Country	Acer Part No	Description	CPU
AS6930G-842G25Bn	CHINA	China	LX.AVB0X.082	AS6930G-842G25Bn VHP32ATCN1 MC 9PGE2HM512COF 2*1G/250/6L/5R/CB_n2_FP_0.3D_HG_SC11	C2DP8400
AS6930G-862G32Bn	CHINA	China	LX.AVB0X.081	AS6930G-862G32Bn VHP32ATCN1 MC 9PGE2HM512COF 2*1G/320/6L/5R/CB_n2_FP_0.3D_HG_SC11	C2DP8600
AS6930G-864G32Bn	CHINA	China	LX.AVB0X.080	AS6930G-864G32Bn VHP32ATCN1 MC 9PGE2HM512COF 2*2G/320/6L/5R/CB_n2_FP_0.3D_HG_SC11	C2DP8600
AS6930G-844G64Mn	EMEA	Italy	LX.AVB0X.091	AS6930G-844G64Mn VHP32ATIT1 MC 9PGE2HM512COF 2*2G/320+320/BT/6L/5R/CB_n2_FP_0.3D_HG_IT12	C2DP8400
AS6930G-844G64Mn	EMEA	Turkey	LX.AVB0X.092	AS6930G-844G64Mn EM VHP32ATTR1 MC 9PGE2HM512COF 2*2G/320+320/BT/6L/5R/CB_n2_FP_0.3D_HG_TR32	C2DP8400
AS6930G-844G64Mn	EMEA	Middle East	LX.AVB0X.093	AS6930G-844G64Mn EM VHP32ATME9 MC 9PGE2HM512COF 2*2G/320+320/BT/6L/5R/CB_n2_FP_0.3D_HG_FR22	C2DP8400
AS6930G-844G64Mn	EMEA	Middle East	LX.AVB0X.087	AS6930G-844G64Mn EM VHP32ATME2 MC 9PGE2HM512COF 2*2G/320+320/BT/6L/5R/CB_n2_FP_0.3D_HG_AR13	C2DP8400
AS6930G-844G64Mn	EMEA	Middle East	LX.AVB0X.090	AS6930G-844G64Mn EM VHP32ATME2 MC 9PGE2HM512COF 2*2G/320+320/BT/6L/5R/CB_n2_FP_0.3D_HG_EN15	C2DP8400
AS6930G-844G64Mn	EMEA	Middle East	LX.AVB0X.089	AS6930G-844G64Mn EM VHP32ATME3 MC 9PGE2HM512COF 2*2G/320+320/BT/6L/5R/CB_n2_FP_0.3D_HG_FR23	C2DP8400
AS6930G-844G64Mn	EMEA	Middle East	LX.AVB0X.088	AS6930G-844G64Mn EM VHP32ATME6 MC 9PGE2HM512COF 2*2G/320+320/BT/6L/5R/CB_n2_FP_0.3D_HG_EN15	C2DP8400
AS6930G-844G64Mn	EMEA	Middle East	LX.AVB0X.084	AS6930G-844G64Mn EM VHP32ATME2 MC 9PGE2HM512COF 2*2G/320+320/BT/6L/5R/CB_n2_FP_0.3D_HG_AR23	C2DP8400
AS6930G-844G64Mn	EMEA	Middle East	LX.AVB0X.085	AS6930G-844G64Mn EM VHP32ATME4 MC 9PGE2HM512COF 2*2G/320+320/BT/6L/5R/CB_n2_FP_0.3D_HG_EN11	C2DP8400
AS6930G-844G64Mn	EMEA	Switzerland	LX.AVB0X.086	AS6930G-844G64Mn VHP32ATCH1 MC 9PGE2HM512COF 2*2G/320+320/BT/6L/5R/CB_n2_FP_0.3D_HG_IT42	C2DP8400
AS6930G-844G64Mn	EMEA	UK	LX.AVB0X.083	AS6930G-844G64Mn VHP32ATGB1 MC 9PGE2HM512COF 2*2G/320+320/BT/6L/5R/CB_n2_FP_0.3D_HG_EN14	C2DP8400
AS6930G-944G32Mn	EMEA	Greece	LX.AVL0X.002	AS6930G-944G32Mn VHP32ATGR1 MC 9PGSHM512TCOF 2*2G/320/BT/6L/5R/CB_n2_DVBT U/ VHF_FP_0.3D_HG_EL32	C2DT9400
AS6930G-944G32Mn	EMEA	Italy	LX.AVL0X.001	AS6930G-944G32Mn VHP32ATIT1 MC 9PGSHM512TCOF 2*2G/320/BT/6L/5R/CB_n2_DVBT U/ VHF_FP_0.3D_HG_IT12	C2DT9400
AS6930G-943G64Mn	AAP	Australia/New Zealand	LX.AVL0X.003	AS6930G-943G64Mn VHP32ATAU1 MC 9PGSHM512TCOF 2G+1G/320+320/BT/6L/5R/CB_n2_DVBT U/ VHF_FP_0.3D_HG_EN12	C2DT9400
AS6930G-733G32Bn	EMEA	Denmark	LX.AUU0X.036	AS6930G-733G32Bn VHP32ATDK1 MC 9MGSHM256COF 2G+1G/320/6L/CB_n2_FP_0.3D_HG_NO13	C2DP7350

Model	RO	Country	Acer Part No	Description	CPU
AS6930G-733G32Bn	EMEA	France	LX.AUU0X.035	AS6930G-733G32Bn VHP32ATFR1 MC 9MGSHM256COF 2G+1G/320/6L/ CB_n2_FP_0.3D_HG_FR23	C2DP7350
AS6930G-733G32Bn	EMEA	Germany	LX.AUU0X.034	AS6930G-733G32Bn VHP32ATDE1 MC 9MGSHM256COF 2G+1G/320/6L/ CB_n2_FP_0.3D_HG_DE13	C2DP7350
AS6930G-733G32Bn	EMEA	Belgium	LX.AUU0X.033	AS6930G-733G32Bn VHP32ATBE1 MC 9MGSHM256COF 2G+1G/320/6L/ CB_n2_FP_0.3D_HG_NL13	C2DP7350
AS6930G-733G32Bn	EMEA	Holland	LX.AUU0X.032	AS6930G-733G32Bn VHP32ATNL1 MC 9MGSHM256COF 2G+1G/320/6L/ CB_n2_FP_0.3D_HG_NL12	C2DP7350
AS6930G-733G32Bn	EMEA	Luxembourg	LX.AUU0X.031	AS6930G-733G32Bn VHP32ATLU1 MC 9MGSHM256COF 2G+1G/320/6L/ CB_n2_FP_0.3D_HG_IT42	C2DP7350
AS6930G-733G32Bn	EMEA	Norway	LX.AUU0X.030	AS6930G-733G32Bn VHP32ATNO1 MC 9MGSHM256COF 2G+1G/320/6L/ CB_n2_FP_0.3D_HG_NO12	C2DP7350
AS6930G-733G32Bi	EMEA	Russia	LX.AUU0X.029	AS6930G-733G32Bi VHP32ATRU1 MC 9MGSHM256COF 2G+1G/320/6L/ CB_abg_FP_0.3D_HG_RU11	C2DP7350
AS6930G-842G32Bn	AAP	Indonesia	LX.AUU0X.147	AS6930G-842G32Bn EM VHP32ATID1 MC 9MGSHM256COF 1*2G/320/BT/8L/ 5R/CB_n2_FP_0.3D_HG_ID22	C2DP8400
AS6930G-733G32Bn	EMEA	Sweden/ Finland	LX.AUU0X.028	AS6930G-733G32Bn VHP32ATSE1 MC 9MGSHM256COF 2G+1G/320/6L/ CB_n2_FP_0.3D_HG_FI12	C2DP7350
AS6930G-733G32Bn	EMEA	Czech	LX.AUU0X.027	AS6930G-733G32Bn VHP32ATCZ2 MC 9MGSHM256COF 2G+1G/320/6L/ CB_n2_FP_0.3D_HG_SK11	C2DP7350
AS6930G-733G32Bn	EMEA	Eastern Europe	LX.AUU0X.026	AS6930G-733G32Bn VHP32ATEU6 MC 9MGSHM256COF 2G+1G/320/6L/ CB_n2_FP_0.3D_HG_CS21	C2DP7350
AS6930G-733G32Bn	EMEA	Eastern Europe	LX.AUU0X.025	AS6930G-733G32Bn VHP32ATEU3 MC 9MGSHM256COF 2G+1G/320/6L/ CB_n2_FP_0.3D_HG_RU11	C2DP7350
AS6930G-733G32Bn	EMEA	Eastern Europe	LX.AUU0X.024	AS6930G-733G32Bn VHP32ATEU1 MC 9MGSHM256COF 2G+1G/320/6L/ CB_n2_FP_0.3D_HG_CS21	C2DP7350
AS6930G-733G32Bn	EMEA	Eastern Europe	LX.AUU0X.023	AS6930G-733G32Bn VHP32ATEU4 MC 9MGSHM256COF 2G+1G/320/6L/ CB_n2_FP_0.3D_HG_FI12	C2DP7350
AS6930G-733G32Bn	EMEA	Eastern Europe	LX.AUU0X.022	AS6930G-733G32Bn VHP32ATEU3 MC 9MGSHM256COF 2G+1G/320/6L/ CB_n2_FP_0.3D_HG_RU21	C2DP7350
AS6930G-733G32Bn	EMEA	Eastern Europe	LX.AUU0X.021	AS6930G-733G32Bn VHP32ATEU5 MC 9MGSHM256COF 2G+1G/320/6L/ CB_n2_FP_0.3D_HG_PL11	C2DP7350
AS6930G-733G32Bn	EMEA	Hungary	LX.AUU0X.020	AS6930G-733G32Bn VHP32ATHU1 MC 9MGSHM256COF 2G+1G/320/6L/ CB_n2_FP_0.3D_HG_HU11	C2DP7350
AS6930G-733G32Bn	EMEA	Slovenia/ Croatia	LX.AUU0X.019	AS6930G-733G32Bn VHP32ATSI1 MC 9MGSHM256COF 2G+1G/320/6L/ CB_n2_FP_0.3D_HG_EN12	C2DP7350
AS6930G-733G32Bn	EMEA	Portugal	LX.AUU0X.018	AS6930G-733G32Bn VHP32ATPT1 MC 9MGSHM256COF 2G+1G/320/6L/ CB_n2_FP_0.3D_HG_PT12	C2DP7350

Model	RO	Country	Acer Part No	Description	CPU
AS6930G-733G32Bn	EMEA	Spain	LX.AUU0X.017	AS6930G-733G32Bn VHP32ATES1 MC 9MGSHM256COF 2G+1G/320/6L/ CB_n2_FP_0.3D_HG_ES22	C2DP7350
AS6930G-733G32Bn	EMEA	Greece	LX.AUU0X.016	AS6930G-733G32Bn VHP32ATGR1 MC 9MGSHM256COF 2G+1G/320/6L/ CB_n2_FP_0.3D_HG_EL32	C2DP7350
AS6930G-733G32Bn	EMEA	Greece	LX.AUU0X.015	AS6930G-733G32Bn VHP32ATGR1 MC 9MGSHM256COF 2G+1G/320/6L/ CB_n2_FP_0.3D_HG_EL22	C2DP7350
AS6930G-733G32Bn	EMEA	Israel	LX.AUU0X.014	AS6930G-733G32Bn VHP32ATIL1 MC 9MGSHM256COF 2G+1G/320/6L/ CB_n2_FP_0.3D_HG_HE11	C2DP7350
AS6930G-733G32Bn	EMEA	Italy	LX.AUU0X.013	AS6930G-733G32Bn VHP32ATIT1 MC 9MGSHM256COF 2G+1G/320/6L/ CB_n2_FP_0.3D_HG_IT12	C2DP7350
AS6930G-733G32Bn	EMEA	Turkey	LX.AUU0X.012	AS6930G-733G32Bn EM VHP32ATTR1 MC 9MGSHM256COF 2G+1G/320/6L/ CB_n2_FP_0.3D_HG_TR32	C2DP7350
AS6930G-733G32Bn	EMEA	Middle East	LX.AUU0X.011	AS6930G-733G32Bn EM VHP32ATME9 MC 9MGSHM256COF 2G+1G/320/6L/ CB_n2_FP_0.3D_HG_FR22	C2DP7350
AS6930G-733G32Bn	EMEA	Middle East	LX.AUU0X.010	AS6930G-733G32Bn EM VHP32ATME2 MC 9MGSHM256COF 2G+1G/320/6L/ CB_n2_FP_0.3D_HG_AR13	C2DP7350
AS6930G-733G32Bn	EMEA	Middle East	LX.AUU0X.009	AS6930G-733G32Bn EM VHP32ATME2 MC 9MGSHM256COF 2G+1G/320/6L/ CB_n2_FP_0.3D_HG_EN15	C2DP7350
AS6930G-733G32Bn	EMEA	Middle East	LX.AUU0X.008	AS6930G-733G32Bn EM VHP32ATME3 MC 9MGSHM256COF 2G+1G/320/6L/ CB_n2_FP_0.3D_HG_FR23	C2DP7350
AS6930G-733G32Bn	EMEA	Middle East	LX.AUU0X.007	AS6930G-733G32Bn EM VHP32ATME6 MC 9MGSHM256COF 2G+1G/320/6L/ CB_n2_FP_0.3D_HG_EN15	C2DP7350
AS6930G-733G32Bn	EMEA	Middle East	LX.AUU0X.006	AS6930G-733G32Bn EM VHP32ATME2 MC 9MGSHM256COF 2G+1G/320/6L/ CB_n2_FP_0.3D_HG_AR23	C2DP7350
AS6930G-733G32Bn	EMEA	Middle East	LX.AUU0X.005	AS6930G-733G32Bn EM VHP32ATME4 MC 9MGSHM256COF 2G+1G/320/6L/ CB_n2_FP_0.3D_HG_EN11	C2DP7350
AS6930G-733G32Bn	EMEA	Switzerland	LX.AUU0X.004	AS6930G-733G32Bn VHP32ATCH1 MC 9MGSHM256COF 2G+1G/320/6L/ CB_n2_FP_0.3D_HG_IT42	C2DP7350
AS6930G-733G32Bn	EMEA	UK	LX.AUU0X.003	AS6930G-733G32Bn VHP32ATGB1 MC 9MGSHM256COF 2G+1G/320/6L/ CB_n2_FP_0.3D_HG_EN14	C2DP7350
AS6930G-733G32Mn	AAP	Singapore	LX.AUU0X.143	AS6930G-733G32Mn VHP32ATSG1 MC 9MGSHM256COF 2G+1G/320/6L/5R/ CB_n3_FP_0.3D_HG_ZH31	C2DP7350
AS6930G-843G32Mn	AAP	Singapore	LX.AUU0X.142	AS6930G-843G32Mn VHP32ATSG1 MC 9MGSHM256COF 2G+1G/320/6L/5R/ CB_n3_FP_0.3D_HG_ZH31	C2DP8400
AS6930G-863G32Mn	AAP	Singapore	LX.AUU0X.141	AS6930G-863G32Mn VHP32ATSG1 MC 9MGSHM256COF 2G+1G/320/6L/5R/ CB_n3_FP_0.3D_HG_ZH31	C2DP8600
AS6930G-583G25Mn	EMEA	South Africa	LX.AUU0X.186	AS6930G-583G25Mn EM VHP32ATZA2 MC 9MGSHM256COF 2G+1G/250/6L/5R/ CB_n2_FP_0.3D_HG_EN16	C2DT5800

Model	RO	Country	Acer Part No	Description	CPU
AS6930G-583G25Mn	EMEA	South Africa	LX.AUU0X.185	AS6930G-583G25Mn EM VHP32ATZA1 MC 9MGSHM256COF 2G+1G/250/6L/5R/CB_n2_FP_0.3D_HG_FR23	C2DT5800
AS6930G-583G25Mn	EMEA	Denmark	LX.AUU0X.184	AS6930G-583G25Mn VHP32ATDK1 MC 9MGSHM256COF 2G+1G/250/6L/5R/CB_n2_FP_0.3D_HG_NO13	C2DT5800
AS6930G-583G25Mn	EMEA	Germany	LX.AUU0X.183	AS6930G-583G25Mn VHP32ATDE1 MC 9MGSHM256COF 2G+1G/250/6L/5R/CB_n2_FP_0.3D_HG_DE13	C2DT5800
AS6930G-583G25Mn	EMEA	Belgium	LX.AUU0X.182	AS6930G-583G25Mn VHP32ATBE1 MC 9MGSHM256COF 2G+1G/250/6L/5R/CB_n2_FP_0.3D_HG_NL13	C2DT5800
AS6930G-583G25Mn	EMEA	Holland	LX.AUU0X.181	AS6930G-583G25Mn VHP32ATNL1 MC 9MGSHM256COF 2G+1G/250/6L/5R/CB_n2_FP_0.3D_HG_NL12	C2DT5800
AS6930G-583G25Mn	EMEA	Luxembourg	LX.AUU0X.180	AS6930G-583G25Mn VHP32ATLU1 MC 9MGSHM256COF 2G+1G/250/6L/5R/CB_n2_FP_0.3D_HG_IT42	C2DT5800
AS6930G-583G25Mn	EMEA	Norway	LX.AUU0X.179	AS6930G-583G25Mn VHP32ATNO1 MC 9MGSHM256COF 2G+1G/250/6L/5R/CB_n2_FP_0.3D_HG_NO12	C2DT5800
AS6930G-583G25Mi	EMEA	Russia	LX.AUU0X.178	AS6930G-583G25Mi VHP32ATRU1 MC 9MGSHM256COF 2G+1G/250/6L/5R/CB_abg_FP_0.3D_HG_RU11	C2DT5800
AS6930G-583G25Mn	EMEA	Sweden/ Finland	LX.AUU0X.177	AS6930G-583G25Mn VHP32ATSE1 MC 9MGSHM256COF 2G+1G/250/6L/5R/CB_n2_FP_0.3D_HG_FI12	C2DT5800
AS6930G-583G25Mn	EMEA	Czech	LX.AUU0X.176	AS6930G-583G25Mn VHP32ATCZ2 MC 9MGSHM256COF 2G+1G/250/6L/5R/CB_n2_FP_0.3D_HG_SK11	C2DT5800
AS6930G-583G25Mn	EMEA	Eastern Europe	LX.AUU0X.175	AS6930G-583G25Mn VHP32ATEU7 MC 9MGSHM256COF 2G+1G/250/6L/5R/CB_n2_FP_0.3D_HG_ENG1	C2DT5800
AS6930G-583G25Mn	EMEA	Eastern Europe	LX.AUU0X.174	AS6930G-583G25Mn VHP32ATEU6 MC 9MGSHM256COF 2G+1G/250/6L/5R/CB_n2_FP_0.3D_HG_CS21	C2DT5800
AS6930G-583G25Mn	EMEA	Eastern Europe	LX.AUU0X.173	AS6930G-583G25Mn VHP32ATEU3 MC 9MGSHM256COF 2G+1G/250/6L/5R/CB_n2_FP_0.3D_HG_RU11	C2DT5800
AS6930G-583G25Mn	EMEA	Eastern Europe	LX.AUU0X.172	AS6930G-583G25Mn VHP32ATEU1 MC 9MGSHM256COF 2G+1G/250/6L/5R/CB_n2_FP_0.3D_HG_CS21	C2DT5800
AS6930G-583G25Mn	EMEA	Eastern Europe	LX.AUU0X.171	AS6930G-583G25Mn VHP32ATEU4 MC 9MGSHM256COF 2G+1G/250/6L/5R/CB_n2_FP_0.3D_HG_FI12	C2DT5800
AS6930G-583G25Mn	EMEA	Eastern Europe	LX.AUU0X.170	AS6930G-583G25Mn VHP32ATEU3 MC 9MGSHM256COF 2G+1G/250/6L/5R/CB_n2_FP_0.3D_HG_RU21	C2DT5800
AS6930G-583G25Mn	EMEA	Eastern Europe	LX.AUU0X.169	AS6930G-583G25Mn VHP32ATEU5 MC 9MGSHM256COF 2G+1G/250/6L/5R/CB_n2_FP_0.3D_HG_PL11	C2DT5800
AS6930G-583G25Mn	EMEA	Hungary	LX.AUU0X.168	AS6930G-583G25Mn VHP32ATHU1 MC 9MGSHM256COF 2G+1G/250/6L/5R/CB_n2_FP_0.3D_HG_HU11	C2DT5800
AS6930G-583G25Mn	EMEA	Slovenia/ Croatia	LX.AUU0X.167	AS6930G-583G25Mn VHP32ATSI1 MC 9MGSHM256COF 2G+1G/250/6L/5R/CB_n2_FP_0.3D_HG_EN12	C2DT5800

Model	RO	Country	Acer Part No	Description	CPU
AS6930G-583G25Mn	EMEA	Portugal	LX.AUU0X.166	AS6930G-583G25Mn VHP32ATPT1 MC 9MGSHM256COF 2G+1G/250/6L/5R/ CB_n2_FP_0.3D_HG_PT12	C2DT5800
AS6930G-583G25Mn	EMEA	Spain	LX.AUU0X.165	AS6930G-583G25Mn VHP32ATES1 MC 9MGSHM256COF 2G+1G/250/6L/5R/ CB_n2_FP_0.3D_HG_ES22	C2DT5800
AS6930G-583G25Mn	EMEA	Greece	LX.AUU0X.164	AS6930G-583G25Mn VHP32ATGR1 MC 9MGSHM256COF 2G+1G/250/6L/5R/ CB_n2_FP_0.3D_HG_EL32	C2DT5800
AS6930G-583G25Mn	EMEA	Greece	LX.AUU0X.163	AS6930G-583G25Mn VHP32ATGR1 MC 9MGSHM256COF 2G+1G/250/6L/5R/ CB_n2_FP_0.3D_HG_EL22	C2DT5800
AS6930G-583G25Mn	EMEA	Israel	LX.AUU0X.162	AS6930G-583G25Mn VHP32ATIL1 MC 9MGSHM256COF 2G+1G/250/6L/5R/ CB_n2_FP_0.3D_HG_HE11	C2DT5800
AS6930G-583G25Mn	EMEA	Italy	LX.AUU0X.161	AS6930G-583G25Mn VHP32ATIT1 MC 9MGSHM256COF 2G+1G/250/6L/5R/ CB_n2_FP_0.3D_HG_IT12	C2DT5800
AS6930G-583G25Mn	EMEA	Turkey	LX.AUU0X.160	AS6930G-583G25Mn EM VHP32ATTR1 MC 9MGSHM256COF 2G+1G/250/6L/5R/CB_n2_FP_0.3D_HG_TR32	C2DT5800
AS6930G-583G25Mn	EMEA	Middle East	LX.AUU0X.159	AS6930G-583G25Mn EM VHP32ATME9 MC 9MGSHM256COF 2G+1G/250/6L/5R/CB_n2_FP_0.3D_HG_FR22	C2DT5800
AS6930G-583G25Mn	EMEA	Middle East	LX.AUU0X.158	AS6930G-583G25Mn EM VHP32ATME2 MC 9MGSHM256COF 2G+1G/250/6L/5R/CB_n2_FP_0.3D_HG_AR13	C2DT5800
AS6930G-583G25Mn	EMEA	Middle East	LX.AUU0X.157	AS6930G-583G25Mn EM VHP32ATME2 MC 9MGSHM256COF 2G+1G/250/6L/5R/CB_n2_FP_0.3D_HG_EN15	C2DT5800
AS6930G-583G25Mn	EMEA	Middle East	LX.AUU0X.156	AS6930G-583G25Mn EM VHP32ATME3 MC 9MGSHM256COF 2G+1G/250/6L/5R/CB_n2_FP_0.3D_HG_FR23	C2DT5800
AS6930G-583G25Mn	EMEA	Middle East	LX.AUU0X.155	AS6930G-583G25Mn EM VHP32ATME6 MC 9MGSHM256COF 2G+1G/250/6L/5R/CB_n2_FP_0.3D_HG_EN15	C2DT5800
AS6930G-583G25Mn	EMEA	Middle East	LX.AUU0X.154	AS6930G-583G25Mn EM VHP32ATME2 MC 9MGSHM256COF 2G+1G/250/6L/5R/CB_n2_FP_0.3D_HG_AR23	C2DT5800
AS6930G-583G25Mn	EMEA	Middle East	LX.AUU0X.153	AS6930G-583G25Mn EM VHP32ATME4 MC 9MGSHM256COF 2G+1G/250/6L/5R/CB_n2_FP_0.3D_HG_EN11	C2DT5800
AS6930G-583G25Mn	EMEA	Switzerland	LX.AUU0X.152	AS6930G-583G25Mn VHP32ATCH1 MC 9MGSHM256COF 2G+1G/250/6L/5R/ CB_n2_FP_0.3D_HG_IT42	C2DT5800
AS6930G-583G25Mn	EMEA	UK	LX.AUU0X.151	AS6930G-583G25Mn VHP32ATGB1 MC 9MGSHM256COF 2G+1G/250/6L/5R/ CB_n2_FP_0.3D_HG_EN14	C2DT5800
AS6930G-733G32Bn	EMEA	South Africa	LX.AUU0X.002	AS6930G-733G32Bn EM VHP32ATZA2 MC 9MGSHM256COF 2G+1G/320/6L/ CB_n2_FP_0.3D_HG_EN16	C2DP7350
AS6930G-733G32Bn	EMEA	South Africa	LX.AUU0X.001	AS6930G-733G32Bn EM VHP32ATZA1 MC 9MGSHM256COF 2G+1G/320/6L/ CB_n2_FP_0.3D_HG_FR23	C2DP7350
AS6930G-733G32Mn	EMEA	South Africa	LX.AUU0X.073	AS6930G-733G32Mn EM VHP32ATZA2 MC 9MGSHM256COF 2G+1G/320/6L/ CB_n2_FP_0.3D_HG_EN16	C2DP7350

Model	RO	Country	Acer Part No	Description	CPU
AS6930G-733G32Mn	EMEA	South Africa	LX.AUU0X.072	AS6930G-733G32Mn EM VHP32ATZA1 MC 9MGSHM256COF 2G+1G/320/6L/ CB_n2_FP_0.3D_HG_FR23	C2DP7350
AS6930G-733G32Mn	EMEA	Denmark	LX.AUU0X.071	AS6930G-733G32Mn VHP32ATDK1 MC 9MGSHM256COF 2G+1G/320/6L/ CB_n2_FP_0.3D_HG_NO13	C2DP7350
AS6930G-733G32Mn	EMEA	France	LX.AUU0X.070	AS6930G-733G32Mn VHP32ATFR1 MC 9MGSHM256COF 2G+1G/320/6L/ CB_n2_FP_0.3D_HG_FR23	C2DP7350
AS6930G-733G32Mn	EMEA	Germany	LX.AUU0X.069	AS6930G-733G32Mn VHP32ATDE1 MC 9MGSHM256COF 2G+1G/320/6L/ CB_n2_FP_0.3D_HG_DE13	C2DP7350
AS6930G-733G32Mn	EMEA	Belgium	LX.AUU0X.068	AS6930G-733G32Mn VHP32ATBE1 MC 9MGSHM256COF 2G+1G/320/6L/ CB_n2_FP_0.3D_HG_NL13	C2DP7350
AS6930G-733G32Mn	EMEA	Holland	LX.AUU0X.067	AS6930G-733G32Mn VHP32ATNL1 MC 9MGSHM256COF 2G+1G/320/6L/ CB_n2_FP_0.3D_HG_NL12	C2DP7350
AS6930G-733G32Mn	EMEA	Luxembourg	LX.AUU0X.066	AS6930G-733G32Mn VHP32ATLU1 MC 9MGSHM256COF 2G+1G/320/6L/ CB_n2_FP_0.3D_HG_IT42	C2DP7350
AS6930G-733G32Mn	EMEA	Norway	LX.AUU0X.065	AS6930G-733G32Mn VHP32ATNO1 MC 9MGSHM256COF 2G+1G/320/6L/ CB_n2_FP_0.3D_HG_NO12	C2DP7350
AS6930G-733G32Mi	EMEA	Russia	LX.AUU0X.064	AS6930G-733G32Mi VHP32ATRU1 MC 9MGSHM256COF 2G+1G/320/6L/ CB_abg_FP_0.3D_HG_RU11	C2DP7350
AS6930G-733G32Mn	EMEA	Sweden/ Finland	LX.AUU0X.063	AS6930G-733G32Mn VHP32ATSE1 MC 9MGSHM256COF 2G+1G/320/6L/ CB_n2_FP_0.3D_HG_FI12	C2DP7350
AS6930G-733G32Mn	EMEA	Czech	LX.AUU0X.062	AS6930G-733G32Mn VHP32ATCZ2 MC 9MGSHM256COF 2G+1G/320/6L/ CB_n2_FP_0.3D_HG_SK11	C2DP7350
AS6930G-733G32Mn	EMEA	Eastern Europe	LX.AUU0X.061	AS6930G-733G32Mn VHP32ATEU7 MC 9MGSHM256COF 2G+1G/320/6L/ CB_n2_FP_0.3D_HG_ENG1	C2DP7350
AS6930G-733G32Mn	EMEA	Eastern Europe	LX.AUU0X.060	AS6930G-733G32Mn VHP32ATEU6 MC 9MGSHM256COF 2G+1G/320/6L/ CB_n2_FP_0.3D_HG_CS21	C2DP7350
AS6930G-733G32Mn	EMEA	Eastern Europe	LX.AUU0X.059	AS6930G-733G32Mn VHP32ATEU3 MC 9MGSHM256COF 2G+1G/320/6L/ CB_n2_FP_0.3D_HG_RU11	C2DP7350
AS6930G-733G32Mn	EMEA	Eastern Europe	LX.AUU0X.058	AS6930G-733G32Mn VHP32ATEU1 MC 9MGSHM256COF 2G+1G/320/6L/ CB_n2_FP_0.3D_HG_CS21	C2DP7350
AS6930G-733G32Mn	EMEA	Eastern Europe	LX.AUU0X.057	AS6930G-733G32Mn VHP32ATEU4 MC 9MGSHM256COF 2G+1G/320/6L/ CB_n2_FP_0.3D_HG_FI12	C2DP7350
AS6930G-733G32Mn	EMEA	Eastern Europe	LX.AUU0X.056	AS6930G-733G32Mn VHP32ATEU3 MC 9MGSHM256COF 2G+1G/320/6L/ CB_n2_FP_0.3D_HG_RU21	C2DP7350
AS6930G-733G32Mn	EMEA	Eastern Europe	LX.AUU0X.055	AS6930G-733G32Mn VHP32ATEU5 MC 9MGSHM256COF 2G+1G/320/6L/ CB_n2_FP_0.3D_HG_PL11	C2DP7350
AS6930G-733G32Mn	EMEA	Hungary	LX.AUU0X.054	AS6930G-733G32Mn VHP32ATHU1 MC 9MGSHM256COF 2G+1G/320/6L/ CB_n2_FP_0.3D_HG_HU11	C2DP7350

Model	RO	Country	Acer Part No	Description	CPU
AS6930G-733G32Mn	EMEA	Slovenia/ Croatia	LX.AUU0X.053	AS6930G-733G32Mn VHP32ATSI1 MC 9MGSHM256COF 2G+1G/320/6L/ CB_n2_FP_0.3D_HG_EN12	C2DP7350
AS6930G-733G32Mn	EMEA	Portugal	LX.AUU0X.052	AS6930G-733G32Mn VHP32ATPT1 MC 9MGSHM256COF 2G+1G/320/6L/ CB_n2_FP_0.3D_HG_PT12	C2DP7350
AS6930G-733G32Mn	EMEA	Spain	LX.AUU0X.051	AS6930G-733G32Mn VHP32ATES1 MC 9MGSHM256COF 2G+1G/320/6L/ CB_n2_FP_0.3D_HG_ES22	C2DP7350
AS6930G-733G32Mn	EMEA	Greece	LX.AUU0X.050	AS6930G-733G32Mn VHP32ATGR1 MC 9MGSHM256COF 2G+1G/320/6L/ CB_n2_FP_0.3D_HG_EL32	C2DP7350
AS6930G-733G32Mn	EMEA	Greece	LX.AUU0X.049	AS6930G-733G32Mn VHP32ATGR1 MC 9MGSHM256COF 2G+1G/320/6L/ CB_n2_FP_0.3D_HG_EL22	C2DP7350
AS6930G-733G32Mn	EMEA	Israel	LX.AUU0X.048	AS6930G-733G32Mn VHP32ATIL1 MC 9MGSHM256COF 2G+1G/320/6L/ CB_n2_FP_0.3D_HG_HE11	C2DP7350
AS6930G-733G32Mn	EMEA	Italy	LX.AUU0X.047	AS6930G-733G32Mn VHP32ATIT1 MC 9MGSHM256COF 2G+1G/320/6L/ CB_n2_FP_0.3D_HG_IT12	C2DP7350
AS6930G-733G32Mn	EMEA	Turkey	LX.AUU0X.046	AS6930G-733G32Mn EM VHP32ATTR1 MC 9MGSHM256COF 2G+1G/320/6L/ CB_n2_FP_0.3D_HG_TR32	C2DP7350
AS6930G-733G32Mn	EMEA	Middle East	LX.AUU0X.045	AS6930G-733G32Mn EM VHP32ATME9 MC 9MGSHM256COF 2G+1G/320/6L/ CB_n2_FP_0.3D_HG_FR22	C2DP7350
AS6930G-733G32Mn	EMEA	Middle East	LX.AUU0X.044	AS6930G-733G32Mn EM VHP32ATME2 MC 9MGSHM256COF 2G+1G/320/6L/ CB_n2_FP_0.3D_HG_AR13	C2DP7350
AS6930G-733G32Mn	EMEA	Middle East	LX.AUU0X.043	AS6930G-733G32Mn EM VHP32ATME2 MC 9MGSHM256COF 2G+1G/320/6L/ CB_n2_FP_0.3D_HG_EN15	C2DP7350
AS6930G-733G32Mn	EMEA	Middle East	LX.AUU0X.042	AS6930G-733G32Mn EM VHP32ATME3 MC 9MGSHM256COF 2G+1G/320/6L/ CB_n2_FP_0.3D_HG_FR23	C2DP7350
AS6930G-583G25Mn	EMEA	France	LX.AUU0X.139	AS6930G-583G25Mn VHP32ATFR1 MC 9MGSHM256COF 2G+1G/250/6L/5R/ CB_n2_FP_0.3D_HG_FR23	C2DT5800
AS6930G-733G32Mn	EMEA	Middle East	LX.AUU0X.041	AS6930G-733G32Mn EM VHP32ATME6 MC 9MGSHM256COF 2G+1G/320/6L/ CB_n2_FP_0.3D_HG_EN15	C2DP7350
AS6930G-733G32Mn	EMEA	Middle East	LX.AUU0X.040	AS6930G-733G32Mn EM VHP32ATME2 MC 9MGSHM256COF 2G+1G/320/6L/ CB_n2_FP_0.3D_HG_AR23	C2DP7350
AS6930G-733G32Mn	EMEA	Middle East	LX.AUU0X.039	AS6930G-733G32Mn EM VHP32ATME4 MC 9MGSHM256COF 2G+1G/320/6L/ CB_n2_FP_0.3D_HG_EN11	C2DP7350
AS6930G-733G32Mn	EMEA	Switzerland	LX.AUU0X.038	AS6930G-733G32Mn VHP32ATCH1 MC 9MGSHM256COF 2G+1G/320/6L/ CB_n2_FP_0.3D_HG_IT42	C2DP7350
AS6930G-733G32Mn	EMEA	UK	LX.AUU0X.037	AS6930G-733G32Mn VHP32ATGB1 MC 9MGSHM256COF 2G+1G/320/6L/ CB_n2_FP_0.3D_HG_EN14	C2DP7350
AS6930G-734G32Mn	EMEA	Eastern Europe	LX.AUU0X.138	AS6930G-734G32Mn VHP32ATEU5 MC 9MGSHM256COF 2*2G/320/BT/6L/5R/ CB_n2_FP_0.3D_HG_PL11	C2DP7350

Model	RO	Country	Acer Part No	Description	CPU
AS6930G-734G64Mn	EMEA	Eastern Europe	LX.AUU0X.137	AS6930G-734G64Mn VHP32ATEU5 MC 9MGSHM256COF 2*2G/320+320/BT/6L/5R/CB_n2_FP_0.3D_HG_PL11	C2DP7350
AS6930G-734G32Bn	EMEA	Eastern Europe	LX.AUU0X.136	AS6930G-734G32Bn VHP32ATEU5 MC 9MGSHM256COF 2*2G/320/BT/6L/5R/CB_n2_FP_0.3D_HG_PL11	C2DP7350
AS6930G-583G32Mn	PA	Canada	LX.AUU0X.095	AS6930G-583G32Mn VHP32ATCA2 MC 9MGSHM256COF 2G+1G/320/6L/5R/CB_n2_FP_0.3D_HG_FR35	C2DT5800
AS6930G-583G32Mn	PA	Canada	LX.AUU0X.096	AS6930G-583G32Mn VHP32ATCA2 MC 9MGSHM256COF 2G+1G/320/6L/5R/CB_n2_FP_0.3D_HG_FR33	C2DT5800
AS6930G-583G32Mn	PA	Canada	LX.AUU0X.092	AS6930G-583G32Mn VHP32ATCA2 MC 9MGSHM256COF 2G+1G/320/6L/5R/CB_n2_FP_0.3D_HG_FR32	C2DT5800
AS6930G-583G32Mn	PA	Canada	LX.AUU0X.093	AS6930G-583G32Mn VHP32ATCA2 MC 9MGSHM256COF 2G+1G/320/6L/5R/CB_n2_FP_0.3D_HG_FR31	C2DT5800
AS6930G-583G32Mn	PA	Canada	LX.AUU0X.094	AS6930G-583G32Mn VHP32ATCA2 MC 9MGSHM256COF 2G+1G/320/6L/5R/CB_n2_FP_0.3D_HG_FR34	C2DT5800
AS6930G-583G32Mn	PA	USA	LX.AUU0X.091	AS6930G-583G32Mn VHP32ATUS1 MC 9MGSHM256COF 2G+1G/320/6L/5R/CB_n2_FP_0.3D_HG_EN33	C2DT5800
AS6930G-583G32Mn	PA	USA	LX.AUU0X.090	AS6930G-583G32Mn VHP32ATUS1 MC 9MGSHM256COF 2G+1G/320/6L/5R/CB_n2_FP_0.3D_HG_EN35	C2DT5800
AS6930G-583G32Mn	PA	USA	LX.AUU0X.089	AS6930G-583G32Mn VHP32ATUS1 MC 9MGSHM256COF 2G+1G/320/6L/5R/CB_n2_FP_0.3D_HG_EN32	C2DT5800
AS6930G-583G32Mn	PA	USA	LX.AUU0X.088	AS6930G-583G32Mn VHP32ATUS1 MC 9MGSHM256COF 2G+1G/320/6L/5R/CB_n2_FP_0.3D_HG_EN34	C2DT5800
AS6930G-583G32Mn	PA	ACLA-Portuguese	LX.AUU0X.084	AS6930G-583G32Mn VHP32ATXC2 MC 9MGSHM256COF 2G+1G/320/6L/5R/CB_n2_FP_0.3D_HG_XC22	C2DT5800
AS6930G-583G32Mn	PA	ACLA-Portuguese	LX.AUU0X.085	AS6930G-583G32Mn EM VHP32ATXC2 MC 9MGSHM256COF 2G+1G/320/6L/5R/CB_n2_FP_0.3D_HG_XC21	C2DT5800
AS6930G-583G32Mn	PA	ACLA-Portuguese	LX.AUU0X.086	AS6930G-583G32Mn EM VHP32ATXC1 MC 9MGSHM256COF 2G+1G/320/6L/5R/CB_n2_FP_0.3D_HG_XC22	C2DT5800
AS6930G-583G32Mn	PA	ACLA-Portuguese	LX.AUU0X.087	AS6930G-583G32Mn VHP32ATXC1 MC 9MGSHM256COF 2G+1G/320/6L/5R/CB_n2_FP_0.3D_HG_XC21	C2DT5800
AS6930G-583G32Mn	PA	ACLA-Spanish	LX.AUU0X.081	AS6930G-583G32Mn VHP32ATEA3 MC 9MGSHM256COF 2G+1G/320/6L/5R/CB_n2_FP_0.3D_HG_ES21	C2DT5800
AS6930G-583G32Mn	PA	ACLA-Spanish	LX.AUU0X.082	AS6930G-583G32Mn EM VHP32ATEA3 MC 9MGSHM256COF 2G+1G/320/6L/5R/CB_n2_FP_0.3D_HG_ES22	C2DT5800
AS6930G-583G32Mn	PA	ACLA-Spanish	LX.AUU0X.083	AS6930G-583G32Mn EM VHP32ATEA1 MC 9MGSHM256COF 2G+1G/320/6L/5R/CB_n2_FP_0.3D_HG_ES22	C2DT5800
AS6930G-583G32Mn	PA	ACLA-Spanish	LX.AUU0X.080	AS6930G-583G32Mn VHP32ATEA1 MC 9MGSHM256COF 2G+1G/320/6L/5R/CB_n2_FP_0.3D_HG_ES21	C2DT5800

Model	RO	Country	Acer Part No	Description	CPU
AS6930G-583G32Mn	AAP	Australia/New Zealand	LX.AUU0X.079	AS6930G-583G32Mn VHP32ATAU1 MC 9MGSHM256COF 2G+1G/320/6L/5R/CB_n2_FP_0.3D_HG_EN12	C2DT5800
AS6930G-583G32Mn	AAP	Japan	LX.AUU0X.078	AS6930G-583G32Mn VHP32ATJP1 MC 9MGSHM256COF 2G+1G/320/6L/5R/CB_n2_FP_0.3D_HG_JA11	C2DT5800
AS6930G-733G32Mn	AAP	Australia/New Zealand	LX.AUU0X.144	AS6930G-733G32Mn VHP32ATAU1 MC 9MGSHM256COF 2G+1G/320/BT/6L/5R/CB_n2_FP_0.3D_HG_EN12	C2DP7350
AS6930G-733G32Mn	AAP	Australia/New Zealand	LX.AUU0X.145	AS6930G-733G32Mn VHP32ATAU1 MC 9MGSHM256COF 2G+1G/320/BT/8L/5R/CB_n2_FP_0.3D_HG_EN12	C2DP7350
AS6930G-583G32Mn	AAP	Singapore	LX.AUU0X.149	AS6930G-583G32Mn VHP32ATSG1 MC 9MGSHM256COF 2G+1G/320/6L/5R/CB_n2_FP_0.3D_HG_ZH31	C2DT5800
AS6930G-593G32Mn	AAP	Singapore	LX.AUU0X.148	AS6930G-593G32Mn VHP32ATSG1 MC 9MGSHM256COF 2G+1G/320/6L/5R/CB_n2_FP_0.3D_HG_ZH31	C2DT5900
AS6930G-733G32Mn	EMEA	Czech	LX.AUU0X.146	AS6930G-733G32Mn VHP32ATCZ2 MC 9MGSHM256COF 2G+1G/320/BT/6L/5R/CB_n2_FP_0.3D_HG_SK11	C2DP7350
AS6930G-954G50B	WW	WW	S2.AUU0X.001	AS6930G-954G50BVHP32AWW1 MC 9MGSHM256COF 2*2G/250+250/BT/8L/CB_FP_0.3D_HG_EN11	C2DP9500
AS6930G-944G32Mn	AAP	Singapore	LX.AUU0X.140	AS6930G-944G32Mn VHP32ATSG1 MC 9MGSHM256COF 2*2G/320/6L/5R/CB_n3_FP_0.3D_HG_ZH31	C2DT9400
AS6930G-733G32Mn	AAP	Singapore	LX.AUU0X.150	AS6930G-733G32Mn VHP32ATSG1 MC 9MGSHM256COF 2G+1G/320/6L/5R/CB_n2_FP_0.3D_HG_ZH31	C2DP7350
AS6930G-733G25Mn	EMEA	South Africa	LX.AUU0X.135	AS6930G-733G25Mn EM VHP32ATZA2 MC 9MGSHM256COF 2G+1G/250/6L/5R/CB_n2_FP_0.3D_HG_EN16	C2DP7350
AS6930G-733G25Mn	EMEA	South Africa	LX.AUU0X.134	AS6930G-733G25Mn EM VHP32ATZA1 MC 9MGSHM256COF 2G+1G/250/6L/5R/CB_n2_FP_0.3D_HG_FR23	C2DP7350
AS6930G-733G25Mn	EMEA	France	LX.AUU0X.133	AS6930G-733G25Mn VHP32ATFR1 MC 9MGSHM256COF 2G+1G/250/6L/5R/CB_n2_FP_0.3D_HG_FR23	C2DP7350
AS6930G-733G25Mn	EMEA	Germany	LX.AUU0X.132	AS6930G-733G25Mn VHP32ATDE1 MC 9MGSHM256COF 2G+1G/250/6L/5R/CB_n2_FP_0.3D_HG_DE13	C2DP7350
AS6930G-733G25Mn	EMEA	Belgium	LX.AUU0X.131	AS6930G-733G25Mn VHP32ATBE1 MC 9MGSHM256COF 2G+1G/250/6L/5R/CB_n2_FP_0.3D_HG_NL13	C2DP7350
AS6930G-733G25Mn	EMEA	Holland	LX.AUU0X.130	AS6930G-733G25Mn VHP32ATNL1 MC 9MGSHM256COF 2G+1G/250/6L/5R/CB_n2_FP_0.3D_HG_NL12	C2DP7350
AS6930G-733G25Mn	EMEA	Luxembourg	LX.AUU0X.129	AS6930G-733G25Mn VHP32ATLU1 MC 9MGSHM256COF 2G+1G/250/6L/5R/CB_n2_FP_0.3D_HG_IT42	C2DP7350
AS6930G-733G25Mn	EMEA	Norway	LX.AUU0X.128	AS6930G-733G25Mn VHP32ATNO1 MC 9MGSHM256COF 2G+1G/250/6L/5R/CB_n2_FP_0.3D_HG_NO12	C2DP7350
AS6930G-733G25Mi	EMEA	Russia	LX.AUU0X.127	AS6930G-733G25Mi VHP32ATRU1 MC 9MGSHM256COF 2G+1G/250/6L/5R/CB_abg_FP_0.3D_HG_RU11	C2DP7350

Model	RO	Country	Acer Part No	Description	CPU
AS6930G-733G25Mn	EMEA	Denmark	LX.AUU0X.126	AS6930G-733G25Mn VHP32ATDK1 MC 9MGSHM256COF 2G+1G/250/6L/5R/ CB_n2_FP_0.3D_HG_NO13	C2DP7350
AS6930G-734G32Bn	CHINA	China	LX.AUU0X.077	AS6930G-734G32Bn VHP32ATCN1 MC 9MGSHM256COF 2*2G/320/6L/5R/ CB_n2_FP_0.3D_HG_SC11	C2DP7350
AS6930G-734G32Bn	CHINA	Hong Kong	LX.AUU0X.076	AS6930G-734G32Bn VHP32ATHK2 MC 9MGSHM256COF 2*2G/320/6L/5R/ CB_n2_FP_0.3D_HG_ZH31	C2DP7350
AS6930G-733G25Mn	EMEA	Sweden/ Finland	LX.AUU0X.125	AS6930G-733G25Mn VHP32ATSE1 MC 9MGSHM256COF 2G+1G/250/6L/5R/ CB_n2_FP_0.3D_HG_FI12	C2DP7350
AS6930G-733G25Mn	EMEA	Czech	LX.AUU0X.124	AS6930G-733G25Mn VHP32ATCZ2 MC 9MGSHM256COF 2G+1G/250/6L/5R/ CB_n2_FP_0.3D_HG_SK11	C2DP7350
AS6930G-733G25Mn	EMEA	Eastern Europe	LX.AUU0X.123	AS6930G-733G25Mn VHP32ATEU7 MC 9MGSHM256COF 2G+1G/250/6L/5R/ CB_n2_FP_0.3D_HG_ENG1	C2DP7350
AS6930G-733G25Mn	EMEA	Eastern Europe	LX.AUU0X.122	AS6930G-733G25Mn VHP32ATEU6 MC 9MGSHM256COF 2G+1G/250/6L/5R/ CB_n2_FP_0.3D_HG_CS21	C2DP7350
AS6930G-733G25Mn	EMEA	Eastern Europe	LX.AUU0X.121	AS6930G-733G25Mn VHP32ATEU3 MC 9MGSHM256COF 2G+1G/250/6L/5R/ CB_n2_FP_0.3D_HG_RU11	C2DP7350
AS6930G-733G25Mn	EMEA	Eastern Europe	LX.AUU0X.120	AS6930G-733G25Mn VHP32ATEU1 MC 9MGSHM256COF 2G+1G/250/6L/5R/ CB_n2_FP_0.3D_HG_CS21	C2DP7350
AS6930G-733G25Mn	EMEA	Eastern Europe	LX.AUU0X.119	AS6930G-733G25Mn VHP32ATEU4 MC 9MGSHM256COF 2G+1G/250/6L/5R/ CB_n2_FP_0.3D_HG_FI12	C2DP7350
AS6930G-733G25Mn	EMEA	Eastern Europe	LX.AUU0X.118	AS6930G-733G25Mn VHP32ATEU3 MC 9MGSHM256COF 2G+1G/250/6L/5R/ CB_n2_FP_0.3D_HG_RU21	C2DP7350
AS6930G-734G32Bn	EMEA	Norway	LX.AUU0X.074	AS6930G-734G32Bn VHP32ATNO1 MC 9MGSHM256COF 2*2G/320/6L/ CB_n2_FP_0.3D_HG_NO12	C2DP7350
AS6930G-733G25Mn	EMEA	Eastern Europe	LX.AUU0X.117	AS6930G-733G25Mn VHP32ATEU5 MC 9MGSHM256COF 2G+1G/250/6L/5R/ CB_n2_FP_0.3D_HG_PL11	C2DP7350
AS6930G-733G25Mn	EMEA	Hungary	LX.AUU0X.116	AS6930G-733G25Mn VHP32ATHU1 MC 9MGSHM256COF 2G+1G/250/6L/5R/ CB_n2_FP_0.3D_HG_HU11	C2DP7350
AS6930G-733G25Mn	EMEA	Slovenia/ Croatia	LX.AUU0X.115	AS6930G-733G25Mn VHP32ATSI1 MC 9MGSHM256COF 2G+1G/250/6L/5R/ CB_n2_FP_0.3D_HG_EN12	C2DP7350
AS6930G-733G25Mn	EMEA	Portugal	LX.AUU0X.114	AS6930G-733G25Mn VHP32ATPT1 MC 9MGSHM256COF 2G+1G/250/6L/5R/ CB_n2_FP_0.3D_HG_PT12	C2DP7350
AS6930G-733G25Mn	EMEA	Spain	LX.AUU0X.113	AS6930G-733G25Mn VHP32ATES1 MC 9MGSHM256COF 2G+1G/250/6L/5R/ CB_n2_FP_0.3D_HG_ES22	C2DP7350
AS6930G-733G25Mn	EMEA	Greece	LX.AUU0X.112	AS6930G-733G25Mn VHP32ATGR1 MC 9MGSHM256COF 2G+1G/250/6L/5R/ CB_n2_FP_0.3D_HG_EL32	C2DP7350
AS6930G-733G25Mn	EMEA	Israel	LX.AUU0X.111	AS6930G-733G25Mn VHP32ATIL1 MC 9MGSHM256COF 2G+1G/250/6L/5R/ CB_n2_FP_0.3D_HG_HE11	C2DP7350

Model	RO	Country	Acer Part No	Description	CPU
AS6930G-733G25Mn	EMEA	Italy	LX.AUU0X.110	AS6930G-733G25Mn VHP32ATIT1 MC 9MGSHM256COF 2G+1G/250/6L/5R/CB_n2_FP_0.3D_HG_IT12	C2DP7350
AS6930G-733G25Mn	EMEA	Turkey	LX.AUU0X.109	AS6930G-733G25Mn EM VHP32ATTR1 MC 9MGSHM256COF 2G+1G/250/6L/5R/CB_n2_FP_0.3D_HG_TR32	C2DP7350
AS6930G-733G25Mn	EMEA	Middle East	LX.AUU0X.108	AS6930G-733G25Mn EM VHP32ATME9 MC 9MGSHM256COF 2G+1G/250/6L/5R/CB_n2_FP_0.3D_HG_FR22	C2DP7350
AS6930G-733G25Mn	EMEA	Middle East	LX.AUU0X.107	AS6930G-733G25Mn EM VHP32ATME2 MC 9MGSHM256COF 2G+1G/250/6L/5R/CB_n2_FP_0.3D_HG_AR13	C2DP7350
AS6930G-733G25Mn	EMEA	Middle East	LX.AUU0X.106	AS6930G-733G25Mn EM VHP32ATME2 MC 9MGSHM256COF 2G+1G/250/6L/5R/CB_n2_FP_0.3D_HG_EN15	C2DP7350
AS6930G-733G25Mn	EMEA	Middle East	LX.AUU0X.105	AS6930G-733G25Mn EM VHP32ATME3 MC 9MGSHM256COF 2G+1G/250/6L/5R/CB_n2_FP_0.3D_HG_FR23	C2DP7350
AS6930G-733G25Mn	EMEA	Greece	LX.AUU0X.104	AS6930G-733G25Mn VHP32ATGR1 MC 9MGSHM256COF 2G+1G/250/6L/5R/CB_n2_FP_0.3D_HG_EL22	C2DP7350
AS6930G-733G25Mn	EMEA	Switzerland	LX.AUU0X.103	AS6930G-733G25Mn VHP32ATCH1 MC 9MGSHM256COF 2G+1G/250/6L/5R/CB_n2_FP_0.3D_HG_IT42	C2DP7350
AS6930G-733G25Mn	EMEA	UK	LX.AUU0X.102	AS6930G-733G25Mn VHP32ATGB1 MC 9MGSHM256COF 2G+1G/250/6L/5R/CB_n2_FP_0.3D_HG_EN14	C2DP7350
AS6930G-733G25Mn	EMEA	Middle East	LX.AUU0X.101	AS6930G-733G25Mn EM VHP32ATME6 MC 9MGSHM256COF 2G+1G/250/6L/5R/CB_n2_FP_0.3D_HG_EN15	C2DP7350
AS6930G-733G25Mn	EMEA	Middle East	LX.AUU0X.099	AS6930G-733G25Mn EM VHP32ATME2 MC 9MGSHM256COF 2G+1G/250/6L/5R/CB_n2_FP_0.3D_HG_AR23	C2DP7350
AS6930G-733G25Mn	EMEA	Middle East	LX.AUU0X.098	AS6930G-733G25Mn EM VHP32ATME4 MC 9MGSHM256COF 2G+1G/250/6L/5R/CB_n2_FP_0.3D_HG_EN11	C2DP7350
AS6930G-844G64Mn	EMEA	South Africa	LX.AUU0X.097	AS6930G-844G64Mn EM VHP32ATZA2 MC 9MGSHM256COF 2*2G/320+320/6L/5R/CB_n2_FP_0.3D_HG_EN16	C2DP8400
AS6930G-734G32Bn	TWN	GCTWN	LX.AUU0X.075	AS6930G-734G32Bn VHP32ATTW1 MC 9MGSHM256COF 2*2G/320/6L/5R/CB_n2_FP_0.3D_HG_TC11	C2DP7350
AS6930G-842G25Mn	CHINA	China	LX.AUU0X.192	AS6930G-842G25Mn VHP32ATCN1 MC 9MGSHM256COF 2*1G/250/6L/5R/CB_n2_FP_0.3D_HG_SC11	C2DP8400
AS6930G-732G16Mn	CHINA	China	LX.AUU0X.191	AS6930G-732G16Mn VHP32ATCN1 MC 9MGSHM256COF 2*1G/160/6L/5R/CB_n2_FP_0.3D_HG_SC11	C2DP7350
AS6930G-732G16Bn	CHINA	China	LX.AUU0X.188	AS6930G-732G16Bn VHP32ATCN1 MC 9MGSHM256COF 2*1G/160/6L/5R/CB_n2_FP_0.3D_HG_SC11	C2DP7350
AS6930G-733G32Mn	AAP	Singapore	LX.AUU0X.190	AS6930G-733G32Mn VHP32ATSG1 MC 9MGSHM256COF 2G+1G/320/BT/6L/5R/CB_n3_FP_0.3D_HG_ZH31	C2DP7350
AS6930G-732G32Mn	AAP	Singapore	LX.AUU0X.189	AS6930G-732G32Mn VHP32ATSG1 MC 9MGSHM256COF 1*2G/320/BT/6L/5R/CB_n3_FP_0.3D_HG_ZH31	C2DP7350

Model	RO	Country	Acer Part No	Description	CPU
AS6930G-842G25Bn	CHINA	China	LX.AUUOX.187	AS6930G-842G25Bn VHP32ATCN1 MC 9PGSHM256COF 2*1G/250/6L/5R/ CB_n2_FP_0.3D_HG_SC11	C2DP8400
AS6930G-863G32Mn	AAP	Vietnam	LX.AVN0X.022	AS6930G-863G32Mn EM VHP32ATVN1 MC 9PGSHM512COF 2G+1G/320/BT/ 8L/5R/CBU_n3_FP_0.3D_HG_EN13	C2DP8600
AS6930G-843G25Mn	AAP	Japan	LX.AVN0X.018	AS6930G-843G25Mn VHP32AJP1 MC 9PGSHM512COF 2G+1G/250/BT/6L/5R/ CB_n2_FP_0.3D_HG_JA12	C2DP8400
AS6930G-864G32Mn	AAP	Japan	LX.AVN0X.021	AS6930G-864G32Mn VHP32AJP1 MC 9PGSHM512COF 2*2G/320/BT/8L/5R/ CB_n2_FP_0.3D_HG_JA12	C2DP8600
AS6930G-584G32Mn	EMEA	France	LX.AVN0X.017	AS6930G-584G32Mn VHP32ATFR1 MC 9PGSHM512COF 2*2G/320/6L/5R/ CB_n2_FP_0.3D_HG_FR23	C2DT5800
AS6930G-864G32Mn	AAP	Australia/New Zealand	LX.AVN0X.020	AS6930G-864G32Mn VHP32ATAU1 MC 9PGSHM512COF 2*2G/320/BT/8L/5R/ CB_n2_FP_0.3D_HG_EN12	C2DP8600
AS6930G-864G32Mn	AAP	Australia/New Zealand	LX.AVN0X.019	AS6930G-864G32Mn VHP32ATAU1 MC 9PGSHM512COF 2*2G/320/BT/6L/5R/ CB_n2_FP_0.3D_HG_EN12	C2DP8600
AS6930G-733G32Mn	AAP	Singapore	LX.AVN0X.023	AS6930G-733G32Mn VHP32ATSG1 MC 9PGSHM512COF 2G+1G/320/BT/6L/5R/ CB_n2_FP_0.3D_HG_ZH31	C2DP7350
AS6930G-734G32Mn	PA	Canada	LX.AVN0X.014	AS6930G-734G32Mn VHP32ATCA2 MC 9PGSHM512COF 2*2G/320/BT/6L/5R/ CB_n2_FP_0.3D_HG_FR35	C2DP7350
AS6930G-734G32Mn	PA	Canada	LX.AVN0X.013	AS6930G-734G32Mn VHP32ATCA2 MC 9PGSHM512COF 2*2G/320/BT/6L/5R/ CB_n2_FP_0.3D_HG_FR33	C2DP7350
AS6930G-734G32Mn	PA	Canada	LX.AVN0X.012	AS6930G-734G32Mn VHP32ATCA2 MC 9PGSHM512COF 2*2G/320/BT/6L/5R/ CB_n2_FP_0.3D_HG_FR32	C2DP7350
AS6930G-734G32Mn	PA	Canada	LX.AVN0X.011	AS6930G-734G32Mn VHP32ATCA2 MC 9PGSHM512COF 2*2G/320/BT/6L/5R/ CB_n2_FP_0.3D_HG_FR31	C2DP7350
AS6930G-734G32Mn	PA	Canada	LX.AVN0X.007	AS6930G-734G32Mn VHP32ATCA2 MC 9PGSHM512COF 2*2G/320/BT/6L/5R/ CB_n2_FP_0.3D_HG_FR34	C2DP7350
AS6930G-734G32Mn	PA	USA	LX.AVN0X.008	AS6930G-734G32Mn VHP32ATUS1 MC 9PGSHM512COF 2*2G/320/BT/6L/5R/ CB_n2_FP_0.3D_HG_EN33	C2DP7350
AS6930G-734G32Mn	PA	USA	LX.AVN0X.009	AS6930G-734G32Mn VHP32ATUS1 MC 9PGSHM512COF 2*2G/320/BT/6L/5R/ CB_n2_FP_0.3D_HG_EN35	C2DP7350
AS6930G-734G32Mn	PA	USA	LX.AVN0X.010	AS6930G-734G32Mn VHP32ATUS1 MC 9PGSHM512COF 2*2G/320/BT/6L/5R/ CB_n2_FP_0.3D_HG_EN32	C2DP7350
AS6930G-734G32Mn	PA	USA	LX.AVN0X.004	AS6930G-734G32Mn VHP32ATUS1 MC 9PGSHM512COF 2*2G/320/BT/6L/5R/ CB_n2_FP_0.3D_HG_EN34	C2DP7350
AS6930G-734G32Mn	PA	ACLA-Portuguese	LX.AVN0X.005	AS6930G-734G32Mn VHP32ATXC2 MC 9PGSHM512COF 2*2G/320/BT/6L/5R/ CB_n2_FP_0.3D_HG_XC22	C2DP7350
AS6930G-734G32Mn	PA	ACLA-Portuguese	LX.AVN0X.006	AS6930G-734G32Mn EM VHP32ATXC2 MC 9PGSHM512COF 2*2G/320/BT/6L/ 5R/CB_n2_FP_0.3D_HG_XC21	C2DP7350

Model	RO	Country	Acer Part No	Description	CPU
AS6930G-734G32Mn	PA	ACLA-Portuguese	LX.AVN0X.003	AS6930G-734G32Mn EM VHP32ATXC1 MC 9PGSHM512COF 2*2G/320/BT/6L/5R/CB_n2_FP_0.3D_HG_XC22	C2DP7350
AS6930G-734G32Mn	PA	ACLA-Spanish	LX.AVN0X.002	AS6930G-734G32Mn EM VHP32ATEA3 MC 9PGSHM512COF 2*2G/320/BT/6L/5R/CB_n2_FP_0.3D_HG_ES22	C2DP7350
AS6930G-734G32Mn	PA	ACLA-Spanish	LX.AVN0X.001	AS6930G-734G32Mn EM VHP32ATEA1 MC 9PGSHM512COF 2*2G/320/BT/6L/5R/CB_n2_FP_0.3D_HG_ES22	C2DP7350
AS6930G-734G32Mn	EMEA	Greece	LX.AVN0X.016	AS6930G-734G32Mn VHP32ATGR1 MC 9PGSHM512COF 2*2G/320/BT/6L/5R/CB_n2_FP_0.3D_HG_EL32	C2DP7350
AS6930G-734G32Mn	EMEA	Italy	LX.AVN0X.015	AS6930G-734G32Mn VHP32ATIT1 MC 9PGSHM512COF 2*2G/320/BT/6L/5R/CB_n2_FP_0.3D_HG_IT12	C2DP7350
AS6930G-943G64Mn	AAP	Australia/New Zealand	LX.AVN0X.028	AS6930G-943G64Mn VHP32ATAU1 MC 9PGSHM512COF 2G+1G/320+320/BT/6L/5R/CB_n2_FP_0.3D_HG_EN12	C2DT9400
AS6930G-943G50Mn	AAP	Australia/New Zealand	LX.AVN0X.027	AS6930G-943G50Mn VHP32ATAU1 MC 9PGSHM512COF 2G+1G/250+250/BT/6L/5R/CB_n2_FP_0.3D_HG_EN12	C2DT9400
AS6930G-583G32Mn	AAP	Singapore	LX.AVN0X.026	AS6930G-583G32Mn VHP32ATSG1 MC 9PGSHM512COF 2G+1G/320/BT/6L/5R/CB_n2_FP_0.3D_HG_ZH31	C2DT5800
AS6930G-593G32Mn	AAP	Singapore	LX.AVN0X.025	AS6930G-593G32Mn VHP32ATSG1 MC 9PGSHM512COF 2G+1G/320/BT/6L/5R/CB_n2_FP_0.3D_HG_ZH31	C2DT5900
AS6930G-734G32Mn	EMEA	France	LX.AVN0X.024	AS6930G-734G32Mn VHP32ATFR1 MC 9PGSHM512COF 2*2G/320/6L/5R/CB_n2_FP_0.3D_HG_FR23	C2DP7350
AS6930G-733G32Mn	AAP	Singapore	LX.AVN0X.029	AS6930G-733G32Mn VHP32ATSG1 MC 9PGSHM512COF 2G+1G/320/BT/6L/5R/CB_n3_FP_0.3D_HG_ZH31	C2DP7350
AS6930G-732G32Mn	AAP	Singapore	LX.AVN0X.030	AS6930G-732G32Mn VHP32ATSG1 MC 9PGSHM512COF 1*2G/320/BT/6L/5R/CB_n3_FP_0.3D_HG_ZH31	C2DP7350
AS6930G-844G32Bn	EMEA	France	LX.AV90X.002	AS6930G-844G32Bn VHP32ATFR1 MC 9PGE2HM512TCOF 2*2G/320/BT/6L/5R/CB_n2_DVBT U/VHF_FP_0.3D_HG_FR23	C2DP8400
AS6930G-944G32Bn	EMEA	France	LX.AV90X.001	AS6930G-944G32Bn VHP32ATFR1 MC 9PGE2HM512TCOF 2*2G/320/BT/6L/5R/CBU_n2_DVBT U/VHF_FP_0.3D_HG_FR23	C2DT9400

Model	LCD	VGA Chip	VRAM 1	Mem 1	Mem 2	HDD 1 (GB)	HDD 2 (GB)
AS6930-732G25Mn	N16WXGAG8	UMA	N	SO1GBII6	SO1GBII6	N250GB 5.4KS	N
AS6930-843G25Mn	N16WXGAG8	UMA	N	SO2GBII6	SO1GBII6	N250GB 5.4KS	N
AS6930-583G32Mn	N16WXGAG8	UMA	N	SO2GBII6	SO1GBII6	N320GB 5.4KS	N
AS6930-583G32Mn	N16WXGAG8	UMA	N	SO2GBII6	SO1GBII6	N320GB 5.4KS	N
AS6930-583G32Mn	N16WXGAG8	UMA	N	SO2GBII6	SO1GBII6	N320GB 5.4KS	N

Model	LCD	VGA Chip	VRAM 1	Mem 1	Mem 2	HDD 1 (GB)	HDD 2 (GB)
AS6930-583G32Mn	N16WXGAG8	UMA	N	SO2GBII6	SO1GBII6	N320GB 5.4KS	N
AS6930-583G32Mn	N16WXGAG8	UMA	N	SO2GBII6	SO1GBII6	N320GB 5.4KS	N
AS6930-583G32Mn	N16WXGAG8	UMA	N	SO2GBII6	SO1GBII6	N320GB 5.4KS	N
AS6930-583G32Mn	N16WXGAG8	UMA	N	SO2GBII6	SO1GBII6	N320GB 5.4KS	N
AS6930-583G32Mn	N16WXGAG8	UMA	N	SO2GBII6	SO1GBII6	N320GB 5.4KS	N
AS6930-583G32Mn	N16WXGAG8	UMA	N	SO2GBII6	SO1GBII6	N320GB 5.4KS	N
AS6930-583G32Mn	N16WXGAG8	UMA	N	SO2GBII6	SO1GBII6	N320GB 5.4KS	N
AS6930-583G32Mn	N16WXGAG8	UMA	N	SO2GBII6	SO1GBII6	N320GB 5.4KS	N
AS6930-583G32Mn	N16WXGAG8	UMA	N	SO2GBII6	SO1GBII6	N320GB 5.4KS	N
AS6930-583G32Mn	N16WXGAG8	UMA	N	SO2GBII6	SO1GBII6	N320GB 5.4KS	N
AS6930-583G32Mn	N16WXGAG8	UMA	N	SO2GBII6	SO1GBII6	N320GB 5.4KS	N
AS6930-583G32Mn	N16WXGAG8	UMA	N	SO2GBII6	SO1GBII6	N320GB 5.4KS	N
AS6930-583G32Mn	N16WXGAG8	UMA	N	SO2GBII6	SO1GBII6	N320GB 5.4KS	N
AS6930-583G32Mn	N16WXGAG8	UMA	N	SO2GBII6	SO1GBII6	N320GB 5.4KS	N
AS6930-583G32Mn	N16WXGAG8	UMA	N	SO2GBII6	SO1GBII6	N320GB 5.4KS	N
AS6930-583G32Mn	N16WXGAG8	UMA	N	SO2GBII6	SO1GBII6	N320GB 5.4KS	N
AS6930-583G32Mn	N16WXGAG8	UMA	N	SO2GBII6	SO1GBII6	N320GB 5.4KS	N
AS6930-583G32Mn	N16WXGAG8	UMA	N	SO2GBII6	SO1GBII6	N320GB 5.4KS	N
AS6930-583G32Mn	N16WXGAG8	UMA	N	SO2GBII6	SO1GBII6	N320GB 5.4KS	N
AS6930-942G25Mn	N16WXGAG8	UMA	N	SO2GBII6	N	N250GB 5.4KS	N
AS6930-942G25Mn	N16WXGAG8	UMA	N	SO2GBII6	N	N250GB 5.4KS	N
AS6930-942G25Mn	N16WXGAG8	UMA	N	SO2GBII6	N	N250GB 5.4KS	N
AS6930-844G16Mn	N16WXGAG8	UMA	N	SO2GBII6	SO2GBII6	N160GB 5.4KS	N
AS6930-842G12Mn	N16WXGAG8	UMA	N	SO1GBII6	SO1GBII6	N120GB 5.4KS	N
AS6930-584G32Mn	N16WXGAG8	UMA	N	SO2GBII6	SO2GBII6	N320GB 5.4KS	N
AS6930-584G32Mn	N16WXGAG8	UMA	N	SO2GBII6	SO2GBII6	N320GB 5.4KS	N
AS6930-584G25Mn	N16WXGAG8	UMA	N	SO2GBII6	SO2GBII6	N250GB 5.4KS	N
AS6930-584G25Mn	N16WXGAG8	UMA	N	SO2GBII6	SO2GBII6	N250GB 5.4KS	N
AS6930-732G16Mn	N16WXGAG8	UMA	N	SO2GBII6	N	N160GB 5.4KS	N

Model	LCD	VGA Chip	VRAM 1	Mem 1	Mem 2	HDD 1 (GB)	HDD 2 (GB)
AS6930G-733G25Mn	N16WXGAG8	9PGE2HM	512M-GD2	SO2GBII6	SO1GBII6	N250GB 5.4KS	N
AS6930G-733G25Mn	N16WXGAG8	9PGE2HM	512M-GD2	SO2GBII6	SO1GBII6	N250GB 5.4KS	N
AS6930G-733G25Mn	N16WXGAG8	9PGE2HM	512M-GD2	SO2GBII6	SO1GBII6	N250GB 5.4KS	N
AS6930G-733G25Mn	N16WXGAG8	9PGE2HM	512M-GD2	SO2GBII6	SO1GBII6	N250GB 5.4KS	N
AS6930G-733G25Mn	N16WXGAG8	9PGE2HM	512M-GD2	SO2GBII6	SO1GBII6	N250GB 5.4KS	N
AS6930G-733G25Mn	N16WXGAG8	9PGE2HM	512M-GD2	SO2GBII6	SO1GBII6	N250GB 5.4KS	N
AS6930G-733G25Mn	N16WXGAG8	9PGE2HM	512M-GD2	SO2GBII6	SO1GBII6	N250GB 5.4KS	N
AS6930G-733G25Mn	N16WXGAG8	9PGE2HM	512M-GD2	SO2GBII6	SO1GBII6	N250GB 5.4KS	N
AS6930G-733G32Mn	N16WUXGAG8	9PGE2HM	512M-GD2	SO2GBII6	SO1GBII6	N320GB 5.4KS	N
AS6930G-583G32Mn	N16WUXGAG8	9PGE2HM	512M-GD2	SO2GBII6	SO1GBII6	N320GB 5.4KS	N
AS6930G-593G32Mn	N16WUXGAG8	9PGE2HM	512M-GD2	SO2GBII6	SO1GBII6	N320GB 5.4KS	N
AS6930G-734G32Bn	N16WXGAG8	9PGE2HM	512M-GD2	SO2GBII6	SO2GBII6	N320GB 5.4KS	N
AS6930G-734G32Mn	N16WXGAG8	9PGE2HM	512M-GD2	SO2GBII6	SO2GBII6	N320GB 5.4KS	N
AS6930G-844G64Mn	N16WXGAG8	9PGE2HM	512M-GD2	SO2GBII6	SO2GBII6	N320GB 5.4KS	N320GB 5.4KS
AS6930G-844G64Mn	N16WXGAG8	9PGE2HM	512M-GD2	SO2GBII6	SO2GBII6	N320GB 5.4KS	N320GB 5.4KS
AS6930G-844G64Mn	N16WXGAG8	9PGE2HM	512M-GD2	SO2GBII6	SO2GBII6	N320GB 5.4KS	N320GB 5.4KS
AS6930G-844G64Mn	N16WXGAG8	9PGE2HM	512M-GD2	SO2GBII6	SO2GBII6	N320GB 5.4KS	N320GB 5.4KS
AS6930G-844G64Mn	N16WXGAG8	9PGE2HM	512M-GD2	SO2GBII6	SO2GBII6	N320GB 5.4KS	N320GB 5.4KS
AS6930G-844G64Mn	N16WXGAG8	9PGE2HM	512M-GD2	SO2GBII6	SO2GBII6	N320GB 5.4KS	N320GB 5.4KS
AS6930G-844G64Mn	N16WXGAG8	9PGE2HM	512M-GD2	SO2GBII6	SO2GBII6	N320GB 5.4KS	N320GB 5.4KS
AS6930G-844G64Mn	N16WXGAG8	9PGE2HM	512M-GD2	SO2GBII6	SO2GBII6	N320GB 5.4KS	N320GB 5.4KS
AS6930G-844G64Mn	N16WXGAG8	9PGE2HM	512M-GD2	SO2GBII6	SO2GBII6	N320GB 5.4KS	N320GB 5.4KS
AS6930G-844G64Mi	N16WXGAG8	9PGE2HM	512M-GD2	SO2GBII6	SO2GBII6	N320GB 5.4KS	N320GB 5.4KS
AS6930G-844G64Mn	N16WXGAG8	9PGE2HM	512M-GD2	SO2GBII6	SO2GBII6	N320GB 5.4KS	N320GB 5.4KS
AS6930G-844G64Mn	N16WXGAG8	9PGE2HM	512M-GD2	SO2GBII6	SO2GBII6	N320GB 5.4KS	N320GB 5.4KS
AS6930G-844G64Mn	N16WXGAG8	9PGE2HM	512M-GD2	SO2GBII6	SO2GBII6	N320GB 5.4KS	N320GB 5.4KS

Model	LCD	VGA Chip	VRAM 1	Mem 1	Mem 2	HDD 1 (GB)	HDD 2 (GB)
AS6930G-733G32Bn	N16WXGAG8	9MGSHM	256M-GD2	SO2GBII6	SO1GBII6	N320GB 5.4KS	N
AS6930G-733G32Bn	N16WXGAG8	9MGSHM	256M-GD2	SO2GBII6	SO1GBII6	N320GB 5.4KS	N
AS6930G-733G32Bn	N16WXGAG8	9MGSHM	256M-GD2	SO2GBII6	SO1GBII6	N320GB 5.4KS	N
AS6930G-733G32Bn	N16WXGAG8	9MGSHM	256M-GD2	SO2GBII6	SO1GBII6	N320GB 5.4KS	N
AS6930G-733G32Bn	N16WXGAG8	9MGSHM	256M-GD2	SO2GBII6	SO1GBII6	N320GB 5.4KS	N
AS6930G-733G32Bn	N16WXGAG8	9MGSHM	256M-GD2	SO2GBII6	SO1GBII6	N320GB 5.4KS	N
AS6930G-733G32Bn	N16WXGAG8	9MGSHM	256M-GD2	SO2GBII6	SO1GBII6	N320GB 5.4KS	N
AS6930G-733G32Bn	N16WXGAG8	9MGSHM	256M-GD2	SO2GBII6	SO1GBII6	N320GB 5.4KS	N
AS6930G-733G32Bn	N16WXGAG8	9MGSHM	256M-GD2	SO2GBII6	SO1GBII6	N320GB 5.4KS	N
AS6930G-733G32Bn	N16WXGAG8	9MGSHM	256M-GD2	SO2GBII6	SO1GBII6	N320GB 5.4KS	N
AS6930G-733G32Bn	N16WXGAG8	9MGSHM	256M-GD2	SO2GBII6	SO1GBII6	N320GB 5.4KS	N
AS6930G-733G32Bn	N16WXGAG8	9MGSHM	256M-GD2	SO2GBII6	SO1GBII6	N320GB 5.4KS	N
AS6930G-733G32Bn	N16WXGAG8	9MGSHM	256M-GD2	SO2GBII6	SO1GBII6	N320GB 5.4KS	N
AS6930G-733G32Mn	N16WXGAG8	9MGSHM	256M-GD2	SO2GBII6	SO1GBII6	N320GB 5.4KS	N
AS6930G-843G32Mn	N16WXGAG8	9MGSHM	256M-GD2	SO2GBII6	SO1GBII6	N320GB 5.4KS	N
AS6930G-863G32Mn	N16WXGAG8	9MGSHM	256M-GD2	SO2GBII6	SO1GBII6	N320GB 5.4KS	N
AS6930G-583G25Mn	N16WXGAG8	9MGSHM	256M-GD2	SO2GBII6	SO1GBII6	N250GB 5.4KS	N
AS6930G-583G25Mn	N16WXGAG8	9MGSHM	256M-GD2	SO2GBII6	SO1GBII6	N250GB 5.4KS	N
AS6930G-583G25Mn	N16WXGAG8	9MGSHM	256M-GD2	SO2GBII6	SO1GBII6	N250GB 5.4KS	N
AS6930G-583G25Mn	N16WXGAG8	9MGSHM	256M-GD2	SO2GBII6	SO1GBII6	N250GB 5.4KS	N
AS6930G-583G25Mn	N16WXGAG8	9MGSHM	256M-GD2	SO2GBII6	SO1GBII6	N250GB 5.4KS	N
AS6930G-583G25Mn	N16WXGAG8	9MGSHM	256M-GD2	SO2GBII6	SO1GBII6	N250GB 5.4KS	N
AS6930G-583G25Mn	N16WXGAG8	9MGSHM	256M-GD2	SO2GBII6	SO1GBII6	N250GB 5.4KS	N
AS6930G-583G25Mi	N16WXGAG8	9MGSHM	256M-GD2	SO2GBII6	SO1GBII6	N250GB 5.4KS	N
AS6930G-583G25Mn	N16WXGAG8	9MGSHM	256M-GD2	SO2GBII6	SO1GBII6	N250GB 5.4KS	N

Model	LCD	VGA Chip	VRAM 1	Mem 1	Mem 2	HDD 1 (GB)	HDD 2 (GB)
AS6930G-733G25Mn	N16WXGAG8	9MGSHM	256M-GD2	SO2GBII6	SO1GBII6	N250GB 5.4KS	N
AS6930G-733G25Mn	N16WXGAG8	9MGSHM	256M-GD2	SO2GBII6	SO1GBII6	N250GB 5.4KS	N
AS6930G-733G25Mn	N16WXGAG8	9MGSHM	256M-GD2	SO2GBII6	SO1GBII6	N250GB 5.4KS	N
AS6930G-733G25Mn	N16WXGAG8	9MGSHM	256M-GD2	SO2GBII6	SO1GBII6	N250GB 5.4KS	N
AS6930G-733G25Mn	N16WXGAG8	9MGSHM	256M-GD2	SO2GBII6	SO1GBII6	N250GB 5.4KS	N
AS6930G-733G25Mn	N16WXGAG8	9MGSHM	256M-GD2	SO2GBII6	SO1GBII6	N250GB 5.4KS	N
AS6930G-844G64Mn	N16WXGAG8	9MGSHM	256M-GD2	SO2GBII6	SO2GBII6	N320GB 5.4KS	N320GB 5.4KS
AS6930G-734G32Bn	N16WXGAG8	9MGSHM	256M-GD2	SO2GBII6	SO2GBII6	N320GB 5.4KS	N
AS6930G-842G25Mn	N16WXGAG8	9MGSHM	256M-GD2	SO1GBII6	SO1GBII6	N250GB 5.4KS	N
AS6930G-732G16Mn	N16WXGAG8	9MGSHM	256M-GD2	SO1GBII6	SO1GBII6	N160GB 5.4KS	N
AS6930G-732G16Bn	N16WXGAG8	9MGSHM	256M-GD2	SO1GBII6	SO1GBII6	N160GB 5.4KS	N
AS6930G-733G32Mn	N16WXGAG8	9MGSHM	256M-GD2	SO2GBII6	SO1GBII6	N320GB 5.4KS	N
AS6930G-732G32Mn	N16WXGAG8	9MGSHM	256M-GD2	SO2GBII6	N	N320GB 5.4KS	N
AS6930G-842G25Bn	N16WXGAG8	9MGSHM	256M-GD2	SO1GBII6	SO1GBII6	N250GB 5.4KS	N
AS6930G-863G32Mn	N16WUXGAG8	9PGSHM	512M-GD3	SO2GBII6	SO1GBII6	N320GB 5.4KS	N
AS6930G-843G25Mn	N16WXGAG8	9PGSHM	512M-GD3	SO2GBII6	SO1GBII6	N250GB 5.4KS	N
AS6930G-864G32Mn	N16WXGAG8	9PGSHM	512M-GD3	SO2GBII6	SO2GBII6	N320GB 5.4KS	N
AS6930G-584G32Mn	N16WXGAG8	9PGSHM	512M-GD3	SO2GBII6	SO2GBII6	N320GB 5.4KS	N
AS6930G-864G32Mn	N16WXGAG8	9PGSHM	512M-GD3	SO2GBII6	SO2GBII6	N320GB 5.4KS	N
AS6930G-864G32Mn	N16WXGAG8	9PGSHM	512M-GD3	SO2GBII6	SO2GBII6	N320GB 5.4KS	N
AS6930G-733G32Mn	N16WXGAG8	9PGSHM	512M-GD3	SO2GBII6	SO1GBII6	N320GB 5.4KS	N
AS6930G-734G32Mn	N16WXGAG8	9PGSHM	512M-GD3	SO2GBII6	SO2GBII6	N320GB 5.4KS	N
AS6930G-734G32Mn	N16WXGAG8	9PGSHM	512M-GD3	SO2GBII6	SO2GBII6	N320GB 5.4KS	N
AS6930G-734G32Mn	N16WXGAG8	9PGSHM	512M-GD3	SO2GBII6	SO2GBII6	N320GB 5.4KS	N
AS6930G-734G32Mn	N16WXGAG8	9PGSHM	512M-GD3	SO2GBII6	SO2GBII6	N320GB 5.4KS	N
AS6930G-734G32Mn	N16WXGAG8	9PGSHM	512M-GD3	SO2GBII6	SO2GBII6	N320GB 5.4KS	N
AS6930G-734G32Mn	N16WXGAG8	9PGSHM	512M-GD3	SO2GBII6	SO2GBII6	N320GB 5.4KS	N
AS6930G-734G32Mn	N16WXGAG8	9PGSHM	512M-GD3	SO2GBII6	SO2GBII6	N320GB 5.4KS	N

Model	LCD	VGA Chip	VRAM 1	Mem 1	Mem 2	HDD 1 (GB)	HDD 2 (GB)
AS6930G-734G32Mn	N16WXGAG8	9PGSHM	512M-GD3	SO2GBII6	SO2GBII6	N320GB 5.4KS	N
AS6930G-734G32Mn	N16WXGAG8	9PGSHM	512M-GD3	SO2GBII6	SO2GBII6	N320GB 5.4KS	N
AS6930G-734G32Mn	N16WXGAG8	9PGSHM	512M-GD3	SO2GBII6	SO2GBII6	N320GB 5.4KS	N
AS6930G-734G32Mn	N16WXGAG8	9PGSHM	512M-GD3	SO2GBII6	SO2GBII6	N320GB 5.4KS	N
AS6930G-734G32Mn	N16WXGAG8	9PGSHM	512M-GD3	SO2GBII6	SO2GBII6	N320GB 5.4KS	N
AS6930G-734G32Mn	N16WXGAG8	9PGSHM	512M-GD3	SO2GBII6	SO2GBII6	N320GB 5.4KS	N
AS6930G-734G32Mn	N16WXGAG8	9PGSHM	512M-GD3	SO2GBII6	SO2GBII6	N320GB 5.4KS	N
AS6930G-734G32Mn	N16WXGAG8	9PGSHM	512M-GD3	SO2GBII6	SO2GBII6	N320GB 5.4KS	N
AS6930G-734G32Mn	N16WXGAG8	9PGSHM	512M-GD3	SO2GBII6	SO2GBII6	N320GB 5.4KS	N
AS6930G-734G32Mn	N16WXGAG8	9PGSHM	512M-GD3	SO2GBII6	SO2GBII6	N320GB 5.4KS	N
AS6930G-734G32Mn	N16WXGAG8	9PGSHM	512M-GD3	SO2GBII6	SO2GBII6	N320GB 5.4KS	N
AS6930G-943G64Mn	N16WXGAG8	9PGSHM	512M-GD3	SO2GBII6	SO1GBII6	N320GB 5.4KS	N320GB 5.4KS
AS6930G-943G50Mn	N16WXGAG8	9PGSHM	512M-GD3	SO2GBII6	SO1GBII6	N250GB 5.4KS	N250GB 5.4KS
AS6930G-583G32Mn	N16WXGAG8	9PGSHM	512M-GD3	SO2GBII6	SO1GBII6	N320GB 5.4KS	N
AS6930G-593G32Mn	N16WXGAG8	9PGSHM	512M-GD3	SO2GBII6	SO1GBII6	N320GB 5.4KS	N
AS6930G-734G32Mn	N16WXGAG8	9PGSHM	512M-GD3	SO2GBII6	SO2GBII6	N320GB 5.4KS	N
AS6930G-733G32Mn	N16WXGAG8	9PGSHM	512M-GD3	SO2GBII6	SO1GBII6	N320GB 5.4KS	N
AS6930G-732G32Mn	N16WXGAG8	9PGSHM	512M-GD3	SO2GBII6	N	N320GB 5.4KS	N
AS6930G-844G32Bn	N16WXGAG8	9PGE2HM	512M-GD2	SO2GBII6	SO2GBII6	N320GB 5.4KS	N
AS6930G-944G32Bn	N16WUXGAG8	9PGE2HM	512M-GD2	SO2GBII6	SO2GBII6	N320GB 5.4KS	N

Model	ODD	Card Reader	Wireless LAN	Wireless LAN1	Bluetooth	Finger Print
AS6930-732G25Mn	NSM8XS	5 in 1-Build in	SP3x3MMW	SP3x3MMW	BT 2.0	N
AS6930-843G25Mn	NSM8XS	5 in 1-Build in	SP1x2MMW	SP1x2MMW	BT 2.0	N
AS6930-583G32Mn	NSM8XS	5 in 1-Build in	SP1x2MMW	SP1x2MMW	N	N
AS6930-583G32Mn	NSM8XS	5 in 1-Build in	SP1x2MMW	SP1x2MMW	N	N
AS6930-583G32Mn	NSM8XS	5 in 1-Build in	SP1x2MMW	SP1x2MMW	N	N

Model	ODD	Card Reader	Wireless LAN	Wireless LAN1	Bluetooth	Finger Print
AS6930-583G32Mn	NSM8XS	5 in 1-Build in	SP1x2MMW	SP1x2MMW	N	N
AS6930-583G32Mn	NSM8XS	5 in 1-Build in	SP1x2MMW	SP1x2MMW	N	N
AS6930-583G32Mn	NSM8XS	5 in 1-Build in	SP1x2MMW	SP1x2MMW	N	N
AS6930-583G32Mn	NSM8XS	5 in 1-Build in	SP1x2MMW	SP1x2MMW	N	N
AS6930-583G32Mn	NSM8XS	5 in 1-Build in	SP1x2MMW	SP1x2MMW	N	N
AS6930-583G32Mn	NSM8XS	5 in 1-Build in	SP1x2MMW	SP1x2MMW	N	N
AS6930-583G32Mn	NSM8XS	5 in 1-Build in	SP1x2MMW	SP1x2MMW	N	N
AS6930-583G32Mn	NSM8XS	5 in 1-Build in	SP1x2MMW	SP1x2MMW	N	N
AS6930-583G32Mn	NSM8XS	5 in 1-Build in	SP1x2MMW	SP1x2MMW	N	N
AS6930-583G32Mn	NSM8XS	5 in 1-Build in	SP1x2MMW	SP1x2MMW	N	N
AS6930-583G32Mn	NSM8XS	5 in 1-Build in	SP1x2MMW	SP1x2MMW	N	N
AS6930-583G32Mn	NSM8XS	5 in 1-Build in	SP1x2MMW	SP1x2MMW	N	N
AS6930-583G32Mn	NSM8XS	5 in 1-Build in	SP1x2MMW	SP1x2MMW	N	N
AS6930-583G32Mn	NSM8XS	5 in 1-Build in	SP1x2MMW	SP1x2MMW	N	N
AS6930-583G32Mn	NSM8XS	5 in 1-Build in	SP1x2MMW	SP1x2MMW	N	N
AS6930-583G32Mn	NSM8XS	5 in 1-Build in	SP1x2MMW	SP1x2MMW	N	N
AS6930-583G32Mn	NSM8XS	5 in 1-Build in	SP1x2MMW	SP1x2MMW	N	N
AS6930-583G32Mn	NSM8XS	5 in 1-Build in	SP1x2MMW	SP1x2MMW	N	N
AS6930-583G32Mn	NSM8XS	5 in 1-Build in	SP1x2MMW	SP1x2MMW	N	N
AS6930-942G25Mn	NSM8XS	5 in 1-Build in	SP1x2MMW	SP1x2MMW	BT 2.0	N
AS6930-942G25Mn	NSM8XS	5 in 1-Build in	SP1x2MMW	SP1x2MMW	BT 2.0	N
AS6930-942G25Mn	NSM8XS	5 in 1-Build in	SP1x2MMW	SP1x2MMW	BT 2.0	N
AS6930-844G16Mn	NSM8XS	5 in 1-Build in	SP1x2HMMW	SP1x2HMMW	BT 2.0	N
AS6930-842G12Mn	NSM8XS	5 in 1-Build in	SP1x2HMMW	SP1x2HMMW	BT 2.0	N
AS6930-584G32Mn	NSM8XS	5 in 1-Build in	SP1x2MMW	SP1x2MMW	BT 2.0	N
AS6930-584G32Mn	NSM8XS	5 in 1-Build in	SP1x2MMW	SP1x2MMW	BT 2.0	N
AS6930-584G25Mn	NSM8XS	5 in 1-Build in	SP1x2MMW	SP1x2MMW	N	N
AS6930-584G25Mn	NSM8XS	5 in 1-Build in	SP1x2MMW	SP1x2MMW	N	N
AS6930-732G16Mn	NSM8XS	5 in 1-Build in	SP1x2MMW	SP1x2MMW	BT 2.0	N
AS6930-732G16Mn	NSM8XS	5 in 1-Build in	SP1x2MMW	SP1x2MMW	BT 2.0	N

Model	ODD	Card Reader	Wireless LAN	Wireless LAN1	Bluetooth	Finger Print
AS6930G-844G64Mn	NSM8XS	5 in 1-Build in	SP1x2MMW	SP1x2MMW	BT 2.0	TCS4E
AS6930G-844G64Mn	NSM8XS	5 in 1-Build in	SP1x2MMW	SP1x2MMW	BT 2.0	TCS4E
AS6930G-844G64Mn	NSM8XS	5 in 1-Build in	SP1x2MMW	SP1x2MMW	BT 2.0	TCS4E
AS6930G-844G64Mn	NSM8XS	5 in 1-Build in	SP1x2MMW	SP1x2MMW	BT 2.0	TCS4E
AS6930G-844G64Mn	NSM8XS	5 in 1-Build in	SP1x2MMW	SP1x2MMW	BT 2.0	TCS4E
AS6930G-844G64Mn	NSM8XS	5 in 1-Build in	SP1x2MMW	SP1x2MMW	BT 2.0	TCS4E
AS6930G-844G64Mn	NSM8XS	5 in 1-Build in	SP1x2MMW	SP1x2MMW	BT 2.0	TCS4E
AS6930G-844G64Mn	NSM8XS	5 in 1-Build in	SP1x2MMW	SP1x2MMW	BT 2.0	TCS4E
AS6930G-842G25Bn	NBDCB2XS	5 in 1-Build in	SP1x2MMW	SP1x2MMW	N	TCS4E
AS6930G-862G32Bn	NBDCB2XS	5 in 1-Build in	SP1x2MMW	SP1x2MMW	N	TCS4E
AS6930G-864G32Bn	NBDCB2XS	5 in 1-Build in	SP1x2MMW	SP1x2MMW	N	TCS4E
AS6930G-844G64Mn	NSM8XS	5 in 1-Build in	SP1x2MMW	SP1x2MMW	BT 2.0	TCS4E
AS6930G-844G64Mn	NSM8XS	5 in 1-Build in	SP1x2MMW	SP1x2MMW	BT 2.0	TCS4E
AS6930G-844G64Mn	NSM8XS	5 in 1-Build in	SP1x2MMW	SP1x2MMW	BT 2.0	TCS4E
AS6930G-844G64Mn	NSM8XS	5 in 1-Build in	SP1x2MMW	SP1x2MMW	BT 2.0	TCS4E
AS6930G-844G64Mn	NSM8XS	5 in 1-Build in	SP1x2MMW	SP1x2MMW	BT 2.0	TCS4E
AS6930G-844G64Mn	NSM8XS	5 in 1-Build in	SP1x2MMW	SP1x2MMW	BT 2.0	TCS4E
AS6930G-844G64Mn	NSM8XS	5 in 1-Build in	SP1x2MMW	SP1x2MMW	BT 2.0	TCS4E
AS6930G-844G64Mn	NSM8XS	5 in 1-Build in	SP1x2MMW	SP1x2MMW	BT 2.0	TCS4E
AS6930G-844G64Mn	NSM8XS	5 in 1-Build in	SP1x2MMW	SP1x2MMW	BT 2.0	TCS4E
AS6930G-844G64Mn	NSM8XS	5 in 1-Build in	SP1x2MMW	SP1x2MMW	BT 2.0	TCS4E
AS6930G-844G64Mn	NSM8XS	5 in 1-Build in	SP1x2MMW	SP1x2MMW	BT 2.0	TCS4E
AS6930G-844G64Mn	NSM8XS	5 in 1-Build in	SP1x2MMW	SP1x2MMW	BT 2.0	TCS4E
AS6930G-844G64Mn	NSM8XS	5 in 1-Build in	SP1x2MMW	SP1x2MMW	BT 2.0	TCS4E
AS6930G-844G64Mn	NSM8XS	5 in 1-Build in	SP1x2MMW	SP1x2MMW	BT 2.0	TCS4E
AS6930G-844G64Mn	NSM8XS	5 in 1-Build in	SP1x2MMW	SP1x2MMW	BT 2.0	TCS4E
AS6930G-944G32Mn	NSM8XS	5 in 1-Build in	SP1x2MMW	SP1x2MMW	BT 2.0	TCS4E
AS6930G-944G32Mn	NSM8XS	5 in 1-Build in	SP1x2MMW	SP1x2MMW	BT 2.0	TCS4E
AS6930G-943G64Mn	NSM8XS	5 in 1-Build in	SP1x2MMW	SP1x2MMW	BT 2.0	TCS4E
AS6930G-733G32Bn	NBDCB2XS	5 in 1-Build in	SP1x2MMW	SP1x2MMW	N	TCS4E
AS6930G-733G32Bn	NBDCB2XS	5 in 1-Build in	SP1x2MMW	SP1x2MMW	N	TCS4E

Model	ODD	Card Reader	Wireless LAN	Wireless LAN1	Bluetooth	Finger Print
AS6930G-842G25Bn	NBDCB2XS	5 in 1-Build in	SP1x2MMW	SP1x2MMW	N	TCS4E
AS6930G-863G32Mn	NSM8XS	5 in 1-Build in	SP3x3MMW	SP3x3MMW	BT 2.0	TCS4E
AS6930G-843G25Mn	NSM8XS	5 in 1-Build in	SP1x2MMW	SP1x2MMW	BT 2.0	TCS4E
AS6930G-864G32Mn	NSM8XS	5 in 1-Build in	SP1x2MMW	SP1x2MMW	BT 2.0	TCS4E
AS6930G-584G32Mn	NSM8XS	5 in 1-Build in	SP1x2MMW	SP1x2MMW	N	TCS4E
AS6930G-864G32Mn	NSM8XS	5 in 1-Build in	SP1x2MMW	SP1x2MMW	BT 2.0	TCS4E
AS6930G-864G32Mn	NSM8XS	5 in 1-Build in	SP1x2MMW	SP1x2MMW	BT 2.0	TCS4E
AS6930G-733G32Mn	NSM8XS	5 in 1-Build in	SP1x2MMW	SP1x2MMW	BT 2.0	TCS4E
AS6930G-734G32Mn	NSM8XS	5 in 1-Build in	SP1x2MMW	SP1x2MMW	BT 2.0	TCS4E
AS6930G-734G32Mn	NSM8XS	5 in 1-Build in	SP1x2MMW	SP1x2MMW	BT 2.0	TCS4E
AS6930G-734G32Mn	NSM8XS	5 in 1-Build in	SP1x2MMW	SP1x2MMW	BT 2.0	TCS4E
AS6930G-734G32Mn	NSM8XS	5 in 1-Build in	SP1x2MMW	SP1x2MMW	BT 2.0	TCS4E
AS6930G-734G32Mn	NSM8XS	5 in 1-Build in	SP1x2MMW	SP1x2MMW	BT 2.0	TCS4E
AS6930G-734G32Mn	NSM8XS	5 in 1-Build in	SP1x2MMW	SP1x2MMW	BT 2.0	TCS4E
AS6930G-734G32Mn	NSM8XS	5 in 1-Build in	SP1x2MMW	SP1x2MMW	BT 2.0	TCS4E
AS6930G-734G32Mn	NSM8XS	5 in 1-Build in	SP1x2MMW	SP1x2MMW	BT 2.0	TCS4E
AS6930G-734G32Mn	NSM8XS	5 in 1-Build in	SP1x2MMW	SP1x2MMW	BT 2.0	TCS4E
AS6930G-734G32Mn	NSM8XS	5 in 1-Build in	SP1x2MMW	SP1x2MMW	BT 2.0	TCS4E
AS6930G-734G32Mn	NSM8XS	5 in 1-Build in	SP1x2MMW	SP1x2MMW	BT 2.0	TCS4E
AS6930G-734G32Mn	NSM8XS	5 in 1-Build in	SP1x2MMW	SP1x2MMW	BT 2.0	TCS4E
AS6930G-734G32Mn	NSM8XS	5 in 1-Build in	SP1x2MMW	SP1x2MMW	BT 2.0	TCS4E
AS6930G-734G32Mn	NSM8XS	5 in 1-Build in	SP1x2MMW	SP1x2MMW	BT 2.0	TCS4E
AS6930G-734G32Mn	NSM8XS	5 in 1-Build in	SP1x2MMW	SP1x2MMW	BT 2.0	TCS4E
AS6930G-734G32Mn	NSM8XS	5 in 1-Build in	SP1x2MMW	SP1x2MMW	BT 2.0	TCS4E
AS6930G-734G32Mn	NSM8XS	5 in 1-Build in	SP1x2MMW	SP1x2MMW	BT 2.0	TCS4E
AS6930G-734G32Mn	NSM8XS	5 in 1-Build in	SP1x2MMW	SP1x2MMW	BT 2.0	TCS4E
AS6930G-734G32Mn	NSM8XS	5 in 1-Build in	SP1x2MMW	SP1x2MMW	BT 2.0	TCS4E
AS6930G-734G32Mn	NSM8XS	5 in 1-Build in	SP1x2MMW	SP1x2MMW	BT 2.0	TCS4E
AS6930G-734G32Mn	NSM8XS	5 in 1-Build in	SP1x2MMW	SP1x2MMW	BT 2.0	TCS4E
AS6930G-943G64Mn	NSM8XS	5 in 1-Build in	SP1x2MMW	SP1x2MMW	BT 2.0	TCS4E
AS6930G-943G50Mn	NSM8XS	5 in 1-Build in	SP1x2MMW	SP1x2MMW	BT 2.0	TCS4E
AS6930G-583G32Mn	NSM8XS	5 in 1-Build in	SP1x2MMW	SP1x2MMW	BT 2.0	TCS4E

Model	ODD	Card Reader	Wireless LAN	Wireless LAN1	Bluetooth	Finger Print
AS6930G-593G32Mn	NSM8XS	5 in 1-Build in	SP1x2MMW	SP1x2MMW	BT 2.0	TCS4E
AS6930G-734G32Mn	NSM8XS	5 in 1-Build in	SP1x2MMW	SP1x2MMW	N	TCS4E
AS6930G-733G32Mn	NSM8XS	5 in 1-Build in	SP3x3MMW	SP3x3MMW	BT 2.0	TCS4E
AS6930G-732G32Mn	NSM8XS	5 in 1-Build in	SP3x3MMW	SP3x3MMW	BT 2.0	TCS4E
AS6930G-844G32Bn	NBDCB2XS	5 in 1-Build in	SP1x2MMW	SP1x2MMW	BT 2.0	TCS4E
AS6930G-944G32Bn	NBDCB2XS	5 in 1-Build in	SP1x2MMW	SP1x2MMW	BT 2.0	TCS4E

Test Compatible Components

This computer's compatibility is tested and verified by Acer's internal testing department. All of its system functions are tested under Windows® XP Home, Windows® XP Pro environment.

Refer to the following lists for components, adapter cards, and peripherals which have passed these tests. Regarding configuration, combination and test procedures, please refer to the Aspire 6930/6930G series Compatibility Test Report released by the Acer Mobile System Testing Department.

Microsoft® Windows® Vista Environment Test

Vendor	Type	Description
Adapter		
F0000183 DELTA CN	65W	Adapter DELTA 65W 1.7x5.5x11 SADP-65KB DFA LF level 4
10001023 LITE-ON	65W	Adapter LITE-ON 65W 1.7x5.5x11 PA-1650-02AC LF level 4
60002015 HIPRO	65W	Adapter HIPRO 65W 19V 1.7x5.5x11 Yellow HP-OK065B13 LED LF level 4
F0000183 DELTA CN	65W-DE	Adapter DELTA 65W 1.7x5.5x11 SADP-65KB BFJA LV4 LF for OBL only
F0000183 DELTA CN	90W	Adapter DELTA 90W 1.7x5.5x11 ADP-90SB BBEA LF level 4
10001023 LITE-ON	90W	Adapter LITE-ON 90W 19V 1.7x5.5x11 Blue PA-1900-24AR LED LF level 4
60002015 HIPRO	90W	Adapter HIPRO 90W 19V 1.7x5.5x11 Blue HP-OL093B13P LED LF level 4
F0000183 DELTA CN	90W-DE	Adapter DELTA 90W 1.7x5.5x11 ADP-90SB BBEN (for OBL Spec.) LV4 LF
Battery Test		
60001921 SANYO	6CELL2.2	Battery SANYO AS-2007B Li-Ion 3S2P SANYO 6 cell 4400mAh Main COMMON Normal Type
10001063 SONY	6CELL2.2	Battery SONY AS-2007B Li-Ion 3S2P SONY 6 cell 4400mAh Main COMMON Normal Type
60001535 PANASONIC	6CELL2.2	Battery PANASONIC AS-2007B Li-Ion 3S2P PANASONIC 6 cell 4400mAh Main COMMON PSS
60002162 SIMPLO	6CELL2.2	Battery SIMPLO AS-2007B Li-Ion 3S2P PANASONIC 6 cell 4400mAh Main COMMON PSS
60001921 SANYO	8CELL2.4	Battery SANYO AS-2007B Li-Ion 4S2P SANYO 8 cell 4800mAh Main COMMON
10001063 SONY	8CELL2.4	Battery SONY AS-2007B Li-Ion 4S2P SONY 8 cell 4800mAh Main COMMON
60001535 PANASONIC	8CELL2.4	Battery PANASONIC AS-2007B Li-Ion 4S2P PANASONIC 8 cell 4800mAh Main COMMON
CPU Test		
10001067 INTEL	C2DP8400	CPU Intel Core2Dual P8400 PGA 2.26G 3M 1066 25W
10001067 INTEL	C2DP8600	CPU Intel Core2Dual P8600 PGA 2.4G 1066 25W 3M
10001067 INTEL	C2DP9500	CPU Intel Core2Dual P9500 PGA 2.53G 6M 1066 25W
10001067 INTEL	C2DT9400	CPU Intel Core2Dual T9400 PGA 2.53G 6M 1066 35W
HDD Test		
60002036 SEAGATE	N120GB5.4KS	HDD SEAGATE 2.5" 5400rpm 120GB ST9120817AS Corsair SATA LF F/W:3.AAA
60001922 TOSHIBA DIGI	N120GB5.4KS	HDD TOSHIBA 2.5" 5400rpm 120GB MK1252GSX Virgo BS SATA LF F/W:LV010J

Vendor	Type	Description
60002005 HGST SG	N120GB5.4KS	HDD HGST 2.5" 5400rpm 120GB HTS543212L9A300 Falcon-B SATA LF F/W:C40C
60002036 SEAGATE	N160GB5.4KS	HDD SEAGATE 2.5" 5400rpm 160GB ST9160310AS Crockett SATA LF F/W:0303
60001922 TOSHIBA DIGI	N160GB5.4KS	HDD TOSHIBA 2.5" 5400rpm 160GB MK1652GSX Virgo - BS SATA LF F/W:LV010J
60002005 HGST SG	N160GB5.4KS	HDD HGST 2.5" 5400rpm 160GB HTS543216L9A300 Falcon-B SATA LF F/W:C40C
60002036 SEAGATE	N250GB5.4KS	HDD SEAGATE 2.5" 5400rpm 250GB ST9250827AS Corsair SATA LF F/W:3.AAA
60001922 TOSHIBA DIGI	N250GB5.4KS	HDD TOSHIBA 2.5" 5400rpm 250GB MK2552GSX Virgo BS SATA LF F/W:LV010J
60002005 HGST SG	N250GB5.4KS	HDD HGST 2.5" 5400rpm 250GB HTS543225L9A300 Falcon-B SATA LF F/W:C40C
60001994 WD	N250GB5.4KS	HDD WD 2.5" 5400rpm 250GB WD2500BEVS-22UST0 ML125 SATA LF F/W:01.01A01
60002036 SEAGATE	N320GB5.4KS	HDD SEAGATE 2.5" 5400rpm 320GB ST9320320AS Crockett SATA LF F/W:0303
60001922 TOSHIBA DIGI	N320GB5.4KS	HDD TOSHIBA 2.5" 5400rpm 320GB MK3252GSX Virgo BS SATA LF F/W:LV010J
60002005 HGST SG	N320GB5.4KS	HDD HGST 2.5" 5400rpm 320GB HTS543232L9A300 Falcon-B SATA LF F/W:C40C
60001994 WD	N320GB5.4KS	HDD WD 2.5" 5400rpm 320GB WD3200BEVT-22ZCT0 ML160 SATA LF F/W:11.01A11
Second HDD Test		
60002036 SEAGATE	N120GB5.4KS	HDD SEAGATE 2.5" 5400rpm 120GB ST9120817AS Corsair SATA LF F/W:3.AAA
60001922 TOSHIBA DIGI	N120GB5.4KS	HDD TOSHIBA 2.5" 5400rpm 120GB MK1252GSX Virgo BS SATA LF F/W:LV010J
60002005 HGST SG	N120GB5.4KS	HDD HGST 2.5" 5400rpm 120GB HTS543212L9A300 Falcon-B SATA LF F/W:C40C
60002036 SEAGATE	N160GB5.4KS	HDD SEAGATE 2.5" 5400rpm 160GB ST9160310AS Crockett SATA LF F/W:0303
60001922 TOSHIBA DIGI	N160GB5.4KS	HDD TOSHIBA 2.5" 5400rpm 160GB MK1652GSX Virgo - BS SATA LF F/W:LV010J
60002005 HGST SG	N160GB5.4KS	HDD HGST 2.5" 5400rpm 160GB HTS543216L9A300 Falcon-B SATA LF F/W:C40C
60002036 SEAGATE	N250GB5.4KS	HDD SEAGATE 2.5" 5400rpm 250GB ST9250827AS Corsair SATA LF F/W:3.AAA
60001922 TOSHIBA DIGI	N250GB5.4KS	HDD TOSHIBA 2.5" 5400rpm 250GB MK2552GSX Virgo BS SATA LF F/W:LV010J
60002005 HGST SG	N250GB5.4KS	HDD HGST 2.5" 5400rpm 250GB HTS543225L9A300 Falcon-B SATA LF F/W:C40C
60001994 WD	N250GB5.4KS	HDD WD 2.5" 5400rpm 250GB WD2500BEVS-22UST0 ML125 SATA LF F/W:01.01A01

Vendor	Type	Description
60002036 SEAGATE	N320GB5.4KS	HDD SEAGATE 2.5" 5400rpm 320GB ST9320320AS Crockett SATA LF F/W:0303
60001922 TOSHIBA DIGI	N320GB5.4KS	HDD TOSHIBA 2.5" 5400rpm 320GB MK3252GSX Virgo BS SATA LF F/W:LV010J
60002005 HGST SG	N320GB5.4KS	HDD HGST 2.5" 5400rpm 320GB HTS543232L9A300 Falcon-B SATA LF F/W:C40C
60001994 WD	N320GB5.4KS	HDD WD 2.5" 5400rpm 320GB WD3200BEVT-22ZCT0 ML160 SATA LF F/W:11.01A11
Memory Test		
60002214 ELPIDA	SO1GBII6	Memory ELPIDA SO-DIMM DDRII 667 1GB EBE11UE6ACUA-6E-E LF 64*16 0.065um
60002215 SAMSUNG	SO1GBII6	Memory SAMSUNG SO-DIMM DDRII 667 1GB M470T2864QZ3-CE6 LF
60002045 HYNIX	SO1GBII6	Memory HYNIX SO-DIMM DDRII 667 1GB HYMP112S64CP6-Y5 LF
60001993 NANYA	SO2GBII6	Memory NANYA SO-DIMM DDRII 667 2GB NT2GT64U8HD0BN-3C LF 128*8 0.07um
16081942 MICRON	SO2GBII6	Memory MICRON SO-DIMM DDRII 667 2GB MT16HTF25664HY-667E1 LF
60002214 ELPIDA	SO2GBII6	Memory ELPIDA SO-DIMM DDRII 667 2GB EBE21UE8ACUA-6E-E LF 128*8 0.07um
60002215 SAMSUNG	SO2GBII6	Memory SAMSUNG SO-DIMM DDRII 667 2GB M470T5663QZ3-CE6 LF
60002045 HYNIX	SO2GBII6	Memory HYNIX SO-DIMM DDRII 667 2GB HYMP125S64CP8-Y5 LF
ODD Test		
10001063 SONY	NBDCB2XS	ODD SONY BD COMBO 12.7mm Tray DL 2X BC-5500S LF W/O bezel SATA
60001939 PIONEER	NSM8XS	ODD PIONEER Super-Multi DRIVE 12.7mm Tray DL 8X DVR-TD08RS LF W/O bezel SATA
23418669 HLDS	NSM8XS	ODD HLDS Super-Multi DRIVE 12.7mm Tray DL 8X GSA-T50N LF W/O bezel SATA
23418669 HLDS	NSM8XS	ODD HLDS Super-Multi DRIVE 12.7mm Tray DL 8X GSA-T50N LF W/O bezel SATA Malaysia
10001063 SONY	NSM8XS	ODD SONY Super-Multi DRIVE 12.7mm Tray DL 8X AD-7560S LF W/O bezel SATA
10001070 PHILIPS	NSM8XS	ODD PLDS Super-Multi DRIVE 12.7mm Tray DL 8X DS-8A2S LF W/O bezel SATA
VGA Test		
10001024 MSI	9MGSHM256M	MSI VGA Card nVidia NB9M-GS DDRII 256M 400MHz 32*16 MXM I w/ HDCP w/ Intersil PowerIC
10001080 YUAN	9MGSHM256M	Yuan VGA Card nVidia NB9M-GS DDRII 256M 400MHz 32*16 MXM I w/ HDCP w/ Intersil PowerIC
Northbridge Chipset Test		
10001067 INTEL	GM45	NB Chipset Intel CS GM45NB
10001067 INTEL	PM45	NB Chipset Intel CS PM45NB

Vendor	Type	Description
Southbridge Chipset Test		
10001067 INTEL	ICH9M	SB Chipset Intel CS ICH9M
Keyboard Test		
820123 DARFON	17_18KB-FV1	Keyboard 17_18KB-FV1 Teton Standard Black (Glossy)
LAN Test		
9999995 ONE TIME VENDER	AR8121	Atheros Lan AR8121
WiFi Antenna Test		
9999995 ONE TIME VENDER	PIFA	PIFA
Audio Codec Test		
9999995 ONE TIME VENDER	ALC888S	ALC888S
Bluetooth Test		
9999995 ONE TIME VENDER	BT 2.0	Foxconn Bluetooth FOX_BRM_2.0 F/W 300
Camera Test		
9999995 ONE TIME VENDER	0.3M DV	Suyin 0.3M DV Camellia_2
Card Reader Test		
9999995 ONE TIME VENDER	5 in 1-Build in	5 in 1-Build in MS, MS Pro, SD, SC, XD
Finger Print Reader Test		
9999995 ONE TIME VENDER	TCS4E	Upek Finger Print TCS4E
Modem Test		
23707801 FOXCONN TW	Fox+Con MC4Z 1.5_3.3V	Foxconn Conexant -Unizion 1.5_3.3v T60M955.02
23707801 FOXCONN TW	Fox+Con MC4Z 1.5_3.3V Aus	Foxconn Conexant -Unizion 1.5_3.3v AUS T60M955.0x
10001023 LITE-ON	Lite+Con MC4Z 1.5_3.3V Aus	Lite-On Conexant -Unizion 1.5_3.3v AUS RD02-D330
TV Tuner Test		
60003470 AVERMEDIA	DVB-T Mini-card	AVerMedia TV-tuner card DVB-T Mini-card A310 w/ Intel+MaxLinear Rev 1.0
60003470 AVERMEDIA	DVB-T Mini-card	AVerMedia TV-tuner card DVB-T Mini-card A309 w/ Afa AF9015 + MaxLiner MxL5003s Rev 1.0

Vendor	Type	Description
WLAN Test		
9999995 ONE TIME VENDER	3rd WiFi 1x2 BGN	Foxconn Wireless LAN Atheros AR5B91 1x2 BGN
9999995 ONE TIME VENDER	3rd WiFi 1x2 BGN	Foxconn Wireless LAN Wireless LAN Ralink RT2700E 1x2 BGN
10001067 INTEL	SP1x2MMW	Lan Intel WLAN 512AN_MMWG Shirley Peak 5100 MM#895361

Peripheral Tests

Test	Category	Model
PCMCIA Test	TV - Tuner Card	AVerMedia AVerTV Hybrid+FM Cardbus
	1394 CardBus Card	e-Sense PCMCIA 1394 CardBus 2 Ports
		UPMOST PCMCIA 1394 CardBus 2 Ports
		Billinton USB 2.0+1394 Combo Cardbus
	eSATA Card	Initio eSATA 2 serial ATA cardbus
	Wireless Lan Card	Sony Ericsson GC89 EDGE/Wireless LAN PC Card
		LINKSYS Wireless-B 2.4GHz 802.11b
		GigaByte 802.11 b.g Dual-Mode Wireless LAN Card
		BUFFALO 54 Mbps Wireless LAN Cardbus
	SCSI Card	Ultra Slim SCSI 1480B Cardbus
		Ultra Slim SCSI 1460 PC Card
	USB2.0 CardBus Card	INTOPIC USB 2.0 4-Port Notebook Card(CardBus)(QSMC)
Billinton USB 2.0+1394 Combo Cardbus		
Express Card Test	1394 Express Card	AboCom Express Card 54 1394A 800Mbs/400Mbs
		AboCom Express Card 54 1394B 800Mbs
		Uptech 1394B 800Mbs
		ExpressCard 34 5 in 1 Adapter
	USB 2.0 Express Card	Belkin Firewire and USB 2.0 Express card
	TV Tuner Express Card	AVerMedia AVerTV Hybrid Express card
	External SATA II Express Card	eSATA II Dual Port Express
	Card Reader Express Card	Maxell Express card 34 5in1 adapter
		Hagiwara Sys-Com Express card 54 adapter
	GigaLAN Express Card	Maxell Express card 34 GigabitEthernet adapter
3G Express Card	BandLuxe C100	

Test	Category	Model
Display Port Test	External Monitor - CRT Monitor	View Sonic PF775
		Graphic Series GT775
		Philips 109P
		Dell 21" Monitor
	External Monitor - LCD Monitor	COMPAQ FP 7317 17" LCD area with 1024*768(QSMC)
		View Sonic 1680*1050
		Gateway FPD1730 17" (1280*1024)(QSMC)
		CMV CM-930D 17" LCD (1280*1024)
		ACER AL2423W LCD area with 1920*1200
		Gateway TV 26" LCD area with 1280*768
		Toshiba TV 37HL869 LCD area with 1366*768
	External Monitor - DVI Monitor	VP730b 17" 1280*1024 (QSMC)
		CMV CM-930D 17" LCD (1280*1024)
		Gateway TV 26" LCD area with 1280*768
		ACER AL2423W LCD area with 1920*1200
	Projector	BenQ FB8225(QSMC)
		3M MP76301
	TV	FERGUSON DV3(QSMC)
		SONY Trinitron 14"VPL-CX5
	LCD TV	Gateway TV 26" LCD area with 1280*768
		Acer AT4220 area with 1920*1200
	HD TV (HDMI)	Toshiba TV 37HL869 LCD area with 1366*768
		Acer AT4220 area with 1920*1200
USB Port Test	Keyboard	NewMen KB-085 USB KEYBOARD
		WiNTEK USB Keyboard
		Microsoft USB/PS2 Keyboard
		A4tech Wireless Ergonomic Keyboard and wireless mouse (USB, Wheel)(QSMC)
		Logitech Cordless Mouse and Keyboard(USB, Wheel)
		Microsoft Wireless Optical Desktop(USB PS/2)
		USB KeyPad:ZIPPY USB Keypad TK323(QSMC)
	Mouse	Logitech Wheel Mouse (Optical, USB PS/2)
		Huaerte mouse (USB)
		NEC Mouse (USB)
		YAHOO XEPER Optical Mouse (USB)
		Logitech (Optical)\(USB)
		Microsoft IntelliMouse Explorer 3.0 USB and PS/2 Compatible(Optical)(QSMC)
		Logitech Wheel Mouse (Optical, USB PS/2)
		NEC Mouse (USB)
	Printer	Epson Stylus C65 Printer
		HP deskjet 3535 Printer

Test	Category	Model	
USB Port Test (cont.)	Scanner	Canon USB2.0 Scanner	
		NEC MultiReader MR800U3 USB2.0 Scanner	
	Speaker	SCLAR	
		OZAKI USB 5.1CH-IN-2SPK Digital Sound - US206	
	Joystick	NAZAR GPC-V70	
		Logitech Freedom 2.4Cordless Joystick	
		Logitech WingMan RUMBLEPAD (USB)	
	Camera / DV	Kinco QuickCam	
		Logitech QuickCam IM (USB2.0)	
		Dlink Digital Camera	
		Flexicam A300 USB Web Camera	
		Praktica Luxmedia 5203 Digital Camera	
	Card Reader	5 in 1	
		HR8-U2M MS/MS-PRO/DUO	
	HDD	FUJITSU USB2.0 HDD/HITACHI USB2.0 HDD	
		TOSHIBA USB2.0 HDD	
	DVD/CD-RW	YAMAHA CD-R/RW Drive	
		MP5125A DVD+RW/+R	
		TOSHIBA DVD-R/RW	
	Handy Drive	Sandisk 8G/Transcend 8G	
		A-data 16G	
	FDD	IBM USB2.0 Device	
		Panasonic YD-8U10 USB1.0 Device	
		Mitsumi USB1.1 Floppy Disk Drive (QSMC)	
		SMSC USB1.1 external Floppy Drive (QSMC)	
	HUB	Slim DX-274AP USB1.1 SLIM HUB 4 Port (QSMC)	
		XHUB4 4-port USB 2.0 hub (adaptec)	
		D-Link 4-Port USB 2.0 Hub	
		Hi-Speed 4-Port USB 2.0 HUB (IOGEAR)	
	3G	BandLuxe C100	
	Access Point Test	Wireless Lan AP	D-Link 655 (N)
			Cisco Aironet 1200 (G)
			Buffalo WZR2-G300N (n)
Bluetooth Test	Bluetooth Mouse	KYE Bluetooth Mouse (Ferrari 5000)	
		Darfon Bluetooth Mouse (Ferrari 1000)	
	USB Bluetooth	Itech Bluetooth 2.0	
		Ambeon Bluetooth 2.0	
Card Reader Test	MMC Card	Transcend 512MB MMC Card	
		Transcend 2G MMC Card	
	SD Card	Sandisk 8.0G SD Card	
		A-Data 16G SD Card	
		Transcend 8G SD Card	

Test	Category	Model
Card Reader Test (cont.)	SD Adapter	Sandisk SD Adapter
		Sandisk MicroSD to SD Adapter
	MS Card	Sandisk 64MB MS Card(QSMC)
	MS Pro Card	Sony 256MB MS Card (MS Pro)
		LEXAR 256MB MS Card (MS Pro)(QSMC)
	MS Pro Duo Card	Sony Memory Stick Pro Duo 4GB
		Sony Memory Stick Pro Duo 8GB
	MS Duo Adapter	Sony Memory Stick Duo Adaptor
		Sandisk Memory Stick Duo Adaptor
	MicroSD	Transcend MicroSD 2G
		Sandisk MicroSD 8G
	MicroSD to MS Pro Duo Adapter	Transcend Memory Stick Duo Adaptor
		READY Memory Stick Duo Adaptor
	XD Card	OLYMPUS XD Picture Card 2G
OLYMPUS XD Picture Card 1G		
Fujifilm XD Picture Card 512MB		
1394 Port Test	1394-HDD	UNIQUE UA351-CB USB2.0/1394 HDD
		Clearlight 2.5" Hard Drive Enclosure (40G)(QSMC)
	1394-Cable	1394 Peer To Peer Cable
Audio Jacks Port Test	Speaker	Creative Inspire 5.1 digital 5600
		Edifier Speaker
	Head Phone	iRiver headphone
		Philips Headphone
	SPDIF	Creative Inspire 5.1 digital 5600
Port Reprecator Test	Docking	Cable Docking

Online Support Information

This section describes online technical support services available to help you repair your Acer Systems.

If you are a distributor, dealer, ASP or TPM, please refer your technical queries to your local Acer branch office. Acer Branch Offices and Regional Business Units may access our website. However some information sources will require a user i.d. and password. These can be obtained directly from Acer CSD Taiwan.

Acer's Website offers you convenient and valuable support resources whenever you need them.

In the Technical Information section you can download information on all of Acer's Notebook, Desktop and Server models including:

- Service guides for all models
- User's manuals
- Training materials
- Bios updates
- Software utilities
- Spare parts lists
- TABs (Technical Announcement Bulletin)

For these purposes, we have included an Acrobat File to facilitate the problem-free downloading of our technical material.

Also contained on this website are:

- Detailed information on Acer's International Traveler's Warranty (ITW)
- Returned material authorization procedures
- An overview of all the support services we offer, accompanied by a list of telephone, fax and email contacts for all your technical queries.

We are always looking for ways to optimize and improve our services, so if you have any suggestions or comments, please do not hesitate to communicate these to us.

A

AFLASH Utility 41

B

Battery Pack 50

BIOS

POST Codes 137

BIOS Utility 33–41

Boot 39

Exit 40

Navigating 33

Onboard Device Configuration 37

Save and Exit 40

Security 36

System Security 40

Bluetooth module 80

Board Layout

Top View 147

brightness

hotkeys 14

C

Camera Module 91

caps lock

on indicator 10

Common Problems 124

computer

on indicator 10

CPU 85

D

DIMM Module 54

Display 4

display

hotkeys 14

E

Euro 15

External Module Disassembly

Flowchart 49

F

Features 1

Flash Utility 41

FPC Cable 93

FRU (Field Replaceable Unit) List 151

H

Hard Disk Drive Module 59

Hibernation mode

hotkey 14

Hot Keys 12

I

Indicators 10

Intermittent Problems 136

Internal Microphone Failure 130

Internal Speaker Failure 128

inverter board 90

J

Jumper and Connector Locations 147

Top View 147

K

Keyboard 69

Keyboard Failure 127

L

LCD Bezel 87

LCD Brackets 93

LCD Failure 127

LCD Module Disassembly

Flowchart 86

LCD Panel 92

lower cover 53

M

Main Unit Disassembly

Flowchart 65

Mainboard 82

media access

on indicator 10
Memory Check 124
Model Definition 164
Modem Module 79

N

No Display Issue 125
Notebook Manager
hotkey 14
num lock
on indicator 10

O

Online Support Information 225
optical drive module 61

P

Panel 5
Bottom 9
left 5
PC Card 10
POST Codes 137
Power On Failure 124

S

speakers
hotkey 14
System
Block Diagram 4

T

Test Compatible Components 215
Top 147
touchpad
hotkey 14
Touchpad Failure 128
Troubleshooting
Built-in KB Failure 127
Internal Microphone 130
Internal Speakers 128
LCD Failure 127
No Display 125
Other Failures 135
Power On 124
Touchpad 128

USB 134
TV tuner 56

U

Undetermined Problems 136
USB Failure (Rightside) 134
utility
BIOS 33–41

V

VGA Module 55

W

Windows 2000 Environment Test 216
WLAN Board 56

Free Manuals Download Website

<http://myh66.com>

<http://usermanuals.us>

<http://www.somanuals.com>

<http://www.4manuals.cc>

<http://www.manual-lib.com>

<http://www.404manual.com>

<http://www.luxmanual.com>

<http://aubethermostatmanual.com>

Golf course search by state

<http://golfingnear.com>

Email search by domain

<http://emailbydomain.com>

Auto manuals search

<http://auto.somanuals.com>

TV manuals search

<http://tv.somanuals.com>