

Aspire 6935G Series Service Guide

Service guide files and updates are available on the ACER/CSD web; for more information, please refer to <http://csd.acer.com.tw>

PRINTED IN TAIWAN

Revision History

Please refer to the table below for the updates made on Aspire 6935G service guide.

Date	Chapter	Updates

Copyright

Copyright © 2008 by Acer Incorporated. All rights reserved. No part of this publication may be reproduced, transmitted, transcribed, stored in a retrieval system, or translated into any language or computer language, in any form or by any means, electronic, mechanical, magnetic, optical, chemical, manual or otherwise, without the prior written permission of Acer Incorporated.

Disclaimer

The information in this guide is subject to change without notice.

Acer Incorporated makes no representations or warranties, either expressed or implied, with respect to the contents hereof and specifically disclaims any warranties of merchantability or fitness for any particular purpose. Any Acer Incorporated software described in this manual is sold or licensed "as is". Should the programs prove defective following their purchase, the buyer (and not Acer Incorporated, its distributor, or its dealer) assumes the entire cost of all necessary servicing, repair, and any incidental or consequential damages resulting from any defect in the software.

Acer is a registered trademark of Acer Corporation.

Intel is a registered trademark of Intel Corporation.

Pentium and Pentium II/III are trademarks of Intel Corporation.

Other brand and product names are trademarks and/or registered trademarks of their respective holders.

Conventions

The following conventions are used in this manual:

SCREEN MESSAGES	Denotes actual messages that appear on screen.
NOTE	Gives bits and pieces of additional information related to the current topic.
WARNING	Alerts you to any damage that might result from doing or not doing specific actions.
CAUTION	Gives precautionary measures to avoid possible hardware or software problems.
IMPORTANT	Reminds you to do specific actions relevant to the accomplishment of procedures.

Preface

Before using this information and the product it supports, please read the following general information.

1. This Service Guide provides you with all technical information relating to the BASIC CONFIGURATION decided for Acer's "global" product offering. To better fit local market requirements and enhance product competitiveness, your regional office MAY have decided to extend the functionality of a machine (e.g. add-on card, modem, or extra memory capability). These LOCALIZED FEATURES will NOT be covered in this generic service guide. In such cases, please contact your regional offices or the responsible personnel/channel to provide you with further technical details.
2. Please note WHEN ORDERING FRU PARTS, that you should check the most up-to-date information available on your regional web or channel. If, for whatever reason, a part number change is made, it will not be noted in the printed Service Guide. For ACER-AUTHORIZED SERVICE PROVIDERS, your Acer office may have a DIFFERENT part number code to those given in the FRU list of this printed Service Guide. You MUST use the list provided by your regional Acer office to order FRU parts for repair and service of customer machines.

System Specifications	1
Features	1
System Block Diagram	4
Board Layout	5
Top View	5
Bottom view	6
Your Acer Notebook tour	7
Front View	7
Closed Front View	9
Left View	9
Right View	10
Rear View	10
Base View	11
Indicators	12
Easy-Launch Buttons	13
Touchpad Basics	14
Using the Keyboard	15
Lock Keys and embedded numeric keypad	15
Windows Keys	16
Hot Keys	17
Special Key	18
The Euro symbol	18
The US dollar sign	18
Acer Empowering Technology	19
Empowering Technology password	20
Acer eAudio Management	21
Acer ePower Management	22
Acer eDataSecurity Management (for selected models)	24
Acer eRecovery Management	26
Acer eSettings Management	28
Using the System Utilities	30
Hardware Specification and Configurations	33
 System Utilities	 39
BIOS Setup Utility	39
Invoking BIOS Setup	40
Information	41
Main	42
Advanced	44
Security	45
Boot	49
Exit	50
BIOS Flash Utility	51
HDD unlock Utility	52
 Machine Disassembly and Replacement	 53
General Information	54
Before You Begin	54
Disassembly Procedure Flowchart	55
Removing the Battery Pack	57
Removing HDD/Wireless Cover/RAM Module/Wireless LAN Card/TV Tunder Card/ System Fan/ Thermal Module/CPU/ODD/Dummy cards	58
Disassembling the Main Unit	63
Disassembling the External Modules	68

Table of Contents

Troubleshooting	69
System Check Procedures	70
External Diskette Drive Check	70
External CD-ROM Drive Check	70
Keyboard or Auxiliary Input Device Check	70
Memory check	71
Power System Check	71
Touchpad Check	72
Power-On Self-Test (POST) Error Message	73
Index of Error Messages	74
Phoenix BIOS Beep Codes	77
Index of Symptom-to-FRU Error Message	81
Intermittent Problems	85
Undetermined Problems	86
Jumper and Connector Locations	87
Top View	87
Bottom View	88
FRU (Field Replaceable Unit) List	91
Aspire 6935G Exploded Diagram	92
Aspire 6935G FRU List	108

System Specifications

Features

Below is a brief summary of the computer's many feature:

Operating system

- ❑ Windows Vista™

NOTE: Windows® Vista™ Capable PCs come with Windows® XP installed, and can be upgraded to Windows® Vista™. For more information on Windows® Vista™ and how to upgrade, go to: Microsoft.com/windowsvista

Platform

- ❑ Intel® Centrino® Duo mobile processor technology, featuring:
 - Intel® Core™2 Duo mobile processor
 - Mobile Intel® GM975/PM975 Express Chipset
 - Intel® Wireless WiFi Link Wi-Fi CERTIFIED® network connection
 - Intel® PRO/Wireless Wi-Fi CERTIFIED® network connection

System Memory

- ❑ Dual-Channel DDR3 SDRAM support
- ❑ Up to 2 GB of DDR3 1066 MHz memory, upgradeable to 4 GB using two soDIMM modules

Display and graphics

- ❑ Mobile Intel® GM975/PM975 Express Chipset (for selected models)
- ❑ NVIDIA® GeForce® 9500M GS with 512MB of dedicated VRAM supporting TurboCache™ (for selected models)

TV-tuner

- ❑ Digital TV-tuner supporting DVB-T

Audio

- ❑ Dolby® -certified surround sound system with two built-in stereo speakers and one subwoofer supporting lowfrequency effects
- ❑ S/PDIF (Sony/Philips Digital Interface) support for digital speakers
- ❑ Built-in stereo microphones

Storage subsystem

- ❑ 2.5" hard disk drive
- ❑ Optical drive options:
 - Blu-ray Disc™ (BD) drive (for selected models)
 - DVD-Super Multi double-layer drive
- ❑ 6-in-1 card reader

Input devices

- ❑ 88-/89-key keyboard
- ❑ Touchpad pointing device
- ❑ Acer CineDash media console capacitive human interface device, including: capacitive human interface device

Communication

- ❑ Acer Video Conference, featuring:
 - Integrated Acer Crystal Eye webcam
 - Acer Video Conference Manager software
 - Acer PureZone technology
 - Optional Acer Xpress VoIP phone
- ❑ WLAN: Intel® Wireless WiFi Link network connection or Intel® PRO/Wireless network connection
- ❑ WPAN: Bluetooth® 2.0+EDR
- ❑ LAN: Gigabit Ethernet, Wake-on-LAN ready
- ❑ Modem: 56K ITU V.92

I/O Ports

- ❑ ExpressCard™/54 slot
- ❑ 6-in-1 card reader (SD™, MMC, MMCplus™, MS, MS PRO, xD)
- ❑ Four USB 2.0 ports
- ❑ HDMI™ port with HDCP support (for selected models)
- ❑ Consumer infrared (CIR) port
- ❑ External display (VGA) port
- ❑ Headphone/speaker/line-out jack with S/PDIF support
- ❑ Microphone-in jack
- ❑ Line-in jack
- ❑ Ethernet (RJ-45) port
- ❑ Modem (RJ-11) port

NOTE: HDCP is acronym for High-bandwidth Digital Content Protection. An encryption system for enforcing digital rights management (DRM) over DVI and HDMI interfaces.

Environment

- ❑ Temperature:
 - operating: 5°C to 35°C
 - Non-operating: -20°C to 65°C
- ❑ Humidity (non-condensing):
 - operating: 20%~80%

NOTE: Non-operating: 20%~80%

System Block Diagram

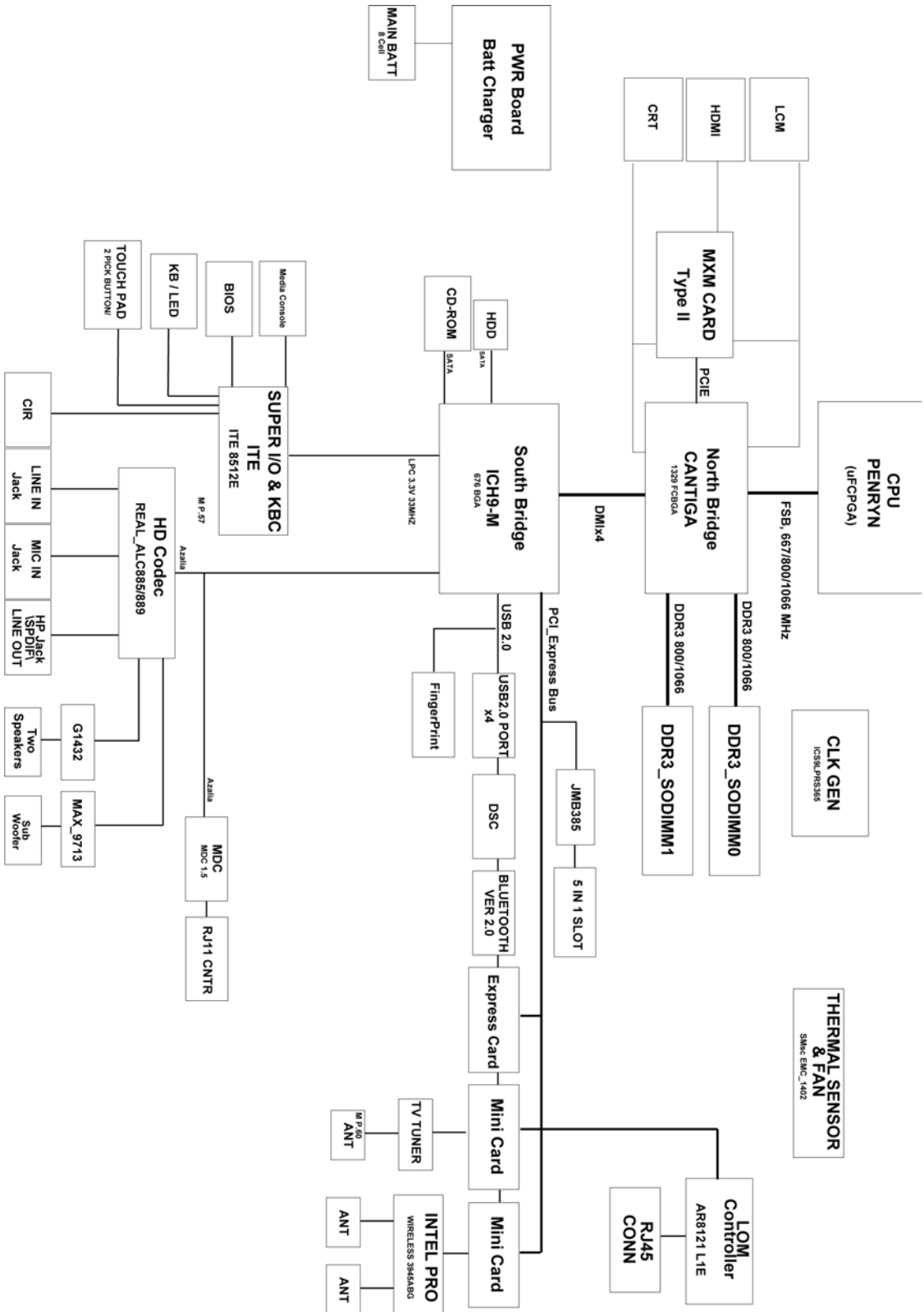

Board Layout

Top View

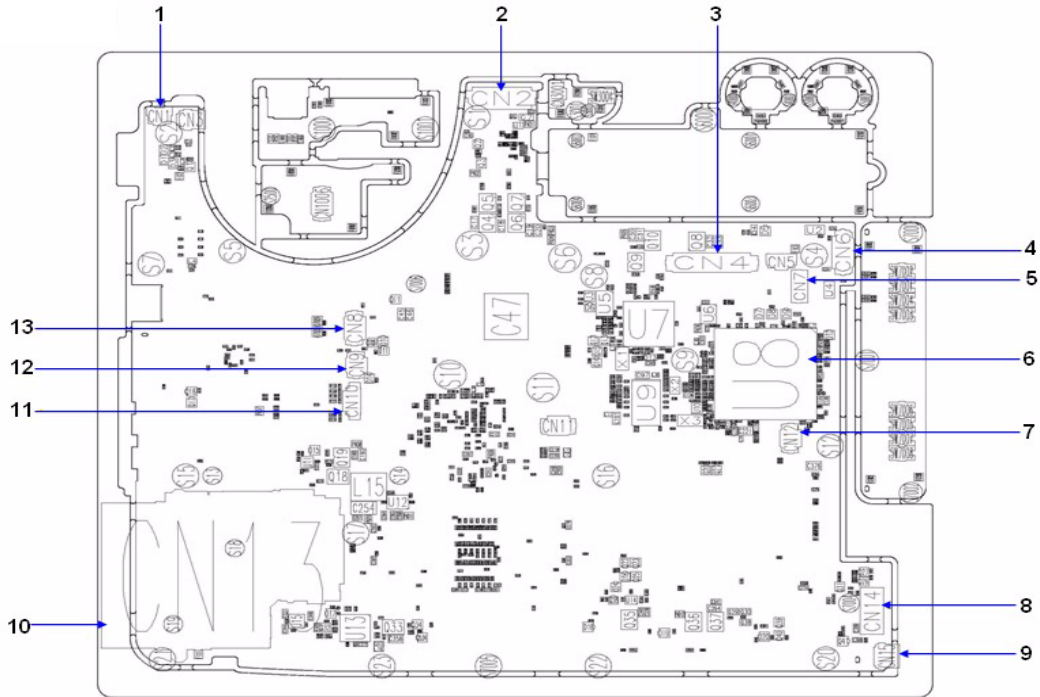

Aspire6935 M/B layout and connector location TOP view		
No.	Name	Description
1	CN1	LED/B Cable CNTR
2	CN2	LCM Cable CNTR
3	CN3	Key board FFC CNTR
4	CN4	USB board CNTR
5	CN7	Hot Key Board CNTR
6	U8	South Bridge
7	CN12	Touch Pad FFC CNTR
8	CN14	I/O Board CNTR
9	CN15	BT Cable CNTR
10	CN13	Express card CNTR
11	CN10	Speaker Cable CNTR
12	CN9	Media consle Board CNTR
13	CN8	Power Board FFC CNTR

Bottom view

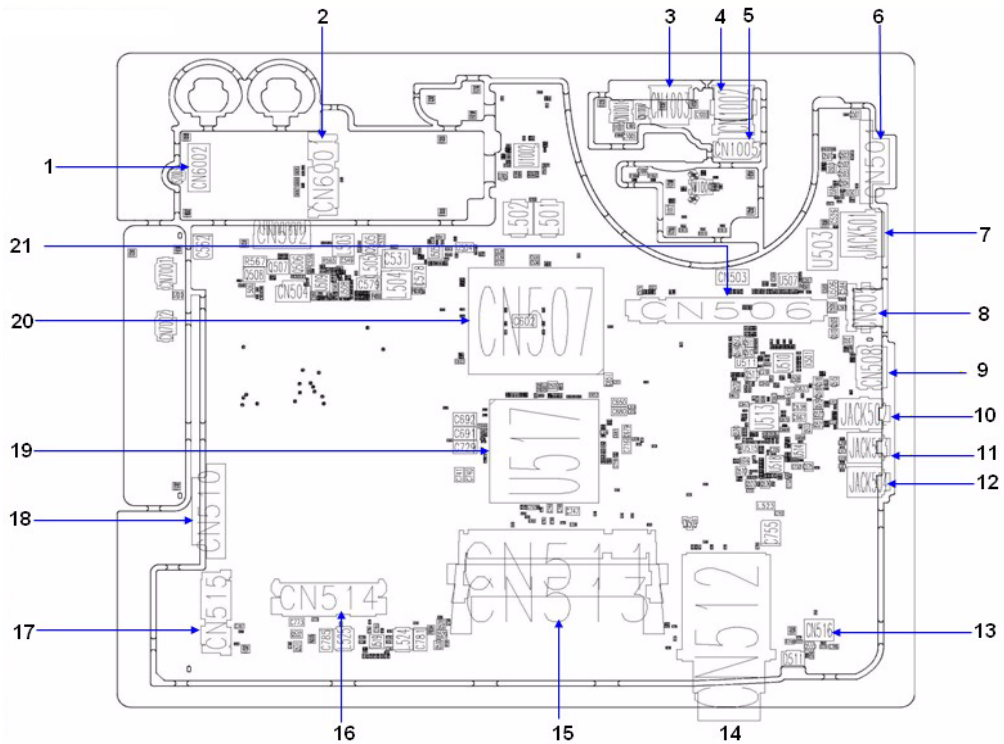

Bottom view		
No.	Name	Description
1	CN6002	W/LAN card board CNTR
2	CN6001	TV/Robson card CNTR
3	CN1003	USB Port
4	CN1002	USB Port
5	CN1005	USB Board CNTR
6	CN501	VGA Port
7	Jack501	RJ45
8	CN505	USB Port
9	CN508	HDMI Port
10	Jack502	SPDIF
11	Jack503	MIC jack
12	Jack504	Line in jack
13	CN516	MDC Card CNTR
14	CN512	New card Socket
15	CN511/513	DIMM Socket
16	CN514	HDD CNTR
17	CN515	PCI-E Socket
18	CN510	ODD CNTR
19	U517	North Bridge
20	CN507	CPU Socket
21	CN506	VGA Card Socket

Your Acer Notebook tour

After knowing your computer features, let us show you around your new Aspire computer.

Front View



No.	Icon	Item	Description
1		Acer Crystal Eye	Web camera for video communication.
2		Acer PureZone	Two internal stereo microphones for sound recording.
3		Display screen	Also called Liquid-Crystal Display (LCD), displays computer output.
4		Status indicators	Light-Emitting Diodes (LEDs) that light up to show the status of the computer's functions and components.
5		Power button	Turns the computer on and off.
6		CineDash media console	The CineDash media console is a touch-sensitive entertainment interface.
7		Keyboard	For entering data into your computer.
8		Palmrest	Comfortable support area for your hands when you use the computer.
9		Touchpad	Touch-sensitive pointing device which functions like a computer mouse.
10		Click buttons (left, center* and right)	The left and right buttons function like the left and right mouse buttons. *The center button serves as Acer BioProtect fingerprint reader supporting Acer FingerNav 4-way control function. (for selected models)
11		Status indicators	Light-Emitting Diodes (LEDs) that light up to show the status of the computer's functions and components.
12		Easy-launch button	Buttons for launching frequently used program.
13		Speakers	5.1 speakers deliver stereo audio output.
14		Empowering key	Launch Acer Empowering Technology.

Closed Front View



No.	Icon	Item	Description
1		CIR receiver	Receives signals from a remote control.
2		6-in-1 card reader	Accepts Secure Digital (SD), MultiMediaCard (MMC), MultiMediaCard Plus (MMCplus), Memory Stick (MS), Memory Stick Pro (MS PRO), xD-Picture Card.

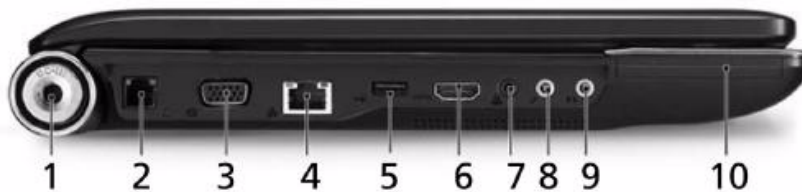

Left View



No.	Icon	Item	Description
1		DC-in jack	Connects to an AC adapter.
2		Modem (RJ-11) port	Connects to a phone line.
3		External display (VGA) port	Connects to a display device (e.g., external monitor, LCD projector).
4		Ethernet (RJ-45) port	Connects to an Ethernet 10/100-based network.
5	HDMI	Two USB 2.0 ports	Connect to USB 2.0 devices (e.g., USB mouse, USB camera).
6		HDMI	Supports high definition digital video connections (for selected models).
7		Headphones/speaker/line-out jack with S/PDIF support	Connects to audio line-out devices (e.g., speakers, headphones).
8		Microphone-in jack	Accepts input from external microphones.
9		Line-in jack	Accepts audio line-in devices (e.g., audio CD player, stereo walkman).
10		ExpressCard/54 skit	Accepts one ExpressCard/54 module.

Right View



No.	Icon	Item	Description
1		Optical drive	Internal optical drive; accepts CDs or DVDs.
2		Optical disk access indicator	Lights up when the optical drive is active.
3		Optical drive eject button	Ejects the optical disk from the drive.
4		Emergency eject hole	Ejects the optical drive tray when the computer is turned off.
5		3 USB 2.0 ports	Connect to USB 2.0 devices (e.g., USB mouse, USB camera).
6		TV-in port	Accepts input signals from analog/digital TV-tuner devices (for selected models).
7		Kensington lock slot	Connects to a Kensington-compatible computer security lock.





Rear View

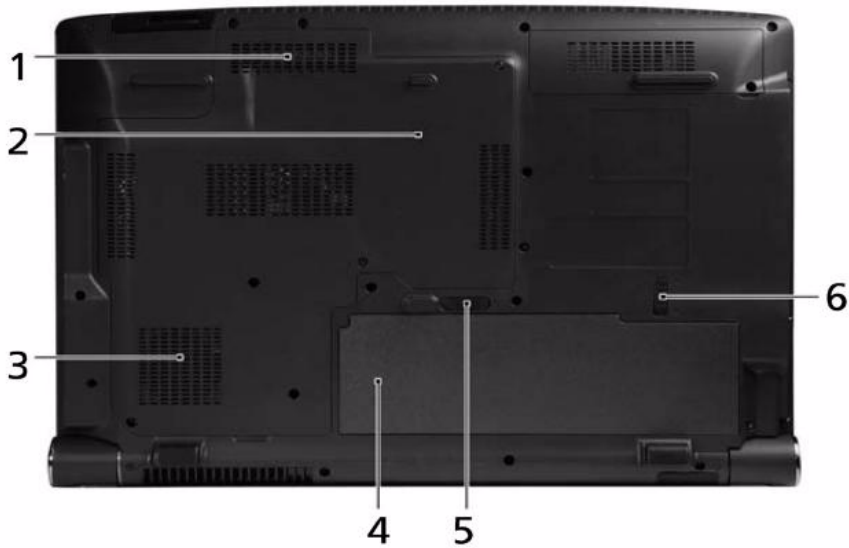

No.	Icon	Item	Description
1		Tuba	The dedicated Tuba CineBass subwoofer pumps out earthshaking movie-house audio.
2		Ventilation slots	Enable the computer to stay cool, even after prolonged use.

Base View







No.	Icon	Item	Description
1		Memory compartment	Houses the computer's main memory.
2		Hard disk bay	Houses the computer's hard disk (secured with screws).
3		Ventilation slots and cooling fan	Enable the computer to stay cool, even after prolonged use. Note: Do not cover or obstruct the opening of the fan.
4		Battery bay	Houses the computer's battery pack.
5		Battery release latch	Releases the battery for removal.
6		Battery lock	Locks the battery in position.

Indicators

The computer has several easy-to-read status indicators.



The front panel indicators are visible even when the computer cover is closed up.

No.	Icon	Item	Description
1		HDD	Indicates when the hard disk drive is active.
2		Num Lock	Lights up when Num Lock is activated.
3		Caps Lock	Lights up when Caps Lock is activated.
4		Power	Indicates the computer's power status.
5		Battery	Indicates the computer's battery status.

NOTE: 1. **Charging:** The light shows amber when the battery is charging.
2. **Fully charged:** The light shows green when in AC mode.

Easy-Launch Buttons

Located beside the keyboard are application buttons. These buttons are called easy-launch buttons. They are: WLAN, Internet, email, Bluetooth and Acer Empowering Technology.

The mail and Web browser buttons are pre-set to email and Internet programs, but can be reset by users. To set the Web browser, mail and programmable buttons, run the Acer Launch Manager.



No.	Icon	Item	Description
1		Empowering Technology	Launch Acer Empowering Technology. (user-programmable)
2		Wireless communication button/Indicator	Enable/disable the wireless function. Indicates the status of wireless LAN communication.
3		Web browser	Internet browser. (user-Programmable)
4		Mail	Email application. (user-Programmable)
5		Bluetooth communication button/indicator	Enable/disable the Bluetooth function. Indicates the status of Bluetooth communication.

Touchpad Basics

The following teaches you how to use the touchpad:

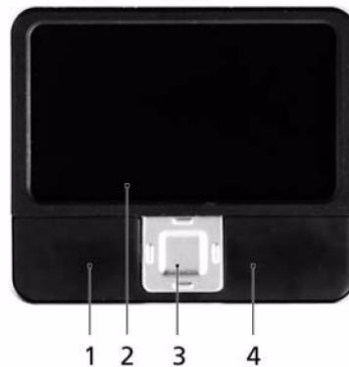

Move your finger across the touchpad (2) to move the cursor.

Press the left (1) and right (4) buttons located beneath the touchpad to perform selection and execution functions. These two buttons are similar to the left and right buttons on a mouse. Tapping on the touchpad is the same as clicking the left button.

Use the 4-way scroll (3) button to scroll up or down and move left or right a page. This button mimics your cursor pressing on the right scroll bar of Windows applications.

Function	Left Button (1)	Right Button (4)	Main touchpad (2)	Center button (3)
Execute	Quickly click twice		Tap twice (at the same speed as double-clicking a mouse button)	
Select	Click once		Tap once	
Drag	Click and hold, then use finger on the touchpad to drag the cursor		Tap twice (at the same speed as double-clicking a mouse button); rest your finger on the touchpad on the second tap and drag the cursor	
Access context menu		Click once		
Scroll				Swipe up/down/left/right using Acer FingerNav 4-way control function (for selected models) or click and hold to move up/down/left/right (for selected models)

NOTE: When using the touchpad, keep it - and your fingers - dry and clean. The touchpad is sensitive to finger movements; hence, the lighter the touch, the better the response. Tapping too hard will not increase the touchpad's responsiveness.

Using the Keyboard

The keyboard has full-sized keys and an embedded keypad, separate cursor keys, two Windows keys and twelve function keys.

Lock Keys and embedded numeric keypad

The keyboard has three lock keys which you can toggle on and off.

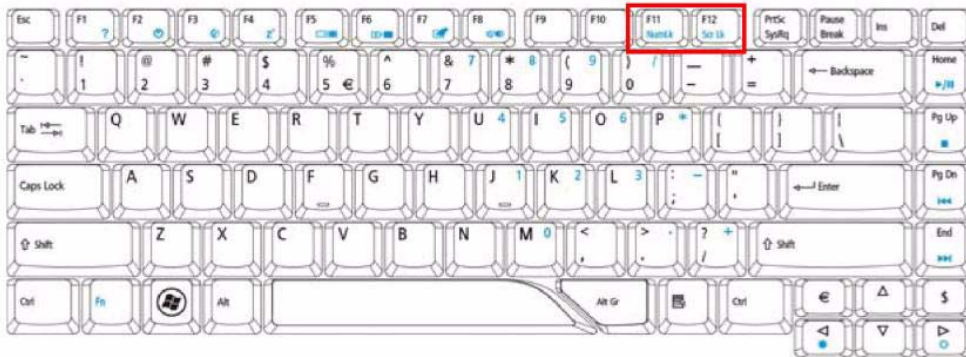



















Lock key	Description
Caps Lock	When Caps Lock is on, all alphabetic characters typed are in uppercase.
Num Lock <Fn> + <F11>	When Num Lock is on, the embedded keypad is in numeric mode. The keys function as a calculator (complete with the arithmetic operators +, -, *, and /). Use this mode when you need to do a lot of numeric data entry. A better solution would be to connect an external keypad.
Scroll Lock <Fn> + <F12>	When Scroll Lock is on, the screen moves one line up or down when you press the up or down arrow keys respectively. Scroll Lock does not work with some applications.

The embedded numeric keypad functions like a desktop numeric keypad. It is indicated by small characters located on the upper right corner of the keycaps. To simplify the keyboard legend, cursor-control key symbols are not printed on the keys.

Desired access	Num Lock on	Num Lock off
Number keys on embedded keypad	Type numbers in a normal manner.	
Cursor-control keys on embedded keypad	Hold <Shift> while using cursor-control keys.	Hold <Fn> while using cursor-control keys.
Main keyboard keys	Hold <Fn> while typing letters on embedded keypad.	Type the letters in a normal manner.

Windows Keys

The keyboard has two keys that perform Windows-specific functions.

Key	Description
 Windows key	<p>Pressed alone, this key has the same effect as clicking on the Windows Start button; it launches the Start menu. It can also be used with other keys to provide a variety of functions:</p> <ul style="list-style-type: none"> <  > : Open or close the Start menu <  > + <D>: Display the desktop <  > + <E>: Open Windows Explore <  > + <F>: Search for a file or folder <  > + <G>: Cycle through Sidebar gadgets <  > + <L>: Lock your computer (if you are connected to a network domain), or switch users (if you're not connected to a network domain) <  > + <M>: Minimizes all windows <  > + <R>: Open the Run dialog box <  > + <T>: Cycle through programs on the taskbar <  > + <U>: Open Ease of Access Center <  > + <X>: Open Windows Mobility Center <  > + <BREAK>: Display the System Properties dialog box <  > + <SHIFT+M>: Restore minimized windows to the desktop <  > + <TAB>: Cycle through programs on the taskbar by using Windows Flip 3-D <  > + <SPACEBAR>: Bring all gadgets to the front and select Windows Sidebar <CTRL> + <  > + <F>: Search for computers (if you are on a network) <CTRL> + <  > + <TAB>: Use the arrow keys to cycle through programs on the taskbar by using Windows Flip 3-D <p>Note: Depending on your edition of Windows Vista or Windows XP, some shortcuts may not function as described.</p>
 Application key	<p>This key has the same effect as clicking the right mouse button; it opens the application's context menu.</p>

Hot Keys

The computer employs hotkeys or key combinations to access most of the computer's controls like screen brightness, volume output and the BIOS utility.

To activate hotkeys, press and hold the <Fn> key before pressing the other key in the hotkey combination.

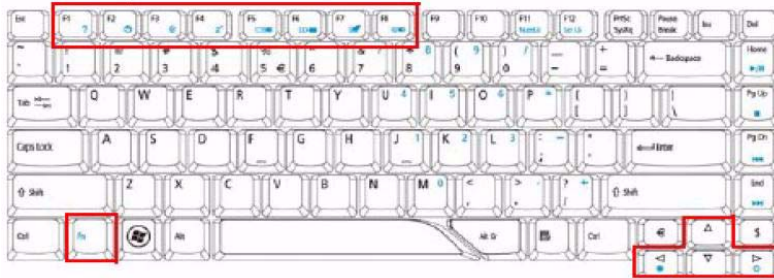

Hotkey	Icon	Function	Description
<Fn> + <F1>	?	Hotkey help	Displays help on hotkeys.
<Fn> + <F2>		Acer eSettings	Launches Acer eSettings in Acer Empowering Technology.
<Fn> + <F3>		Acer ePower Management	Launches Acer ePower Management in Acer Empowering Technology.
<Fn> + <F4>	Zz	Sleep	Puts the computer in Sleep mode.
<Fn> + <F5>		Display toggle	Switches display output between the display screen, external monitor (if connected) and both.
<Fn> + <F6>		Screen blank	Turns the display screen backlight off to save power. Press any key to return.
<Fn> + <F7>		Touchpad toggle	Turns the internal touchpad on and off.
<Fn> + <F8>		Speaker toggle	Turns the speakers on and off.
<Fn> + <->>		Brightness up	Increases the screen brightness.
<Fn> + <<->		Brightness down	Decreases the screen brightness.

Special Key

You can locate the Euro symbol and US dollar sign at the upper-center and/or bottom-right of your keyboard.
To type:

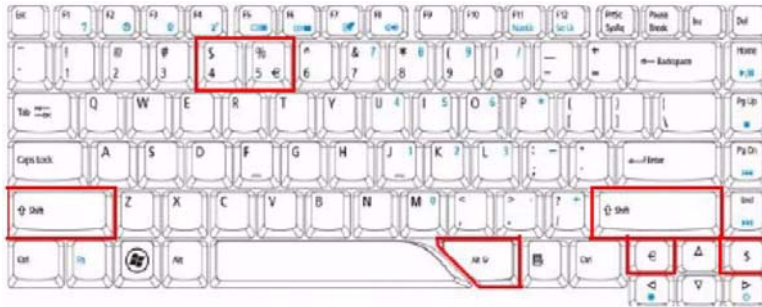

The Euro symbol

1. Open a text editor or word processor.
2. Either directly press the < € > symbol at the bottom-right of the keyboard, or hold <Alt Gr> and then press the <5> symbol at the upper-center of the keyboard.

NOTE: Some fonts and software do not support the Euro symbol. Please refer to www.microsoft.com/typography/faq/faq12.htm for more information.

The US dollar sign

1. Open a text editor or word processor.
2. Either directly press the < \$ > key at the bottom-right of the keyboard, or hold <Shift> and then press the <4> key at the upper-center of the keyboard.

NOTE: This function varies by the operating system version.

Acer Empowering Technology

Acer's innovative Empowering Technology makes it easy for you to access frequently used functions and manage your new Acer notebook. It features the following handy utilities:

- ❑ Acer eAudio Management allows you to easily control the enhanced sound effects of Dolby Home Theater on your system.
- ❑ Acer ePower Management optimizes battery usage via customizable power plans.
- ❑ Acer eDataSecurity Management protects data with passwords and encryption (for selected models).
- ❑ Acer eRecovery Management backs up and recovers data flexibly, reliably and completely.
- ❑ Acer eSettings Management accesses system information and adjusts settings easily.



For more information, press the < *e* > key to launch the Empowering Technology menu, then click on the appropriate utility and select the Help or Tutorial function.

Empowering Technology password

You must set the Empowering Technology password to use the password protection feature of Acer eRecovery Management to protect your data.

To set the Empowering Technology password:

1. Launch Acer eRecovery Management.
2. Click the Restore tab.
3. Click Password settings. The Empowering Technology Password Center dialog box pops up.
4. Click Create a new password.



5. In the Create a New Password dialog box, key in and confirm your password in the appropriate boxes. Your password should have a minimum of 4 and a maximum of 12 characters.
6. Enter a password hint that will help you remember your password.
7. Make sure the box Use for Acer eRecovery Management is checked.
8. Click OK to set the password.



Acer eAudio Management

Acer eAudio Management allows you to easily control the enhanced sound effects of Dolby Home Theater on your system. Select Movie or Game mode to experience the awesome realism of 5.1-channel audio output from the speakers fitted to your system via Dolby Surround sound technology. Music mode lets you enjoy your favorite tunes, in vivid detail.



To choose your playback device, click the icon on the upper right side of the Acer eAudio Management window.

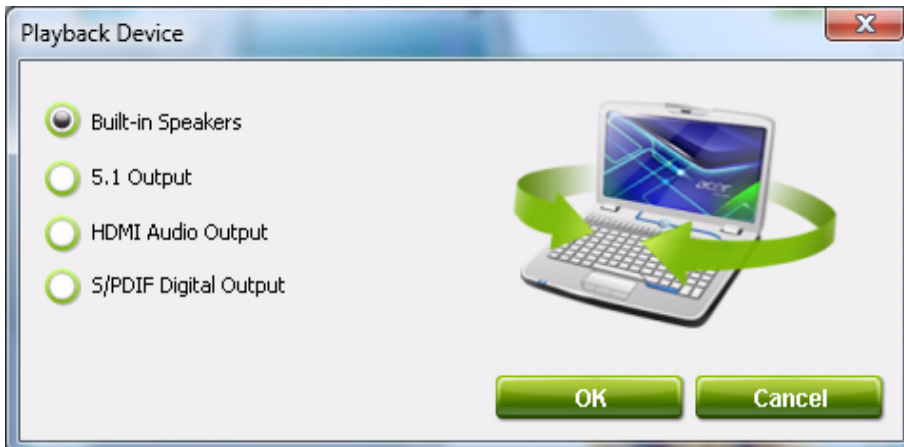

Acer ePower Management

Acer ePower Management features a straightforward user interface for configuring your power management options. To access this utility, select Acer ePower Management from the Empowering Technology toolbar, run the program from the Acer Empowering Technology program group in Start menu, or right-click the Windows power icon in the system tray and select Acer ePower Management.

AC Mode (Adapter mode)

The default setting is "Maximum Performance." You can adjust CPU speed, LCD brightness and other settings, or click on buttons to turn the following functions on/off: Wireless LAN, Bluetooth, CardBus, FireWire (1394), Wired LAN and Optical Device if supported.

DC Mode (Battery mode)

There are four pre-defined profiles - Entertainment, Presentation, Word Processing, and Battery Life. You can also define up to three of your own.

To create new power profile

1. Change power settings as desired.
2. Click "**Save as...**" to save to a new power profile.
3. Name the newly created profile.
4. Select whether this profile is for Adapter or Battery mode, then click **OK**.
5. The new profile will appear in the profile list.

Battery status

For real-time battery life estimates based on current usage, refer to the panel on the lower left-hand side of the window.



For additional options, click “**Settings**” to:

- Set alarms.
- Re-load factory defaults.
- Select what actions will be taken when the cover is closed or the power button is pressed.
- View information about Acer ePower Management.

Acer eDataSecurity Management (for selected models)

Acer eDataSecurity Management is an encryption utility that protects your files from being accessed by unauthorized persons. It is conveniently integrated with Windows Explorer as a shell extension for quick data encryption/decryption and also supports on-the-fly file encryption for Lotus Notes and Microsoft Outlook.

On first use, the Acer eDataSecurity Management setup wizard will prompt you to create the Master Password. You will use this password to access the Personal Secure Disk (PSD). The Master Password may also be used to encrypt/decrypt files by default.

If you set a different password to encrypt a file, but you forgot the encryption password, you can use the Master Password to decrypt the file.

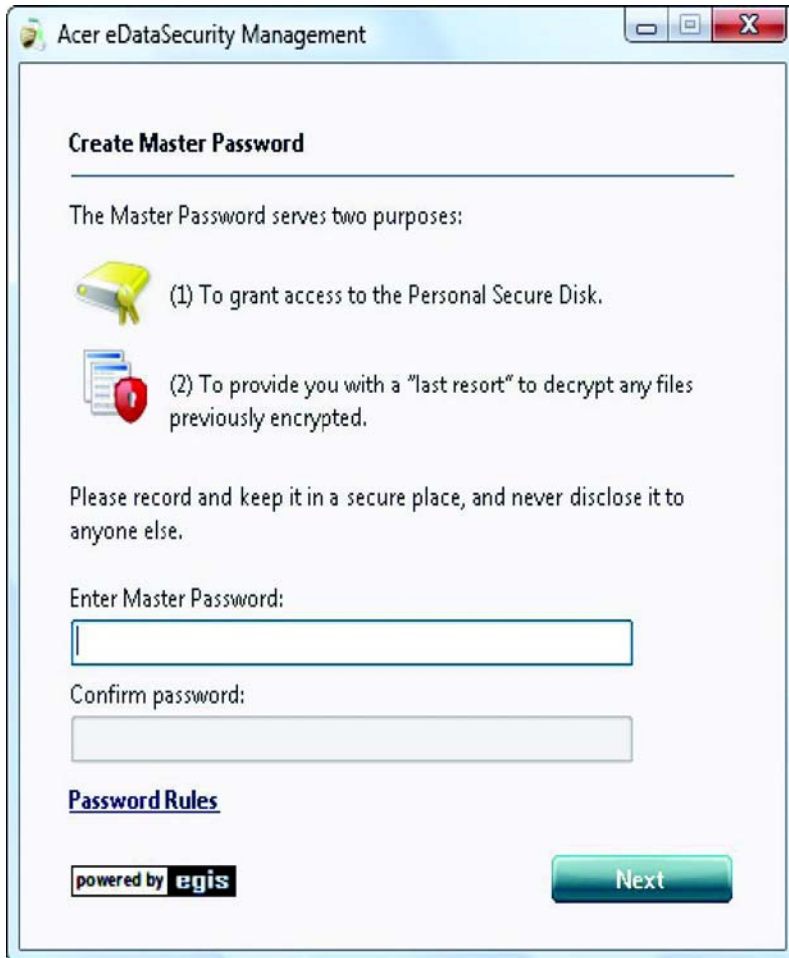

The screenshot shows a Windows-style dialog box titled "Acer eDataSecurity Management". The main heading is "Create Master Password". Below this, it explains the purpose of the Master Password: "The Master Password serves two purposes:" followed by two numbered points: (1) To grant access to the Personal Secure Disk (with a yellow folder icon) and (2) To provide you with a "last resort" to decrypt any files previously encrypted (with a red shield icon). A warning message states: "Please record and keep it in a secure place, and never disclose it to anyone else." There are two input fields: "Enter Master Password:" and "Confirm password:". Below the fields is a link for "Password Rules". At the bottom left, it says "powered by egis" and at the bottom right is a "Next" button.

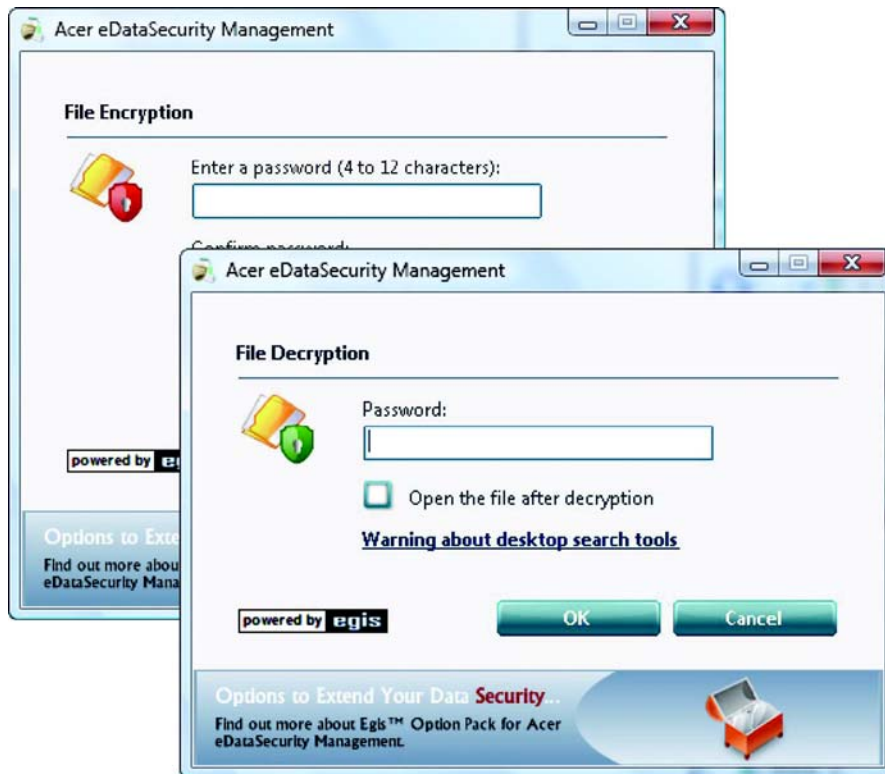

Acer eRecovery Management

Acer eRecovery Management is a versatile backup utility. It allows you to create full or incremental backups, burn the factory default image to optical disc, and restore from previously created backups or reinstall applications and drivers. By default, user-created backups are stored to the D:\ drive.

Acer eRecovery Management provides you with:

- ❑ Backup:
 - Back up factory default to CD/DVD
 - Back up drivers and applications to CD/DVD
 - Create user backup
 - Manage user backups
- ❑ Restore:
 - Restore system to factory default
 - Reinstall applications/drivers
 - Restore system from user backup
 - Password settings

To use the password protection feature of Acer eRecovery Management to protect your data, you must first set the Empowering Technology password. To set the password, refer to the section "Empowering Technology password".



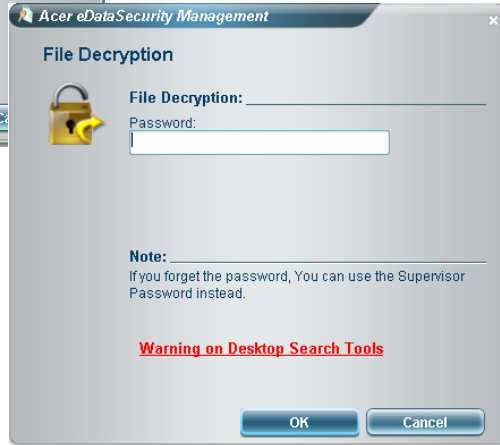

Windows Mobility Center

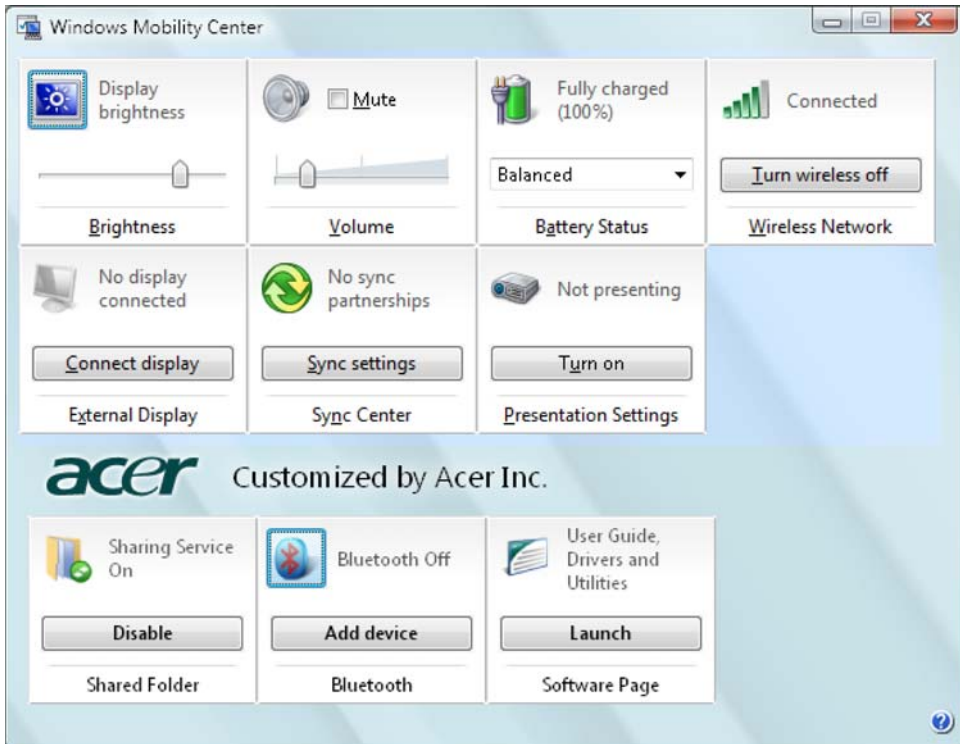

The Windows Mobility Center collects key mobile-related system settings in one easy-to-find place, so you can quickly configure your Acer system to fit the situation as you change locations, networks or activities. Settings include display brightness, volume, power plan, wireless networking on/off, external display settings, synchronization status and presentation settings.

Windows Mobility Center also includes Acer-specific settings like sharing folders overview/sharing service on or off, Bluetooth Add Device (if applicable), and a shortcut to the Acer user guide, drivers and utilities.

To launch Windows Mobility Center:

- Use the shortcut key < > + <X>.
- Start Windows Mobility Center from the Control panel.
- Start Windows Mobility Center from the Accessories program group in the Start menu.
- Launch Windows Mobility Center by right-clicking in the system tray and select Windows Mobility Center.

Using the System Utilities

NOTE: The system utilities work under Microsoft Windows XP only.

Acer GridVista (dual-display compatible)

NOTE: This feature is only available on certain models.

To enable the dual monitor feature of the notebook, first ensure that the second monitor is connected, then select **Start, Control Panel, Display** and click on **Settings**. Select the secondary monitor (**2**) icon in the display box and then click the check box **Extend my windows desktop onto this monitor**. Finally, click **Apply** to confirm the new settings and click **OK** to complete the process.

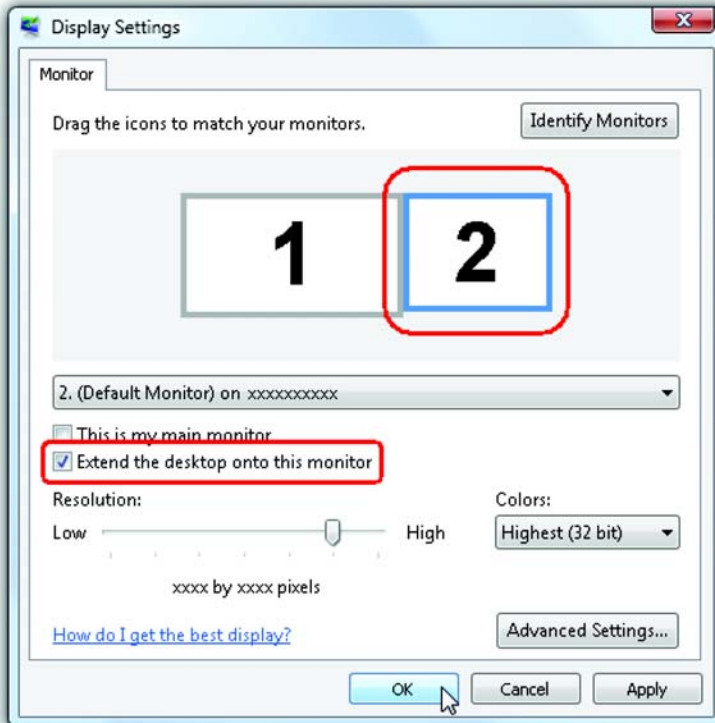

Acer GridVista is a handy utility that offers four pre-defined display settings so you can view multiple windows on the same screen. To access this function, please go to **Start>All Programs** and click on **Acer GridVista**. You may choose any one of the four display settings indicated below:

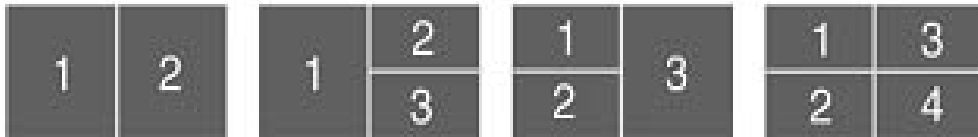

Double (verticle), Triple (primary at left), Triple (primary at right), or Quad Acer Gridvista is dual-display compatible, allowing two displays to be partitioned indepently.

Acer Gridvista is dual-display compatible, allowing two displays to be partitioned independently.

AcerGridVista is imple to set up:

1. Run Acer GridVista and select your preferred screen configuration for each display from the task bar.
2. Drag and drop each window into the appropriate grid.
3. Enjoy the convenience of a well-organized desktop.

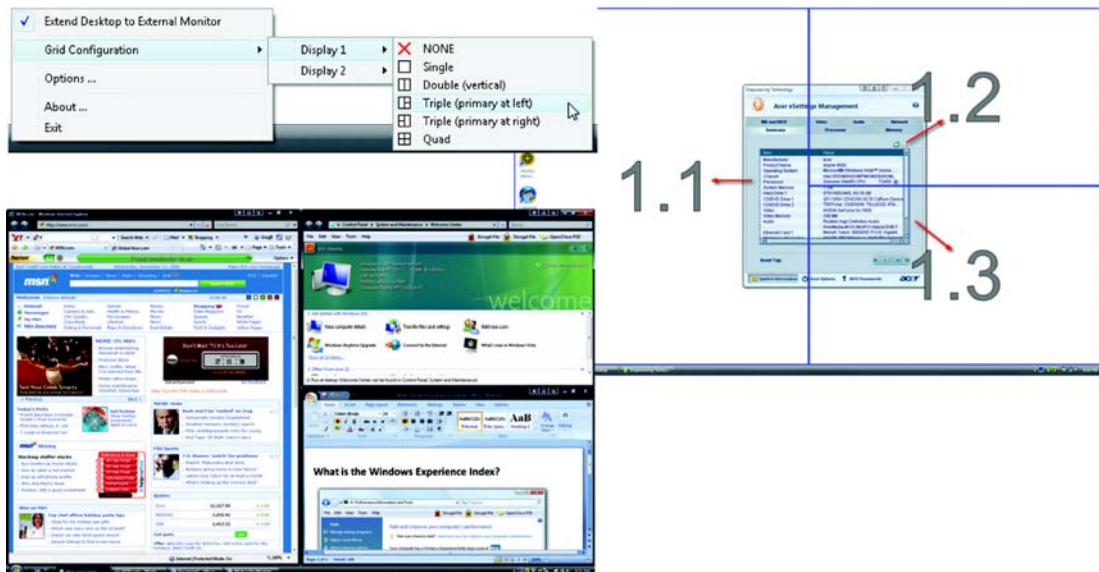

NOTE: Please ensure that the resolution setting of the second monitor is set to the manufacturer's recommended value.

Launch Manager

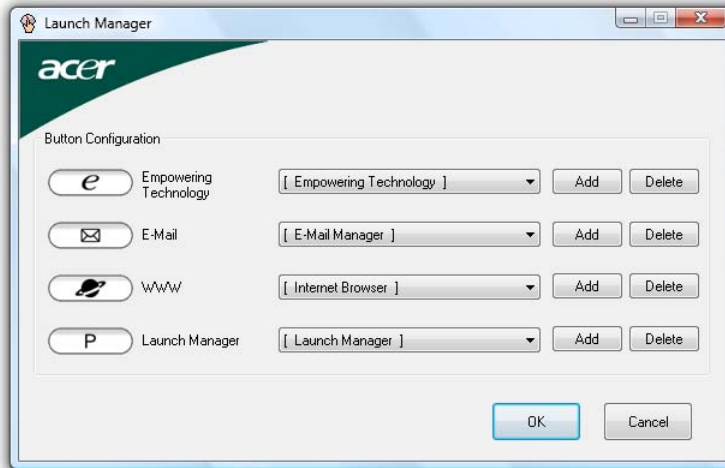

Launch Manager allows you to set the four easy-launch buttons located above the keyboard. You can access the Launch Manager by clicking on Start > All Programs > Launch Manager to start the application.

Hardware Specification and Configurations

Processor

Item	Specification
CPU type	Intel® Centrino® Duo mobile processor P7450/P8600/P8700/T6400/T6600/T9550 (Intel Penryn CPU) Note: you can also refer to AVLK for more details.
Clock Speeds	2.0GHz-2.66GHz
Front Side Bus	800MHz (for T6400/T6600)-1033MHz (for T9550/P7450/P8600/P8700/P9500)
Core logic	Intel 975PM/975GM + ICH8M
CPU package	uFCPGA, Socket P
CPU core voltage	0.944~1.3V

Processor Specification

#	CPU Speed	Cores	Bus Speed	Mfg Tech.	Cache Size	Package	Acer PN
P7450	2.0GHz	2	1066MHz	45nm	3MB	Micro-FCPGA	KC.74501.DPP
P8600	2.4GHz		1066MHz	45nm	3MB	Micro-FCPGA	KC.86R01.DPP
P8700	2.53GHz		1066MHz	45nm	3MB	Micro-FCPGA	KC.87R01.DPP
P9500	2.53GHz		1066MHz	45nm	6MB	Micro-FCPGA	KC.95001.DPP
T6400	2.0GHz		800MHz	45nm	3MB	Micro-FCPGA	KC.64001.DTP
T6600	2.2GHz		800MHz	45nm	2MB	Micro-FCPGA	KC.66001.DTP
T9550	2.66GHz		1066MHz	45nm	6MB	Micro-FCPGA	KC.95501.DTP

Second Level Cache

Item	Specification
Cache controller	Built-in CPU
Cache size	2 (for T6400) 3 (for P7450) 6MB
1st level cache control	Always enabled
2st level cache control	Always enabled
Cache scheme control	Fixed in write-back

System Memory

Item	Specification
Memory controller	Intel PM975 / Intel GM975
Memory size	0MB (no on-board memory)

Item	Specification
DIMM socket number	2 sockets
Supports memory size per socket	2GB
Supports maximum memory size	4GB
Supports DIMM type	DDR3 Synchronous DRAM
Supports DIMM Speed	1066 MHz
Supports DIMM voltage	1.8V and 0.9V
Supports DIMM package	200-pin soDIMM

Lan Interface

Item	Specification
Chipset	ATHEROS_AR8121
Supports LAN protocol	10/100/1000 Ethernet
PCI-E Giga	
LAN connector type	RJ45
LAN connector location	Left side
Features	Integrated 10/100/1000 BASE-T transceiver

Modem Interface

Item	Specification
Data modem data baud rate (bps)	56K
Supports modem protocol	V.92
Modem connector type	RJ11
Modem connector location	Left side

Bluetooth Interface

Item	Specification
Chipset	Built-in ICH8M
Data throughput	723 bps (full speed data rate)
Protocol	Bluetooth 1.1 (Upgradeable to Bluetooth 1.2 when SIG specification is ratified).
Interface	USB 2.0
Connector type	USB

Hard Disk Drive Interface

Item	Specification	Specification	Specification
Vendor & Model Name	<ul style="list-style-type: none"> • HGST HTS541680J9SA00 • WD WD800BEVS-22RST0 	<ul style="list-style-type: none"> • Seagate ST9120822AS • Toshiba MK1237GSX • HGST HTS541612J9SA00 • WD WD1200BEVS-22RST0 	<ul style="list-style-type: none"> • TOSHIBA MK1637GSX • Seagate ST9120822AS • HGST HTS541616J9SA00 • WD WD1600BEVS-22RST0
Capacity (MB)	80000		
Bytes per sector	512		
Data heads	2		
4 for Toshiba and HGST	4		
Drive Format			
Disks	1		
Spindle speed (RPM)	5400 RPM		
Performance Specifications			
Buffer size	8M		
Interface	SATA		
Max. media transfer rate (disk-buffer, Mbytes/s)	100, 150		
Data transfer rate (host~buffer, Mbytes/s)			
Ultra DMA mode-5	100 MB/Sec.		
DC Power Requirements			
Voltage tolerance	5V(DC) +/- 5%		

DVD-Super Multi Interface

Item	Specification
Vendor & model name	TOSHIBA 8X TS-L632D PHILIPS 8X DS-8A1P HLDS 8X GSA-T20N
Performance Specification	With CD Diskette
Transfer rate (KB/sec)	Sustained:Max 3.6Mbytes/sec Sustained:Max 10.8Mbytes/sec
Buffer Memory	2MB
Interface	Enhanced IDE(ATAPI) compatible
Applicable disc format	

Item	Specification
Support disc formats	<ol style="list-style-type: none"> 1. Reads data in each CD-ROM, CD-ROM XA, CD-1, Video CD, CD-Extra and CD-Plus 2. Reads data in super Audio CD (SACD) Hybrid type 3. Reads standard CD-DA 4. Reads and writes CD-R discs 5. Reads and writes CD-RW and HSRW discs 6. Reads and writes US & US+RW 7. Reads data in each DVD-ROM and DVD-Dual 8. Reads and writes in each DVD-R (Ver. 2.0 for general), DVD-RW and DVD+R/RW (Ver1.1) 9. Reads and writes DVD+-R Dual 10. Reads and writes DVD-RAM
Loading mechanism	Load: Manual Release: (a) Electrical Release (Release Button) (b) Release by ATAPI command (c) Emergency Release
Power Requirement	
Input Voltage	5 V +/- 5 % (Operating)

Audio Interface

Item	Specification
Audio Controller	Realtek ALC889X
Audio onboard or optional	Built-in
Mono or Stereo	Stereo
Resolution	24 bit stereo full duplex
Compatibility	HD audio Interface; S/PDIF output for PCM or AC-3 content
Sampling rate	1Hz resolution VSR (Variable Sampling Rate)
Internal microphone	Yes
Internal speaker / Quantity	Yes/2(3W speakers)
Supports PnP DMA channel	DMA channel 0, DMA channel 1
Supports PnP IRQ	IRQ10, IRQ11

Video Interface

Item	Specification
Chipset	Acer MXM compatible

USB Port

Item	Specification
Chipset	Built-in ICH8M
USB Compliancy Level	2
OHCI	USB 1.1 and USB 2.0 Host controller
Number of USB port	4
Location	One on the left side; three on the right side
Serial port function control	Enable/Disable by BIOS Setup

Express Card Interface

Item	Specification
Express card controller	Built-in ICH8M
Supports card type	75mmx54mm(W)x5mm
Number of slots	One
Access location	Left Side
Interface	PCI Express

System Board Major Chips

Item	Specification
Core logic	Intel PM975/GM975 + ICH8M
VGA	Acer MXM compatible
LAN	ATHEROS_AR8121
USB 2.0	Built in ICH8M
CardReader	Jmicro JMB385
MODEM	Foxconn T60M951
Bluetooth	Foxconn T60H928.01
Wireless 802.11 a+b+g	Built-in ICH8-M
Audio	Realtek ALC889X

Keyboard

Item	Specification
Keyboard controller	ITE 8512E
Total number of keypads	88-/89-key
Windows logo key	Yes
Internal & external keyboard work simultaneously	Plug USB keyboard to the USB port directly: Yes

Battery

Item	Specification
Vendor & Model Name	BATTERY PACK SANYO LI-ION 8 CELL2.4, 4800MAH BATTERY PACK SONY LI-ION 8CELL2.4, 4800MAH
Battery Type	Li-ion
Pack capacity	4800 mAh
Number of battery cell	8 cell
Package configuration	4 cells in series, 2 series in parallel
Normal voltage	14.8V
Charge voltage	16.8+-0.2V

LCD 16.0" inch

Item	Specification
Vendor & model name	Samsung LTN160AT01-A01
Screen Diagonal (mm)	16.0 inches
Active Area (mm)	353.45(H) x 198.72(V) mm
Display resolution (pixels)	1366x768 WXGA
Pixel Pitch	0.25875 (H) x 0.25875(V) mm
Pixel Arrangement	R.G.B. Vertical Stripe
Display Mode	Normally White
Typical White Luminance (cd/m2) also called Brightness	300
Luminance Uniformity	N/A
Contrast Ratio	600
Response Time (Optical Rise Time/Fall Time)msec	8
Nominal Input Voltage VDD	+3.3V
Typical Power Consumption (watt)	4.5W
Weight(g)	550g
Physical Size(mm)	365x214x6.5
Electrical Interface	Dual channel LVDS
Support Color	262,144

Item	Specification
Viewing Angle (degree)	
Horizontal: Right/Left	65/65
Vertical: Upper/Lower	50/50
Temperature Range(°C)	
Operating	0 to +50
Storage (shipping)	-20 to +60

LCD Inverter

Item	Specification
Vendor & model name	TDK
Brightness conditions	N/A
Input voltage (V)	9~20V
Input current (mA)	360mA (max)
Output voltage (V, rms)	710V (1800V for kick off)
Output current (mA, rms)	6.5mA (max)
Output voltage frequency (k Hz)	58 KHz (max)

AC Adaptor

Item	Specification
Input rating	100V AC to 240V AC, 47Hz to 63Hz
Maximum input AC current	1.5A
Inrush current	50A@115VAC 100A@230VAC
Efficiency	85% min. @115VAC input full load

System Power Management

ACPI mode	Power Management
Mech. Off (G3)	All devices in the system are turned off completely
Soft Off (G2/S5)	OS initiated shutdown. All devices in the system are turned off completely
Working (G0/S0)	Individual devices such as the CPU and hard disc may be power managed in this state
Suspend to RAM (S3)	CPU set power down VGA Suspend PCMCIA Suspend Audio Power Down Hard Disk Power Down CD-ROM Power Down Super I/O Low Power mode
Save to Disk (S4)	Also called Hibernation Mode. System saves all system states and data onto the disc prior to power off the whole system

System Utilities

BIOS Setup Utility

The BIOS Setup Utility is a hardware configuration program built into your computer's BIOS (Basic Input/Output System).

Your computer is already properly configured and optimized, and you do not need to run this utility. However, if you encounter configuration problems, you may need to run Setup. Please also refer to Chapter 4 Troubleshooting when problem arises.

To activate the BIOS Utility, press **m** during POST (when "Press <F2> to enter Setup" message is prompted on the bottom of screen).

Press **m** to enter setup. The default parameter of F12 Boot Menu is set to "disabled". If you want to change boot device without entering BIOS Setup Utility, please set the parameter to "enabled".

Press <F12> during POST to enter multi-boot menu. In this menu, user can change boot device without entering BIOS SETUP Utility.

InsydeH2O Setup Utility		Rev. 3.0
Information	Main	Advanced Security Boot Exit
CPU Type:	Genuine Intel(R) CPU	
CPU Speed:	T2300 @ 1.66GHz	
IDE 0 Model Name: <i>(Note1)</i>	ST960821A-(PM)	
IDE0 Serial Number: <i>(Note1)</i>	3LF005DB	
ATAPI Model Name:	MATSHITADVD	
ATAPI Serial Number:		
System BIOS Version:	V1.00	
VGA BIOS Version:	ATI V008.050I.0-26.00	
Serial Number:	xxxxxxxxxxxxxxxxxxxx (Max: 22 Byte)	
Asset Tag Number:	xxxxxxxxxxxxxxxxxxxx (Max: 32 Byte)	
Product Name:	xxxxxxxxxxxxxxxxxxxx (Max: 16 Byte)	
Manufacturer Name:	Acer	
UUID:	xxxxxxxxxxxxxxxxxxxx (Max: 16 Byte)	
F1 Help	↑↓ Select Item	F5/F6 Change Values F9 Setup defaults
Esc Exit	←→ Select Menu	Enter Select ▸ Sub-Menu F10 Save and Exit

Invoking BIOS Setup

The setup function can only be invoked by pressing F2 when Press <F2> to enter Setup message is prompted on the bottom of screen during POST.

The setup uses a menu driven interface to allow the user to configure their system. The features are divided into 6 parts as follows:

Information	Display the system informations.
Main	Allows the user to specify standard IBM PC AT system parameters.
Advanced	Provides advanced settings of the system.
Security	Provides security settings of the system.
Boot	Allows the user to specify the boot options.
Exit	Allows the user to save CMOS setting and exit Setup.

NOTE: You can change the value of a parameter if it is enclosed in square brackets. Navigation keys for a particular menu are shown on the bottom of the screen. Help for parameters are found in the Item Specific Help part of the screen. Read this carefully when making changes to parameter values.

NOTE: Please note that system information is subject to different models.

Information

InsydeH2O Setup Utility		Rev. 3.0
Information	Main	Advanced
	Security	Boot
		Exit
CPU Type:	Genuine Intel(R) CPU	
CPU Speed:	T2300 @ 1.66GHz	
IDE 0 Model Name: <i>(Note1)</i>	ST960821A-(PM)	
IDE0 Serial Number: <i>(Note1)</i>	3LF005DB	
ATAPI Model Name:	MATSHITADVD	
ATAPI Serial Number:		
System BIOS Version:	V1.00	
VGA BIOS Version:	ATI V008.050I.0-26.00	
Serial Number:	xxxxxxxxxxxxxxxxxxxx (Max: 22 Byte)	
Asset Tag Number:	xxxxxxxxxxxxxxxxxxxx (Max: 32 Byte)	
Product Name:	xxxxxxxxxxxxxxxxxxxx (Max: 16 Byte)	
Manufacturer Name:	Acer	
UUID:	xxxxxxxxxxxxxxxxxxxx (Max: 16 Byte)	

F1	Help	↑↓	Select Item	F5/F6	Change Values	F9	Setup defaults
Esc	Exit	←→	Select Menu	Enter	Select	▶	Sub-Menu
				F10			Save and Exit

NOTE: The system information is subject to different models.

ParameterItem	Description
CPU Type	This field shows the CPU type and speed of the system.
IDE1 Model Name	This field shows the model name of HDD installed on primary IDE master.
IDE1 Serial Number	This field displays the serial number of HDD installed on primary IDE master.
IDE2I Model Name	This field displays the mofel name of devices installed on secondary IDE master. The hard disk drive or optical drive model name is automatically detected by the system.
IDE2 Serial Number	This field shows the serial number of devices installed on secondary IDE master.
System BIOS ver	Displays system BIOS version.
VGA BIOS Ver	This field displays the VGA firmware version of the system.
KBC Ver	This field shows the keyboard
Serial Number	This field displays the serial number of this unit.
Asset Tag Number	This field displays the asset tag number of the system.
Product Name	This field shows product name of the system.
Manufacturer Name	This field displays the manufacturer of this system.
UUID Number	This will be visible only when an internal LAN device is presenting. UUID=32bytes

Main

The Main screen displays a summary of your computer hardware information, and also includes basic setup parameters. It allows the user to specify standard IBM PC AT system parameters.

InsydeH2O Setup Utility		Rev. 3.0
Information	Main	Advanced Security Boot Exit
System Time:	[09:00:00]	Item specific Help <Tab>, <Shift-Tab>, or <Enter> selects field
System Date:	[01/01/2003]	
Total Memory	[xxxxMB]	
Video Memory:	[8MB] <i>(note2)</i>	
Quiet Boot:	[Enabled]	
Network boot:	[Enabled]	
F12 Boot Menu:	[Disabled]	
D2D Recovery:	[Enabled]	
F1 Help ↑↓ Select Item F5/F6 Change Values F9 Setup defaults Esc Exit ←→ Select Menu Enter Select ▶ Sub-Menu F10 Save and Exit		

NOTE: The screen above is for your reference only. Actual values may differ.

The table below describes the parameters in this screen. Settings in **boldface** are the default and suggested parameter settings.

Parameter	Description	Format/Option
System Time	Sets the system time. The hours are displayed with 24-hour format.	Format: HH:MM:SS (hour:minute:second) System Time
System Date	Sets the system date.	Format MM/DD/YYYY (month/day/year) System Date
System Memory	This field reports the memory size of the system. Memory size is fixed to 640MB.	
Extended Memory	This field reports the memory size of the extended memory in the system. Extended Memory size=Total memory size-1MB.	
VGA Memory	Shows the VGA memory size. VGA Memory size=64/128MB.	
Quiet Boot	Determines if Customer Logo will be displayed or not; shows Summary Screen is disabled or enabled. Enabled: Customer Logo is displayed, and Summary Screen is disabled. Disabled: Customer Logo is not displayed, and Summary Screen is enabled.	Option: Enabled or Disabled
Power on display	Auto: During power process, the system will detect if any display device is connected on external video port. If any external display device is connected, the power on display will be in CRT (or projector) only mode. Otherwise it will be in LCD only mode. Both: Simultaneously enable both the integrated LCD screen and the system's external video port (for an external CRT or projector).	Option: Auto or Both
Network Boot	Enables, disables the system boot from LAN (remote server).	Option: Enabled or Disabled
F12 Boot Menu	Enables, disables Boot Menu during POST.	Option: Disabled or Enabled
D2D Recovery	Enables, disables D2D Recovery function. The function allows the user to create a hidden partition on hard disc drive to store operation system and restore the system to factory defaults.	Option: Enabled or Disabled

NOTE: The sub-items under each device will not be shown if the device control is set to disable or auto. This is because the user is not allowed to control the settings in these cases.

Advanced

The Advanced screen displays advanced settings in BIOS.

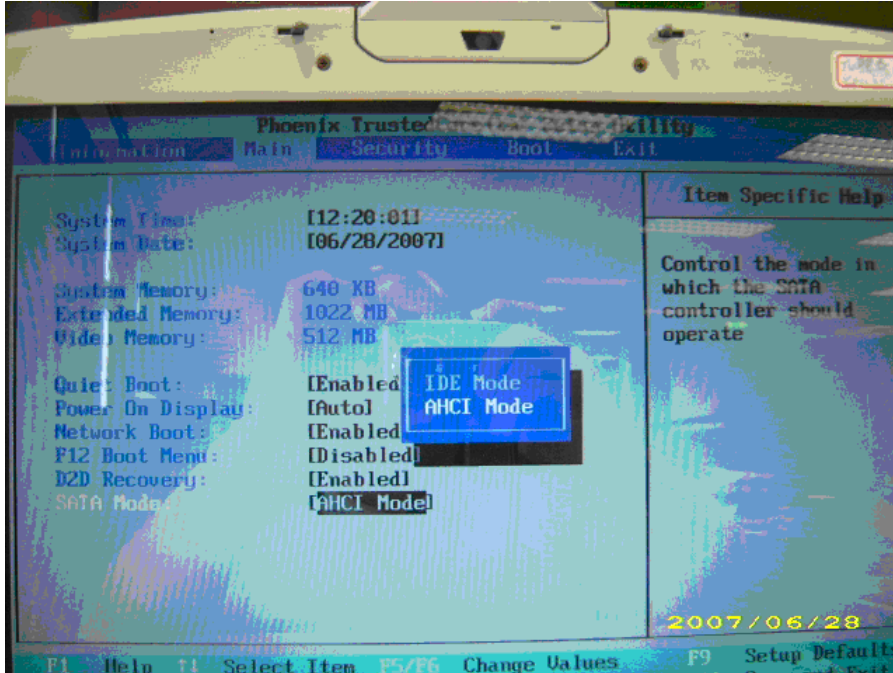

The table below describes the parameters in this screen. Settings in **boldface** are the default and suggested parameter settings.

Parameter	Description	Format/Option
Serial port	Displays the settings of the serial port	Enabled or Disabled
Parallel port	Shows the settings of the parallel port	Enabled or Disabled

Security

The Security screen contains parameters that help safeguard and protect your computer from unauthorized use.

InsydeH2O Setup Utility		Rev. 3.0			
Information.	Main	Advanced	Security	Boot	Exit
		Item specific Help			
Supervisor Password Is	Clear	Supervisor Password controls access to the whole setup utility. It can be used to boot up when Password on boot is enabled.			
User Password Is	Clear				
HDD Password	Clear				
Set Supervisor Password	[Enter]				
Set User Password	[Enter]				
Set HDD Password	[Enter]				
Password on Boot:	[Disabled]				
F1 Help ↑↓ Select Item F5/F6 Change Values F9 Setup defaults Esc Exit ←→ Select Menu Enter Select ▶ Sub-Menu F10 Save and Exit					

The table below describes the parameters in this screen. Settings in **boldface** are the default and suggested parameter settings.

Parameter	Description	Format/Option
User Password is	Shows the setting of the user password.	Clear or Set
Supervisor Password is	Shows the setting of the Supervisor password.	Clear or Set
Set User Password	Press Enter to set the user password. When user password is set, this password protects the BIOS Setup Utility from unauthorized access. The user can enter Setup menu only and does not have right to change the value of parameters.	
Set Supervisor Password	Press Enter to set the supervisor password. When set, this password protects the BIOS Setup Utility from unauthorized access. The user can not either enter the Setup menu nor change the value of parameters.	
HardDisk Security	Enables or disables primary hard disk security function.	
Password on Boot	Defines whether a password is required or not while the events defined in this group happened. The following sub-options are all requires the Supervisor password for changes and should be grayed out if the user password was used to enter setup.	Disabled or Enabled

NOTE: When you are prompted to enter a password, you have three tries before the system halts. Don't forget your password. If you forget your password, you may have to return your notebook computer to your dealer to reset it.

Setting a Password

Follow these steps as you set the user or the supervisor password:

1. Use the **w** and **y** keys to highlight the Set Supervisor Password parameter and press the **e** key. The Set Supervisor Password box appears:

Set Supervisor Password		
Enter New Password	[]
Confirm New Password	[]

2. Type a password in the "Enter New Password" field. The password length can not exceeds 8 alphanumeric characters (A-Z, a-z, 0-9, not case sensitive). Retype the password in the "Confirm New Password" field.

IMPORTANT: Be very careful when typing your password because the characters do not appear on the screen.

3. Press **e**.
After setting the password, the computer sets the User Password parameter to "Set".
4. If desired, you can opt to enable the Password on boot parameter.
5. When you are done, press **u** to save the changes and exit the BIOS Setup Utility.

Removing a Password

Follow these steps:

1. Use the **w** and **y** keys to highlight the Set Supervisor Password parameter and press the **e** key. The Set Password box appears:

Set Supervisor Password		
Enter current password	[]
Enter New Password	[]
Confirm New Password	[]

2. Type the current password in the Enter Current Password field and press **e**.
3. Press **e** twice **without** typing anything in the Enter New Password and Confirm New Password fields. The computer then sets the Supervisor Password parameter to "Clear".
4. When you have changed the settings, press **u** to save the changes and exit the BIOS Setup Utility.

Changing a Password

1. Use the **w** and **y** keys to highlight the Set Supervisor Password parameter and press the **e** key. The Set Password box appears:

Set Supervisor Password		
Enter current password	[]
Enter New Password	[]
Confirm New Password	[]

2. Type the current password in the Enter Current Password field and press **e**.
3. Type a password in the Enter New Password field. Retype the password in the Confirm New Password field.
4. Press **e**. After setting the password, the computer sets the User Password parameter to "Set".
5. If desired, you can enable the Password on boot parameter.
6. When you are done, press **u** to save the changes and exit the BIOS Setup Utility.

If the verification is OK, the screen will display as following.

Setup Notice
Changes have been saved.
[continue]

The password setting is complete after the user presses **u**.

If the current password entered does not match the actual current password, the screen will show you the Setup Warning.

Setup Warning
Invalid password
Re-enter Password
[continue]

If the new password and confirm new password strings do not match, the screen will display the following message.

Setup Warning
Password do not match
Re-enter Password

Boot

This menu allows the user to decide the order of boot devices to load the operating system. Bootable devices includes the distette drive in module bay, the onboard hard disk drive and the CD-ROM in module bay.

InsydeH2O Setup Utility				Rev. 3.0	
Information	Main	Advanced	Security	Boot	Exit
Boot priority order: 1. IDE 0: ST960821A 2. IDE 1: MATSHITADVD 3. USB FDD: 4. Network Boot: Realtek Boot Agent 5. USB HDD: 6. USB KEY: 7. USB CDROM:			Item specific Help Use <↑> or <↓> to select a device, then press <F6> to move it up the List, or <F5> to move it down the list. Press <Esc> to escape the menu		
F1	Help	↑↓ Select Item	F5/F6 Change Values	F9	Setup defaults
Esc	Exit	←→ Select Menu	Enter Select ▸ Sub-Menu	F10	Save and Exit

Exit

The Exit screen contains parameters that help safeguard and protect your computer from unauthorized use.

InsydeH2O Setup Utility		Rev. 3.0			
Information	Main	Advanced	Security	Boot	Exit
<p>Exit Saving Changes</p> <p>Exit Discarding Changes</p> <p>Load Setup Defaults</p> <p>Discard changes</p> <p>Save changes</p>		<p>Item specific Help</p> <p>Exit System Setup and save your Changes</p> <p>Exit utility without saving Setup Data</p> <p>Load default values for all SETUP item.</p>			
<p>F1 Help ↑↓ Select Item F5/F6 Change Values F9 Setup defaults</p> <p>Esc Exit ←→ Select Menu Enter Select ▶ Sub-Menu F10 Save and Exit</p>					

The table below describes the parameters in this screen.

Parameter	Description
Exit Saving Changes	Exit System Setup and save your changes to CMOS.
Exit Discarding Changes	Exit utility without saving setup data to CMOS.
Load Setup Default	Load default values for all SETUP item.
Discard Changes	Load previous values from CMOS for all SETUP items.
Save Changes	Save Setup Data to CMOS.

BIOS Flash Utility

The BIOS flash memory update is required for the following conditions:

- New versions of system programs
- New features or options
- Restore a BIOS when it becomes corrupted

Use the Phlash utility to update the system BIOS flash ROM.

NOTE: If you do not have a crisis recovery diskette at hand, then you should create a **Crisis Recovery Diskette** before you use the Phlash utility.

NOTE: Do not install memory-related drivers (XMS, EMS, DPMS) when you use the Phlash.

NOTE: Please use the AC adaptor power supply when you run the Phlash utility. If the battery pack does not contain enough power to finish BIOS flash, you may not boot the system because the BIOS is not completely loaded.

Follow the steps below to run the Phlash.

1. Prepare a bootable diskette.
2. Copy the flash utilities to the bootable diskette.
3. Then boot the system from the bootable diskette. The flash utility has auto-execution function.

HDD unlock Utility

This section provide you with removing HDD password method.

Remove HDD Password:

If you key in wrong HDD password for three time, "HDD password error code" would display on the screen. See the image below.

If you need to solve HDD password locked problem, you can run unlock6.EXE



1. Key in "unlock6 error code 205"
2. Select "2"
3. Choose one HDD password

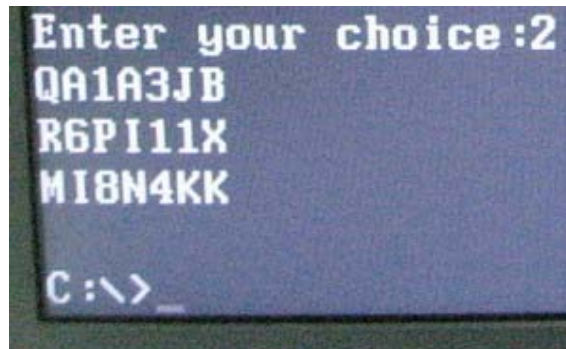

Reboot system and key in "R6PI11X" or "MI8N4KK" to HDD user password.

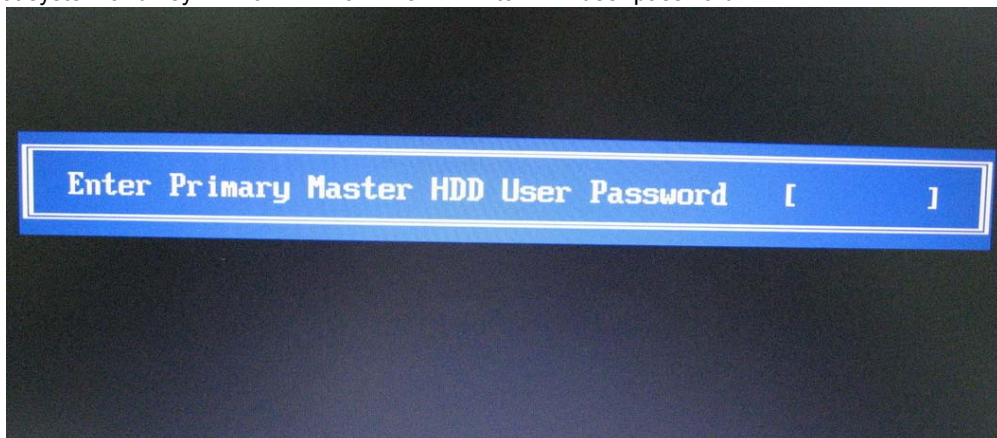

Then the HDD password will be unlocked and will auto into Windows after reboot.

Machine Disassembly and Replacement

This chapter contains step-by-step procedures on how to disassemble the notebook computer Aspire 6935G for maintenance and troubleshooting.

To disassemble the computer, you need the following tools:

- Wrist grounding strap and conductive mat for preventing electrostatic discharge
- Small Philips screw driver
- Philips screwdriver
- Plastic flat head screw driver
- Tweezers

NOTE: The screws for the different components vary in size. During the disassembly process, group the screws with the corresponding components to avoid mismatch when putting back the components. When you remove the stripe cover, please be careful not to scrape the cover.

General Information

Before You Begin

Before proceeding with the disassembly procedure, make sure that you do the following:

1. Turn off the power to the system and all peripherals.
2. Unplug the AC adapter and all power and signal cables from the system.
3. Remove the battery pack.

Disassembly Procedure Flowchart

The flowchart on the succeeding page gives you a graphic representation on the entire disassembly sequence and instructs you on the components that need to be removed during servicing. For example, if you want to remove the system board, you must first remove the keyboard, then disassemble the inside assembly frame in that order.

Main unit disassembly flow chart

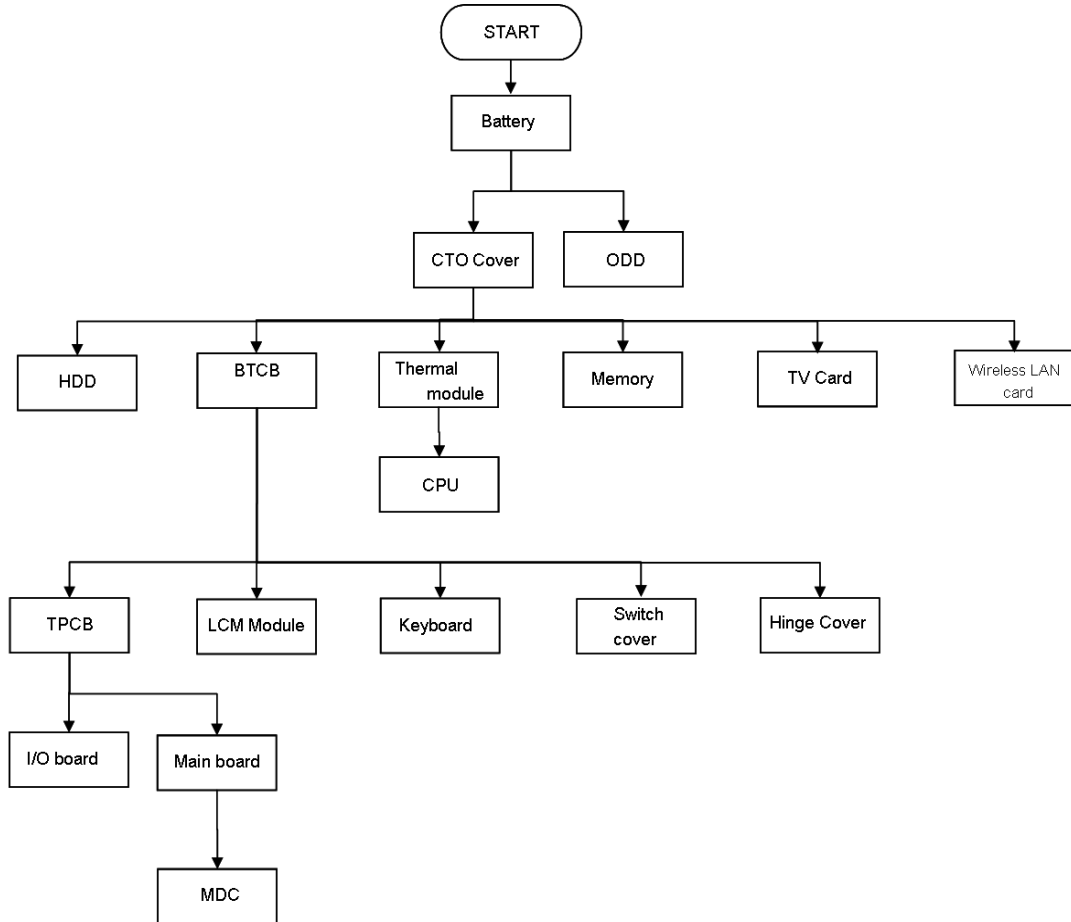

LCM module disassembly flow chart

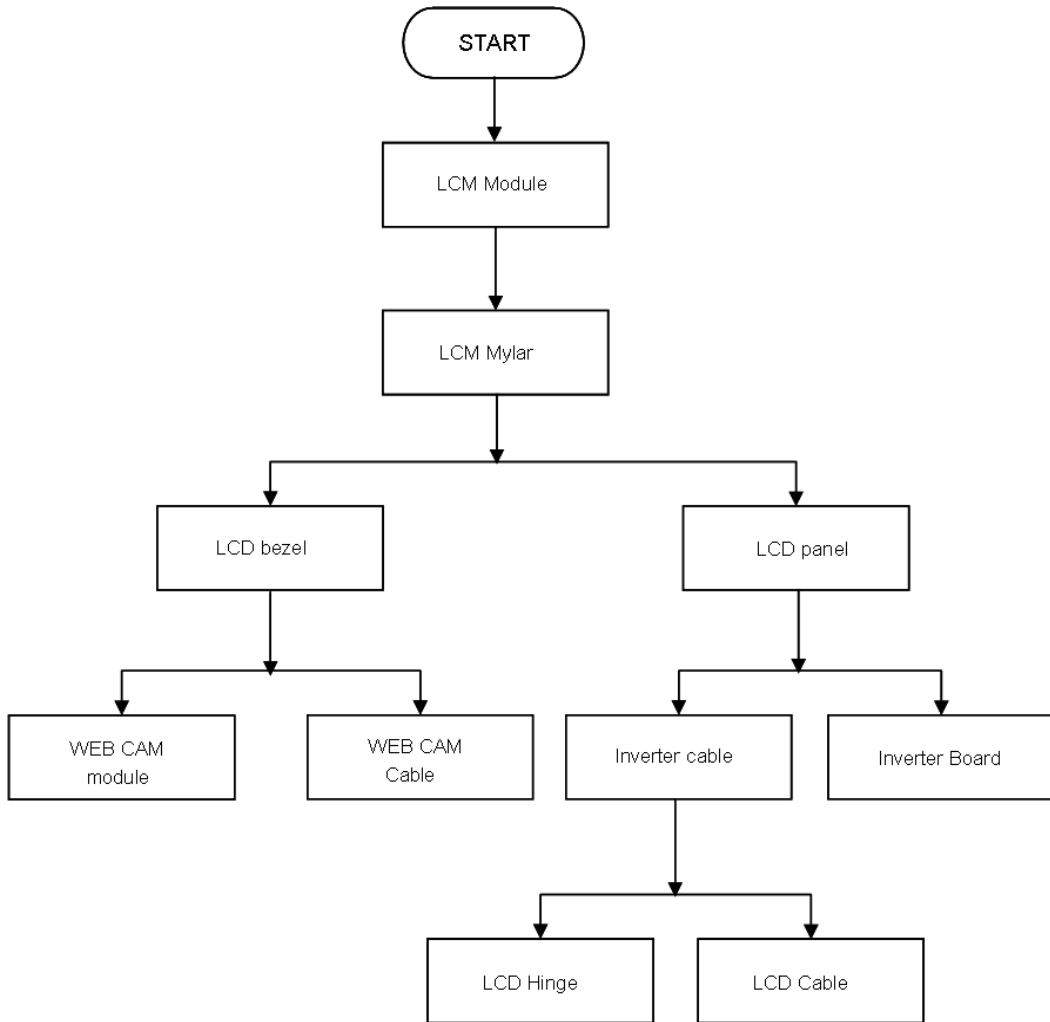

Removing the Battery Pack

1. Release the battery.
2. Slide the battery latch then remove the battery.

Removing the HDD/Memory Module/Wireless LAN Card/TV Tuner Card/System Fan/Thermal Modules/CPU

Removing the HDD

1. 1. Remove the six screws fastening the CTO cover
2. 2. Detach the CTO cover from the notebook..

Removing the Wireless Cover & RAM Module

3. Remove one screw to release the Wireless cover
4. Remove the Wireless cover from the notebook.

-
5. Pop out the memory module from the DIMM socket then remove it (If the notebook has two memory modules, then repeat this step).

Removing the Wireless LAN Card/TV Tunder Card and System Fan

6. Pull out the Wireless antenna.
7. Remove the two screws fastening the wireless LAN card.t.
8. Disconnect the main and auxiliary antennae from the wireless LAN card.
9. Then take out the wireless LAN card from the main unit.
10. Loose two screws from the TV card.
11. Remove the TV card from the machine.

12. Remove the two screws from the Wireless card.
13. Remove the Wireless card from the machine..

14. Remove HDD module as shown.

15. Unplug power cable from the machine.

16. Remove FAN cable from the machine.

17. Loose the FAN screw.

18. Take out the system fan from the main unit as shown.

Removing the Thermal Modules and the CPU

19. Remove the two screws holding the finger heatsink.

20. Detach the finger heatsink from the main board.

21. Then take out the CPU heatsink from the main board.

22. Use a flat screwdriver to release the CPU lock (Turn counter clock-wise) then remove the CPU carefully.

23. Remove the Express dummy card.

-
24. Remove the card reader dummy.

Removing the ODD and Dummy cards

25. Remove the screw fastening the optical disk drive module on the bottom.
26. Use a tool to push the optical disk drive module outwards and remove the ODD module

Removing the Hinge cover

27. Remove two hinge cover screws.
28. Then detach the Hinge cover from both side.

Removing the BTCB screws

29. Loose 21 screws from BTCB.

30. Detach Switch cover.

31. Disconnect Media board FFC from the Switch cover

Disassembling the Main Unit

1. Turn over the keyboard as the image shows.
 2. Disconnect the Keyboard FFC from the main board
 3. Then remove the keyboard from the main unit.
-
4. Remove the 18 screws fastening the upper case and the lower case assembly as shown.
 5. Disconnect the FFC from the main board.
-
-
-
-
-
-
-
-
-
-
6. Loose two screws from the TPCB.
 7. Disconnect the LCM cable.
 8. Pull out the Power cable.
 9. Pull out the Wireless antenna.
 10. Release four TPCB locker then remove the TCB from machine.

Disassembling the LED boards

11. Loosen the LED boards four screws.
12. Remove two LED boards from the machine.

13. Loosen four LCM hinge screws.
14. Then remove LCM module from the machine.

Remove I/O board and Main Board.

15. Loosen the daughter board screw then remove the daughter board from the machine.
16. Disconnect four cables on the M/B as shown.
17. Loosen the M/B screw, remove RJ11 connector from the BT/CB.
18. Remove M/B from the BT/CB..

19. Disconnect LED/B cable and USB/B FFC.

20. Remove the USB board from BTCB.

21. Loose two Modem card screws.

22. Disconnect Modem card cable.

23. Remove Modem card from the M/B.

Disassembly LCM module

1. Remove six LCM bezel mylar.

2. Loose 11 LCM bezel screws.

3. Remove LCM bezel.

4. Disconnect Inverter cable and Back LED board cable.

5. Disconnect CCD cable.

6. Loose four LCD scrws from the hinge.

7. Remove the LCD panel.

8. Remove the Inverter board.

9. Loose four LCD hinge screws, then remove two hinges from LCD panel.

Disassembling the External Modules

Disassembling the HDD Module

1. Remove the four screws holding the HDD (hard disk drive) foil; two on each side.
2. Carefully take out the hard disk drive from the HDD foil.

Disassembling the ODD Module

1. Remove the two screws holding the optical bracket.
2. Then remove the optical bracket from the optical disk drive.

Troubleshooting

Use the following procedure as a guide for computer problems.

NOTE: The diagnostic tests are intended to test only Acer products. Non-Acer products, prototype cards, or modified options can give false errors and invalid system responses.

1. Obtain the failing symptoms in as much detail as possible.
2. Verify the symptoms by attempting to re-create the failure by running the diagnostic test or by repeating the same operation.
3. Use the following table with the verified symptom to determine which page to go to.

Symptoms (Verified)	Go To
Power failure. (The power indicator does not go on or stay on.)	"Power System Check" on page 71
POST does not complete. No beep or error codes are indicated.	"Power-On Self-Test (POST) Error Message" on page 73 "Undetermined Problems" on page 86
POST detects an error and displayed messages on screen.	"Error Message List" on page 74
Other symptoms (i.e. LCD display problems or others).	"Power-On Self-Test (POST) Error Message" on page 73
Symptoms cannot be re-created (intermittent problems).	Use the customer-reported symptoms and go to "Power-On Self-Test (POST) Error Message" on page 73 "Intermittent Problems" on page 85 "Undetermined Problems" on page 86

System Check Procedures

External Diskette Drive Check

Do the following to isolate the problem to a controller, driver, or diskette. A write-enabled, diagnostic diskette is required.

NOTE: Make sure that the diskette does not have more than one label attached to it. Multiple labels can cause damage to the drive or cause the drive to fail.

Do the following to select the test device.

1. Boot from the diagnostics diskette and start the diagnostics program.
2. See if FDD Test is passed as the program runs to FDD Test.
3. Follow the instructions in the message window.

If an error occurs with the internal diskette drive, reconnect the diskette connector on the system board.

If the error still remains:

1. Reconnect the external diskette drive/DVD-ROM module.
2. Replace the external diskette drive/CD-ROM module.
3. Replace the main board.

External CD-ROM Drive Check

Do the following to isolate the problem to a controller, drive, or CD-ROM. Make sure that the CD-ROM does not have any label attached to it. The label can cause damage to the drive or can cause the drive to fail.

Do the following to select the test device:

1. Boot from the diagnostics diskette and start the diagnostics program.
2. See if CD-ROM Test is passed when the program runs to CD-ROM Test.
3. Follow the instructions in the message window.

If an error occurs, reconnect the connector on the System board. If the error still remains:

1. Reconnect the external diskette drive/CD-ROM module.
2. Replace the external diskette drive/CD-ROM module.
3. Replace the main board.

Keyboard or Auxiliary Input Device Check

Remove the external keyboard if the internal keyboard is to be tested.

If the internal keyboard does not work or an unexpected character appears, make sure that the flexible cable extending from the keyboard is correctly seated in the connector on the system board.

If the keyboard cable connection is correct, run the Keyboard Test.

If the tests detect a keyboard problem, do the following one at a time to correct the problem. Do not replace a non-defective FRU:

1. Reconnect the keyboard cables.
2. Replace the keyboard.
3. Replace the main board.

The following auxiliary input devices are supported by this computer:

- Numeric keypad
- External keyboard

If any of these devices do not work, reconnect the cable connector and repeat the failing operation.

Memory check

Memory errors might stop system operations, show error messages on the screen, or hang the system.

1. Boot from the diagnostics diskette and start the doagmpstotics program (please refer to main board).
2. Go to the diagnostic memory in the test items.
3. Press F2 in the test items.
4. Follow the instructions in the message window.

NOTE: Make sure that the DIMM is fully installed into the connector. A loose connection can cause an error.

Power System Check

To verify the symptom of the problem, power on the computer using each of the following power sources:

1. Remove the battery pack.
2. Connect the power adapter and check that power is supplied.
3. Disconnect the power adapter and install the charged battery pack; then check that power is supplied by the battery pack.

If you suspect a power problem, see the appropriate power supply check in the following list:

- "Check the Power Adapter" on page 71
- "Check the Battery Pack" on page 72

Check the Power Adapter

Unplug the power adapter cable from the computer and measure the output voltage at the plug of the power adapter cable. See the following figure:

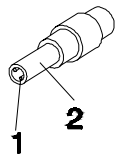

Pin 1: +19 to +20.5V

Pin 2: 0V, Ground

1. If the voltage is not correct, replace the power adapter.
2. If the voltage is within the range, do the following:
 - Replace the System board.
 - If the problem is not corrected, see "Undetermined Problems" on page 86.
 - If the voltage is not correct, go to the next step.

NOTE: An audible noise from the power adapter does not always indicate a defect.

3. If the power-on indicator does not light up, check the power cord of the power adapter for correct continuity and installation.
4. If the operational charge does not work, see "Check the Battery Pack" on page 72.

Check the Battery Pack

To check the battery pack, do the following:

From Software:

1. Check out the Power Management in control Panel.
2. In Power Meter, confirm that if the parameters shown in the screen for Current Power Source and Total Battery Power Remaining are correct.
3. Repeat the steps 1 and 2, for both battery and adapter.
4. This helps you identify first the problem is on recharging or discharging.

From Hardware:

1. Power off the computer.
2. Remove the battery pack and measure the voltage between battery terminals 1(+) and 6(ground). See the following figure:

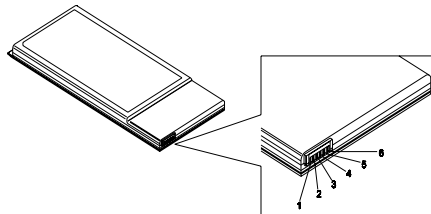

3. If the voltage is still less than 7.5 Vdc after recharging, replace the battery.

To check the battery charge operation, use a discharged battery pack or a battery pack that has less than 50% of the total power remaining when installed in the computer.

If the battery status indicator does not light up, remove the battery pack and let it return to room temperature. Re-install the battery pack.

If the charge indicator still does not light up, replace the battery pack. If the charge indicator still does not light up, replace the DC/DC charger board.

Touchpad Check

If the touchpad doesn't work, do the following actions one at a time to correct the problem. Do not replace a non-defective FRU:

1. Reconnect the touchpad cables.
2. Replace the touchpad.
3. Replace the system board.

After you use the touchpad, the pointer drifts on the screen for a short time. This self-acting pointer movement can occur when a slight, steady pressure is applied to the touchpad pointer. This symptom is not a hardware problem. No service actions are necessary if the pointer movement stops in a short period of time.

Power-On Self-Test (POST) Error Message

The POST error message index lists the error message and their possible causes. The most likely cause is listed first.

NOTE: Perform the FRU replacement or actions in the sequence shown in FRU/Action column, if the FRU replacement does not solve the problem, put the original part back in the computer. Do not replace a non-defective FRU.

This index can also help you determine the next possible FRU to be replaced when servicing a computer.

If the symptom is not listed, see "Undetermined Problems" on page 86.

The following lists the error messages that the BIOS displays on the screen and the error symptoms classified by function.

NOTE: Most of the error messages occur during POST. Some of them display information about a hardware device, e.g., the amount of memory installed. Others may indicate a problem with a device, such as the way it has been configured.

NOTE: If the system fails after you make changes in the BIOS Setup Utility menus, reset the computer, enter Setup and install Setup defaults or correct the error.

Index of Error Messages

Error Code List

Error Codes	Error Messages
006	Equipment Configuration Error causes: 1. CPU BIOS Update Code Mismatch. 2. IDE Primary Channel Master Drive Error. (The causes will be shown before "Equipment Configuration Error")
010	Memory Error at xxxx:xxx:xxxh (R:xxxh, W:xxxh).
070	Real Time Clock Error
071	CMOS Battery Bad
072	CMOS Checksum Error
110	System disabled Incorrect password is specified.
<No error code>	Battery critical LOW In this situation BIOS will issue 4 short beeps then shut down system, no message will show.
<No error code>	Thermal critical High In this situation BIOS will shut down system, not show message.

Error Message List

Error Messages	FRU/Action in Sequence
Failure Fixed Disk	Reconnect hard disk drive connector. "Load Default Settings" in BIOS Setup Utility. Hard disk drive System board
Stuck Key	see "Keyboard or Auxiliary Input Device Check" on page 70.
Keyboard error	see "Keyboard or Auxiliary Input Device Check" on page 70.
Keyboard Controller Failed	see "Keyboard or Auxiliary Input Device Check" on page 70.
Keyboard locked - Unlock key switch	Unlock external keyboard
Monitor type does not match CMOS - Run Setup	Run "Load Default Settings" in BIOS Setup Utility.
Shadow RAM Failed at offset: nnnn	BIOS ROM System board
System RAM Failed at offset: nnnn	DIMM System board
Extended RAM Failed at offset: nnnn	DIMM System board
System battery is dead - Replace and run Setup	Replace RTC battery and Run BIOS Setup Utility to reconfigure system time, then reboot system.
System CMOS checksum bad - Default configuration used	RTC battery Run BIOS Setup Utility to reconfigure system time, then reboot system.
System timer error	RTC battery Run BIOS Setup Utility to reconfigure system time, then reboot system. System board

Error Messages	FRU/Action in Sequence
Real time clock error	RTC battery Run BIOS Setup Utility to reconfigure system time, then reboot system. System board
Previous boot incomplete - Default configuration used.	Run "Load Default Settings" in BIOS Setup Utility. RTC battery System board
Memory size found by POST differed from CMOS.	Run "Load Default Settings" in BIOS Setup Utility. DIMM System board
Diskette drive A error	Check the drive is defined with the proper diskette type in BIOS Setup Utility. See "External Diskette Drive Check" on page 70.
Incorrect Drive A type - run SETUP	Check the drive is defined with the proper diskette type in BIOS Setup Utility.
System cache error - Cache disabled	System board
CPU ID	System board
DMA Test Failed	DIMM System board
Software NMI Failed	DIMM System board
Fail-Safe Timer NMI Failed	DIMM System board
Device Address Conflict	Run "Load Default Settings" in BIOS Setup Utility. RTC battery System board
Allocation Error for device	Run "Load Default Settings" in BIOS Setup Utility. RTC battery System board
Failing Bits: nnnn	DIMM BIOS ROM System board
Fixed Disk n	None
Invalid System Configuration Data	BIOS ROM System board
I/O device IRQ conflict	Run "Load Default Settings" in BIOS Setup Utility. RTC battery System board
Operating system not found	Enter Setup and see if fixed disk and drive A: are properly identified. Diskette drive Hard disk drive System board

Error Message List

No beep Error Messages	FRU/Action in Sequence
No beep, power-on indicator turns off and LCD is blank.	Power source (battery pack and power adapter). See "Power System Check" on page 71. Ensure every connector is connected tightly and correctly. Reconnect the DIMM LED board System board

No beep Error Messages	FRU/Action in Sequence
No beep, power-on indicator turns on and LCD is blank.	Power source (battery pack and power adapter). See "Power System Check" on page 71. Reconnect the LCD connector Hard disk drive LCD inverter ID LCD cable LCD Inverter LCD System board
No beep, power-on indicator turns on and LCD is blank. But you can see POST on an external CRT.	Reconnect the LCD connectors LCD inverter ID LCD cable LCD inverter LCD System board
No beep, power-on indicator turns on and a blinking cursor shown on LCD during POST.	Ensure every connector is connected tightly and correctly. System board
No beep during POST but system runs correctly.	Speaker System board

Phoenix BIOS Beep Codes

Code	Beeps	POST Routine Description
02h		Verify Real Mode
03h		Disable Non-Maskable Interrupt (NMI)
04h		Get CPU type
06h		Initialize system hardware
08h		Initialize chipset with initial POST values
09h		Set IN POST flag
0Ah		Initialize CPU registers
0Bh		Enable CPU cache
0Ch		Initialize caches to initial POST values
0Eh		Initialize I/O component
0Fh		Initialize the local bus IDE
10h		Initialize Power Management
11h		Load alternate registers with initial POST values
12h		Restore CPU control word during warm boot
13h		Initialize PCI Bus Mastering devices
14h		Initialize keyboard controller
16h	1-2-2-3	BIOS ROM checksum
17h		Initialize cache before memory autosize
18h		8254 timer initialization
1Ah		8237 DMA controller initialization
1Ch		Reset Programmable Interrupt Controller
20h	1-3-1-1	Test DRAM refresh
22h	1-3-1-3	Test 8742 Keyboard Controller
24h		Set ES segment register to 4 GB
26h		Enable A20 line
28h		Autosize DRAM
29h		Initialize POST Memory Manager
2Ah		Clear 215 KB base RAM
2Ch	1-3-4-1	RAM failure on address line xxxx
2Eh	1-3-4-3	RAM failure on data bits xxxx of low byte of memory bus
2Fh		Enable cache before system BIOS shadow
2Ah		Clear 215 KB base RAM
2Ch	1-3-4-1	RAM failure on address line xxxx
2Eh	1-3-4-3	RAM failure on data bits xxxx of low byte of memory bus
2Fh		Enable cache before system BIOS shadow
30h	1-4-1-1	RAM failure on data bits xxxx of high byte of memory bus
32h		Test CPU bus-clock frequency
33h		Initialize Phoenix Dispatch Manager
36h		Warm start shut down
38h		Shadow system BIOS ROM
3Ah		Autosize cache
3Ch		Advanced configuration of chipset registers
3Dh		Load alternate registers with CMOS values
42h		Initialize interrupt vectors

Code	Beeps	POST Routine Description
45h		POST device initialization
46h	2-1-2-3	Check ROM copyright notice
48h		Check video configuration against CMOS
49h		Initialize PCI bus and devices
4Ah		Initialize all video adapters in system
4Bh		QuietBoot start (optional)
4Ch		Shadow video BIOS ROM
4Eh		Display BIOS copyright notice
50h		Display CPU type and speed
51h		Initialize EISA board
52h		Test keyboard
54h		Set key click if enabled
58h	2-2-3-1	Test for unexpected interrupts
59h		Initialize POST display service
5Ah		Display prompt "Press F2 to enter SETUP"
5Bh		Disable CPU cache
5Ch		Test RAM between 512 and 640 KB
60h		Test extended memory
62h		Test extended memory address lines
64h		Jump to User Patch1
66h		Configure advanced cache registers
67h		Initialize Multi Processor APIC
68h		Enable external and CPU caches
69h		Setup System Management Mode (SMM) area
6Ah		Display external L2 cache size
6Bh		Load custom defaults (optional)
6Ch		Display shadow-area message
6Eh		Display possible high address for UMB recovery
70h		Display error messages
72h		Check for configuration errors
76h		Check for keyboard errors
7Ch		Set up hardware interrupt vectors
7Eh		Initialize coprocessor if present
80h		Disable onboard Super I/O ports and IRQs
81h		Late POST device initialization
82h		Detect and install external RS232 ports
83h		Configure non-MCD IDE controllers
84h		Detect and install external parallel ports
85h		Initialize PC-compatible PnP ISA devices
86h		Re-initialize onboard I/O ports
87h		Configure Motherboard Configurable Devices (optional)
88h		Initialize BIOS Area
89h		Enable Non-Maskable Interrupts (NMIs)
8Ah		Initialize Extended BIOS Data Area
8Bh		Test and initialize PS/2 mouse
8Ch		Initialize floppy controller

Code	Beeps	POST Routine Description
8Fh		Determine number of ATA drives (optional)
90h		Initialize hard-disk controllers
91h		Initialize local-bus hard-disk controllers
92h		Jump to UserPatch2
93h		Build MPTABLE for multi-processor boards
95h		Install CD ROM for boot
96h		Clear huge ES segment register
97h		Fixup Multi Processor table
98h	1-2	Search for option ROMs. One long, two short beeps on checksum failure.
99h		Check for SMART drive (optional)
9Ah		Shadow option ROMs
9Ch		Set up Power Management
9Dh		Initialize security engine (optional)
9Eh		Enable hardware interrupts
9Fh		Determine number of ATA and SCSI drives
A0h		Set time of day
A2h		Check key lock
A4h		Initialize Typematic rate
A8h		Erase F2 prompt
AAh		Scan for F2 key stroke
ACH		Enter SETUP
AEh		Clear Boot flag
B0h		Check for errors
B2h		POST done- prepare to boot operating system
B4h	1	One short beep before boot
B5h		Terminate QuietBoot (optional)
B6h		Check password (optional)
B9h		Prepare Boot
BAh		Initialize DMI parameters
BBh		Initialize PnP Option ROMs
BCh		Clear parity checkers
BDh		Display MultiBoot menu
BEh		Clear screen (optional)
BFh		Check virus and backup reminders
C0h		Try to boot with INT 19
C1h		Initialize POST Error Manager (PEM)
C2h		Initialize error logging
C3h		Initialize error display function
C4h		Initialize system error handler
C5h		PnPnd dual CMOS (optional)
C6h		Initialize notebook docking (optional)
C7h		Initialize notebook docking late
C8h		Force check (optional)
C9h		Extended checksum (optional)
D2h		Unknown interrupt
E0h		Initialize the chipset

Code	Beeps	POST Routine Description
E1h		Initialize the bridge
E2h		Initialize the CPU
E3h		Initialize the system timer
E4h		Initialize system I/O
E5h		Check force recovery boot
E6h		Checksum BIOS ROM
E7h		Go to BIOS
E8h		Set Huge Segment
E9h		Initialize Multi Processor
EAh		Initialize OEM special code
EBh		Initialize PIC and DMA
ECh		Initialize Memory type
EDh		Initialize Memory size
EEh		Shadow Boot Block
EFh		System memory test
F0h		Initialize interrupt vectors
F1h		Initialize Run Time Clock
F2h		Initialize video
F3h		Initialize System Management Mode

Index of Symptom-to-FRU Error Message

LCD-Related Symptoms

Symptom / Error	Action in Sequence
LCD backlight doesn't work LCD is too dark LCD brightness cannot be adjusted LCD contrast cannot be adjusted	Enter BIOS Utility to execute "Load Setup Default Settings", then reboot system. Reconnect the LCD connectors Keyboard (if contrast and brightness function key doesn't work) LCD inverter ID LCD cable LCD inverter LCD System board
Unreadable LCD screen Missing pels in characters Abnormal screen Wrong color displayed	Reconnect the LCD connector LCD inverter ID LCD cable LCD inverter LCD System board
LCD has extra horizontal or vertical lines displayed	LCD inverter ID LCD inverter LCD cable LCD System board

Indicator-Related Symptoms

Symptom / Error	Action in Sequence
Indicator incorrectly remains off or on, but system runs correctly	Reconnect the inverter board Inverter board System board

Power-Related Symptoms

Symptom / Error	Action in Sequence
Power shuts down during operation.	Power source (battery pack and power adapter). See "Power System Check" on page 71. Battery pack Power adapter Hard drive & battery connection board System board
The system doesn't power-on.	Power source (battery pack and power adapter). See "Power System Check" on page 71. Battery pack Power adapter Hard drive & battery connection board System board
The system doesn't power-off.	Power source (battery pack and power adapter). See "Power System Check" on page 71. Hold and press the power switch for more than 4 seconds. System board
Battery can't be charged.	See "Check the Battery Pack" on page 72. Battery pack System board

PCMCIA-Related Symptoms

Symptom / Error	Action in Sequence
System cannot detect the PC Card (PCMCIA) .	PCMCIA slot assembly System board
PCMCIA slot pin is damaged.	PCMCIA slot assembly

Memory-Related Symptoms

Symptom / Error	Action in Sequence
Memory count (size) appears different from actual size.	Enter BIOS Setup Utility to execute "Load Default Settings, then reboot system. DIMM System board

Speaker-Related Symptoms

Symptom / Error	Action in Sequence
In Windows, multimedia programs, no sound comes from the computer.	Audio driver Speaker System board
Internal speakers make noise or emit no sound.	Speaker System board

Power Management-Related Symptoms

Symptom / Error	Action in Sequence
The system will not enter hibernation.	Keyboard (if control is from the keyboard) Hard disk drive System board
The system doesn't enter hibernation mode and four short beeps every minute.	Press Fn+o and see if the computer enters hibernation mode. Touchpad Keyboard Hard disk connection board Hard disk drive System board
The system doesn't enter standby mode after closing the LCD.	LCD cover switch System board
The system doesn't resume from hibernation mode.	Hard disk connection board Hard disk drive System board
The system doesn't resume from standby mode after opening the LCD.	LCD cover switch System board
Battery fuel gauge in Windows doesn't go higher than 90%.	Remove battery pack and let it cool for 2 hours. Refresh battery (continue use battery until power off, then charge battery). Battery pack System board
System hangs intermittently.	Reconnect hard disk/CD-ROM drives. Hard disk connection board System board

Peripheral-Related Symptoms

Symptom / Error	Action in Sequence
System configuration does not match the installed devices.	Enter BIOS Setup Utility to execute "Load Default Settings", then reboot system. Reconnect hard disk/CD-ROM/diskette drives.
External display does not work correctly.	Press Fn+F5, LCD/CRT/Both display switching. System board
USB does not work correctly.	System board
Print problems.	Ensure the "Parallel Port" in the "Onboard Devices Configuration" of BIOS Setup Utility is set to Enabled. Onboard Devices Configuration Run printer self-test. Printer driver Printer cable Printer System Board
Serial or parallel port device problems.	Ensure the "Serial Port" in the Devices Configuration" of BIOS Setup Utility is set to Enabled. Device driver Device cable Device System board

Keyboard/Touchpad-Related Symptoms

Symptom / Error	Action in Sequence
Keyboard (one or more keys) does not work.	Reconnect the keyboard cable Keyboard System board
Touchpad does not work.	Reconnect touchpad cable Touchpad board System board

Modem-Related Symptoms

Symptom / Error	Action in Sequence
Internal modem does not work correctly.	Modem phone port modem combo board System board

NOTE: If you cannot find a symptom or an error in this list and the problem remains, see "Undetermined Problems" on page 86.

Intermittent Problems

Intermittent system hang problems can be caused by a variety of reasons that have nothing to do with a hardware defect, such as: cosmic radiation, electrostatic discharge, or software errors. FRU replacement should be considered only when a recurring problem exists.

When analyzing an intermittent problem, do the following:

1. Run the advanced diagnostic test for the system board in loop mode at least 10 times.
2. If no error is detected, do not replace any FRU.
3. If any error is detected, replace the FRU. Rerun the test to verify that there are no more errors.

Undetermined Problems

The diagnostic problems does not identify which adapter or device failed, which installed devices are incorrect, whether a short circuit is suspected, or whether the system is inoperative.

Follow these procedures to isolate the failing FRU (do not isolate non-defective FRU).

NOTE: Verify that all attached devices are supported by the computer.

NOTE: Verify that the power supply being used at the time of the failure is operating correctly. (See "Power System Check" on page 71):

1. Power-off the computer.
2. Visually check them for damage. If any problems are found, replace the FRU.
3. Remove or disconnect all of the following devices:
 - Non-Acer devices
 - Printer, mouse, and other external devices
 - Battery pack
 - Hard disk drive
 - DIMM
 - CD-ROM/Diskette drive Module
 - PC Cards
4. Power-on the computer.
5. Determine if the problem has changed.
6. If the problem does not recur, reconnect the removed devices one at a time until you find the failing FRU.
7. If the problem remains, replace the following FRU one at a time. Do not replace a non-defective FRU:
 - System board
 - LCD assembly

Jumper and Connector Locations

Top View

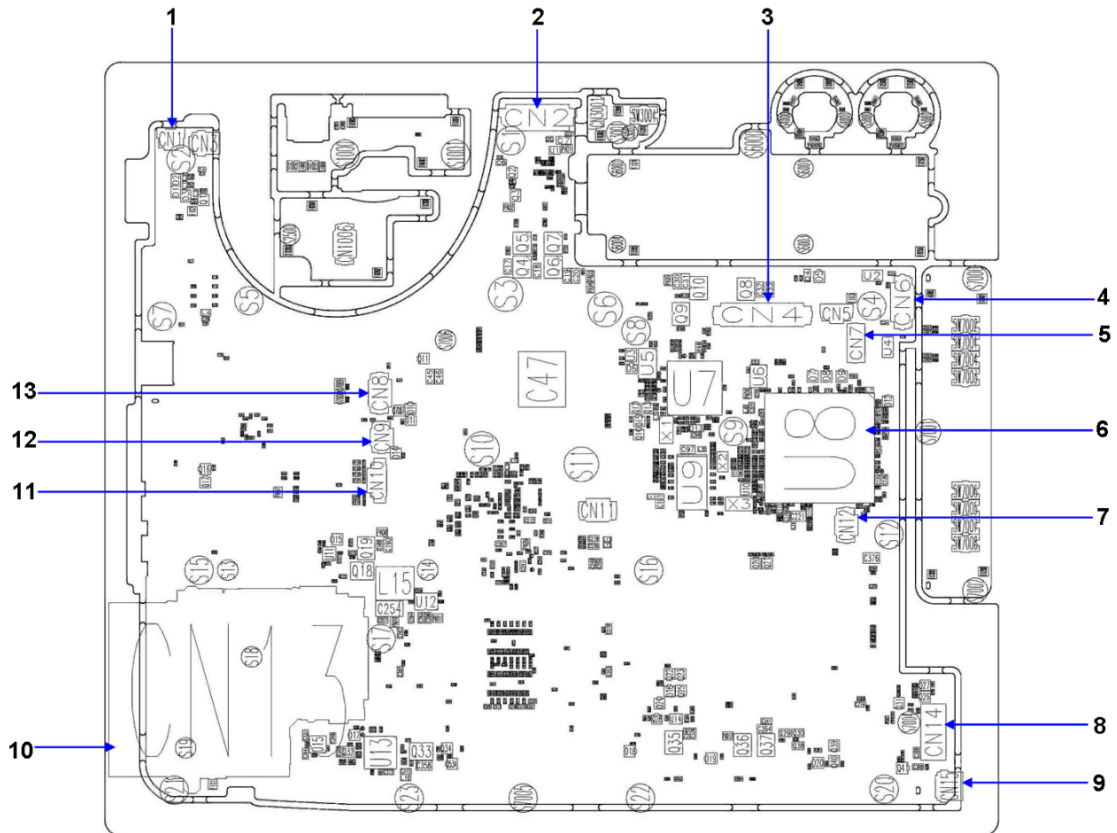

**Aspire6935 M/B layout and connector location
TOP view**

No.	Name	Description
1	CN1	LED/B Cable CNTR
2	CN2	LCM Cable CNTR
3	CN3	Key board FFC CNTR
4	CN4	USB board CNTR
5	CN7	Hot Key Board CNTR
6	U8	South Bridge
7	CN12	Touch Pad FFC CNTR
8	CN14	I/O Board CNTR
9	CN15	BT Cable CNTR
10	CN13	Express card CNTR
11	CN10	Speaker Cable CNTR
12	CN9	Media console Board CNTR
13	CN8	Power Board FFC CNTR

Bottom View

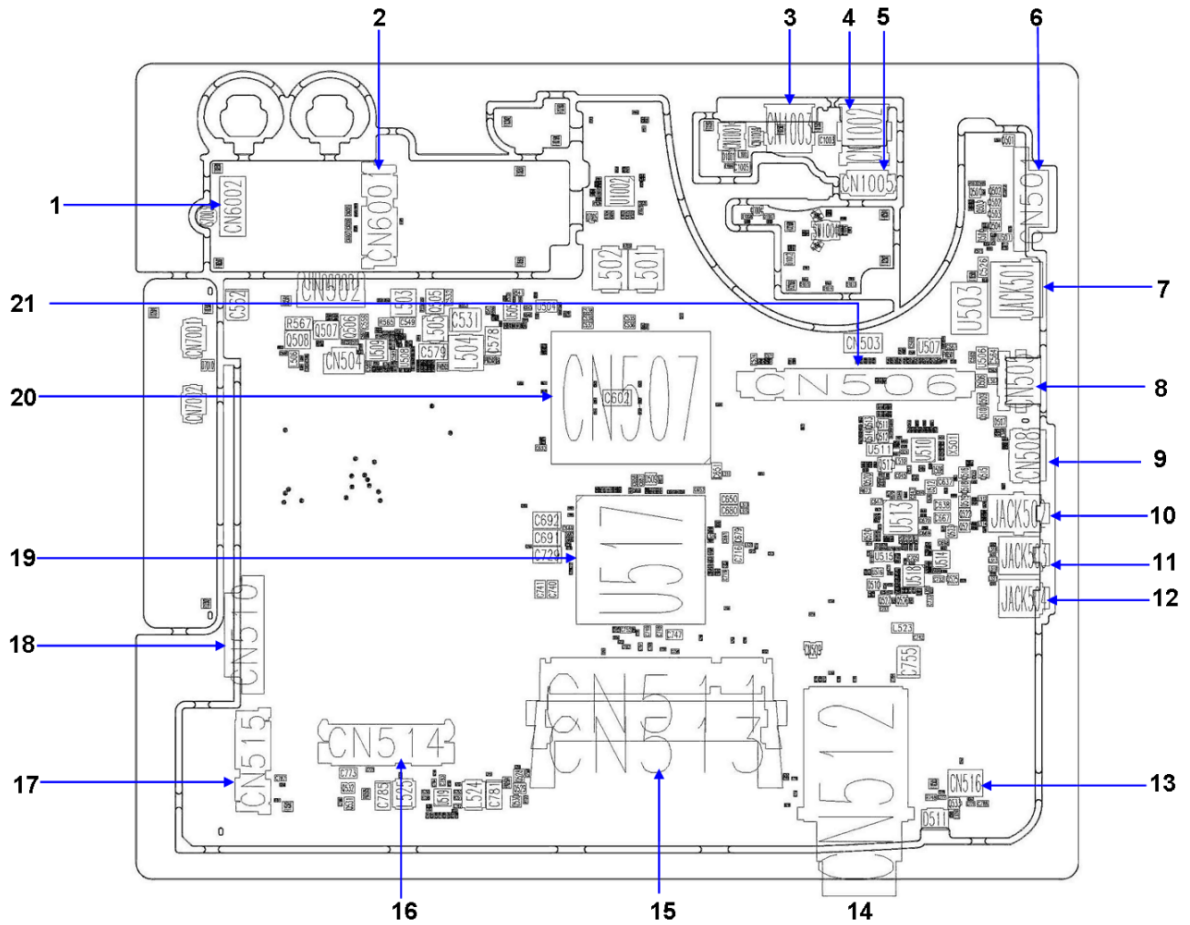

Bottom view		
No.	Name	Description
1	CN6002	W/LAN card board CNTR
2	CN6001	TV/Robson card CNTR
3	CN1003	USB Port
4	CN1002	USB Port
5	CN1005	USB Board CNTR
6	CN501	VGA Port
7	Jack501	RJ45
8	CN505	USB Port
9	CN508	HDMI Port
10	Jack502	SPDIF
11	Jack503	MIC jack
12	Jack504	Line in jack
13	CN516	MDC Card CNTR
14	CN512	New card Socket
15	CN511/513	DIMM Socket
16	CN514	HDD CNTR
17	CN515	PCI-E Socket
18	CN510	ODD CNTR
19	U517	North Bridge
20	CN507	CPU Socket
21	CN506	VGA Card Socket

FRU (Field Replaceable Unit) List

This chapter gives you the FRU (Field Replaceable Unit) listing in global configurations of Aspire 6935G. Refer to this chapter whenever ordering for parts to repair or for RMA (Return Merchandise Authorization).

Please note that WHEN ORDERING FRU PARTS, you should check the most up-to-date information available on your regional web or channel. For whatever reasons a part number change is made, it will not be noted on the printed Service Guide. For ACER AUTHORIZED SERVICE PROVIDERS, your Acer office may have a DIFFERENT part number code from those given in the FRU list of this printed Service Guide. You MUST use the local FRU list provided by your regional Acer office to order FRU parts for repair and service of customer machines.

NOTE: To scrap or to return the defective parts, you should follow the local government ordinance or regulations on how to dispose it properly, or follow the rules set by your regional Acer office on how to return it.

Aspire 6935G Exploded Diagram

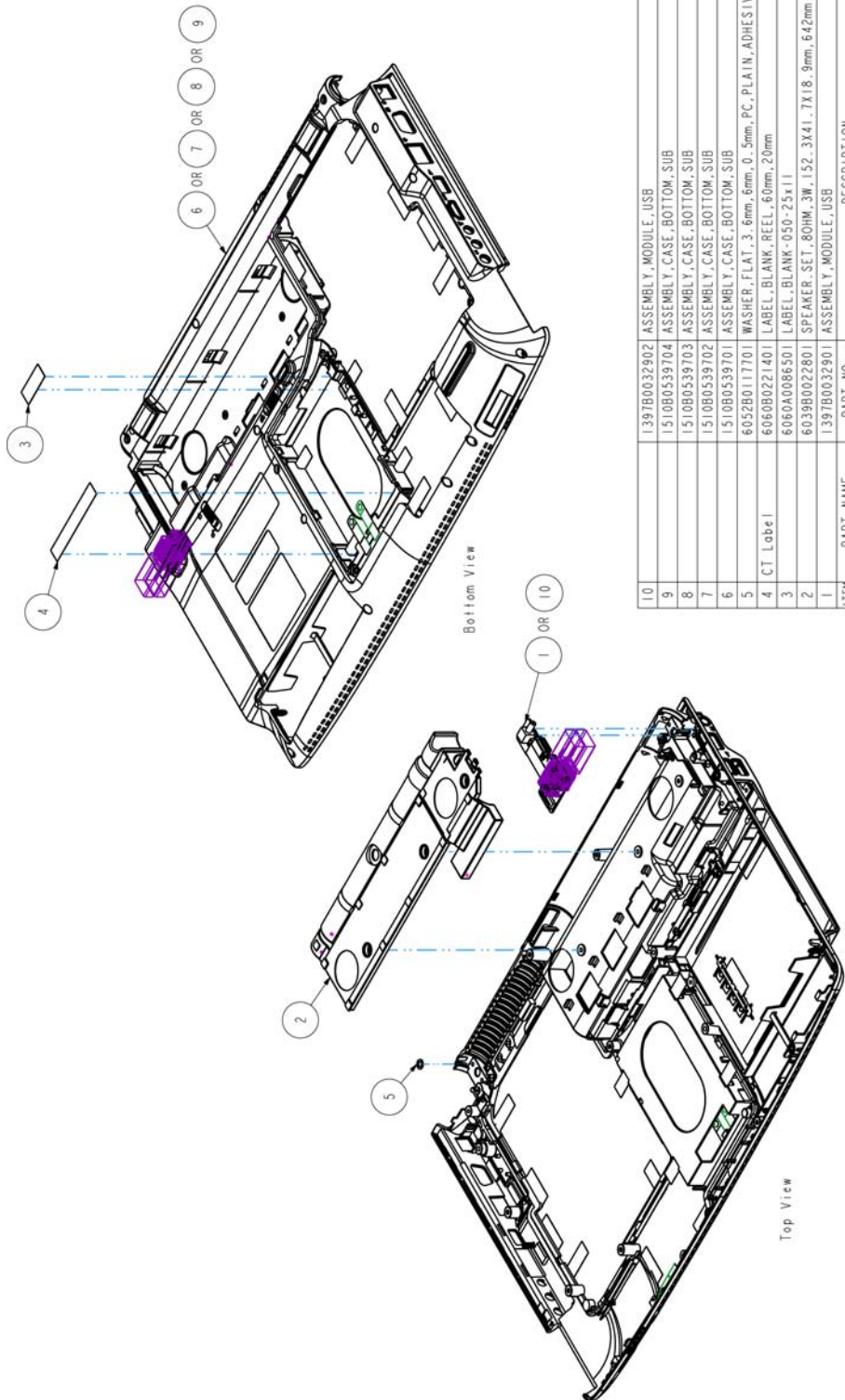

ITEM	PART NAME	PART NO	DESCRIPTION					
10		1397B0032902	ASSEMBLY, MODULE, USB					1
9		1510B0539704	ASSEMBLY, CASE, BOTTOM, SUB					1
8		1510B0539703	ASSEMBLY, CASE, BOTTOM, SUB					1
7		1510B0539702	ASSEMBLY, CASE, BOTTOM, SUB					1
6		1510B0539701	ASSEMBLY, CASE, BOTTOM, SUB					1
5		6032B0117701	WASHER, FLAT, 3.6mm, 6mm, 0.5mm, PC, PLAIN, ADHESIVE					1
4	CT Label	6060B0221401	LABEL, BLANK, REEL, 60mm, 20mm					1
3		6060A0086501	LABEL, BLANK, 050-25x11					1
2		6039B0022801	SPEAKER, SET, 80HM, 3W, 152.3x41.7x18.9mm, 6.42mm					1
1		1397B0032901	ASSEMBLY, MODULE, USB					1

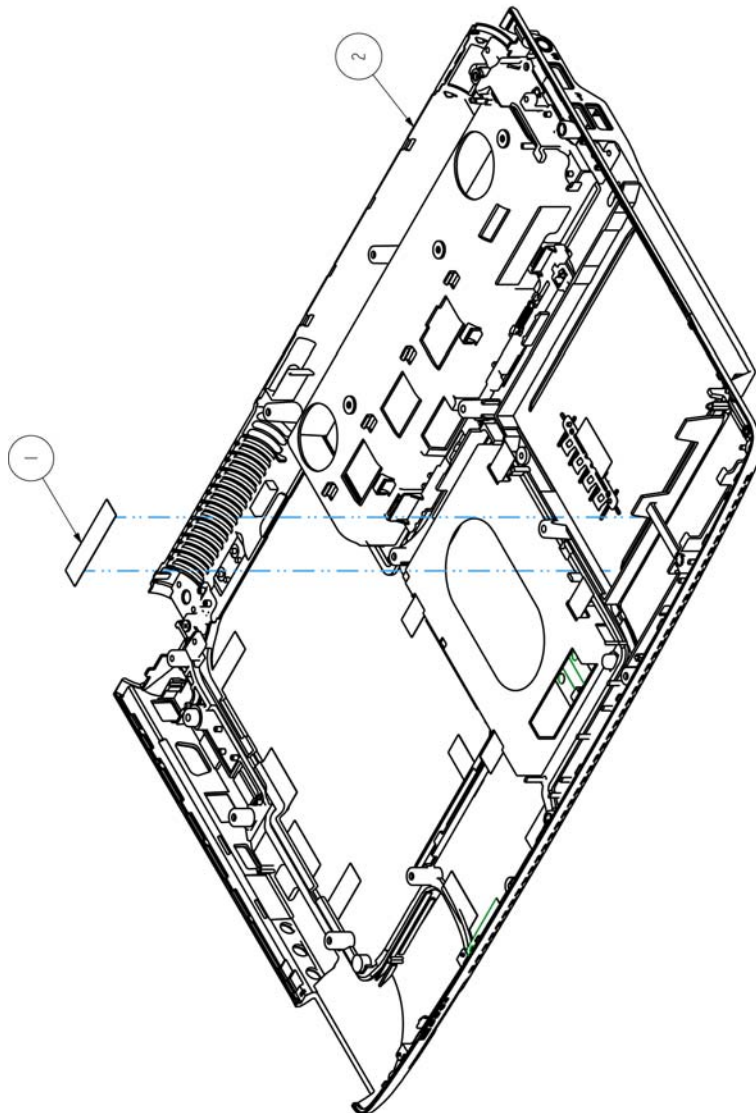

ITEM	PART NAME	PART NO	DESCRIPTION
2	1510B0539301	ASSEMBLY, CASE, BOTTOM, OFFLINE	1 1 1 1
1	60600511J905	LABEL, BLANK-033-40*9	1 1 1 1
			01 02 03 04

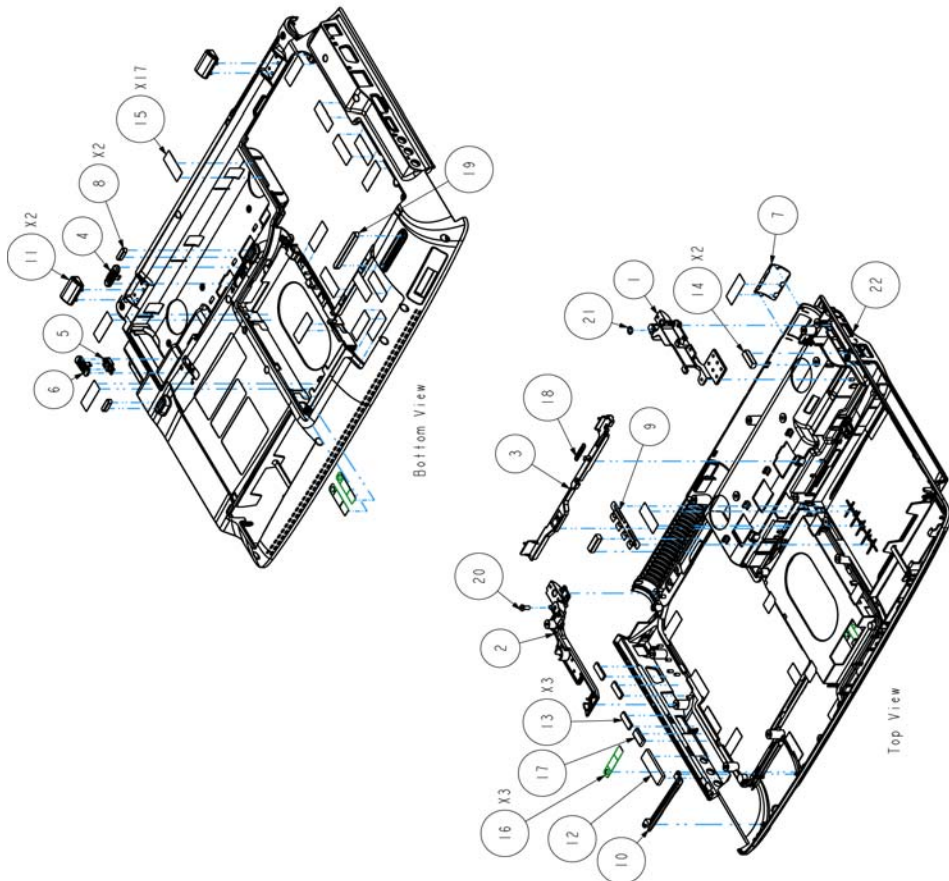

ITEM	PART NAME	PART NO	DESCRIPTION
22	BOTTOM CABINET	6051B034790	CASE, BOTTOM, PC+ABS, PLATING
21		6052B003410	WASHER, FLAT, 3.5mm, 6mm, 0.3mm, AL PLATE
20		6052B007800	SCREW, I, M2, 5.6, 0mm, M, 4.5mm, 0.8mm, BNI, PATCH
19	BTM FRONT BUMPER	6054B040650	FOOT, BOTTOM, FRONT, SILICONE
18	BATTERY SPRING	6053B034570	SPRING, EXTEN, BOTTOM, BATTERY, SUS304
17	GASKET, 130X70X25	6054B021580	GASKET, BELOW, FAN, CONDUCTIVE
16	BTM GASKET	6054B015000	GASKET, NI/CU PNW FR, 29.8mm, 7mm, 0.13mm
15		6054B004360	GASKET, NI/CU PRS FR, 25mm, 10mm, 0.1mm
14	8.5mm x H:4mm x L:1.5mm	6054B010730	GASKET, NI/CU PNW FOF, 15.0mm, 5.0mm, 4.0mm
13	USB GASKET	6054B038130	GASKET, NI/CU PPW FOF, 15mm, 5mm, 1.5mm
12	AUDIO GASKET	6054B038110	GASKET, NI/CU PPW FOF, 30mm, 10mm, 2.5mm
11		6051B031740	FOOT, BOTTOM, PC+ABS+RUBBER
10	BOTTOM IR COVER	6051B029000	COVER, IR, PC
9	BTM ODD SHIELD	6053B034630	SHIELD, BOTTOM, ODD, SUS301
8	BTM MID BUMPER	6054B034900	FOOT, BOTTOM, MID, SILICONE
7	TUNE MESH	6053B034910	NET, BOTTOM, FRONT, SPECC
6	BATT KNOB LOCK	6051B028500	KNOB, BATTERY, LOCK, PC+ABS
5	BATT LATCH LOCK	6051B028520	LATCH, BATTERY, LOCK, NYLON+30%GF
4	BATT KNOB	6051B028510	KNOB, BATTERY, PC+ABS
3	BATT LATCH	6051B028530	LATCH, BATTERY, NYLON+30%GF
2	BOTTOM L BRACKET	6053B034880	BRACKET, BOTTOM, LEFT, ZN ALLOY
1	BOTTOM R BRACKET	6053B034890	BRACKET, BOTTOM, RIGHT, ZN ALLOY
		PART NO	DESCRIPTION
			P/TH

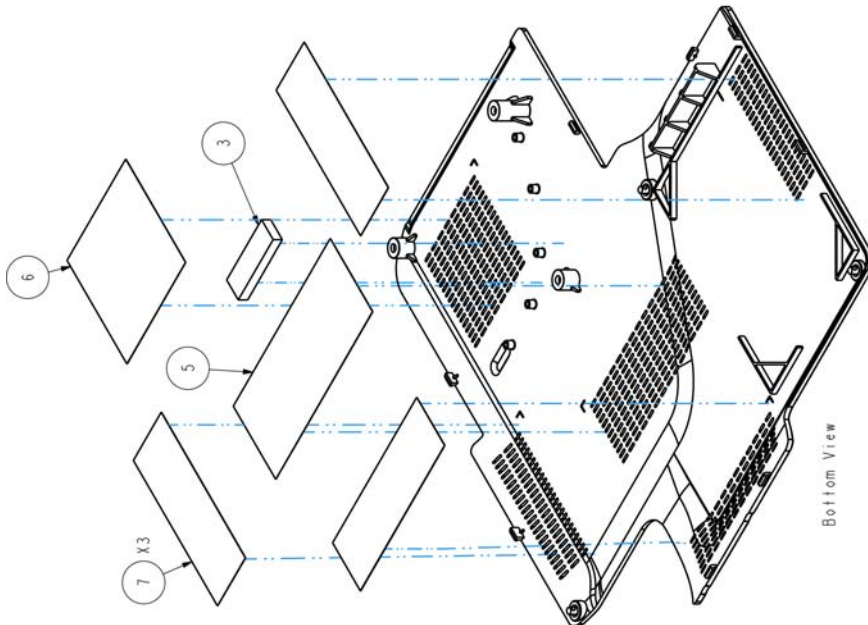
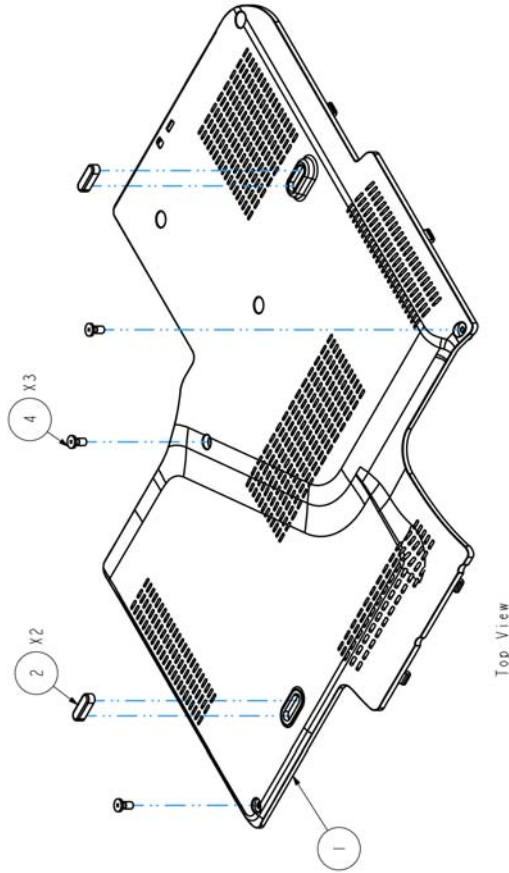

ITEM	PART NAME	PART NO	DESCRIPTION	Q'TY
7	MPCI COVER NET	6054B039980	NET,MPCI COVER,FRB3	3
6	cto.NET_top	6054B047770	NET.CTO COVER.TOP,FRB3	1
5	cto.NET_middle	6054B047780	NET.CTO COVER.MIDDLE,FRB3	1
4	Gasket_300X100X40T	6052B013070	SCREW,T,M2.5,3.0mm,WACHI,4.5mm,0.8mm,CROSS,BNI,PATCH,SMK	3
3	BTM MID BUMPER	6054B024500	GASKET,N1/CU PNW FOF,30.0mm,10.0mm,4.0mm	1
2	BOTTOM CTO COVER	6054B034900	FOOT,BOTTOM,MID,SILICONE	2
1	BOTTOM CTO COVER	6051B029020	COVER,CTO,PC,ABS,PLATING	1

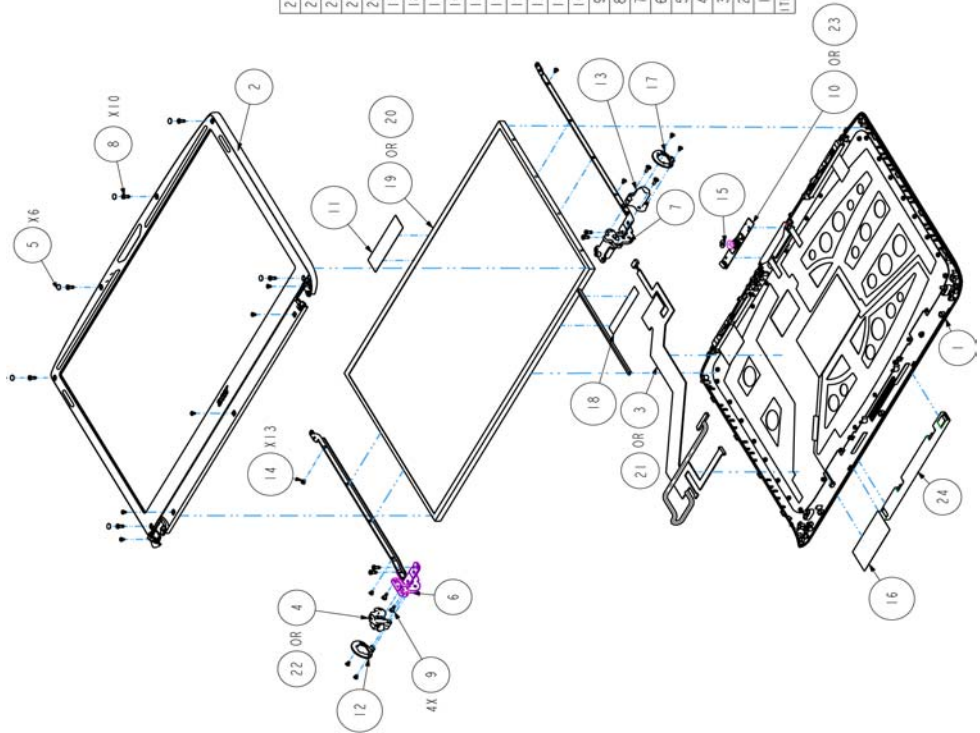

ITEM	PART NAME	PART NO	DESCRIPTION	1	1	1	1	1	1
24		60388001940	INVERTER, 9V-20V, AC710V, 56KHz, 1.41X11X3.9						
23		6047B000820	CAMERA MODULE, LENS, 1.0M						
22		6017B015730	CABLE, ROUND, 4POS, 335mm, 1, DC IN/YELLOW						
21		6017B015720	CABLE, FLAT, 4POS, 363mm, 1, LCN						
20		6024B004370	LCM, 16, TFT, WUGA, LVDS, 580g						
19		6024B004310	LCM, 16, TFT, WUGA, LVDS, 530g						
18	CT LEHPI	6060B022140	LABEL, BLANK, REEL, 60mm, 20mm						
17		1397B003340Z	ASSEMBLY, MODULE, LED						
16	4X DISP, REAR, AL, FOIL	6053B040250	SHIELD, REAR, AL, FOIL						
15	DISP, CCD, LENS, MYLAR	6054B040000	INSULATOR, DISPLAY, CCD, ASI, DO, LENS						
14		6052A000450	SCREW, 120030M4, 0Dx0.471-BK-PATCH						
13	HINGE, ATB, IN, STAIN, BRIT	6053B034550	BRACKET, HINGE, COVER, RIGHT, ZN ALLOY	13	13	13	13	13	13
12		1397B003340	ASSEMBLY, MODULE, LED						
11	DISP, MYLAR	6054B036780	INSULATOR, DISPLAY, PANEL, ASI, DO						
10		6047B000710	CAMERA MODULE, LENS, 0.3M						
9		6052B0008070	SCREW, 1, M2, 6mm, W, 4, 5mm, 0.8mm, PHIL, BK, PATCH	4	4	4	4	4	4
8		6052B007800	SCREW, 1, M2, 5.6, 0mm, W, 4, 5mm, 0.8mm, BNT, PATCH	10	10	10	10	10	10
7	DISP, HINGE, BRACKET, R	6053B034510	HINGE, W BRACKET, DISPLAY, RIGHT, 10-11, 6KGF-CM, 16 INCH						
6	DISP, HINGE, BRACKET, L	6053B034520	HINGE, W BRACKET, DISPLAY, LEFT, 10-11, 6KGF-CM, 16 INCH						
5	DISP, C, REEL, INSULATOR	6054B034480	INSULATOR, DISPLAY, BEZEL, PC, CIRCLE	6	6	6	6	6	6
4		6017B015870	CABLE, ROUND, 4POS, 335MM, 1, DC IN/BLUE						
3	LCM CABLE	6017B015880	CABLE, FLAT, 4POS, 363MM, 1, LCN						
2		1510B047010	ASSEMBLY, BEZEL, DISPLAY, OFFLINE						
1		1510B047000	ASSEMBLY, CASE, REAR, DISPLAY, OFFLINE						
ITEM	PART NAME	PART NO	DESCRIPTION	01	02	03	05	07	

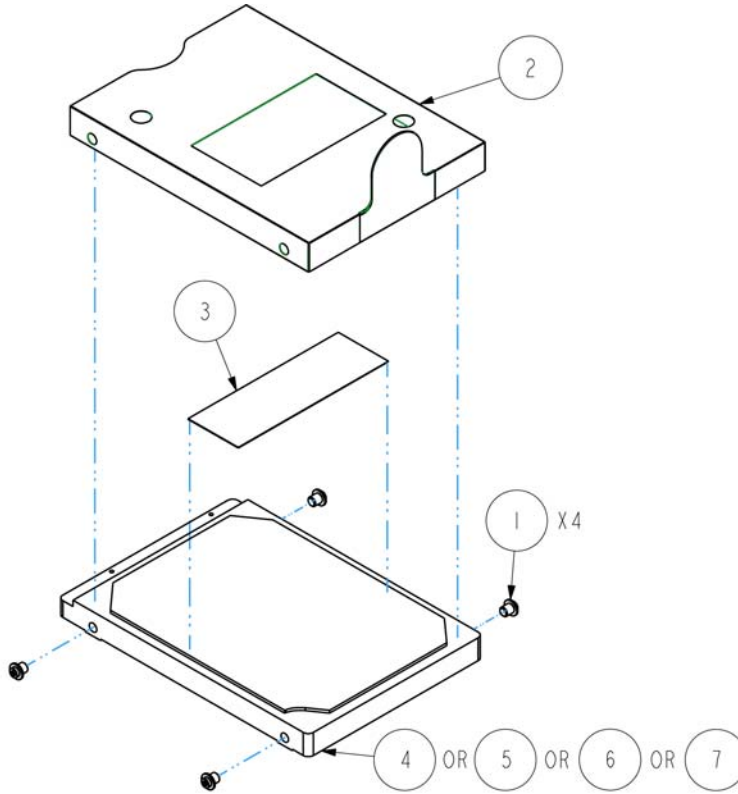

7		6022B0056802	HDD, SATA, 320GB, 5.4KRPM, 22P, 12ms, 5.5ms, SATA 2.0, 2.5X0.37, M3					1
6		6022B0056103	HDD, SATA, 250GB, 5.4KRPM, 22P, 12ms, 5.6ms, SATA 1.0, 2.5X0.37, M3				1	
5		6022B0067902	HDD, SATA, 160GB, 5.4KRPM, 22P, 12ms, 5.6ms, SATA 2.0, 2.5X0.37, M3			1		
4		6022B0056101	HDD, SATA, 120GB, 5.4KRPM, 22P, 12ms, 5.6ms, SATA 1.0, 2.5X0.37, M3	1				
3		6060B0221401	LABEL, BLANK, REEL, 60mm, 20mm	1	1	1	1	
2	HDD, NYLAR	6054B0432201	INSULATOR, HDD, LUMIRROR S10+AL	1	1	1	1	
1	SCREW-W130030M1.5Dx1.5T1-NI-HARDEN	6052A0029401	SCREW-W130030M1.5Dx1.5T1-NI-HARDEN	4	4	4	4	
ITEM	PART NAME	PART NO	DESCRIPTION	01	02	03	04	

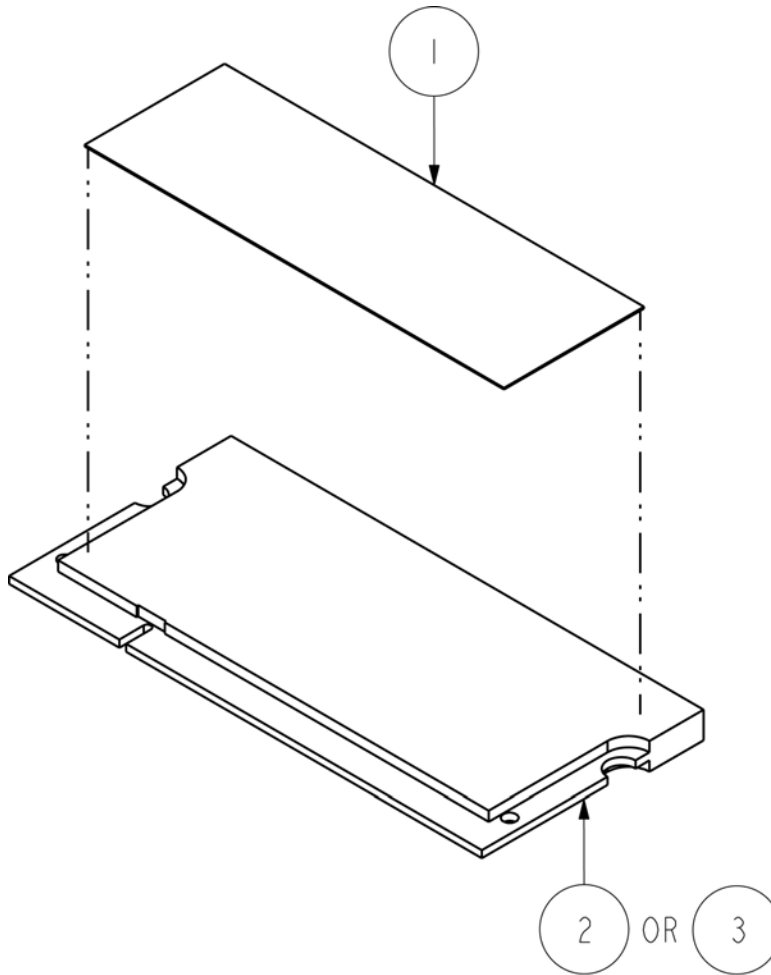

3		6021B0098101	MEMORY MODULE, 2GB, PC3-8500, DDR3, 204P, 256MX€
2		6021B0098201	MEMORY MODULE, 1GB, PC3-8500, DDR3, 204P, 128MX€
1		6060B0221401	LABEL, BLANK, REEL, 60mm, 20mm
ITEM	PART NAME	PART NO	DESCRIPTION

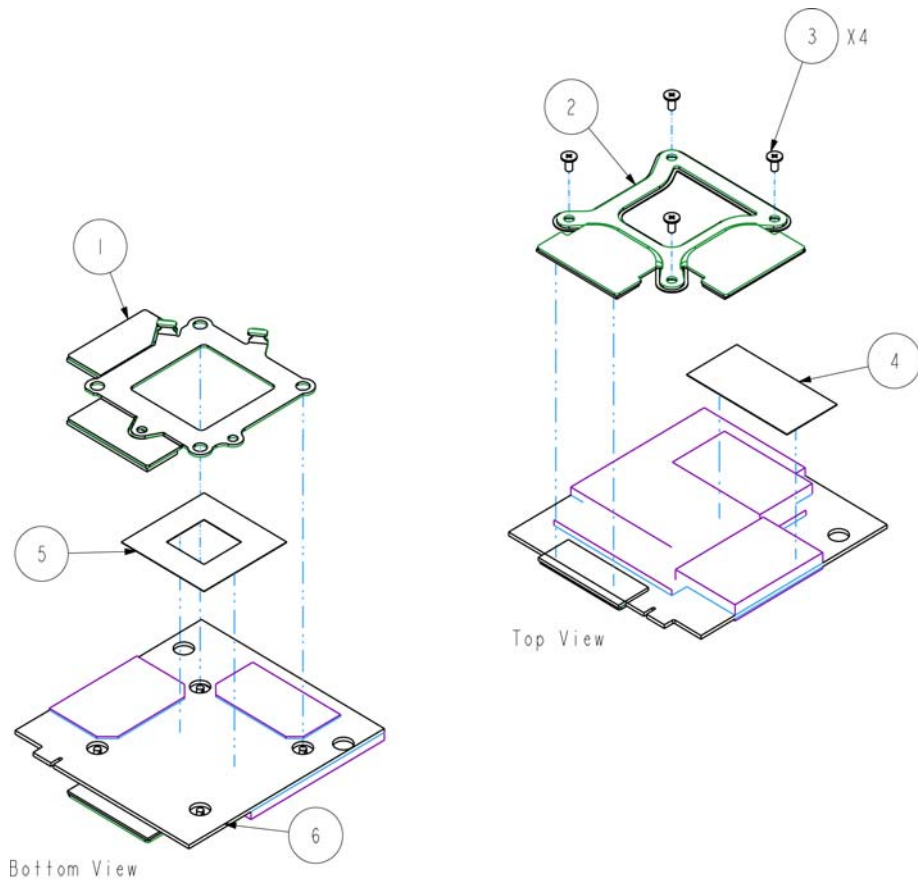

6		6042B0096801	MODULE, MXM GRAPHICS, PCI-EXPRESS	1
5	MXM INSULATOR	6054B0040101	INSULATOR, PCB, MXM, PC	1
4		6060B0238501	LABEL, BLANK, REEL, 40mm, 20mm	1
3	SCREW 120040M	6052A0036901	SCREW, 1, M2.0, 4mm, M, 4.5mm, 0.5mm, BNI, PATCH	4
2		6053B0227901	BRACKET, VGA, BOTTOM, SECC	1
1	BRACKET, TOP, GPU	6053B0346901	BRACKET, TOP, GPU, SECC	1
ITEM	PART NAME	PART NO	DESCRIPTION	Q'TY

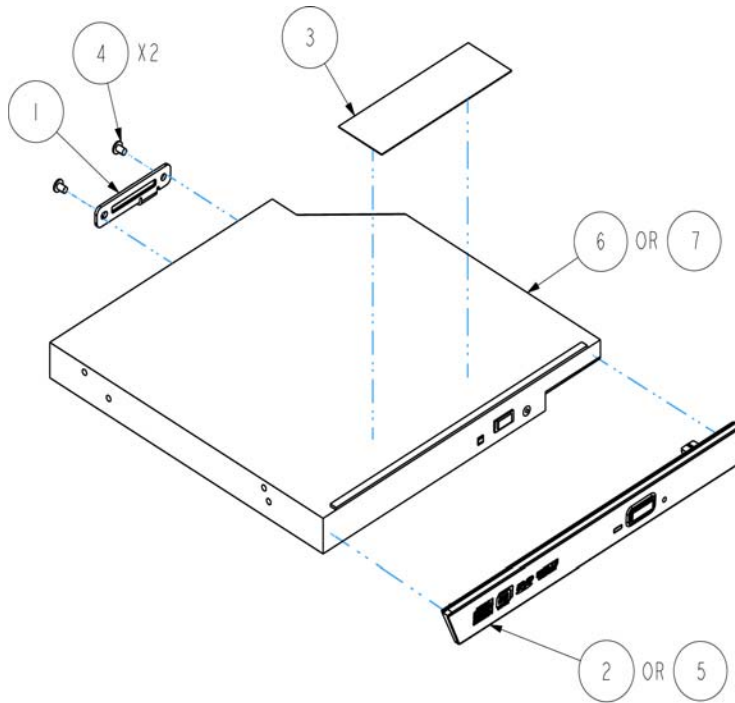

7		6029B0025802	DVD, SUPER MULTI, 5X, 8X, 6X, 8X, 8X, 8X, M2, 128X12.7X126.1mm, SLIM		1
6		6029B0026901	DVD, BD-COMBO, 8X, 16X, 10X, 24X, M2, 128X12.7X126.1mm, SLIM		1
5		1510B0468002	ASSEMBLY, BEZEL, ODD, OFFLINE		1
4		6052A0004501	SCREW-120030M(4.0D*0.4T)-BK-PATCH	2	2
3		6060B0221401	LABEL, BLANK, REEL, 60mm, 20mm	1	1
2		1510B0468001	ASSEMBLY, BEZEL, ODD, OFFLINE		1
1	CDROM BRACKET	6053B0031001	BRACKET, BOTTOM, ODD, SECC		1
ITEM	PART NAME	PART NO	DESCRIPTION		01 02

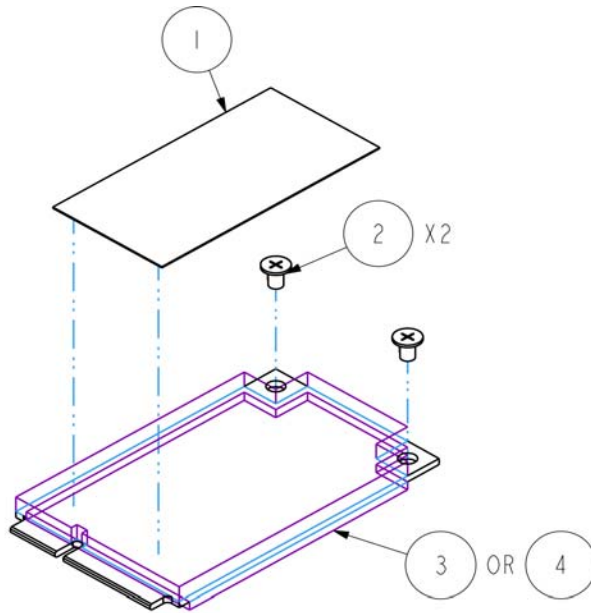

4		6042B0098701	MODULE, ROBSON, 2GB		1
3		6042B0089901	MODULE, TURBO MEMORY, FULL MINI PCI-E/4G	1	
2		6052A0004501	SCREW-120030M(4.0D*0.4T)-BK-PATCH	2	2
1		6060B0238501	LABEL, BLANK, REEL, 40mm, 20mm	1	1
ITEM	PART NAME	PART NO	DESCRIPTION	01	02

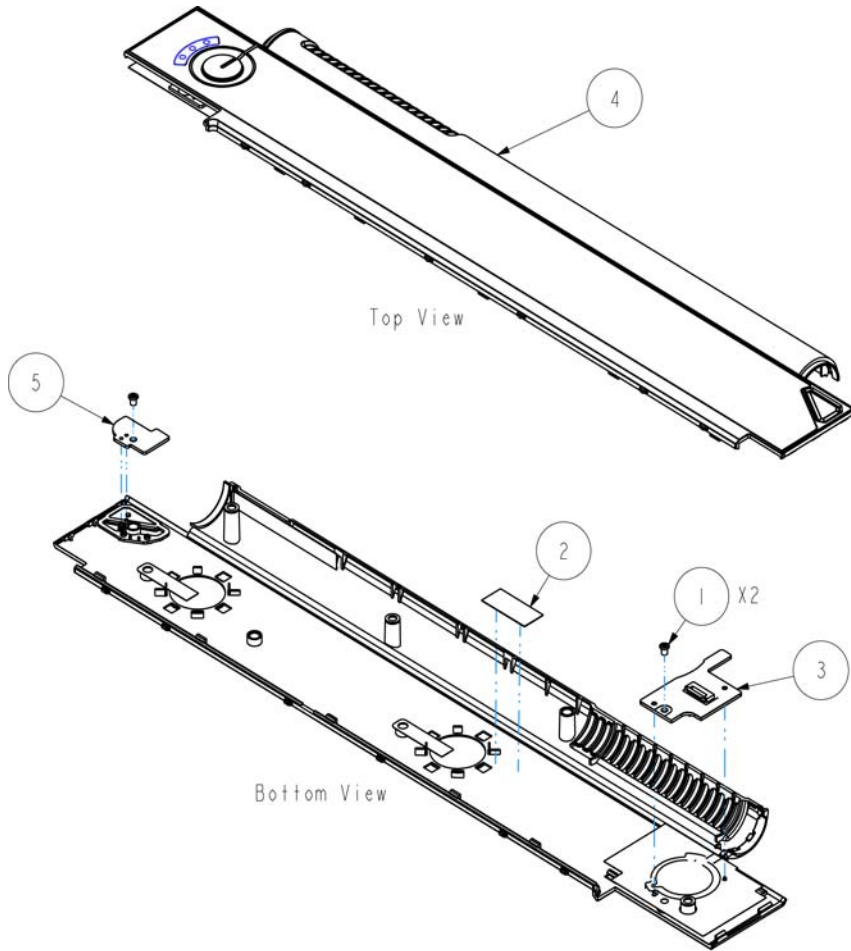

5		1397B0043201	ASSEMBLY,MODULE,EKEY	1
4		1510B0586901	ASSEMBLY,COVER,SWITCH,OFFLINE	1
3		1310A2230001	ASSEMBLY,BOARD,PWR BUTTON	1
2		6060A0086501	LABEL,BLANK-050-25x11	1
1	TOP CASE HINGE SCREW	6052A0024301	SCREW-125030M(4.0DX0.8T)-BK-PATCH	2
ITEM	PART NAME	PART NO	DESCRIPTION	Q'TY

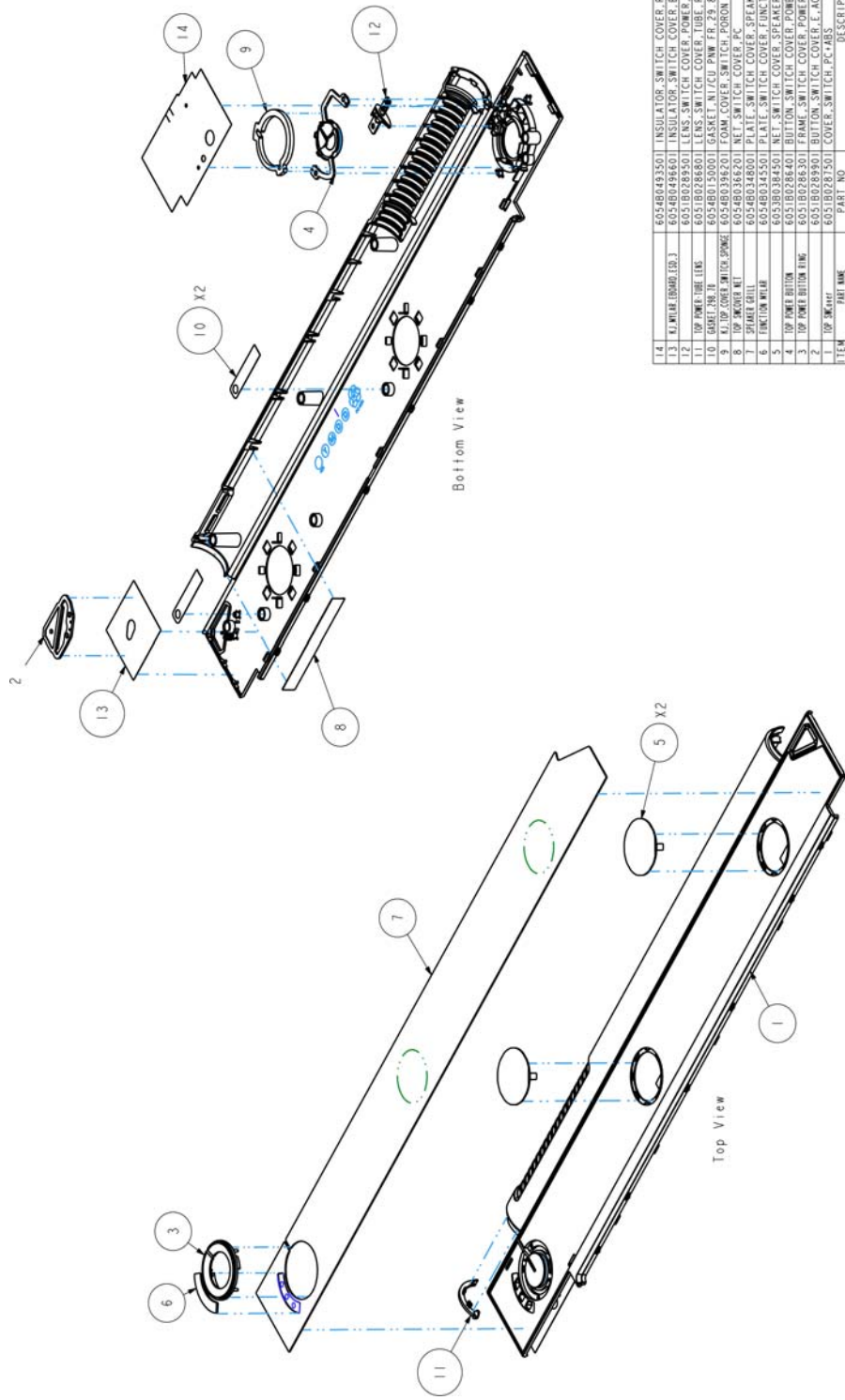

ITEM	PART NAME	DESCRIPTION	QTY
14	605480403501	INSULATOR, SWITCH COVER, POWER, PET	1
13	605480408601	INSULATOR, SWITCH COVER, EMBUTTON, PE500	1
12	605180289501	LENS, SWITCH COVER, POWER, PC	1
11	605180286801	LENS, SWITCH COVER, TUBE, PC	1
10	605480150001	GASKET, NI/CU, PNM, FR, 29.8mm, Tmm, 0.13mm	2
9	605480396201	FOAM, COVER, SWITCH, PORON, M24, ADHESIVE	1
8	605480398201	NET, SWITCH COVER, POWER, SPEAKER, FR700	1
7	605480398201	NET, SWITCH COVER, POWER, SPEAKER, FR700	1
6	605480345501	PLATE, SWITCH COVER, FUNCTION, PC	1
5	605380384501	NET, SWITCH COVER, SPEAKER, SPCC	2
4	605180286401	BUTTON, SWITCH COVER, POWER, PC/ABS, PLATE	1
3	605180286301	FRAME, SWITCH COVER, POWER, ABS, PLATE	1
2	605180289901	BUTTON, SWITCH COVER, E, ACRYLIC/ABS, PVD/PRINT	1
1	605180281501	COVER, SWITCH, PC/ABS	1
	PART NO	DESCRIPTION	QTY

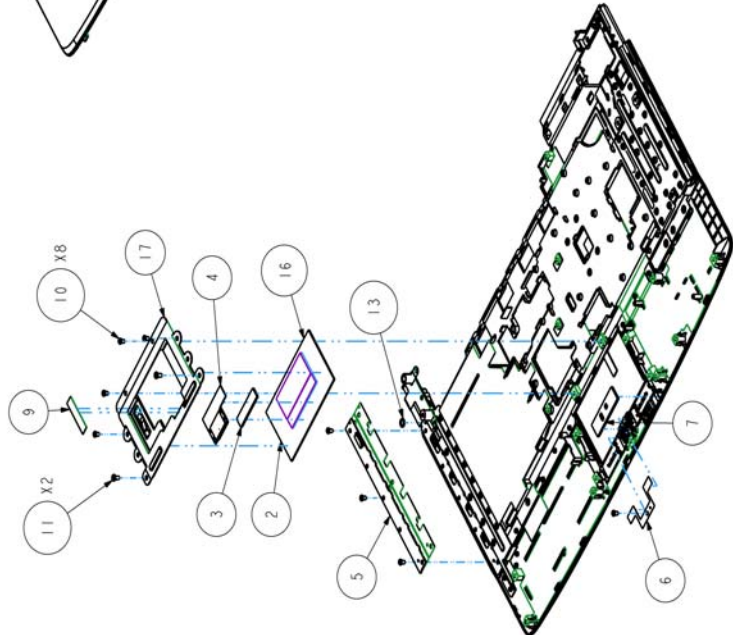
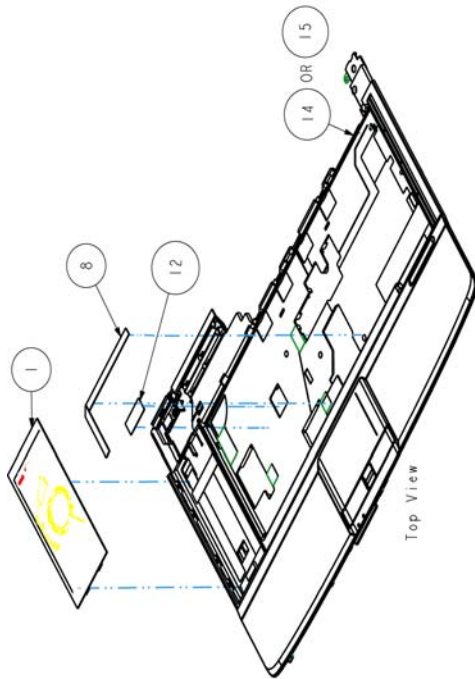

17	6053B0347702	BRACKET, TOP, TOUCH PAD, SGCC	1	1
16	1397B0040401	ASSEMBLY, MODULE, TH BUTTON	1	1
15	1510B0539202	ASSEMBLY, CASE, TOP, OFFLINE	1	1
14	1510B0539201	ASSEMBLY, CASE, TOP, OFFLINE	1	1
13	6052B0034101	WASHER, FLAT, 3.5mm, 6mm, Ø, 3mm, AL PLATE	1	1
12	6060A0086501	LABEL, BLANK-050-25x11	1	1
11	6052A0009901	SCREW, 1.4Z, S+0.45, 4.0mm, MACH, 4.5mm, 1.0mm, CROSS-BN1_PATCH	2	2
10	6052A0024301	SCREW-125030M(4.00X0.8T)-BK-PATCH	8	8
9	6035B0025301	FFC, 6P, IL, 1.18X0.27X0.01, PET, S	1	1
8	6035B0025701	FFC, 12P, IL, 4.7X0.3X0.01, PET, S	1	1
7	6054B0405901	FOAM CHARGE LENS, ML24	1	1
6	6054B0396901	GASNET, FINGER, NI/CU PPM FR	1	1
5	1397B0033201	ASSEMBLY, MODULE, HOTKEY	1	1
4	6042B0086001	MODULE, FINGER PRINTER	1	1
3	6054B0367301	FOAM, MO48, 30.0mm, 8.0mm, 1.3mm	1	1
2	6034B0006601	TOUCH PAD, NO BUTTON, 12P, 19.7X47.7	1	1
1	1397B0037201	ASSEMBLY, MODULE, MEDIA	1	1
ITEM	PART NO	DESCRIPTION		

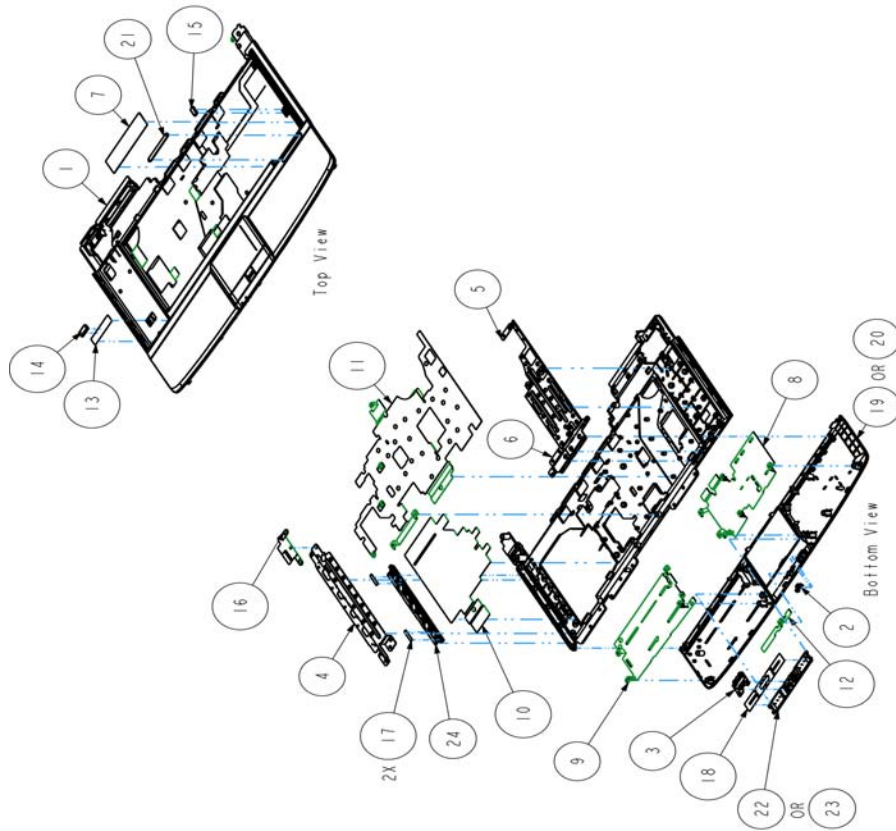

24	TOP Hotkey Button	6051B0289301	BUTTON, TOP, HOTKEY, PC, COAT/LC	1	1
23	TL, TOP, BUTTON, PICK	6051B0286602	BUTTON, TOUCH PAD, PC+ABS, COAT	1	1
22	TL, TOP, BUTTON, PICK	6051B0286601	BUTTON, TOUCH PAD, PC+ABS, IMR	1	1
21	ASPIRE LOGO	6054B0348303	NAMEPLATE, ASPIRE 6935, 45, 0mm, 5, 0mm, 1, 2mm, ACRYLIC, PVD/PRINT	1	1
20	TOP Palmrest	6051B0287704	CASE, TOP, PALMREST, PC+ABS, COAT/PRINT/AC-MT-020	1	1
19	TOP Palmrest	6051B0287703	CASE, TOP, PALMREST, PC+ABS, IMR/AC-MT-020	1	1
18	PICK-BUTTON, SHIELD	6053B0409801	SHIELD, PICK, BUTTON, AL, FOIL	1	1
17		6054B0390801	INSULATOR, BUTTON, PC8010	2	2
16	K/J, TOP, AB, GASKET	6054B00396101	GASKET, TOP, KEYBOARD, NI/CU PPW FR	1	1
15	GASKET, 1046X2	6054A0045901	GASKET, PCT455-USB-0116x2x10L	1	1
14	GASKET, 130X10X25	6054B0215801	GASKET, BELOW, FAN, CONDUCTIVE	1	1
13	GASKET, 40, 10	6054B0281701	GASKET, NI/CU PPW FR, 40mm, 10mm, 0, 1mm	1	1
12	K/J, TOP, TP, AL, FOIL	6053B0381501	SHIELD, TOP, TP, AL, FOIL	1	1
11	K/J, TOP, AB, MB, AL, FOIL	6053B00366501	SHIELD, TOP, K/B, FRAME, AL, FOIL	1	1
10	K/J, TOP, AB, 000, AL, FOIL	6053B0366201	SHIELD, TOP, K/B, FRAME, AL, FOIL, 000	1	1
9	K/J, TOP, AL, FOIL, R	6053B00366301	SHIELD, TOP, RIGHT, AL, FOIL	1	1
8	K/J, TOP, AL, FOIL, L	6053B00366401	SHIELD, TOP, LEFT, AL, FOIL	1	1
7		6054B0412401	INSULATOR, CASE, AB, FRAME, 80mm, 20mm, 0, 4mm, FR700	1	1
6	lj, top, brkt, palmrest	6053B00347101	BRACKET, TOP, PALMREST, SOCC	1	1
5	K/J, TOP, BRKT, HINGE, L	6053B00345601	BRACKET, TOP, LEFT, SOCC	1	1
4	K/J, TOP, BRKT, HINGE, R	6053B00345001	BRACKET, TOP, RIGHT, SUS301	1	1
3	TOP PICK BUTTON BRACKET	6053B00347601	BRACKET, TOP, PICK, BUTTON, AL	1	1
2	TOP Charge Lens	6051B0289401	LENS, TOP, CHARGE, PC	1	1
1	TOP Keyboard Frame	6051B0287601	CASE, TOP, K/B, FRAME, PC+ABS, PRINT	1	1
ITEM PART NAME	PART NO	DESCRIPTION			
				01	02

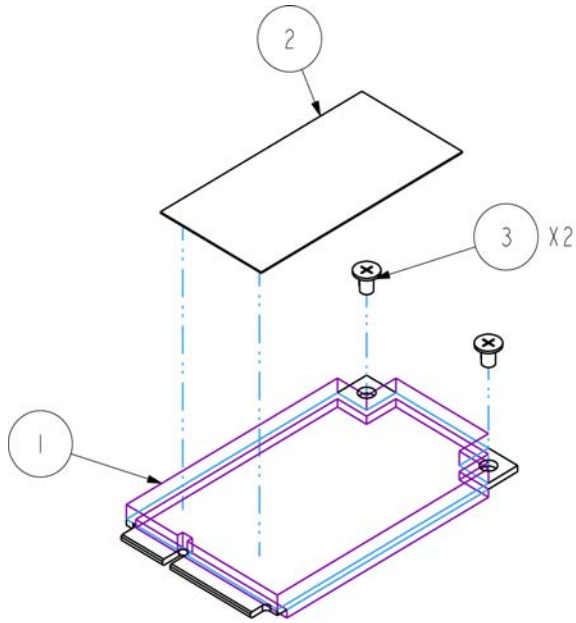

3		6052A0004501	SCREW-120030M(4.0D*0.4T)-BK-PATCH	2
2		6060B0238501	LABEL,BLANK,REEL,40mm,20mm	1
1		6042B0084401	MODULE,DVBT CARD,MINI CARD	1
ITEM	PART NAME	PART NO	DESCRIPTION	Q'TY

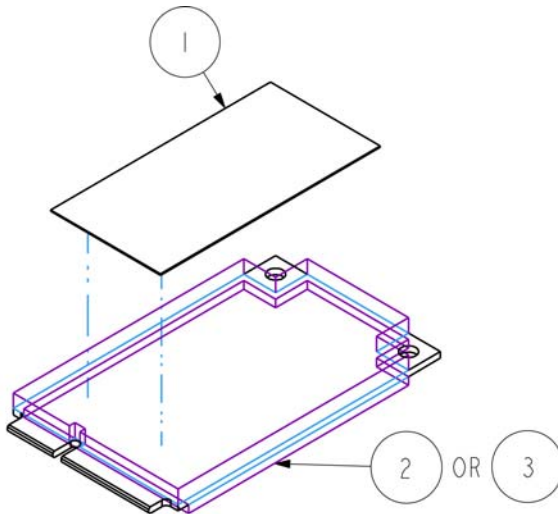

3		6042B0099201	MODULE,PCI E MIMO CARD,802.11B/G/N		1
2		6042B0099301	MODULE,WIRELESS LAN,MINI PCI 802.11B/G/N	1	
1		6060B0238501	LABEL,BLANK,REEL,40mm,20mm	1	1
ITEM	PART NAME	PART NO	DESCRIPTION	01	02

Aspire 6935G FRU List

Accessory

Category	Part Name and Description	Acer Part No.
	REMOTE CONTROLLER FOMOSA21 RC804V-B EU	RT.22700.008
	REMOTE CONTROLLER FOMOSA21 RC804V-B TC	RT.22700.009
	REMOTE CONTROLLER FOMOSA21 RC804V-B SC	RT.22700.010
	REMOTE CONTROLLER FOMOSA21 RC804V-B EN	RT.22700.011
	WISTRON ACER XPRESS CARD PHONE KIT REV 2.0	LC.VIP00.014
	EXTERNAL ANTENNA SET	25.AAMVN.004

Adapter

Category	Part Name and Description	Acer Part No.
	ADAPTER 65W 3PINS DELTA SADP-65KB DFA YELLOW 1.7X5.5X11 LF LEVEL4	AP.06501.013
	ADAPTER 65W 3PINS LITEON PA-1650-02AC 1.7X5.5X11 LF LEVEL4	AP.06503.016
	ADAPTER 65W 3PINS HIPRO HP-OK065B13 1.7X5.5X11 LF LEVEL4	AP.0650A.010
	ADAPTER 90W 3PINS DELTA ADP-90SB BBEA 1.7X5.5X11 LF LEVEL4	AP.09001.013
	ADAPTER 90W LITE-ON PA-1900-24AR BLUE 1.7X5.5X11 LF LEVEL4	AP.09003.011
	ADAPTER 90W HIPRO HPOL093B13P BLUE 1.7X5.5X11 LF LEVEL4	AP.0900A.001
	ADAPTER 65W 3PINS DELTA SADP-65KB BFJA 1.7X5.5X11 LF LEVEL4 FOR OBL SPEC	AP.6501.014





Battery

Category	Part Name and Description	Acer Part No.
	BATTERY LI-ION 6CELL SANYO AS-2007B 3S2P 4400MAH	BT.00603.042
	BATTERY LI-ION 6CELL SONY AS-2007B 3S2P 4400MAH	BT.00604.025
	BATTERY LI-ION 6CELL PANASONIC AS-2007B 3S2P 4400MAH	BT.00605.021
	BATTERY LI-ION 6CELL SIMPLO AS-2007B 3S2P 4400MAH	BT.00607.016
	BATTERY LI-ION 8CELL SANYO AS-2007B 4S2P 4800MAH	BT.00803.024
	BATTERY LI-ION 8CELL SONY AS-2007B 4S2P 4800MAH	BT.00804.020
	BATTERY LI-ION 8CELL PANASONIC AS-2007B 4S2P 4800MAH	BT.00805.011
	BATTERY LI-ION 8CELL SIMPLO AS-2007B 4S2P 4800MAH	BT.00807.015





Board

Category	Part Name and Description	Acer Part No.
	BLUETOOTH BOARD FOXCONN BCM2045 V2 T60H928.11	BT.21100.005
	LED BOARD RIGHT	55.APQ0N.009
	LED BOARD LEFT	55.APQ0N.010
	TOUCHPAD BUTTON BOARD	55.ATP0N.002
	HOTKEY BOARD	55.APQ0N.002
	MEDIA BOARD MODULE	55.APQ0N.005

Category	Part Name and Description	Acer Part No.
	POWER BUTTON BOARD	55.ATP0N.003
	E-KEY BOARD	55.ATP0N.001
	USB BOARD W/O TV CABLE	55.APQ0N.008
	USB BOARD WITH TV CABLE	55.AP40N.001
	I/O BOARD	55.APQ0N.007
	VGA CARD nVidia NB8P-GS DDRII 512MB 400MHz 32*16 MXM II w/ HDCP (IEC VBIOS)	55.AKE0N.004
	Yuan VGA Card nVidia NB9P-GS GDDRIII 512M 800MHz 32*32 MXM II w/ HDCP w/ MPS PowerIC w/DP support Ver. A3	VG.9PG0Y.005
	MSI VGA Card nVidia NB9P-GS GDDRIII 512M 800MHz 32*32 MXM II w/ HDCP w/ Intersil PowerIC w/DP support Ver. A3	VG.9PG06.006
	WIRELESS LAN BOARD 802.11BGN FOXCONN T77H053.00 Atheros AR5B91 1X2	NI.23600.030
	WIRELESS LAN BOARD 802.11BGN FOXCONN T77H028.00 RALINK RT2700E 1X2	NI.23600.031
	WIRELESS LAN BOARD 512AN_HMWG SHIRLEY PEAK 5100 MM#895373 (HALF MINI-CARD)	KI.SPH01.003
	WIRELESS LAN BOARD 512AN_MMWG SHIRLEY PEAK 5100 MM#895361	KI.SPM01.003
		KI.SPH01.001
	WIRELESS LAN BOARD 533AN_MMWG SHIRLEY PEAK MM#895362	KI.SPM01.001
	TV TUNER MINI CARD AVERMEDIA DVB-T A309 REV 1.0	TU.23100.014
	TV TUNER MINI CARD AVERMEDIA DVB-T A310 REV 1.0	TU.23100.010

Category	Part Name and Description	Acer Part No.
	FLASH MODULE 2GB INTEL NVCPEMWR002G2 LF	KF.2GB0N.002
	FLASH MODULE 4GB INTEL NVCPEMWR004G2 LF	KF.4GB0N.002
	FINGER PRINT BOARD	55.APQ0N.001
	TOUCHPAD SYNAPTICS TM-00372-012	56.APQ0N.001
	MODEM BOARD MDC 1.5 FOXCONN T60M951.36 (AGERE 1.5_ 3.3V) AUSTRALIA APPROVED	FX.22500.023

Cable

Category	Part Name and Description	Acer Part No.
	POWER CORD 3PIN USA	27.AAMVN.001
	POWER CORD 3PIN EUR	27.AAMVN.002
	POWER CORD 3PIN SOUTH AFRICA	27.AAMVN.008
	POWER CORD 3PIN DENMARK	27.AAMVN.010
	POWER CORD ISRAEL	27.AAMVN.011
	POWER CORD 3PIN ITALIAN	27.AAMVN.009
	POWER CORD 3PIN UK	27.AAMVN.004
	POWER CORD 3PIN SWISS	27.AAMVN.006
	POWER CORD AUSTRALIA W/LABEL	27.AAMVN.003
	POWER CORD 3PIN CHINA	27.AAMVN.005
	POWER CORD SOUTH AFRICA (AIL)	27.AAMVN.007
	POWER CORD 3PIN USA	27.AAMVN.001
	"LCD/CAMERA CABLE 16" "WUXGA/ WXGA"	50.APQ0N.012
	"LCD/CAMERA CABLE 16""WXGA"	50.APQ0N.013
	DC-IN CABLE	50.APQ0N.011
	DC-IN CABLE	50.APD0N.001

Category	Part Name and Description	Acer Part No.
	MODEM CABLE WITH RJ11	50.APQ0N.010
	BLUETOOTH BOARD CABLE	50.APQ0N.009
	FINGER PRINT BOARD CABLE	50.APQ0N.001
	HOTKEY BOARD CABLE	50.APQ0N.002
	POWER BUTTON BOARD CABLE	50.APQ0N.003
	TOUCH BUTTON BOARD CABLE	50.APQ0N.004
	MEDIA BOARD CABLE	50.APQ0N.005
	E-KEY BOARD CABLE	50.APQ0N.006
	USB BOARD CABLE	50.APQ0N.007
	TOUCHPAD CABLE	50.APQ0N.008

Camra

Category	Part Name and Description	Acer Part No.
	CAMERA 0.3M SUYIN	57.APQ0N.001
	CAMERA 0.3M BISON BN30V407-010	57.ASY0N.001
	CAMERA 1.0M SUYIN CN1014-S36B-OV01	57.ASY0N.002

CASE/COVER/BRACKET ASSEMBLY

Category	Part Name and Description	Acer Part No.
	MINI DUMMY CARD	42.APQ0N.008
	SD DUMMY CARD	42.APQ0N.009
	BD COMBO BEZEL	42.APQ0N.005
	SUPER-MULTI BEZEL	42.APQ0N.004
	LCD COVER 16"	60.ATP0N.003
	LCD BEZEL 16"	60.APQ0N.004
	LCD BRACKET RIGHT	33.APQ0N.004
	LCD BRACKET LEFT	33.APQ0N.005
	UPPER CASE WITH FINGERPRINT HOLE	60.ATP0N.002
	TOUCHPAD BRACKET	33.ASY0N.001
	LOWER CASE WITH TV PORT	60.ATQ0N.001
	LOWER CASE W/O TV PORT	60.ATP0N.001
	MIDDLE COVER	42.APQ0N.001

Category	Part Name and Description	Acer Part No.
	UNILOAD COVER	42.ATP0N.002
	MPCI COVER	42.APQ0N.003
	OPTICAL BRACKET	33.AAMVN.002
	KENSINGTON BRACKET	33.APQ0N.006
	HINGE COVER ASSEMBLY LEFT	42.APQ0N.007
	HINGE COVER ASSEMBLY RIGHT	42.APQ0N.006
	VGA BRACKET TOP	33.APQ0N.003
	VGA BRACKET BOTTOM	33.AKE0N.005
	HALF MINI-CARD BRACKET	33.TQP0N.002

CPU/PROCESSOR

Category	Part Name and Description	Acer Part No.
	CPU INTEL CORE2DUAL P8400 PGA 2.26G 3M 1066 25W	KC.84001.DPP
	CPU INTEL CORE2DUAL P8600 PGA 2.4G 1066 25W 3M	KC.86001.DPP
	CPU INTEL CORE2DUAL P9500 PGA 2.53G 6M 1066 25W	KC.95001.DPP
	CPU INTEL CORE2DUAL T9400 PGA 2.53G 6M 1066 35W	KC.94001.DTP
	CPU INTEL CORE2DUAL T9600 PGA 2.8G 6M 1066 35W	KC.96001.DTP
	CPU INTEL CORE2DUAL P7350 PGA 2.0G 3M 1066 25W	KC.73501.DPP

DVD RW DRIVE

Category	Part Name and Description	Acer Part No.
	ODD SONY BD COMBO 12.7MM TRAY DL 2X BC-5500S LF W/O BEZEL SATA	KO.0020E.002
	ODD SONY SUPER-MULTI DRIVE 12.7MM TRAY DL 8X AD-7580S LF W/O BEZEL SATA	KU.0080E.017
	ODD PLDS SUPER-MULTI DRIVE 12.7MM TRAY DL 8X DS-8A2S LF W/O BEZEL SATA	KU.0080F.001
	DVD-RW DRIVE 8X SUPER-MULTI TRAY PIONEER DVR-KD08RS LF W/O BEZEL F/ W:1.00 PATA	KU.00805.043





FAN

Category	Part Name and Description	Acer Part No.
	FAN	23.APQ0N.001

INVERTER

Category	Part Name and Description	Acer Part No.
	INVERTER BOARD TDKTBD484NR	19.APQ0N.001



HEATSINK

Category	Part Name and Description	Acer Part No.
	CPU HEATSINK FOR 965GM	60.APD0N.002
	CPU HEATSINK FOR 965PM	60.APQ0N.003
	CPU HEATSINK FINGER	33.APD0N.001
	CPU HEATSINK FINGER	33.APQ0N.002

LCD

Category	Part Name and Description	Acer Part No.
	"LCD 16" "WXGA SAMSUNG LTN160AT01-A01 GLARE LF 220NIT 8MS 600:1 16:9"	LK.16006.001
	"LCD 16" "WXGA SAMSUNG LTN160AT01-A02 GLARE LF 220NIT 8MS"	LK.16006.003
	"LCD 16" "WUXGA SAMSUNG LTN160HT01-A02 GLARE LF 220NIT 8MS 600:1 60%, 16:9"	LK.16006.004

MAIN BOARD

Category	Part Name and Description	Acer Part No.
	MAINBOARD AS6935G DISCRETE INTEL PM45 ICH9 LF	MB.ATN0B.002
	MAINBOARD AS6935 UMA INTEL GM45 ICH9 LF	MB.ATN0B.001

HDD/HARD DISK DRIVER

Category	Part Name and Description	Acer Part No.
	HDD 120GB SATA 5400RPM SEAGATE ST9120817AS CORSAIR LF F/W:3.AAA	KH.12001.032
	HDD 120GB 5400RPM SATA TOSHIBA MK1252GSX LF F/W:LV010J	KH.12004.008
	HDD 120GB 5400RPM SATA HGST HTS543212L9A300 LF F/W:C40C	KH.12007.016
	HDD 120GB 5400RPM SATA WD WD1200BEVS-22UST0 ML125 LF F/W:01.01A01	KH.12008.019
	HDD 160GB 5400RPM SATA SEAGATE ST9160310AS CORSAIR LF F/W:30303	KH.16001.034
	HDD 160GB 5400RPM SATA TOSHIBA MK1652GSX LF F/W:LV010J	KH.16004.003
	HDD 160GB 5400RPM SATA HGST HTS543216L9A300 LF F/W:C40C	KH.16007.019
	HDD 160GB 5400RPM SATA WD WD1600BEVT-22ZCT0 ML160 LF F/W:11.01A11	KH.16008.022
	HDD 160GB 5400RPM SATA SEAGATE ST9250827AS CORSAIR LF F/W:3.AAA	KH.25001.011
	HDD 250GB 5400RPM SATA TOSHIBA MK2552GSX LF F/W:LV010J	KH.25004.002
	HDD 250GB 5400RPM SATA HGST HTS543225L9A300 LF F/W:C40C	KH.25007.013
	HDD 250GB 5400RPM SATA WD WD2500BEVS-22UST0 ML125 LFF/W:01.01A01	KH.25008.018
	HDD 320GB 5400RPM SATA WD WD3200BEVT-22ZCT0 ML160 LF F/W:11.01A11	KH.32008.013
	HDD 320GB 5400RPM SATA SEAGATE ST9320320AS LF F/W:0303	KH.32001.008
	HDD 320GB 5400RPM SATA SEAGATE ST9320320AS LF F/W:0303	KH.32004.001
	HDD 320GB 5400RPM SATA TOSHIBA MK3252GSX LF F/W:LV010J	KH.32007.004

SPEAKER

Category	Part Name and Description	Acer Part No.
	SPEAKER SET W/ SUBWOOFER	23.APQ0N.002

KEYBOARD





Category	Part Name and Description	Acer Part No.
	KEYBOARD 15_16KB-FV1 88KS BLACK US INTERNATIONAL (GLOSSY)	KB.INT00.261
	KEYBOARD 15_16KB-FV1 89KS BLACK TURKISH (GLOSSY)	KB.INT00.264
	KEYBOARD 15_16KB-FV1 88KS BLACK THAILAND (GLOSSY)	KB.INT00.265
	KEYBOARD 15_16KB-FV1 89KS BLACK SWISS/G (GLOSSY)	KB.INT00.266
	KEYBOARD 15_16KB-FV1 89KS BLACK SWEDISH (GLOSSY)	KB.INT00.267
	KEYBOARD 15_16KB-FV1 89KS BLACK SPANISH (GLOSSY)	KB.INT00.268
	KEYBOARD 15_16KB-FV1 89KS BLACK SLOVAK (GLOSSY)	KB.INT00.269
	KEYBOARD 15_16KB-FV1 89KS BLACK SLO/CRO (GLOSSY)	KB.INT00.270
	KEYBOARD 15_16KB-FV1 88KS BLACK RUSSIAN (GLOSSY)	KB.INT00.271
	KEYBOARD 15_16KB-FV1 89KS BLACK PORTUGUESE (GLOSSY)	KB.INT00.272
	KEYBOARD 15_16KB-FV1 89KS BLACK POLISH (GLOSSY)	KB.INT00.273
	KEYBOARD 15_16KB-FV1 89KS BLACK NORWEGIAN (GLOSSY)	KB.INT00.274
	KEYBOARD 15_16KB-FV1 88KS BLACK KOREAN (GLOSSY)	KB.INT00.276
	KEYBOARD 15_16KB-FV1 88KS BLACK JAPANESE (GLOSSY)	KB.INT00.277
	KEYBOARD 15_16KB-FV1 89KS BLACK ITALIAN (GLOSSY)	KB.INT00.278
	KEYBOARD 15_16KB-FV1 89KS BLACK HUNGARIAN (GLOSSY)	KB.INT00.281
	KEYBOARD 15_16KB-FV1 88KS BLACK GREEK (GLOSSY)	KB.INT00.282
	KEYBOARD 15_16KB-FV1 89KS BLACK GERMAN (GLOSSY)	KB.INT00.283
	KEYBOARD 15_16KB-FV1 89KS BLACK FRENCH (GLOSSY)	KB.INT00.284
	KEYBOARD 15_16KB-FV1 89KS BLACK DUTCH (GLOSSY)	KB.INT00.286
	KEYBOARD 15_16KB-FV1 89KS BLACK DANISH (GLOSSY)	KB.INT00.287
	KEYBOARD 15_16KB-FV1 89KS BLACK CZECH (GLOSSY)	KB.INT00.288
	KEYBOARD 15_16KB-FV1 88KS BLACK TRADITIONAL CHINESE (GLOSSY)	KB.INT00.289
	KEYBOARD 15_16KB-FV1 89KS BLACK CANADIAN FRENCH (GLOSSY)	KB.INT00.290
	KEYBOARD 15_16KB-FV1 89KS BLACK BRAZILIAN PORTUGUESE (GLOSSY)	KB.INT00.291
	KEYBOARD 15_16KB-FV1 89KS BLACK BELGIUM (GLOSSY)	KB.INT00.292

Category	Part Name and Description	Acer Part No.
	KEYBOARD 15_16KB-FV1 88KS BLACK ARABIC/ENGLISH (GLOSSY)	KB.INT00.293
	KEYBOARD 15_16KB-FV1 89KS BLACK ARABIC/FRENCH (GLOSSY)	KB.INT00.294
	KEYBOARD 15_16KB-FV1 89KS BLACK NORDIC (GLOSSY)	KB.INT00.295
	KEYBOARD 15_16KB-FV1 89KS BLACK ENGLISH/CANADIAN FRENCH (GLOSSY)	KB.INT00.296

MEMORY

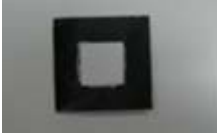
Category	Part Name and Description	Acer Part No.
	SO-DIMM 1GB DDRIII1066 MICRON MT8JSF12864HY-1G1D1 LF	KN.1GB04.003
	SO-DIMM 1GB DDRIII1066 ELPIDA EBJ11UE6BAU0-AE-E LF	KN.1GB09.009
	SO-DIMM 1GB DDRIII1066 SAMSUNG M471B2874DZ1-CF8 LF	KN.1GB0B.019
	SO-DIMM 1GB DDRIII1066 HYNIX HMT112S6AFP6C-G7N0 LF	KN.1GB0G.019
	SO-DIMM 2GB DDRIII1066 MICRON MT16JSF25664HY-1G1D1 LF	KN.2GB04.004
	SO-DIMM 2GB DDRIII1066 ELPIDA EBJ21UE8BAU0-AE-E LF 128*8 0.07um	KN.2GB09.002
	SO-DIMM 2GB DDRIII1066 SAMSUNG M471B5673DZ1-CF8 LF	KN.2GB0B.005
	SO-DIMM 2GB DDRIII1066 HYNIX HMT125S6AFP8C-G7N0 LF	KN.2GB0G.009

MISCELLANEOUS

Category	Part Name and Description	Acer Part No.
	LCD CHUSION	47.APQ0N.001
	VGA BOARD INSULATOR	47.AKE0N.002
	HDD INSULATOR	47.ASY0N.001
	ANTENNA, DUAL, 2.4/5.2G, 810mm, 1.37mm	50.ATP0N.001
	ANTENNA, DUAL, 2.4/5.2G, 910mm, 1.37mm	50.ATP0N.002
	MICROPHONE	23.ATP0N.001

SCREW

Category	Part Name and Description	Acer Part No.
	SCREW M2.5X0.45	86.APQ0N.001
	SCREW-I25030M (4.0DX0.8T)-BK-PATCH	86.APQ0N.002
	SCREW	86.AAMVN.001
	SCREW BNI PAT	86.TLT0N.002
	SCREW I M2 6MM M 4.5MM 0.8MM PHIL BK PATCH	86.APQ0N.004
	SCREW I M2.5 2.5MM MACH 4.5MM 0.8MM CROSS BNI PATCH	86.APQ0N.005

Free Manuals Download Website

<http://myh66.com>

<http://usermanuals.us>

<http://www.somanuals.com>

<http://www.4manuals.cc>

<http://www.manual-lib.com>

<http://www.404manual.com>

<http://www.luxmanual.com>

<http://aubethermostatmanual.com>

Golf course search by state

<http://golfingnear.com>

Email search by domain

<http://emailbydomain.com>

Auto manuals search

<http://auto.somanuals.com>

TV manuals search

<http://tv.somanuals.com>