

Aspire M5700

Service Guide

Service guide files and updates are available on the AIPG/CSD web; for more information please refer to <http://csd.acer.com.tw>

PRINTED IN TAIWAN

Revision History

Please refer to the table below for the updates made on Persian II Aspire M5700 Service Guide.

Date	Chapter	Updates

Copyright

Copyright © 2007 by Acer Incorporated. All rights reserved. No part of this publication may be reproduced, transmitted, transcribed, stored in a retrieval system, or translated into any language or computer language, in any form or by any means, electronic, mechanical, magnetic, optical, chemical, manual or otherwise, without the prior written permission of Acer Incorporated.

Disclaimer

The information in this guide is subject to change without notice.

Acer Incorporated makes no representations or warranties, either expressed or implied, with respect to the contents hereof and specifically disclaims any warranties of merchantability or fitness for any particular purpose. Any Acer Incorporated software described in this manual is sold or licensed "as is". Should the programs prove defective following their purchase, the buyer (and not Acer Incorporated, its distributor, or its dealer) assumes the entire cost of all necessary servicing, repair, and any incidental or consequential damages resulting from any defect in the software.

Acer is a registered trademark of Acer Corporation.

Intel is a registered trademark of Intel Corporation.

Pentium 4 and Celeron are trademarks of Intel Corporation.

Other brand and product names are trademarks and/or registered trademarks of their respective holders.

Conventions

The following conventions are used in this manual:

SCREEN MESSAGES	Denotes actual messages that appear on screen.
NOTE	Gives bits and pieces of additional information related to the current topic.
WARNING	Alerts you to any damage that might result from doing or not doing specific actions.
CAUTION	Gives precautionary measures to avoid possible hardware or software problems.
IMPORTANT	Remind you to do specific actions relevant to the accomplishment of procedures.

Preface

Before using this information and the product it supports, please read the following general information.

1. This Service Guide provides you with all technical information relating to the BASIC CONFIGURATION decided for Acer's "global" product offering. To better fit local market requirements and enhance product competitiveness, your regional office MAY have decided to extend the functionality of a machine (e.g. add-on card, modem, or extra memory capability). These LOCALIZED FEATURES will NOT be covered in this generic service guide. In such cases, please contact your regional offices or the responsible personnel/channel to provide you with further technical details.
2. Please note WHEN ORDERING FRU PARTS, that you should check the most up-to-date information available on your regional web or channel. If, for whatever reason, a part number change is made, it will not be noted in the printed Service Guide. For ACER-AUTHORIZED SERVICE PROVIDERS, your Acer office may have a DIFFERENT part number code to those given in the FRU list of this printed Service Guide. You MUST use the list provided by your regional Acer office to order FRU parts for repair and service of customer machines.

System Specifications

Features

Operating System

- Microsoft Windows Vista (Home Basic, Home Premium, Business)

Processor

- Socket Type: Intel® Socket T LGA 775 pin
- Processor Type:
 - Intel Conroe/Kensfield/Wolfdale/Yorkfield CPUs
 - FSB 800/ 1066/1333 MHz CPUs

Chipset

- Intel G45 + ICH10R

PCB

- Form Factor: Micro ATX
- Dimension/Layer: 244mm x244mm

Memory

- Memory Type: DDR2 667/800
- Support single channel 64 bit mode with maximum memory size up to 8GB
- Support un-buffered DIMM (ICH10R)
- DIMM Slot: 4
- Memory Max: 1GB to 8GB DDR2 memory technologies
- Capacity: Up to 2GB per DIMM with maximum memory size up to 8GB

PCI

- PCI Express Slot Type: x16
 - PCI Express x16 Slot Quantity: 1
- PCI Express Slot Type: x1
 - PCI Express x1 Slot Quantity: 1
- PCI Slot Type: PCI 2.3 5V slots

-
- PCI Slot Quantity: 2

FDD

- Slot Quantity: 1
- Design Criteria:
 - Should support 1.44MB/3 mode 3.5" Devices

SATA

- Slot Type: SATA slot
- Slot Quantity: 6
- Storage Type support:
 - HDD/CD-ROM/CD-RW/DVD-ROM/DVD-RW/DVD+RW/DVD Dual/DVD SuperMultiPlus/Blu-Ray ODD

Audio

- Audio Type: HD audio codec
- Audio Channel: 7.1 channel
- Audio Controller /Codec: ALC888S HD codec 7.1
- Connectors support:
 - Rear 6 jack follow HD audio definition, example as below
 - Audio jacks color coding: should meet Microsoft Windows Logo Program Device Requirements: Audio-0002
 - 1 S/PDIF-out header (1*4)
 - 1 AUX-In header (1*4)
 - 1 front panel audio header (2*5)
 - Add HD de-pop CKT (the attachment is the reference, please propose your solution)
 - S/N ratio: 90 dB at rear output jack

LAN

- MAC Controller: ICH10R
- Should be worked under 10M/100M/1000Mbs environment

-
- PHY: Intel Boazman 82567V PCI-E Giga LAN.

USB

- Controller Type: ICH10R
- Ports Quantity: 12
 - 4 back panel ports
 - On-board: 3 2*5 headers (6 ports)
 - 4 ports for front daughter board
 - 2 ports reserved.
 - 2 ports for internal card reader
 - Connector Pin: standard Intel FPIO pin definition
- Data transfer rate support:
 - USB 2.0/1.1

1394

- Controller: VIA VT6308P 1394a controller
- Connector Quantity: 2
 - 1 rear 6pin IEEE1394 port
 - 1 2x5pin onboard jumper

BIOS

- BIOS Type: Phoenix Award or AMI Kernel with Acer skin
- Size: 32Mb
- Note:
 - Boot ROM should be included (PXE function should be built in with default and RPL function is optional by service BIOS)
 - BIOS shall auto detect FDD to avoid checksum error when boot

I/O Connector

- Controller: Super I/O ITE ITE8720 (F stepping or after; must full support Intel platform)

Rear I/O Connector

- 1 PS/2 Keyboard port,
- 1 PS/2 Mouse port,
- 1 COM port
- 1 x VGA port
- 1 RJ45 LAN port,
- 1 IEEE 1394 port
- 4 USB ports
- 7.1 channel phone jack (6 audio jacks)

On-board connectors

- 1 CPU socket
- 4 DDR-2 memory sockets
- 1 PCI Express x16 slot
- 1 PCI Express x 1 slot
- 2 PCI slots
- 1 FDD slot
- 6 SATA connectors
- 3 2*5 pin Intel FPIO specification USB pin connectors (follow Intel FPIO standard Specification)
- 1 2*5 pin IEEE1394 jumper (reserve header on all SKU)
- 1 2*5 pin Intel FPIO spec. Microphone In/ Headphone Out pin connectors
- 1 serial port 2*5 pin connector
- 1 AUX-In 4pin connector
- 1 1*4 S/PDIF out header
- 1 4 pin CPU Fan connector
- 1 3 pin System FAN connector with linear circuit
- 1 24pin + 4pin ATX interface PS3/PS2 SPS connector
- 1 2*7 pin front panel IO header

-
- 1 Jumper for clear CMOS
 - 1 on board buzzer
 - Color management for on board connector (pls provide proposal)
 - 1 2*10 pin TPM module connector(Reserved)
 - 1 2*4 pin internal speaker header(Reserved)
 - 1 2pin Intrusion Alarm connector(Reserved)
 - 1 2pin OBR header(Reserved)
 - 1 Parallel port connector(Reserved)
 - 2 2pin GPIO connector

Power Supply

- Power Supply Mounting Features
 - Chassis accepts ATX-style power supply
 - Chasses accepts PS2, PS3 style power supply
 - Features for internal mounting tab
 - Location of 4 external mounting holes
- Power Supply Electrical Design Feature
 - 400W /300W/250W in stable mode (Acer Assign System Power Unit)
 - Design for NVidia MCP7A series chipset compatible system
 - Voltage design should be covered +5V, +3.3V, +12V, +5VSB, -12V (attention to 12V output capability)
 - Demand for both PFC/Non-PFC solutions (two different quotations are needed)
 - Minimum 4 Serial ATA power connector solution should be included (by default)
 - Minimum 3 big 4-pin power connector included
 - Minimum 1 small 4-pin power connector included
 - PFC version will not provide switch selector for 115/230V AC input but it should be universal for Europe and China

-
- Non-PFC version should provide switch selector for 115/230V AC input and universal for worldwide
 - PS2 style

Main board Placement

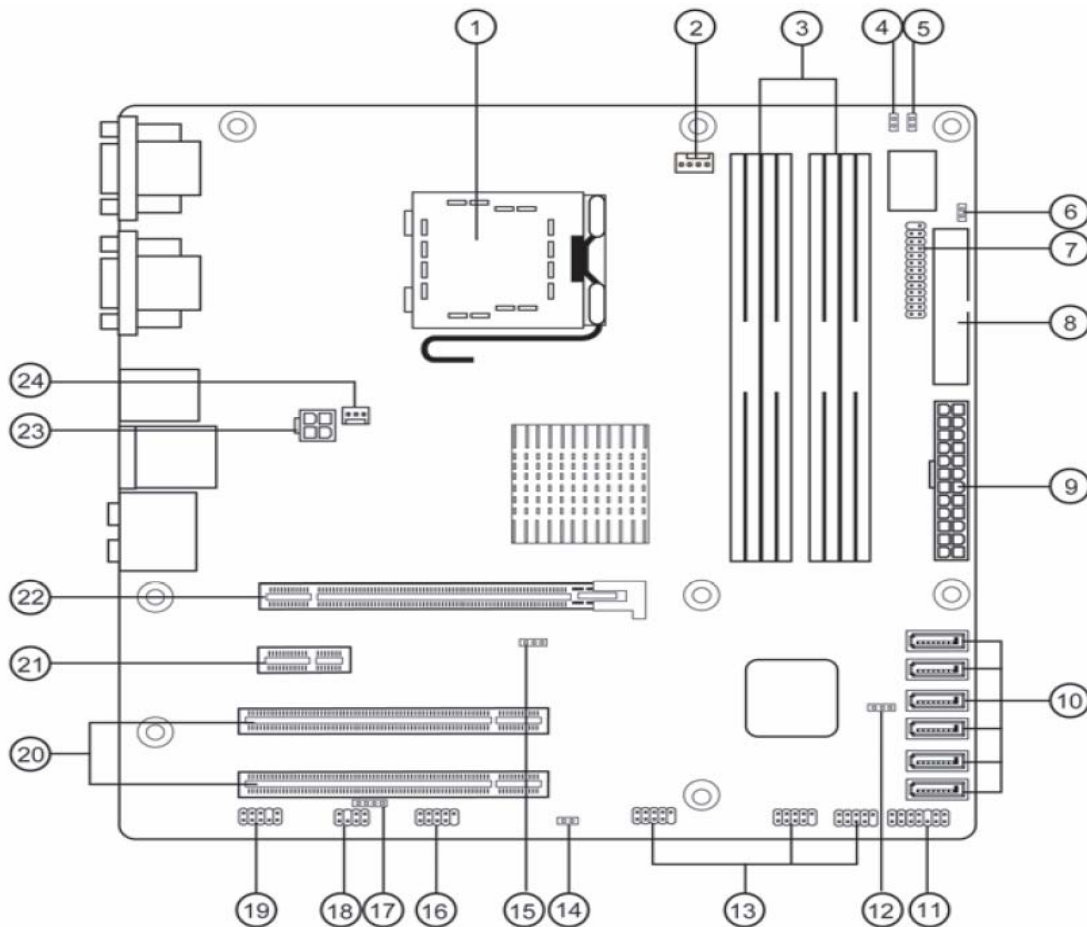
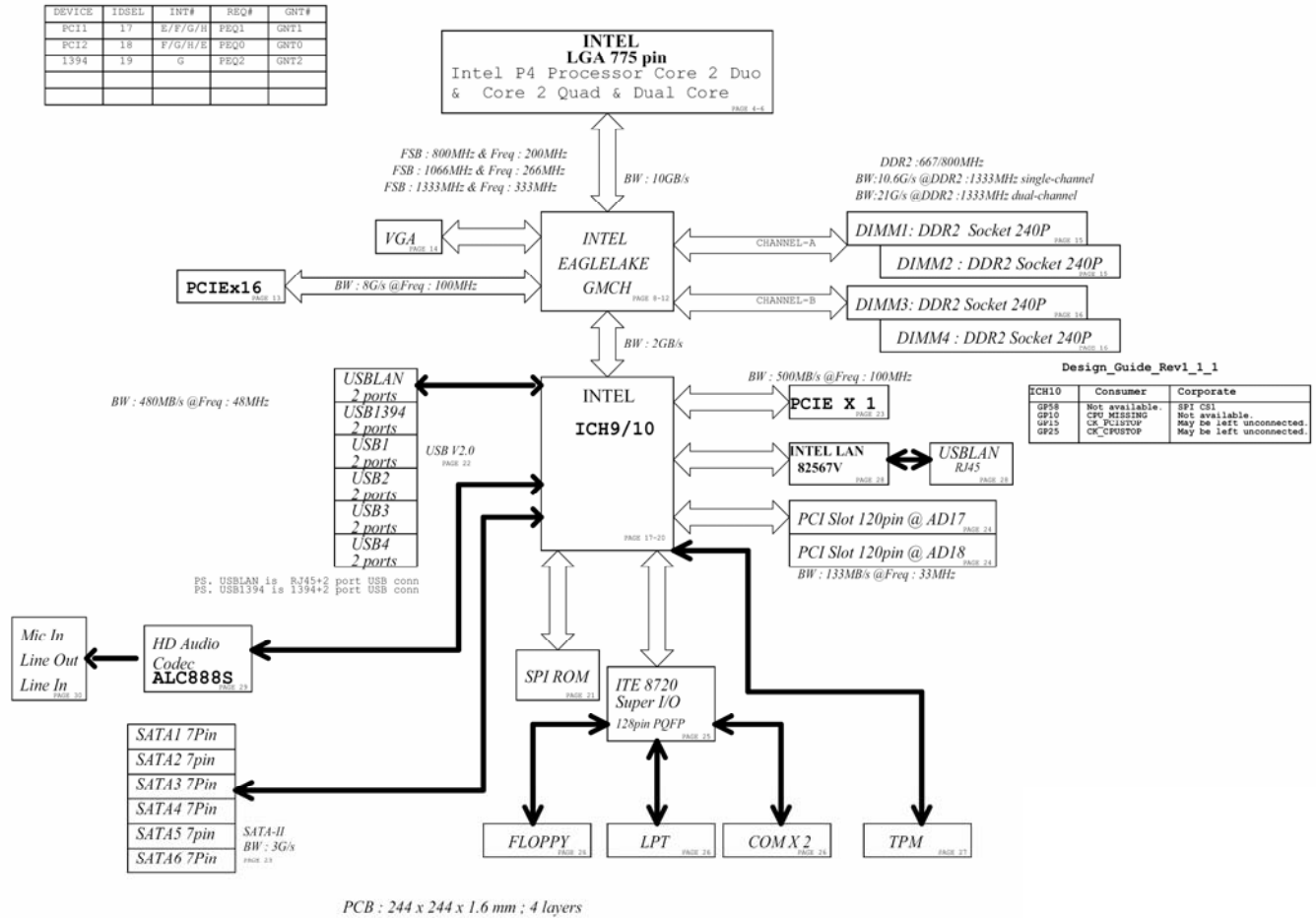

Table of Motherboard Components

LABEL	COMPONENTS
1. CPU Socket	LGA775 socket for Intel [®] Kentsfield/ Yorkfield/Wolfdale/Core™ 2 Duo CPUs
2. CPU_FAN	CPU cooling fan connector
3. DIMM1-4	240-Pin DDR3 SDRAM slots (Channel A: DIMM1, DIMM2 Channel B: DIMM3, DIMM4)
4. OBR	One button recovery jumper
5. GPIO1	General Purpose Input/Output 1
6. GPIO2	General Purpose Input/Output 2
7. PRINTER	Onboard parallel port header
8. FDD1	Floppy disk drive connector
9. ATX POWER1	Standard 24-pin ATX power connector
10. SATA1-6	Serial ATA connectors
11. F_PANEL	Front panel switch/LED header
12. ME_DISABLE	ME Disable jumper
13. F_USB1-3	Front panel USB headers
14. C_INTRUSION	Chassis detect header
15. CLR_CMOS	Clear CMOS jumper
16. COM2	Onboard serial port header
17. SPDIF_OUT	SPDIF out header
18. INT_SPK	Speaker header
19. F_AUDIO	Front panel audio header
20. PCI1-2	32-bit add-on card slots
21. PCIEX1	PCI Express x1 slot
22. PCIEX1	PCI Express slot for graphics interface
23. ATX12V1	Auxiliary 4-pin power connector
24. SYS_FAN	System cooling fan connector

Block Diagram



Aspire M5700 Front Panel

The computer's front panel consists of the following:

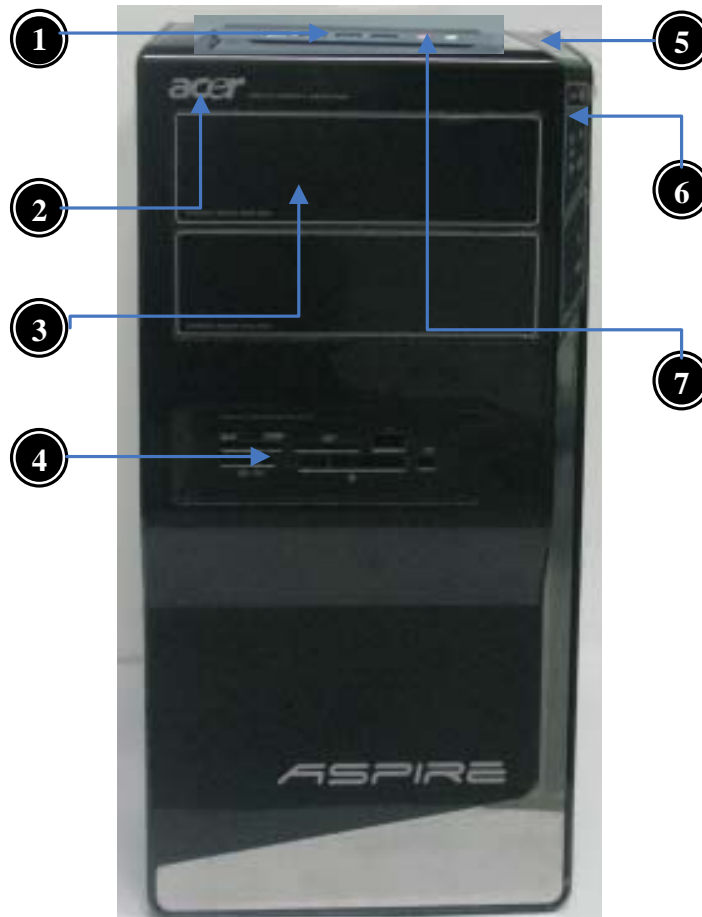

Label	Description
1	USB ports
2	Floppy disk drive Acer Logo
3	Optical drive
4	Card reader
5	Power button
6	LED module
7	Speaker /Microphone jack

Aspire M5700 Rear Panel

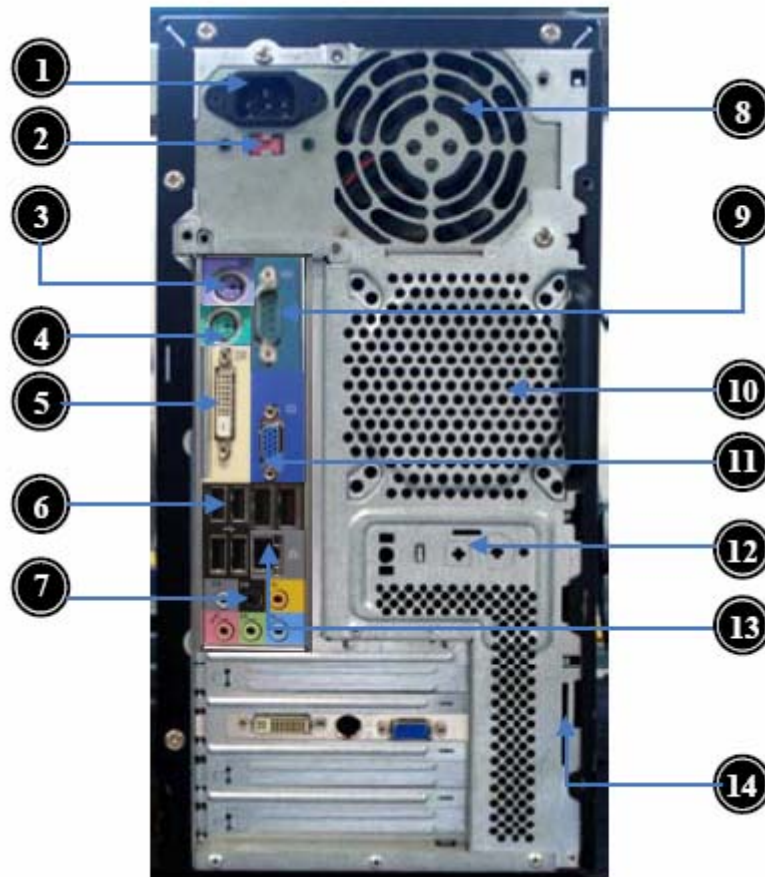

Label	Description	Label	Description
1	Power card socket	8	Fan aperture
2	Voltage selector switch	9	Serial port
3	PS/2 keyboard connector	10	System FAN
4	PS/2 mouse connector	11	Monitor connector
5	DVI port	12	SPDF connector
6	USB 2.0 connector	13	LAN connector
7	Audio connector	14	Lock Handle

Hardware Specifications and Configurations

Processor

Item	Specification
Type	Intel Conroe/Kensfield/Wolfdale/Yorkfield processor
Socket	LGA 775 pin
FSB	800/1066 /1333 MHz
Minimum operating speed	0 MHz (If Stop CPU Clock in Sleep State in BIOS Setup is set to Enabled.)

BIOS

Item	Specification
BIOS code programmer	Phoenix Award or AMI Kernel with Acer skin
BIOS version	D07
BIOS ROM type	SPI Flash
BIOS ROM size	32Mb
Support protocol	SMBIOS(DMI)2.4/DMI2.0
Device Boot Support	<ul style="list-style-type: none">- 1st priority: SATA HDD- 2nd priority: CD-ROM- 3rd priority: FDD- 4th priority: LAN- 5th priority: USB device
Support to LS-120 drive	YES
Support to BIOS boot block feature	YES

BIOS Hotkey List

Hotkey	Function	Description
Del	Enter BIOS Setup Utility	Press while the system is booting to enter BIOS Setup Utility.

Main Board Major Chips

Item	Specification
North Bridge	Intel G45
South Bridge	ICH 10R
APG controller	Intel G45
Super I/O controller	ITE 8720
Audio controller	Realtek HD audio codec ALC888S HD codec 7.1 (co-lay with ALC888)
LAN controller	Intel Boazman 82567V PCI-E Giga LAN
HDD controller	ICH 10R
Keyboard controller	ITE 8720

Memory Combinations

Slot	Memory	Total Memory
Slot 1	1GB, 2GB	1GB ~2GB
Slot 2	1GB, 2GB	1GB ~2GB
Slot 3	1GB, 2GB	1GB ~2GB
Slot 4	1GB, 2GB	1GB ~2GB
Maximum System Memory Supported		1GB ~8GB

System Memory

Item	Specification
Memory slot number	4 slot
Support Memory size per socket	1GB/2GB
Support memory type	DDR2
Support memory interface	DDR2 667/800MHz
Support memory voltage	1.8V
Support memory module package	240-pin DDR2
Support to parity check feature	Yes
Support to error correction code (ECC) feature	No
Memory module combinations	You can install memory modules in any combination as long as they match the above specifications.

Audio Interface

Item	Specification
Audio controller	Intel ICH 10R
Audio controller type	ALC888S
Audio channel	codec 7.1
Audio function control	Enable/disable by BIOS Setup
Mono or stereo	Stereo
Compatibility	Sound Blaster Pro/16 compatible Mixed digital and analog high performance chip Enhanced stereo full duplex operation High performance audio accelerator and AC'97 support Full native DOS games compatibility Virtual FM enhances audio experience through real-time FM-to-Wavetable conversionMPU-401 (UART mode) interface for Wavetable synthesizers and MIDI devices Integrated dual game port Meets AC'97and WHQL specifications
Music synthesizer	Yes, internal FM synthesizer
Sampling rate	48 KHz (max.)
MPU-401 UART support	Yes
Microphone jack	Supported
Headphone jack	Supported

SATA Interface

Item	Specification
SATA controller	Intel ICH 10R
SATA controller resident bus	PCI bus
Number of SATA channel	SATA X 6
Support bootable CD-ROM	YES

Floppy disk drive Interface

Item	Specification
Floppy disk drive controller	ITE 8720
Floppy disk drive controller resident bus	ISA bus
Support FDD format	1.44MB

USB Port

Item	Specification
Universal HCI	USB 2.0/1.1
USB Class	Support legacy keyboard for legacy mode
USB Connectors Quantity	4 back panel ports 4 ports for front daughter board 2 ports for 3.5" card reader module

Environmental Requirements

Item	Specification
Temperature	
Operating	+5°C ~ +35°C
Non-operating	-20 ~ +60°C (Storage package)
Humidity	
Operating	15% to 80% RH
Non-operating	10% to 90% RH
Vibration	
Operating (unpacked)	5 ~ 500 Hz: 2.20g RMS random, 10 minutes per axis in all 3 axes 5 ~500 Hz: 1.09g RMS random, 1 hour per axis in all 3 axes

Power Management

Devices	S1	S3	S4	S5
Power Button	V	V	V	V
USB Keyboard/Mouse	V	V	N/A	N/A
PME	Disabled	Disabled	Disabled	Disabled
RCT	Disabled	Disabled	Disabled	Disabled
WOR	Disabled	Disabled	Disabled	Disabled

- *Devices wake up from S3 should be less than*
- *Devices wake up from S5 should be less than 10 seconds*

Power Management Function (ACPI support function)

Device Standby Mode

- Independent power management timer for hard disk drive devices (0-15 minutes, time step=1 minute).
- Hard disk drive goes into Standby mode (for ATA standard interface).
- Disable V-sync to control the VESA DPMS monitor.
- Resume method: device activated (Keyboard for DOS, keyboard & mouse for Windows).
- Resume recovery time: 3-5 sec.

Global Standby Mode

- Global power management timer (2-120 minutes, time step=10 minute).
- Hard disk drive goes into Standby mode (for ATA standard interface).
- Disable H-sync and V-sync signals to control the VESA DPMS monitor.
- Resume method: Return to original state by pushing external switch button, modem ring in, keyboard and mouse for APM mode.
- Resume recovery time: 7-10 sec.

Suspend Mode

- Independent power management timer (2-120 minutes, time step=10 minutes) or pushing external switch button.
- CPU goes into SMM.
- CPU asserts STPCLK# and goes into the Stop Grant State.
- LED on the panel turns amber colour.
- Hard disk drive goes into SLEEP mode (for ATA standard interface).
- Disable H-sync and V-sync signals to control the VESA DPMS monitor.
- Ultra I/O and VGA chip go into power saving mode.
- Resume method: Return to original state by pushing external switch button, modem ring in, keyboard and mouse for APM mode.
- Return to original state by pushing external switch button, modem ring in and USB keyboard for ACPI mode.

ACPI

- ACPI specification 1.0b.
- S0, S1, S3 and S5 sleep state support.
- On board device power management support.
- On board device configuration support.

System Utilities

The manufacturer or the dealer already configures most systems. There is no need to run Setup when starting the computer unless you get a Run Setup message.

The Setup program loads configuration values into the battery-backed nonvolatile memory called CMOS RAM.

This memory area is not part of the system RAM.

NOTE: If you repeatedly receive Run Setup messages, the battery may be bad/flat. In this case, the system cannot retain configuration values in CMOS.

Before you run Setup, make sure that you have saved all open files. The system reboots immediately after you exit Setup.

Entering Setup

Power on the computer and the system will start POST (Power On Self Test) process. When the message of “Press DEL to enter SETUP” appears on the screen, press the key of [Delete] to enter the setup menu.

NOTE: If the message disappears before you respond and you still wish to enter Setup, restart the system by turning it OFF and On. You may also restart the system by simultaneously pressing [Ctrl+ Alt+ Delete].

The Setup Utility main menu then appears:

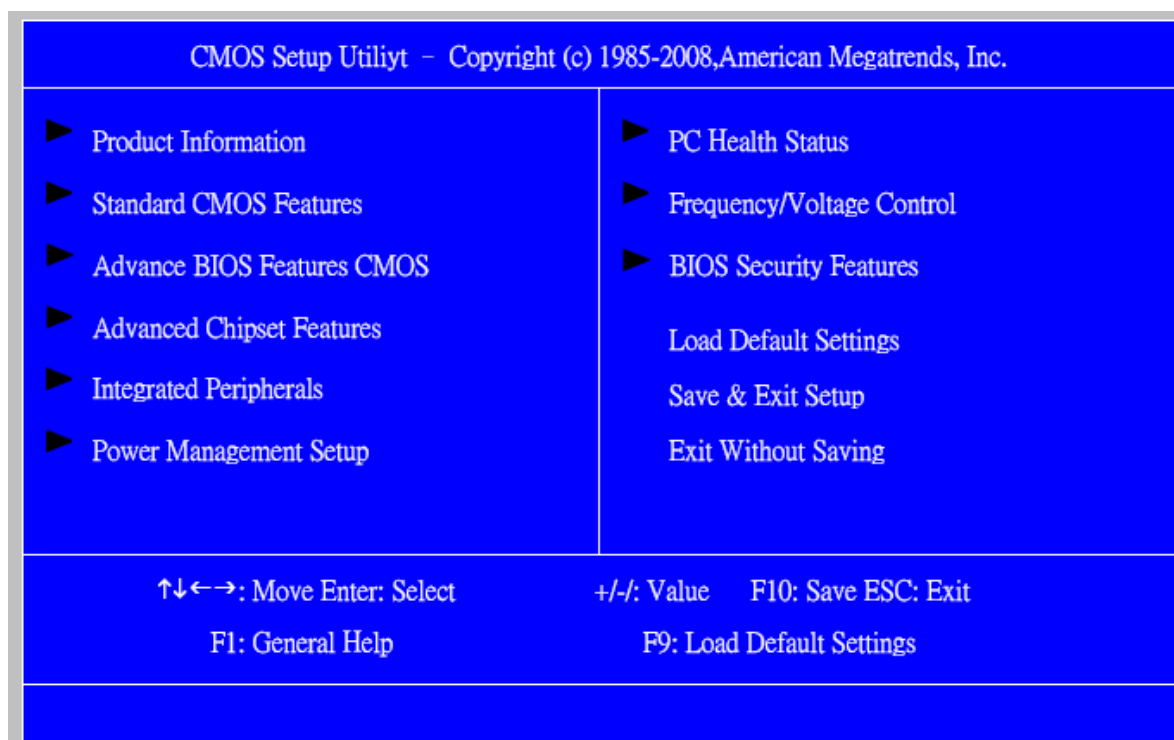

The items in the main menu are explained below:

Parameter	Description
Production Information	This page shows the relevant information of the main board
Standard CMOS Features	This setup page includes all the items in standard compatible BIOS
Advance BIOS Features	This setup page includes all the items of Award special enhanced features
Advance Chipset Features	This setup page includes all advanced chipset features
Integrated Peripherals	This setup page includes all onboard peripherals
Power Management Setup	This setup page includes all the items of Green function features
PC Health Status	This setup page is the System auto detect Temperature, voltage, and fan speed
Frequency/Voltage Control	This setup page is the System Frequency/Voltage setup
BIOS Security Features	Change, set or disable password. It allows you to limit access to the System
Load Optimized Defaults	Load Optimized Settings Default Settings indicates the value of the system parameters which the system would be in best performance configuration
Save & Exit Setup	Save CMOS value settings to CMOS and exit setup
Exit Without Saving	Abandon all CMOS value changes and exit setup

Product Information

The screen below appears if you select Product Information from the main menu: The Product Information menu contains general data about the system, such as the product name, serial number, BIOS version, etc. This information is necessary for troubleshooting (maybe required when asking for technical support).

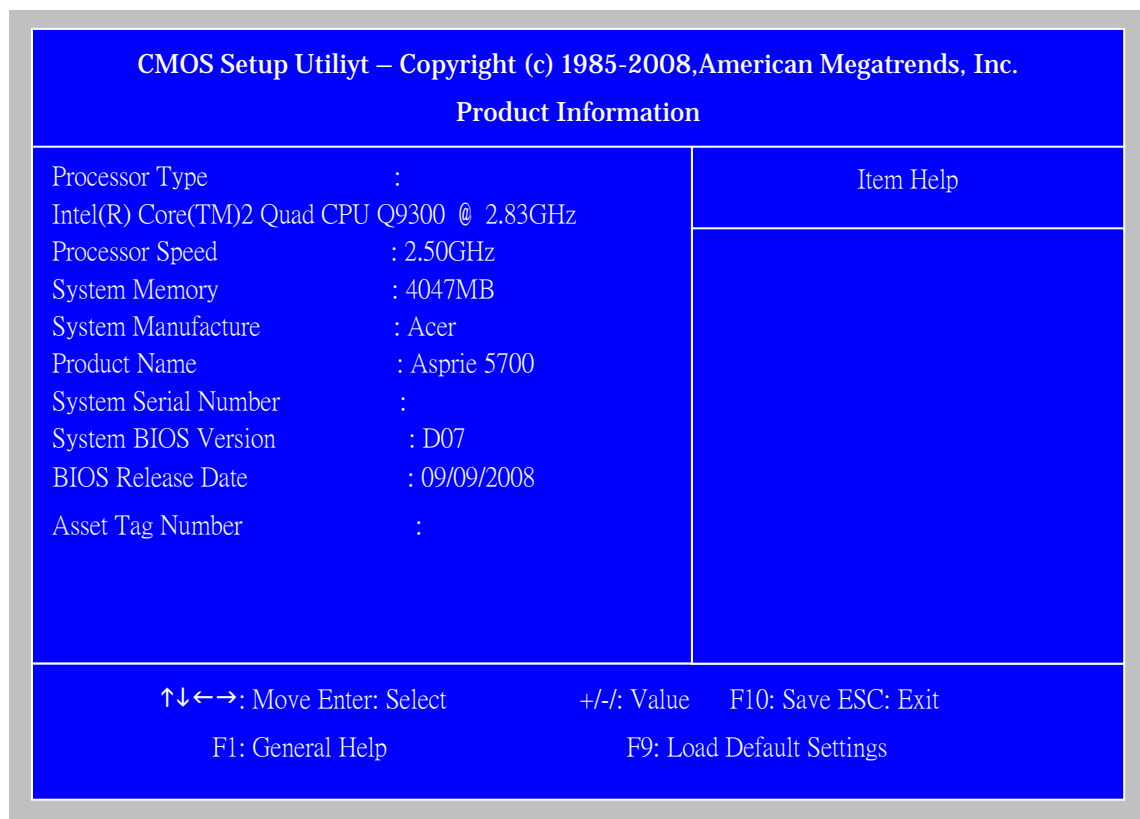

The following table describes the parameters found in this menu:

Parameter	Description
Processor Type	This item lists the product processor model
Processor Speed	This item lists the processor frequency for the system
System Memory	Total memory size for the system
Product Name	This item lists the product name
Product Name	This item lists the system BIOS version
System Serial Number	This item lists the system serial number
System BIOS Version	This item lists the system BIOS version
BIOS Release Date	This item lists the BIOS release date

Standard CMOS Setup

Select standard CMOS features from the main menu to configure some basic parameters in your system the following screen shows the standard CMOS features menu:

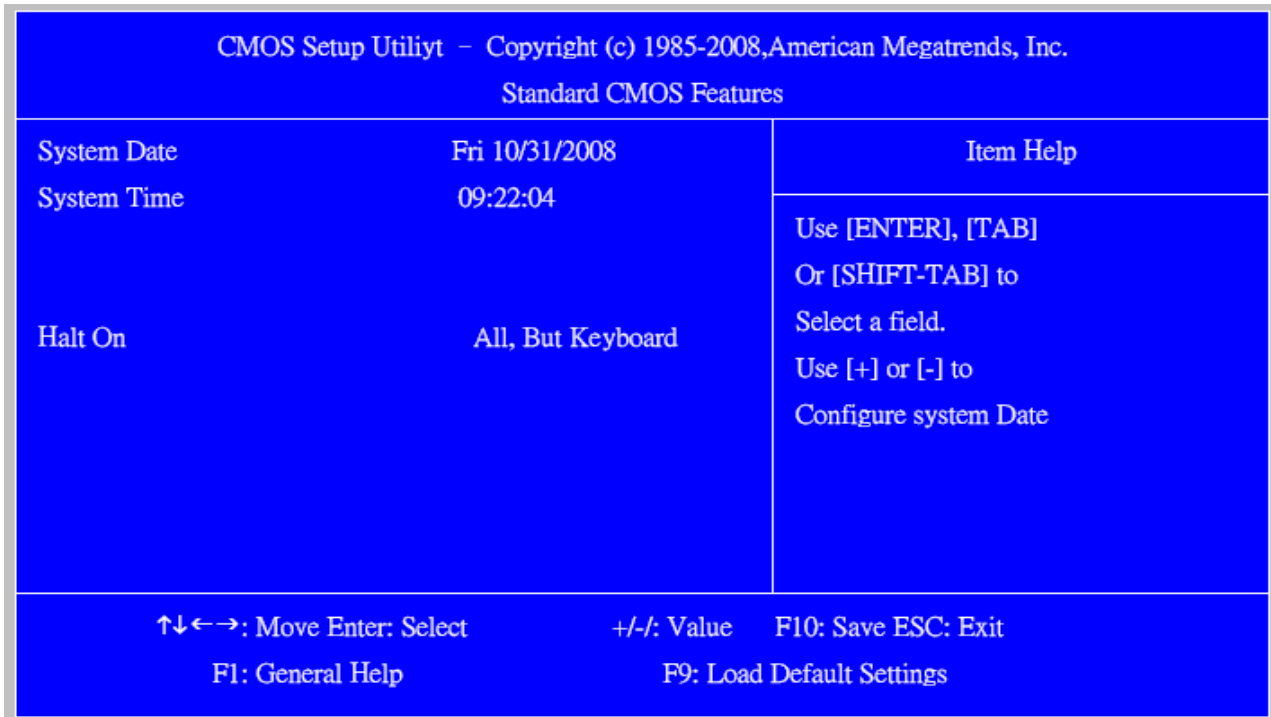

The following table describes the parameters found in this menu.

Parameter	Description	Options
System Date	To set the date following the weekday-month-date-year format	Week: From [Sun.] to [Sat.]. determined by BIOS and is display only Day: from [1] to [31] (or the maximum allowed in the month). Year: from 1999 to 2099
System Time	To set the time following the hour-minute-second format	The items format is [hour] [minute][second]. The time is calculated base on the 24-hour timer clock.
Halt On	This item enables use to select the situation if the BIOS stops the POST process and the notification	All Errors No Errors All, But Keyboard All, But Diskette All, But Disk/Key

Advanced Setup

The following screen shows the Advanced Setup:

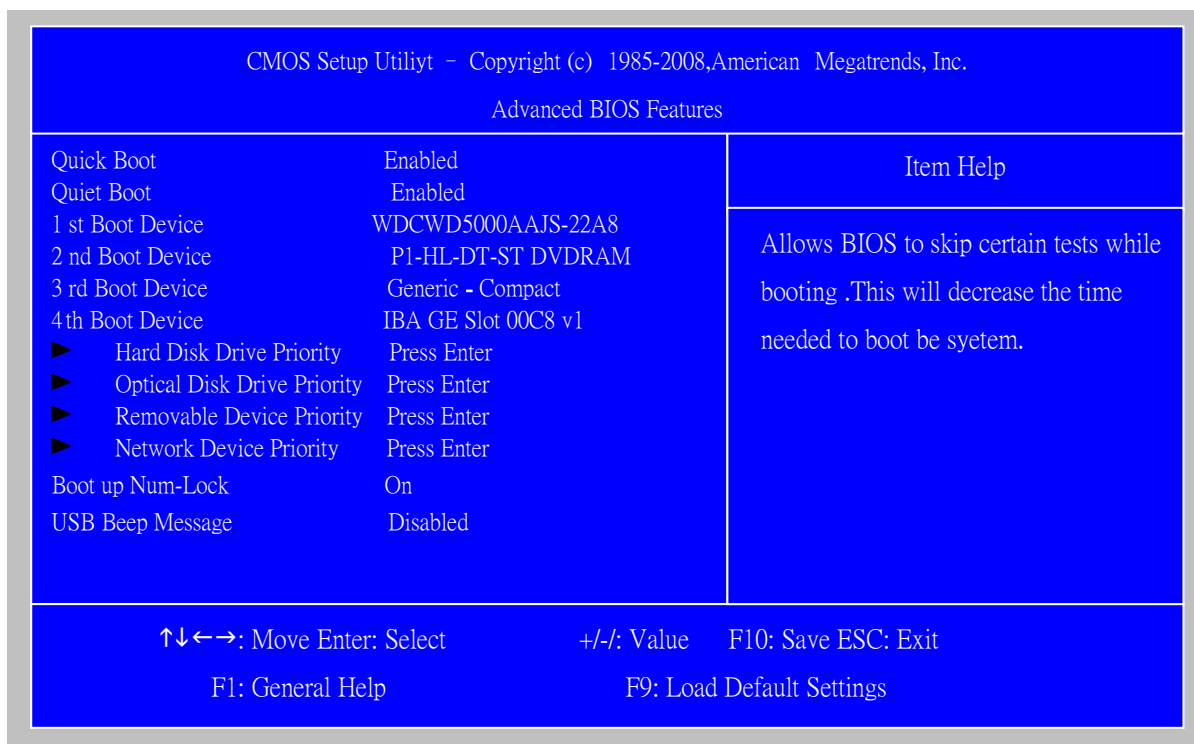

The following table describes the parameters found in this menu.

Parameter	Description	Options
Quick Boot	Allows BIOS to skip certain tests while booting. This will decrease the time needed to boot the system	[Enabled], [Disabled]
1 st Boot Device	The item allows you to see the sequence of boot device where BIOS attempts to load the disk operation system.	
2 nd Boot Device		
3 rd Boot Device		
4 th Boot Device		
Hard Disk Drive	Specifies the boot device. Priority sequence from available Hard Drives	
Optical Drive		
Removable Device		
Network Device		
Boot up Num-Lock On	Select Power-on state for Numlock	On,Off
USB Beep Message	Enables the beep during USB device enumeration	[Enabled], [Disabled]

Advanced Chipset Setup

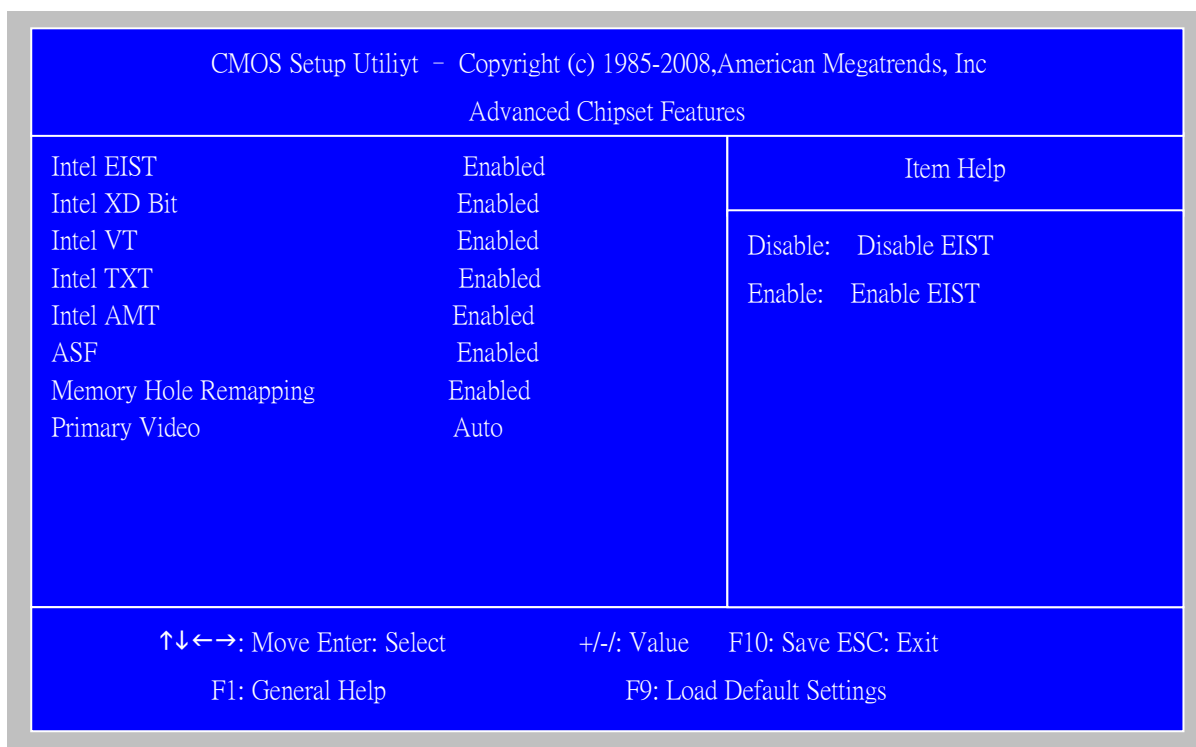

The following table describes the parameters found in this menu.

Parameter	Description	Options
Intel EIST	For Intel platform	Disabled/Enabled
Intel XD Bit	For Intel platform	Disabled/Enabled
Intel VT	For Intel platform	Disabled/Enabled
Intel AMT	For Intel platform	Disabled/Enabled
ASF	For Veriton series with vPro or DASH solution	Disabled/Enabled
Memory Hole Remapping	You can reserve this area of system memory for ISA adapter ROM. When this area is reserved, it cannot be cached. The user information of peripherals that need to use this area of system memory usually discuss their memory requirements.	Disabled/Enabled
Primary Video	Priority for Auto : PCIE -> Onboard -> PCI	Auto/PCIE/Onboard/PCI

Integrated Peripherals

CMOS Setup Utility - Copyright (c) 1985-2008, American Megatrends, Inc.		
Integrated Peripherals		
Onboard SATA Controller	Enabled	Item Help
Onboard SATA Mode	RAID	
Onboard USB Controller	Enabled	Options
Legacy USB Support	Enabled	
Onboard Audio Controller	Enabled	Native IDE
Onboard LAN Controller	Enabled	RAID
Onboard LAN Option ROM	Enabled	AHCI
Onboard Floppy Controller	Enabled	
Serial Port1 Address	3F8/IRQ4	
Serial Port2 Address	2F8/IRQ3	
Serial Port2 Mode	Normal	
Parallel Port Address	378	
Parallel Port Mode	Normal	
Parallel Port IRQ	IRQ7	

↑↓←→: Move Enter: Select +/-: Value F10: Save ESC: Exit
 F1: General Help F9: Load Default Settings

The following table describes the parameters found in this menu.

Parameter	Description	Options
Onboard SATA Mode	This item is only available when onboard SATA controller is enabled	Disabled/Enabled
Onboard USB Controller	Always enabled USB keyboard during POST no matter what option is set	Disabled/Enabled
Legacy USB Support	This item is only available when onboard USB controller is enabled	Disabled/Enabled
Onboard Audio Controller	Always enabled Audio POST no matter what option is set	Disabled/Enabled
Onboard LAN Controller	Always enabled Audio POST no matter what option is set	Disabled/Enabled
Onboard LAN Option ROM	This item is only available when onboard LAN controller is enabled	Disabled/Enabled
Onboard Floppy Controller	Always enabled FloppyOST no matter what option is set	Disabled/Enabled
Serial Port1 Address	Allows BIOS to select serial port1 base addresses	Disabled / 3F8/IRQ4 / 2F8/IRQ3 / 3E8/IRQ4 / 2E8/IRQ3
Serial Port2 Address	Allows BIOS to select serial port1 base addresses	Disabled / 3F8/IRQ4 / 2F8/IRQ3 / 3E8/IRQ4 / 2E8/IRQ3
Serial Port2 Mode	Allows BIOS to select serial port1 base Mode	Normal/IrDA/ASK IR

Power Management

The Power Management menu lets you configure your system to most effectively save energy while operating in a manner consistent with your own style of computer use. The following screen shows the Power Management parameters and their default settings:

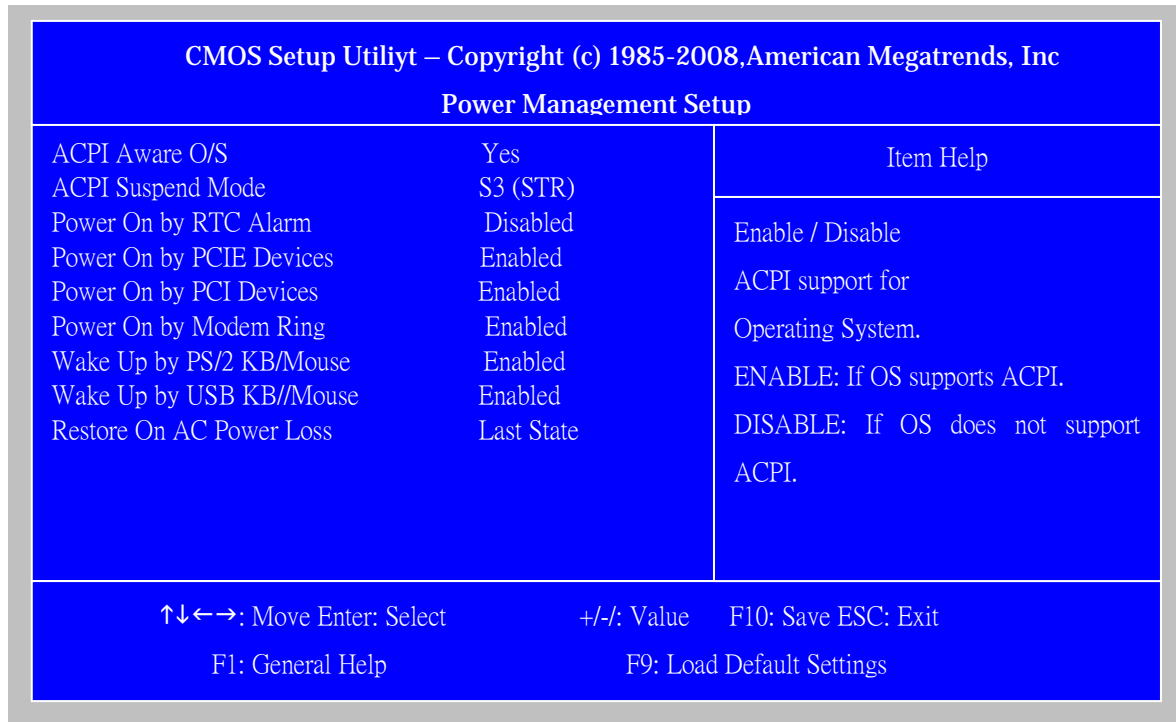

The following table describes the parameters found in this menu.

Parameter	Description	Options
ACPI Aware O/S	Control wake up event for S1/S3/S4/S5	No/Yes
ACPI Suspend Mode		S1(POS)/S3 (STR)
Power On by RTC Alarm		Disabled/Enabled
Power On by PCIE Devices		Disabled/Enabled
Power On by PCI Devices		Disabled/Enabled
Power On by Modem Ring		Disabled/Enabled
Wake Up by PS/2 KB/Mouse	Control wake up event for S1/S3	Disabled/Enabled
Wake Up by USB KB//Mouse		Disabled/Enabled

PC Health Status

CMOS Setup Utility – Copyright (c) 1985-2008, American Megatrends, Inc.			
PC Health Status			
CPU Temperature (PECI Mode)	: 38	Item Help Disabled Enabled	
System Temperature	: 39°C/102°F		
CPU Fan Speed	: 1383 RPM		
System Fan Speed	: 915		
CPU Core	: 1.152V		
+1.1V	: 1.120V		
+3.30V	: 3.344V		
+5.00V	: 5.134V		
+12.0V	: 11.968V		
5VSB	: 5.026V		
VBAT	: 3.184V		
Smart Fan	Enabled		
↑↓←→: Move Enter: Select +/-: Value F10: Save ESC: Exit F1: General Help F9: Load Default Settings			

The following table describes the parameters found in this menu:

Parameter	Description	Options
CPU/System Temperature	Detect CPU Temperature automatically	
CPU/SYSTEM FAN Speed (RPM)	Detect CPU/SYSTEM Fan Speed Status automatically	
CPU Smart FAN Control	The item displays the system Smart Fan Function status. It is always enabled by system.	

Frequency/Voltage Control

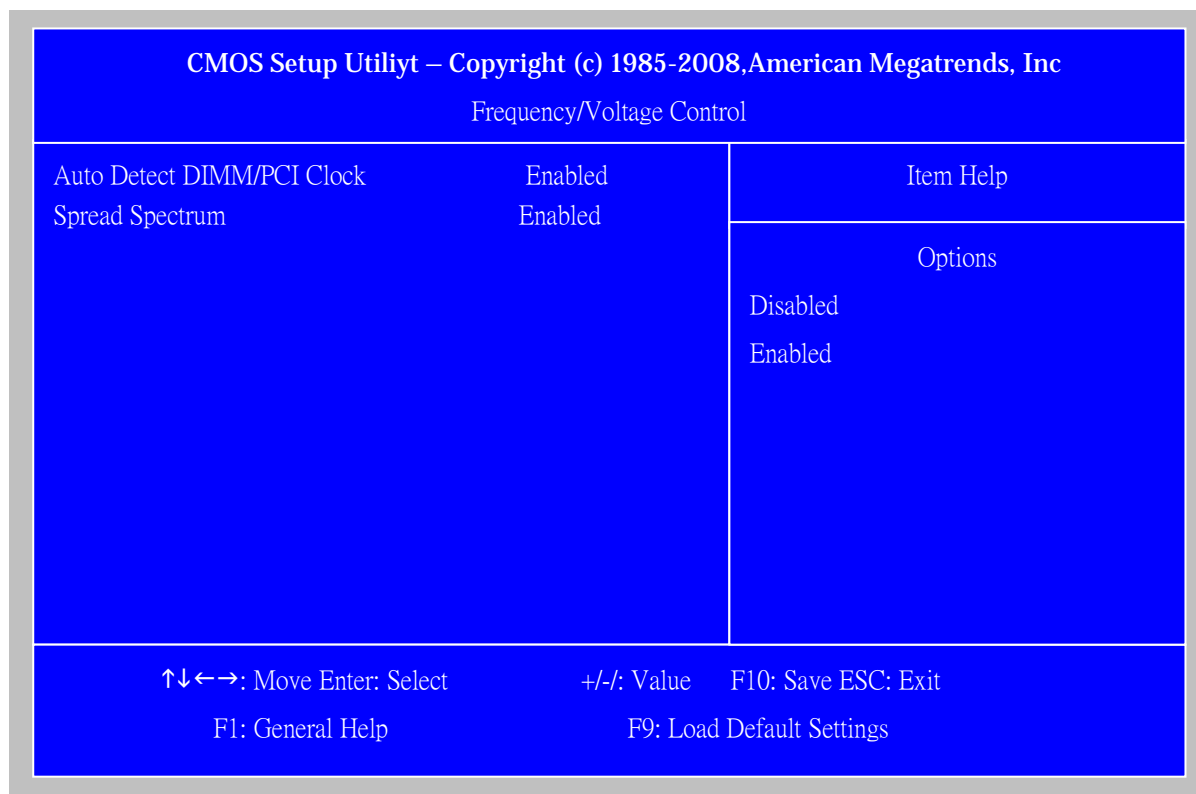

The following table describes the parameters found in this menu:

Parameter	Description	Options
Auto Detect DIMM/PCI Clk	Always auto detect DIMM/PCI Clk	Disabled/Enabled
Spread Spectrum	Always auto detect Spread Spectrum	Disabled/Enabled

BIOS Security Features

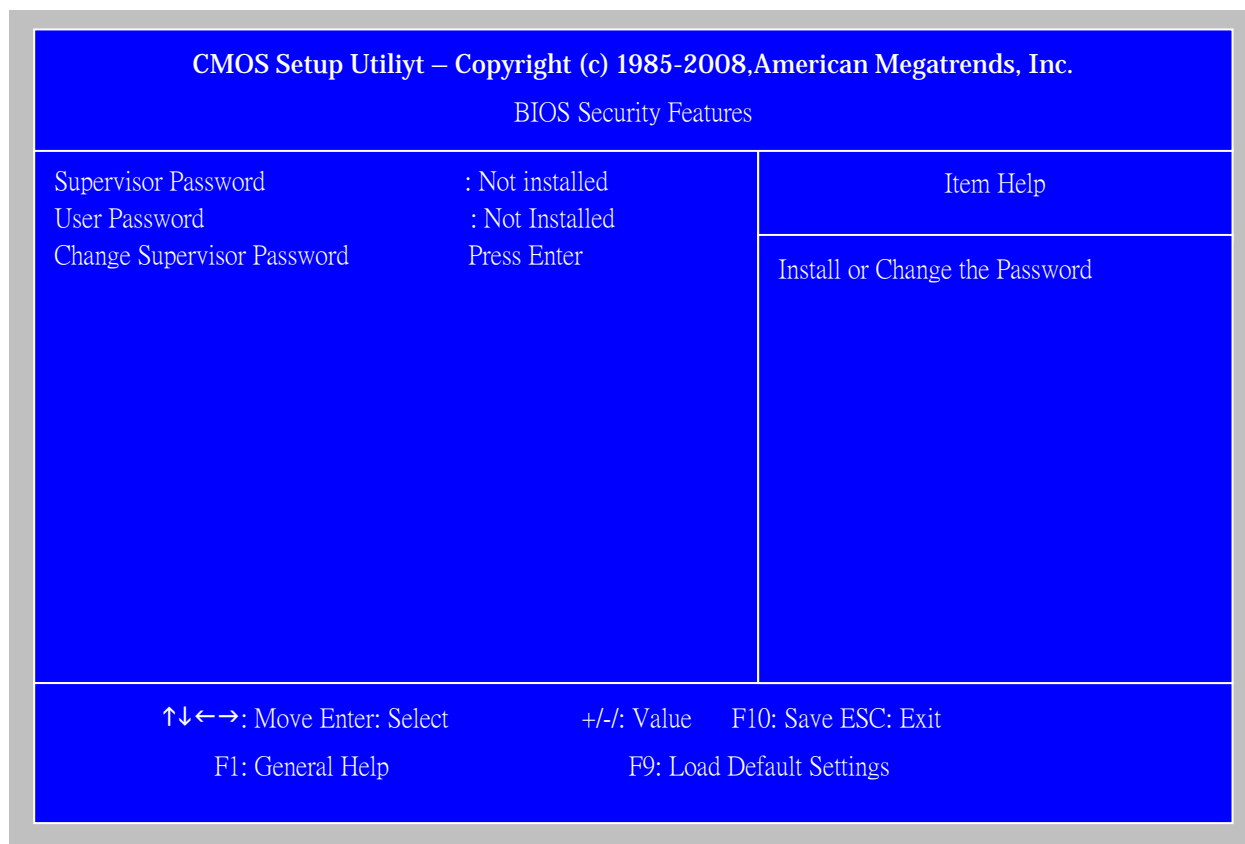

The following table describes the parameters found in this menu:

Parameter	Description	Options
Change Supervisor Password	This item is only available when supervisor password is installed, If clear supervisor password, user password should also be cleared. All setup items will be view-only except user password item when login with user password	Press Enter

Load Default Settings

This option opens a dialog box that lets you install defaults for all appropriate items in the Setup Utility.

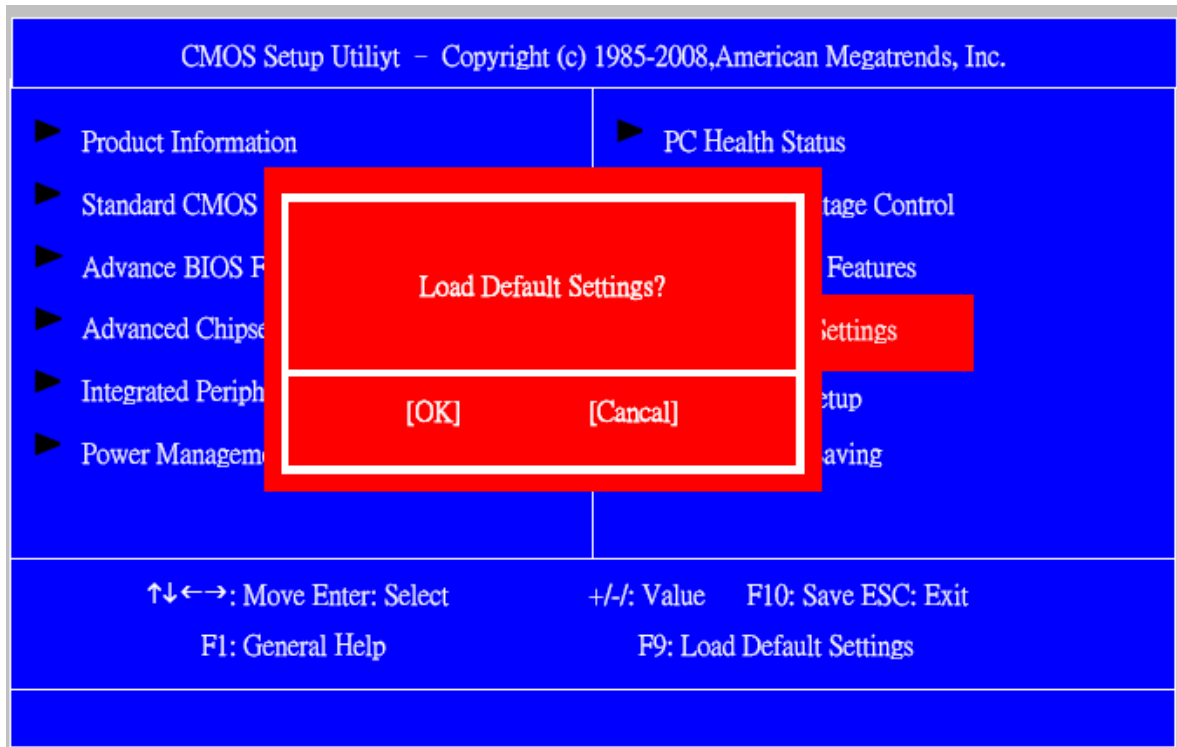

The following table describes the parameters found in this menu:

Parameter	Description	Options
Load Default Settings	Select the field loads the factory defaults for BIOS and Chipset Features, which the system automatically detects. This option opens a dialog box that lets you install optimized defaults for all appropriate items in the Setup Utility.	

Save & Exit Setup

Highlight this item and press <Enter> to save the changes that you have made in the Setup Utility and exit the Setup Utility.

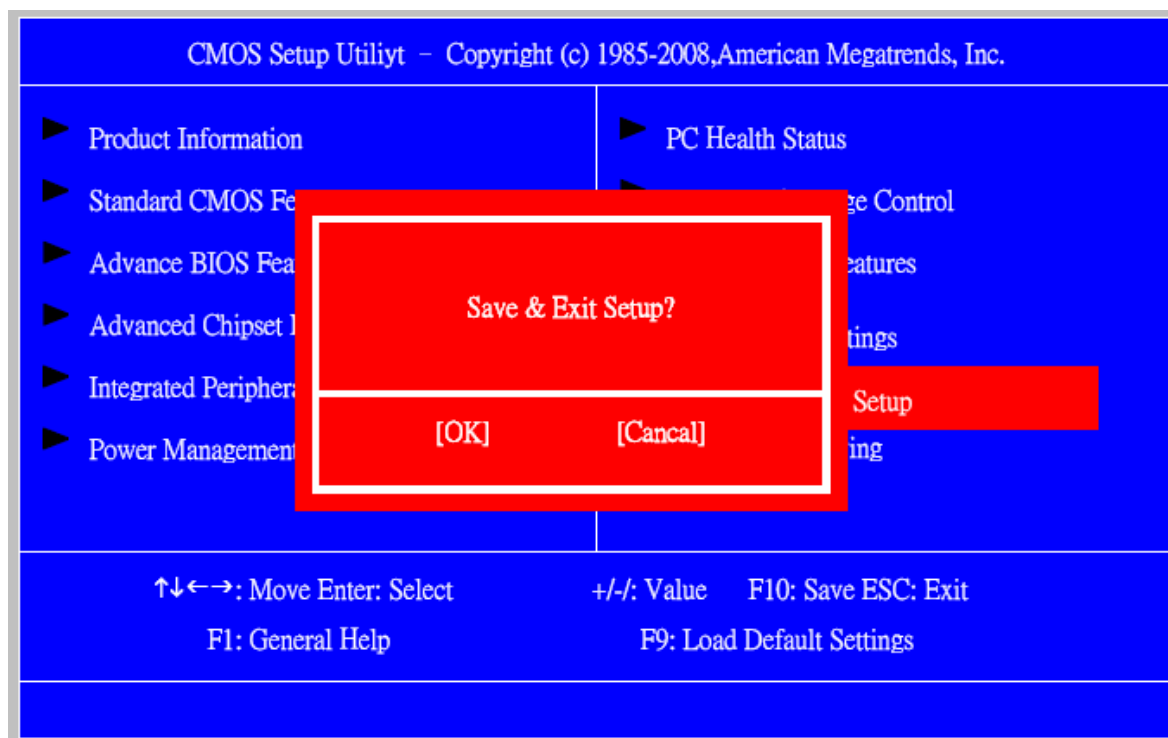

The following table describes the parameters found in this menu:

Parameter	Description	Options
Save & Exit Setup	Press <Enter> to save the changes that have made in the Setup Utility and exit the Setup Utility. Press<Y> to save and Exit or <N> to return to the main menu.	

Exit Without Saving

Highlight this item and press <Enter> to discard any changes that you have made in the Setup Utility and exit the Setup Utility.

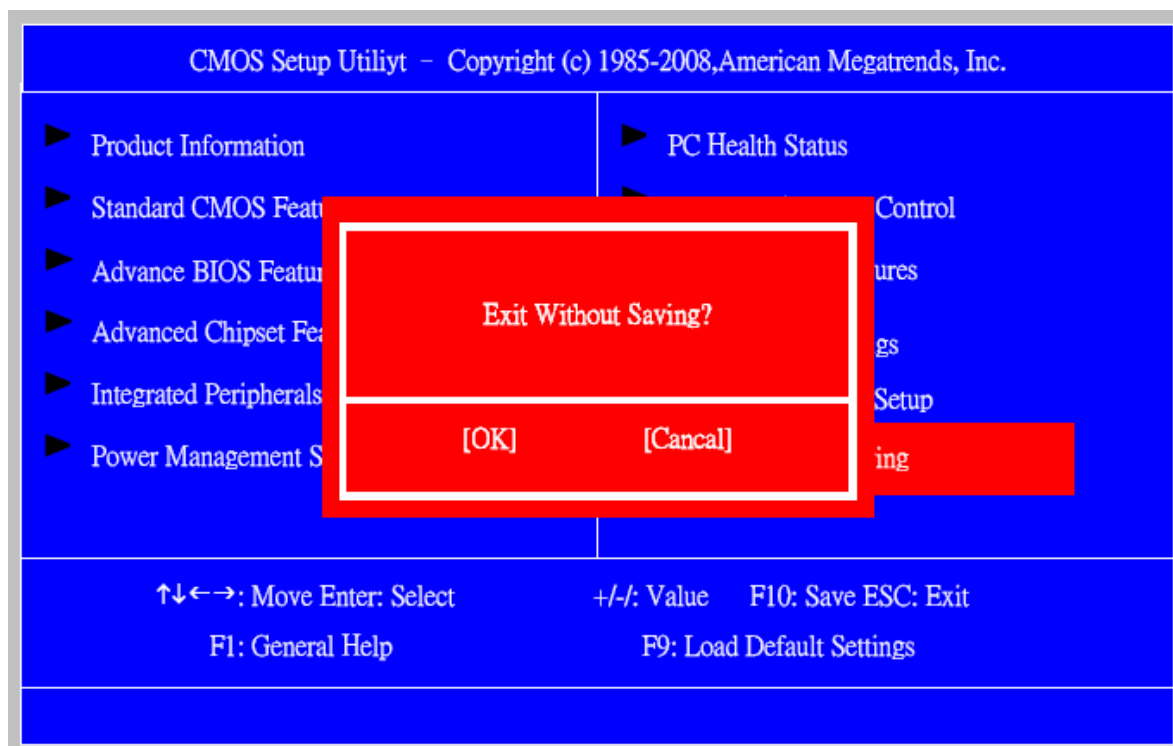

Parameter	Description	Options
Exit Without Saving	Press<Enter> to discard any changes and exit the Setup Utility	

Machine Disassembly and Replacement

To disassemble the computer, you need the following tools:

Wrist grounding strap and conductive mat for preventing electrostatic discharge.

Wire cutter.

Phillips screwdriver (may require different size).

NOTE: The screws for the different components vary in size. During the disassembly process, group the screws with the corresponding components to avoid mismatches when putting back the components.

General Information

Before You Begin

Before proceeding with the disassembly procedure, make sure that you do the following:

1. Turn off the power to the system and all peripherals.
2. Unplug the AC adapter and all power and signal cables from the system

Disassembly Procedure

This section tells you how to disassemble the system when you need to perform system service. Please also refer to the disassembly video, if available.

CAUTION: Before you proceed, make sure you have turned off the system and all peripherals connected to it.

Himalayan-Viiv M5700 Standard Disassembly

Process Bezel

Process:

1. According to the requirement, paste ATI, OS, CPU, HDMI and marketing label by SKU.



Remove side cover

Process:

1. Put the Computer on the worktable lightly.
2. Release left side cover with 2 screws then remove left side cover.

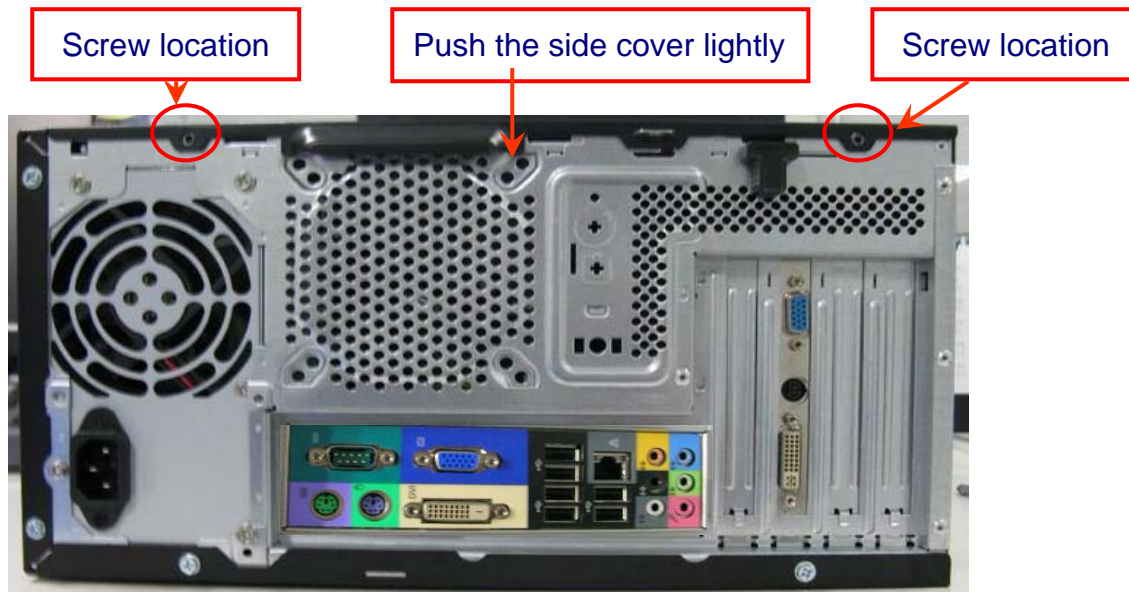

Remove CPU fan pipe

Process:

1. Release the CPU fan pipe.

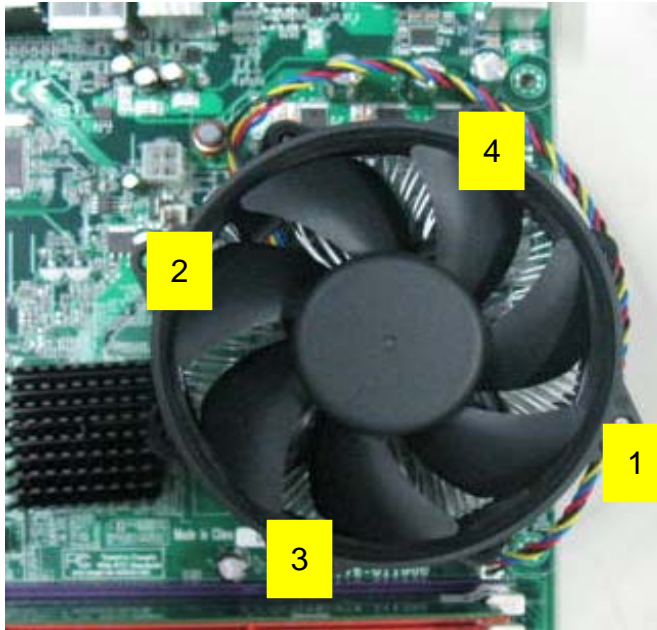

Remove Cards

Process:

1. Release the slot cover tooless
2. Remove VGA 、 TV、 Modem Card , the following list is for your reference about the mutual location relation (Optional by SKU).

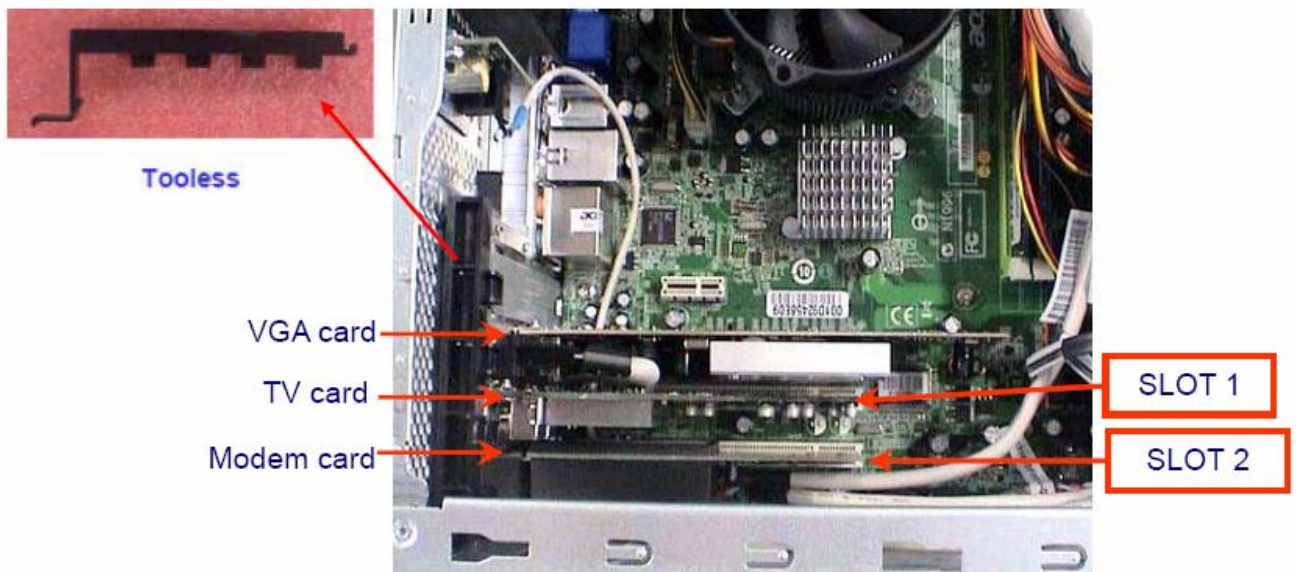

Notice:

I. Remove card, don't touch any electric parts on PCB.

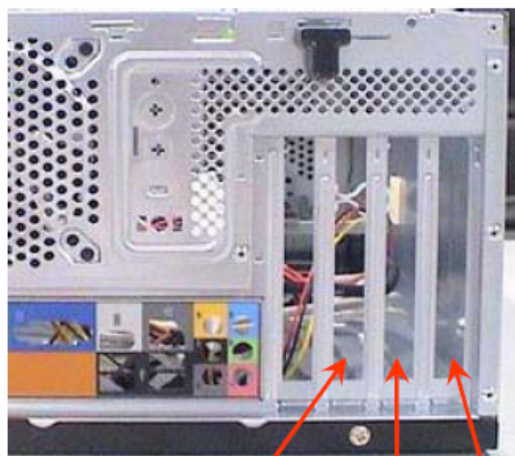

VGA card
TV card
Modem card

Slot 1	Slot 2
TV Card	N
N	Modem Card
1394 Card	N
Lan Card	N
TV Card	Modem Card
TV Card	1394/Lan Card
1394 /Lan card	Modem Card
Lan Card	1394 Card

Remove HDD Data Cables

Process:

1. Remove master HDD data cable from M/B SATA1/SATA3(Optional by SKU).
2. Remove slave ODD data cable from M/B SATA2/SATA4(Optional by SKU)



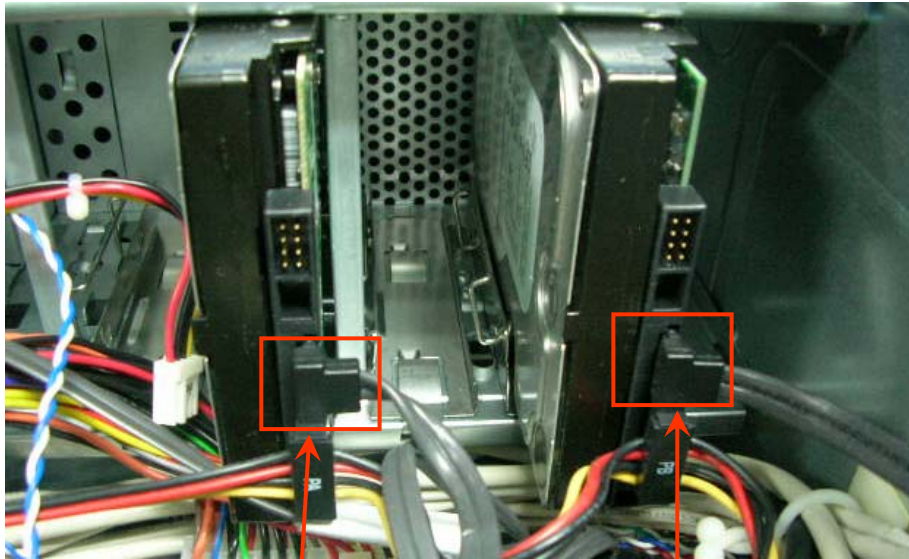

Remove slave HDD cable

Remove master HDD cable

Remove ODD DATA cable

Process:

1. Remove master ODD data/power cable from Master ODD.

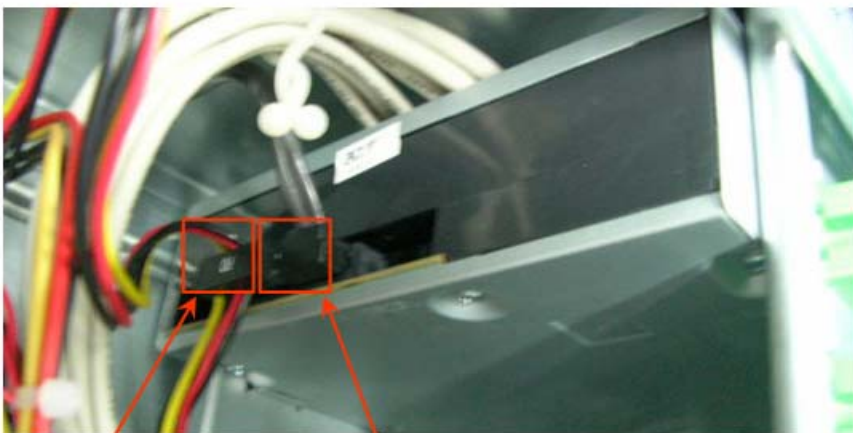

Remove master ODD Power Cable

Remove master ODD Data Cable

Remove HDD power cable

Process:

1. Remove master HDD data cable from master HDD.
2. Remove slave HDD data cable from slave HDD.

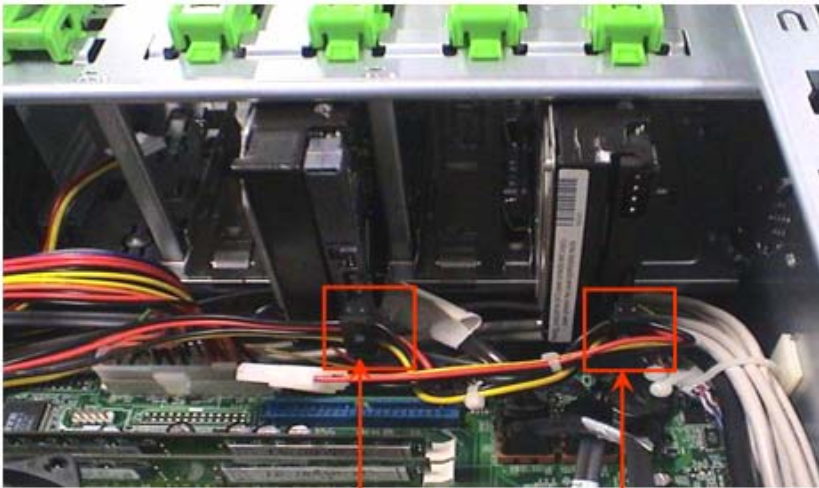

Remove slave HDD

Remove master HDD

Remove Cables

Process:

1. Remove front panel light cable from “PANEL1” slot of M/B.
2. Remove USB1 cable from M/B” F_ USB3”.
3. Remove USB2 cable from M/B”F_ USB4”.
4. Remove Card reader cable from M/B” USB2”.
5. Remove audio cable from the “AUDIO” port on M/B.

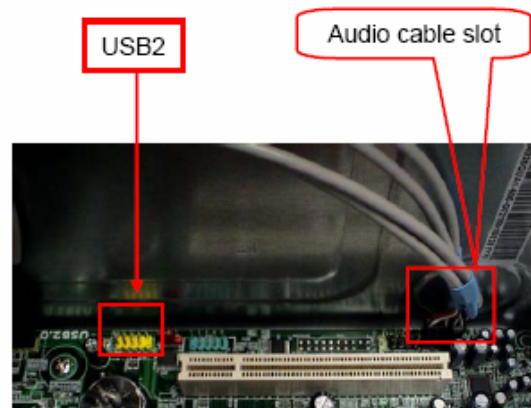
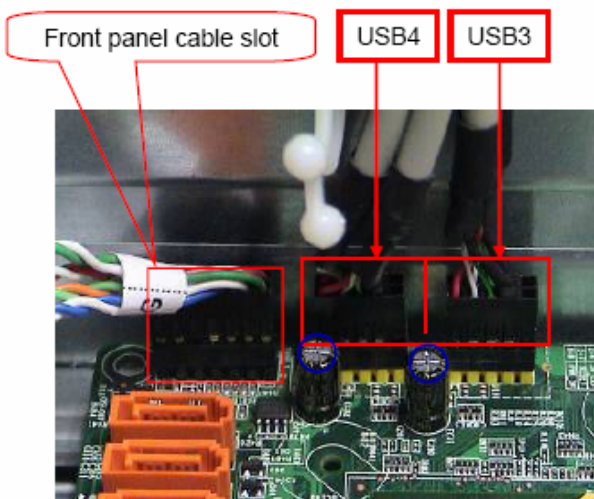

Notice:

- I. Recovery switch cable is next to FDD port, and the black cable face to the top of Chassis.
- II. Intrusion switches cable face to front bezel of chassis.

Remove HDD

Process:

1. Remove Master HDD from the first HDD location.
2. Remove Slave HDD from the second HDD location. (Optional by SKU)

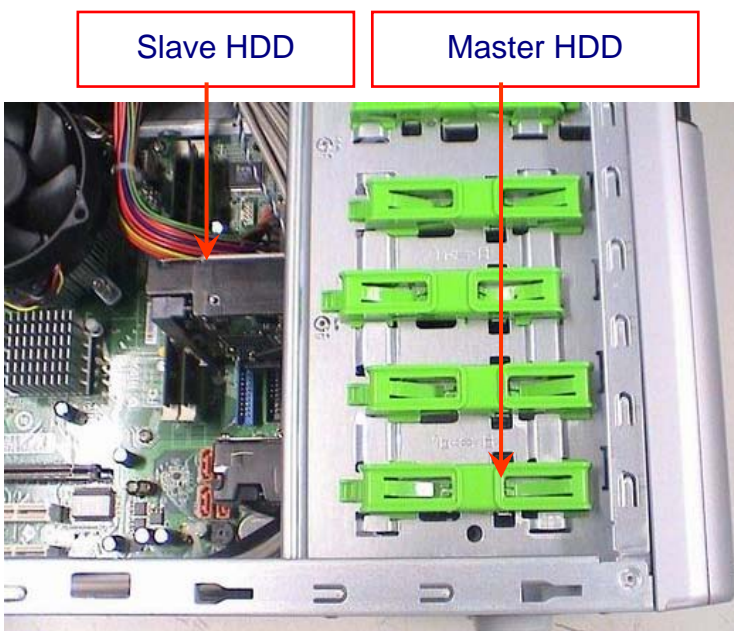

Port Num \	SATA1	SATA2	SATA3	SATA4
1HDD	V			
2HDDs	V		V	
1ODD		V		
2ODDs		V		V

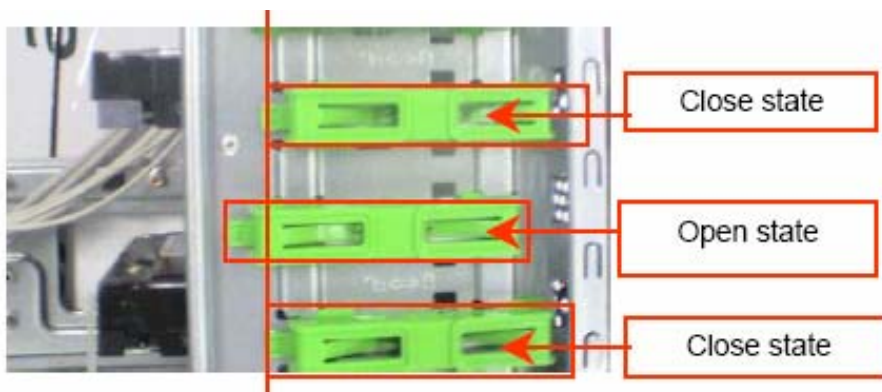

3.

Remove card reader

Process:

1. Remove card reader from chassis.

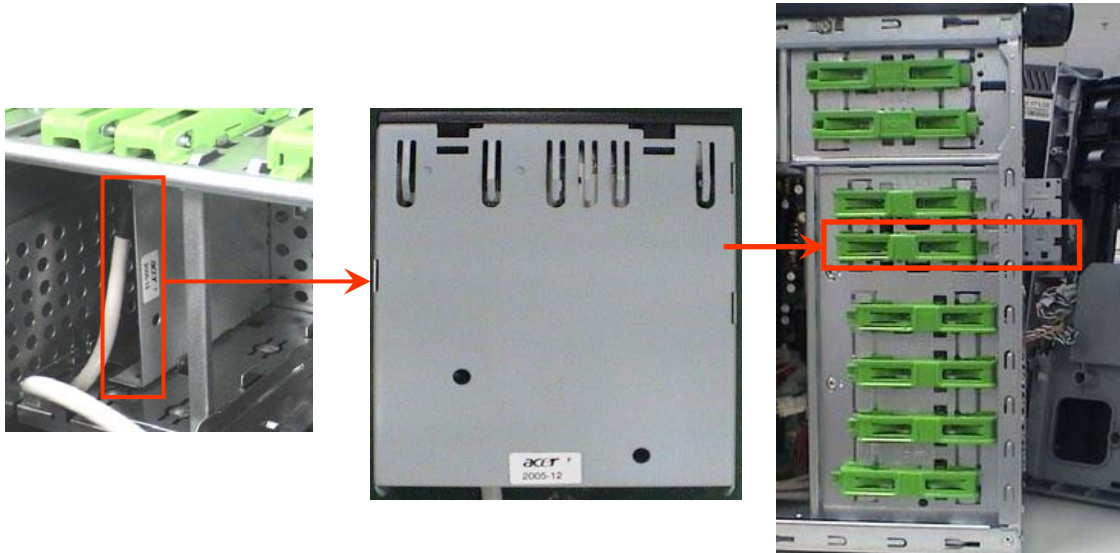

Remove FDD Cable

Process:

1. Remove FDD digital cable just as pictures (Optional by SKU).
2. Plug 4 pins power cord from FDD slot.
3. Remove front bezel light cable from PATA power cable

Remove from FDD

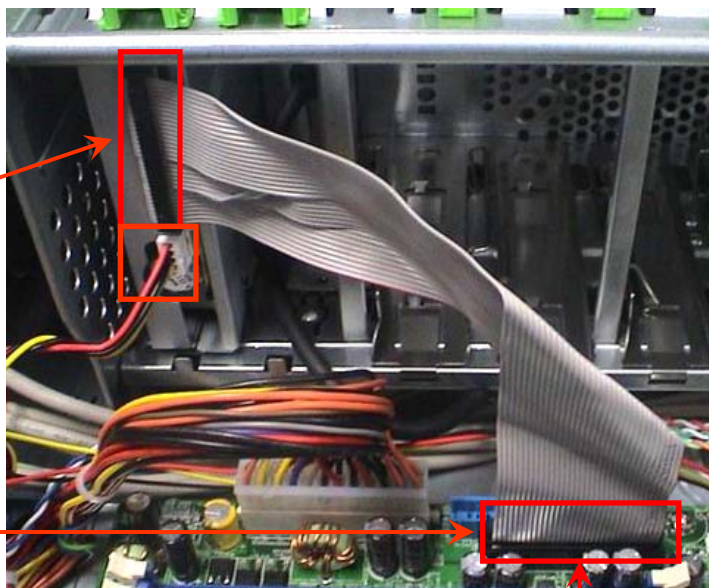

Remove from M/B

"FDD1" slot

Remove Front bezel light cable

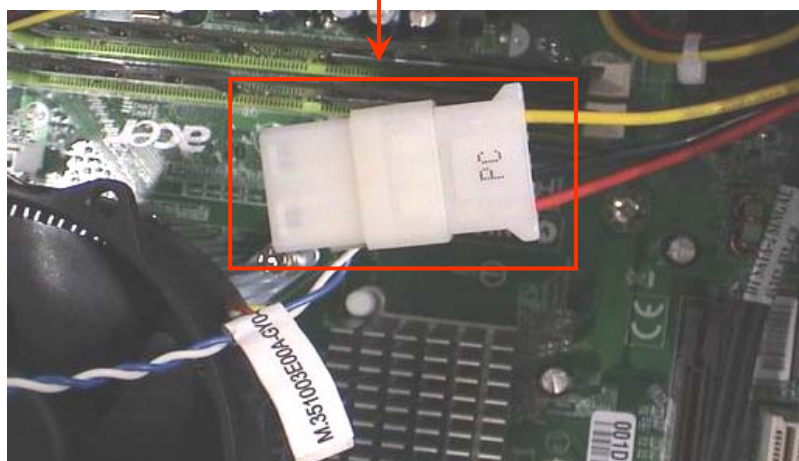

Remove ODD

Process:

1. Push the lock handle release ODD.

2. Remove Master ODD from the location.
3. Remove slave ODD from the location. (Optional by SKU)

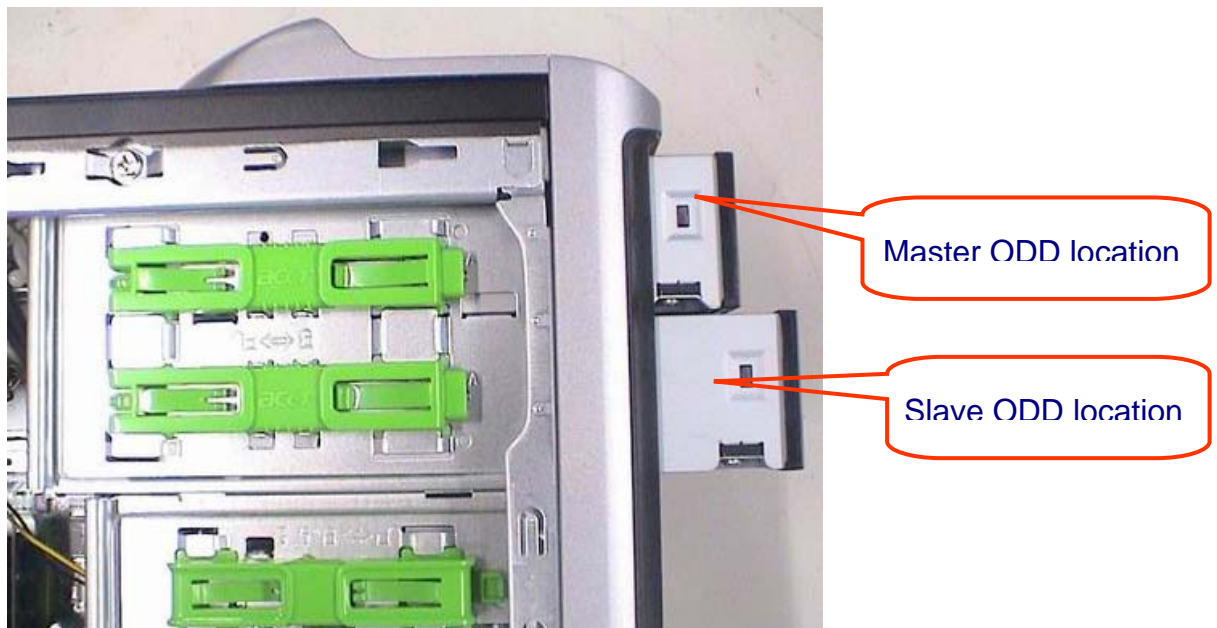
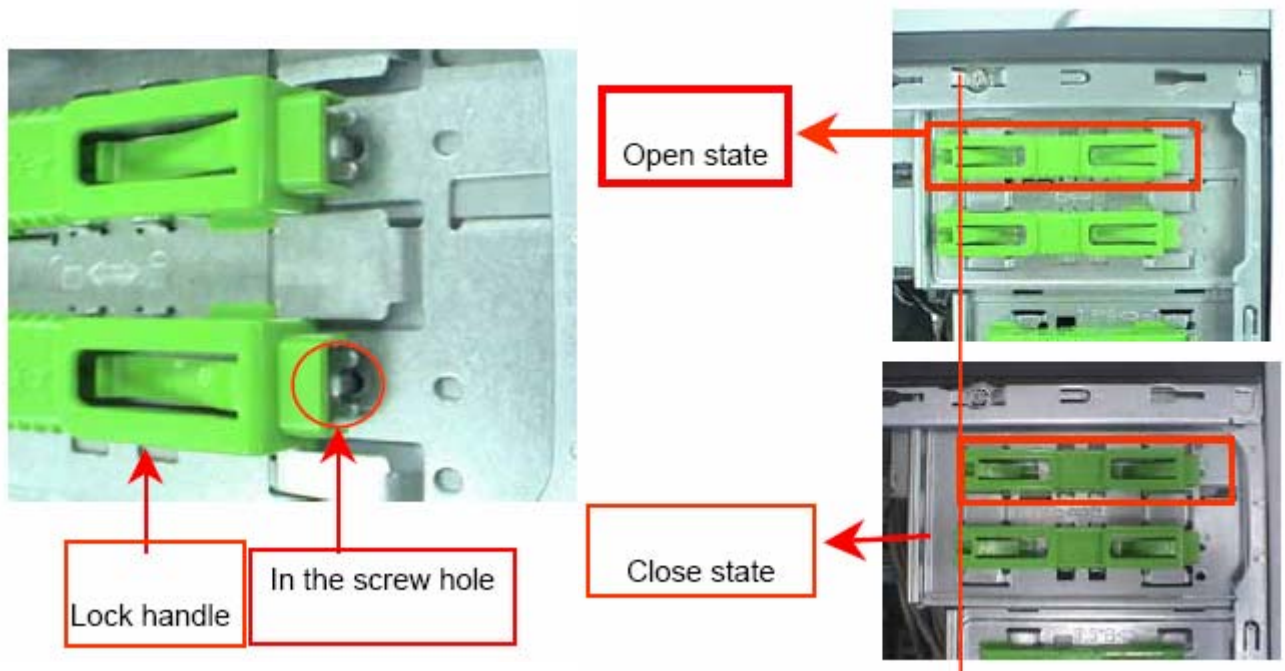

Remove Cables

Process:

1. Remove M/B power cable from M/B "ATX1".

2. Remove 12 V power cable from M/B" JPW1" 3. Remove System Fan cable from M/B"SYS-F2".

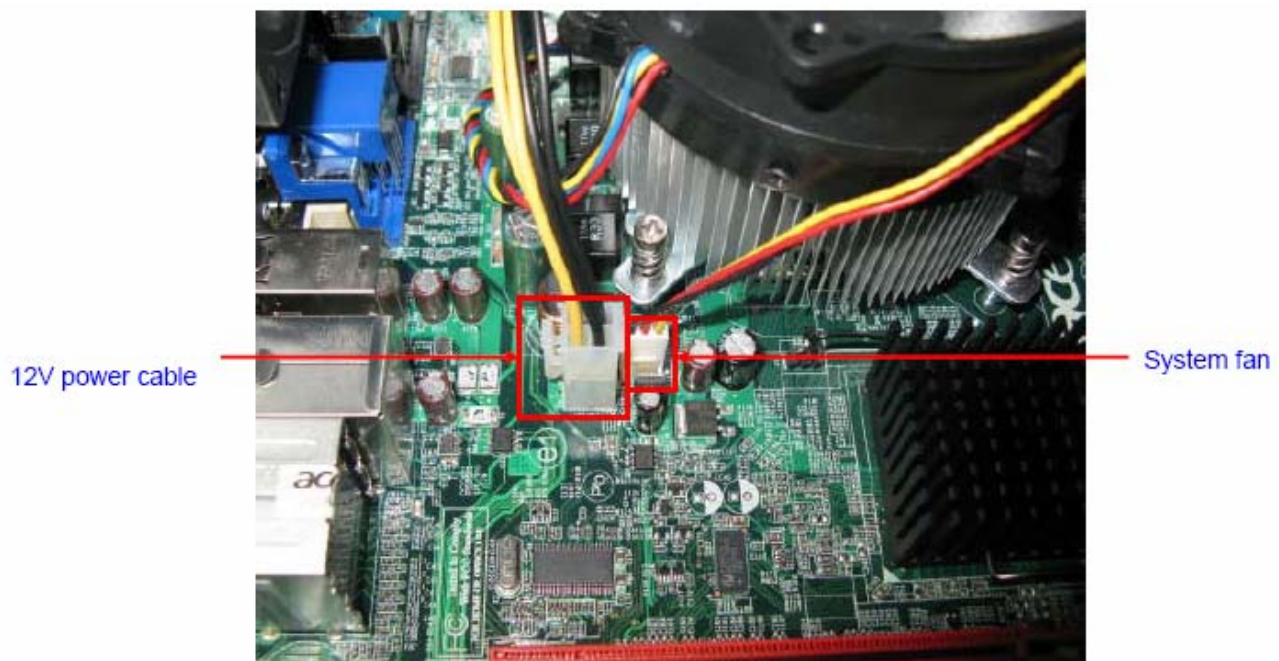

Remove System FAN

Process:

1. Release four screws according to the following picture.

2. Remove Sys FAN (Optional by SKU)

Release four screws.

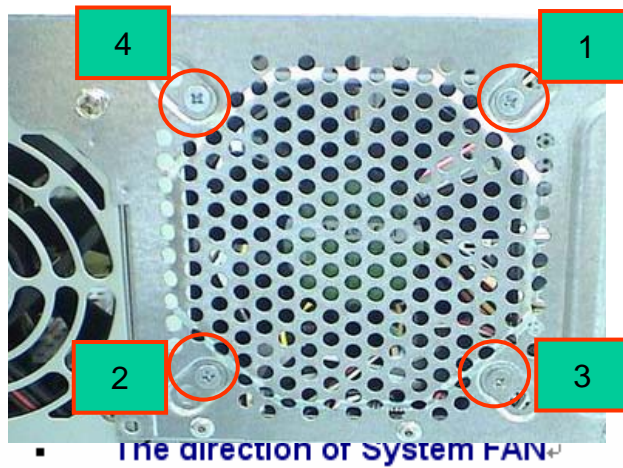

Remove mother board

Process:

1. Release 8 pcs screws form the corresponding hole.

2. Release screws according to the following picture in turn.

3. Remove the Mother board from chassis.

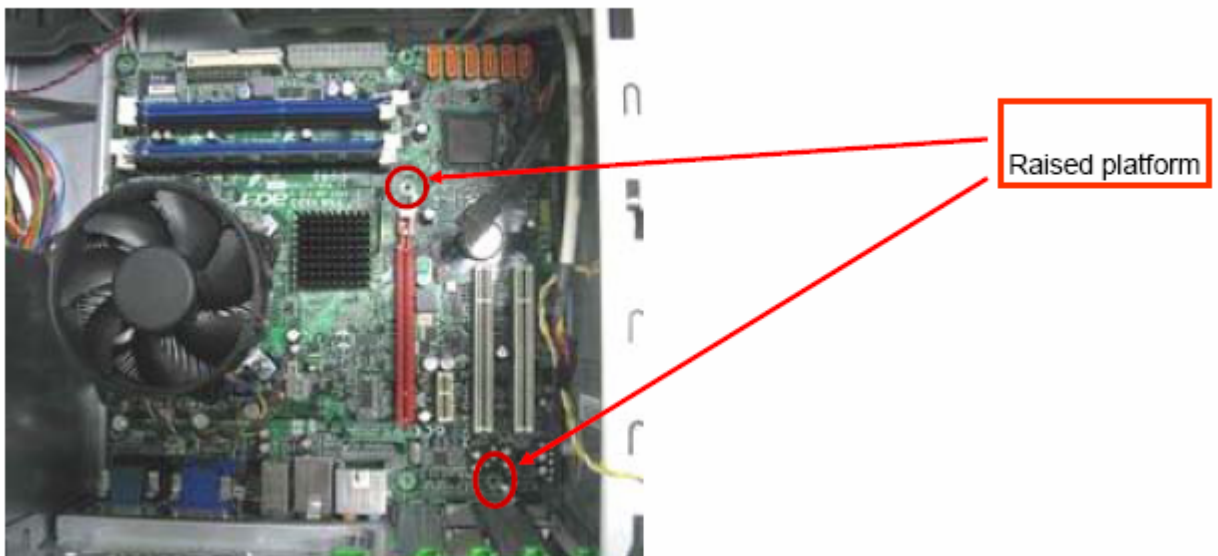
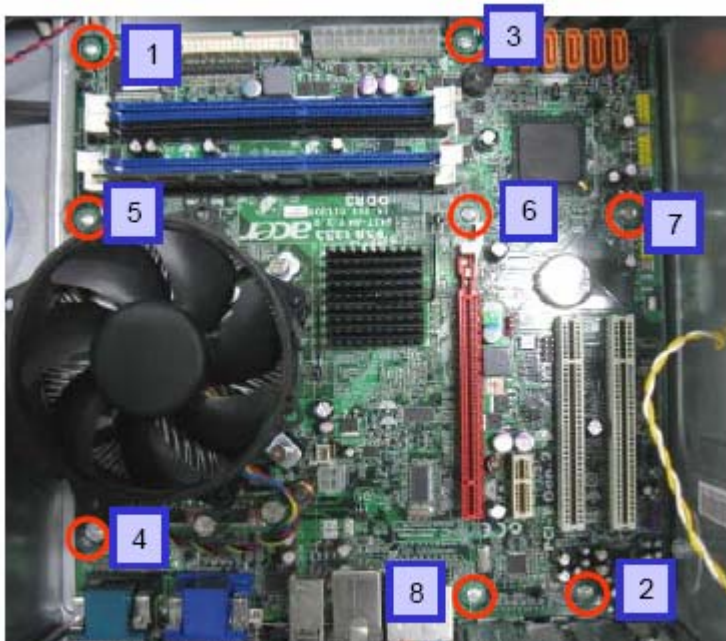

Remove CPU cooler

Process:

1. Remove cooler power cable from M/B "CPU-F2".
2. Release screw 1 first, then fixes screw 2, screw 3 & screw 4 (As Picture).

3. Remove Cooler from the Retention module.

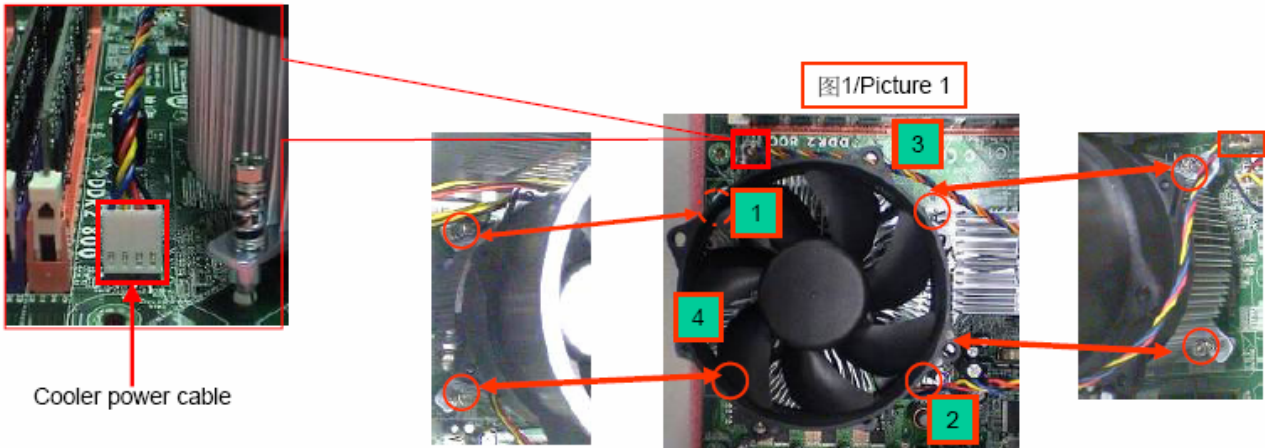

Remove memory

Process:

1. Remove the first Memory from DIMM.
2. Remove the second Memory from DIMM2 (Optional by SKU).

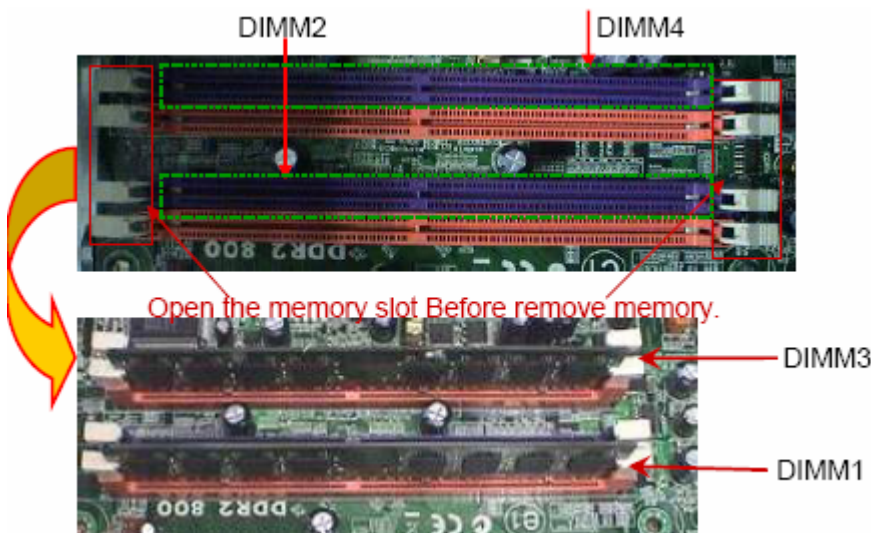

DIMM 1	DIMM 2	DIMM 3	DIMM 4
A		B	
A		A	
A	B	A	
B	A	B	
A	B	A	B

Remove CPU

Process:

1. Remove CPU according following the pictures.

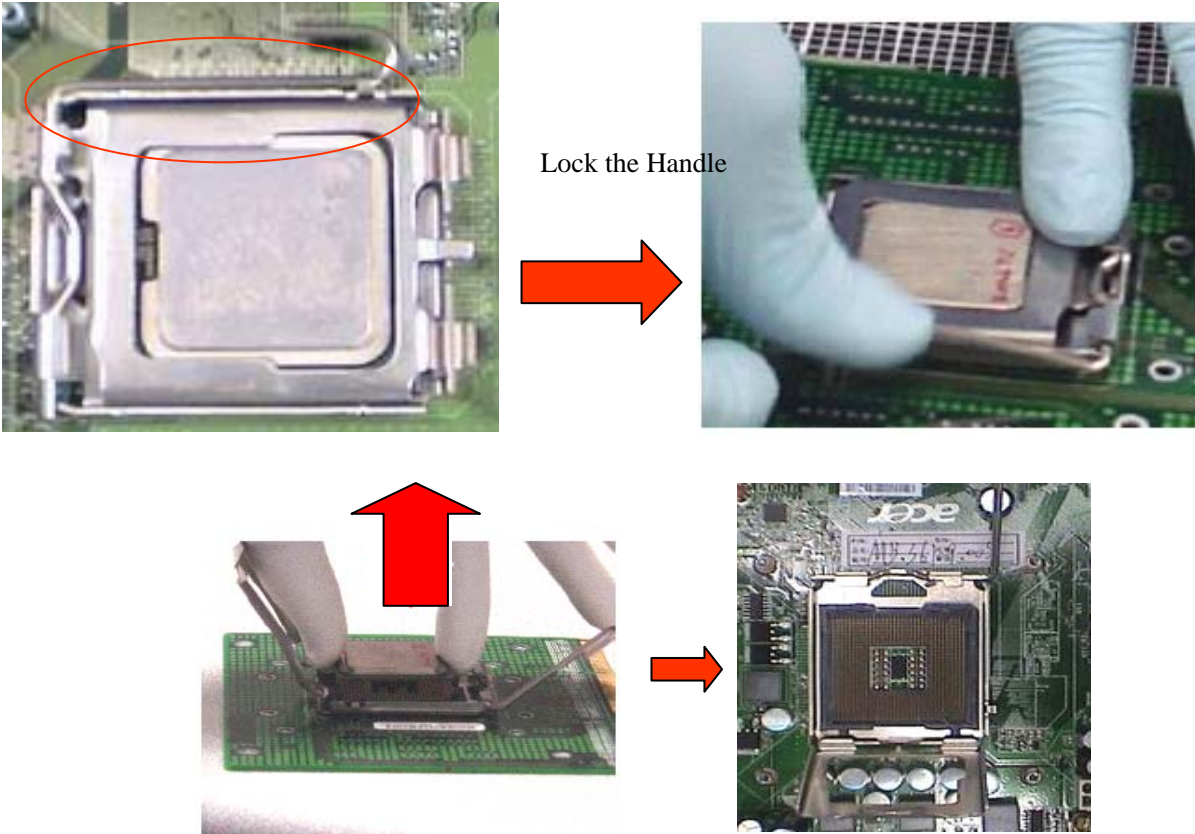

Remove I/O shielding

Process:

1. Remove I/O Shielding.



Troubleshooting

Please refer to generic troubleshooting guide for troubleshooting information relating to following topics:

- Power-On Self-Test (POST)
- POST Check Points
- POST Error Messages List
- Error Symptoms List

Jumper and Connector Information

Jumper Setting

This section explains how to set jumpers for correct configuration of the mainboard.

Setting Jumper

Use the motherboard jumpers to set system configuration options. Jumpers with more than one pin are numbered. When setting the jumpers, ensure that the jumper caps are placed on the correct pins.

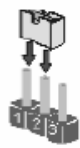
Description	Illustration
The illustrations show a 2-pin jumper. When the jumper cap is placed on both pins, the jumper is SHORT. If you remove the jumper cap, or place the jumper cap on just one pin, the jumper is OPEN.	 <p style="text-align: center;">SHORT OPEN</p>
This illustration shows a 3-pin jumper. Pins 1 and 2 are SHORT	

Clear CMOS

Jumper	Type	Description	Setting(Default)	Illustration
CLR_CMOS	3-pin	CLEAR CMOS	1-2 : Clear 2-3 : Normal Before clearing the CMOS,make sure to turn off the system	<p style="text-align: center;">Clear CMOS</p>  <p style="text-align: center;">1</p>

Checking Connector

CPU_FAN: CPU Cooling Fan Connector

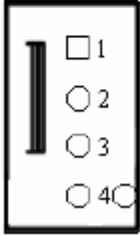
	Pin	Signal Name	Function
	1	GND	System Ground
	2	+12V	Power +12V
	3	Sense	Sensor
	4	Control	FAN Control Signal

SYS_FAN/PWR_FAN: FAN Power Connectors

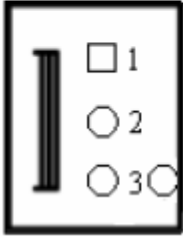
	Pin	Signal Name	Function
	1	GND	System Ground
	2	+12V	Power +12V
	3	Sense	Sensor

ATX12V: ATX 12V Power Connector

Pin	Signal Name
1	Ground
2	Ground
3	+12V
4	+12V

ATX_POWER: ATX 24-pin Power Connector

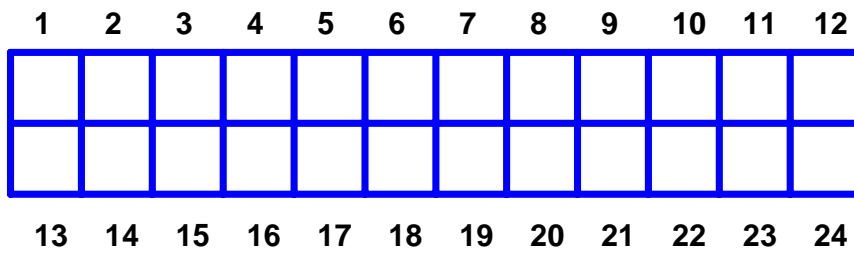

Pin	Signal Name	Pin	Signal Name
1	+3.3	13	+3.3V
2	+3.3	14	-12V
3	COM	15	COM
4	+5V	16	PS_ON
5	COM	17	COM
6	+5V	18	COM
7	COM	19	COM
8	PWR OK	20	-5V
9	5VSB	21	+5V
10	+12V	22	+5V
11	+12V	23	+5V
12	+3.3V	24	COM

Front Panel Header

The front panel header (PANEL1) provides a standard set of switch and LED connectors commonly found on ATX or Micro ATX cases. Refer to the table below for information:

Illustration	Pin	Signal	Pin	Signal
	1	5V_SYS	2	GPIO_GRN_HDR_R
	3	HDD_LED_R	4	GPIO_YLW_HDR_R
	5	GND	6	PSIN
	7	ICH_SYS_RS TJ	8	GND
	9	5V_SYS	10	KEY
	11	NC	12	5V_SB
	13	NC	14	LAN_ACTJ

Front USB

Illustration	Pin	Signal	Function	Pin	Signal	Function
	1	VREG_FP_U SBPWR0	Front panel USB power(Ports 0,1)	2	VREG_FP_U SBPWR0	Front panel USB power(Ports 0,1)
	3	USB_FP_P0-	Front panel USB Port 0 Negative Signal	4	USB_FP_P1-	Front panel USB Port 1 Negative Signal
	5	USB_FP_P0+	Front panel USB Port 0 Positive Signal	6	USB_FP_P1+	Front panel USB Port 1 Positive Signal
	7	GROUND		8	GROUND	
	9	KEY		10	GROUND	

Front Audio

Illustration	Pin	Signal Name	Pin	Signal Name
	1	MIC2-L	2	AUD_GND
	3	MIC2-R	4	AUD_PRESENCE_L
	5	LINE2-R	6	MIC2-JD
	7	FRONT-IO-SENSE	8	KEY
	9	LINE2-L	10	LINE2-JD

Intruder

Pin	Signal Name	Pin	Signal Name
1	INTRUDERJ	2	GROUND

J3(for requested)

Pin	Signal Name	Pin	Signal Name
1	AGPIO1	2	GROUND

J4(for requested)

Pin	Signal Name	Pin	Signal Name
1	AGPIO2	2	GROUND

(Top-View)

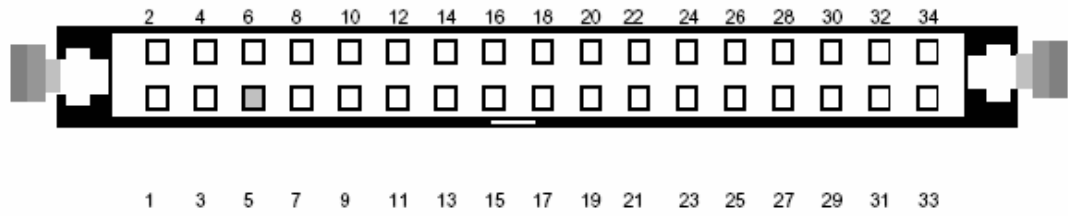

Pin	Signal Name	Pin	Signal Name
1	Ground	2	DRV DEN0
3	Ground	4	HDL-
5	Keypin	6	DS3-
7	Ground	8	INDEX-
9	Ground	10	MTR0-
11	Ground	12	DS0-
13	Ground	14	DS1-
15	Ground	16	MTR1-
17	Ground	18	DIR-
19	Ground	20	STEP-
21	Ground	22	WDATA
23	Ground	24	WGATE-
25	Ground	26	TRK0-
27	Ground	28	WP-
29	Ground	30	RDATA
31	Ground	32	HDSEL-
33	Ground	34	DSKCHG-

FRU (Field Replaceable Unit) List

This chapter gives you the FRU (Field Replaceable Unit) listing in global configurations of **Aspire M5700**. Refer to this chapter whenever ordering for parts to repair or for RMA (Return Merchandise Authorization).

NOTE: Please note WHEN ORDERING FRU PARTS, that you should check the most up-to-date information available on your regional web or channel. For whatever reasons a part number change is made, it will not be noted in the printed Service Guide. For ACER-AUTHORIZED SERVICE PROVIDERS, your Acer office may have a DIFFERENT part number code to those given in the FRU list of this printed Service Guide. You MUST use the local FRU list provided by your regional Acer office to order FRU parts for repair and service of customer machines.

Exploded Diagram

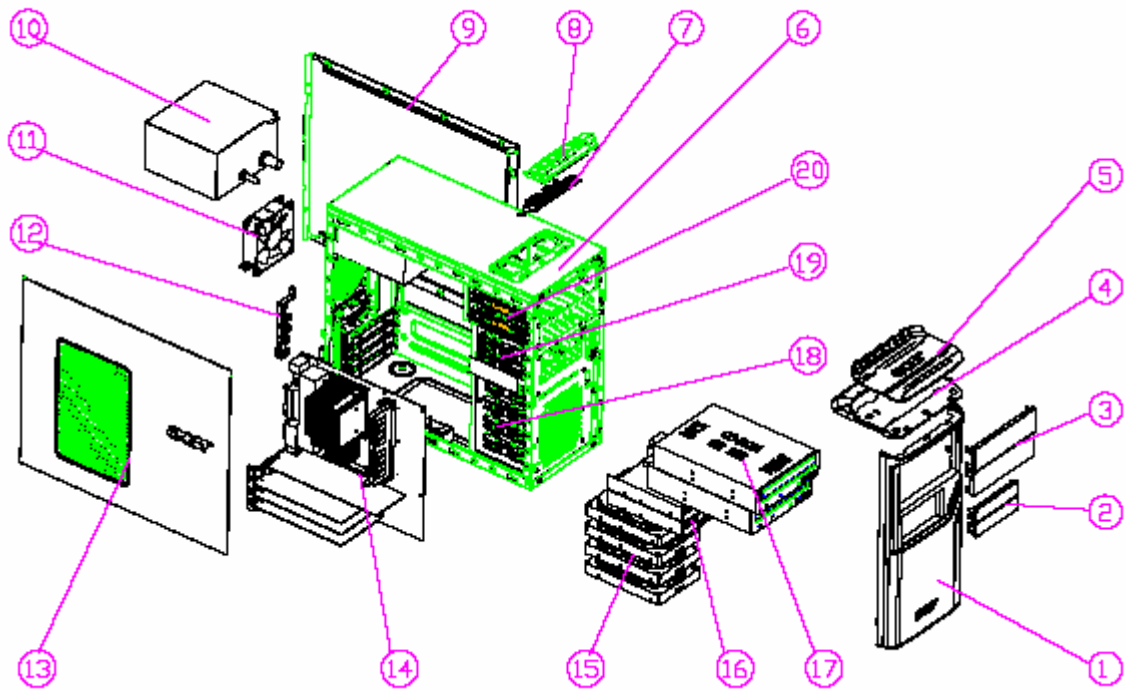

NO	DESCRIPTION	NO	DESCRIPTION
1	MAIN-BEZEL	11	FAN
2	3-25-COVER	12	PCI-BRACKET
3	5-25-COVER	13	LEFT SIDE DOOR
4	USB	14	NOTHERBOARD
5	USB-PENEL	15	HDD
6	CHASSIS	16	3.5' DEVICE
7	USB-PCE-ASN	17	CD-ROM
8	USB-SHTELDING	18	HDD-LOCK-SLIDE
9	RIGHT SIDE DOOR	19	FDD-LOCK-SLTDE
10	POWER SUPPLY	20	CD-ROM LOCK SLIDE

Free Manuals Download Website

<http://myh66.com>

<http://usermanuals.us>

<http://www.somanuals.com>

<http://www.4manuals.cc>

<http://www.manual-lib.com>

<http://www.404manual.com>

<http://www.luxmanual.com>

<http://aubethermostatmanual.com>

Golf course search by state

<http://golfingnear.com>

Email search by domain

<http://emailbydomain.com>

Auto manuals search

<http://auto.somanuals.com>

TV manuals search

<http://tv.somanuals.com>