

A8R-MVP

ASUS[®]

Motherboard

E2319

**Revised Edition V2
November 2005**

Copyright © 2005 ASUSTeK COMPUTER INC. All Rights Reserved.

No part of this manual, including the products and software described in it, may be reproduced, transmitted, transcribed, stored in a retrieval system, or translated into any language in any form or by any means, except documentation kept by the purchaser for backup purposes, without the express written permission of ASUSTeK COMPUTER INC. ("ASUS").

Product warranty or service will not be extended if: (1) the product is repaired, modified or altered, unless such repair, modification or alteration is authorized in writing by ASUS; or (2) the serial number of the product is defaced or missing.

ASUS PROVIDES THIS MANUAL "AS IS" WITHOUT WARRANTY OF ANY KIND, EITHER EXPRESS OR IMPLIED, INCLUDING BUT NOT LIMITED TO THE IMPLIED WARRANTIES OR CONDITIONS OF MERCHANTABILITY OR FITNESS FOR A PARTICULAR PURPOSE. IN NO EVENT SHALL ASUS, ITS DIRECTORS, OFFICERS, EMPLOYEES OR AGENTS BE LIABLE FOR ANY INDIRECT, SPECIAL, INCIDENTAL, OR CONSEQUENTIAL DAMAGES (INCLUDING DAMAGES FOR LOSS OF PROFITS, LOSS OF BUSINESS, LOSS OF USE OR DATA, INTERRUPTION OF BUSINESS AND THE LIKE), EVEN IF ASUS HAS BEEN ADVISED OF THE POSSIBILITY OF SUCH DAMAGES ARISING FROM ANY DEFECT OR ERROR IN THIS MANUAL OR PRODUCT.

SPECIFICATIONS AND INFORMATION CONTAINED IN THIS MANUAL ARE FURNISHED FOR INFORMATIONAL USE ONLY, AND ARE SUBJECT TO CHANGE AT ANY TIME WITHOUT NOTICE, AND SHOULD NOT BE CONSTRUED AS A COMMITMENT BY ASUS. ASUS ASSUMES NO RESPONSIBILITY OR LIABILITY FOR ANY ERRORS OR INACCURACIES THAT MAY APPEAR IN THIS MANUAL, INCLUDING THE PRODUCTS AND SOFTWARE DESCRIBED IN IT.

Products and corporate names appearing in this manual may or may not be registered trademarks or copyrights of their respective companies, and are used only for identification or explanation and to the owners' benefit, without intent to infringe.

Contents

Notices	vii
Safety information	viii
About this guide	ix
A8R-MVP specifications summary	xi

Chapter 1: Product introduction

1.1 Welcome!	1-1
1.2 Package contents	1-1
1.3 Special features	1-2
1.3.1 Product highlights	1-2
1.3.3 Innovative ASUS features	1-4

Chapter 2: Hardware information

2.1 Before you proceed	2-1
2.2 Motherboard overview	2-2
2.2.1 Placement direction	2-2
2.2.2 Screw holes	2-2
2.2.3 Motherboard layout	2-3
2.2.4 Layout Contents	2-4
2.3 Central Processing Unit (CPU)	2-5
2.3.1 Installing the CPU	2-5
2.3.2 Installing the heatsink and fan	2-7
2.4 System memory	2-10
2.4.1 Overview	2-10
2.4.2 Memory Configurations	2-11
2.4.3 Installing a DDR DIMM	2-13
2.4.4 Removing a DDR DIMM	2-13
2.5 Expansion slots	2-14
2.5.1 Installing an expansion card	2-14
2.5.2 Configuring an expansion card	2-14
2.5.3 Interrupt assignments	2-15
2.5.4 PCI slots	2-16
2.5.5 PCI Express x1 slot	2-16
2.5.6 Two PCI Express x16 slots	2-16

Contents

2.6	Jumper	2-18
2.7	Connectors	2-19
2.7.1	Rear panel connectors	2-19
2.7.2	Internal connectors.....	2-21

Chapter 3: Powering up

3.1	Starting up for the first time	3-1
3.2	Powering off the computer	3-2
3.2.1	Using the OS shut down function	3-2
3.2.2	Using the dual function power switch	3-2

Chapter 4: BIOS setup

4.1	Managing and updating your BIOS	4-1
4.1.1	ASUS Update utility	4-1
4.1.2	Creating a bootable floppy disk.....	4-4
4.1.3	ASUS EZ Flash utility	4-5
4.1.4	AFUDOS utility	4-6
4.1.5	ASUS CrashFree BIOS 2 utility	4-9
4.2	BIOS setup program	4-11
4.2.1	BIOS menu screen.....	4-12
4.2.2	Menu bar	4-12
4.2.3	Navigation keys	4-12
4.2.4	Menu items	4-13
4.2.5	Sub-menu items	4-13
4.2.6	Configuration fields	4-13
4.2.7	Pop-up window	4-13
4.2.8	Scroll bar	4-13
4.2.9	General help	4-13
4.3	Main menu	4-14
4.3.1	System Time	4-14
4.3.2	System Date	4-14
4.3.3	Legacy Diskette A	4-14
4.3.4	Primary, Secondary, Third, and Fourth IDE Master/Slave	4-15
4.3.5	Storage Configuration	4-16
4.3.6	System Information	4-17

Contents

4.4	Advanced menu	4-18
4.4.1	JumperFree Configuration	4-18
4.4.2	CPU Configuration	4-22
4.4.3	Chipset Configuration	4-26
4.4.4	Onboard Devices Configuration	4-27
4.4.5	PCI PnP	4-29
4.4.6	LAN Cable Status	4-30
4.4.7	USB Configuration	4-30
4.5	Power menu	4-32
4.5.1	Suspend Mode	4-32
4.5.2	Repost Video on S3 Resume	4-32
4.5.3	ACPI 2.0 Support	4-32
4.5.4	ACPI APIC Support	4-32
4.5.5	APM Configuration	4-33
4.5.6	Hardware Monitor	4-35
4.6	Boot menu	4-37
4.6.1	Boot Device Priority	4-38
4.6.2	Boot Settings Configuration	4-39
4.6.3	Security	4-40
4.7	Exit menu	4-42

Chapter 5: Software support

5.1	Installing an operating system	5-1
5.2	Support CD information	5-1
5.2.1	Running the support CD	5-1
5.2.2	Drivers menu	5-2
5.2.3	Utilities menu	5-3
5.2.4	Make Disk menu	5-4
5.2.5	Manuals menu	5-5
5.2.6	ASUS Contact information	5-6
5.2.7	Other information	5-6

Contents

5.3	Software information	5-8
5.3.1	ASUS MyLogo™	5-8
5.3.2	AI Net 2	5-10
	Using the Virtual Cable Tester™	5-10
5.3.3	ASUS PC Probe II.....	5-11
5.3.4	Cool 'n' Quiet™ Technology	5-17
5.3.5	SoundMAX® High Definition Audio utility	5-19
	Audio Setup Wizard	5-20
5.4	RAID configurations	5-24
5.4.1	Installing hard disks	5-25
5.4.2	ULI® RAID configurations	5-25
5.5	Creating a RAID driver disk	5-33

Chapter 6: ATI® MVP technology support

6.1	Overview.....	6-1
6.2	Hardware installation	6-2
6.2.1	Installing a single graphics card	6-2
6.2.2	Installing CrossFire™ graphics cards	6-3
6.3	Software information	6-6
6.3.1	Installing the device drivers	6-6
6.3.2	Using the Catalyst™ Control Center	6-8

Notices

Federal Communications Commission Statement

This device complies with Part 15 of the FCC Rules. Operation is subject to the following two conditions:

- This device may not cause harmful interference, and
- This device must accept any interference received including interference that may cause undesired operation.

This equipment has been tested and found to comply with the limits for a Class B digital device, pursuant to Part 15 of the FCC Rules. These limits are designed to provide reasonable protection against harmful interference in a residential installation. This equipment generates, uses and can radiate radio frequency energy and, if not installed and used in accordance with manufacturer's instructions, may cause harmful interference to radio communications. However, there is no guarantee that interference will not occur in a particular installation. If this equipment does cause harmful interference to radio or television reception, which can be determined by turning the equipment off and on, the user is encouraged to try to correct the interference by one or more of the following measures:

- Reorient or relocate the receiving antenna.
- Increase the separation between the equipment and receiver.
- Connect the equipment to an outlet on a circuit different from that to which the receiver is connected.
- Consult the dealer or an experienced radio/TV technician for help.



The use of shielded cables for connection of the monitor to the graphics card is required to assure compliance with FCC regulations. Changes or modifications to this unit not expressly approved by the party responsible for compliance could void the user's authority to operate this equipment.

Canadian Department of Communications Statement

This digital apparatus does not exceed the Class B limits for radio noise emissions from digital apparatus set out in the Radio Interference Regulations of the Canadian Department of Communications.

This class B digital apparatus complies with Canadian ICES-003.

Safety information

Electrical safety

- To prevent electrical shock hazard, disconnect the power cable from the electrical outlet before relocating the system.
- When adding or removing devices to or from the system, ensure that the power cables for the devices are unplugged before the signal cables are connected. If possible, disconnect all power cables from the existing system before you add a device.
- Before connecting or removing signal cables from the motherboard, ensure that all power cables are unplugged.
- Seek professional assistance before using an adapter or extension cord. These devices could interrupt the grounding circuit.
- Make sure that your power supply is set to the correct voltage in your area. If you are not sure about the voltage of the electrical outlet you are using, contact your local power company.
- If the power supply is broken, do not try to fix it by yourself. Contact a qualified service technician or your retailer.

Operation safety

- Before installing the motherboard and adding devices on it, carefully read all the manuals that came with the package.
- Before using the product, make sure all cables are correctly connected and the power cables are not damaged. If you detect any damage, contact your dealer immediately.
- To avoid short circuits, keep paper clips, screws, and staples away from connectors, slots, sockets and circuitry.
- Avoid dust, humidity, and temperature extremes. Do not place the product in any area where it may become wet.
- Place the product on a stable surface.
- If you encounter technical problems with the product, contact a qualified service technician or your retailer.



The symbol of the crossed out wheeled bin indicates that the product (electrical and electronic equipment) should not be placed in municipal waste. Please check local regulations for disposal of electronic products.

About this guide

This user guide contains the information you need when installing and configuring the motherboard.

How this guide is organized

This guide contains the following parts:

- **Chapter 1: Product introduction**
This chapter describes the features of the motherboard and the new technology it supports.
- **Chapter 2: Hardware information**
This chapter lists the hardware setup procedures that you have to perform when installing system components. It includes description of the switches, jumpers, and connectors on the motherboard.
- **Chapter 3: Powering up**
This chapter describes the power up sequence, the vocal POST messages, and ways of shutting down the system.
- **Chapter 4: BIOS setup**
This chapter tells how to change system settings through the BIOS Setup menus. Detailed descriptions of the BIOS parameters are also provided.
- **Chapter 5: Software support**
This chapter describes the contents of the support CD that comes with the motherboard package.
- **Chapter 6: ATI® MVP technology support**
This chapter tells how to install ATI® MVP graphics cards.

Where to find more information

Refer to the following sources for additional information and for product and software updates.

1. ASUS websites

The ASUS website provides updated information on ASUS hardware and software products. Refer to the ASUS contact information.

2. Optional documentation

Your product package may include optional documentation, such as warranty flyers, that may have been added by your dealer. These documents are not part of the standard package.

Conventions used in this guide

To make sure that you perform certain tasks properly, take note of the following symbols used throughout this manual.



DANGER/WARNING: Information to prevent injury to yourself when trying to complete a task.



CAUTION: Information to prevent damage to the components when trying to complete a task.



IMPORTANT: Instructions that you **MUST** follow to complete a task.



NOTE: Tips and additional information to help you complete a task.

Typography

Bold text

Indicates a menu or an item to select.

Italics

Used to emphasize a word or a phrase.

<Key>

Keys enclosed in the less-than and greater-than sign means that you must press the enclosed key.

Example: <Enter> means that you must press the Enter or Return key.

<Key1+Key2+Key3>

If you must press two or more keys simultaneously, the key names are linked with a plus sign (+).

Example: <Ctrl+Alt+D>

Command

Means that you must type the command exactly as shown, then supply the required item or value enclosed in brackets.

Example: At the DOS prompt, type the command line:

```
afudos /i[filename]
```

```
afudos /iA8R-MVP.ROM
```

A8R-MVP specifications summary

CPU	Socket 939 for AMD Athlon™ 64FX/Athlon™ 64 X2/ Athlon™ 64/Sempron™ processor* AMD64 architecture enables simultaneous 32- and 64-bit computing Supports AMD Cool 'n' Quiet™ Technology Supports AMD HyperTransport™ Technology
Chipset	ATI Radeon® Xpress 200 CrossFire™
System bus	2000/1600 MT/s
Memory	Dual-channel memory architecture 4 x 184-pin DIMM sockets support up to 4 GB unbuffered ECC/non-ECC 400/333/266 MHz DDR memory modules
Expansion slots	2 x PCI Express™ x16 slot for discrete graphics card 1 x PCI Express™ x1 slot 3 x PCI slots
CrossFire™	Supports ATI CrossFire™ graphics cards (both at x8 mode)
Storage	ULi M1575 Southbridge supports: - 2 x IDE connectors for up to four Ultra DMA 133/100/66/33 hard disks - 4 x Serial ATA I/II 3.0 Gb/s hard disks with RAID 0, RAID 1, RAID 1+0, RAID 5, and JBOD configuration
AI Audio	ADI SoundMAX® AD1986A 6-channel CODEC S/PDIF Out port on the rear panel
LAN	Marvell® 88E8001 Gigabit LAN controller featuring AI NET2
IEEE 1394a	T1 1394 controller supports: - 2 x IEEE 1394a ports (one on the rear panel and one at mid-board)
USB	Supports up to 8 USB 2.0/1.1 ports
BIOS features	4 Mb Flash ROM, AMI BIOS, PnP, DMI2.0, WfM2.0
Special features	ASUS MyLogo™ ASUS CrashFree BIOS 2 ASUS Q-Fan2 Technology ASUS EZ Flash

(continued on the next page)

A8R-MVP specifications summary

Overclocking	<p>ASUS PEG Link AI Overclocking (intelligent CPU frequency tuner) Precision Tweaker:</p> <ul style="list-style-type: none"> - vDIMM: 8-step DRAM voltage control - vCore: Adjustable CPU voltage at 0.025 increment - Stepless Frequency Selection (SFS) allows FSB tuning from 200 MHz up to 400 MHz at 1 MHz increment <p>ASUS C.P.R. (CPU Parameter Recall)</p>
Rear panel	<p>1 x PS/2 mouse port 1 x PS/2 keyboard port 1 x Parallel port 1 x LAN (RJ-45) port 4 x USB 2.0 ports 1 x Serial (COM) port 1 x Coaxial S/PDIF port 1 x IEEE 1394a port 6-Channel audio ports</p>
Manageability	<p>WfM 2.0, DMI 2.0, WOL by PME, WOR by PME, chassis intrusion, PXE, and RPL</p>
Internal connectors	<p>1 x Floppy disk drive connector 2 x IDE connectors 4 x Serial ATA connectors 1 x CPU fan connector 1 x Chassis fan connector 1 x Power fan connector 1 x IEEE 1394a connector 2 x USB 2.0 connectors for four additional USB 2.0 ports 1 x 24-pin EATX power connector 1 x 4-pin ATX 12 V power connector 1 x EZ Plug connector 1 x GAME/MIDI port connector 1 x CD-in connector 1 x AUX connector 1 x Chassis intrusion connector 1 x Front panel High Definition Audio connector 1 x System panel connector</p>
Support CD contents	<p>Drivers ASUS PC Probe 2 ASUS LiveUpdate Utility Anti-virus software (OEM version)</p>
Form factor	<p>ATX form factor: 12 in x 9.6 in (30.5 cm x 24.4 cm)</p>

Specifications are subject to change without notice.

This chapter describes the motherboard features and the new technologies it supports

1 Product information

Chapter summary



1.1	Welcome!	1-1
1.2	Package contents	1-1
1.3	Special features	1-2

1.1 Welcome!

Thank you for buying an ASUS® A8R-MVP motherboard!

The motherboard delivers a host of new features and latest technologies, making it another standout in the long line of ASUS quality motherboards!

Before you start installing the motherboard, and hardware devices on it, check the items in your package with the list below.

1.2 Package contents

Check your motherboard package for the following items.

Motherboard	ASUS A8R-MVP motherboard
Cables	1 x Floppy disk drive signal cable 1 x IDE cable 1 x Ultra DMA cable 133/100/66 cable 2 x Serial ATA signal cables 1 x Serial ATA power cable (dual-plug) 1 x IEEE 1394a cable
Accessories	I/O shield 1 x MVP Switch Card 1 x 2-port USB 2.0/Game module
Application CDs	ASUS motherboard support CD
Documentation	User guide



If any of the above items is damaged or missing, contact your retailer.



In single card mode, install the MVP Switch Card on the black PCI Express slot.

1.3 Special features

1.3.1 Product highlights

Latest processor technology



The motherboard comes with a 939-pin surface mount, Zero Insertion Force (ZIF) socket that supports AMD Athlon™ 64/Athlon™ 64 FX/Athlon™ 64 X2/Sempron™ processors. With an integrated low-latency high-bandwidth memory controller and a highly-scalable HyperTransport™ technology-based system bus, the motherboard provides a powerful platform for your diverse computing needs, increased office productivity, and enhanced digital media experience. See page 2-5.

ATI Radeon® Xpress 200 CrossFire™



The ATI Radeon® Xpress 200 CrossFire™ boosts image quality and rendering speed, eliminating the need to crank down screen resolutions to get high quality images. The chipset allows higher antialiasing, anisotropic filtering, shading, and texture settings. ATI Radeon® Xpress 200 CrossFire™ features the ATI Catalyst™ Control Center that allows you to get real-time 3D-rendered previews of adjustments to your display configurations and advanced 3D settings. See Chapter 6 for details.

PCI Express™ interface



The motherboard fully supports PCI Express, the latest I/O interconnect technology that speeds up the PCI bus. PCI Express features point-to-point serial interconnections between devices and allows higher clockspeeds by carrying data in packets. This high speed interface is software compatible with existing PCI specifications. See page 2-16 for details.

6-channel High Definition audio



Onboard is the SoundMAX® ADI AD1986A 6-channel CODEC that supports Jack Sensing and Enumeration Technology. The CODEC supports High Definition Audio standard. With the CODEC, 6-channel audio ports, and S/PDIF interface, your computer will produce crystal-clear digital audio. See page 5-19 for details.

Serial ATA I/II technology



The motherboard supports the Serial ATA II 3 Gb/s technology through the Serial ATA interfaces and the ULI M1575 Southbridge. The Serial ATA II 3 Gb/s specification provides twice the bandwidth of the current Serial ATA products with a host of new features, including Native Command Queuing (NCQ), and Power Management (PM) Implementation Algorithm. Serial ATA allows for thinner, more flexible cables with lower pin count, reduced voltage requirement. See page 2-22 for details.

SATA RAID solution



Onboard RAID controllers provide the motherboard with RAID functionality. The ULI M1575 Southbridge allows RAID 0, RAID 1, RAID 0+1, RAID 5, and JBOD configuration. See page 5-25 for details.

Gigabit LAN



The motherboard comes with the Marvell® Yukon™ 88E8001 Gigabit LAN controller to meet your growing networking needs. See pages 2-19 and 5-10 for details.

IEEE 1394a support



The IEEE 1394a interface provides high-speed and flexible PC connectivity to a wide range of peripherals and devices compliant to IEEE 1394a standards. The IEEE 1394a interface allows up to 400 Mbps transfer rates through simple, low-cost, high-bandwidth asynchronous (real-time) data interfacing between computers, peripherals, and consumer electronic devices such as camcorders, VCRs, printers, TVs, and digital cameras. See pages 2-19 and 2-26 for details.

USB 2.0 technology



The motherboard implements the Universal Serial Bus (USB) 2.0 specification, dramatically increasing the connection speed from the 12 Mbps bandwidth on USB 1.1 to a fast 480 Mbps on USB 2.0. USB 2.0 is backward compatible with USB 1.1. See pages 2-20 and 2-24 for details.

1.3.3 Innovative ASUS features

AI NET2

The AI NET2 is a BIOS-based diagnostic tool that detects and reports Ethernet cable faults and shorts. With this utility, you can easily monitor the condition of the Ethernet cable(s) connected to the LAN (RJ-45) port(s). During the bootup process, AI NET2 immediately diagnoses the LAN cable(s) and reports shorts and faults up to 100 meters at 1 meter accuracy. See page 5-10 for details.

Precision Tweaker

This feature allows you to fine tune the CPU/memory voltage and gradually increase the memory Front Side Bus (FSB) and PCI Express frequency at 1MHz increment to achieve maximum system performance. See pages 4-19 and 4-20 for details.

PEG Link Mode for two graphics cards

This feature enhances your PCI Express graphics card performance, allowing the motherboard to automatically adjust the PCI Express graphics link mode to the correct frequency based on the system configuration. Four additional settings are available for overclocking the PEG Link Mode. See page 4-20 for details.

ASUS Q-Fan 2 technology

The ASUS Q-Fan 2 technology smartly adjusts the CPU fan speed according to the system loading to ensure quiet, cool, and efficient operation. See page 4-35 for details.

ASUS CrashFree BIOS 2

This feature allows you to restore the original BIOS data from the support CD when the BIOS codes and data are corrupted. This protection eliminates the need to buy a replacement ROM chip. See page 4-9 for details.

ASUS MyLogo™

This feature allows you to personalize and add style to your system with customizable boot logos. See page 5-8 for details.

C.P.R. (CPU Parameter Recall)

The C.P.R. feature of the motherboard BIOS allows automatic re-setting to the BIOS default settings in case the system hangs due to overclocking. When the system hangs due to overclocking, C.P.R. eliminates the need to open the system chassis and clear the RTC data. Simply shut down and reboot the system, and the BIOS automatically restores the CPU default setting for each parameter.

ASUS EZ Flash BIOS

With the ASUS EZ Flash, you can easily update the system BIOS even before loading the operating system. No need to use a DOS-based utility or boot from a floppy disk. See page 4-5 for details.

This chapter lists the hardware setup procedures that you have to perform when installing system components. It includes description of the jumpers and connectors on the motherboard.

Hardware information



Chapter summary



2.1	Before you proceed	2-1
2.2	Motherboard overview	2-2
2.3	Central Processing Unit (CPU)	2-5
2.4	System memory	2-10
2.5	Expansion slots	2-14
2.6	Jumper	2-18
2.7	Connectors	2-19

2.1 Before you proceed

Take note of the following precautions before you install motherboard components or change any motherboard settings.



- Unplug the power cord from the wall socket before touching any component.
- Use a grounded wrist strap or touch a safely grounded object or a metal object, such as the power supply case, before handling components to avoid damaging them due to static electricity
- Hold components by the edges to avoid touching the ICs on them.
- Whenever you uninstall any component, place it on a grounded antistatic pad or in the bag that came with the component.
- **Before you install or remove any component, ensure that the ATX power supply is switched off or the power cord is detached from the power supply.** Failure to do so may cause severe damage to the motherboard, peripherals, and/or components.

Onboard LED

The motherboard comes with a standby power LED that lights up to indicate that the system is ON, in sleep mode, or in soft-off mode. This is a reminder that you should shut down the system and unplug the power cable before removing or plugging in any motherboard component. The illustration below shows the location of the onboard LED.

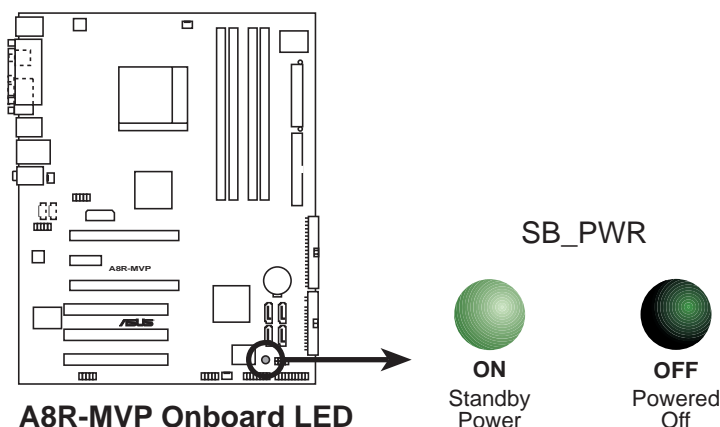

Make sure to connect the EZPlug when using two PCI Express graphics cards and a 20-pin ATX power supply unit, or if the graphics cards do not have auxiliary power plugs. See page 2-24 for the location of the EZPlug connector.

2.2 Motherboard overview

Before you install the motherboard, study the configuration of your chassis to ensure that the motherboard fits into it. Refer to the chassis documentation before installing the motherboard.



Make sure to unplug the power cord before installing or removing the motherboard. Failure to do so can cause you physical injury and damage motherboard components.

2.2.1 Placement direction

When installing the motherboard, make sure that you place it into the chassis in the correct orientation. The edge with external ports goes to the rear part of the chassis as indicated in the image below.

2.2.2 Screw holes

Place nine (9) screws into the holes indicated by circles to secure the motherboard to the chassis.



Do not overtighten the screws! Doing so can damage the motherboard.

Place this side towards
the rear of the chassis

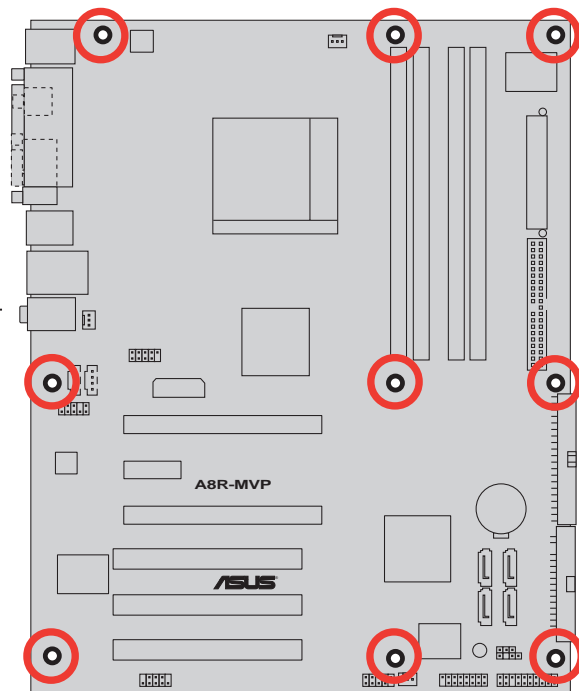

2.2.3 Motherboard layout

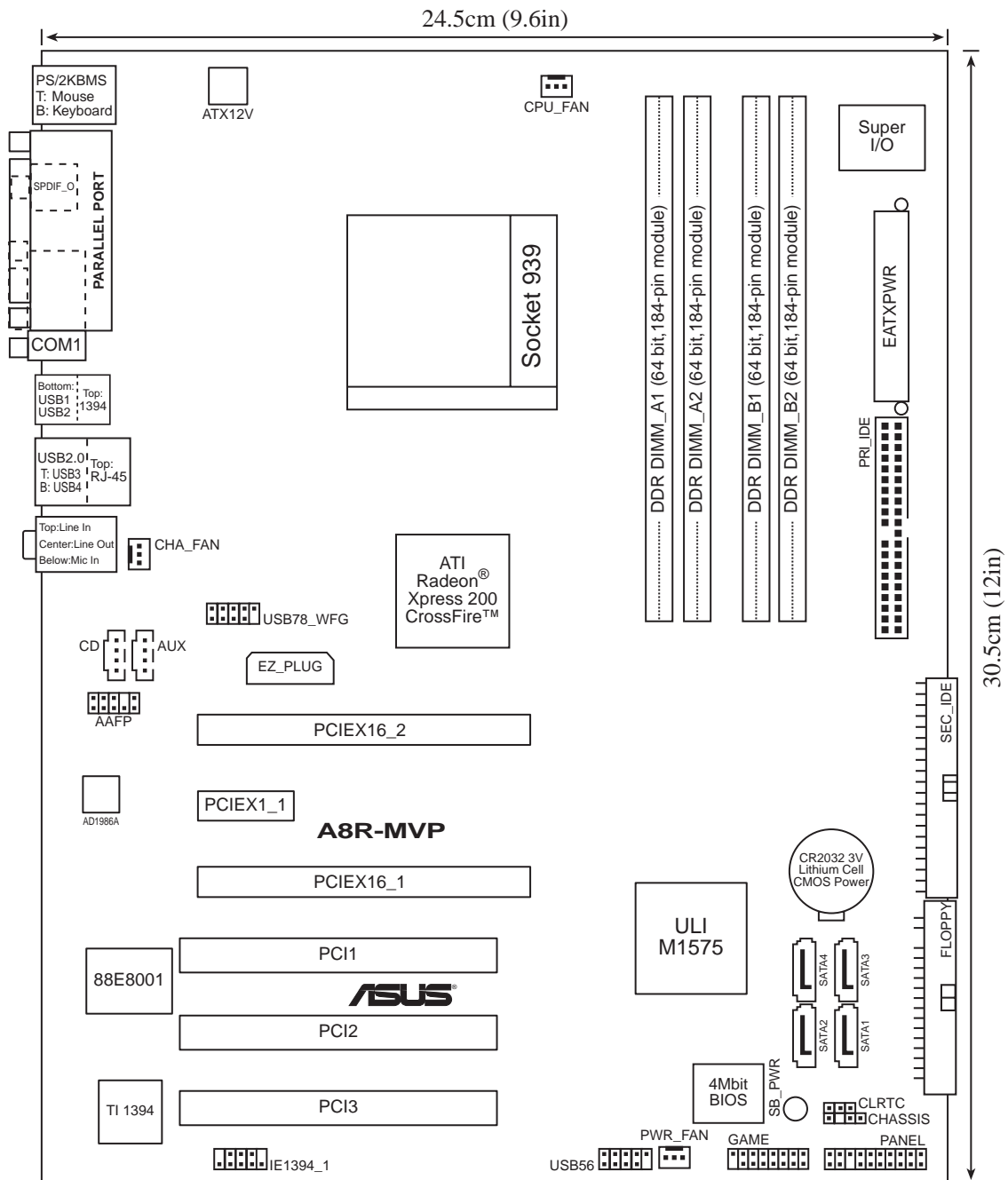

2.2.4 Layout Contents

Slots	Page
1. DDR DIMM slots	2-10
2. PCI slots	2-16
3. PCI Express x1 slot	2-16
4. PCI Express x16 slots	2-16

Jumper	Page
1. Clear RTC RAM (3-pin CLRRTC)	2-18

Rear panel connectors	Page
1. PS/2 mouse port	2-19
2. Parallel port	2-19
3. IEEE 1394a port	2-19
4. LAN (RJ-45) port	2-19
5. Line In port	2-19
6. Line Out port	2-19
7. Microphone port	2-19
8. USB 2.0 ports 3 and 4	2-20
9. USB 2.0 ports 1 and 2	2-20
10. Serial port	2-20
11. Coaxial S/PDIF Out port	2-20
12. PS/2 keyboard port	2-20

Internal connectors	Page
1. Floppy disk drive connector (34-1 pin FLOPPY)	2-21
2. IDE connectors (40-1 pin PRI_IDE, 40-1 pin SEC_IDE)	2-21
3. Serial ATA connectors (7-pin SATA1 [red], SATA2 [red], SATA3 [black], SATA4 [black])	2-22
4. CPU, Chassis, and Power fan connectors (3-pin CPU_FAN, 3-pin CHA_FAN, 3-pin PWR_FAN)	2-23
5. USB connectors (10-1 USB56, USB78_WFG)	2-24
6. Power connectors (24-pin EATXPWR, 4-pin ATX12V; 4-pin EZ_PLUG)	2-24
7. GAME/MIDI port connector (16-1 pin GAME)	2-25
8. IEEE 1394a connector (10-1 pin IE1394_1)	2-26
9. Chassis intrusion connector (4-1 pin CHASSIS)	2-26
10. Front panel audio connector (10-1 pin AAFP)	2-27
11. Internal audio connectors (4-pin CD [black], 4-pin AUX [white])	2-27
12. System panel connectors (20 pin PANEL) <ul style="list-style-type: none"> - System Power LED (Green 3-pin PLED) - Hard Disk activity (Red 2-pin IDE_LED) - System warning speaker (Orange 4-pin SPEAKER) - Power/Soft-off button (Yellow 2-pin PWRSW) - Reset switch (Blue 2-pin RESET) 	2-28

2.3 Central Processing Unit (CPU)

The motherboard comes with a surface mount 939-pin Zero Insertion Force (ZIF) socket designed for the AMD Athlon™ 64FX/AMD Athlon™ 64 / Athlon™ 64 X2 processor.

The 128-bit-wide data paths of these processors can run applications faster than processors with only 32-bit or 64-bit wide data paths.

Take note of the marked corner (with gold triangle) on the CPU. This mark should match a specific corner on the socket to ensure correct installation.

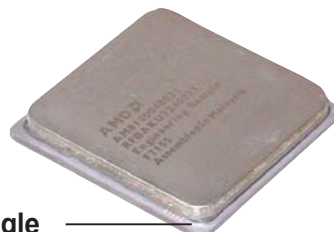

Gold triangle

2.3.1 Installing the CPU

To install a CPU.

1. Locate the 939-pin ZIF socket on the motherboard.

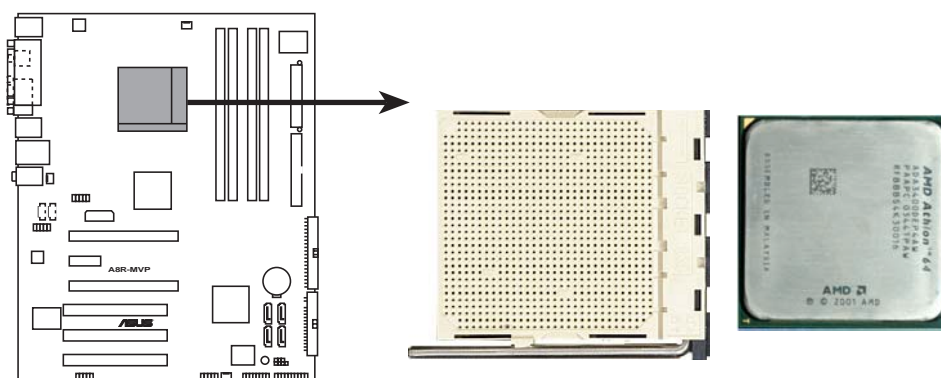

A8R-MVP CPU Socket 939

2. Unlock the socket by pressing the lever sideways, then lift it up to a 90°-100° angle.

Socket lever

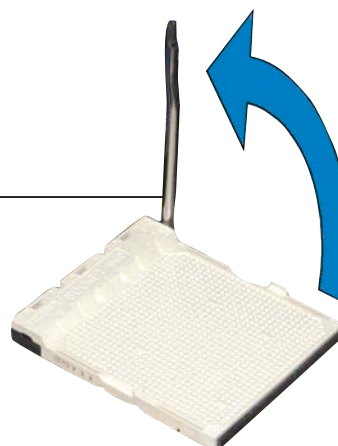

Make sure that the socket lever is lifted up to 90°-100° angle, otherwise the CPU does not fit in completely.

3. Position the CPU above the socket such that the CPU corner with the gold triangle matches the socket corner with a small triangle.
4. Carefully insert the CPU into the socket until it fits in place.

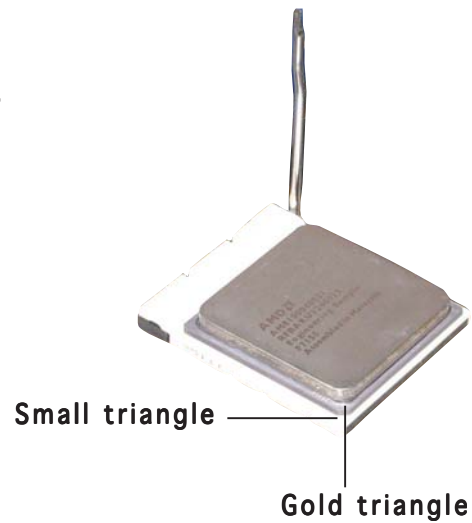

The CPU fits only in one correct orientation. **DO NOT** force the CPU into the socket to prevent bending the pins and damaging the CPU!

5. When the CPU is in place, push down the socket lever to secure the CPU. The lever clicks on the side tab to indicate that it is locked.
6. Install a CPU heatsink and fan following the instructions that came with the heatsink package.

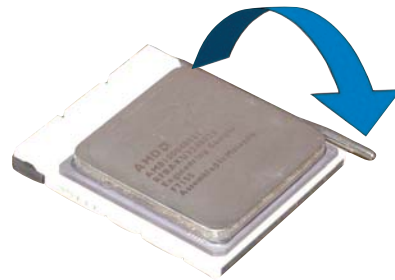

2.3.2 Installing the heatsink and fan

The AMD Athlon™ 64FX/Athlon™ 64/Athlon™ 64 X2/Sempron™ processor requires a specially designed heatsink and fan assembly to ensure optimum thermal condition and performance.



Make sure that you use only AMD-certified heatsink and fan assembly.

To install the CPU heatsink and fan:

1. Place the heatsink on top of the installed CPU, making sure that the heatsink fits properly on the retention module base.



- The retention module base is already installed on the motherboard upon purchase.
 - You do not have to remove the retention module base when installing the CPU or installing other motherboard components.
 - If you purchased a separate CPU heatsink and fan assembly, make sure that a Thermal Interface Material is properly applied to the CPU heatsink or CPU before you install the heatsink and fan assembly.
-

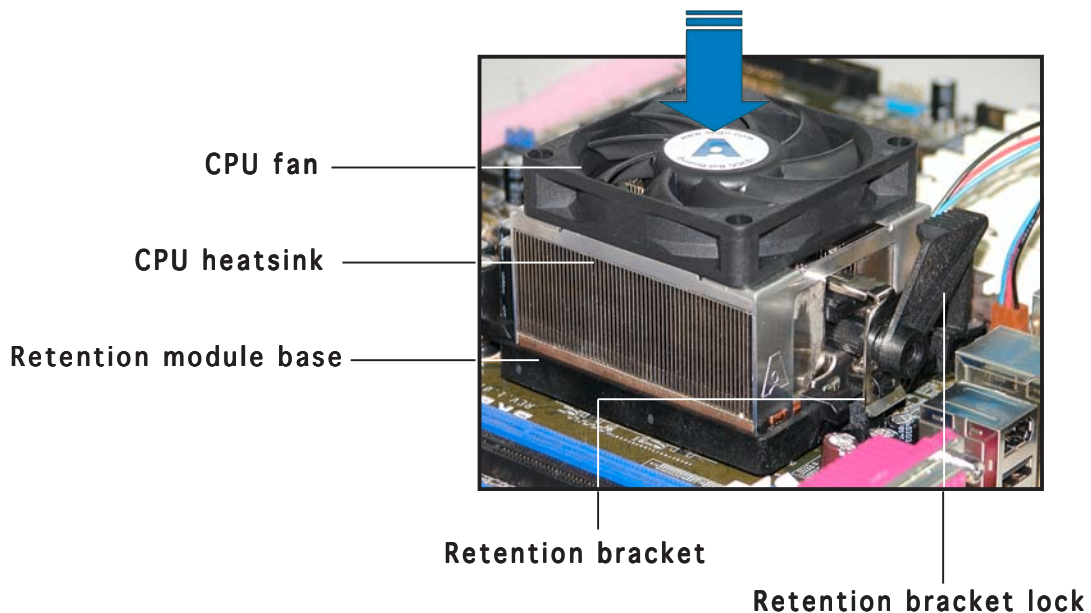

Your boxed CPU heatsink and fan assembly should come with installation instructions for the CPU, heatsink, and the retention mechanism. If the instructions in this section do not match the CPU documentation, follow the latter.

2. Attach one end of the retention bracket to the retention module base.

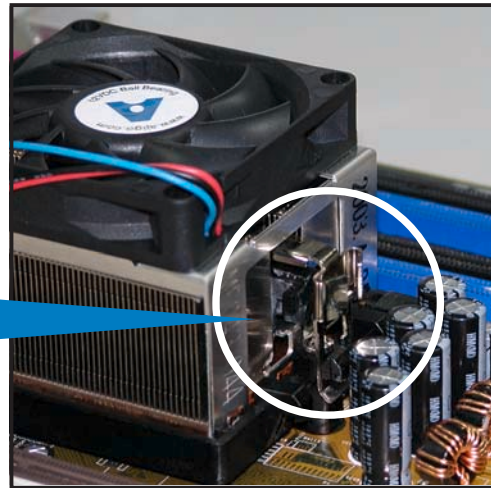
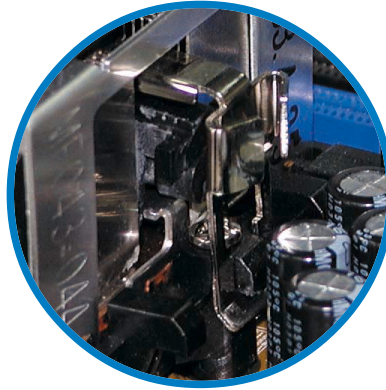

3. Align the other end of the retention bracket (near the retention bracket lock) to the retention module base. A clicking sound denotes that the retention bracket is in place.



Make sure that the fan and heatsink assembly perfectly fits the retention mechanism module base, otherwise you cannot snap the retention bracket in place.



4. Push down the retention bracket lock on the retention mechanism to secure the heatsink and fan to the module base.

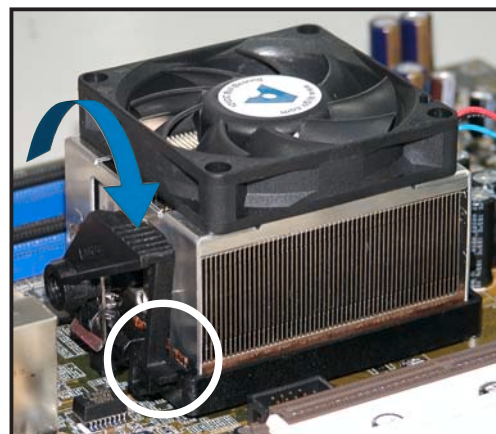

- When the fan and heatsink assembly is in place, connect the CPU fan cable to the connector on the motherboard labeled CPU_FAN.

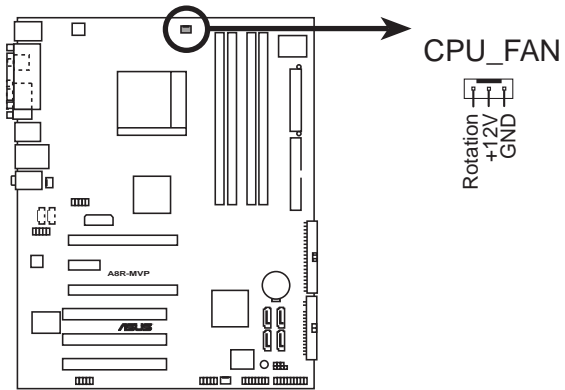

A8R-MVP CPU fan connector



Do not forget to connect the CPU fan connector! Hardware monitoring errors can occur if you fail to plug this connector.

2.4 System memory

2.4.1 Overview

The motherboard comes with four 184-pin Double Data Rate (DDR) Dual Inline Memory Modules (DIMM) sockets.

The following figure illustrates the location of the sockets:

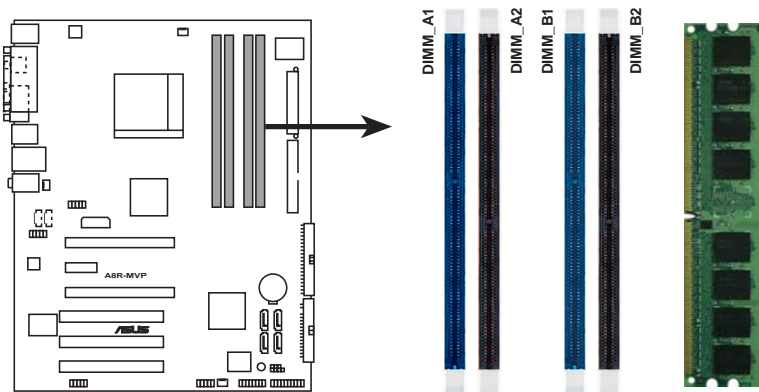

A8R-MVP 184-pin DDR DIMM sockets

Channel	Sockets
Channel 1	DIMM_A1 and DIMM_B1
Channel 2	DIMM_A2 and DIMM_B2



In dual-channel configurations, installing **identical** (the same type and size) DDR DIMM pairs for each channel provides optimum performance.

2.4.2 Memory Configurations

You may install 256 MB, 512 MB, and 1 GB unbuffered ECC/non-ECC DDR DIMMs into the DIMM sockets using the memory configurations in this section.



- If you installed four 1 GB memory modules, the system may detect less than 3 GB of total memory because of address space allocation for other critical functions. This limitation applies to Windows® XP 32-bit version operating system since it does not support Physical Address Extension (PAE).
- When using only one DDR DIMM module, install it into slot DIMM_B1 only.
- For single-channel memory configuration, start installing the DDR DIMMs from slot DIMM_B1 or DIMM_B2.
- For dual-channel memory configuration, install the DIMMs in slots DIMM_B1 and DIMM_A1 (blue slots); install another pair of DIMMs in slots DIMM_B2 and DIMM_A2 (black slots).
- Always install DIMMs with the same CAS latency. For optimum results, we recommend that you obtain memory modules from the same vendor. Refer to the Qualified Vendors List on the next page for details.

Recommended memory configurations

Mode		Sockets			
		DIMM_A1	DIMM_A2	DIMM_B1	DIMM_B2
Single-channel	(1)	-	-	Populated	-
Dual-channel*	(1)	Populated	-	Populated	-
	(2)	Populated	Populated	Populated	Populated

* Use only identical DDR DIMM pairs.

* For dual-channel configuration (2), you may:

- install identical DIMMs in all four sockets

OR

- install identical DIMM pair in DIMM_A1 and DIMM_B1 (blue sockets)

DDR (400 MHz) Qualified Vendors List

						DIMM support		
Size	Vendor	Chip No.	Brand	Side/s*	Part No.	A	B	C
256 MB	KINGSTON	V58C2256804SAT5(ECC)	-	SS	KVR400X72C3A/256	•	•	•
512 MB	KINGSTON	V58C2256804SAT5(ECC)	-	DS	KVR400X72C3A/512	•	•	•
512 MB	KINGSTON	Heat-Sink Package	-	DS	KHX3200A/512	•	•	•
256 MB	KINGSTON	D3208DL3T-5A	-	SS	KVR400X64C3A/256	•	•	•
256 MB	KINGSTON	A2S56D30BTP	-	SS	KVR400X64C3A/256	•	•	•
512 MB	KINGSTON	V58C2256804SAT5	-	DS	KVR400X64C3A/512	•	•	•
512 MB	KINGSTON	HY5DU12822BT-D43	-	SS	KVR400X64C3A/512	•	•	•
1024 MB	KINGSTON	HYB25D512800BE-5B	-	DS	KVR400X64C3A/1G	•	•	•
256 MB	SAMSUNG	K4H560838E-TCCC(ECC)	SAMSUNG	SS	M381L3223ETM-CCC	•	•	•
512 MB	SAMSUNG	K4H560838E-TCCC(ECC)	SAMSUNG	DS	M381L6423ETM-CCC	•	•	•
256 MB	SAMSUNG	K4H560838E-TCCC	SAMSUNG	SS	M368L3223ETM-CCC	•	•	
256 MB	SAMSUNG	K4H560838F-TCCC	SAMSUNG	SS	M368L3223FTN-CCC	•	•	
512 MB	SAMSUNG	K4H560838F-TCCC	SAMSUNG	DS	M368L6423FTN-CCC	•	•	•
512 MB	SAMSUNG	K4H510838B-TCCC	SAMSUNG	SS	M368L6523BTM-CCC	•	•	
256 MB	MICRON	MT46V32M8TG-5BC	MICRON	SS	MT8VDDT3264AG-40BCB	•	•	•
512 MB	MICRON	MT46V32M8TG-5BC	MICRON	DS	MT16VDDT6464AG-40BCB	•	•	•
256 MB	Infineon	HYB25D256800CE-5C	Infineon	SS	HYS64D32300HU-5-C	•	•	•
512 MB	Infineon	HYB25D256800CE-5C	Infineon	DS	HYS64D64320HU-5-C	•	•	•
256 MB	Infineon	HYB25D512160CE-5C	Infineon	SS	HYS64D32301HU-5-C	•	•	•
512 MB	Infineon	HYB25D512800CE-5C	Infineon	SS	HYS64D64300HU-5-C	•	•	•
1024 MB	Infineon	HYB25D512800CE-5B	Infineon	DS	HYS64D128320HU-5-C	•	•	•
256 MB	CORSAIR	W942508BH-5	-	SS	CMX256A-3200C2PT	•	•	•
512 MB	CORSAIR	Heat-Sink Package	-	DS	CMX512-3200C2	•	•	
512 MB	CORSAIR	VS32M8-5	-	DS	VS512MB400	•	•	•
512 MB	CORSAIR	Heat-Sink Package	-	DS	CMXP512-3200XL	•	•	
1024 MB	CORSAIR	Heat-Sink Package	-	DS	TWINX2048-3200C2	•	•	•
256 MB	Hynix	HY5DU56822DT-D43	-	SS	HYMD232646D8J-D43	•	•	•
512 MB	Hynix	HY5DU56822DT-D43	-	DS	HYMD264646D8J-D43	•	•	•

Legend:

- A** - supports one module inserted in DIMM_B1 slot in a Single-channel memory configuration.
- B** - Supports one pair of modules inserted into either the blue slots or the black slots as one pair of Dual-channel memory configuration.
- C** - Supports 4 modules inserted into both the blue and black slots as two pairs of Dual-channel memory configuration
- SS** - Single-sided
- DS** - Double-sided



Visit the ASUS website (www.asus.com) for the latest Qualified Vendors List.

2.4.3 Installing a DDR DIMM



Make sure to unplug the power supply before adding or removing DIMMs or other system components. Failure to do so may cause severe damage to both the motherboard and the components.

1. Unlock a DIMM socket by pressing the retaining clips outward.
2. Align a DIMM on the socket such that the notch on the DIMM matches the break on the socket.

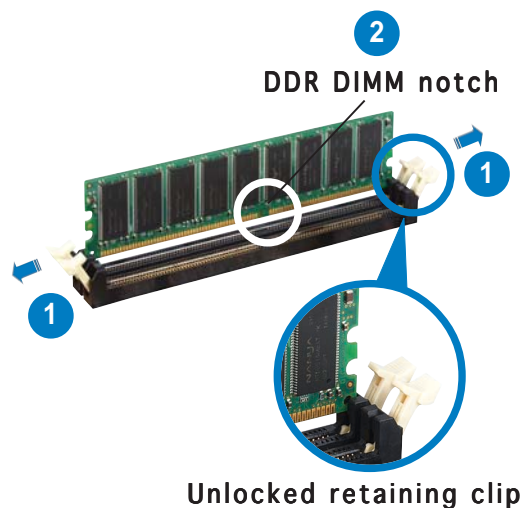

A DDR DIMM is keyed with a notch so that it fits in only one direction. DO NOT force a DIMM into a socket to avoid damaging the DIMM.

3. Firmly insert the DIMM into the socket until the retaining clips snap back in place and the DIMM is properly seated.

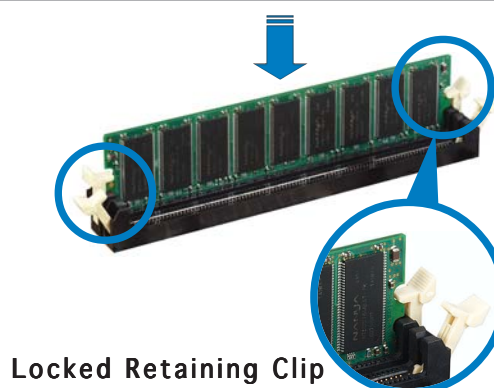

2.4.4 Removing a DDR DIMM

To remove a DIMM:

1. Simultaneously press the retaining clips outward to unlock the DIMM.

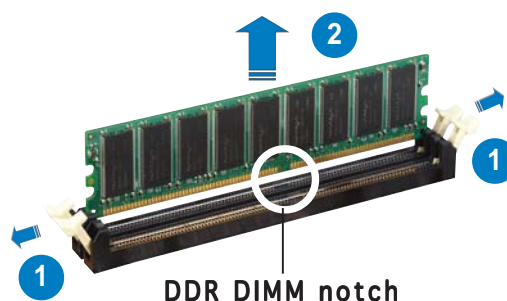

Support the DIMM lightly with your fingers when pressing the retaining clips. The DIMM might get damaged when it flips out with extra force.

2. Remove the DIMM from the socket.

2.5 Expansion slots

In the future, you may need to install expansion cards. The following sub-sections describe the slots and the expansion cards that they support.



Make sure to unplug the power cord before adding or removing expansion cards. Failure to do so may cause you physical injury and damage motherboard components.

2.5.1 Installing an expansion card

To install an expansion card:

1. Before installing the expansion card, read the documentation that came with it and make the necessary hardware settings for the card.
2. Remove the system unit cover (if your motherboard is already installed in a chassis).
3. Remove the bracket opposite the slot that you intend to use. Keep the screw for later use.
4. Align the card connector with the slot and press firmly until the card is completely seated on the slot.
5. Secure the card to the chassis with the screw you removed earlier.
6. Replace the system cover.

2.5.2 Configuring an expansion card

After installing the expansion card, configure it by adjusting the software settings.

1. Turn on the system and change the necessary BIOS settings, if any. See Chapter 4 for information on BIOS setup.
2. Assign an IRQ to the card. Refer to the tables on the next page.
3. Install the software drivers for the expansion card.

2.5.3 Interrupt assignments

Standard interrupt assignments

IRQ	Priority	Standard Function
0	1	System Timer
1	2	Keyboard Controller
2	—	Re-direct to IRQ #9
3	11	Reserved
4	12	Communications Port (COM1)*
5	13	IRQ holder for PCI steering*
6	14	Floppy Disk Controller
7	15	Printer Port (LPT1)*
8	3	System CMOS/Real Time Clock
9	4	IRQ holder for PCI steering*
10	5	IRQ holder for PCI steering*
11	6	IRQ holder for PCI steering*
12	7	PS/2 Compatible Mouse Port*
13	8	Numeric Data Processor
14	9	Primary IDE/SATA Channel
15	10	Secondary IDE/SATA Channel

* These IRQs are usually available for ISA or PCI devices.

IRQ assignments for this motherboard

	A	B	C	D	E	F	G	H
PCI slot 1	—	shared	shared	shared	shared	—	—	—
PCI slot 2	—	—	shared	shared	shared	shared	—	—
PCI slot 3	—	—	—	shared	shared	shared	shared	—
IEEE 1394	—	—	—	—	shared	—	—	—
LAN	—	—	—	—	—	shared	—	—
PCI-E x1	shared	shared	shared	shared	—	—	—	—
PCI-E x16_1	shared	shared	shared	shared	—	—	—	—
PCI-E x16_2	shared	shared	shared	shared	—	—	—	—
Onboard USB controller 1	shared	—	—	—	—	—	—	—
Onboard USB controller 2	—	shared	—	—	—	—	—	—
Onboard USB controller 3	—	—	shared	—	—	—	—	—
Onboard USB 2.0 controller	—	—	—	shared	—	—	—	—
HD audio	—	—	shared	—	—	—	—	—



When using PCI cards on shared slots, ensure that the drivers support “Share IRQ” or that the cards do not need IRQ assignment; otherwise, conflicts will arise between the two PCI groups, making the system unstable and the card inoperable.

2.5.4 PCI slots

The PCI slots support cards such as a LAN card, SCSI card, USB card, and other cards that comply with PCI specifications. The figure shows a LAN card installed on a PCI slot.

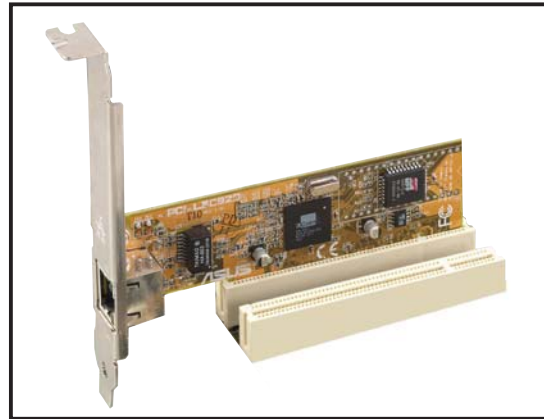

2.5.5 PCI Express x1 slot

This motherboard supports PCI Express x1 network cards, SCSI cards and other cards that comply with the PCI Express specifications. The following figure shows a network card installed on the PCI Express x1 slot.



2.5.6 Two PCI Express x16 slots

This motherboard supports two ATI CrossFire™ PCI Express x16 graphics cards that comply with the PCI Express specifications. The figure shows two graphics cards installed on the PCI Express x16 slots.

See Chapter 6 for details on the CrossFire™ technology feature.

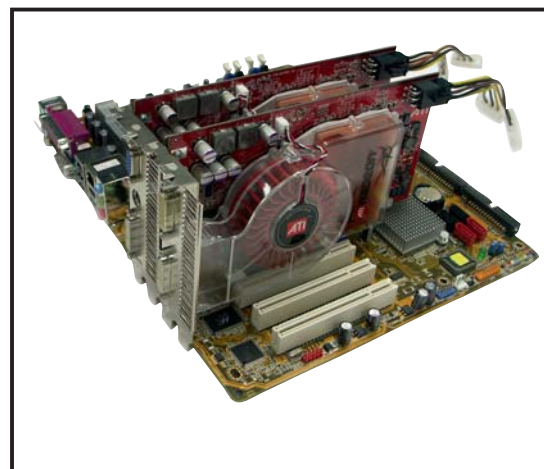



- We recommend that you install a VGA card on the primary (blue) PCI Express slot and install any other PCI Express device on the secondary (black) PCI Express slot.
- In CrossFire™ mode, each PCI Express x16 slot works at x8 bandwidth.
- **In CrossFire™ mode, install the ATI CrossFire™ Edition (Master) graphics card on the primary (blue) PCI Express slot; otherwise, the system will not boot.**
- Refer to the table below for possible PCI Express Card configurations.

PCI Express x16 slot configurations

	PCIEX16_1 (blue) slot		PCIEX16_2 (black) slot	
	Card Type	Speed	Card Type	Speed
Single graphics card*	PCIe x16 graphics card	x16	MVP Switch Card	NA
	PCIe x16 graphics card	x8	PCIe devices (non-VGA)	x8, x4, x1
Dual graphics cards in CrossFire™ mode**	ATI CrossFire Edition graphics card	x8	ATI graphics card	x8



- * Install the MVP Switch Card on the black PCI Express slot. Remove it only when you want to install other devices.
- ** Install two ATI graphics cards from the same GPU family.

2.6 Jumper

Clear RTC RAM (CLRRTC)

This jumper allows you to clear the Real Time Clock (RTC) RAM in CMOS. You can clear the CMOS memory of date, time, and system setup parameters by erasing the CMOS RTC RAM data. The onboard button cell battery powers the RAM data in CMOS, which include system setup information such as system passwords.

To erase the RTC RAM:

1. Turn OFF the computer and unplug the power cord.
2. Remove the onboard battery.
3. Move the jumper cap from pins 1-2 (default) to pins 2-3. Keep the cap on pins 2-3 for about 5~10 seconds, then move the cap back to pins 1-2.
4. Reinstall the battery.
5. Plug the power cord and turn ON the computer.
6. Hold down the key during the boot process and enter BIOS setup to re-enter data.



Except when clearing the RTC RAM, never remove the cap on CLRRTC jumper default position. Removing the cap will cause system boot failure!

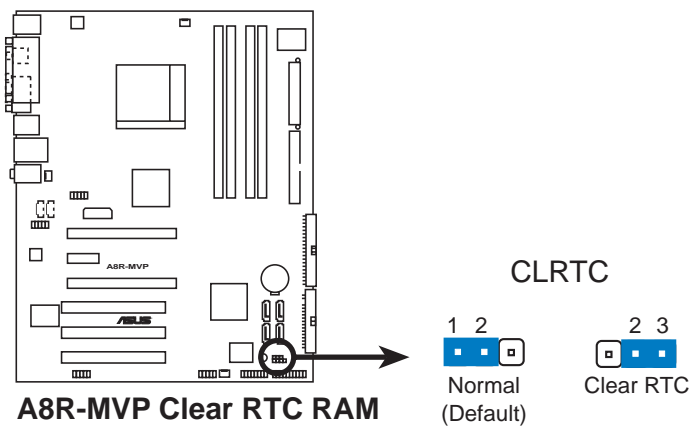

You do not need to clear the RTC when the system hangs due to overclocking. For system failure due to overclocking, use the C.P.R. (CPU Parameter Recall) feature. Shut down and reboot the system so the BIOS can automatically reset parameter settings to default values.

2.7 Connectors

2.7.1 Rear panel connectors

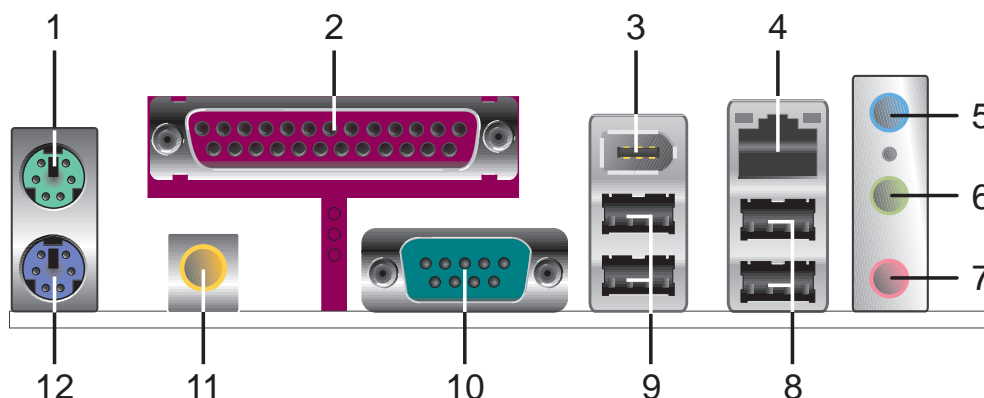

1. **PS/2 mouse port (green).** This port is for a PS/2 mouse.
2. **Parallel port.** This 25-pin port connects a parallel printer, a scanner, or other devices.
3. **IEEE 1394a port.** This 6-pin IEEE 1394a port provides high-speed connectivity for audio/video devices, storage peripherals, PCs, or portable devices.
4. **LAN (RJ-45) port.** This port allows Gigabit connection to a Local Area Network (LAN) through a network hub. Refer to the table below for the LAN port LED indications.

LAN port LED indications

ACT/LINK LED		SPEED LED	
Status	Description	Status	Description
OFF	No link	OFF	10Mbps connection
GREEN	Linked	ORANGE	100Mbps connection
BLINKING	Acting	GREEN	1Gbps connection

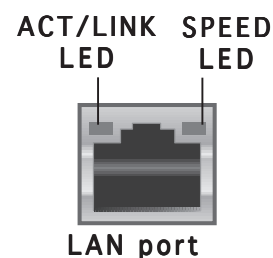

5. **Line In port (light blue).** This port connects a tape, CD, DVD player, or other audio sources.
6. **Line Out port (lime).** This port connects a headphone or a speaker. In 4/6-channel configuration, the function of this port becomes Front Speaker Out.
7. **Microphone port (pink).** This port connects a microphone.



Refer to the audio configuration table on the next page for the function of the audio ports in 2, 4, or 6-channel configuration.

Audio 2, 4, or 6-channel configuration

Port	Headset 2-speaker	4-speaker	6-speaker
Light Blue	Line In	Surround Out	Surround Out
Lime	Line Out	Front Speaker Out	Front Speaker Out
Pink	Mic In	Mic	Center/Bass

8. **USB 2.0 ports 3 and 4.** These two 4-pin Universal Serial Bus (USB) ports are available for connecting USB 2.0 devices.
9. **USB 2.0 ports 1 and 2.** These two 4-pin Universal Serial Bus (USB) ports are available for connecting USB 2.0 devices.
10. **Serial port.** This 9-pin COM1 port is for pointing devices or other serial devices.
11. **Coaxial S/PDIF Out port.** This port connects an external audio output device via a coaxial S/PDIF cable.
12. **PS/2 keyboard port (purple).** This port is for a PS/2 keyboard.

2.7.2 Internal connectors

1. Floppy disk drive connector (34-1 pin FLOPPY)

This connector is for the provided floppy disk drive (FDD) signal cable. Insert one end of the cable to this connector, then connect the other end to the signal connector at the back of the floppy disk drive.



Pin 5 on the connector is removed to prevent incorrect cable connection when using an FDD cable with a covered Pin 5.

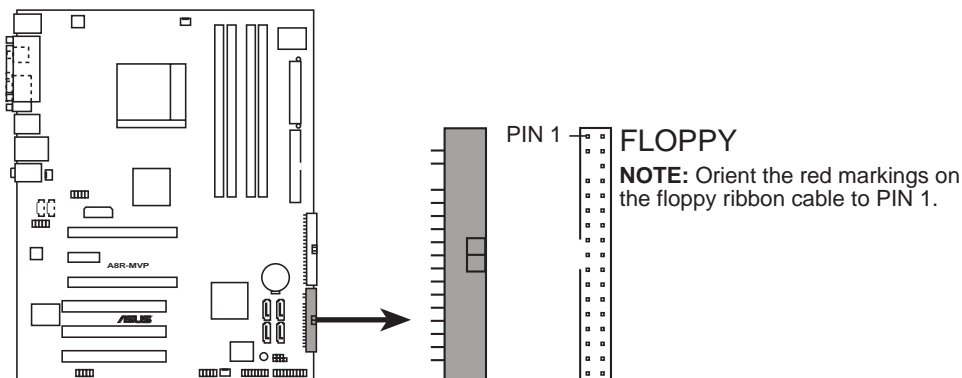

A8R-MVP Floppy disk drive connector

2. IDE connectors (40-1 pin PRI_IDE, 40-1 pin SEC_IDE)

This connector is for an Ultra DMA 133/100/66 signal cable. The Ultra DMA 133/100/66 signal cable has three connectors: a blue connector for the primary IDE connector on the motherboard, a black connector for an Ultra DMA 133/100/66 IDE slave device (optical drive/hard disk drive), and a gray connector for an Ultra DMA 133/100/66 IDE master device (hard disk drive). If you install two hard disk drives, you must configure the second drive as a slave device by setting its jumper accordingly. Refer to the hard disk documentation for the jumper settings.



-
- Pin 20 on the IDE connector is removed to match the covered hole on the Ultra DMA cable connector. This prevents incorrect insertion when you connect the IDE cable.
 - Use the 80-conductor IDE cable for Ultra DMA 133/100/66 IDE devices.
-

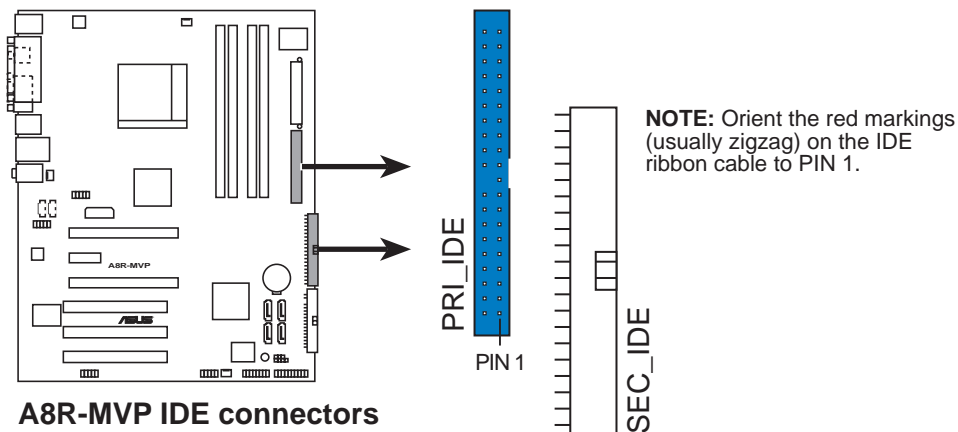

3. Serial ATA connectors (7-pin SATA1 [red], SATA2 [red], SATA3 [black], SATA4 [black])

These connectors are for the Serial ATA signal cables for Serial ATA hard disk drives.

If you installed Serial ATA hard disk drives, you can create a RAID 0, RAID 1, RAID 0+1, RAID 5, and JBOD configuration. Refer to Chapter 5 for information on creating a RAID configuration.



Enable the **Serial ATA Controller** and **Onboard SATA Boot ROM** items in the BIOS if you want to use the Serial ATA RAID feature. See section “4.3.5 Storage Configuration” for details.

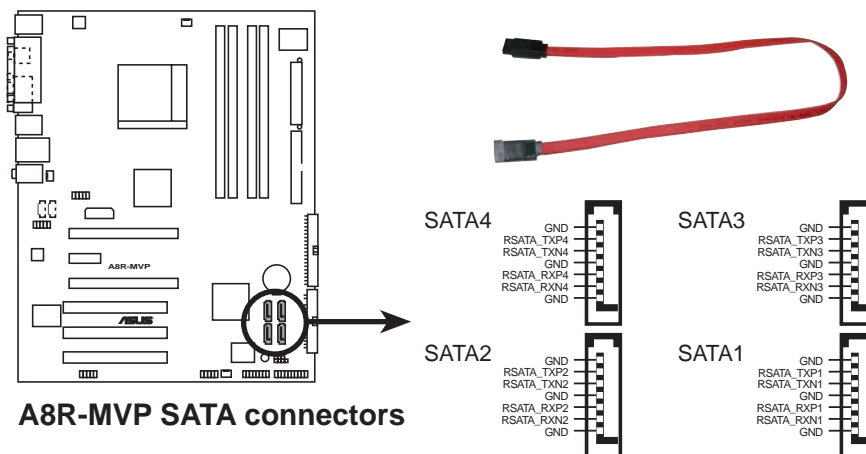

- Plug your Serial ATA boot disk on the master port (SATA1/2 to support S3 function).
- Install the Windows® 2000 Service Pack 4 or the Windows® XP Service Pack1 or later when using Serial ATA.

Serial ATA hard disk drive connection

Connector	Color	Setting	Use
SATA1/SATA2	Red	Master	Boot disk
SATA3/SATA4	Black	Slave	Data Disk

4. CPU, Chassis, and Power fan connectors (3-pin CPU_FAN, 3-pin CHA_FAN, 3-pin PWR_FAN)

The fan connectors support cooling fans of 350 mA ~ 2000 mA (24 W max.) or a total of 1 A ~ 3.48 A (41.76 W max.) at +12 V. Connect the fan cables to the fan connectors on the motherboard, making sure that the black wire of each cable matches the ground pin of the connector.



Do not forget to connect the fan cables to the fan connectors. Insufficient air flow inside the system may damage the motherboard components. These are not jumpers! DO NOT place jumper caps on the fan connectors.

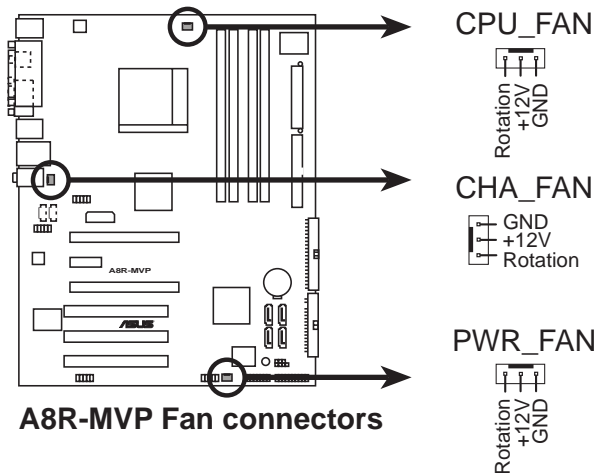

Only the CPU_FAN and CHA_FAN connectors support the ASUS Q-Fan 2 feature.



For some chassis models with short 3-pin chassis fan cable, connect the cable to the PWR_FAN connector.

5. USB connectors (10-1 pin USB56, USB78_WFG)

These connectors are for USB 2.0 ports. Connect the USB/GAME module cable to any of these connectors, then install the module to a slot opening at the back of the system chassis. These USB connectors comply with USB 2.0 specification that supports up to 480 Mbps connection speed.

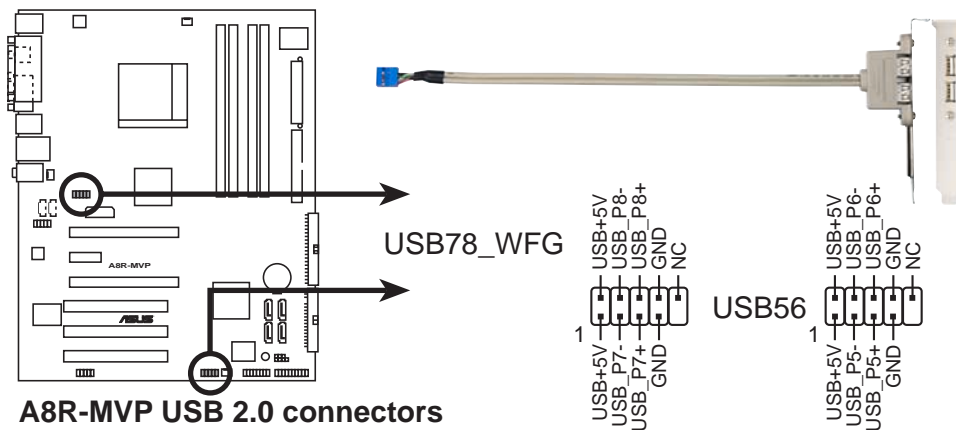

Never connect a **1394 cable** to the USB connectors. Doing so will damage the motherboard!

6. Power connectors (24-pin EATXPWR, 4-pin ATX12V, 4-pin EZ_PLUG)

These connectors are for an ATX power supply. The plugs from the power supply are designed to fit these connectors in only one orientation. Find the proper orientation and push down firmly until the connectors completely fit.

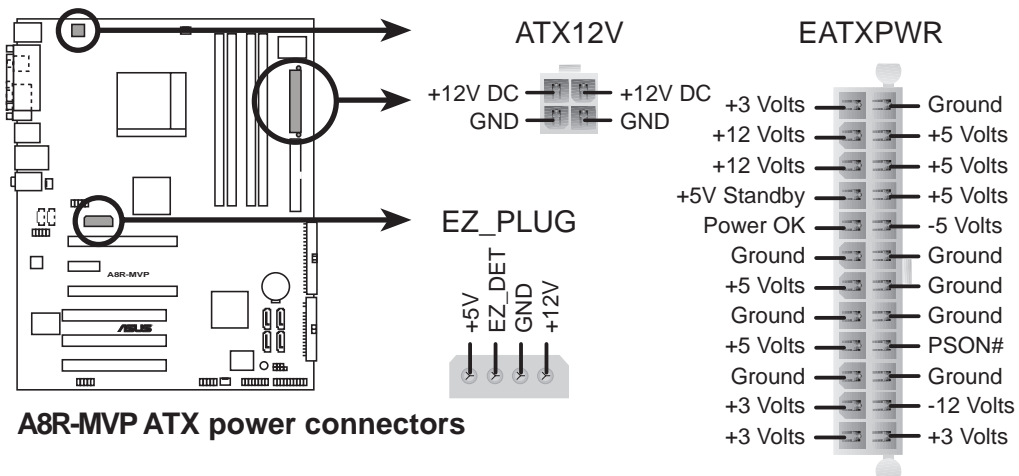



- For a fully-configured system, we recommend that you use a power supply unit (PSU) that complies with ATX 12 V Specification 2.0 (or later version) and provides a minimum power of 400 W.
- Do not forget to connect the 4-pin ATX +12 V power plug; otherwise, the system will not boot up.
- Make sure to connect the EZ Plug™ when using two PCI Express graphics card and a 20-pin ATX power supply unit; otherwise, the system will be unstable.
- The ATX 12 V Specification 2.0 compliant (400 W) PSU has been tested to support the below configuration:

CPU:	AMD FX-57
Memory:	512 MB DDR (x4)
Graphics card:	PCI Express x16 ATI X850
Hard disk:	SATA HD (x2)
ATAPI:	CD-ROM (x1)

- Use of a PSU with a higher power output is recommended when configuring a system with more power-consuming devices. The system may become unstable or may not boot up if the power is inadequate.
- If you want to use the ATI CrossFire™ Graphics solution, use a PSU with 500 ~ 600 W power to ensure system stability.

7. GAME/MIDI port connector (16-1 pin GAME)

This connector is for a GAME/MIDI port. Connect the USB/GAME module cable to this connector, then install the module to a slot opening at the back of the system chassis. The GAME/MIDI port connects a joystick or game pad for playing games, and MIDI devices for playing or editing audio files.

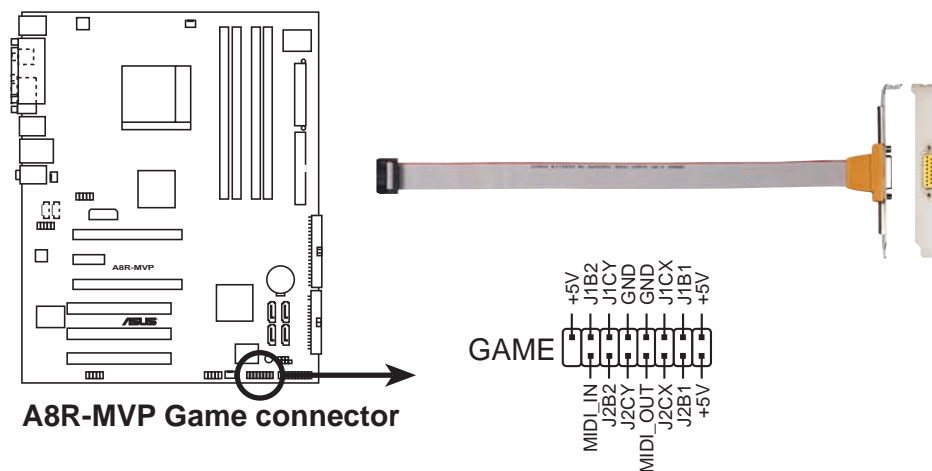

8. IEEE 1394a connector (10-1 pin IE1394_1)

This connector is for an IEEE 1394a port. Connect the IEEE 1394a module cable to this connector, then install the module to a slot opening at the back of the system chassis.

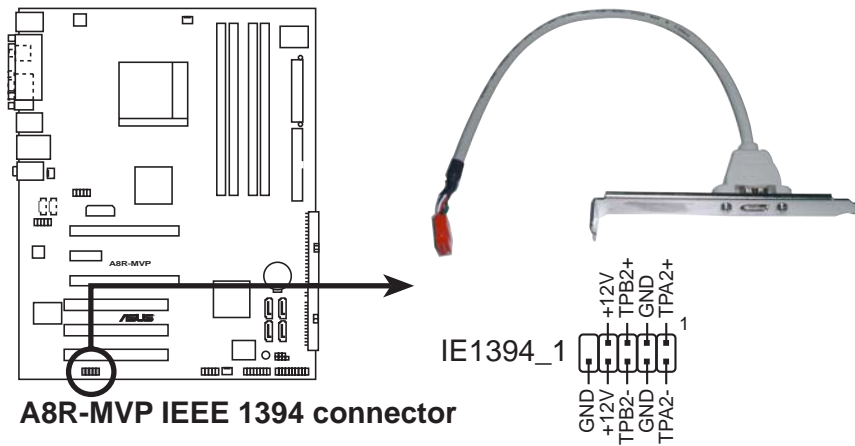

NEVER connect a **USB cable** to the IEEE 1394a connector. Doing so will damage the motherboard!

9. Chassis intrusion connector (4-1 pin CHASSIS)

This connector is for a chassis-mounted intrusion detection sensor or switch. Connect one end of the chassis intrusion sensor or switch cable to this connector. The chassis intrusion sensor or switch sends a high-level signal to this connector when a chassis component is removed or replaced. The signal is then generated as a chassis intrusion event.

By default, the pins labeled “Chassis Signal” and “Ground” are shorted with a jumper cap. Remove the jumper caps only when you intend to use the chassis intrusion detection feature.

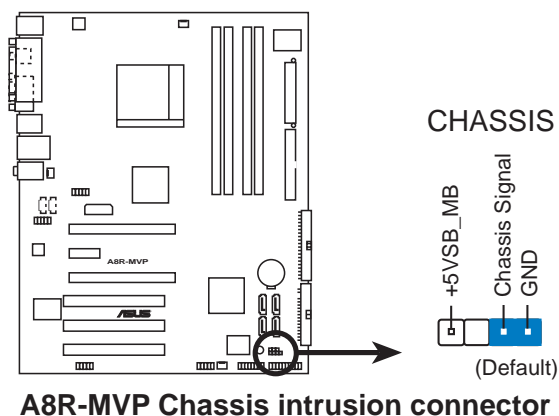

10. Front panel audio connector (10-1 pin AAFP)

This connector is for a chassis-mounted front panel audio I/O module that supports either HD Audio or legacy AC '97 audio standard. Connect one end of the front panel audio I/O module cable to this connector.

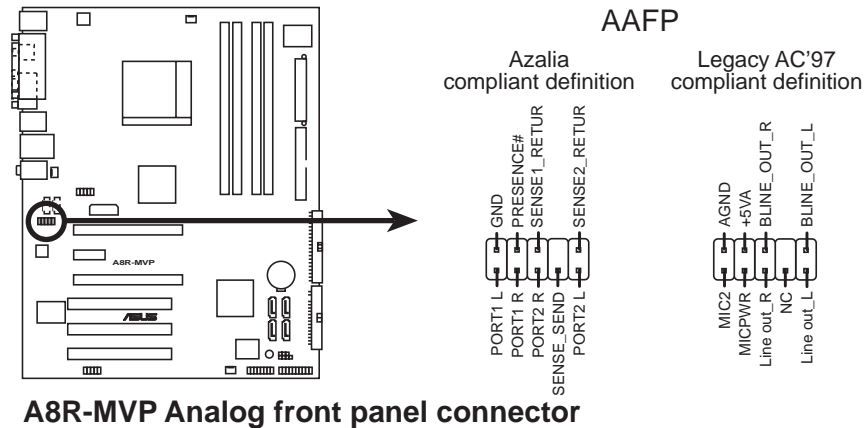

A8R-MVP Analog front panel connector



- We recommend that you connect a high-definition front panel audio module to this connector to avail of the motherboard's high-definition audio capability.
- Make sure the HD Audio item in the BIOS is set to [Enabled] to avail of the motherboard's high-definition audio capability. See section "4.4.4 Onboard Devices Configuration" for details.

11. Internal audio connectors (4-pin CD [black], 4-pin AUX [white])

These connectors allow you to receive stereo audio input from sound sources such as a CD-ROM, TV tuner, or MPEG card.

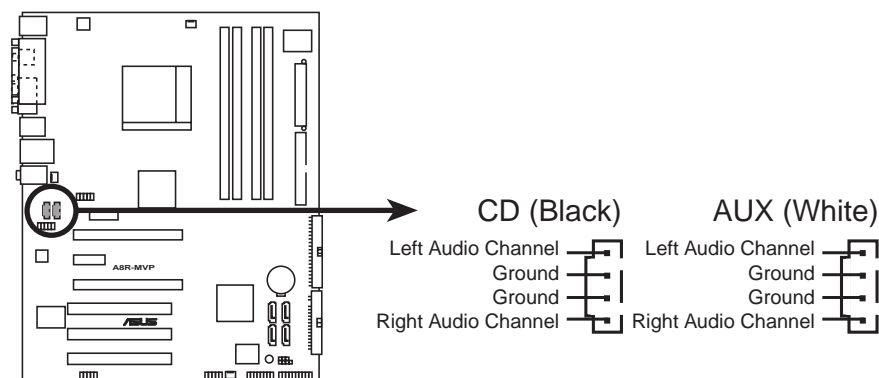

A8R-MVP Internal audio connectors

12. System panel connector (20-pin PANEL)

This connector supports several chassis-mounted functions.

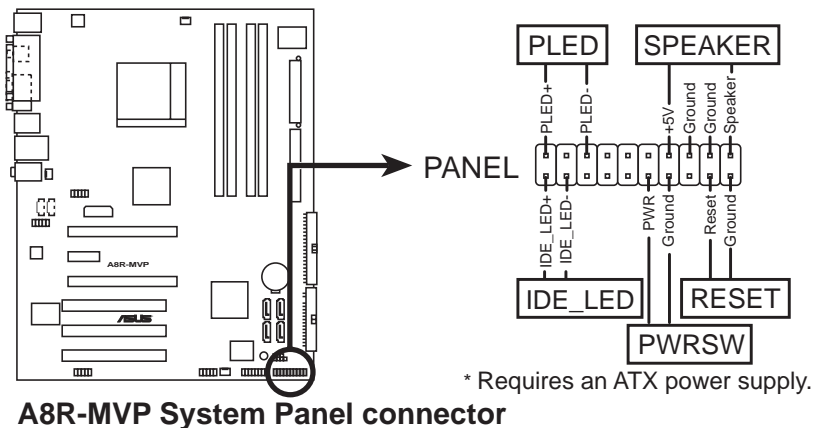

The system panel connector is color-coded for easy connection. Refer to the connector description below for details.

- **System power LED (Green 3-pin PLED)**
This 3-pin connector is for the system power LED. Connect the chassis power LED cable to this connector. The system power LED lights up when you turn on the system power, and blinks when the system is in sleep mode.
- **Hard disk drive activity (Red 2-pin IDE_LED)**
This 2-pin connector is for the HDD Activity LED. Connect the HDD Activity LED cable to this connector. The IDE LED lights up or flashes when data is read from or written to the HDD.
- **System warning speaker (Orange 4-pin SPEAKER)**
This 4-pin connector is for the chassis-mounted system warning speaker. The speaker allows you to hear system beeps and warnings.
- **Power/Soft-off button (Yellow 2-pin PWRSW)**
This connector is for the system power button. Pressing the power button turns the system ON or puts the system in SLEEP or SOFT-OFF mode depending on the BIOS settings. Pressing the power switch for more than four seconds while the system is ON turns the system OFF.
- **Reset button (Blue 2-pin RESET)**
This 2-pin connector is for the chassis-mounted reset button for system reboot without turning off the system power.

This chapter describes the power up sequence, the vocal POST messages, and ways of shutting down the system.

Powering up

Chapter summary



3.1	Starting up for the first time	3-1
3.2	Powering off the computer	3-2

3.1 Starting up for the first time

1. After making all the connections, replace the system case cover.
2. Be sure that all switches are off.
3. Connect the power cord to the power connector at the back of the system chassis.
4. Connect the power cord to a power outlet that is equipped with a surge protector.
5. Turn on the devices in the following order:
 - a. Monitor
 - b. External SCSI devices (starting with the last device on the chain)
 - c. System power
6. After applying power, the system power LED on the system front panel case lights up. For systems with ATX power supplies, the system LED lights up when you press the ATX power button. If your monitor complies with “green” standards or if it has a “power standby” feature, the monitor LED may light up or switch between orange and green after the system LED turns on.

The system then runs the power-on self tests or POST. While the tests are running, the BIOS beeps (see BIOS beep codes table below) or additional messages appear on the screen. If you do not see anything within 30 seconds from the time you turned on the power, the system may have failed a power-on test. Check the jumper settings and connections or call your retailer for assistance.

AMI BIOS beep codes

Beep Description	Error
One beep	Keyboard controller error Refresh Time error No master drive detected
Two continuous beeps followed by two short beeps	Floppy controller failure
Two continuous beeps followed by four short beeps	Hardware component failure

7. At power on, hold down the <Delete> key to enter the BIOS Setup. Follow the instructions in Chapter 4.

3.2 Powering off the computer

3.2.1 Using the OS shut down function

If you are using Windows® 2000:

1. Click the **Start** button then click **Shut Down...**
2. Make sure that the **Shut Down** option button is selected, then click the **OK** button to shut down the computer.
3. The power supply should turn off after Windows® shuts down.

If you are using Windows® XP:

1. Click the **Start** button then select **Turn Off Computer.**
2. Click the **Turn Off** button to shut down the computer.
3. The power supply should turn off after Windows® shuts down.

3.2.2 Using the dual function power switch

While the system is ON, pressing the power switch for less than four seconds puts the system to sleep mode or to soft-off mode, depending on the BIOS setting. Pressing the power switch for more than four seconds lets the system enter the soft-off mode regardless of the BIOS setting. Refer to section “4.5 Power Menu” in Chapter 4 for details.

This chapter tells how to change the system settings through the BIOS Setup menus. Detailed descriptions of the BIOS parameters are also provided.

BIOS setup



4.1	Managing and updating your BIOS	4-1
4.2	BIOS setup program	4-11
4.3	Main menu	4-14
4.4	Advanced menu	4-18
4.5	Power menu	4-32
4.6	Boot menu	4-37
4.7	Exit menu	4-42

4.1 Managing and updating your BIOS

The following utilities allow you to manage and update the motherboard Basic Input/Output System (BIOS) setup.

1. **ASUS Update** (Updates the BIOS in Windows® environment.)
2. **ASUS EZ Flash** (Updates the BIOS using a floppy disk during POST.)
3. **ASUS AFUDOS** (Updates the BIOS in DOS mode using a bootable floppy disk.)
4. **ASUS CrashFree BIOS 2** (Updates the BIOS using a bootable floppy disk or the motherboard support CD when the BIOS file fails or gets corrupted.)

Refer to the corresponding sections for details on these utilities.



Save a copy of the original motherboard BIOS file to a bootable floppy disk in case you need to restore the BIOS in the future. Copy the original motherboard BIOS using the ASUS Update or AFUDOS utilities.

4.1.1 ASUS Update utility

The ASUS Update is a utility that allows you to manage, save, and update the motherboard BIOS in Windows® environment. The ASUS Update utility allows you to:

- Save the current BIOS file
- Download the latest BIOS file from the Internet
- Update the BIOS from an updated BIOS file
- Update the BIOS directly from the Internet, and
- View the BIOS version information.

This utility is available in the support CD that comes with the motherboard package.



ASUS Update requires an Internet connection either through a network or an Internet Service Provider (ISP).

Installing ASUS Update

To install ASUS Update:

1. Place the support CD in the optical drive. The **Drivers** menu appears.
2. Click the **Utilities** tab, then click **Install ASUS Update VX.XX.XX**. See page 5-3 for the **Utilities** screen menu.
3. The ASUS Update utility is copied to your system.



Quit all Windows® applications before you update the BIOS using this utility.

Updating the BIOS through the Internet

To update the BIOS through the Internet:

1. Launch the ASUS Update utility from the Windows® desktop by clicking **Start > Programs > ASUS > ASUSUpdate > ASUSUpdate**. The ASUS Update main window appears.

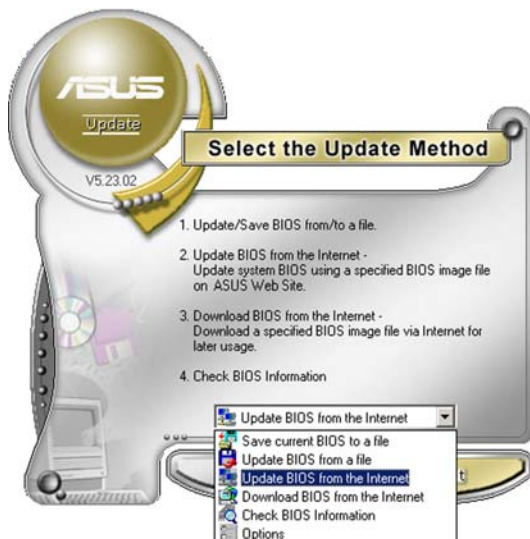
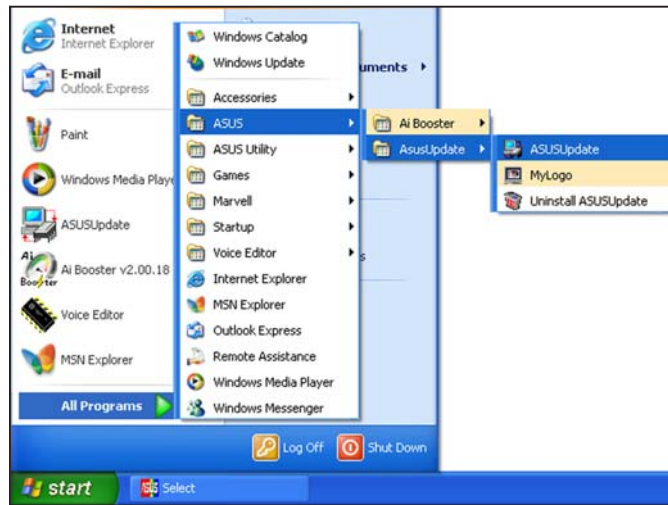

2. Select **Update BIOS from the Internet** option from the drop-down menu, then click **Next**.



3. Select the ASUS FTP site nearest you to avoid network traffic, or click **Auto Select**. Click **Next**.

- From the FTP site, select the BIOS version that you wish to download. Click Next.
- Follow the screen instructions to complete the update process.



The ASUS Update utility is capable of updating itself through the Internet. Always update the utility to avail all its features.



Updating the BIOS through a BIOS file

To update the BIOS through a BIOS file:

- Launch the ASUS Update utility from the Windows® desktop by clicking **Start > Programs > ASUS > ASUSUpdate > ASUSUpdate**. The ASUS Update main window appears.
- Select **Update BIOS from a file** option from the drop-down menu, then click **Next**.

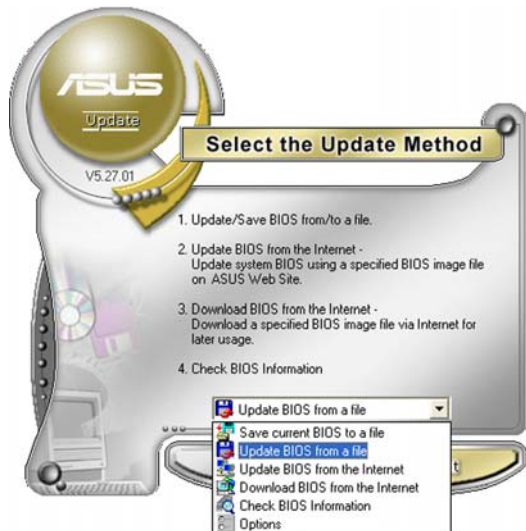

- Locate the BIOS file from the **Open** window, then click **Save**.
- Follow the screen instructions to complete the update process.

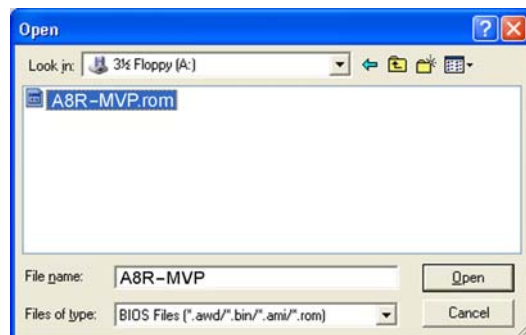

4.1.2 Creating a bootable floppy disk

1. Do either one of the following to create a bootable floppy disk.

DOS environment

- a. Insert a 1.44MB floppy disk into the drive.
- b. At the DOS prompt, type `format a: /s` then press <Enter>.

Windows® XP environment

- a. Insert a 1.44 MB floppy disk to the floppy disk drive.
- b. Click **Start** from the Windows® desktop, then select **My Computer**.
- c. Select the 3 1/2 Floppy Drive icon.
- d. Click **File** from the menu, then select **Format. A Format 3 1/2 Floppy Disk** window appears.
- e. Select **Create an MS-DOS startup disk** from the format options field, then click **Start**.

Windows® 2000 environment

To create a set of boot disks for Windows® 2000:

- a. Insert a formatted, high density 1.44 MB floppy disk into the drive.
 - b. Insert the Windows® 2000 CD to the optical drive.
 - c. Click **Start**, then select **Run**.
 - d. From the Open field, type
`D:\bootdisk\makeboot a:`
assuming that D: is your optical drive.
 - e. Press <Enter>, then follow screen instructions to continue.
2. Copy the original or the latest motherboard BIOS file to the bootable floppy disk.

4.1.3 ASUS EZ Flash utility

The ASUS EZ Flash feature allows you to update the BIOS without having to go through the long process of booting from a floppy disk and using a DOS-based utility. The EZ Flash utility is built-in the BIOS chip so it is accessible by pressing <Alt> + <F2> during the Power-On Self Tests (POST).

To update the BIOS using EZ Flash:

1. Visit the ASUS website (www.asus.com) to download the latest BIOS file for the motherboard and rename the same to **A8R-MVP.ROM**.
2. Save the BIOS file to a floppy disk, then restart the system.
3. Press <Alt> + <F2> during POST to display the following.

```
EZFlash starting BIOS update
Checking for floppy...
```

4. Insert the floppy disk that contains the BIOS file to the floppy disk drive. When the correct BIOS file is found, EZ Flash performs the BIOS update process and automatically reboots the system when done.

```
EZFlash starting BIOS update
Checking for floppy...
Floppy found!
Reading file "A8R-MVP.ROM". Completed.
Start erasing.....|
Start programming...|
Flashed successfully. Rebooting.
```



- Do not shut down or reset the system while updating the BIOS to prevent system boot failure!
- A “Floppy not found!” error message appears if there is no floppy disk in the drive. A “A8R-MVP.ROM not found!” error message appears if the correct BIOS file is not found in the floppy disk. Make sure that you rename the BIOS file to A8R-MVP.ROM.

4.1.4 AFUDOS utility

The AFUDOS utility allows you to update the BIOS file in DOS environment using a bootable floppy disk with the updated BIOS file. This utility also allows you to copy the current BIOS file that you can use as backup when the BIOS fails or gets corrupted during the updating process.

Copying the current BIOS

To copy the current BIOS file using the AFUDOS utility:



- Make sure that the floppy disk is not write-protected and has at least 600 KB free space to save the file.
- The succeeding BIOS screens are for reference only. The actual BIOS screen displays may not be exactly the same as shown.

1. Copy the AFUDOS utility (afudos.exe) from the motherboard support CD to the bootable floppy disk you created earlier.
2. Boot the system in DOS mode, then at the prompt type:

```
afudos /o[filename]
```

where the [filename] is any user-assigned filename not more than eight alphanumeric characters for the main filename and three alphanumeric characters for the extension name.

```
A:\>afudos /oOLDBIOS1.ROM
```

Main filename Extension name

3. Press <Enter>. The utility copies the current BIOS file to the floppy disk.

```
A:\>afudos /oOLDBIOS1.ROM
AMI Firmware Update Utility - Version 1.10
Copyright (C) 2002 American Megatrends, Inc. All rights reserved.
Reading flash ..... done
A:\>
```

The utility returns to the DOS prompt after copying the current BIOS file.

Updating the BIOS file

To update the BIOS file using the AFUDOS utility:

1. Visit the ASUS website (www.asus.com) and download the latest BIOS file for the motherboard. Save the BIOS file to a bootable floppy disk.



Write the BIOS filename on a piece of paper. You need to type the exact BIOS filename at the DOS prompt.

2. Copy the AFUDOS utility (afudos.exe) from the motherboard support CD to the bootable floppy disk you created earlier.
3. Boot the system in DOS mode, then at the prompt type:

```
afudos /i[filename]
```

where [filename] is the latest or the original BIOS file on the bootable floppy disk.

```
A:\>afudos /iA8R-MVP.ROM
```

4. The utility verifies the file and starts updating the BIOS.

```
A:\>afudos /iA8R-MVP.ROM
AMI Firmware Update Utility - Version 1.19 (ASUS V2.07 (03.11.24BB))
Copyright (C) 2003 American Megatrends, Inc. All rights reserved.

WARNING!! Do not turn off power during flash BIOS
Reading file ..... done
Reading flash .... done

Advance Check.....
Erasing flash .... done
Writing flash .... 0x0008CC00 (9%)
```



Do not shut down or reset the system while updating the BIOS to prevent system boot failure!

5. The utility returns to the DOS prompt after the BIOS update process is completed. Reboot the system from the hard disk drive.

```
A:\>afudos /iA8R-MVP.ROM
AMI Firmware Update Utility - Version 1.19(ASUS V2.07(03.11.24BB))
Copyright (C) 2003 American Megatrends, Inc. All rights reserved.

WARNING!! Do not turn off power during flash BIOS
Reading file ..... done
Reading flash .... done
Search bootblock version
Advance Check.....
Erasing flash ..... done
Writing flash ..... done
Verifying flash ... done

Please restart your computer

A:\>
```

4.1.5 ASUS CrashFree BIOS 2 utility

The ASUS CrashFree BIOS 2 is an auto recovery tool that allows you to restore the BIOS file when it fails or gets corrupted during the updating process. You can update a corrupted BIOS file using the motherboard support CD or the floppy disk that contains the updated BIOS file.



- Prepare the motherboard support CD or the floppy disk containing the updated motherboard BIOS before using this utility.
- Make sure that you rename the original or updated BIOS file in the floppy disk to **A8R-MVP.ROM**.

Recovering the BIOS from a floppy disk

To recover the BIOS from a floppy disk:

1. Turn on the system.
2. Insert the floppy disk with the original or updated BIOS file to the floppy disk drive.
3. The utility displays the following message and automatically checks the floppy disk for the original or updated BIOS file.

```
Bad BIOS checksum. Starting BIOS recovery...
Checking for floppy...
```

When found, the utility reads the BIOS file and starts flashing the corrupted BIOS file.

```
Bad BIOS checksum. Starting BIOS recovery...
Checking for floppy...
Floppy found!
Reading file "A8R-MVP.ROM". Completed.
Start flashing...
```



DO NOT shut down or reset the system while updating the BIOS! Doing so can cause system boot failure!

4. Restart the system after the utility completes the updating process.

Recovering the BIOS from the support CD

To recover the BIOS from the support CD:

1. Remove any floppy disk from the floppy disk drive, then turn on the system.
2. Insert the support CD to the optical drive.
3. The utility displays the following message and automatically checks the floppy disk for the original or updated BIOS file.

```
Bad BIOS checksum. Starting BIOS recovery...
Checking for floppy...
```

When no floppy disk is found, the utility automatically checks the optical drive for the original or updated BIOS file. The utility then updates the corrupted BIOS file.

```
Bad BIOS checksum. Starting BIOS recovery...
Checking for floppy...
Floppy not found!
Checking for CD-ROM...
CD-ROM found!
Reading file "A8R-MVP.ROM". Completed.
Start flashing...
```



DO NOT shut down or reset the system while updating the BIOS! Doing so can cause system boot failure!

4. Restart the system after the utility completes the updating process.



The recovered BIOS may not be the latest BIOS version for this motherboard. Visit the ASUS website (www.asus.com) to download the latest BIOS file.

4.2 BIOS setup program

This motherboard supports a programmable firmware chip that you can update using the provided utility described in section “4.1 Managing and updating your BIOS.”

Use the BIOS Setup program when you are installing a motherboard, reconfiguring your system, or prompted to “Run Setup.” This section explains how to configure your system using this utility.

Even if you are not prompted to use the Setup program, you can change the configuration of your computer in the future. For example, you can enable the security password feature or change the power management settings. This requires you to reconfigure your system using the BIOS Setup program so that the computer can recognize these changes and record them in the CMOS RAM or the firmware hub.

The firmware hub on the motherboard stores the Setup utility. When you start up the computer, the system provides you with the opportunity to run this program. Press during the Power-On-Self-Test (POST) to enter the Setup utility; otherwise, POST continues with its test routines.

If you wish to enter Setup after POST, restart the system by pressing <Ctrl+Alt+Delete>, or by pressing the reset button on the system chassis. You can also restart by turning the system off and then back on. Do this last option only if the first two failed.

The Setup program is designed to make it as easy to use as possible. Being a menu-driven program, it lets you scroll through the various sub-menus and make your selections from the available options using the navigation keys.



-
- The default BIOS settings for this motherboard apply for most conditions to ensure optimum performance. If the system becomes unstable after changing any BIOS settings, load the default settings to ensure system compatibility and stability. Select the **Load Default Settings** item under the Exit Menu. See section “4.7 Exit Menu.”
 - The BIOS setup screens shown in this section are for reference purposes only, and may not exactly match what you see on your screen.
 - Visit the ASUS website (www.asus.com) to download the latest BIOS file for this motherboard.
-

4.2.1 BIOS menu screen

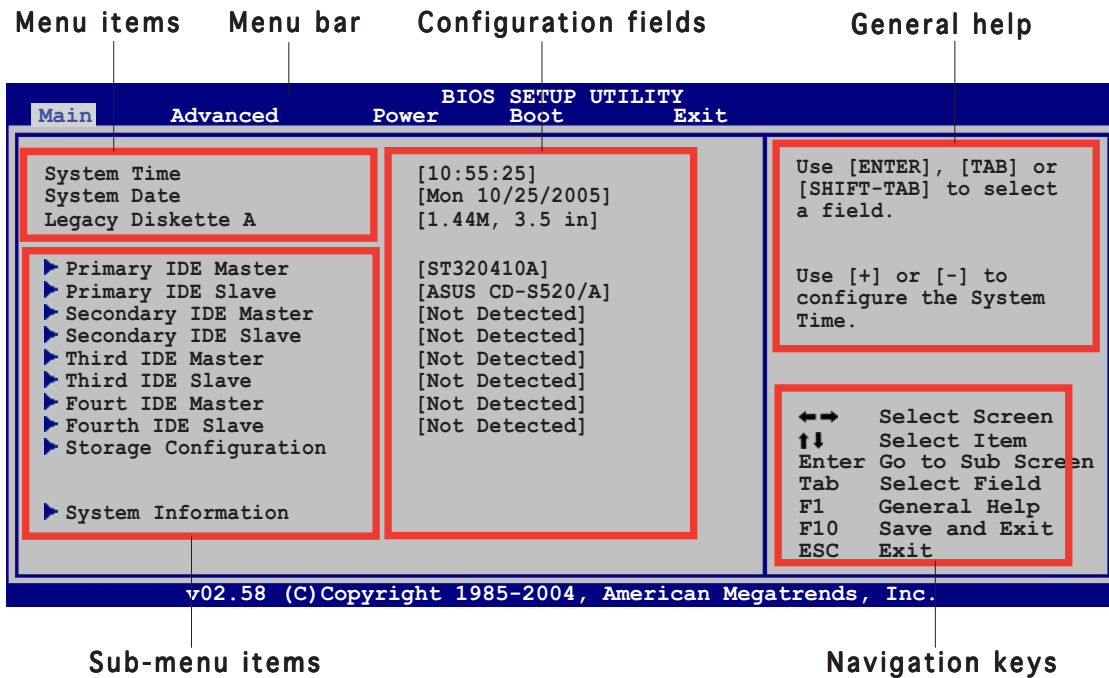

4.2.2 Menu bar

The menu bar on top of the screen has the following main items:

- Main** For changing the basic system configuration
- Advanced** For changing the advanced system settings
- Power** For changing the advanced power management (APM) configuration
- Boot** For changing the system boot configuration
- Exit** For selecting the exit options and loading default settings

To select an item on the menu bar, press the right or left arrow key on the keyboard until the desired item is highlighted.

4.2.3 Navigation keys

At the bottom right corner of a menu screen are the navigation keys for that particular menu. Use the navigation keys to select items in the menu and change the settings.



Some of the navigation keys differ from one screen to another.

4.2.4 Menu items

The highlighted item on the menu bar displays the specific items for that menu. For example, selecting **Main** shows the Main menu items.

The other items (Advanced, Power, Boot, and Exit) on the menu bar have their respective menu items.

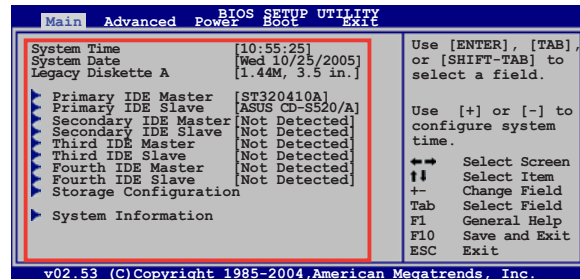

Main menu items

4.2.5 Sub-menu items

A solid triangle before each item on any menu screen means that the item has a sub-menu. To display the sub-menu, select the item and press <Enter>.

4.2.6 Configuration fields

These fields show the values for the menu items. If an item is user-configurable, you can change the value of the field opposite the item. You cannot select an item that is not user-configurable.

A configurable field is enclosed in brackets, and is highlighted when selected. To change the value of a field, select it then press <Enter> to display a list of options. Refer to “4.2.7 Pop-up window.”

4.2.7 Pop-up window

Select a menu item then press <Enter> to display a pop-up window with the configuration options for that item.

4.2.8 Scroll bar

A scroll bar appears on the right side of a menu screen when there are items that do not fit on the screen. Press the Up/Down arrow keys or <Page Up> / <Page Down> keys to display the other items on the screen.

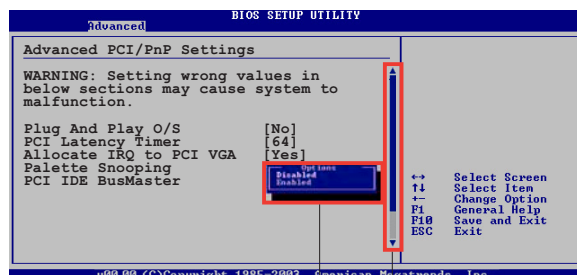

Pop-up window

Scroll bar

4.2.9 General help

At the top right corner of the menu screen is a brief description of the selected item.

4.3 Main menu

When you enter the BIOS Setup program, the **Main** menu screen appears, giving you an overview of the basic system information.



Refer to section “4.2.1 BIOS menu screen” for information on the menu screen items and how to navigate through them.

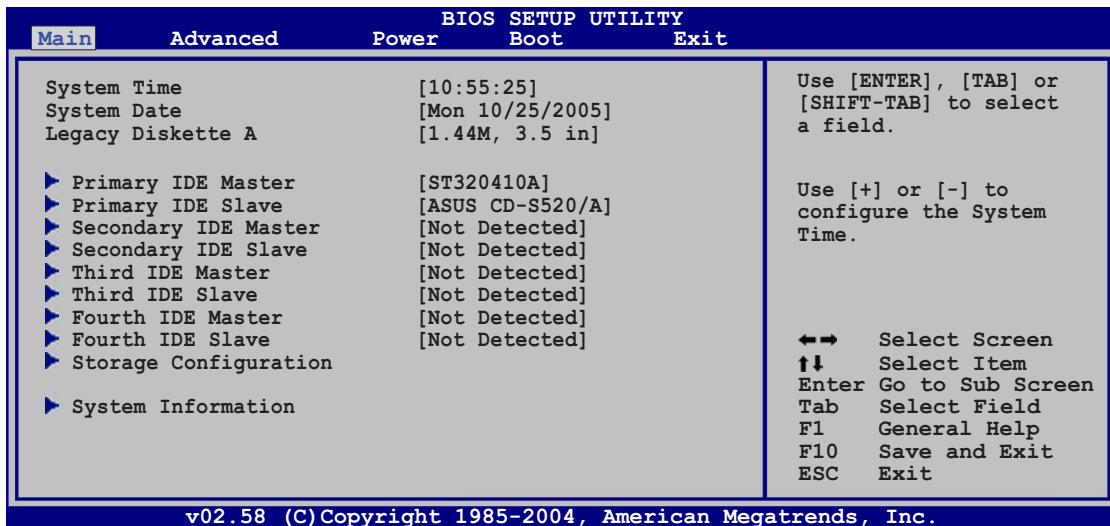

4.3.1 System Time [xx:xx:xx]

Allows you to set the system time.

4.3.2 System Date [Day xx/xx/xxxx]

Allows you to set the system date.

4.3.3 Legacy Diskette A [1.44M, 3.5 in.]

Sets the type of floppy drive installed. Configuration options: [Disabled] [360K, 5.25 in.] [1.2M, 5.25 in.] [720K, 3.5 in.] [1.44M, 3.5 in.] [2.88M, 3.5 in.]

4.3.4 Primary, Secondary, Third, and Fourth IDE Master/Slave

The BIOS automatically detects the connected IDE devices. There is a separate sub-menu for each IDE device. Select a device item, then press <Enter> to display the IDE device information.

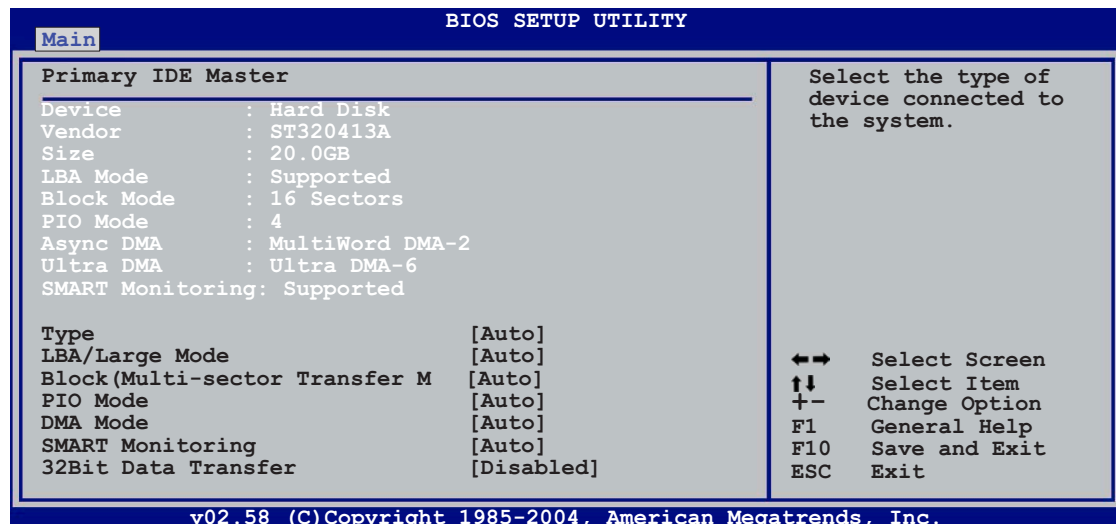

The BIOS automatically detects the values opposite the dimmed items (Device, Vendor, Size, LBA Mode, Block Mode, PIO Mode, Async DMA, Ultra DMA, and SMART monitoring). These values are not user-configurable. These items show N/A if no IDE device is installed in the system.

Type [Auto]

Selects the type of IDE drive. Setting to [Auto] allows automatic selection of the appropriate IDE device type. Select [CDROM] if you are specifically configuring a CD-ROM drive. Select [ARMD] (ATAPI Removable Media Device) if your device is either a ZIP, LS-120, or MO drive. Configuration options: [Not Installed] [Auto] [CDROM] [ARMD]

LBA/Large Mode [Auto]

Enables or disables the LBA mode. Setting to [Auto] enables the LBA mode if the device supports this mode, and if the device was not previously formatted with LBA mode disabled. Configuration options: [Disabled] [Auto]

Block (Multi-sector Transfer) M [Auto]

Enables or disables data multi-sectors transfers. When set to [Auto], the data transfer from and to the device occurs multiple sectors at a time if the device supports multi-sector transfer feature. When set to [Disabled], the data transfer from and to the device occurs one sector at a time. Configuration options: [Disabled] [Auto]

PIO Mode [Auto]

Selects the PIO mode.

Configuration options: [Auto] [0] [1] [2] [3] [4]

DMA Mode [Auto]

Selects the DMA mode. Configuration options: [Auto] [SWDMA0] [SWDMA1] [SWDMA2] [MWDMA0] [MWDMA1] [MWDMA2] [UDMA0] [UDMA1] [UDMA2] [UDMA3] [UDMA4] [UDMA5] [UDMA6]

SMART Monitoring [Auto]

Sets the Smart Monitoring, Analysis, and Reporting Technology.

Configuration options: [Auto] [Disabled] [Enabled]

32Bit Data Transfer [Disabled]

Enables or disables 32-bit data transfer.

Configuration options: [Disabled] [Enabled]

4.3.5 Storage Configuration

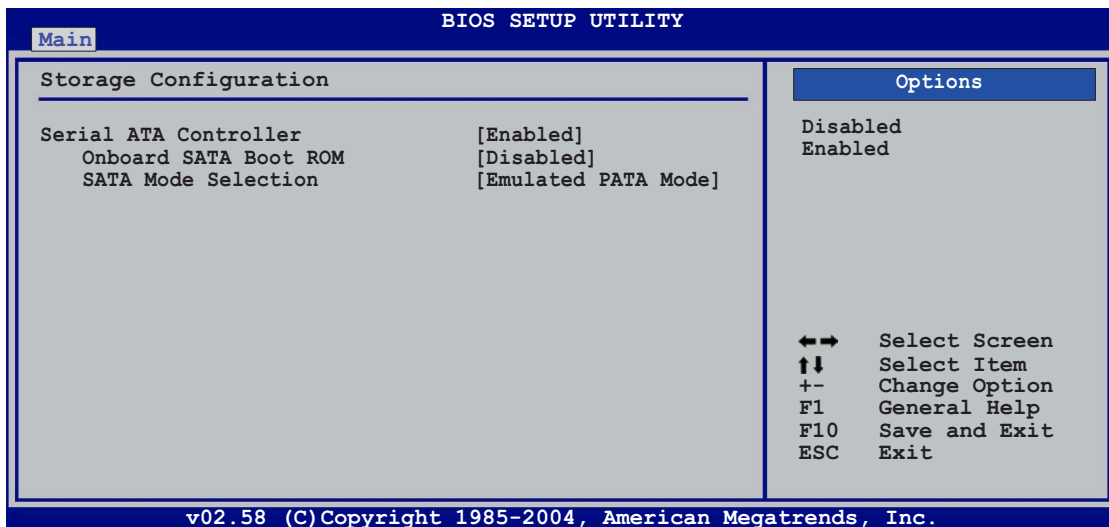

Serial ATA Controller [Enabled]

Allows you to enable or disable the Serial ATA controller.

Configuration options: [Disabled] [Enabled]



The succeeding items appear only if the **Serial ATA Controller** item is set to [Enabled].

Onboard SATA Boot ROM [Disabled]

Allows you to enable or disable the onboard Serial ATA Boot ROM. Set this item to [Enabled] to configure Serial ATA RAID. Configuration options: [Disabled] [Enabled]

SATA Mode Selection [Emulated PATA Mode]

Allows you to select the Serial ATA mode. Configuration options: [Emulated PATA Mode] [AHCI Mode]

4.3.6 System Information

This menu gives you an overview of the general system specifications. The BIOS automatically detects the items in this menu.

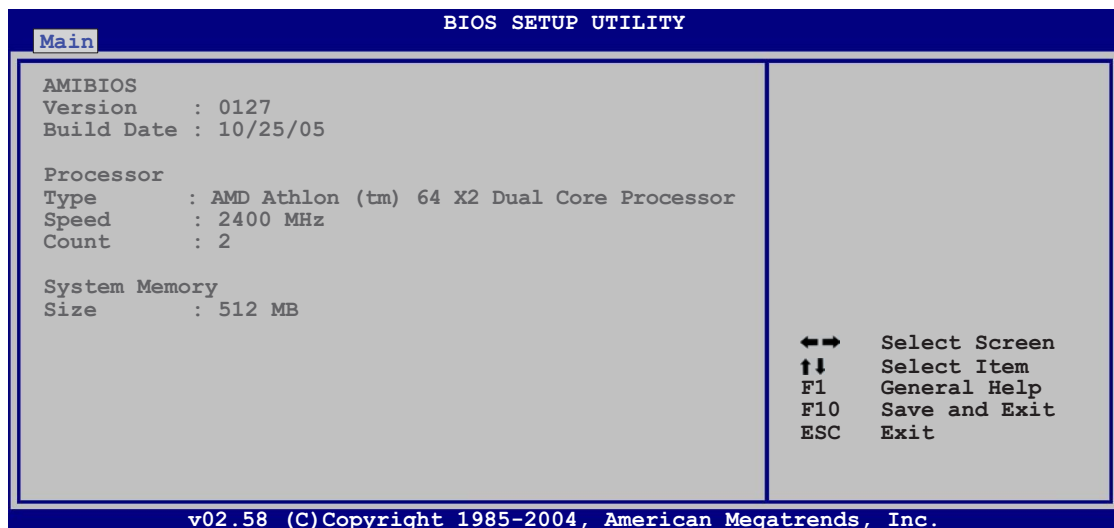

AMI BIOS

Displays the auto-detected BIOS information.

Processor

Displays the auto-detected CPU specification.

System Memory

Displays the auto-detected system memory.

4.4 Advanced menu

The Advanced menu items allow you to change the settings for the CPU and other system devices.

Take caution when changing the settings of the Advanced menu items. Incorrect field values can cause the system to malfunction.

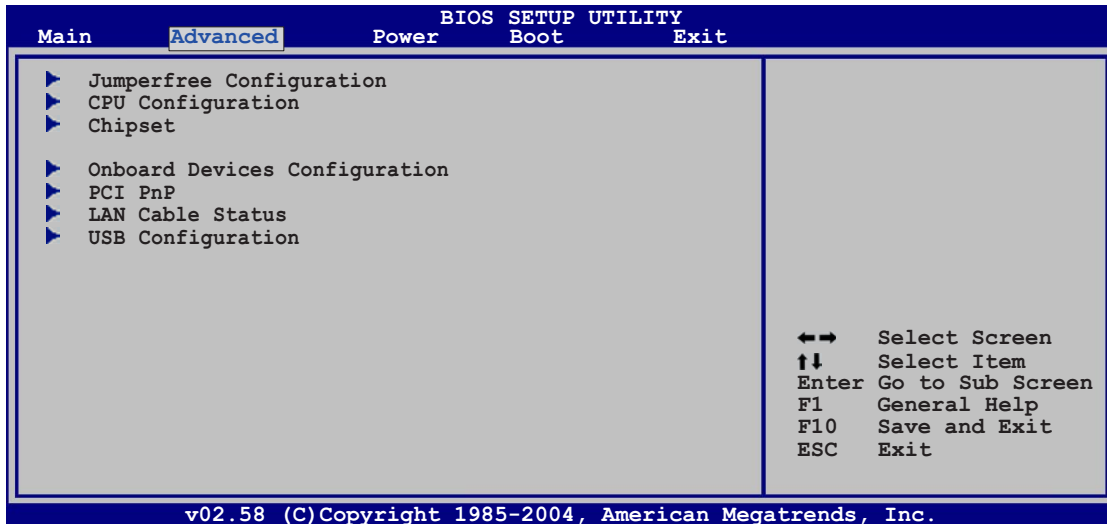

4.4.1 JumperFree Configuration

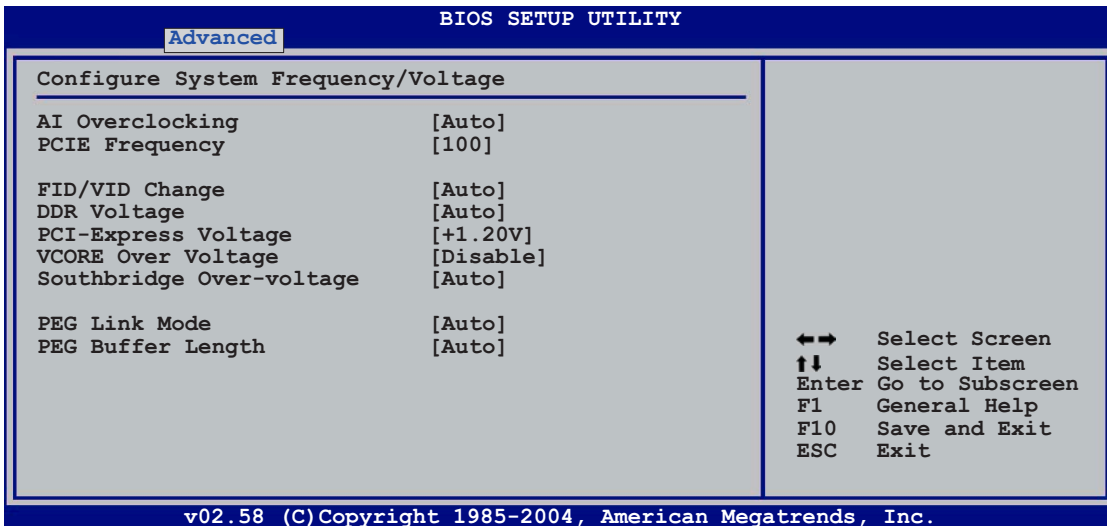

AI Overclocking [Auto]

Allows you to select the overclocking options to achieve the desired CPU internal frequency. Select either one of the preset overclocking configuration options.

Setting	Description
Manual	allows you to individually set overclocking parameters.
Auto	loads the optimal settings for the system.
Standard	loads the standard settings for the system.
Overclock Profile	loads overclocking profiles with optimal parameters for stability when overclocking.

PCIe Frequency [100]

Allows you to set the PCI Express frequency. Use the <+>/<-> key or the number keys to set the value. Configuration options: [100] ~ [150]

FID/VID Change [Auto]

When set to [Auto], FID/VID will be set at the rated frequency/voltage. When set to [Manual], FID/VID will be set based on the user selection.



The following items appear only when the **FID/VID Change item** is set to [Manual].

Processor Frequency Multiplier [x4]

Allows you to set the processor frequency multiplier. Configuration options: [x4] [x4.5] [x5]... [x25.5]

Processor Voltage [1.350 V]

Allows you to set the processor voltage. Configuration options: [1.350 V] [1.325 V] [1.300 V]... [0.800 V]

DDR Voltage [Auto]

Allows you to set the DDR memory voltage.

Configuration options: [Auto] [2.65 V] [2.70 V] [2.80 V] [2.85 V] [2.90 V] [3.00 V] [3.10 V] [3.20 V]



Setting a very high voltage may damage the component permanently.
Setting a very low voltage may cause the system to become unstable.

PCI-Express Voltage [+1.20V]

Allows you to set the PCI Express voltage.

Configuration options: [+1.20V] [+1.30V] [+1.40V] [+1.50V]



Setting a very high voltage may damage the component permanently.
Setting a very low voltage may cause the system to become unstable.

VCORE Over-voltage [Disable]

Allows you to enable or disable VCORE over-voltage.

Configuration options: [Disable] [Enable]

Southbridge Over-voltage [Disable]

Configuration options: [Auto] [Disable] [Enable]

PEG Link Mode [Auto]

Sets the PCI Express graphics (PEG) link mode. Setting this item to [Auto] allows the motherboard to automatically adjust the PCI Express graphics link mode to the correct frequency based on the system configuration.

Three additional settings are available for overclocking the PEG Link Mode.

Configuration options: [Auto] [Disabled] [Normal] [Fast] [Faster]

PEG Buffer Length [Auto]

Allows you to set the PEG buffer length.

Configuration options: [Auto] [Short] [Long] [Longer] [Longest]



The following item appears only when you set the **AI Overclocking** item to [Manual].

CPU Frequency [XXX]

Allows you to adjust the CPU frequency. The value of this item is auto-detected by the BIOS. Use the <+> and <-> keys to adjust the CPU FSB frequency. You can also type the desired CPU frequency using the numeric keypad. The values range from 200 to 400.



The following item appears only when you set the **AI Overclocking** item to [Overclock Profile].

Overclock Options [Overclock 5%]

Allows you to overclock the CPU speed through the available preset values. Configuration options: [Overclock 3%] [Overclock 5%] [Overclock 10%] [Overclock 15%] [Overclock 20%] [Overclock 30%]

4.4.2 CPU Configuration

The items in this menu show the CPU-related information that the BIOS automatically detects.

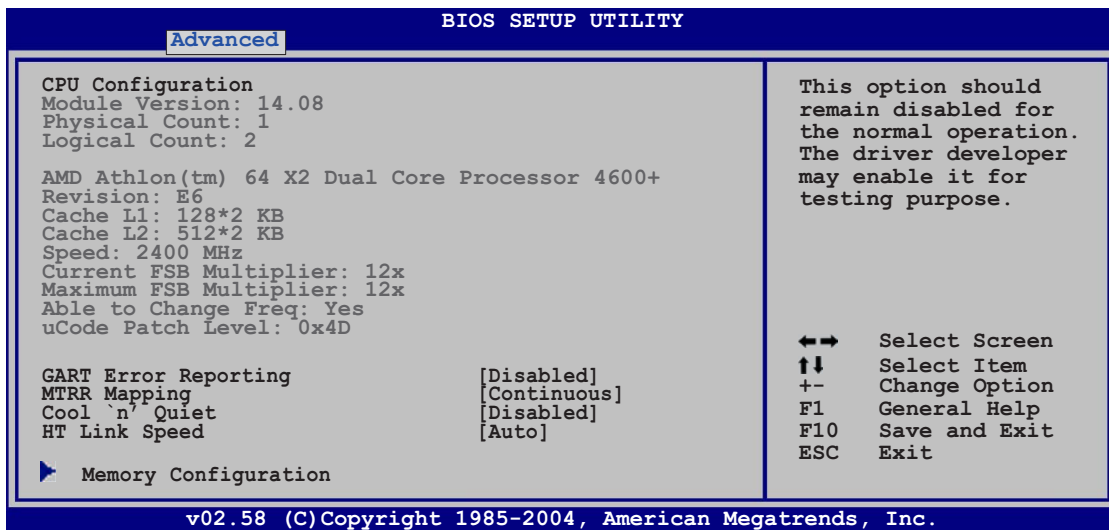

GART Error Reporting [Disabled]

Allows you to enable or disable GART error checking for testing purposes. Configuration options: [Disabled] [Enabled]

MTRR Mapping [Continuous]

Determines the method used for programming processor MTRRs when using more than 4 GB of system memory. Setting to [Discrete] leaves the PCI hole below the 4 GB boundary undescribed. [Continuous] explicitly describes the PCI hole as non-cacheable. Configuration options: [Continuous] [Discrete]

Cool 'n' Quiet [Disabled]

Enables or disables the Cool 'n' Quiet™ technology feature. Configuration options: [Enabled] [Disabled]

HT Link Speed [Auto]

Allows you to set the speed at which the HyperTransport link will run if the speed is lower than or equal to the system clock and if the board is capable. Configuration options: [Auto] [200 MHz] [400 MHz] [600 MHz] [800 MHz] [1 GHz]

Memory Configuration

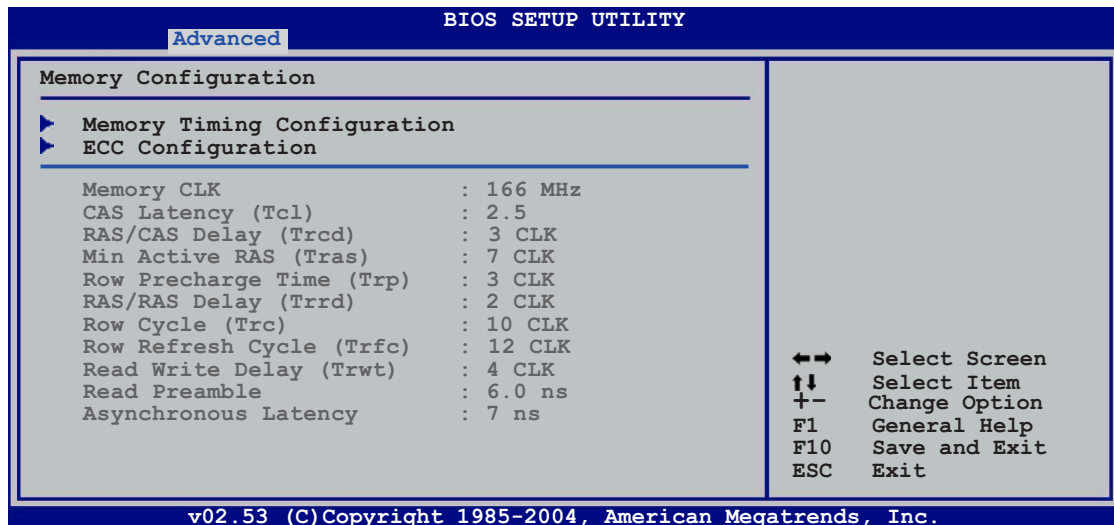

Memory Timing Configuration

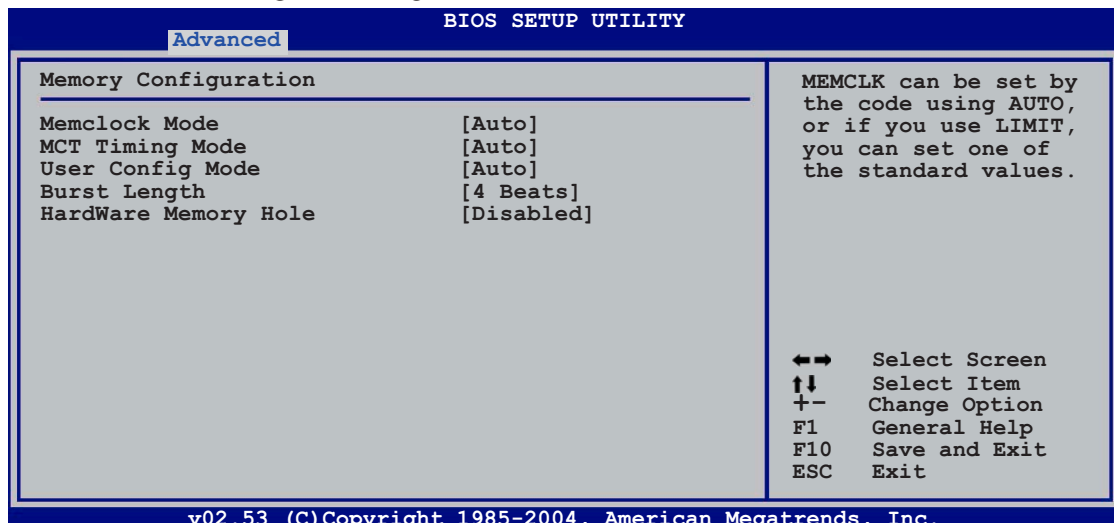

Memclock Mode [Auto]

[Auto] allows the BIOS to set the memclock mode automatically.

[Limit] allows you to select from any of the standard values.

Configuration options: [Auto] [Limit]



The following item appears when the **Memclock Mode** item is set to [Limit].

Memclock Value [200 MHz]

Allows you to set the memclock value.

Configuration options: [100 MHz] [133 MHz] [166 MHz] [183 MHz] [200 MHz]

MCT Timing Mode [Auto]

[Auto] allows the BIOS to set the MCT timing mode automatically.

[Manual] allows you to set the values by yourself.

Configuration options: [Auto] [Manual]



The following items appear when the **MCT Timing Mode** item is set to [Manual].

CAS Latency (CL) [Auto]

Configuration options: [Auto] [2.0] [3.0] [2.5]

TRAS [Auto]

Configuration options: [Auto] [5 CLK] [6 CLK]... [15 CLK]

TRP [Auto]

Configuration options: [Auto] [2 CLK] [3 CLK]... [6 CLK]

TRCD [Auto]

Configuration options: [Auto] [2 CLK] [3 CLK]... [6 CLK]

TRRD [Auto]

Configuration options: [Auto] [2T] [3T] [4T]

TRC [Auto]

Configuration options: [Auto] [7T] [8T] [9T]... [22T]

TRFC [Auto]

Configuration options: [Auto] [9T] [10T] [11T]... [24T]

TRWT [Auto]

Configuration options: [Auto] [1 CLK] [2 CLK]... [6 CLK]

User Config Mode [Auto]

Configuration options: [Auto] [Manual]



The following items appear when the **User Config Mode** item is set to [Manual].

Read Preamble [5.5ns]

Configuration options: [2.0ns] [2.5ns] [3.0ns]... [9.5ns]

Async Latency [7.0ns]

Configuration options: [4.0ns] [5.0ns] [6.0ns]... [11.0ns]

CMD-ADDR Timing Mode [2T]

Configuration options: [1T] [2T]

Burst length [4 Beats]

Sets the burst length.

Configuration options: [8 Beats] [4 Beats] [2 Beats]

Hardware Memory Hole [Disabled]

Enables or disables the software memory remapping around the memory hole. Only REV E0 processors and above support this feature.
Configuration options: [Disabled] [Enabled]

ECC Configuration

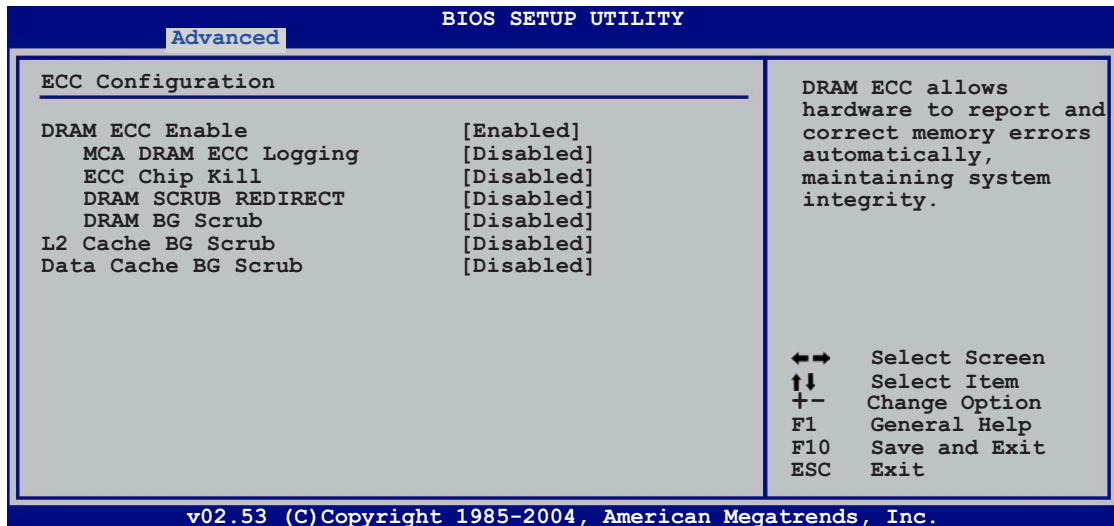

DRAM ECC Enable [Enabled]

Allows you to enable or disable DRAM ECC, which allows the hardware to report and correct memory errors automatically to maintain system integrity. Configuration options: [Disabled] [Enabled]

MCA DRAM ECC Logging [Disabled]

Allows you to enable or disable MCA DRAM ECC logging/reporting.
Configuration options: [Disabled] [Enabled]

ECC Chip Kill [Disabled]

Allows you to enable or disable ECC chip kill.
Configuration options: [Disabled] [Enabled]

DRAM SCRUB REDIRECT [Disabled]

Allows you to enable or disable DRAM scrub redirect, which allows the system to correct DRAM ECC errors immediately when they occur, even if background scrubbing is on. Configuration options: [Disabled] [Enabled]

DRAM BG Scrub [Disabled]

Allows DRAM scrubbing to correct memory errors so later reads are correct. Doing this while memory is not being used improves performance. Configuration options:
[Disabled] [40ns] [80ns] [160ns] [320ns] [640ns] [1.28us] [2.56us] [5.12us]
[10.2us] [20.5 us] [41.0us] [81.9us] [163.8us] [327.7us] [655.4us] [1.31ms]
[2.62ms] [5.24ms] [10.49ms] [20.97ms] [42.00ms] [84.00ms]

L2 Cache BG Scrub [Disabled]

Allows the L2 Data Cache RAM to be corrected while idle.

Configuration options: [Disabled] [40ns] [80ns] [160ns] [320ns] [640ns] [1.28us] [2.56us] [5.12us] [10.2us] [20.5 us] [41.0us] [81.9us] [163.8us] [327.7us] [655.4us] [1.31ms] [2.62ms] [5.24ms] [10.49ms] [20.97ms] [42.00ms] [84.00ms]

Data Cache BG Scrub [Disabled]

Allows the L1 Data Cache RAM to be corrected while idle.

Configuration options: [Disabled] [40ns] [80ns] [160ns] [320ns] [640ns] [1.28us] [2.56us] [5.12us] [10.2us] [20.5 us] [41.0us] [81.9us] [163.8us] [327.7us] [655.4us] [1.31ms] [2.62ms] [5.24ms] [10.49ms] [20.97ms] [42.00ms] [84.00ms]

4.4.3 Chipset Configuration

The Chipset menu allows you to change the advanced chipset settings. Select an item then press <Enter> to display the sub-menu.

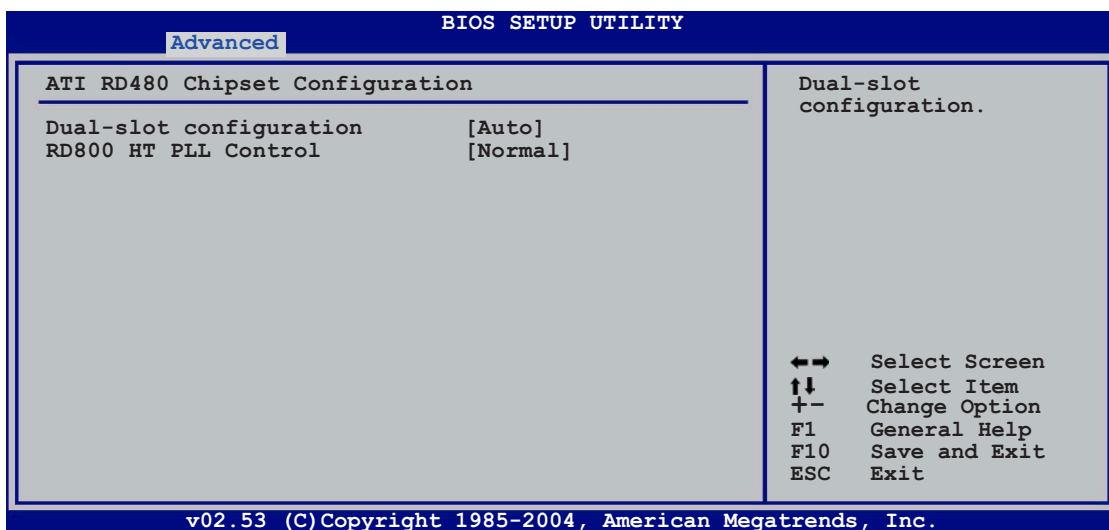

Dual-slot configuration [Auto]

When set to [Auto], the BIOS automatically sets the configuration for either single or dual graphics cards. Configuration options: [Auto] [Single Video Card] [Dual Video Cards]



If you set this item to [Single Video Card], you will not be able to enable the Crossfire™ function even if you installed two Crossfire™-enabled graphics cards. For optimum performance, we recommend that you keep the default setting [Auto].

RD800 HT PLL Control [Normal]

Configuration options: [Normal] [Fast]

4.4.4 Onboard Devices Configuration

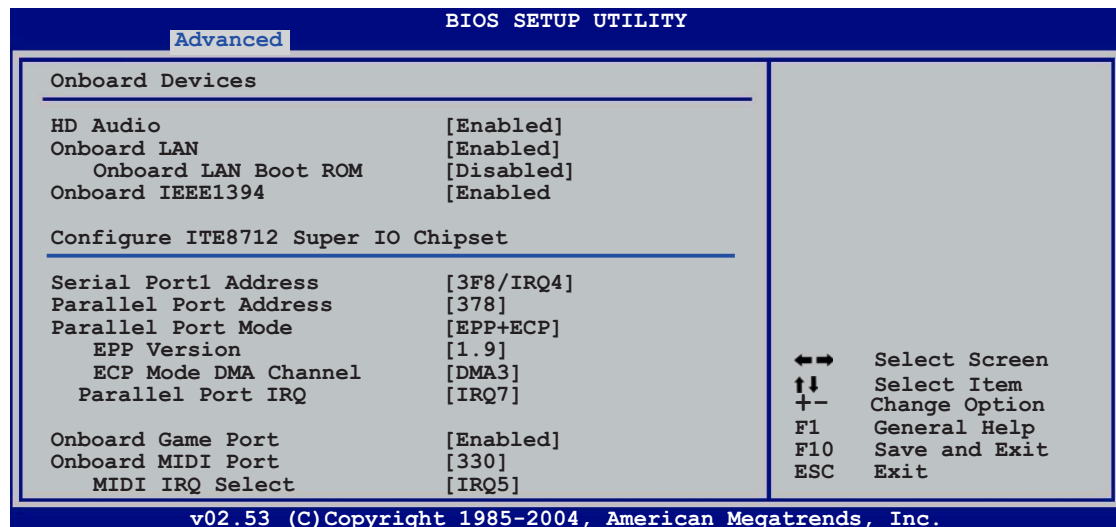

HD Audio [Enabled]

Allows you to enable or disable the HD Audio feature.
Configuration options: [Disabled] [Enabled]

Onboard LAN [Enabled]

Allows you to enable or disable the onchip MAC LAN.
Configuration options: [Disabled] [Enabled]

Onboard LAN Boot ROM [Disabled]

This item allows you to enable or disable the MAC boot ROM. This item appears only when the **Onboard LAN** item is set to [Enabled].
Configuration options: [Disabled] [Enabled]

Onboard IEEE1394 [Enabled]

Allows you to enable or disable the onboard IEEE 1394a controller.
Configuration options: [Disabled] [Enabled]

Serial Port1 Address [3F8/IRQ4]

Allows you to select the Serial Port1 base address.
Configuration options: [Disabled] [3F8/IRQ4] [2F8/IRQ3] [3E8/IRQ4] [2E8/IRQ3]

Parallel Port Address [378]

Allows you to select the Parallel Port base addresses.
Configuration options: [Disabled] [378] [278]

Parallel Port Mode [EPP+ECP]

Allows you to select the Parallel Port mode.
Configuration options: [Normal] [EPP] [ECP] [EPP+ECP]

EPP Version [1.9]

Appears only when the Parallel Port Mode is set to [EPP] or [EPP+ECP]. Allows you to select the parallel port EPP version.
Configuration options: [1.9] [1.7]

ECP Mode DMA Channel [DMA3]

Appears only when the Parallel Port Mode is set to [EPP+ECP] or [ECP]. This item allows you to set the Parallel Port ECP DMA.
Configuration options: [DMA0] [DMA1] [DMA3]

Parallel Port IRQ [IRQ7]

Allows you to select the parallel port IRQ.
Configuration options: [IRQ5] [IRQ7]

Onboard Game Port [Enabled]

Allows you to enable or disable the onboard game port.
Configuration options: [Disabled] [Enabled]

Onboard MIDI Port [330]

Allows you to select the MIDI Port address or to disable the port.
Configuration options: [Disabled] [300] [330]

MIDI IRQ Select [IRQ5]

This item allows the BIOS to select the MIDI port IRQs.
Configuration options: [IRQ5] [IRQ7] [IRQ10] [IRQ11]

4.4.5 PCI PnP

The PCI PnP menu items allow you to change the advanced settings for PCI/PnP devices. The menu includes setting IRQ and DMA channel resources for either PCI/PnP or legacy ISA devices, and setting the memory size block for legacy ISA devices.



Take caution when changing the settings of the PCI PnP menu items. Incorrect field values can cause the system to malfunction.

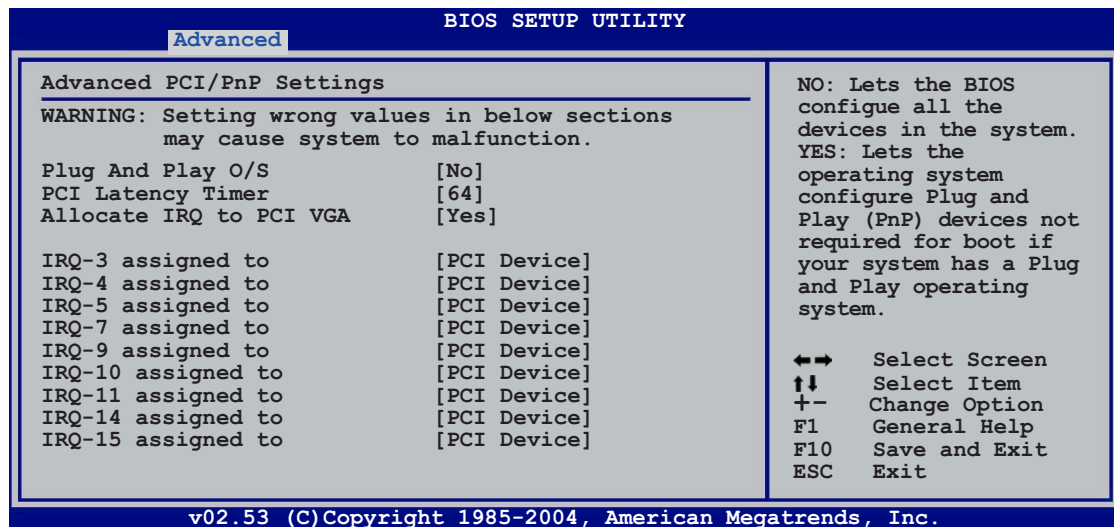

Plug And Play O/S [No]

When set to [No], BIOS configures all the devices in the system. When set to [Yes] and if you install a Plug and Play operating system, the operating system configures the Plug and Play devices not required for boot.

Configuration options: [No] [Yes]

PCI Latency Timer [64]

Allows you to select the value in units of PCI clocks for the PCI device latency timer register. Configuration options: [32] [64] [96] [128] [160] [192] [224] [248]

Allocate IRQ to PCI VGA [Yes]

When set to [Yes], BIOS assigns an IRQ to PCI VGA card if the card requests for an IRQ. When set to [No], BIOS does not assign an IRQ to the PCI VGA card even if requested. Configuration options: [No] [Yes]

IRQ-xx assigned to [PCI Device]

When set to [PCI Device], the specific IRQ is free for use of PCI/PnP devices. When set to [Reserved], the IRQ is reserved for legacy ISA devices. Configuration options: [PCI Device] [Reserved]

4.4.6 LAN Cable Status

This menu displays the status of the Local Area Network (LAN) cable connected to the LAN (RJ-45) port.

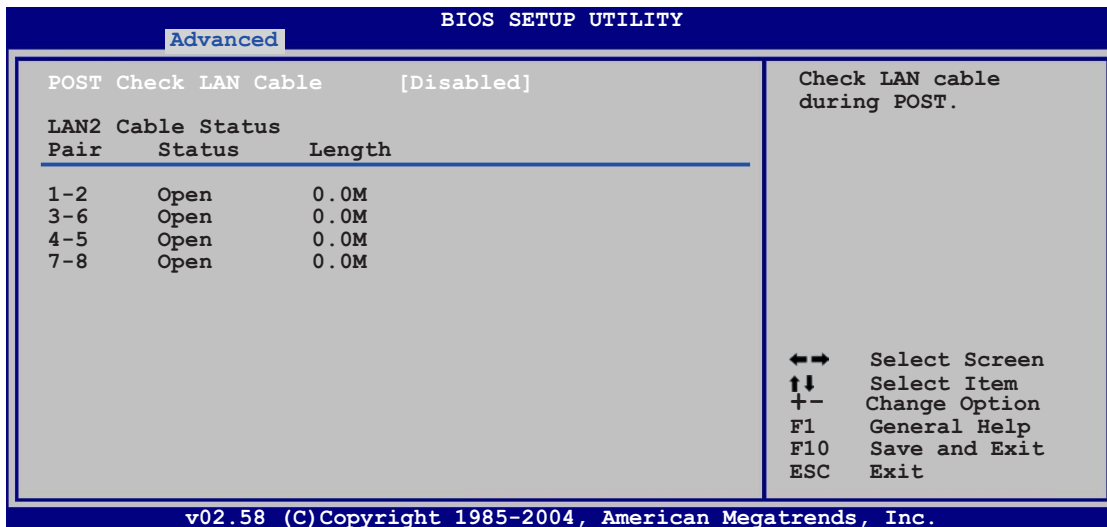

POST Check LAN Cable [Disabled]

Allows you to enable or disable LAN cable check during POST. When enabled, the menu reports the cable faults or shorts, and displays the point (length) where the fault or short is detected. Configuration options: [Disabled] [Enabled]

4.4.7 USB Configuration

The items in this menu allows you to change the USB-related features. Select an item then press <Enter> to display the configuration options.

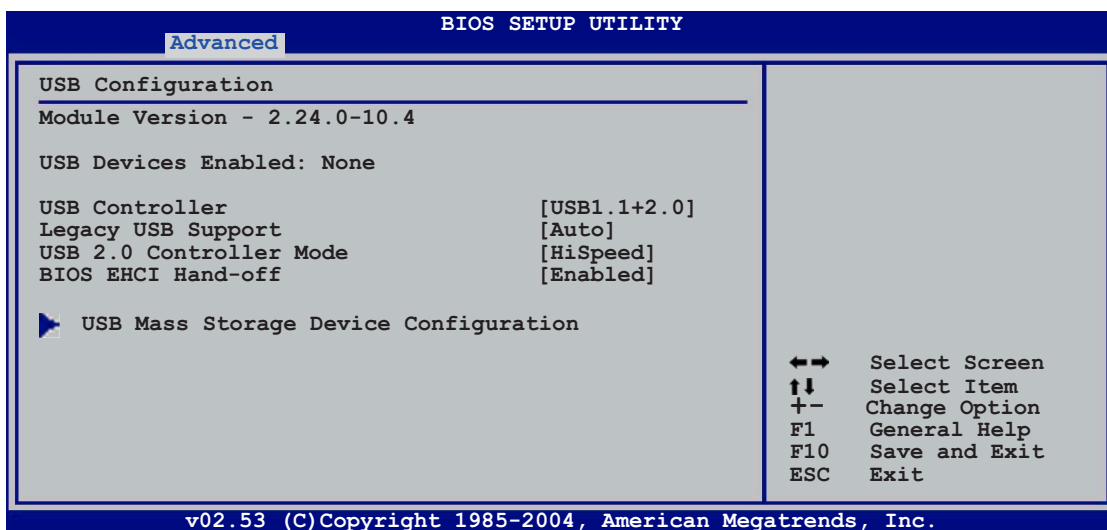

The **Module Version** and **USB Devices Enabled** items show the auto-detected values. If no USB device is detected, the item shows **None**.

USB Controller [USB1.1+2.0]

Allows you to disable the USB controllers, or choose which controller to enable. Configuration options: [Disabled] [USB1.1+2.0] [USB1.1 Only]

Legacy USB Support [Auto]

Allows you to enable or disable support for legacy USB devices. Setting to [Auto] allows the system to detect the presence of USB devices at startup. If detected, the USB controller legacy mode is enabled. If no USB device is detected, the legacy USB support is disabled.

Configuration options: [Disabled] [Enabled] [Auto]

USB 2.0 Controller Mode [HiSpeed]

Allows you to set the USB 2.0 controller mode to HiSpeed (480 Mbps) or FullSpeed (12 Mbps). Configuration options: [HiSpeed] [FullSpeed]

BIOS EHCI Hand-off [Enabled]

Allows you to enable support for operating systems without an EHCI hand-off feature. Configuration options: [Disabled] [Enabled]



The following sub-menu and its related items appear only when you plugged a USB device into a USB port.

USB Mass Storage Device Configuration

USB Mass Storage Reset Delay [Auto]

Sets the USB mass storage reset delay time in seconds.

Configuration options: [10] [20] [30] [40]

Emulation Type [Auto]

Configuration options: [Auto] [Floppy] [Forced FDD] [HD] [CDROM]

4.5 Power menu

The Power menu items allow you to change the settings for the ACPI and Advanced Power Management (APM) features. Select an item then press <Enter> to display the configuration options.

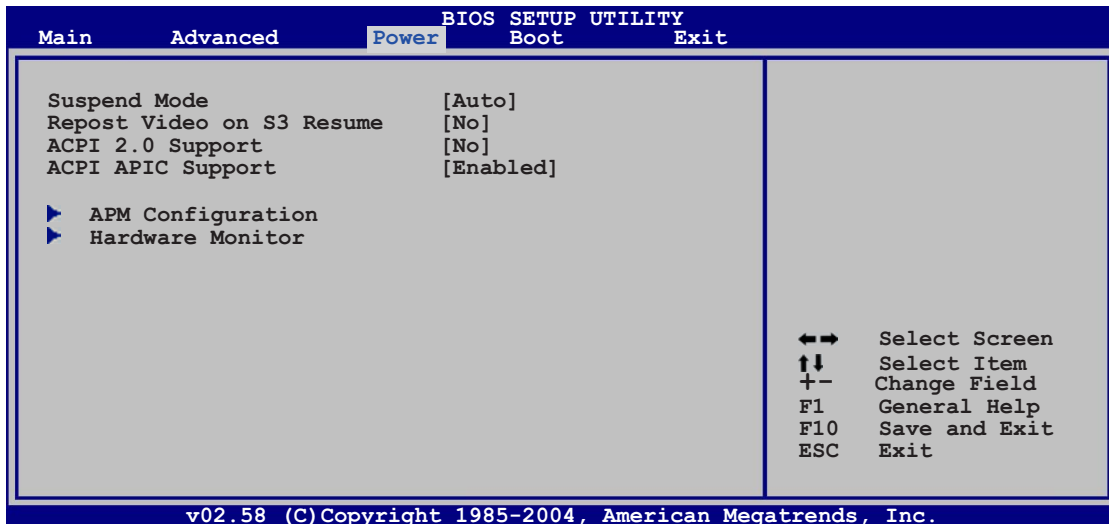

4.5.1 Suspend Mode [Auto]

Allows you to select the Advanced Configuration and Power Interface (ACPI) state to be used for system suspend. Setting this item to [Auto] allows the OS to select the ACPI state. Configuration options: [S1 (POS) Only] [S3 Only] [Auto]

4.5.2 Repost Video on S3 Resume [No]

Determines whether to invoke VGA BIOS POST on S3/STR resume. Configuration options: [No] [Yes]

4.5.3 ACPI 2.0 Support [No]

Allows you to add more tables for Advanced Configuration and Power Interface (ACPI) 2.0 specifications. Configuration options: [No] [Yes]

4.5.4 ACPI APIC Support [Enabled]

Allows you to enable or disable the Advanced Configuration and Power Interface (ACPI) support in the Advanced Programmable Interrupt Controller (APIC). When set to Enabled, the ACPI APIC table pointer is included in the RSDT pointer list. Configuration options: [Disabled] [Enabled]

4.5.5 APM Configuration

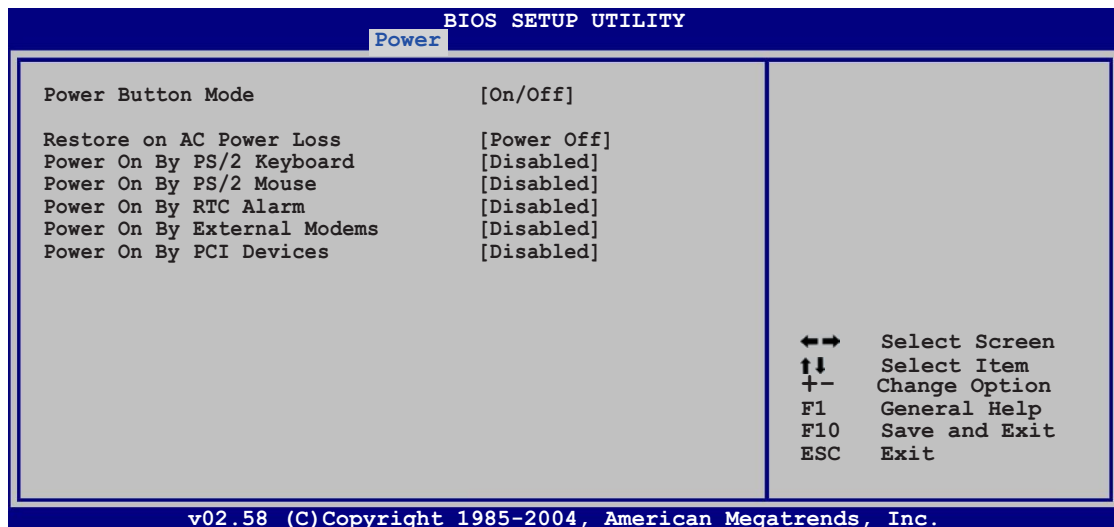

Power Button Mode [On/Off]

Allows the system to go into On/Off mode or suspend mode when the power button is pressed. Configuration options: [On/Off] [Suspend]

Restore on AC Power Loss [Power Off]

When set to Power Off, the system goes into off state after an AC power loss. When set to Power On, the system goes on after an AC power loss. When set to Last State, the system goes into either off or on state, whatever the system state was before the AC power loss. Configuration options: [Power Off] [Power On] [Last State]

Power On By PS/2 Keyboard [Disabled]

Allows you to use specific keys on the keyboard to turn on the system. This feature requires an ATX power supply that provides at least 1A on the +5VSB lead. Configuration options: [Disabled] [Enabled]

Power On By PS/2 Mouse [Disabled]

When set to [Enabled], this parameter allows you to use the PS/2 mouse to turn on the system. This feature requires an ATX power supply that provides at least 1A on the +5VSB lead. Configuration options: [Disabled] [Enabled]

Power On By RTC Alarm [Disabled]

Allows you to enable or disable RTC to generate a wake event. Configuration options: [Disabled] [Enabled]



The succeeding items appear when the **Power On By RTC Alarm** item is set to Enabled.

RTC Alarm Date (Days) [Everyday]

To set the alarm date, highlight this item and press the <+> or <-> key to make the selection.

RTC Alarm Hour (Hours) [0]

To set the alarm hour, highlight this item and press the <+> or <-> key to make the selection.

RTC Alarm Minute (Minutes) [0]

To set the alarm minute, highlight this item and press the <+> or <-> key to make the selection.

RTC Alarm Second (Seconds) [0]

To set the alarm second, highlight this item and press the <+> or <-> key to make the selection.

Power On By External Modems [Disabled]

Allows either settings of [Enabled] or [Disabled] for powering up the computer when the external modem receives a call while the computer is in Soft-off mode. Configuration options: [Disabled] [Enabled]



The computer cannot receive or transmit data until the computer and applications are fully running. Thus, connection cannot be made on the first try. Turning an external modem off and then back on while the computer is off causes an initialization string that turns the system power on.

Power On By PCI Devices [Disabled]

When set to [Enabled], this parameter allows you to turn on the system through a PCI LAN or modem card. This feature requires an ATX power supply that provides at least 1A on the +5VSB lead. Configuration options: [Disabled] [Enabled]

4.5.6 Hardware Monitor

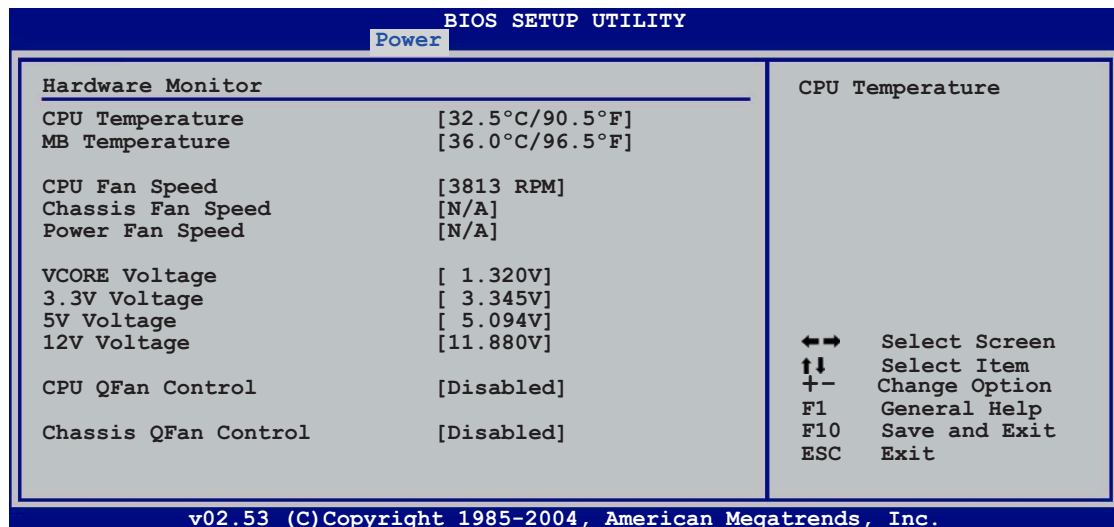

CPU Temperature [xxx°C/xxx°F]

MB Temperature [xxx°C/xxx°F]

The onboard hardware monitor automatically detects and displays the motherboard and CPU temperatures. Select [Ignored] if you do not wish to display the detected temperatures.

CPU Fan Speed [xxxxRPM] or [Ignored]

The onboard hardware monitor automatically detects and displays the CPU fan speed in rotations per minute (RPM). If the fan is not connected to the motherboard, the field shows N/A. Select [Ignore] from the item options to disable CPU fan speed monitoring.

Chassis Fan Speed N/A] or [Ignored]

The onboard hardware monitor automatically detects and displays the chassis fan speed in rotations per minute (RPM). If the fan is not connected to the chassis, the specific field shows N/A. Select [Ignore] from the item options to disable chassis fan speed monitoring.

Power Fan Speed [N/A] or [Ignored]

The onboard hardware monitor automatically detects and displays the power fan speed in rotations per minute (RPM). If the fan is not connected to the power fan connector, the specific field shows N/A.

VCore Voltage, 3.3V Voltage, 5V Voltage, 12V Voltage

The onboard hardware monitor automatically detects the voltage output through the onboard voltage regulators.

CPU QFan Control [Disabled]

Allows you to enable or disable the ASUS Q-Fan feature that smartly adjusts the fan speeds for more efficient system operation. Configuration options: [Disabled] [Enabled]



The following items appear when the **CPU QFan Control** item is set to [Enabled].

CPUFan Off Temperature [XXX]

Allows you to specify the maximum CPU temperature at which the system will shut down. Use the <+>/<-> key or use the numeric keypad to set the value. Valid values range from [0] to [100].

CPUFan Start Temperature[XXX]

Allows you to set the CPU temperature at which the CPU fan starts. Use the <+>/<-> key or use the numeric keypad to set the value. Valid values range from [0] to [100].

CPUFan Full-speed Temperature[XXX]

Allows you to set the CPU temperature at which the CPU fan runs at full speed. Use the <+>/<-> key or use the numeric keypad to set the value. Valid values range from [0] to [100].

CPU Start PWM [XXX]

Allows you to set the CPU temperature at which the power management feature starts. Use the <+>/<-> key or use the numeric keypad to set the value. Valid values range from [0] to [100].

Chassis QFan Control [Disabled]

Allows you to enable or disable the ASUS Q-Fan feature that smartly adjusts the fan speeds for more efficient system operation. Configuration options: [Disabled] [Enabled]



The following items appear when the **Chassis QFan Control** item is set to [Enabled].

ChassisFan Off Temperature [XXX]

Allows you to specify the maximum chassis temperature at which the system will shut down. Use the <+>/<-> key or use the numeric keypad to set the value. Valid values range from [0] to [100].

ChassisFan Start Temperature[XXX]

Allows you to set the chassis temperature at which the CPU fan starts. Use the <+>/<-> key or use the numeric keypad to set the value. Valid values range from [0] to [100].

ChassisFan Full-speed Temperature[XXX]

Allows you to set the CPU temperature at which the chassis fan runs at full speed. Use the <+>/<-> key or use the numeric keypad to set the value. Valid values range from [0] to [100].

ChassisStart PWM [XXX]

Allows you to set the chassis temperature at which the power management feature starts. Use the <+>/<-> key or use the numeric keypad to set the value. Valid values range from [0] to [100].

4.6 Boot menu

The Boot menu items allow you to change the system boot options. Select an item then press <Enter> to display the sub-menu.

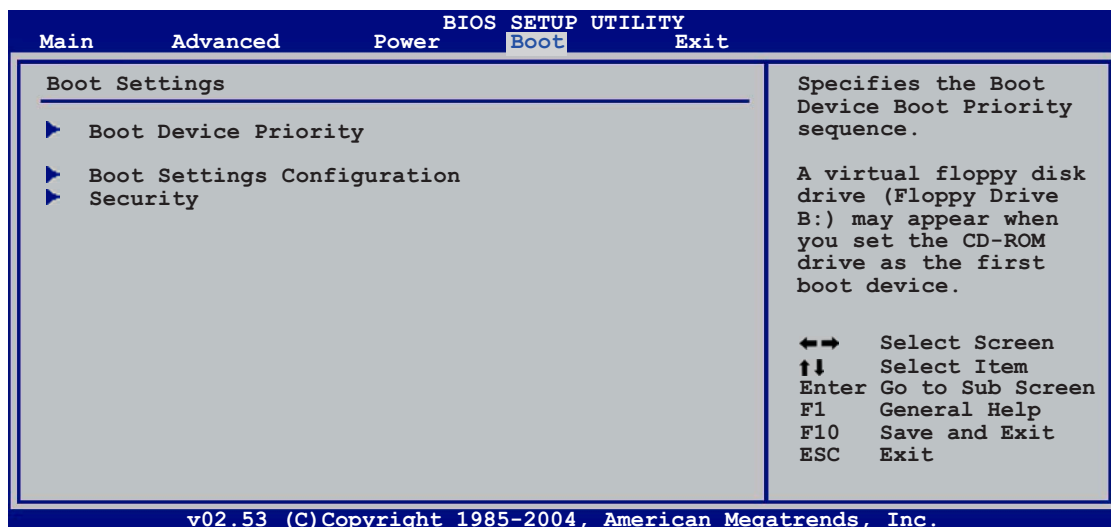

4.6.1 Boot Device Priority

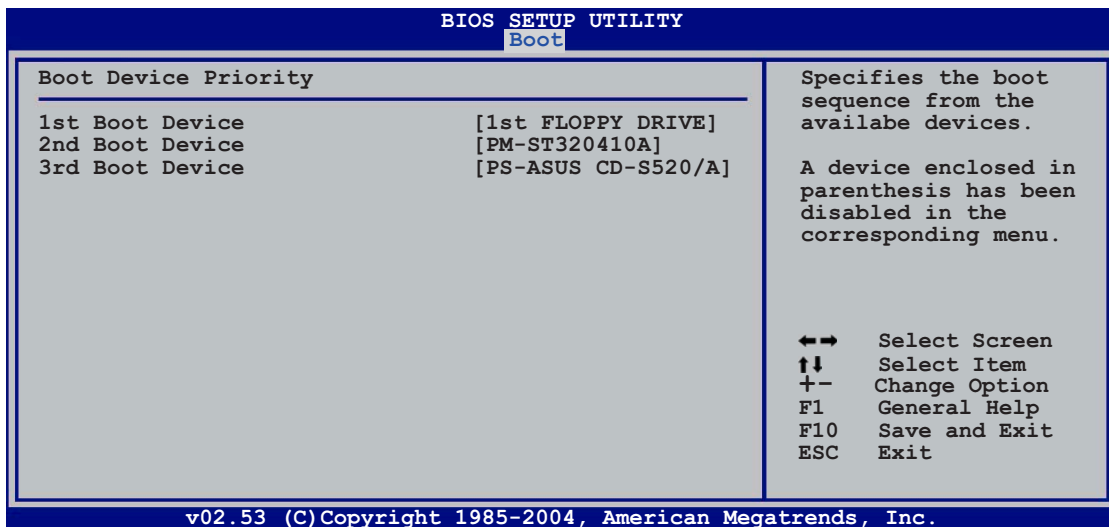

1st ~ xxth Boot Device [1st Floppy Drive]

These items specify the boot device priority sequence from the available devices. The number of device items that appears on the screen depends on the number of devices installed in the system.

Configuration options: [xxxxx Drive] [Disabled]



The following item appears only when you have set a Serial ATA drive in a RAID configuration as boot device.

Hard Disk [XXX Drive]

This item specifies the Serial ATA boot device priority sequence from the available devices in a RAID configuration.

4.6.2 Boot Settings Configuration

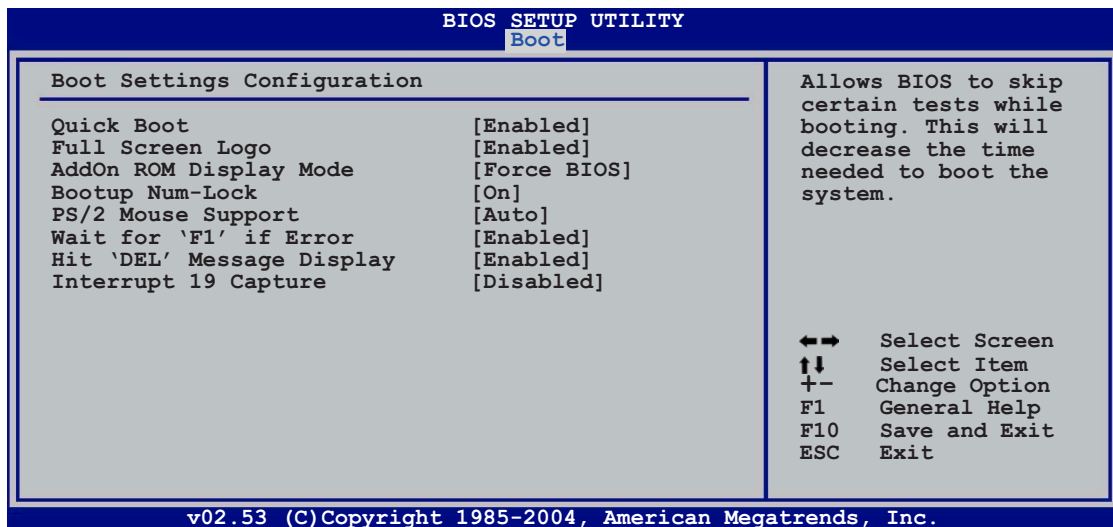

Quick Boot [Enabled]

Enabling this item allows the BIOS to skip some power on self tests (POST) while booting to decrease the time needed to boot the system. When set to [Disabled], BIOS performs all the POST items.

Configuration options: [Disabled] [Enabled]

Full Screen Logo [Enabled]

Allows you to enable or disable the full screen logo display feature.

Configuration options: [Disabled] [Enabled]



Set this item to [Enabled] to use the ASUS MyLogo™ feature.

Add On ROM Display Mode [Force BIOS]

Sets the display mode for option ROM.

Configuration options: [Force BIOS] [Keep Current]

Bootup Num-Lock [On]

Allows you to select the power-on state for the NumLock.

Configuration options: [Off] [On]

PS/2 Mouse Support [Auto]

Allows you to enable or disable support for PS/2 mouse.

Configuration options: [Disabled] [Enabled] [Auto]

Wait for 'F1' If Error [Enabled]

When set to Enabled, the system waits for the F1 key to be pressed when error occurs. Configuration options: [Disabled] [Enabled]

Hit 'DEL' Message Display [Enabled]

When set to Enabled, the system displays the message "Press DEL to run Setup" during POST. Configuration options: [Disabled] [Enabled]

Interrupt 19 Capture [Disabled]

When set to [Enabled], this function allows the option ROMs to trap Interrupt 19. Configuration options: [Disabled] [Enabled]

4.6.3 Security

The Security menu items allow you to change the system security settings. Select an item then press <Enter> to display the configuration options.

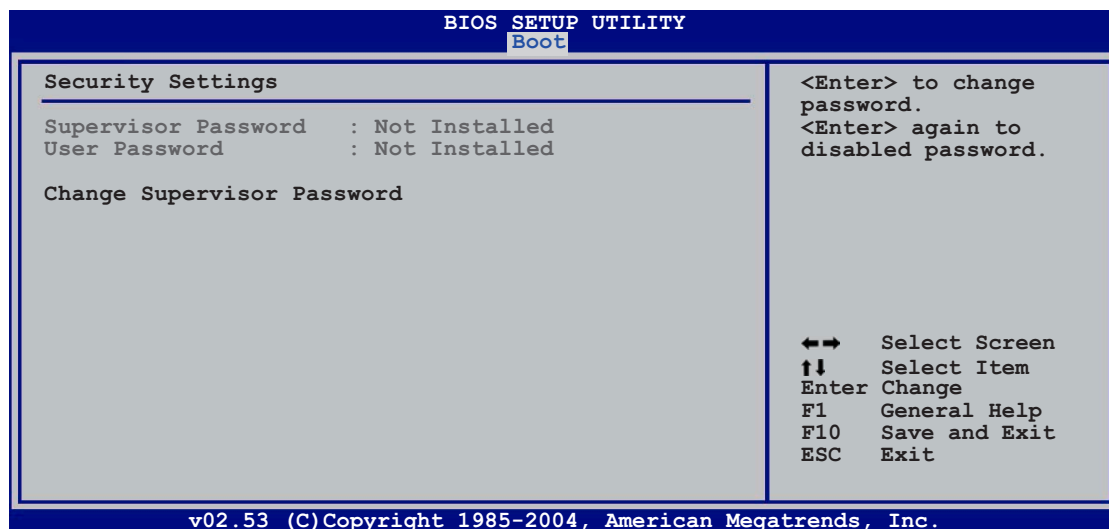

Change Supervisor Password

Select this item to set or change the supervisor password. The Supervisor Password item on top of the screen shows the default **Not Installed**. After you set a password, this item shows **Installed**.

To set a Supervisor Password:

1. Select the Change Supervisor Password item and press <Enter>.
2. From the password box, type a password composed of at least six letters and/or numbers, then press <Enter>.
3. Confirm the password when prompted.

The message "Password Installed" appears after you successfully set your password.

To change the supervisor password, follow the same steps as in setting a user password.

To clear the supervisor password, select the Change Supervisor Password then press <Enter>. The message “Password Uninstalled” appears.



If you forget your BIOS password, you can clear it by erasing the CMOS Real Time Clock (RTC) RAM. See section “2.6 Jumpers” for information on how to erase the RTC RAM.

After you have set a supervisor password, the other items appear to allow you to change other security settings.

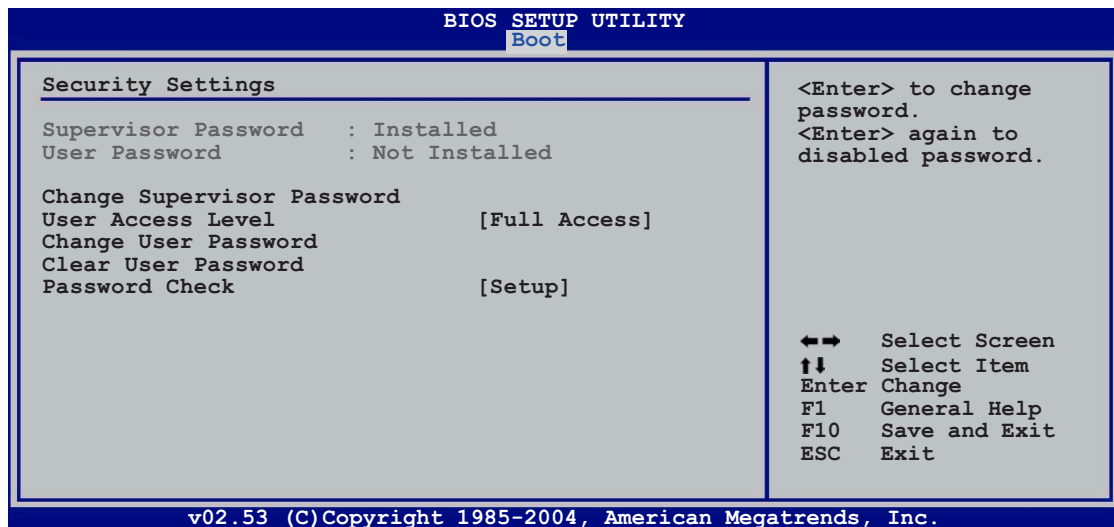

User Access Level (Full Access]

This item allows you to select the access restriction to the Setup items. Configuration options: [No Access] [View Only] [Limited] [Full Access]

No Access prevents user access to the Setup utility.

View Only allows access but does not allow change to any field.

Limited allows changes only to selected fields, such as Date and Time.

Full Access allows viewing and changing all the fields in the Setup utility.

Change User Password

Select this item to set or change the user password. The User Password item on top of the screen shows the default **Not Installed**. After you set a password, this item shows **Installed**.

To set a User Password:

1. Select the Change User Password item and press <Enter>.
2. On the password box that appears, type a password composed of at least six letters and/or numbers, then press <Enter>.
3. Confirm the password when prompted.

The message "Password Installed" appears after you set your password successfully.

To change the user password, follow the same steps as in setting a user password.

Password Check [Setup]

When set to [Setup], BIOS checks for user password when accessing the Setup utility. When set to [Always], BIOS checks for user password both when accessing Setup and booting the system.

Configuration options: [Setup] [Always]

4.7 Exit menu

The Exit menu items allow you to load the optimal or failsafe default values for the BIOS items, and save or discard your changes to the BIOS items.

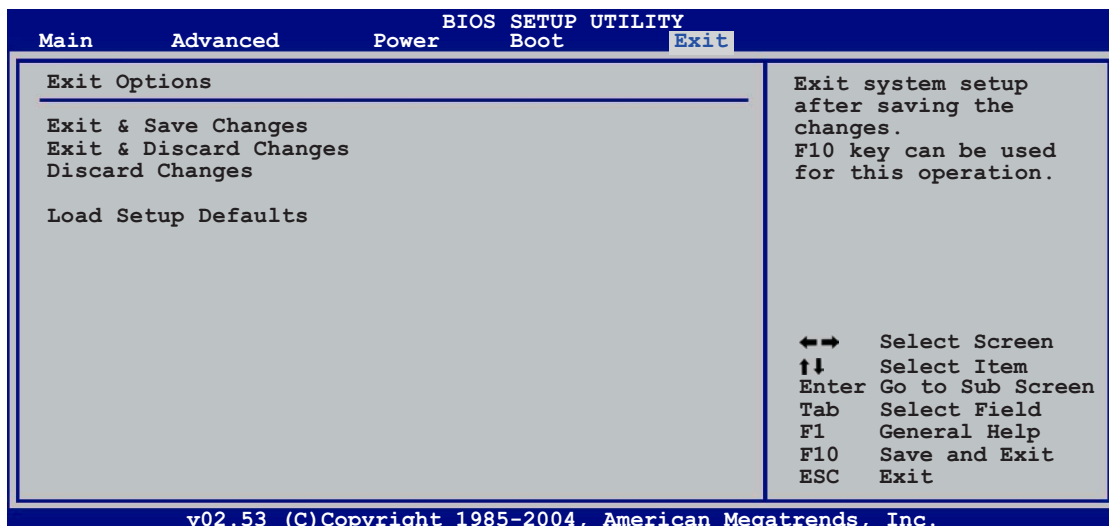

Pressing <Esc> does not immediately exit this menu. Select one of the options from this menu or <F10> from the legend bar to exit.

Exit & Save Changes

Once you are finished making your selections, choose this option from the Exit menu to ensure the values you selected are saved to the CMOS RAM. An onboard backup battery sustains the CMOS RAM so it stays on even when the PC is turned off. When you select this option, a confirmation window appears. Select **[Ok]** to save changes and exit.



If you attempt to exit the Setup program without saving your changes, the program prompts you with a message asking if you want to save your changes before exiting. Press <Enter> to save the changes while exiting.

Exit & Discard Changes

Select this option only if you do not want to save the changes that you made to the Setup program. If you made changes to fields other than System Date, System Time, and Password, the BIOS asks for a confirmation before exiting.

Discard Changes

This option allows you to discard the selections you made and restore the previously saved values. After selecting this option, a confirmation appears. Select **[Ok]** to discard any changes and load the previously saved values.

Load Setup Defaults

This option allows you to load the default values for each of the parameters on the Setup menus. When you select this option or if you press <F5>, a confirmation window appears. Select **[Ok]** to load default values. Select **Exit & Save Changes** or make other changes before saving the values to the non-volatile RAM.

This chapter describes the contents of the support CD that comes with the motherboard package.

5 Software support

5.1	Installing an operating system	5-1
5.2	Support CD information	5-1
5.3	Software information	5-8
5.4	RAID configurations	5-24
5.5	Creating a RAID driver disk	5-33

5.1 Installing an operating system

This motherboard supports Windows® 2000/XP operating systems (OS). Always install the latest OS version and corresponding updates to maximize the features of your hardware.



- Motherboard settings and hardware options vary. Use the setup procedures presented in this chapter for reference only. Refer to your OS documentation for detailed information.
- Make sure that you install Windows® 2000 Service Pack 4 or the Windows® XP Service Pack 1 or later versions before installing the drivers for better compatibility and system stability.

5.2 Support CD information

The support CD that came with the motherboard package contains the drivers, software applications, and utilities that you can install to avail all motherboard features.



The contents of the support CD are subject to change at any time without notice. Visit the ASUS website(www.asus.com) for updates.

5.2.1 Running the support CD

Place the support CD to the optical drive. The CD automatically displays the **Drivers** menu if Autorun is enabled in your computer.

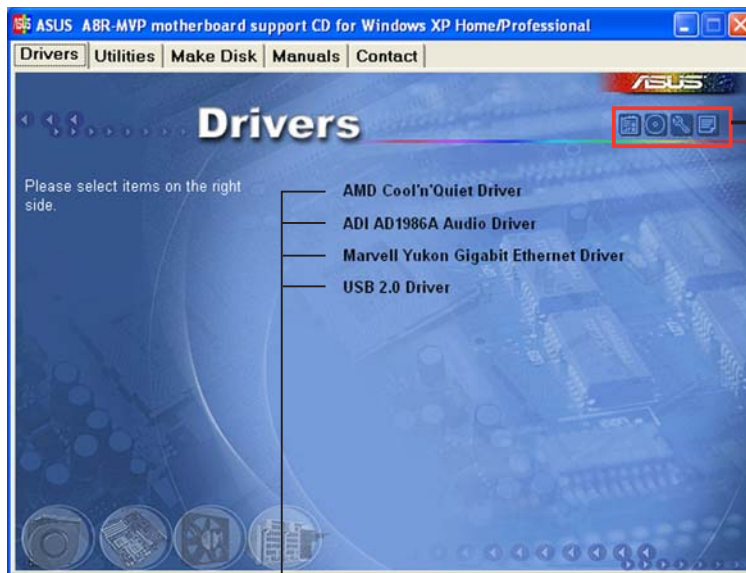

Click an icon to display support CD/motherboard information

Click an item to install



If **Autorun** is NOT enabled in your computer, browse the contents of the support CD to locate the file **ASSETUP.EXE** from the BIN folder. Double-click the **ASSETUP.EXE** to run the CD.

5.2.2 Drivers menu

The drivers menu shows the available device drivers if the system detects installed devices. Install the necessary drivers to activate the devices.

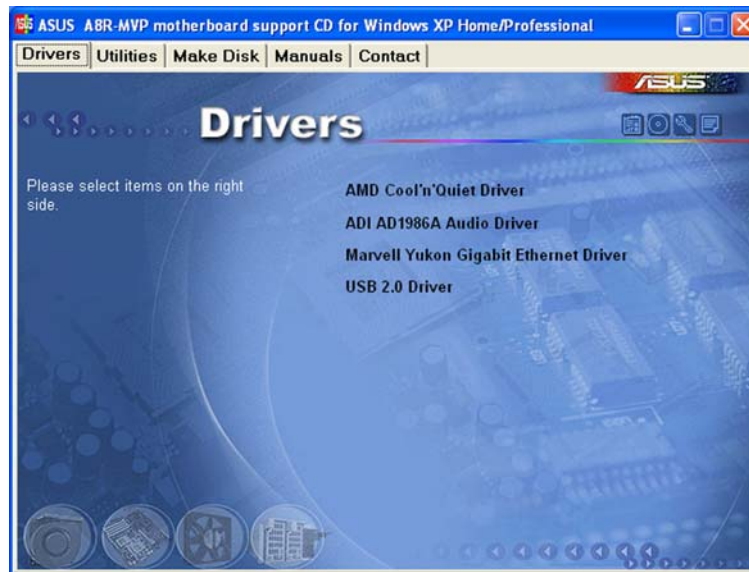

AMD Cool 'n' Quiet Driver

Installs the AMD Cool 'n' Quiet™ driver.

ADI 1986A Audio Driver

Executes the wizard to install the ADI SoundMAX® AD1986A audio driver and application.

Marvell Yukon Gigabit Driver

Installs the driver for the Marvell® Yukon™ 88E8001 PCI interface Gigabit LAN .

USB 2.0 Driver

Installs the USB 2.0 driver.



The screen display and drivers option may not be the same for different operating system versions.

5.2.3 Utilities menu

The Utilities menu shows the applications and other software that the motherboard supports.



Marvell Yukon VCT Application

The Virtual Cable Tester (VCT) is a cable diagnostic application that analyzes and reports LAN cable faults and shorts. See page 5-10 for details.

ASUS PC Probe II

This smart utility monitors the fan speed, CPU temperature, and system voltages, and alerts you of any detected problems. This utility helps you keep your computer in healthy operating condition.

ASUS Update

The ASUS Update utility that allows you to update the motherboard BIOS in Windows® environment. This utility requires an Internet connection either through a network or an Internet Service Provider (ISP). See section "4.1.1 ASUS Update utility" for details.



Before using the ASUS Update, make sure that you have an Internet connection so you can connect to the ASUS website.

ASUS Screen Saver

Bring life to your computer screen by installing the ASUS Screen Saver.

Adobe Acrobat Reader V7.0

Installs the Adobe® Acrobat® Reader that allows you to open, view, and print documents in Portable Document Format (PDF).

Microsoft DirectX 9.0c

Installs the Microsoft® DirectX® 9.0c driver. The Microsoft® DirectX® 9.0c is a multimedia technology that enhances computer graphics and sound. DirectX® improves the multimedia features of your computer so you can enjoy watching TV and movies, capturing videos, or playing games on your computer. Visit the Microsoft® website (www.microsoft.com) for updates.

ASUS Cool 'n' Quiet Utility

Installs the AMD Cool 'n' Quiet™ software.

Anti-virus utility

The anti-virus application scans, identifies, and removes computer viruses. View the online help for detailed information.



The screen display and utilities option may not be the same for different operating system versions.

5.2.4 Make Disk menu

The Make Disk menu contains the item needed to create the ULI Serial ATA/RAID driver disk.



Make ULi Chipset Driver Disk

Allows you to create the ULI chipset driver disk for Serial ATA and RAID features.

5.2.5 Manuals menu

The Manuals menu contains a list of supplementary user manuals. Click an item to open the folder of the user manual.



Most user manual files are in Portable Document Format (PDF). Install the Adobe® Acrobat® Reader from the **Utilities menu** before opening a user manual file.

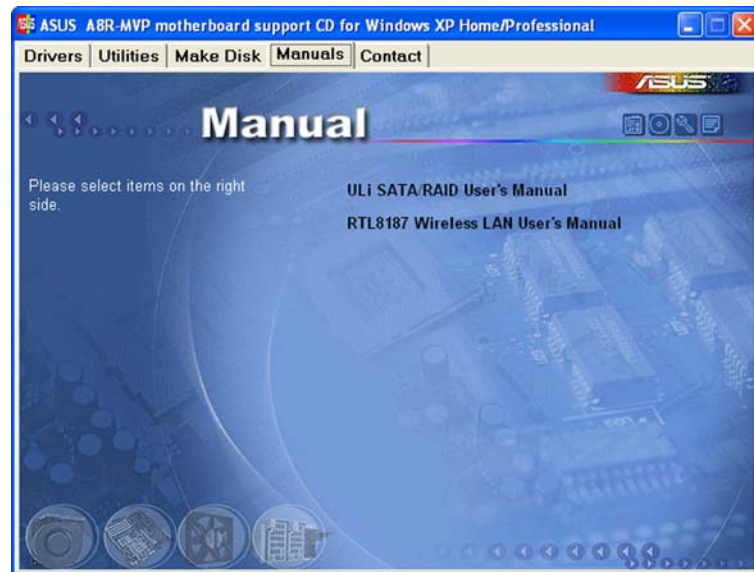

ULi SATA/RAID User's Manual

Allows you to open the ULI Serial ATA/RAID user's manual.

5.2.6 ASUS Contact information

Click the **Contact** tab to display the ASUS contact information. You can also find this information on the inside front cover of this user guide.

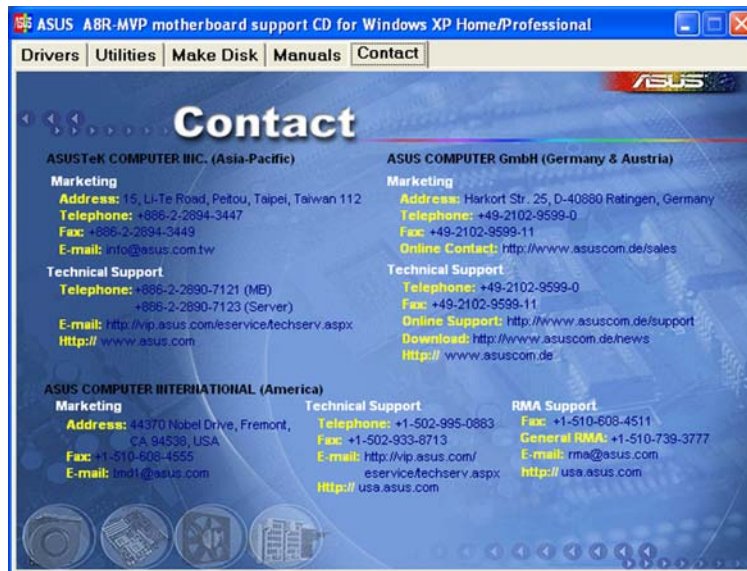

5.2.7 Other information

The icons on the top right corner of the screen give additional information on the motherboard and the contents of the support CD. Click an icon to display the specified information.

Motherboard Info

Displays the general specifications of the motherboard.

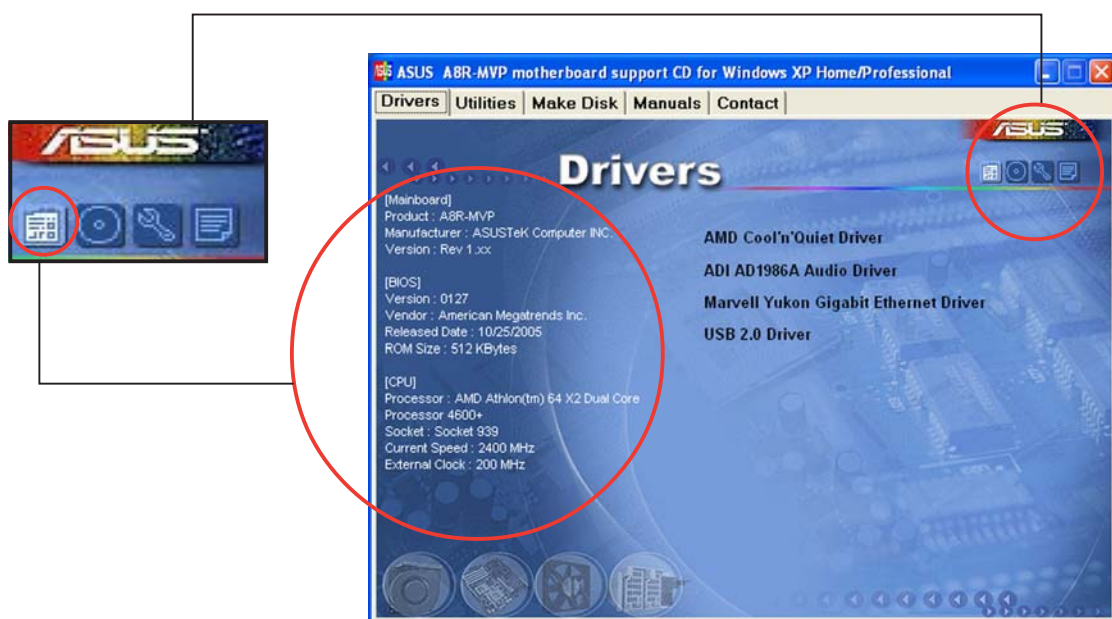

Browse this CD

Displays the support CD contents in graphical format.

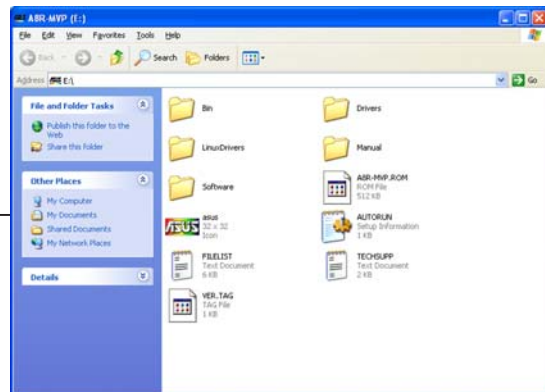
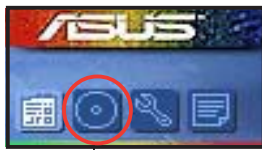

Technical support Form

Displays the ASUS Technical Support Request Form that you have to fill out when requesting technical support.

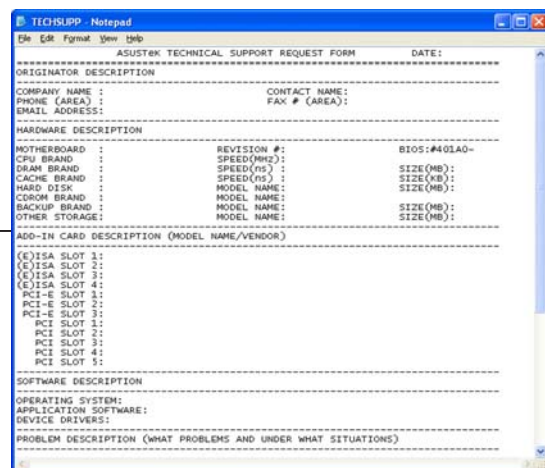
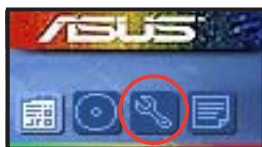

Filelist

Displays the contents of the support CD and a brief description of each in text format.

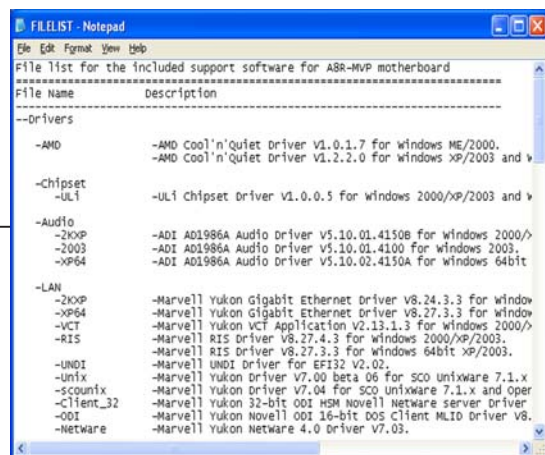
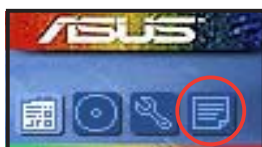

5.3 Software information

Most of the applications in the support CD have wizards that will conveniently guide you through the installation. View the online help or readme file that came with the software application for more information.

5.3.1 ASUS MyLogo™

The ASUS MyLogo™ utility lets you customize the boot logo. The boot logo is the image that appears on screen during the Power-On-Self-Tests (POST). The ASUS MyLogo™ is automatically installed when you install the **ASUS Update** utility from the support CD. See section “5.2.3 Utilities menu” for details.



- Before using the ASUS MyLogo™, use the AFUDOS utility to make a copy of your original BIOS file, or obtain the latest BIOS version from the ASUS website. See section “4.1.4 AFUDOS Utility.”
- Make sure that the BIOS item **Full Screen Logo** is set to [Enabled] if you wish to use ASUS MyLogo. See section “4.6.2 Boot Settings Configuration.”
- You can create your own boot logo image in GIF, JPG, or BMP file formats.

To launch the ASUS MyLogo™:

1. Launch the ASUS Update utility. Refer to section “4.1.1 ASUS Update utility” for details.
2. Select **Options** from the drop down menu, then click **Next**.
3. Check the option **Launch MyLogo to replace system boot logo before flashing BIOS**, then click **Next**.
4. Select **Update BIOS from a file** from the drop down menu, then click **Next**.
5. When prompted, locate the new BIOS file, then click **Next**. The ASUS MyLogo window appears.
6. From the left window pane, select the folder that contains the image you intend to use as your boot logo.



7. When the logo images appear on the right window pane, select an image to enlarge by clicking on it.

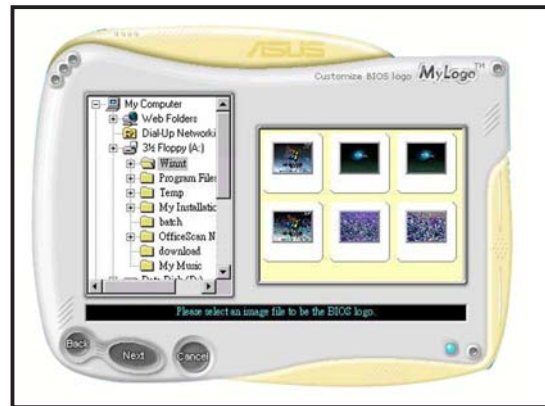

8. Adjust the boot image to your desired size by selecting a value on the **Ratio** box.



9. When the screen returns to the ASUS Update utility, flash the original BIOS to load the new boot logo.
10. After flashing the BIOS, restart the computer to display the new boot logo during POST.

5.3.2 Al Net 2

The Marvell® Virtual Cable Tester™ (VCT) is a cable diagnostic utility that reports LAN cable faults and shorts using the Time Domain Reflectometry (TDR) technology. The VCT detects and reports open and shorted cables, impedance mismatches, pair swaps, pair polarity problems, and pair skew problems of up to 64 ns at one meter accuracy.

The VCT feature reduces networking and support costs through a highly manageable and controlled network system. This utility can be incorporated in the network systems software for ideal field support as well as development diagnostics.

Using the Virtual Cable Tester™

To use the the Marvell® Virtual Cable Tester™ utility:

1. Launch the VCT utility from the Windows® desktop by clicking **Start > All Programs > Marvell > Virtual Cable Tester**.
2. Click **Virtual Cable Tester** from the menu to display the screen below.

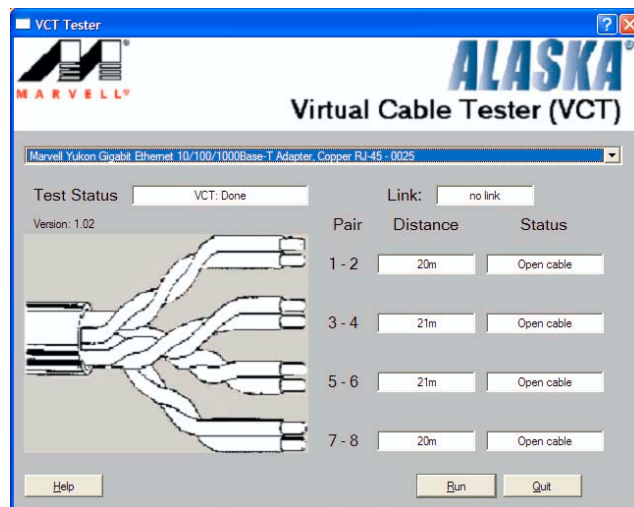

3. Click the **Run** button to perform a cable test.



- The VCT only runs on systems with Windows® XP or Windows® 2000 operating systems.
- The VCT utility only tests Ethernet cables connected to Gigabit LAN port(s).
- The **Run** button on the Virtual Cable Tester™ main window is disabled if no problem is detected on the LAN cable(s) connected to the LAN port(s).
- If you want the system to check the LAN cable before entering the OS, enable the **POST Check LAN cable** item in the BIOS.

5.3.3 ASUS PC Probe II

PC Probe II is a utility that monitors the computer's vital components, and detects and alerts you of any problem with these components. PC Probe II senses fan rotations, CPU temperature, and system voltages, among others. Because PC Probe II is software-based, you can start monitoring your computer the moment you turn it on. With this utility, you are assured that your computer is always at a healthy operating condition.

Installing PC Probe II

To install PC Probe II on your computer:

1. Place the support CD to the optical drive. The **Drivers** installation tab appears if your computer has an enabled Autorun feature.



If Autorun is not enabled in your computer, browse the contents of the support CD to locate the setup.exe file from the ASUS PC Probe II folder. Double-click the setup.exe file to start installation.

2. Click the **Utilities** tab, then click **ASUS PC Probe II**.
3. Follow the screen instructions to complete installation.

Launching PC Probe II

You can launch the PC Probe II right after installation or anytime from the Windows® desktop.

To launch the PC Probe II from the Windows® desktop, click **Start > All Programs > ASUS > PC Probe II > PC Probe II v1.00.43**. The PC Probe II main window appears.

After launching the application, the PC Probe II icon appears in the Windows® taskbar. Click this icon to close or restore the application.









Using PC Probe II

Main window

The PC Probe II main window allows you to view the current status of your system and change the utility configuration. By default, the main window displays the **Preference** section. You can close or restore the **Preference** section by clicking on the triangle on the main window right handle.



Click to close the Preference panel

Button	Function
	Opens the Configuration window
	Opens the Report window
	Opens the Desktop Management Interface window
	Opens the Peripheral Component Interconnect window
	Opens the Windows Management Instrumentation window
	Opens the hard disk drive, memory, CPU usage window
	Shows/Hides the Preference section
	Minimizes the application
	Closes the application

Sensor alert

When a system sensor detects a problem, the main window right handle turns red, as the illustrations below show.

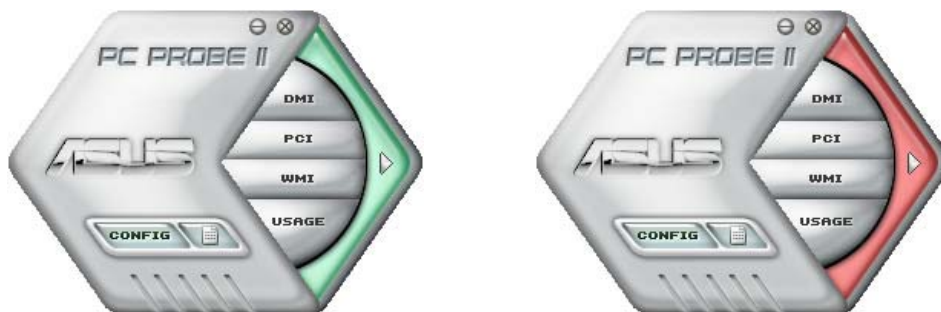

When displayed, the monitor panel for that sensor also turns red. Refer to the **Monitor panels** section for details.

Preferences

You can customize the application using the Preference section in the main window. Click the box before each preference to activate or deactivate.

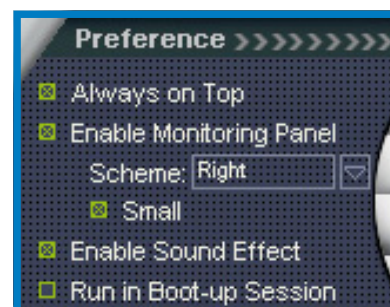

Hardware monitor panels

The hardware monitor panels display the current value of a system sensor such as fan rotation, CPU temperature, and voltages.

The hardware monitor panels come in two display modes: hexagonal (large) and rectangular (small). When you check the **Enable Monitoring Panel** option from the **Preference** section, the monitor panels appear on your computer's desktop.



Large display



Small display

Changing the monitor panels position

To change the position of the monitor panels in the desktop, click the arrow down button of the **Scheme** options, then select another position from the list box. Click **OK** when finished.

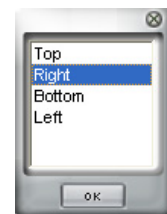

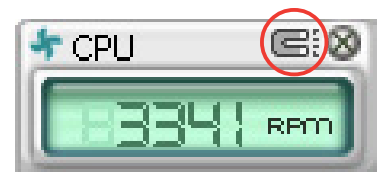

Moving the monitor panels

All monitor panels move together using a magnetic effect. If you want to detach a monitor panel from the group, click the horseshoe magnet icon. You can now move or reposition the panel independently.



Adjusting the sensor threshold value

You can adjust the sensor threshold value in the monitor panel by clicking the  or  buttons. You can also adjust the threshold values using the **Config** window.

You cannot adjust the sensor threshold values in a small monitoring panel.

Click to increase value

Click to decrease value



Monitoring sensor alert

The monitor panel turns red when a component value exceeds or is lower than the threshold value. Refer to the illustrations below.



Large display



Small display

WMI browser

Click **WMI** to display the WMI (Windows Management Instrumentation) browser. This browser displays various Windows® management information. Click an item from the left panel to display on the right panel. Click the plus sign (+) before **WMI Information** to display the available information.

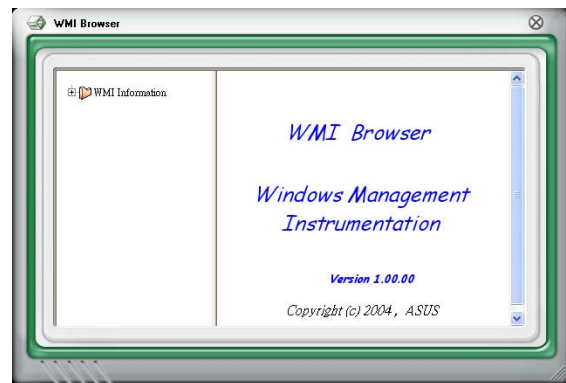

You can enlarge or reduce the browser size by dragging the bottom right corner of the browser.

DMI browser

Click **DMI** to display the DMI (Desktop Management Interface) browser. This browser displays various desktop and system information. Click the plus sign (+) before **DMI Information** to display the available information.



PCI browser

Click **PCI** to display the PCI (Peripheral Component Interconnect) browser. This browser provides information on the PCI devices installed on your system. Click the plus sign (+) before the **PCI Information** item to display available information.

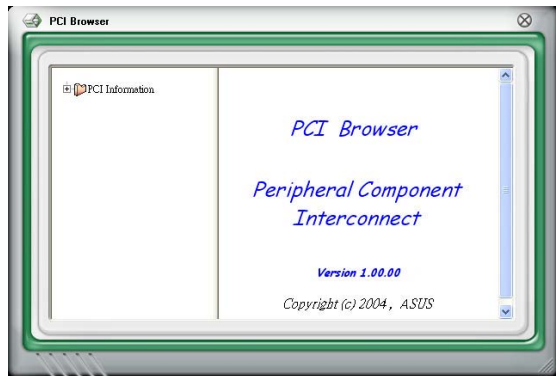

Usage

The **Usage** browser displays real-time information on the CPU, hard disk drive space, and memory usage. Click **USAGE** to display the Usage browser.

CPU usage

The **CPU** tab displays real-time CPU usage in line graph representation. If the CPU has an enabled Hyper-Threading, two separate line graphs display the operation of the two logical processors.

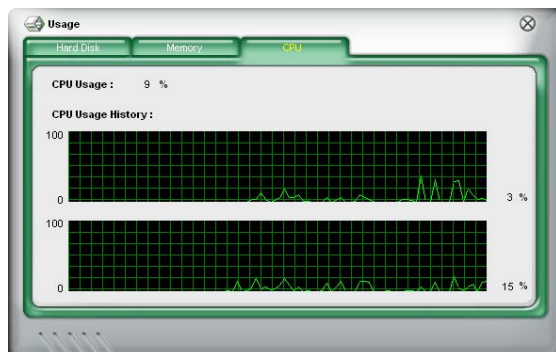

Hard disk drive space usage

The **Hard Disk** tab displays the used and available hard disk drive space. The left panel of the tab lists all logical drives. Click a hard disk drive to display the information on the right panel. The pie chart at the bottom of the window represents the used (blue) and the available HDD space.



Memory usage

The Memory tab shows both used and available physical memory. The pie chart at the bottom of the window represents the used (blue) and the available physical memory.

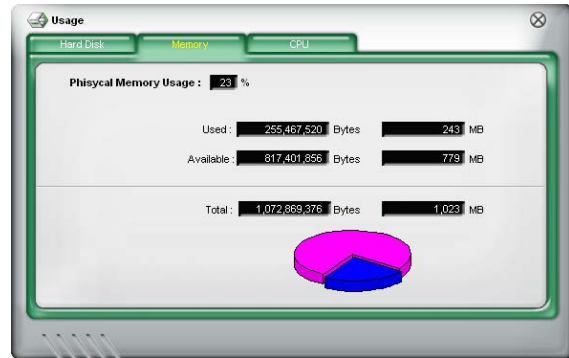

Configuring PC Probe II

Click **CONFIG** to view and adjust the sensor threshold values.

The **Config** window has two tabs: **Sensor/Threshold** and **Preference**. The **Sensor/Threshold** tab enables you to activate the sensors or to adjust the sensor threshold values. The **Preference** tab allows you to customize sensor alerts, or change the temperature scale.

Enabled	Sensor Name	Nominal Value	Current Value	Threshold
<input checked="" type="checkbox"/>	CPU		43	60 °C
<input checked="" type="checkbox"/>	MB		34	45 °C

Default: Loads the default threshold values for each sensor

Apply: Applies your changes

Cancel: Cancels or ignores your changes

Save As: Saves your configuration

Load: Loads your saved configuration

5.3.4 Cool 'n' Quiet™ Technology

The motherboard supports the AMD Cool 'n' Quiet™ Technology that dynamically and automatically change the CPU speed, voltage, and amount of power depending on the task the CPU performs.

Enabling Cool 'n' Quiet™ Technology

To enable Cool 'n' Quiet™ Technology:

1. Turn on the system and enter BIOS by pressing the key during the Power On Self-Tests (POST).
2. Go to the **Advanced Menu -> CPU Configuration**, select the item **Cool 'n'Quiet** and set it to **Enabled**. See section "4.4.2 CPU Configuration."
3. In the **Power** menu, select the item **ACPI 2.0 Support** and set it to **Yes**. See section "4.5 Power Menu."
4. Save your changes and exit BIOS Setup.
5. Reboot your computer and set your Power Options Properties depending on your operating system.



The Cool 'n' Quiet™ Technology item is set to [Disabled] by default in the BIOS.

Windows® 2000/XP

1. From the Windows® 2000/XP operating system, click the **Start** button. Select **Settings**, then **Control Panel**.
2. Make sure the Control Panel is set to Classic View.
3. Double-click the **Display** icon in the Control Panel then select the **Screen Saver** tab.
4. Click the **Power...** button. The following dialog box appears.
5. From the **Power schemes** combo list box, select **Minimal Power Management**.
6. Click **OK** to effect settings.

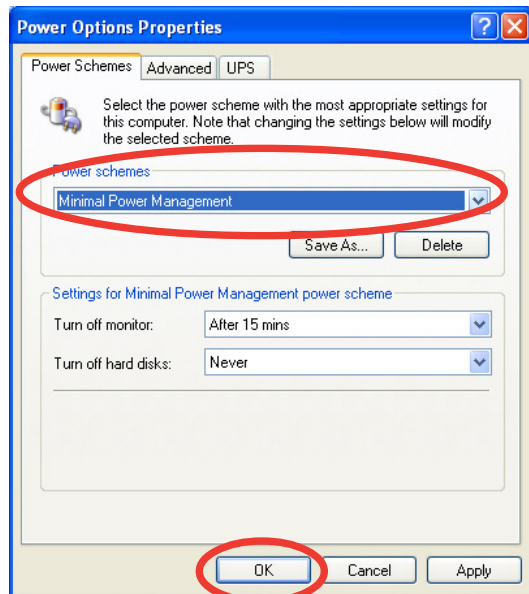

Make sure to install the Cool 'n' Quiet™ driver and application before using this feature.

Launching the Cool 'n' Quiet™ software

The motherboard support CD includes the Cool 'n' Quiet!™ software that enables you to view your system's real-time CPU Frequency and voltage.



Make sure to install the Cool 'n' Quiet™ software from the motherboard support CD. Refer to section "5.2.3 Utilities menu" for details.

To launch the Cool 'n' Quiet™ program:

1. If you are using Windows® 2000, click the **Start** button. Select **Programs-> ASUS -> Cool & Quiet -> Cool & Quiet.**
2. If you are using Windows® XP, click the **Start** button. Select **All Programs-> ASUS -> Cool & Quiet -> Cool & Quiet.**
3. The Cool 'n' Quiet!™ technology screen appears and displays the current CPU Frequency and CPU Voltage.

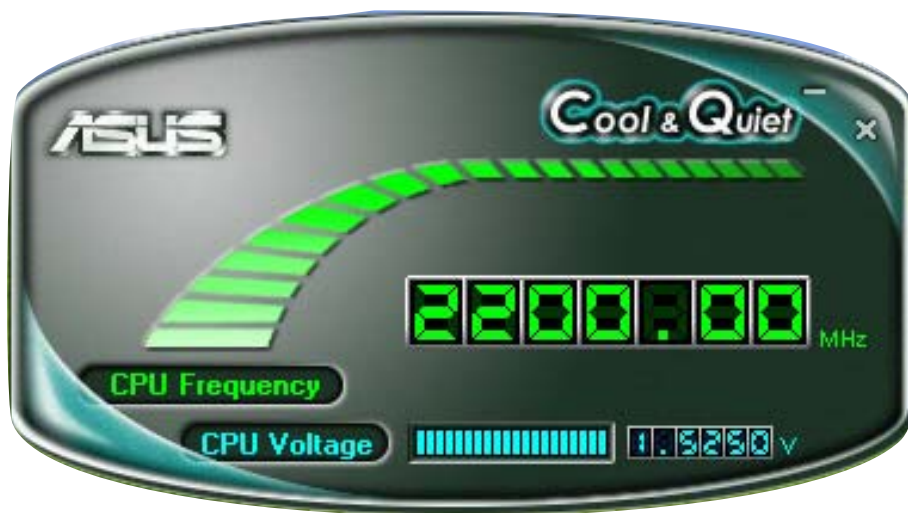

5.3.5 SoundMAX® High Definition Audio utility

The ADI AD1986 High Definition Audio CODEC provides 6-channel audio capability through the SoundMAX® audio utility with AudioESP™ software to deliver the ultimate audio experience on your PC. The software implements high quality audio synthesis/rendering, 3D sound positioning, and advanced voice-input technologies.



Follow the installation wizard to install the **ADI AD1986A Audio Driver** from the support CD that came with the motherboard package to activate the SoundMAX® audio utility.

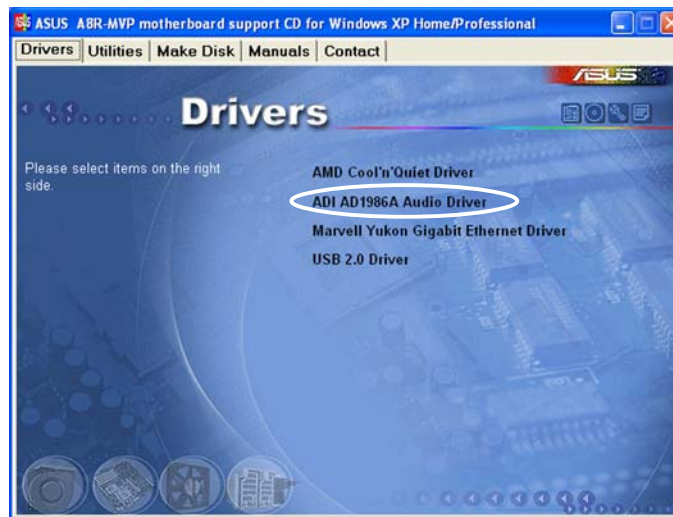

- You must use 4-channel or 6-channel speakers for this setup.
- SoundMAX® requires Microsoft® Windows® 2000/XP. Make sure that one of these operating systems is installed before installing SoundMAX®.

If the SoundMAX® audio utility is correctly installed, you will find the SoundMAX® icon on the taskbar.



From the taskbar, double-click on the **SoundMAX®** icon to display the **SoundMAX® Control Panel**.



Audio Setup Wizard

By clicking the  icon from the SoundMAX® control panel, you can easily configure your audio settings. Simply follow succeeding screen instructions and begin enjoying High Definition Audio.



Jack configuration

This screen helps you configure your computer's audio ports, depending on the audio devices you have installed.

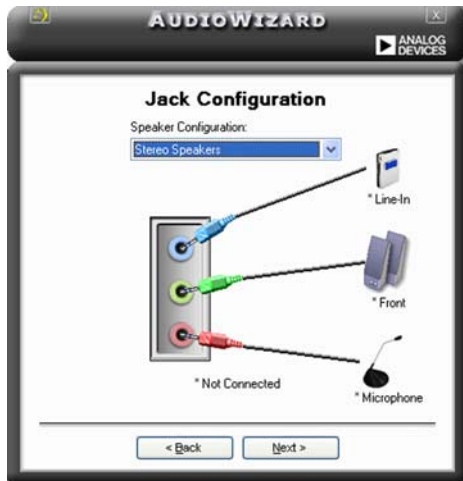

Adjust speaker volume

This screen helps you adjust speaker volume. Click the **Test** button to hear the changes you have made.



Adjust microphone volume

This screen helps you adjust microphone volume. You will be asked to read pre-written text to allow the AudioWizard to adjust the volume as you speak.



Audio preferences

Click the  icon to go to the **Preferences** page. This page allows you to change various audio settings.

General options

Click the **General** tab to choose your playback and recording devices, enable/disable the AudioESP™ feature, and enable/disable digital output.

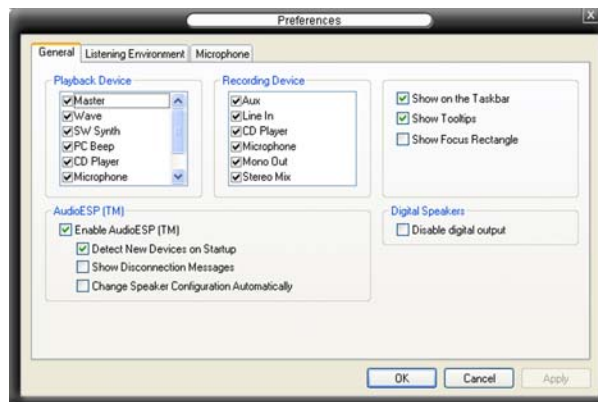

Listening Environment options

Click the **Listening Environment** tab allows you to optimize your audio listening environment. You can setup your speakers, choose from different acoustic environments, and enable/disable the Virtual Theater™ Surround, which can create virtual speakers through your stereo setup.

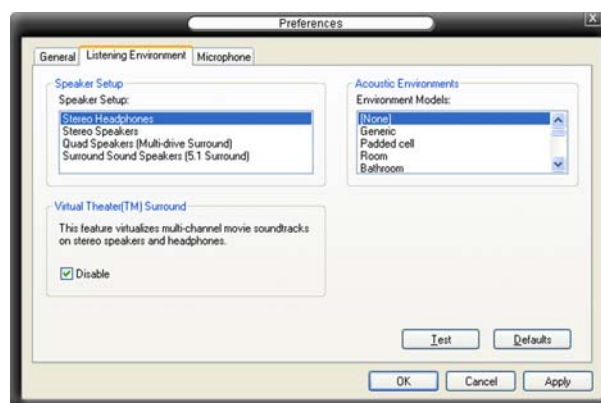

Microphone options

Click the **Listening Environment** tab allows you to optimize your microphone input settings.

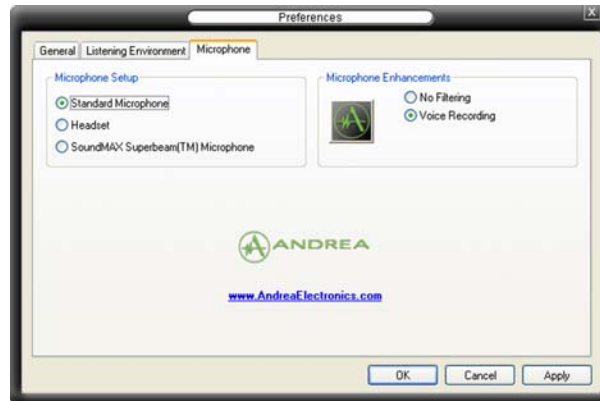

5.4 RAID configurations

The motherboard comes with a RAID controller integrated in the ULI M1575 Southbridge that allows you to configure Serial ATA hard disk drives as RAID sets. The motherboard supports the following RAID configurations.

RAID 0 (*Data striping*) optimizes two identical hard disk drives to read and write data in parallel, interleaved stacks. Two hard disks perform the same work as a single drive but at a sustained data transfer rate, double that of a single disk alone, thus improving data access and storage. Use of two new identical hard disk drives is required for this setup.

RAID 1 (*Data mirroring*) copies and maintains an identical image of data from one drive to a second drive. If one drive fails, the disk array management software directs all applications to the surviving drive as it contains a complete copy of the data in the other drive. This RAID configuration provides data protection and increases fault tolerance to the entire system. Use two new drives or use an existing drive and a new drive for this setup. The new drive must be of the same size or larger than the existing drive.

RAID 0+1 is *data striping* and *data mirroring* combined without parity (redundancy data) having to be calculated and written. With the RAID 0+1 configuration you get all the benefits of both RAID 0 and RAID 1 configurations. Use four new hard disk drives or use an existing drive and three new drives for this setup.

RAID 5 stripes both data and parity information across three or more hard disk drives. Among the advantages of RAID 5 configuration include better HDD performance, fault tolerance, and higher storage capacity. The RAID 5 configuration is best suited for transaction processing, relational database applications, enterprise resource planning, and other business systems. Use a minimum of three identical hard disk drives for this setup.

JBOD (*Spanning*) stands for **Just a Bunch of Disks** and refers to hard disk drives that are not yet configured as a RAID set. This configuration stores the same data redundantly on multiple disks that appear as a single disk on the operating system. Spanning does not deliver any advantage over using separate disks independently and does not provide fault tolerance or other RAID performance benefits.

5.4.1 Installing hard disks

The motherboard supports Ultra DMA 133/100/66 and Serial ATA hard disk drives. For optimal performance, install identical drives of the same model and capacity when creating a disk array.

Installing Serial ATA (SATA) hard disks

To install the SATA hard disks for a RAID configuration:

1. Install the SATA hard disks into the drive bays.
2. Connect the SATA signal cables.
3. Connect a SATA power cable to the power connector on each drive.

5.4.2 ULI® RAID configurations

The ULI® RAID controller supports RAID 0, RAID 1, RAID 0+1, RAID 5, and JBOD configurations. Use the ULI® RAID BIOS Setup utility to configure a disk array.



You may also set the RAID configurations in Windows® OS after you have installed the Serial ATA RAID driver. See section “5.2.4 Make Disk menu” for details.

Entering the ULI® RAID BIOS Setup Utility

To enter the ULI® RAID BIOS setup utility:

1. Boot up your computer, and press during POST to enter the BIOS setup.
2. In the **Main Menu**, go to **Storage Configuration**, and set the **Onboard SATA Boot ROM** item to [Enabled].
3. Press <F10> to save the changes and exit.
4. During POST, press <Ctrl+A>.



The RAID BIOS setup screens shown in this section are for reference only, and may not exactly match the items on your screen.

```

RAID BIOS Setup Utility (c) 2005 ULI Electronics Inc. www.uli.com.tw

Create RAID 0 Striping x2 for Performance
Create RAID 1 Mirroring for Reliability
Create RAID 0+1 Striping, Mirroring
Create JBOD for integrated Capacity
Stripe Size 16K
Delete RAID Settings & Partition
Delete All RAID Settings & Partition
Rebuild RAID Array
Create RAID 5 for Reliability

SPACE: Select
↑↓ : Moving Cursor
Enter: Select & Finish
ESC: Exit

Channel 0 Master: XXXXXXXXXXXX SATA 2 XXXXX MB
Channel 1 Master: XXXXXXXXXXXX SATA 2 XXXXX MB
Channel 2 Master: XXXXXXXXXXXX SATA 2 XXXXX MB
Channel 3 Master: XXXXXXXXXXXX SATA 2 XXXXX MB

Capacity RAID Type Stripe Size RAID Name
RAID Array A :
RAID Array B :
RAID Array C :

```

The Main Menu on the upper left side allows you to select an operation to perform. The Main Menu options include:

Create RAID 0 Striping x2 for Performance - creates a new legacy RAID set or allocates spare drives.

Create RAID 0+1 for Striping, Mirroring - creates a RAID setup with all the benefits of both RAID 0 and RAID 1 configuration.

Create JBOD for integrated capacity - creates a JBOD configuration.

Stripe Size - sets the stripe size.

Delete RAID Settings & Partition - deletes a selected RAID set and partition.

Delete All RAID Settings & Partition - deletes all current RAID set(s) and partition(s).

Rebuild RAID array - rebuilds mirror drive(s).

Create RAID 5 for Reliability - creates a RAID 5 configuration

On the upper right side of the screen is the legend box. The keys on the legend box allow you to navigate through the setup menu options. The following lists the keys in the legend box and their corresponding functions.

- SPACE** : Select an item
- ↑, ↓** : Move cursor to the next item
- Enter** : Confirms a selected item
- ESC** : Exit

Creating a RAID 0 configuration

To create a RAID 0 set:

1. From the ULI RAID BIOS Setup utility menu, move the cursor to **Create RAID 0 Striping for Performance** then press <Enter>.
2. Use the up or down arrow keys to select a drive then press <Space> or <Enter>. The striped mark “S” appears before a selected drive.
3. Repeat step 2 to select the second drive.
4. The utility prompts the following warning message:

```
Data on RAID drives will be deleted (Y/N)?
```

Press <Y> to continue or press <N> to return to the menu.

5. Key in a RAID name with a maximum of eight (8) alphanumeric characters then press <Enter>. Do not use special characters or symbols.
6. The utility displays the RAID Array settings at the bottom of the screen.

Channel	Master	Drive Model	Mode	Capacity	RAID Array/Type
Channel 0	Master	XXXXXXXXXX	SATA 2	XXXXX MB	RAID A/0x2
Channel 1	Master	XXXXXXXXXX	SATA 2	XXXXX MB	
Channel 2	Master	XXXXXXXXXX	SATA 2	XXXXX MB	RAID A/0x2
Channel 3	Master	XXXXXXXXXX	SATA 2	XXXXX MB	

	Capacity	RAID Type	Stripe Size	RAID Name
RAID Array A	: XXXXX GB	0X2	16K	RAID0
RAID Array B	:			
RAID Array C	:			

Creating a RAID 0+1 configuration

To create a RAID 0+1 set:

1. From the ULI RAID BIOS Setup utility menu, move the cursor to **Create RAID 0+1 Striping, Mirroring** then press <Enter>.
2. The utility prompts the following warning message:

```
Data on first 4 drives will be deleted (Y/N)?
```

Press <Y> to continue or press <N> to return to the menu.

3. Key in a RAID name with a maximum of eight (8) alphanumeric characters then press <Enter>. Do not use special characters or symbols.
4. The utility displays the RAID Array settings at the bottom of the screen.

Channel	Drive Model	Mode	Capacity	RAID Array/Type
Channel 0 Master:	XXXXXXXXXX	SATA 2	XXXXX MB	RAID A/RAID0+1
Channel 1 Master:	XXXXXXXXXX	SATA 2	XXXXX MB	RAID A/RAID0+1
Channel 2 Master:	XXXXXXXXXX	SATA 2	XXXXX MB	RAID A/RAID0+1
Channel 3 Master:	XXXXXXXXXX	SATA 2	XXXXX MB	RAID A/RAID0+1

	Capacity	RAID Type	Stripe Size	RAID Name
RAID Array A :	XXXXX MB	0+1 X4		RAID01
RAID Array B :				
RAID Array C :				

Creating a JBOD configuration

To create a JBOD set:

1. From the ULI RAID BIOS Setup utility menu, move the cursor to **Create JBOD for integrated capacity** then press <Enter>.
2. Use the up or down arrow keys to select a drive then press <Space> or <Enter>. The striped mark “J” appears before a selected drive.
3. Repeat step 2 to select the second drive.
4. The utility prompts the following warning message:

```
Data on RAID drives will be deleted (Y/N)?
```

Press <Y> to continue or press <N> to return to the menu.

5. Key in a RAID name with a maximum of eight (8) alphanumeric characters then press <Enter>. Do not use special characters or symbols.
6. The utility displays the RAID Array settings at the bottom of the screen.

	Drive Model	Mode	Capacity	RAID Array/Type
Channel 0 Master:	XXXXXXXXXXXX	SATA 2	XXXXX MB	RAID A/JBOD
Channel 1 Master:	XXXXXXXXXXXX		XXXXX MB	
Channel 2 Master:	XXXXXXXXXXXX	SATA 2	XXXXX MB	RAID A/JBOD
Channel 3 Master:	XXXXXXXXXXXX	SATA 2	XXXXX MB	

	Capacity	RAID Type	Stripe Size	RAID Name
RAID Array A :	XXXXX MB	JBOD		RAIDJ
RAID Array B :				
RAID Array C :				

Setting the Stripe Size

To set the stripe size:

1. From the ULI RAID BIOS Setup utility menu, move the cursor to **Stripe Size** then press <Enter>.
2. Use the up or down arrow keys to select a stripe size then press <Enter>.
3. The stripe size is displayed beside the Stripe Size menu item.



TIP: For server systems, we recommend using a lower array block size. For multimedia computer systems used mainly for audio and video editing, we recommend a higher array block size for optimum performance.

Deleting a RAID configuration

To delete a RAID set:

1. From the ULI RAID BIOS Setup utility menu, move the cursor to **Delete RAID Settings & Partition** then press <Enter>.
2. Use the up or down arrow keys to select a RAID set then press <Space> or <Enter>. The striped mark “E” appears before a selected drive.
3. The utility prompts the following warning message:

```
Data on RAID drives will be deleted (Y/N)?
```

Press <Y> to continue or press <N> to return to the menu.

Pressing <Y> removes the deleted RAID Array item from the list at the bottom of the screen.

Deleting All RAID configurations

To delete all RAID sets:

1. From the ULI RAID BIOS Setup utility menu, move the cursor to **Delete All RAID Settings & Partition** then press <Enter>.
2. The utility prompts the following warning message:

```
Data on RAID drives will be deleted (Y/N)?
```

Press <Y> to continue or press <N> to return to menu.

Pressing <Y> removes all the RAID Array items from the list at the bottom of the screen.

Rebuilding a RAID array

This option allows you to rebuild an existing RAID array.

To rebuild a RAID array:

1. From the ULI RAID BIOS Setup utility menu, move the cursor to **Rebuild RAID Array** then press <Enter>.
2. Use the up or down arrow keys to select the source drive from which to rebuild then press <Enter>. The striped mark “R” appears before a selected drive.
3. The utility prompts if you want to proceed with rebuilding the array. Press <Y> to continue or press <N> to return to the menu.

Creating a RAID 5 configuration

To create a RAID 5 set:

1. From the ULI RAID BIOS Setup utility menu, move the cursor to **Create RAID 5 for Reliability** then press <Enter>.
2. Use the up or down arrow keys to select a drive then press <Space> or <Enter>. The striped mark “5” appears before a selected drive.
3. Repeat step 2 to select the second and third drives.
4. The utility prompts the following warning message:

```
Data on RAID drives will be deleted (Y/N)?
```

Press <Y> to continue or press <N> to return to the menu.

5. Key in a RAID name with a maximum of eight (8) alphanumeric characters then press <Enter>. Do not use special characters or symbols.
6. The utility displays the RAID Array settings at the bottom of the screen.

	Drive Model	Mode	Capacity	RAID Array/Type
Channel 0 Master:	XXXXXXXXXXXX	SATA 2	XXXXX MB	RAID A/5
Channel 1 Master:	XXXXXXXXXXXX		XXXXX MB	
Channel 2 Master:	XXXXXXXXXXXX	SATA 2	XXXXX MB	RAID A/5
Channel 3 Master:	XXXXXXXXXXXX	SATA 2	XXXXX MB	RAID A/5

	Capacity	RAID Type	Stripe Size	RAID Name
RAID Array A :	160 GB	5	16K	RAID5
RAID Array B :				
RAID Array C :				

5.5 Creating a RAID driver disk

A floppy disk with the RAID driver is required when installing Windows® 2000/XP operating system on a hard disk drive that is included in a RAID set.

To create a RAID driver disk:

1. Boot your computer.
2. Press during POST to enter the BIOS setup utility.
3. Set the optical drive as the primary boot device.
4. Save changes and exit BIOS.
5. Insert the support CD into the optical drive.
6. Press the any key when the system prompts “Press any key to boot from the optical drive.” The following menu appears:

```
1) Make ULi RAID Driver Disk
2) Format Floppy Disk
3) FreeDOS command prompt
Please choose 1 ~ 3: _
```

7. Press <1> to create a RAID driver disk.
8. Insert a formatted floppy disk into the floppy drive then press <Enter>.
9. Follow succeeding screen instructions to complete the process.

- OR -

1. Start Windows® .
2. Place the motherboard support CD into the optical drive.
3. When the **Drivers** menu appears, click **Make ULi Chipset Driver Disk** to create a ULI RAID driver disk.
4. Insert a floppy disk into the floppy disk drive.
5. Follow succeeding screen instructions to complete the process.



Write-protect the floppy disk to avoid computer virus infection.

To install the RAID driver:

1. During the OS installation, the system prompts you to press the F6 key to install third-party SCSI or RAID driver.
2. Press <F6> then insert the floppy disk with RAID driver into the floppy disk drive.
3. Follow the succeeding screen instructions to complete the installation.

This chapter tells how to install CrossFire™ graphics cards to avail of ATI's Multi-Video Processing technology.

ATI® MVP technology support

Chapter summary



6.1	Overview	6-1
6.2	Hardware installation	6-2
6.3	Software information	6-6

6.1 Overview

The motherboard supports the ATI® MVP (Multi-Video Processing) technology that allows you to install multi-graphics processing units (GPU) graphics cards. Follow the installation procedures in this section.

Requirements

- CrossFire™ Edition graphics card (Master)
- CrossFire™-ready graphics card (Slave)
- CrossFire™-ready motherboard, such as the ASUS A8R-MVP motherboard.
- Make sure that your power supply unit (PSU) can provide at least the minimum power required by your system. See “6. Power connectors” on page 2-24 for details.



-
- Visit the ATI website or download the Radeon® X850 Crossfire™ Edition User's Guide from the support CD for detailed hardware requirements and installation procedures.
 - The ATI CrossFire™ technology supports only the following operating systems:
 - Windows® XP 32-bit (Home or Professional) with Service Pack 2 (SP2)
 - Windows® XP Professional 64-bit Edition.
 - Make sure that your graphics card driver supports the ATI CrossFire™ Technology. Download the latest driver from the ATI website (www.ati.com)
 - The maximum resolution of Radeon™ X850 CrossFire™ Edition is 1600 x 1200 at 65 MHz when you use DVI output.
-

Before you begin

Uninstall other graphics card drivers in your system

To uninstall other graphics card drivers:

1. Close all current applications.
2. Go to **Control Panel > Add/Remove Programs**.
3. Select your current graphics card driver/s.
4. Select **Add/Remove**.
5. Restart your system.

6.2 Hardware installation

6.2.1 Installing a single graphics card

1. Install a PCI Express x16 graphics card on the blue slot.

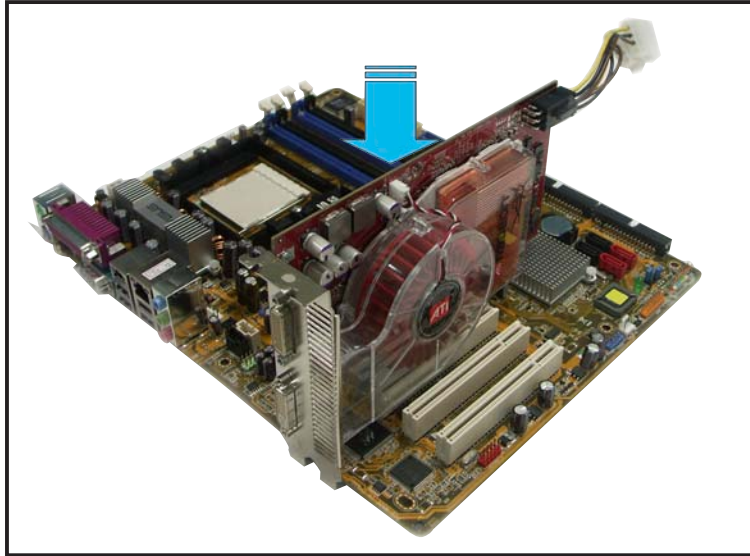

To avail of the card full x16 bandwidth, install the ASUS MVP Switch Card on the black slot; otherwise, the card will run only at x8 speed.

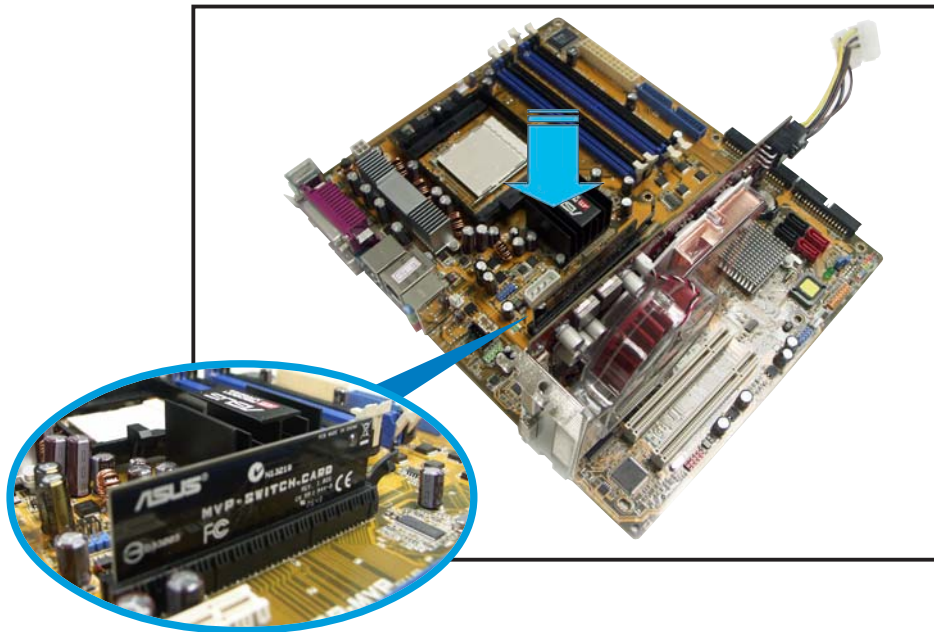

2. Connect one end of the external cable to the graphics card.
3. Connect the loose end to the corresponding port on your monitor.
4. Connect an auxiliary power source from the power supply to the graphics card.

6.2.2 Installing CrossFire™ graphics cards



Before installing a CrossFire™ system, refer to the user guide that came with the ATI CrossFire™ Edition graphics card.

To install the graphics cards:

1. Remove the MVP Switch Card if one is installed.
2. Prepare one CrossFire™ Edition graphics card, which will serve as the Master graphics card, and one CrossFire™-ready graphics card, which will serve as the Slave graphics card.

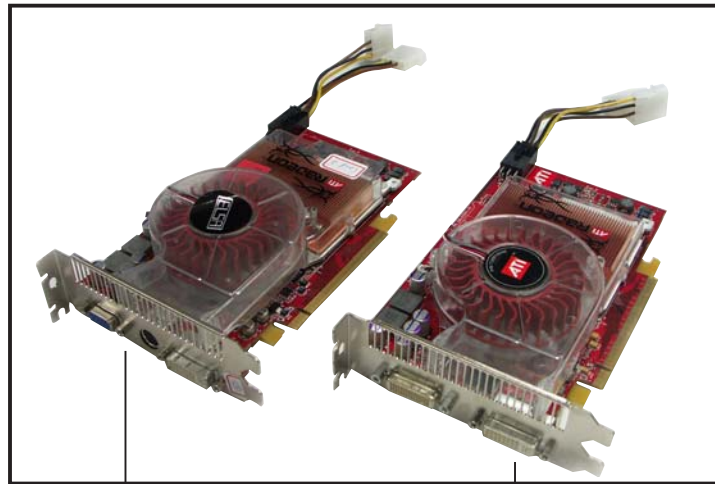

Slave graphics card

Master graphics card

3. Insert the CrossFire™-ready (Slave) graphics card into the black slot. Make sure that the card is properly seated on the slot.

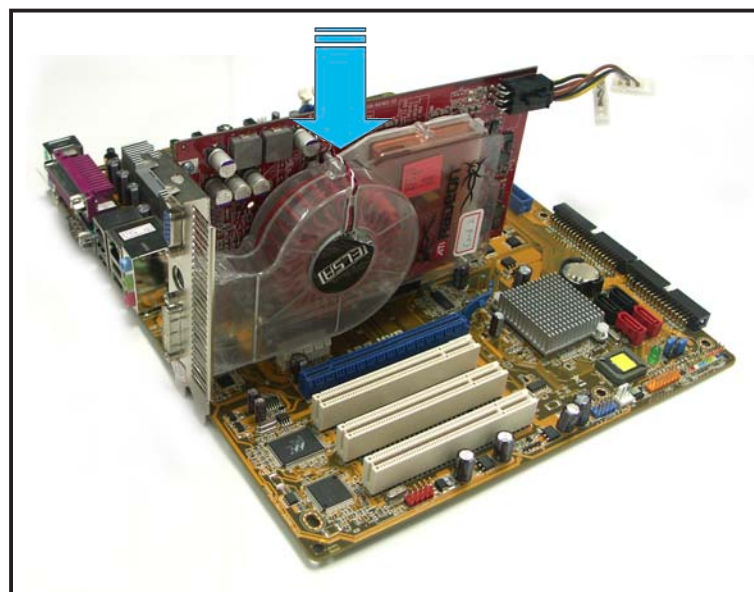

4. Insert the CrossFire™ Edition (Master) graphics card into the blue slot. Make sure that the card is properly seated on the slot.

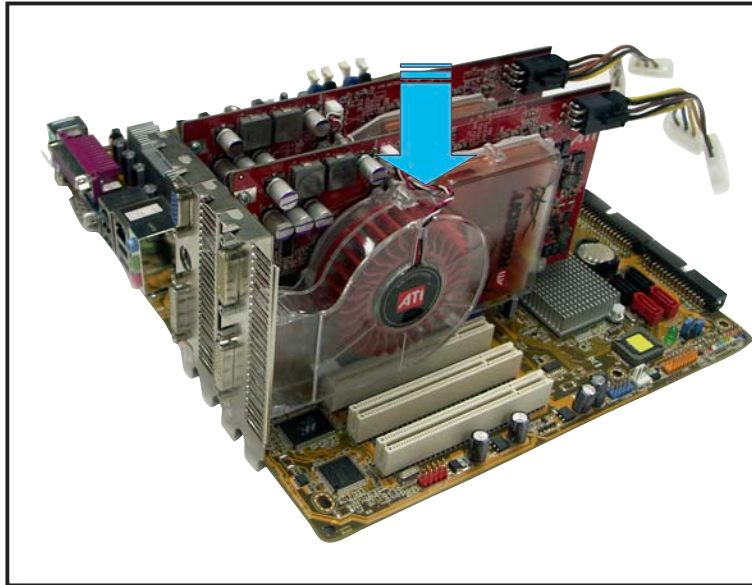

5. Connect one end of the external cable to the Slave graphics card.

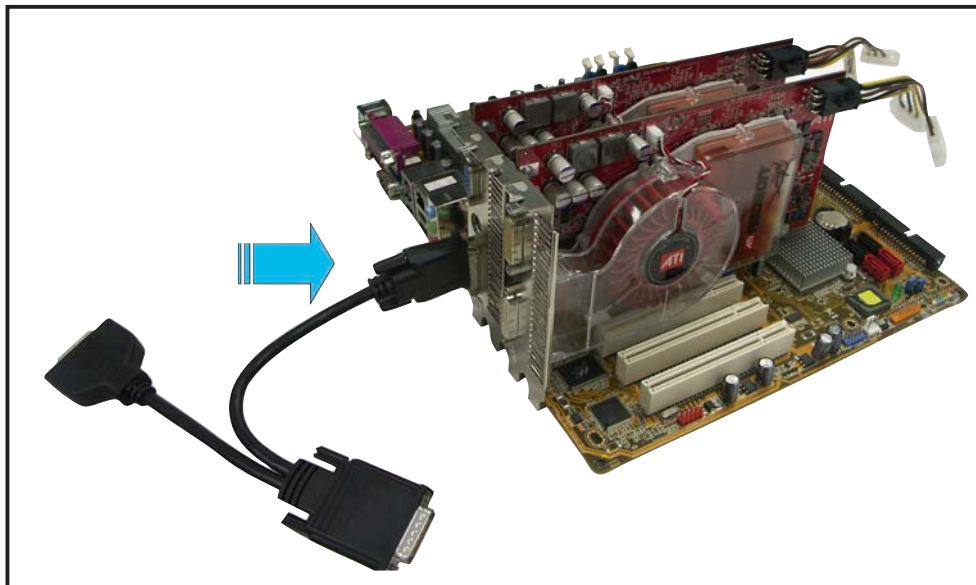

6. Connect the other end of the external cable to the Master graphics card.
7. Connect the loose end to the corresponding port on your monitor.
8. Connect an auxiliary power source from the power supply to the graphics cards.

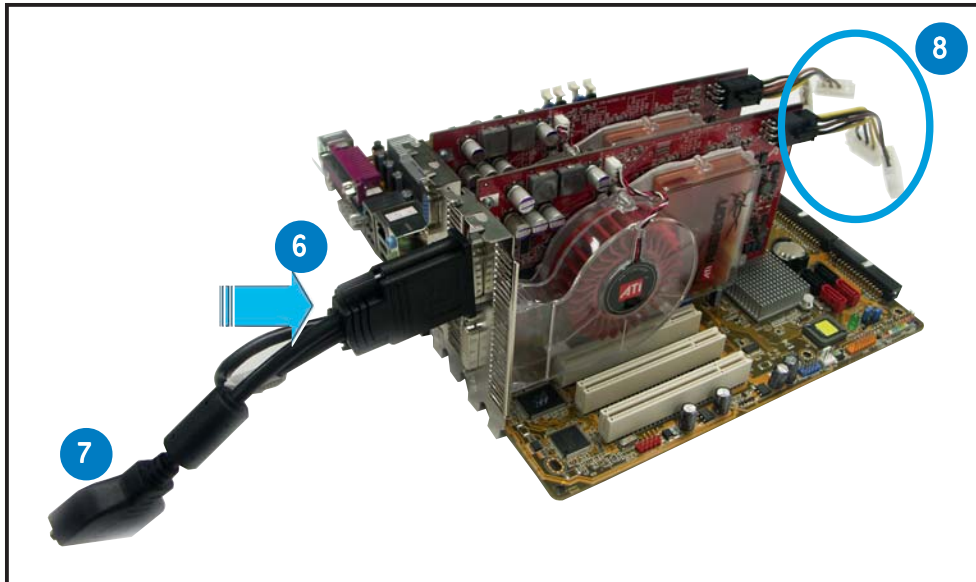

9. Boot up your computer, and press during POST to enter the BIOS setup.
10. Set the Dual-slot configuration item in the BIOS to [Auto] or [Dual Video Cards]. See section “4.4.3 Chipset Configuration” for details.

6.3 Software information

6.3.1 Installing the device drivers

Refer to the documentation that came with your graphics card package to install the device drivers.



The ATI CrossFire™ technology supports only the following operating systems:

- Windows® XP 32-bit (Home or Professional) with Service Pack 2 (SP2)
- Windows® XP Professional 64-bit Edition.

1. Turn on your system and log in with administrator rights.
2. Windows® auto-detects the ASUS TV/FM card and displays the **Found New Hardware Wizard** window. Click **Cancel**.
3. Place the CrossFire™ installation CD in your optical drive. The opening menu appears.

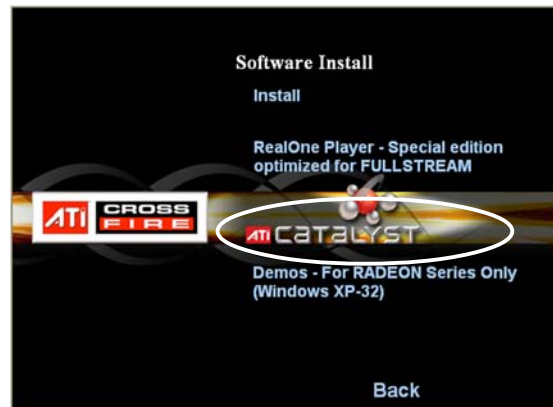

Click **Install CrossFire drivers**.

4. The installation window appears. Click **Next** to continue.
5. Read the License Agreement, then click **Yes**.

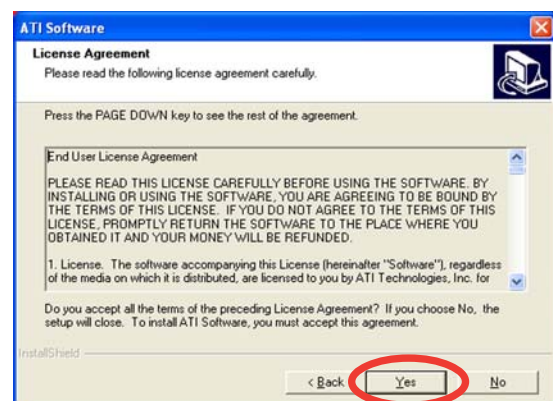
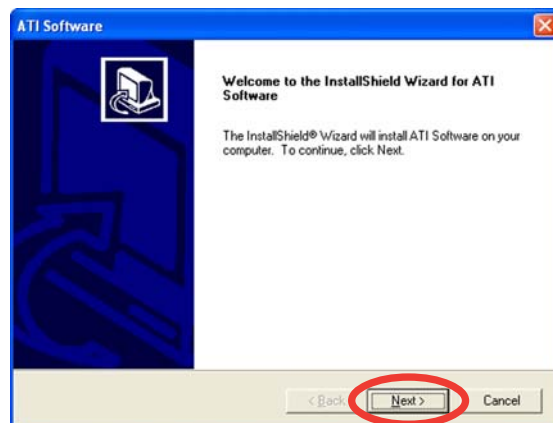

6. Select the components that you want to install, then click **Next**.

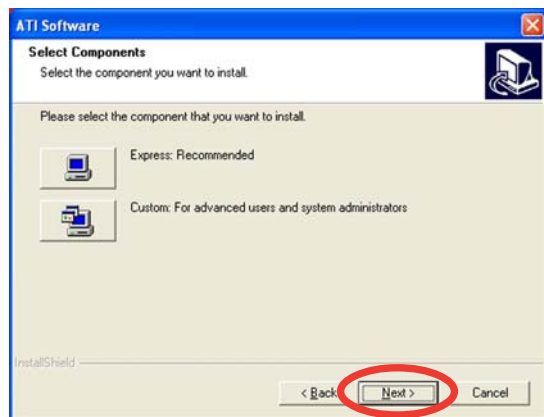

- Select **Express** to install the HydraVision™ multi-monitor and desktop management software, as well as the ATI driver.
- Select **Custom** to individually choose desired software components.

7. Installation begins.

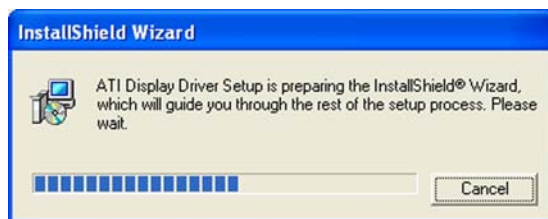

8. A status window appears, indicating the progress of the installation.

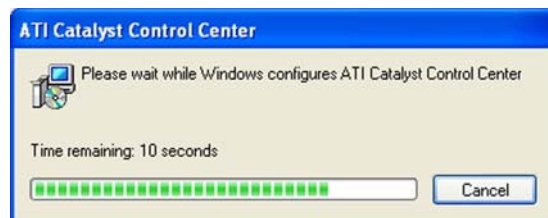

9. The **Setup Complete** window appears, indicating that the driver files have been copied to your computer.

Click **Yes** to restart your computer now or **No** to restart later.

Click **Finish**.



6.3.2 Using the Catalyst™ Control Center

The Catalyst™ Control Center allows you to access display features of the ATI hardware and software you installed. Use this application to adjust your graphic settings, enable/disable connected devices, and change your desktop orientation.

Launching the Catalyst™ Control Center

There are several ways to launch the Catalyst™ Control Center:

- On the Windows® task bar, click **Start > ATI Catalyst™ Control Center > Catalyst™ Control Center**
- Double-click the Catalyst™ Control Center desktop shortcut.



- On the Windows® task bar, double-click the Catalyst™ Control Center icon.



The Catalyst™ Control Center Dialog Box

View

The Catalyst™ Control Center provides two views:

- **Standard** - simple view with wizards for beginners



- **Advance** - allows advanced users to access and configure the complete features of the software



- Set to **Advance** view to enable the CrossFire™ function.
- Make sure that the Dual-slot configuration item in the BIOS is set to [Auto] or [Dual Video Cards] if you want to enable the CrossFire™ function.

To enable CrossFire™:

1. Set the view to **Advance**.
2. Click the **Crossfire™** item in **Graphics Settings**.
3. In the CrossFire™ Settings dialog, tick the box opposite **Enable CrossFire™**.
4. Click OK to effect the setting.



Hotkeys

Click the **Hotkeys** tab on the Catalyst™ Control Center to access the Hotkeys Manager, which allows you to create key combinations as shortcuts for performing certain functions quickly.



Profiles

Click the **Profiles** tab on the Catalyst™ Control Center to access the Profiles Manager, which allows you to create customized environments for your desktop, video, and 3D applications.



Preferences

Click the **Preferences** tab on the Catalyst™ Control Center to select a language, restore defaults, change skins, or enable/disable the System Tray icon.



Help

Click the **Help** tab on the Catalyst™ Control Center to access the online help system, generate a Problem Report, and get the Catalyst™ Control Center version information.



Free Manuals Download Website

<http://myh66.com>

<http://usermanuals.us>

<http://www.somanuals.com>

<http://www.4manuals.cc>

<http://www.manual-lib.com>

<http://www.404manual.com>

<http://www.luxmanual.com>

<http://aubethermostatmanual.com>

Golf course search by state

<http://golfingnear.com>

Email search by domain

<http://emailbydomain.com>

Auto manuals search

<http://auto.somanuals.com>

TV manuals search

<http://tv.somanuals.com>