

**P5VDC-MX**



**Motherboard**

**E2545**

**Revised Edition V2  
March 2006**

**Copyright © 2006 ASUSTeK COMPUTER INC. All Rights Reserved.**

No part of this manual, including the products and software described in it, may be reproduced, transmitted, transcribed, stored in a retrieval system, or translated into any language in any form or by any means, except documentation kept by the purchaser for backup purposes, without the express written permission of ASUSTeK COMPUTER INC. ("ASUS").

Product warranty or service will not be extended if: (1) the product is repaired, modified or altered, unless such repair, modification or alteration is authorized in writing by ASUS; or (2) the serial number of the product is defaced or missing.

ASUS PROVIDES THIS MANUAL "AS IS" WITHOUT WARRANTY OF ANY KIND, EITHER EXPRESS OR IMPLIED, INCLUDING BUT NOT LIMITED TO THE IMPLIED WARRANTIES OR CONDITIONS OF MERCHANTABILITY OR FITNESS FOR A PARTICULAR PURPOSE. IN NO EVENT SHALL ASUS, ITS DIRECTORS, OFFICERS, EMPLOYEES OR AGENTS BE LIABLE FOR ANY INDIRECT, SPECIAL, INCIDENTAL, OR CONSEQUENTIAL DAMAGES (INCLUDING DAMAGES FOR LOSS OF PROFITS, LOSS OF BUSINESS, LOSS OF USE OR DATA, INTERRUPTION OF BUSINESS AND THE LIKE), EVEN IF ASUS HAS BEEN ADVISED OF THE POSSIBILITY OF SUCH DAMAGES ARISING FROM ANY DEFECT OR ERROR IN THIS MANUAL OR PRODUCT.

SPECIFICATIONS AND INFORMATION CONTAINED IN THIS MANUAL ARE FURNISHED FOR INFORMATIONAL USE ONLY, AND ARE SUBJECT TO CHANGE AT ANY TIME WITHOUT NOTICE, AND SHOULD NOT BE CONSTRUED AS A COMMITMENT BY ASUS. ASUS ASSUMES NO RESPONSIBILITY OR LIABILITY FOR ANY ERRORS OR INACCURACIES THAT MAY APPEAR IN THIS MANUAL, INCLUDING THE PRODUCTS AND SOFTWARE DESCRIBED IN IT.

Products and corporate names appearing in this manual may or may not be registered trademarks or copyrights of their respective companies, and are used only for identification or explanation and to the owners' benefit, without intent to infringe.

## Contents

Notices .....	vi
Safety information .....	vii
About this guide .....	viii
P5VDC-MX specifications summary .....	x

### Chapter 1: Product introduction

1.1	Welcome! .....	1-2
1.2	Package contents .....	1-2
1.3	Special features .....	1-2
	1.3.1 Product highlights .....	1-2
	1.3.2 Innovative ASUS features .....	1-4
1.4	Before you proceed .....	1-5
1.5	Motherboard overview .....	1-6
	1.5.1 Placement direction .....	1-6
	1.5.2 Screw holes .....	1-6
	1.5.3 Motherboard layout .....	1-7
1.6	Central Processing Unit (CPU) .....	1-8
	1.6.1 Installing the CPU .....	1-8
	1.6.2 Installing the CPU heatsink and fan .....	1-11
	1.6.3 Uninstalling the CPU heatsink and fan .....	1-13
1.7	System memory .....	1-15
	1.7.1 Overview .....	1-15
	1.7.2 Memory Configurations .....	1-15
	1.7.3 DDR Qualified Vendors List .....	1-16
	1.7.4 Installing a DDR DIMM (blue slots) .....	1-18
	1.7.5 Removing a DDR DIMM .....	1-18
	1.7.6 Installing a DDR2 DIMM (yellow slots) .....	1-19
	1.7.7 Removing a DDR2 DIMM .....	1-19
1.8	Expansion slots .....	1-20
	1.8.1 Installing an expansion card .....	1-20
	1.8.2 Configuring an expansion card .....	1-20
	1.8.3 Interrupt assignments .....	1-21
	1.8.4 PCI slots .....	1-22
	1.8.5 PCI Express x1 slot .....	1-22
	1.8.6 AGP slot .....	1-22

## Contents

1.9	Jumpers .....	1-23
1.10	Connectors .....	1-25
1.10.1	Rear panel connectors .....	1-25
1.10.2	Internal connectors .....	1-26
<b>Chapter 2: BIOS setup</b>		
2.1	Managing and updating your BIOS .....	2-2
2.1.1	Creating a bootable floppy disk .....	2-2
2.1.2	ASUS EZ Flash utility .....	2-3
2.1.3	AFUDOS utility .....	2-4
2.1.4	ASUS CrashFree BIOS 2 utility .....	2-6
2.1.5	ASUS Update utility .....	2-8
2.2	BIOS setup program .....	2-11
2.2.1	BIOS menu screen .....	2-12
2.2.2	Menu bar .....	2-12
2.2.3	Navigation keys .....	2-12
2.2.4	Menu items .....	2-13
2.2.5	Sub-menu items .....	2-13
2.2.6	Configuration fields .....	2-13
2.2.7	Pop-up window .....	2-13
2.2.8	Scroll bar .....	2-13
2.2.9	General help .....	2-13
2.3	Main menu .....	2-14
2.3.1	System Time [xx:xx:xxxx] .....	2-14
2.3.2	System Date [Day xx/xx/xxxx] .....	2-14
2.3.3	Legacy Diskette A [1.44M, 3.5 in.] .....	2-14
2.3.4	Primary and Secondary IDE Master/Slave .....	2-15
2.3.5	System Information .....	2-16
2.4	Advanced menu .....	2-17
2.4.1	JumperFree Configuration .....	2-17
2.4.2	USB Configuration .....	2-18
2.4.3	CPU Configuration .....	2-19
2.4.4	Chipset .....	2-20
2.4.5	Onboard Devices Configuration .....	2-24

## Contents

2.4.6	PCI PnP .....	2-25
2.5	Power menu .....	2-27
2.5.1	Suspend Mode [Auto] .....	2-27
2.5.2	Repost Video on S3 Resume [No] .....	2-27
2.5.3	ACPI 2.0 Support [No] .....	2-27
2.5.4	ACPI APIC Support [Enabled] .....	2-27
2.5.5	APM Configuration .....	2-28
2.5.6	Hardware Monitor .....	2-29
2.6	Boot menu .....	2-30
2.6.1	Boot Device Priority .....	2-30
2.6.2	Boot Settings Configuration .....	2-31
2.6.3	Security .....	2-32
2.7	Exit menu .....	2-34

### Chapter 3: Software support

3.1	Installing an operating system .....	3-2
3.2	Support CD information .....	3-2
3.2.1	Running the support CD .....	3-2
3.2.2	Drivers menu .....	3-3
3.2.3	Utilities menu .....	3-4
3.2.4	Make Disk menu .....	3-5
3.2.5	Manuals menu .....	3-5
3.2.6	ASUS Contact information .....	3-6
3.3	RAID configurations .....	3-7
3.3.1	Installing hard disks .....	3-8
3.4	Creating a RAID driver disk .....	3-12

## Notices

### Federal Communications Commission Statement

This device complies with Part 15 of the FCC Rules. Operation is subject to the following two conditions:

- This device may not cause harmful interference, and
- This device must accept any interference received including interference that may cause undesired operation.

This equipment has been tested and found to comply with the limits for a Class B digital device, pursuant to Part 15 of the FCC Rules. These limits are designed to provide reasonable protection against harmful interference in a residential installation. This equipment generates, uses and can radiate radio frequency energy and, if not installed and used in accordance with manufacturer's instructions, may cause harmful interference to radio communications. However, there is no guarantee that interference will not occur in a particular installation. If this equipment does cause harmful interference to radio or television reception, which can be determined by turning the equipment off and on, the user is encouraged to try to correct the interference by one or more of the following measures:

- Reorient or relocate the receiving antenna.
- Increase the separation between the equipment and receiver.
- Connect the equipment to an outlet on a circuit different from that to which the receiver is connected.
- Consult the dealer or an experienced radio/TV technician for help.



---

The use of shielded cables for connection of the monitor to the graphics card is required to assure compliance with FCC regulations. Changes or modifications to this unit not expressly approved by the party responsible for compliance could void the user's authority to operate this equipment.

---

### Canadian Department of Communications Statement

This digital apparatus does not exceed the Class B limits for radio noise emissions from digital apparatus set out in the Radio Interference Regulations of the Canadian Department of Communications.

**This class B digital apparatus complies with Canadian ICES-003.**

## Safety information

### Electrical safety

- To prevent electrical shock hazard, disconnect the power cable from the electrical outlet before relocating the system.
- When adding or removing devices to or from the system, ensure that the power cables for the devices are unplugged before the signal cables are connected. If possible, disconnect all power cables from the existing system before you add a device.
- Before connecting or removing signal cables from the motherboard, ensure that all power cables are unplugged.
- Seek professional assistance before using an adapter or extension cord. These devices could interrupt the grounding circuit.
- Make sure that your power supply is set to the correct voltage in your area. If you are not sure about the voltage of the electrical outlet you are using, contact your local power company.
- If the power supply is broken, do not try to fix it by yourself. Contact a qualified service technician or your retailer.

### Operation safety

- Before installing the motherboard and adding devices on it, carefully read all the manuals that came with the package.
- Before using the product, make sure all cables are correctly connected and the power cables are not damaged. If you detect any damage, contact your dealer immediately.
- To avoid short circuits, keep paper clips, screws, and staples away from connectors, slots, sockets and circuitry.
- Avoid dust, humidity, and temperature extremes. Do not place the product in any area where it may become wet.
- Place the product on a stable surface.
- If you encounter technical problems with the product, contact a qualified service technician or your retailer.



This symbol of the crossed out wheeled bin indicates that the product (electrical and electronic equipment) should not be placed in municipal waste.  
Please check local regulations for disposal of electronic products.

## About this guide

This user guide contains the information you need when installing and configuring the motherboard.

## How this guide is organized

This manual contains the following parts:

- **Chapter 1: Product introduction**  
This chapter describes the features of the motherboard and the new technology it supports. This chapter also lists the hardware setup procedures that you have to perform when installing system components. It includes description of the jumpers and connectors on the motherboard.
- **Chapter 2: BIOS setup**  
This chapter tells how to change system settings through the BIOS Setup menus. Detailed descriptions of the BIOS parameters are also provided.
- **Chapter 3: Software support**  
This chapter describes the contents of the support CD that comes with the motherboard package.

## Where to find more information

Refer to the following sources for additional information and for product and software updates.

1. **ASUS websites**  
The ASUS website provides updated information on ASUS hardware and software products. Refer to the ASUS contact information.
2. **Optional documentation**  
Your product package may include optional documentation, such as warranty flyers, that may have been added by your dealer. These documents are not part of the standard package.



## Conventions used in this guide

To make sure that you perform certain tasks properly, take note of the following symbols used throughout this manual.



**DANGER/WARNING:** Information to prevent injury to yourself when trying to complete a task.



**CAUTION:** Information to prevent damage to the components when trying to complete a task.



**IMPORTANT:** Instructions that you **MUST** follow to complete a task.



**NOTE:** Tips and additional information to help you complete a task.

## Typography

**Bold text**

Indicates a menu or an item to select

*Italics*

Used to emphasize a word or a phrase

<Key>

Keys enclosed in the less-than and greater-than sign means that you must press the enclosed key

Example: <Enter> means that you must press the Enter or Return key

<Key1+Key2+Key3>

If you must press two or more keys simultaneously, the key names are linked with a plus sign (+)

Example: <Ctrl+Alt+D>

**Command**

Means that you must type the command exactly as shown, then supply the required item or value enclosed in brackets

Example: At the DOS prompt, type the command line:

**afudos /i[filename]**

**afudos /iP5VDCMX.ROM**

## P5VDC-MX specifications summary

<b>CPU</b>	LGA775 socket for Intel® Pentium® D/Pentium® 4/ Celeron CPU Compatible with Intel® 05B/05A and 04B/ 04A processor Supports Intel® EM64T/Hyper-Threading Technology (Note: Due to chipset limitation, the Intel Enhanced Intel SpeedStep Technology, C1E, and TM2 are not supported in this model)
<b>Chipset</b>	Northbridge: VIA P4M800 PRO Southbridge: VIA VT8251
<b>Front Side Bus</b>	800/533 MHz
<b>Memory</b>	2 x 240-pin DIMM sockets support max. 2GB DDR2 533/400 non-ECC, unbuffered memory. 2 x 184-pin DIMM sockets support max. 2GB DDR 400/ 333/266 non-ECC, unbuffered memory (Note:DDR and DDR2 memory can not be used simultaneously)
<b>Expansion slots</b>	1 x AGP 8X/4X (1.5V only) 1 x PCI Express x1 2 x PCI, PCI 2.2
<b>VGA</b>	Integrated VIA UniChrome Graphics, up to 64MB shared memory
<b>Storage</b>	South Bridge: VT8251 2 x UltraDMA 133/100/66 4 x Serial ATA 3Gb/s with RAID 0, 1, 0+1 & JBOD function
<b>LAN</b>	Realtek RTL8201CL 10/100 LAN controller
<b>Audio</b>	Realtek ALC653 AC'97 6-channel Audio CODEC
<b>Other ASUS Special Features</b>	ASUS Q-Fan ASUS EZ Flash CrashFree BIOS 2 ASUS MyLogo
<b>Back panel I/O Ports</b>	1 x Parallel port 1 x RJ-45 4 x USB 2.0/1.1 1 x VGA out 1 x Serial port 1 x PS/2 keyboard 1 x PS/2 mouse 1 x 6-Channel Audio I/O

*(continued on the next page)*

## P5VDC-MX specifications summary

<b>BIOS</b>	4 Mb Flash ROM, AMI BIOS, PnP, WfM2.0, DMI2.0, SM BIOS 2.3
<b>Manageability</b>	WOL by PME, WOR by PME, Chassis Intrusion, PXE, RPL
<b>USB</b>	Max. 8 USB 2.0 ports
<b>Internal I/O connectors</b>	2 x USB 2.0/1.1 connector supports additional 4 USB ports 4 x SATA connector 2 x IDE connector CPU/Chassis fan connectors Game/MIDI connector 24-pin EATX Power connector 4-pin ATX 12 V Power connector CD/AUX audio-in connector Chassis Intrusion 1 x Floppy disk drive connector 1 x S/PDIF out connector Front panel audio connector System panel connector
<b>Form Factor</b>	mATX Form Factor, 9.6 in x 9.6 in (24.5 cm x 24.5 cm)
<b>Support CD contents</b>	Drivers ASUS PC Probe ASUS Live Update utility Anti-virus software (OEM version)

*\*Specifications are subject to change without notice.*



This chapter describes the motherboard features and the new technologies it supports.

# Product introduction

## 1.1 Welcome!

### Thank you for buying an ASUS® P5VDC-MX motherboard!

The motherboard delivers a host of new features and latest technologies, making it another standout in the long line of ASUS quality motherboards!

Before you start installing the motherboard, and hardware devices on it, check the items in your package with the list below.

## 1.2 Package contents

Check your motherboard package for the following items.

<b>Motherboard</b>	ASUS P5VDC-MX motherboard
<b>Cables</b>	1 x Serial ATA power cable 1 x Serial ATA signal cable 1 x Ultra DMA 133/100 cables 1 x Floppy disk drive cable
<b>Accessories</b>	I/O shield
<b>Application CDs</b>	ASUS motherboard support CD
<b>Documentation</b>	User guide



If any of the above items is damaged or missing, contact your retailer.

## 1.3 Special features

### 1.3.1 Product highlights

#### Latest processor technology

The motherboard comes with a 775-pin surface mount Land Grid Array (LGA) socket designed for the Intel® Pentium® 4 processor in the 775-land package. The motherboard supports the Intel® Pentium® 4 processor with 800 MHz Front Side Bus (FSB), and core speed of up to 3.8 GHz. The motherboard also supports the Intel® Hyper-Threading Technology and is fully compatible with Intel® 05B/05A and 04B/04A processors. See page 1-8 for details.

## 64-bit CPU support



64-bit computing, the next generation technology to replace current 32-bit architecture, delivers advanced system performance, faster memory access and increased productivity. This motherboard provides excellent compatibility and flexibility by supporting either 64-bit or 32-bit architecture.

## Dual-Core CPU



Enjoy the extraordinary CPU power from the latest dual-core CPU. The advanced processing technology contains two physical CPU cores with individually dedicated L2 cache to satisfy the rising demand for more powerful processing capability.

## AGP 8X support **AGP8X**

The AGP 8X (AGP 3.0) VGA interface specification enables enhanced graphics performance with high bandwidth speeds up to 2.12 GB/s.

## Serial ATA II technology



The motherboard supports the Serial ATA II technology through the Serial ATA interfaces and the VIA VT8251 chipset. The SATA specification allows for thinner, more flexible cables with lower pin count, reduced voltage requirement, and up to 300 MB/s data transfer rate. See page 1-28 for details.

## Onboard RAID solution

The onboard VIA VT8251 chipset allows RAID 0, RAID 1, RAID 0+1 and JBOD configuration for four SATA connectors. Refer to page 3-7~3-12 for details.

## USB 2.0 technology



The motherboard implements the Universal Serial Bus (USB) 2.0 specification, dramatically increasing the connection speed from the 12 Mbps bandwidth on USB 1.1 to a fast 480 Mbps on USB 2.0. USB 2.0 is backward compatible with USB 1.1. See page 1-24, 1-26, 1-31 for details.

## AUDIO CODEC

The Realtek ALC653 is an AC'97 CODEC that allows 6-channel audio playback. The audio CODEC provides six DAC channels for 5.1 surround sound, AUX, and Line In stereo inputs.

### 1.3.2 Innovative ASUS features

#### CrashFree BIOS 2

This feature allows you to restore the original BIOS data from the support CD in case when the BIOS codes and data are corrupted. This protection eliminates the need to buy a replacement ROM chip. See details on page 2-6.

#### ASUS EZ Flash BIOS

With the ASUS EZ Flash, you can easily update the system BIOS even before loading the operating system. No need to use a DOS-based utility or boot from a floppy disk. See page 2-3 for details.

#### ASUS Q-Fan technology

The ASUS Q-Fan technology smartly adjusts the CPU fan speed according to the system loading to ensure quiet, cool, and efficient operation. See page 2-30 for details.



## 1.4 Before you proceed

Take note of the following precautions before you install motherboard components or change any motherboard settings.



- Unplug the power cord from the wall socket before touching any component.
- Use a grounded wrist strap or touch a safely grounded object or to a metal object, such as the power supply case, before handling components to avoid damaging them due to static electricity
- Hold components by the edges to avoid touching the ICs on them.
- Whenever you uninstall any component, place it on a grounded antistatic pad or in the bag that came with the component.
- **Before you install or remove any component, ensure that the ATX power supply is switched off or the power cord is detached from the power supply.** Failure to do so may cause severe damage to the motherboard, peripherals, and/or components.

### Onboard LED

The motherboard comes with a standby power LED that lights up to indicate that the system is ON, in sleep mode, or in soft-off mode. This is a reminder that you should shut down the system and unplug the power cable before removing or plugging in any motherboard component. The illustration below shows the location of the onboard LED.

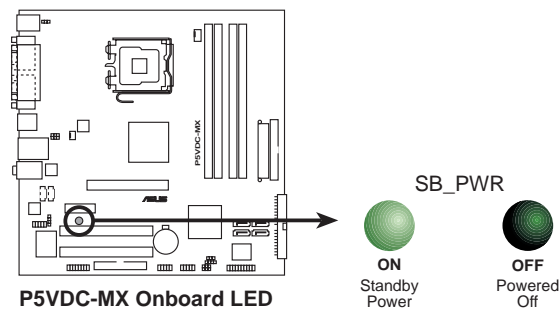

## 1.5 Motherboard overview

Before you install the motherboard, study the configuration of your chassis to ensure that the motherboard fits into it.



Make sure to unplug the power cord before installing or removing the motherboard. Failure to do so can cause you physical injury and damage motherboard components.

### 1.5.1 Placement direction

When installing the motherboard, make sure that you place it into the chassis in the correct orientation. The edge with external ports goes to the rear part of the chassis as indicated in the image below.

### 1.5.2 Screw holes

Place eight (8) screws into the holes indicated by circles to secure the motherboard to the chassis.



Do not overtighten the screws! Doing so can damage the motherboard.

Place this side towards  
the rear of the chassis

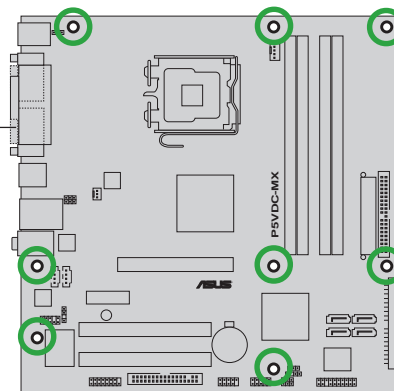

### 1.5.3 Motherboard layout

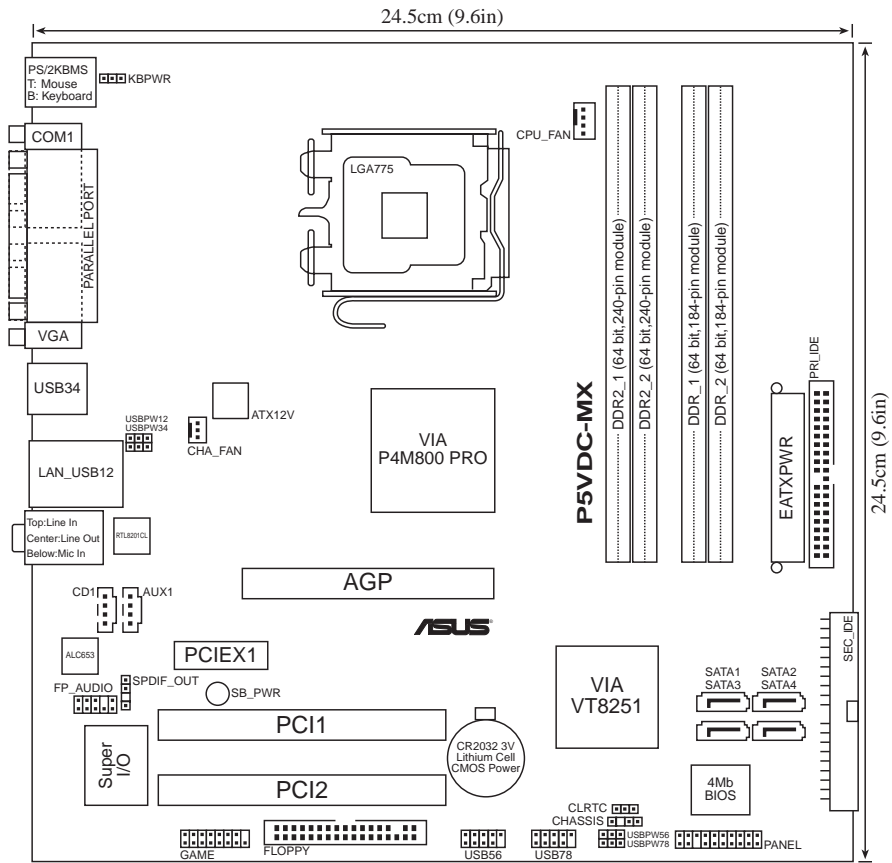

## 1.6 Central Processing Unit (CPU)

The motherboard comes with a surface mount LGA775 socket designed for the Intel® Pentium® 4/Intel® Pentium® D processor in the 775-land package.



- Your boxed Intel® Pentium® 4 LGA775 processor package should come with installation instructions for the CPU, fan and heatsink assembly. If the instructions in this section do not match the CPU documentation, follow the latter.
- Upon purchase of the motherboard, make sure that the PnP cap is on the socket and the socket pins are not bent. Contact your retailer immediately if the PnP cap is missing, or if you see any damage to the PnP cap/socket pins/motherboard components. ASUS will shoulder the cost of repair only if the damage is shipment/transit-related.
- Keep the cap after installing the motherboard. ASUS will process Return Merchandise Authorization (RMA) requests only if the motherboard comes with the cap on the LGA775 socket.
- The product warranty does not cover damage to the socket pins resulting from incorrect CPU installation/removal, or misplacement/loss/incorrect removal of the PnP cap.



- Due to chipset limitation. The motherboard does not support Enhanced Intel SpeedStep technology, C1E and TM2 technology.
- This motherboard does not support Intel® Pentium® Processor Extreme Edition.

### 1.6.1 Installing the CPU

To install a CPU:

1. Locate the CPU socket on the motherboard.

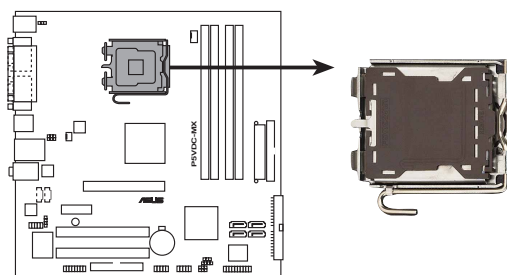

**P5VDC-MX CPU Socket 775**



Before installing the CPU, make sure that the socket box is facing towards you and the load lever is on your left.

2. Press the load lever with your thumb (A) and move it to the left (B) until it is released from the retention tab.

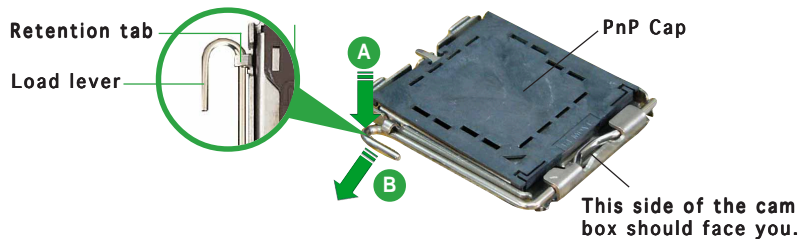

To prevent damage to the socket pins, do not remove the PnP cap unless you are installing a CPU.

3. Lift the load lever in the direction of the arrow to a 135° angle.

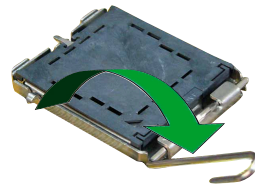

4. Lift the load plate with your thumb and forefinger to a 100° angle (A), then push the PnP cap from the load plate window to remove (B).

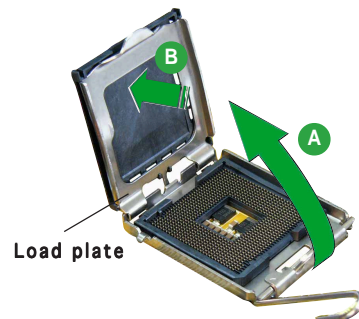

5. Position the CPU over the socket, making sure that the gold triangle is on the bottom-left corner of the socket. The socket alignment key should fit into the CPU notch.

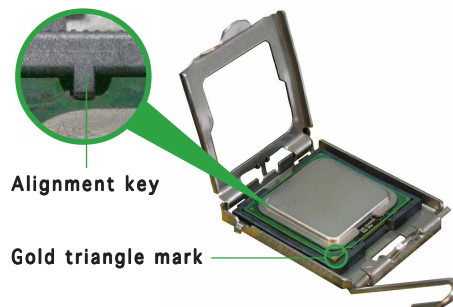

6. Close the load plate (A), then push the load lever (B) until it snaps into the retention tab.

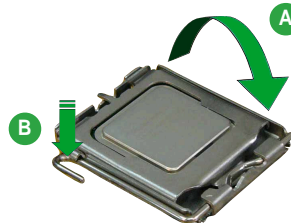

The CPU fits in only one correct orientation. DO NOT force the CPU into the socket to prevent bending the connectors on the socket and damaging the CPU!

### Notes on Intel® Hyper-Threading Technology



- This motherboard supports Intel® Pentium® 4 CPUs in the 775-land package with Hyper-Threading Technology.
- Hyper-Threading Technology is supported under Windows® XP/2003 Server and Linux 1.7.x (kernel) and later versions only. Under Linux, use the Hyper-Threading compiler to compile the code. If you are using any other operating systems, disable the Hyper-Threading Technology item in the BIOS to ensure system stability and performance.
- Installing Windows® XP Service Pack 1 or later version is recommended.
- Make sure to enable the Hyper-Threading Technology item in BIOS before installing a supported operating system.
- For more information on Hyper-Threading Technology, visit [www.intel.com/info/hyperthreading](http://www.intel.com/info/hyperthreading).

To use the Hyper-Threading Technology on this motherboard:

1. Install an Intel® Pentium® 4 CPU in the 775-land package that supports Hyper-Threading Technology.
2. Power up the system and enter the BIOS Setup (see Chapter 2: BIOS setup). Under the Advanced Menu, make sure that the item Hyper-Threading Technology is set to Enabled. The item appears only if you installed a CPU that supports Hyper-Threading Technology.
3. Reboot the computer.

## 1.6.2 Installing the CPU heatsink and fan

The Intel® Pentium® 4/Pentium® D LGA775 processor requires a specially designed heatsink and fan assembly to ensure optimum thermal condition and performance.



- Install the motherboard to the chassis before you install the CPU fan and heatsink assembly
- When you buy a boxed Intel® Pentium® 4 processor, the package includes the CPU fan and heatsink assembly. If you buy a CPU separately, make sure that you use only Intel®-certified multi-directional heatsink and fan.
- Your Intel® Pentium® 4 LGA775 heatsink and fan assembly comes in a push-pin design and requires no tool to install.



If you purchased a separate CPU heatsink and fan assembly, make sure that a Thermal Interface Material is properly applied to the CPU heatsink or CPU before you install the heatsink and fan assembly.

To install the CPU heatsink and fan:

1. Place the heatsink on top of the installed CPU, making sure that the four fasteners match the holes on the motherboard.

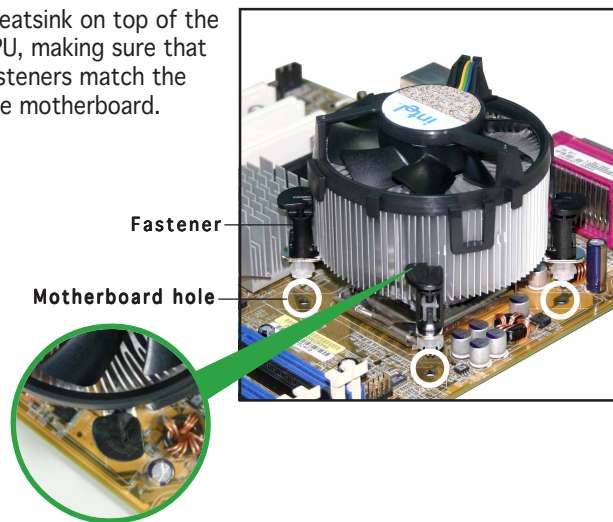

Make sure each fastener is oriented as shown, with the narrow groove directed outward.

2. Push down two fasteners at a time in a diagonal sequence to secure the heatsink and fan assembly in place.

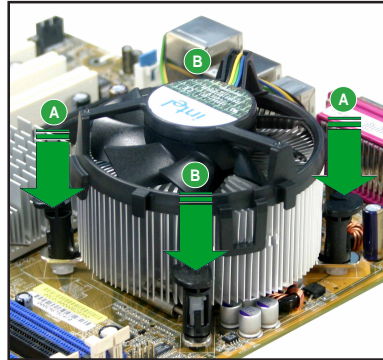
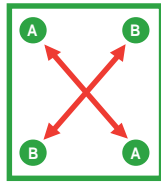

3. When the fan and heatsink assembly is in place, connect the CPU fan cable to the connector on the motherboard labeled CPU\_FAN.

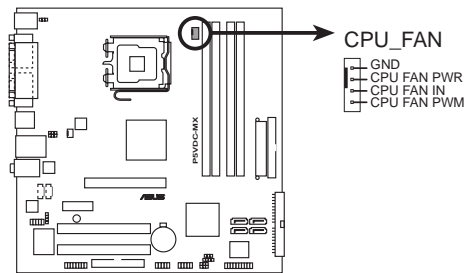

**P5VDC-MX CPU fan connector**



Do not forget to connect the CPU fan connector! Hardware monitoring errors can occur if you fail to plug this connector.



### 1.6.3 Uninstalling the CPU heatsink and fan

To uninstall the CPU heatsink and fan:

1. Disconnect the CPU fan cable from the connector on the motherboard labeled CPU\_FAN.
2. Rotate each fastener counterclockwise.

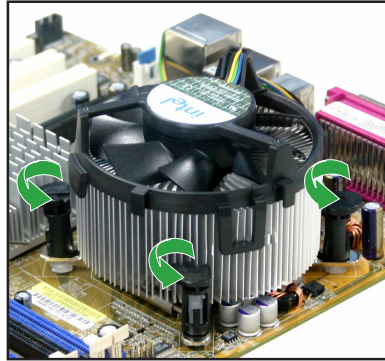

3. Pull up two fasteners at a time in a diagonal sequence to disengage the heatsink and fan assembly from the motherboard.

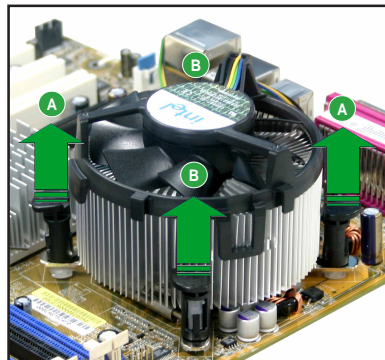
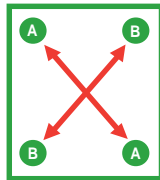

4. Remove the heatsink and fan assembly from the motherboard.

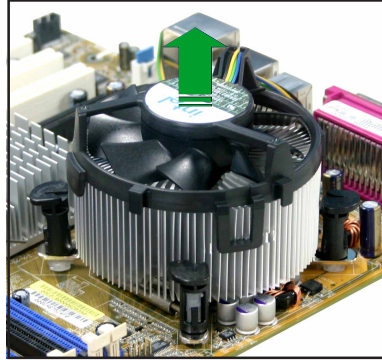

5. Rotate each fastener clockwise to reset the orientation.

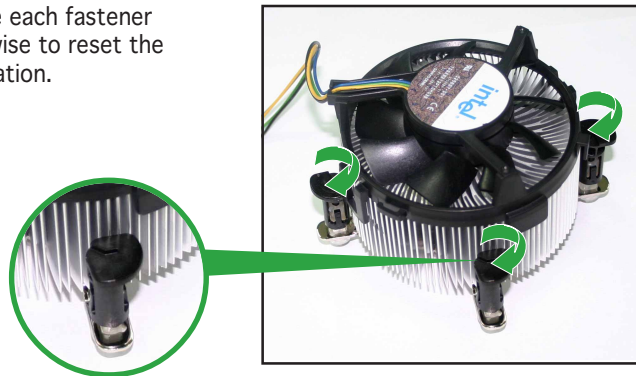

**Narrow end of the groove**



The narrow end of the groove should point outward after resetting. (The photo shows the groove shaded for emphasis.)



## 1.7 System memory

### 1.7.1 Overview

The motherboard comes with two 240-pin Double Data Rate (DDR2) and two 184-pin DDR Dual Inline Memory Modules (DIMM) sockets.

DDR2 DIMMS are notched differently to prevent installation on a DDR DIMM socket.

The following figure illustrates the location of the sockets:

Color	Sockets
Blue	DDR_1 and DDR_2
Yellow	DDR2_1 and DDR2_2

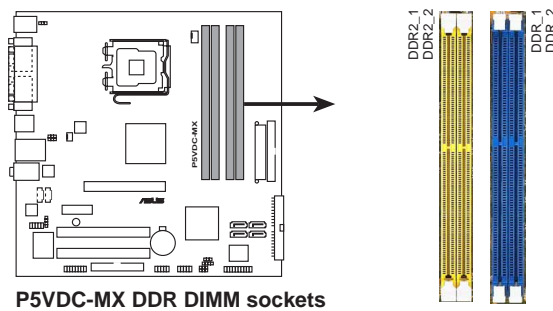

- To prevent damage to the motherboard, **do not use DDR and DDR2 memory simultaneously.**
- Due to chipset resource allocation, the system may detect less than 2 GB system memory when you installed two 1 GB DDR2 or DDR memory modules.

### 1.7.2 Memory Configurations

You may install 256MB, 512MB, and 1 GB unbuffered non-ECC DDR/DDR2 DIMMs into the DIMM sockets.

### 1.7.3 DDR Qualified Vendors List

Visit the ASUS website ([www.asus.com](http://www.asus.com)) for the latest DDR DIMM modules for this motherboard.

#### DDR2-533 Qualified Vendors List

Size	Vendor	Model	Brand	Side(s)	Component	DIMM support	
						A	B
256MB	KINGSTON	E5116AB-5C-E	N/A	SS	KVR533D2N4/256	V	V
512MB	KINGSTON	HY5PS56821F-C4	N/A	DS	KVR533D2N4/512	V	V
1024MB	KINGSTON	D6408TE7BL-37	N/A	DS	KVR533D2N4/1G	V	V
512MB	SAMSUNG	K4T51083QB-GCD5	N/A	SS	M378T6553BG0-CD5	V	V
256MB	SAMSUNG	K4T56083QF-GCD5	N/A	SS	M378T3253FG0-CD5	V	V
512MB	SAMSUNG	K4T56083QF-GCD5	N/A	DS	M378T6453FG0-CD5	V	V
1024MB	SAMSUNG	K4T51083QB-GCD5	N/A	DS	M378T2953BG0-CD5	V	V
512MB	MICRON	4FBII9BQM	N/A	DS	MT16HTF6464AG-53EB2	V	V
256MB	MICRON	4DBII29BQT	N/A	SS	N/A	V	V
256MB	MICRON	4FBII9CHM	N/A	SS	MT8HTF3264AY-53EB3	V	V
512MB	MICRON	4FBII9CHM	N/A	DS	MT16HTF6464AY-53EB2	V	V
512MB	Infineon	HYB18T512800AC37	N/A	SS	HYS64T64000GU-3.7-A	V	V
256MB	Infineon	HYB18T512160AF-3.7	N/A	SS	HYS64T32000HU-3.7-A	V	V
512MB	Infineon	HYB18T512800AF37	N/A	SS	HYS64T64000HU-3.7-A	V	V
256MB	Infineon	HYB18T512800AF37	N/A	DS	HYS64T128020HU-3.7-A	V	V
256MB	Infineon	HYB18T5121608BF-3.7	N/A	SS	HYS64T32000HU-3.7-B	V	V
512MB	Infineon	HYB18T512800BF37	N/A	SS	HYS64T64000HU-3.7-B	V	V
1024MB	Infineon	HYB18T512800BF37	N/A	DS	HYS64T128020HU-3.7-B	V	V
512MB	Hynix	HY5PS12821F-C4	N/A	SS	HYMP564U648-C4	V	V
1024MB	Hynix	HY5PS12821F-C4	N/A	DS	HYMP512U648-C4	V	V
1024MB	Hynix	HY5PS12821FP-C4	N/A	DS	HYMP512U648-C4	V	V
512MB	Hynix	HY5PS12821AFP-C3	N/A	SS	HYMP564U64AP8-C3	V	V
1024MB	Hynix	HY5PS12821AFP-C3	N/A	DS	HYMP512U64AP8-C3	V	V
512MB	ELPIDA	E5108AB-5C-E	N/A	SS	EBE51UD8ABFA-5C	V	V
512MB	ELPIDA	E5108AB-5C-E	N/A	SS	EBE51UD8ABFA-5C-E	V	V
1024MB	ELPIDA	E5108AB-5C-E	N/A	DS	EBE11UD8ABFA-5C-E	V	V
2048MB	ELPIDA	E1108AA-5C-E	N/A	DS	EBE21EE8AFA-5C-E	V	V
256MB	CORSAIR	MIII0051832M8CEC	N/A	SS	VS256MB533D2	V	V
512MB	CORSAIR	MI110052432M8CEC	N/A	DS	VS512MB533D2	V	V
256MB	Apacer	E5116AB-5C-E	N/A	SS	78.81077.420	V	V
256MB	crucial	Heat-Sink Package	N/A	SS	BL3264AA53V.8FB	V	V
512MB	crucial	Heat-Sink Package	N/A	DS	BL6464AA53V.16FB	V	V
256MB	KINGMAX	K4T56083QF-GCD5	N/A	SS	KLBB68K-38SP4	V	V
1024MB	KINGMAX	E5108AB-5C-E	N/A	DS	KLBD48F-A8EP4	V	V
512MB	KINGMAX	E5108AB-5C-E	N/A	SS	KLBC28F-A8EP4	V	V
512MB	KINGMAX	KKEA88A4IA-37	N/A	SS	KLBC28F-A8KP4	V	V
256MB	KINGMAX	E5116AB-5C-E	N/A	SS	KLBB68F-36EP4	V	V
512MB	KINGMAX	E5108AE-5C-E	N/A	SS	KLBC28F-A8EB4	V	V
512MB	Transcend	K4T51083QB-GCD5	N/A	SS	TS64MLQ64V5J	V	V
1024MB	Transcend	K4T51083QB-GCD5	N/A	DS	TS128MLQ64V5J	V	V

#### Legend:

- A** - supports one module inserted in any **yellow** slot.
- B** - supports one pair of modules inserted into both of the **yellow** slots.
- SS** - Single-sided
- DS** - Double-sided

## DDR400 Qualified Vendors List

Size	Vendor	Model	Brand	Side(s)	Component	DIMM support	
						A	B
512MB	KINGSTON	Heat-Sink Package	N/A	DS	KHX3200A/512	V	V
256MB	KINGSTON	D3208DL3T-5A	N/A	SS	KVR400X64C3A/256	V	V
256MB	KINGSTON	A2S56D30BTP	N/A	SS	KVR400X64C3A/256		V
512MB	KINGSTON	V58C2256804SAT5	N/A	DS	KVR400X64C3A/512	V	V
512MB	KINGSTON	HY5DU12822BT-D43	N/A	SS	KVR400X64C3A/512	V	V
1024MB	KINGSTON	HYB25D512800BE-5B	N/A	DS	KVR400X64C3A/1G	V	V
256MB	SAMSUNG	K4H560838E-TCCC	SAMSUNG	SS	M368L3223ETM-CCC	V	V
256MB	SAMSUNG	K4H560838F-TCCC	SAMSUNG	SS	M368L3223FTN-CCC		V
512MB	SAMSUNG	K4H560838F-TCCC	SAMSUNG	DS	M368L6423FTN-CCC	V	V
512MB	SAMSUNG	K4H510838B-TCCC	SAMSUNG	SS	M368L6523BTM-CCC	V	V
256MB	MICRON	MT46V32M8TG-5BC	MICRON	SS	MT8VDDT3264AG-40BCB		V
512MB	MICRON	MT46V32M8TG-5BC	MICRON	DS	MT16VDDT6464AG-40BCB	V	V
256MB	Infineon	HYB25D256800CE-5C	Infineon	SS	HYS64D32300HU-5-C	V	V
512MB	Infineon	HYB25D256800CE-5C	Infineon	DS	HYS64D64320HU-5-C	V	V
256MB	Infineon	HYB25D512160CE-5C	Infineon	SS	HYS64D32301HU-5-C	V	V
512MB	Infineon	HYB25D512800CE-5C	Infineon	SS	HYS64D64300HU-5-C		V
1024MB	Infineon	HYB25D512800CE-5B	Infineon	DS	HYS64D128320HU-5-C	V	V
256MB	CORSAIR	W942508BH-5	N/A	SS	CMX256A-3200C2PT	V	V
512MB	CORSAIR	Heat-Sink Package	N/A	DS	CMX512-3200C2	V	V
512MB	CORSAIR	VS32M8-5	N/A	DS	VS512MB400	V	V
512MB	CORSAIR	Heat-Sink Package	N/A	DS	CMXP512-3200XL		V
1024MB	CORSAIR	Heat-Sink Package	N/A	DS	TWINX2048-3200C2	V	V
256MB	Hynix	HY5DU56822DT-D43	N/A	SS	HYMD232646D8J-D43	V	V
512MB	Hynix	HY5DU56822DT-D43	N/A	DS	HYMD264646D8J-D43		V
256MB	Transcend	K4H560838F-TCCC	SAMSUNG	SS	TS32MLD64V4F3	V	V
512MB	Transcend	K4H560838F-TCCC	SAMSUNG	DS	TS64MLD64V4F3		V
1024MB	Transcend	K4H510838B-TCCC	SAMSUNG	DS	TS128MLD64V4J	V	V
256MB	A DATA	K4H560838E-TCCC	SAMSUNG	SS	MDOSS6F3G31Y0K1E0Z	V	V
512MB	A DATA	K4H560838F-TCCC	SAMSUNG	DS	MDOSS6F3H41Y0N1E0Z	V	V
256MB	A DATA	HY5DU56822CT-D43	Hynix	SS	MDOHY6F3G31Y0N1E0Z	V	V
512MB	A DATA	HY5DU56822CT-D43	Hynix	DS	MDOHY6F3H41Y0N1E0Z	V	V
256MB	A DATA	ADD8608A8A-5B	N/A	SS	MDOAD5F3G31Y0D1E0Z		V
512MB	A DATA	ADD8608A8A-5B	N/A	DS	MDOAD5F3H41Y0D1E0Z		V
256MB	KINGMAX	KDL388P4LA-50	N/A	SS	MPXB62D-38KT3R	V	V
256MB	crucial	Heat-Sink Package	Ballistix	SS	BL3264Z402.8TG	V	V

### Legend:

- A** - supports one module inserted in any **blue** slot.
- B** - supports one pair of modules inserted into both of the **blue** slots.
- SS** - Single-sided
- DS** - Double-sided

## 1.7.4 Installing a DDR DIMM(blue slots)



Make sure to unplug the power supply before adding or removing DIMMs or other system components. Failure to do so may cause severe damage to both the motherboard and the components.

1. Unlock a DIMM socket by pressing the retaining clips outward.
2. Align a DIMM on the socket such that the notch on the DIMM matches the break on the socket.

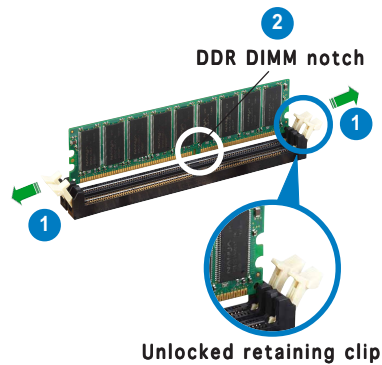

A DDR DIMM is keyed with a notch so that it fits in only one direction. DO NOT force a DIMM into a socket to avoid damaging the DIMM.

3. Firmly insert the DIMM into the socket until the retaining clips snap back in place and the DIMM is properly seated.

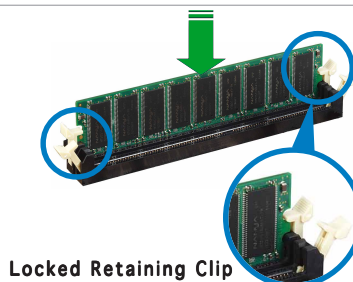

## 1.7.5 Removing a DDR DIMM

Follow these steps to remove a DIMM.

1. Simultaneously press the retaining clips outward to unlock the DIMM.

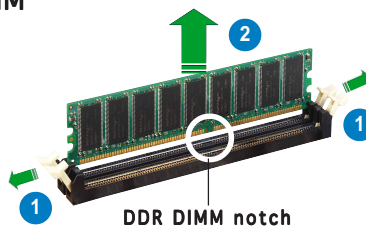

Support the DIMM lightly with your fingers when pressing the retaining clips. The DIMM might get damaged when it flips out with extra force.

2. Remove the DIMM from the socket.

### 1.7.6 Installing a DDR2 DIMM(yellow slots)



Unplug the power supply before adding or removing DIMMs or other system components. Failure to do so can cause severe damage to both the motherboard and the components.

To install a DIMM:

1. Unlock a DIMM socket by pressing the retaining clips outward.
2. Align a DIMM on the socket such that the notch on the DIMM matches the break on the socket.
3. Firmly insert the DIMM into the socket until the retaining clips snap back in place and the DIMM is properly seated.

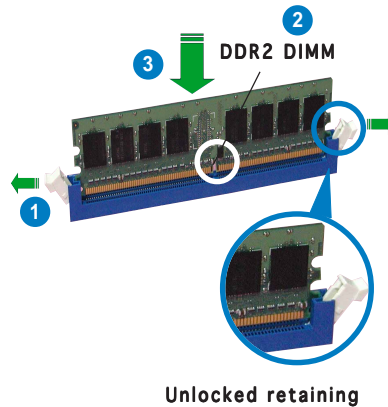

- A DDR2 DIMM is keyed with a notch so that it fits in only one direction. Do not force a DIMM into a socket to avoid damaging the DIMM.
- The DDR2 DIMM sockets do not support DDR DIMMs. Do not install DDR DIMMs to the DDR2 DIMM sockets.

### 1.7.7 Removing a DDR2 DIMM

Follow these steps to remove a DIMM.

1. Simultaneously press the retaining clips outward to unlock the DIMM.



Support the DIMM lightly with your fingers when pressing the retaining clips. The DIMM might get damaged when it flips out with extra force.

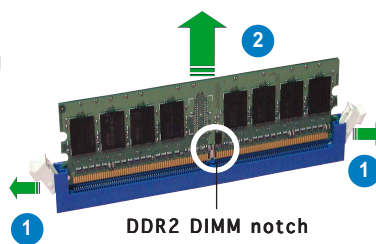

2. Remove the DIMM from the socket.

## 1.8 Expansion slots

In the future, you may need to install expansion cards. The following sub-sections describe the slots and the expansion cards that they support.



---

Make sure to unplug the power cord before adding or removing expansion cards. Failure to do so may cause you physical injury and damage motherboard components.

---

### 1.8.1 Installing an expansion card

To install an expansion card:

1. Before installing the expansion card, read the documentation that came with it and make the necessary hardware settings for the card.
2. Remove the system unit cover (if your motherboard is already installed in a chassis).
3. Remove the bracket opposite the slot that you intend to use. Keep the screw for later use.
4. Align the card connector with the slot and press firmly until the card is completely seated on the slot.
5. Secure the card to the chassis with the screw you removed earlier.
6. Replace the system cover.

### 1.8.2 Configuring an expansion card

After installing the expansion card, configure it by adjusting the software settings.

1. Turn on the system and change the necessary BIOS settings, if any. See Chapter 2 for information on BIOS setup.
2. Assign an IRQ to the card. Refer to the tables on the next page.
3. Install the software drivers for the expansion card.



### 1.8.3 Interrupt assignments

#### Standard interrupt assignments

IRQ	Priority	Standard Function
0	1	System Timer
1	2	Keyboard Controller
2	•	Re-direct to IRQ#9
4	12	Communications Port (COM)*
5	13	IRQ holder for PCI steering*
6	14	Floppy Disk Controller
7	15	Printer Port (LPT1)*
8	3	System CMOS/Real Time Clock
9	4	IRQ holder for PCI steering*
10	5	IRQ holder for PCI steering*
11	6	PCI-E x1
12	7	PS/2 Compatible Mouse Port*
13	8	Numeric Data Processor
14	9	Primary IDE Channel
15	10	Secondary IDE Channel

\* These IRQs are usually available for ISA or PCI devices.

#### IRQ assignments for this motherboard

	A	B	C	D
PCI slot 1	—	shared	—	—
PCI slot 2	—	—	shared	—
PCIe x1 slot*	Fixed	Fixed	Fixed	Fixed
AGP 8X slot	shared	—	—	—
Onboard USB controller 1	shared	—	—	—
Onboard USB controller 2	—	—	shared	—
Onboard USB controller 3	—	shared	—	—
Onboard USB controller 4	—	—	—	shared
Onboard USB 2.0 controller	—	—	shared	—
Onboard LAN	shared	—	—	—
Onboard audio	—	shared	—	—
Onboard VGA	shared	—	—	—

\* The PCIe x1 slot does not need IRQ assignment.



When using PCI cards on shared slots, ensure that the drivers support “Share IRQ” or that the cards do not need IRQ assignments. Otherwise, conflicts will arise between the two PCI groups, making the system unstable and the card inoperable.

### 1.8.4 PCI slots

The PCI slots support cards such as a LAN card, SCSI card, USB card, and other cards that comply with PCI specifications. The figure shows a LAN card installed on a PCI slot.

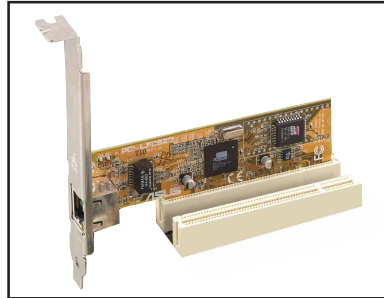

### 1.8.5 PCI Express x1 slot

This motherboard supports PCI Express x1 network cards, SCSI cards and other cards that comply with the PCI Express specifications. The figure shows a network card installed on the PCI Express x1 slot.

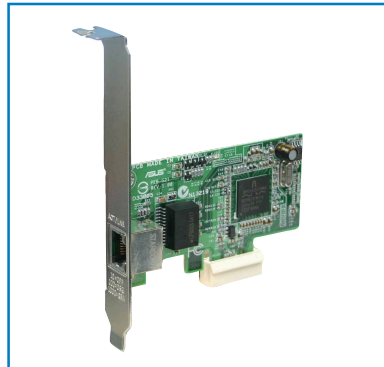

### 1.8.6 AGP slot

The Accelerated Graphics Port (AGP) slot supports AGP8X/4X cards. When you buy an AGP card, make sure that you ask for one with +1.5V specification. Note the notches on the card golden fingers to ensure that they fit the AGP slot on your motherboard.



Install only 1.5 V or 0.8 V AGP cards on this motherboard! 3.3V AGP cards are not supported in this motherboard.

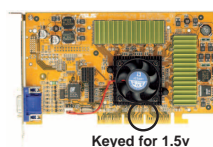
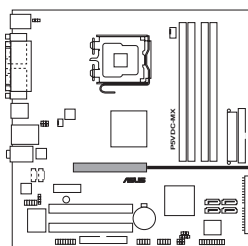

P5VDC-MX Accelerated Graphics Port (AGP)

## 1.9 Jumpers

### 1. Clear RTC RAM (CLRRTC)

This jumper allows you to clear the Real Time Clock (RTC) RAM in CMOS. You can clear the CMOS memory of date, time, and system setup parameters by erasing the CMOS RTC RAM data. The onboard button cell battery powers the RAM data in CMOS, which include system setup information such as system passwords.

To erase the RTC RAM:

1. Turn OFF the computer and unplug the power cord.
2. Remove the onboard battery.
3. Move the jumper cap from pins 1-2 (default) to pins 2-3. Keep the cap on pins 2-3 for about 5~10 seconds, then move the cap back to pins 1-2.
4. Re-install the battery.
5. Plug the power cord and turn ON the computer.
6. Hold down the <Del> key during the boot process and enter BIOS setup to re-enter data.



Except when clearing the RTC RAM, never remove the cap on CLRRTC jumper default position. Removing the cap will cause system boot failure!

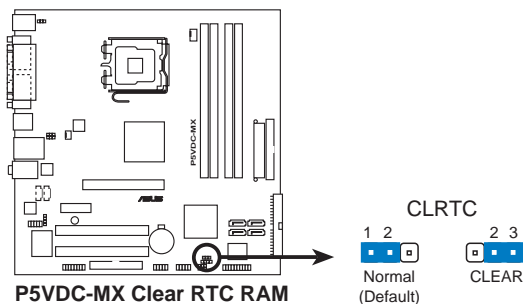

You do not need to clear the RTC when the system hangs due to overclocking. For system failure due to overclocking, use the C.P.R. (CPU Parameter Recall) feature. Shut down and reboot the system so the BIOS can automatically reset parameter settings to default values.

## 2. Keyboard power (3-pin KBPWR)

This jumper allows you to enable or disable the keyboard wake-up feature. Set this jumper to pins 2-3 (+5VSB) to wake up the computer when you press a key on the keyboard (the default is the Space Bar). This feature requires an ATX power supply that can supply at least 1A on the +5VSB lead, and a corresponding setting in the BIOS.

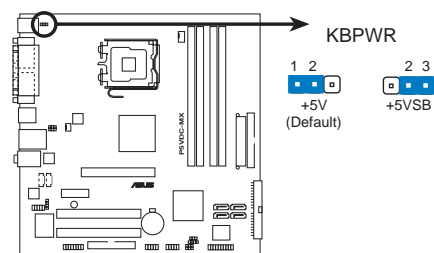

P5VDC-MX Keyboard power setting

## 3. USB device wake-up (3-pin USBPW12, USBPW34, USBPW56, USBPW78)

Set these jumpers to +5V to wake up the computer from S1 sleep mode (CPU stopped, DRAM refreshed, system running in low power mode) using the connected USB devices. Set to +5VSB to wake up from S3 and S4 sleep modes (no power to CPU, DRAM in slow refresh, power supply in reduced power mode).

The USBPW12 and USBPW34 jumpers are for the rear USB ports. The USBPW56 and USBPW78 jumpers are for the internal USB connectors that you can connect to additional USB ports.

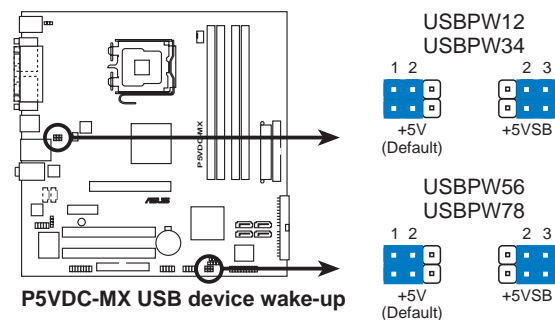

P5VDC-MX USB device wake-up



- The USB device wake-up feature requires a power supply that can provide 500mA on the +5VSB lead for each USB port; otherwise, the system would not power up.
- The total current consumed must NOT exceed the power supply capability (+5VSB) whether under normal condition or in sleep mode.

## 1.10 Connectors

### 1.10.1 Rear panel connectors

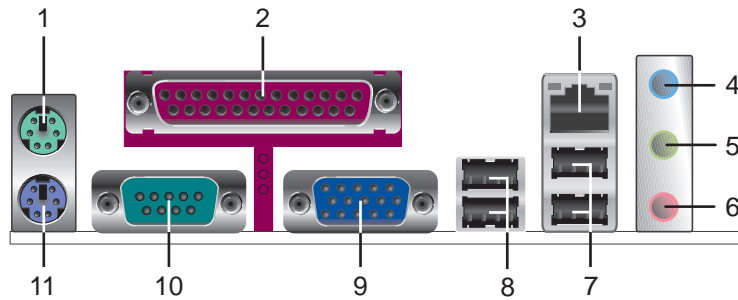

1. **PS/2 mouse port (green).** This port is for a PS/2 mouse.
2. **Parallel port.** This 25-pin port connects a parallel printer, a scanner, or other devices.
3. **LAN (RJ-45) port.** This port allows connection to a Local Area Network (LAN) through a network hub.

#### LAN port LED indications

ACT/LINK LED		SPEED LED	
Status	Description	Status	Description
OFF	No link	OFF	No link
ORANGE	100 Linked	GREEN	10 Linked
BLINKING	Data activity	BLINKING	Data activity

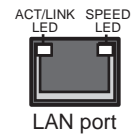

4. **Line In port (light blue).** This port connects a tape, CD, DVD player, or other audio sources. In 4-channel and 6-channel configuration, the function of this port becomes Rear Speaker Out.
5. **Line Out port (lime).** This port connects a headphone or a speaker. In 4-channel and 6-channel configuration, the function of this port becomes Front Speaker Out.
6. **Microphone port (pink).** This port connects a microphone. In a 6-channel configuration, the function of this port becomes Bass/Center Speaker.



Refer to the audio configuration table for the function of the audio ports in 2, 4, or 6-channel configuration.

### Audio 2, 4, or 6-channel configuration

Port	Headset 2-channel	4-channel	6-channel
Light Blue	Line In	Rear Speaker Out	Rear Speaker Out
Lime	Line Out	Front Speaker Out	Front Speaker Out
Pink	Mic In	Mic In	Bass/Center

- 7. USB 2.0 ports 1 and 2.** These two 4-pin Universal Serial Bus (USB) ports are available for connecting USB 2.0 devices.
- 8. USB 2.0 ports 3 and 4.** These two 4-pin Universal Serial Bus (USB) ports are available for connecting USB 2.0 devices.
- 9. VGA port.** This 15-pin VGA port connects to a VGA monitor.
- 10. Serial connector.** This 9-pin COM port is for serial devices.
- 11. PS/2 keyboard port (purple).** This port is for a PS/2 keyboard.

### 1.10.2 Internal connectors

#### 1. Floppy disk drive connector (34-1 pin FLOPPY)

This connector is for the provided floppy disk drive (FDD) signal cable. Insert one end of the cable to this connector, then connect the other end to the signal connector at the back of the floppy disk drive.



Pin 5 on the connector is removed to prevent incorrect cable connection when using an FDD cable with a covered Pin 5.

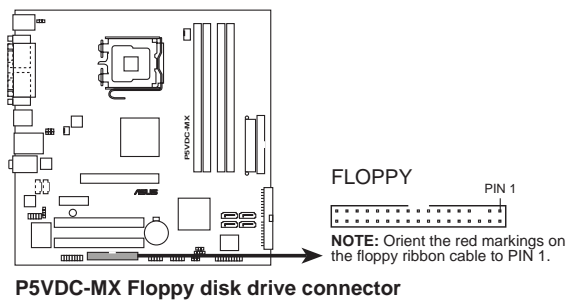

## 2. Primary/Secondary IDE connector (40-1 pin PRI\_IDE, SEC\_IDE)

The onboard IDE connectors are for Ultra DMA 133/100/66 signal cables. There are three connectors on each Ultra DMA 133/100/66 signal cable: blue, black, and gray. Connect the blue connector to the motherboard's IDE connector, and then select one of the following modes to configure your device.

	Drive jumper setting	Mode of derve(s)	Cable connector
Single device	Cable-Select or Master	-	black
Two devices	Cable-Select	Master	black
		Slave	gray
	Master	Master	black or gray
	Slave	Slave	



If any device jumper is set as "Cable-Select, " make sure all other device jumpers have the same setting.



1. Follow the hard disk drive documentation when setting the device in master or slave mode.
2. Pin 20 on each IDE connector is removed to match the covered hole on the UltraATA cable connector. This prevents incorrect orientation when you connect the cables.
3. The hole near the blue connector on the UltraATA cable is intentional.

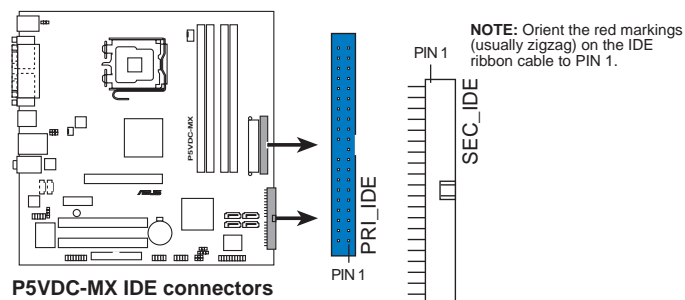

### 3. Serial ATA connectors (7-pin SATA1, SATA2, SATA3, SATA4)

These connectors are for the Serial ATA signal cables for Serial ATA hard disk drives.

If you installed Serial ATA hard disk drives, you can create a RAID 0, RAID 1, RAID 0+1 and JBOD configuration through the onboard VIA VT8251 RAID controller.

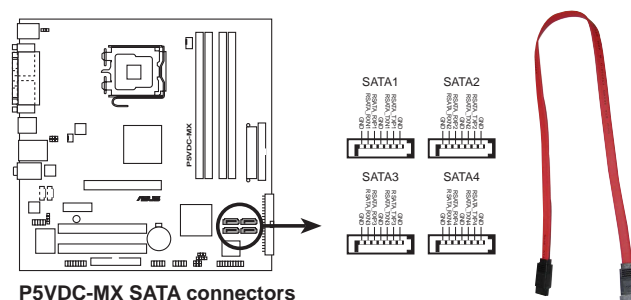

P5VDC-MX SATA connectors



#### Important notes on Serial ATA

- The Serial ATA RAID feature (RAID 0, RAID 1, RAID 0+1 and JBOD) is available only if you are using Windows® 2000/2003 Server/XP operation system.
- The SATA ports couldn't be Book Disk under Windows® 98SE and ME.
- Install the Windows® 2000 Service Pack 4, the Windows® XP Service Pack1 or later version before using Serial ATA.
- Please refer to section "VIA RAID Configuration" for details on SATA RAID configuration.

### 4. Internal audio connectors (4-pin CD, AUX)

These connectors allow you to receive stereo audio input from sound sources such as a CD-ROM, TV tuner, MPEG card or modem.

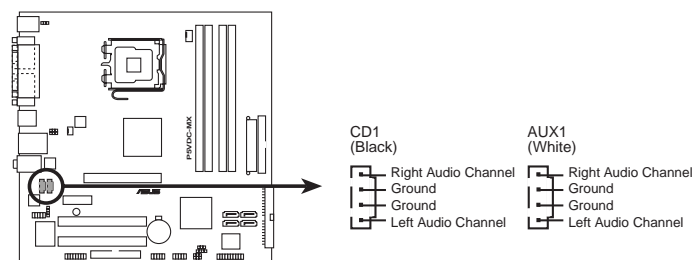

P5VDC-MX Internal audio connectors



## 5. CPU and Chassis fan connectors (4-pin CPU\_FAN, 3-pin CHA\_FAN)

The fan connectors support cooling fans of 350mA~740mA (8.88W max.) or a total of 1A~2.22A (26.64W max.) at +12V. Connect the fan cables to the fan connectors on the motherboard, making sure that the black wire of each cable matches the ground pin of the connector.



Do not forget to connect the fan cables to the fan connectors. Insufficient air flow inside the system may damage the motherboard components. These are not jumpers! DO NOT place jumper caps on the fan connectors.

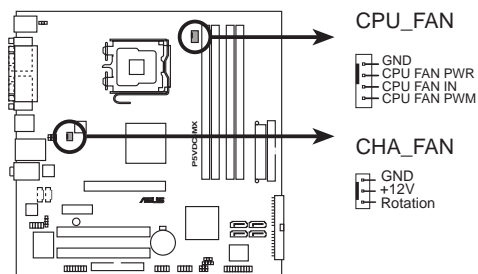

P5VDC-MX Fan connectors

## 6. Digital Audio connector (4-1 pin SPDIF)

This connector is for the S/PDIF audio module to allow digital sound output. Connect one end of the S/PDIF audio cable to this connector and the other end to the S/PDIF module.

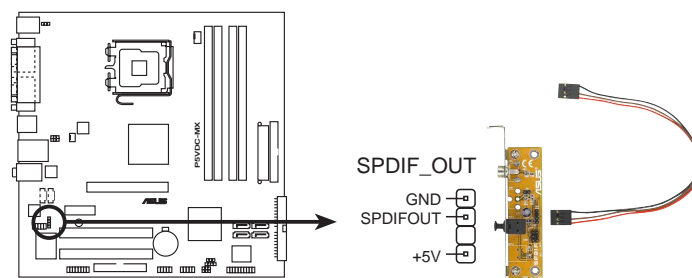

P5VDC-MX Digital audio connector



The S/PDIF out module is purchased separately.

## 7. ATX power connectors (24-pin EATXPWR, 4-pin ATX12V)

These connectors are for an ATX power supply. The plugs from the power supply are designed to fit these connectors in only one orientation. Find the proper orientation and push down firmly until the connectors completely fit.



- Do not forget to connect the 4-pin ATX +12 V power plug; otherwise, the system will not boot up.
- When using an ATX 12 V PSU with 20-pin power plug, make sure that it can provide 8 A on the +12 V lead and at least 1A on the +5V standby lead (+5 VSB). The minimum recommended wattage is 300 W, or 350 W for a fully configured system. The system may become unstable or may not boot up if the power is inadequate.
- You must install a Power Supply Unit (PSU) with a higher power rating if you intend to install additional devices.

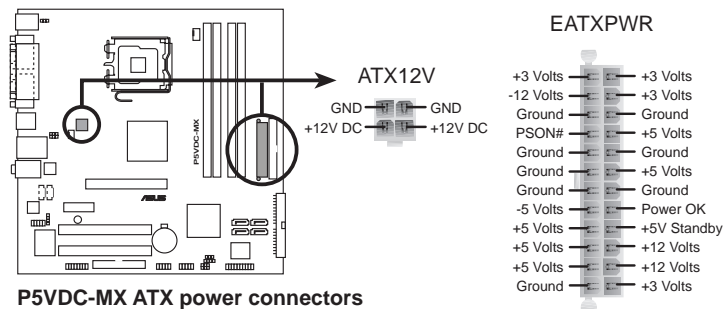

## 8. GAME/MIDI port connector (16-1 pin GAME)

This connector is for a GAME/MIDI port. Connect the USB/GAME module cable to this connector, then install the module to a slot opening at the back of the system chassis. The GAME/MIDI port connects a joystick or game pad for playing games, and MIDI devices for playing or editing audio files.

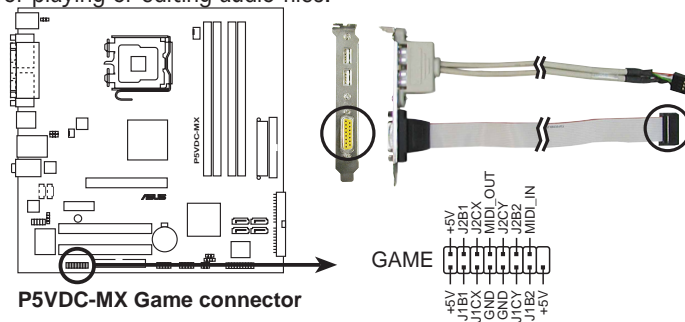

## 9. USB connectors (10-1 pin USB56, USB78)

These connectors are for USB 2.0 ports. Connect the optional USB/GAME module cable to any of these connectors, then install the module to a slot opening at the back of the system chassis. These USB connectors comply with USB 2.0 specification that supports up to 480 Mbps connection speed.

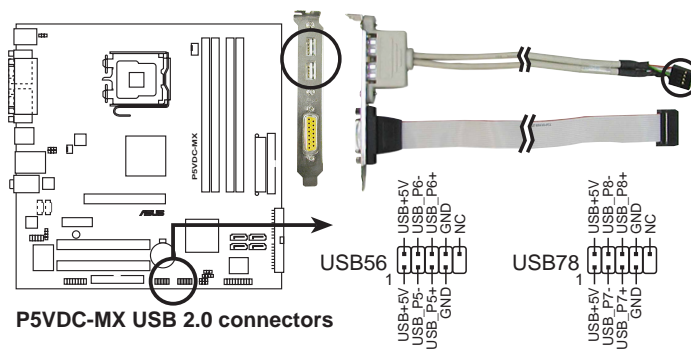

Never connect a **1394 cable** to the USB connectors. Doing so will damage the motherboard!



The USB/GAME module is purchased separately.

## 10. Front panel audio connector (10-1 pin FP\_AUDIO)

This is an interface for the front panel audio cable that allows convenient connection and control of audio devices.

By default, the pins labeled LINE\_OUT\_R/BLINE\_OUT\_R and the pins LINE\_OUT\_L/BLINE\_OUT\_L are shorted with jumper caps. Remove the caps only when you are connecting the front panel audio cable.

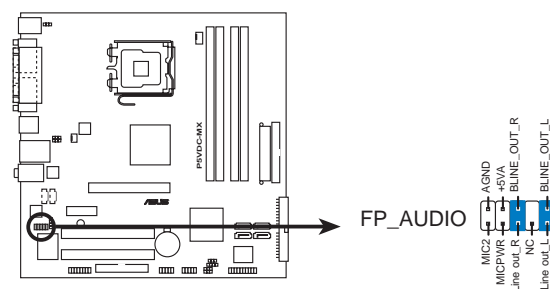

P5VDC-MX Front panel audio connector

## 11. Chassis intrusion connector (4-1 pin CHASSIS)

This connector is for a chassis-mounted intrusion detection sensor or switch. Connect one end of the chassis intrusion sensor or switch cable to this connector. The chassis intrusion sensor or switch sends a high-level signal to this connector when a chassis component is removed or replaced. The signal is then generated as a chassis intrusion event.

By default, the pins labeled “Chassis Signal” and “Ground” are shorted with a jumper cap. Remove the jumper caps only when you intend to use the chassis intrusion detection feature.

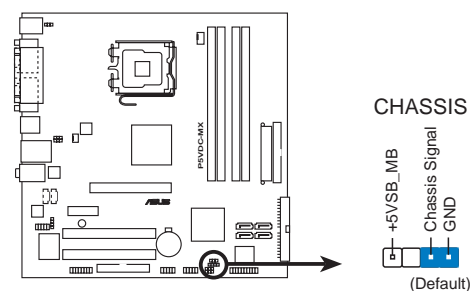

P5VDC-MX Chassis intrusion connector

## 12. System panel connector (20-1 pin F\_PANEL)

This connector supports several chassis-mounted functions.

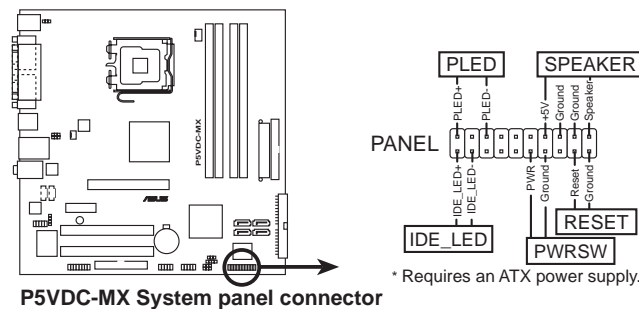

**P5VDC-MX System panel connector**



The system panel connector is color-coded for easy connection. Refer to the connector description below for details.

- **System power LED (Green 3-pin PLED)**  
This 3-pin connector is for the system power LED. Connect the chassis power LED cable to this connector. The system power LED lights up when you turn on the system power, and blinks when the system is in sleep mode.
- **Hard disk drive activity (Red 2-pin IDE\_LED)**  
This 2-pin connector is for the HDD Activity LED. Connect the HDD Activity LED cable to this connector. The IDE LED lights up or flashes when data is read from or written to the HDD.
- **System warning speaker (Orange 4-pin SPEAKER)**  
This 4-pin connector is for the chassis-mounted system warning speaker. The speaker allows you to hear system beeps and warnings.
- **Power/Soft-off button (Yellow 2-pin PWRSW)**  
This connector is for the system power button. Pressing the power button turns the system ON or puts the system in SLEEP or SOFT-OFF mode depending on the BIOS settings. Pressing the power switch for more than four seconds while the system is ON turns the system OFF.
- **Reset button (Blue 2-pin RESET)**  
This 2-pin connector is for the chassis-mounted reset button for system reboot without turning off the system power.



This chapter tells how to change the system settings through the BIOS Setup menus. Detailed descriptions of the BIOS parameters are also provided.

# BIOS setup

## 2.1 Managing and updating your BIOS

The following utilities allow you to manage and update the motherboard Basic Input/Output System (BIOS) setup.

1. **ASUS AFUDOS** (Updates the BIOS in DOS mode using a bootable floppy disk.)
2. **ASUS EZ Flash** (Updates the BIOS using a floppy disk during POST.)
3. **ASUS CrashFree BIOS 2** (Updates the BIOS using a bootable floppy disk or the motherboard support CD when the BIOS file fails or gets corrupted.)
4. **ASUS Update** (Updates the BIOS in Windows® environment.)

Refer to the corresponding sections for details on these utilities.



---

Save a copy of the original motherboard BIOS file to a bootable floppy disk in case you need to restore the BIOS in the future. Copy the original motherboard BIOS using the ASUS Update or AFUDOS utilities.

---

### 2.1.1 Creating a bootable floppy disk

1. Do either one of the following to create a bootable floppy disk.

#### DOS environment

- a. Insert a 1.44MB floppy disk into the drive.
- b. At the DOS prompt, type `format a: /s` then press <Enter>.

#### Windows® XP environment

- a. Insert a 1.44 MB floppy disk to the floppy disk drive.
- b. Click **Start** from the Windows® desktop, then select **My Computer**.
- c. Select the 3 1/2 Floppy Drive icon.
- d. Click **File** from the menu, then select **Format**. A **Format 3 1/2 Floppy Disk** window appears.
- e. Select **Create an MS-DOS startup disk** from the format options field, then click **Start**.

#### Windows® 2000 environment

To create a set of boot disks for Windows® 2000:

- a. Insert a formatted, high density 1.44 MB floppy disk into the drive.
- b. Insert the Windows® 2000 CD to the optical drive.
- c. Click **Start**, then select **Run**.
- d. From the Open field, type

`D:\bootdisk\makeboot a:`

assuming that D: is your optical drive.



- e. Press <Enter>, then follow screen instructions to continue.
2. Copy the original or the latest motherboard BIOS file to the bootable floppy disk.

### 2.1.2 ASUS EZ Flash utility

The ASUS EZ Flash feature allows you to update the BIOS without having to go through the long process of booting from a floppy disk and using a DOS-based utility. The EZ Flash utility is built-in the BIOS chip so it is accessible by pressing <Alt> + <F2> during the Power-On Self Tests (POST).



---

To use EZ Flash feature on motherboards with onboard VGA, you will not see the screen display when the BIOS is refreshed. Install a graphics card into the expansion slot to display BIOS update message.

---

To update the BIOS using EZ Flash:

1. Visit the ASUS website ([www.asus.com](http://www.asus.com)) to download the latest BIOS file for the motherboard and rename the same to **P5VDCMX.ROM**.
2. Save the BIOS file to a floppy disk, then restart the system.
3. Press <Alt> + <F2> during POST to display the following.

```
EZFlash starting BIOS update
Checking for floppy...
```

4. Insert the floppy disk that contains the BIOS file to the floppy disk drive. When the correct BIOS file is found, EZ Flash performs the BIOS update process and automatically reboots the system when done.

```
EZFlash starting BIOS update
Checking for floppy...
Floppy found!
Reading file "P5VDCMX.ROM". Completed.
Start erasing.....|
Start programming...|
Flashed successfully. Rebooting.
```



- Do not shutdown or reset the system while updating the BIOS to prevent system boot failure!
- A "Floppy not found!" error message appears if there is no floppy disk in the drive. A "P5VDCMX.ROM not found!" error message appears if the correct BIOS file is not found in the floppy disk. Make sure that you rename the BIOS file to P5VDCMX.ROM.

### 2.1.3 AFUDOS utility

The AFUDOS utility allows you to update the BIOS file in DOS environment using a bootable floppy disk with the updated BIOS file. This utility also allows you to copy the current BIOS file that you can use as backup when the BIOS fails or gets corrupted during the updating process.

#### Copying the current BIOS

To copy the current BIOS file using the AFUDOS utility:



- Make sure that the floppy disk is not write-protected and has at least 600 KB free space to save the file.
- The succeeding BIOS screens are for reference only. The actual BIOS screen displays may not be exactly the same as shown.

1. Copy the AFUDOS utility (afudos.exe) from the motherboard support CD to the bootable floppy disk you created earlier.
2. Boot the system in DOS mode, then at the prompt type:

```
afudos /o[filename]
```

where the [filename] is any user-assigned filename not more than eight alphanumeric characters for the main filename and three alphanumeric characters for the extension name.

```
A:\>afudos /oOLDBIOS1.ROM
```

Main filename    Extension name

3. Press <Enter>. The utility copies the current BIOS file to the floppy disk.

```
A:\>afudos /oOLDBIOS1.ROM
AMI Firmware Update Utility - Version 1.10
Copyright (C) 2002 American Megatrends, Inc. All rights reserved.
Reading flash ..... done
A:\>
```

The utility returns to the DOS prompt after copying the current BIOS file.

## Updating the BIOS file

To update the BIOS file using the AFUDOS utility:

1. Visit the ASUS website ([www.asus.com](http://www.asus.com)) and download the latest BIOS file for the motherboard. Save the BIOS file to a bootable floppy disk.



Write the BIOS filename on a piece of paper. You need to type the exact BIOS filename at the DOS prompt.

2. Copy the AFUDOS utility (afudos.exe) from the motherboard support CD to the bootable floppy disk you created earlier.
3. Boot the system in DOS mode, then at the prompt type:

```
afudos /i[filename]
```

where [filename] is the latest or the original BIOS file on the bootable floppy disk.

```
A:\>afudos /iP5VDCMX.ROM
```

4. The utility verifies the file and starts updating the BIOS.

```
A:\>afudos /iP5VDCMX.ROM
AMI Firmware Update Utility - Version 1.10
Copyright (C) 2002 American Megatrends, Inc. All rights reserved.
Reading file ..... done
Erasing flash .... done
Writing flash .... 0x0008CC00 (9%)
```



Do not shut down or reset the system while updating the BIOS to prevent system boot failure!

5. The utility returns to the DOS prompt after the BIOS update process is completed. Reboot the system from the hard disk drive.

```
A:\>afudos /iP5VDCMX.ROM
AMI Firmware Update Utility - Version 1.10
Copyright (C) 2002 American Megatrends, Inc. All rights reserved.
Reading file ..... done
Erasing flash .... done
Writing flash .... 0x0008CC00 (9%)
Verifying flash .. done
A:\>
```

## 2.1.4 ASUS CrashFree BIOS 2 utility

The ASUS CrashFree BIOS 2 is an auto recovery tool that allows you to restore the BIOS file when it fails or gets corrupted during the updating process. You can update a corrupted BIOS file using the motherboard support CD or the floppy disk that contains the updated BIOS file.



- Prepare the motherboard support CD or the floppy disk containing the updated motherboard BIOS before using this utility.
- Make sure that you rename the original or updated BIOS file in the floppy disk to **P5VDCMX.ROM**.



To use CrashFree BIOS2 feature on motherboards with onboard VGA, you will not see the screen display when the BIOS crashes even when you reboot the system. Install a graphics card into the expansion slot before rebooting the computer to display BIOS recovery message.

### Recovering the BIOS from a floppy disk

To recover the BIOS from a floppy disk:

1. Turn on the system.
2. Insert the floppy disk with the original or updated BIOS file to the floppy disk drive.
3. The utility displays the following message and automatically checks the floppy disk for the original or updated BIOS file.

```
Bad BIOS checksum. Starting BIOS recovery...  
Checking for floppy...
```

When found, the utility reads the BIOS file and starts flashing the corrupted BIOS file.

```
Bad BIOS checksum. Starting BIOS recovery...  
Checking for floppy...  
Floppy found!  
Reading file "P5VDCMX.ROM". Completed.  
Start flashing...
```



DO NOT shut down or reset the system while updating the BIOS! Doing so can cause system boot failure!

4. Restart the system after the utility completes the updating process.

## Recovering the BIOS from the support CD

To recover the BIOS from the support CD:

1. Remove any floppy disk from the floppy disk drive, then turn on the system.
2. Insert the support CD to the optical drive.
3. The utility displays the following message and automatically checks the floppy disk for the original or updated BIOS file.

```
Bad BIOS checksum. Starting BIOS recovery...  
Checking for floppy...
```

When no floppy disk is found, the utility automatically checks the optical drive for the original or updated BIOS file. The utility then updates the corrupted BIOS file.

```
Bad BIOS checksum. Starting BIOS recovery...  
Checking for floppy...  
Floppy not found!  
Checking for CD-ROM...  
CD-ROM found!  
Reading file "P5VDCMX.ROM". Completed.  
Start flashing...
```



---

DO NOT shut down or reset the system while updating the BIOS! Doing so can cause system boot failure!

---

4. Restart the system after the utility completes the updating process.



---

The recovered BIOS may not be the latest BIOS version for this motherboard. Visit the ASUS website ([www.asus.com](http://www.asus.com)) to download the latest BIOS file.

---

### 2.1.5 ASUS Update utility

The ASUS Update is a utility that allows you to manage, save, and update the motherboard BIOS in Windows® environment. The ASUS Update utility allows you to:

- Save the current BIOS file
- Download the latest BIOS file from the Internet
- Update the BIOS from an updated BIOS file
- Update the BIOS directly from the Internet, and
- View the BIOS version information.

This utility is available in the support CD that comes with the motherboard package.



---

ASUS Update requires an Internet connection either through a network or an Internet Service Provider (ISP).

---

### Installing ASUS Update

To install ASUS Update:

1. Place the support CD in the optical drive. The **Drivers** menu appears.
2. Click the **Utilities** tab, then click **Install ASUS Update VX.XX.XX**. See page 3-4 for the **Utilities** screen menu.
3. The ASUS Update utility is copied to your system.



---

Quit all Windows® applications before you update the BIOS using this utility.

---

## Updating the BIOS through the Internet

To update the BIOS through the Internet:

1. Launch the ASUS Update utility from the Windows® desktop by clicking **Start > Programs > ASUS > ASUSUpdate > ASUSUpdate**. The ASUS Update main window appears.

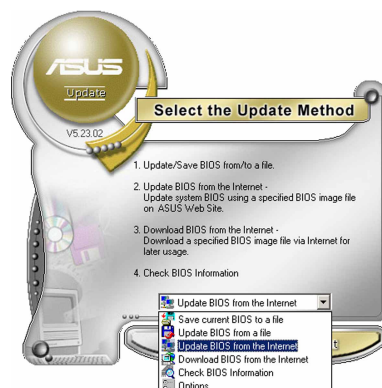
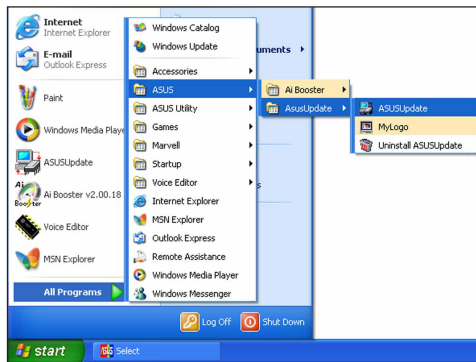

2. Select **Update BIOS from the Internet** option from the drop-down menu, then click **Next**.



3. Select the ASUS FTP site nearest you to avoid network traffic, or click **Auto Select**. Click **Next**.

4. From the FTP site, select the BIOS version that you wish to download. Click Next.
5. Follow the screen instructions to complete the update process.



The ASUS Update utility is capable of updating itself through the Internet. Always update the utility to avail all its features.

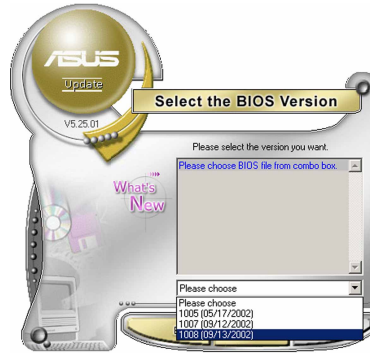

### Updating the BIOS through a BIOS file

To update the BIOS through a BIOS file:

1. Launch the ASUS Update utility from the Windows® desktop by clicking **Start > Programs > ASUS > ASUSUpdate > ASUSUpdate**. The ASUS Update main window appears.
2. Select **Update BIOS from a file** option from the drop-down menu, then click **Next**.

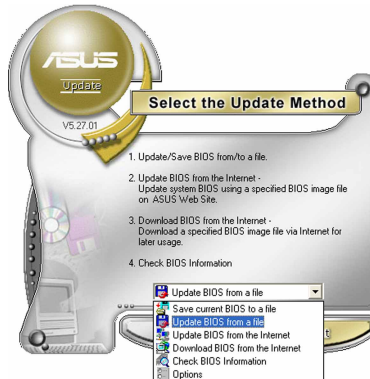

3. Locate the BIOS file from the **Open** window, then click **Save**.
4. Follow the screen instructions to complete the update process.

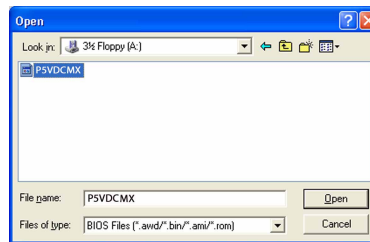



## 2.2 BIOS setup program

This motherboard supports a programmable firmware chip that you can update using the provided utility described in section “2.1 Managing and updating your BIOS.”

Use the BIOS Setup program when you are installing a motherboard, reconfiguring your system, or prompted to “Run Setup”. This section explains how to configure your system using this utility.

Even if you are not prompted to use the Setup program, you can change the configuration of your computer in the future. For example, you can enable the security password feature or change the power management settings. This requires you to reconfigure your system using the BIOS Setup program so that the computer can recognize these changes and record them in the CMOS RAM of the firmware hub.

The firmware hub on the motherboard stores the Setup utility. When you start up the computer, the system provides you with the opportunity to run this program. Press <Del> during the Power-On Self-Test (POST) to enter the Setup utility; otherwise, POST continues with its test routines.

If you wish to enter Setup after POST, restart the system by pressing <Ctrl+Alt+Delete>, or by pressing the reset button on the system chassis. You can also restart by turning the system off and then back on. Do this last option only if the first two failed.

The Setup program is designed to make it as easy to use as possible. Being a menu-driven program, it lets you scroll through the various sub-menus and make your selections from the available options using the navigation keys.



- 
- The default BIOS settings for this motherboard apply for most conditions to ensure optimum performance. If the system becomes unstable after changing any BIOS settings, load the default settings to ensure system compatibility and stability. Select the **Load Default Settings** item under the Exit Menu. See section “2.7 Exit Menu.”
  - The BIOS setup screens shown in this section are for reference purposes only, and may not exactly match what you see on your screen.
  - Visit the ASUS website ([www.asus.com](http://www.asus.com)) to download the latest BIOS file for this motherboard and .
-

## 2.2.1 BIOS menu screen

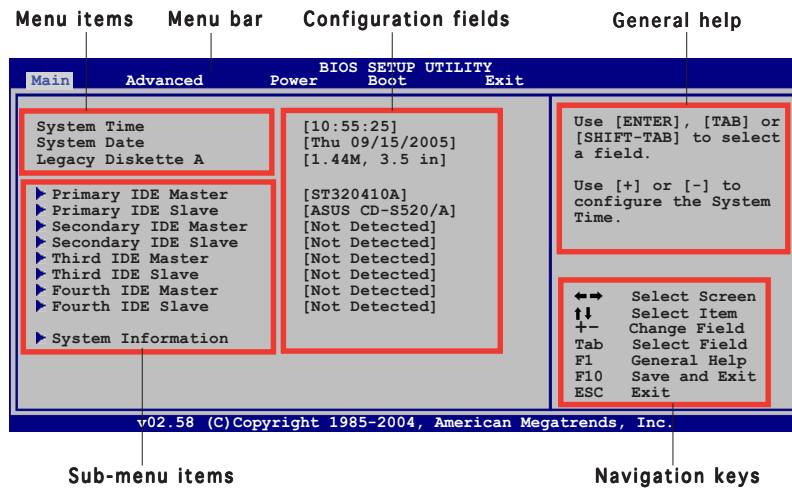

## 2.2.2 Menu bar

The menu bar on top of the screen has the following main items:

- Main** For changing the basic system configuration
- Advanced** For changing the advanced system settings
- Power** For changing the advanced power management (APM) configuration
- Boot** For changing the system boot configuration
- Exit** For selecting the exit options and loading default settings

To select an item on the menu bar, press the right or left arrow key on the keyboard until the desired item is highlighted.

## 2.2.3 Navigation keys

At the bottom right corner of a menu screen are the navigation keys for that particular menu. Use the navigation keys to select items in the menu and change the settings.



Some of the navigation keys differ from one screen to another.

## 2.2.4 Menu items

The highlighted item on the menu bar displays the specific items for that menu. For example, selecting **Main** shows the Main menu items.

The other items (Advanced, Power, Boot, and Exit) on the menu bar have their respective menu items.

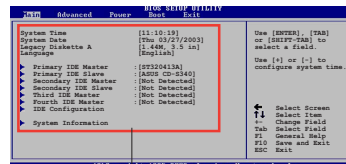

Main menu items

## 2.2.5 Sub-menu items

A solid triangle before each item on any menu screen means that the item has a sub-menu. To display the sub-menu, select the item and press <Enter>.

## 2.2.6 Configuration fields

These fields show the values for the menu items. If an item is user-configurable, you can change the value of the field opposite the item. You cannot select an item that is not user-configurable.

A configurable field is enclosed in brackets, and is highlighted when selected. To change the value of a field, select it then press <Enter> to display a list of options. Refer to “2.2.7 Pop-up window.”

## 2.2.7 Pop-up window

Select a menu item then press <Enter> to display a pop-up window with the configuration options for that item.

## 2.2.8 Scroll bar

A scroll bar appears on the right side of a menu screen when there are items that do not fit on the screen.

Press the Up/Down arrow keys or <Page Up> / <Page Down> keys to display the other items on the screen.

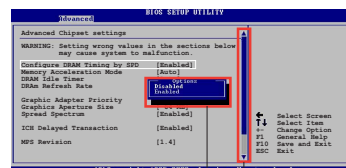

Pop-up window

Scroll bar

## 2.2.9 General help

At the top right corner of the menu screen is a brief description of the selected item.

## 2.3 Main menu

When you enter the BIOS Setup program, the Main menu screen appears, giving you an overview of the basic system information.



Refer to section “2.2.1 BIOS menu screen” for information on the menu screen items and how to navigate through them.

```

BIOS SETUP UTILITY
Main  Advanced  Power  Boot  Exit
-----
System Time          [10:55:25]
System Date          [Thu 07/21/2005]
Legacy Diskette A    [1.44M, 3.5 in]

▶ Primary IDE Master  [ST320410A]
▶ Primary IDE Slave   [ASUS CD-S520/A]
▶ Secondary IDE Master [Not Detected]
▶ Secondary IDE Slave [Not Detected]
▶ Third IDE Master    [Not Detected]
▶ Third IDE Slave     [Not Detected]
▶ Fourth IDE Master   [Not Detected]
▶ Fourth IDE Slave    [Not Detected]

▶ System Information

Use [ENTER], [TAB] or [SHIFT-TAB] to select a field.

Use [+] or [-] to configure the System Time.

←→ Select Screen
↑↓ Select Item
+- Change Field
Tab Select Field
F1 General Help
F10 Save and Exit
ESC Exit

v02.58 (C)Copyright 1985-2004, American Megatrends, Inc.
```

### 2.3.1 System Time [xx:xx:xxxx]

Allows you to set the system time.

### 2.3.2 System Date [Day xx/xx/xxxx]

Allows you to set the system date.

### 2.3.3 Legacy Diskette A [1.44M, 3.5 in.]

Sets the type of floppy drive installed. Configuration options: [Disabled] [360K, 5.25 in.] [1.2M, 5.25 in.] [720K, 3.5 in.] [1.44M, 3.5 in.] [2.88M, 3.5 in.]

### 2.3.4 Primary and Secondary IDE Master/Slave

While entering Setup, the BIOS automatically detects the presence of IDE devices. There is a separate sub-menu for each IDE device. Select a device item then press <Enter> to display the IDE device information.

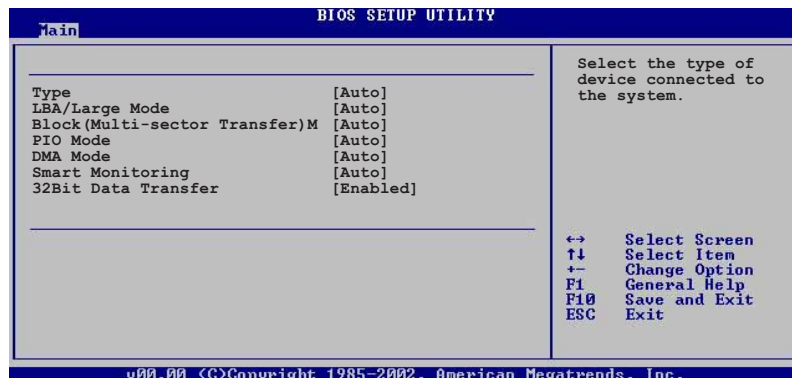

The BIOS automatically detects the values opposite the dimmed items (Device, Vendor, Size, LBA Mode, Block Mode, PIO Mode, Async DMA, Ultra DMA, and SMART monitoring). These values are not user-configurable. These items show N/A if no IDE device is installed in the system.

#### **Type [Auto]**

Selects the type of IDE drive. Setting to Auto allows automatic selection of the appropriate IDE device type. Select CDROM if you are specifically configuring a CD-ROM drive. Select ARMD (ATAPI Removable Media Device) if your device is either a ZIP, LS-120, or MO drive.

Configuration options: [Not Installed] [Auto] [CDROM] [ARMD]

#### **LBA/Large Mode [Auto]**

Enables or disables the LBA mode. Setting to Auto enables the LBA mode if the device supports this mode, and if the device was not previously formatted with LBA mode disabled.

Configuration options: [Disabled] [Auto]

#### **Block (Multi-sector Transfer) M [Auto]**

Enables or disables data multi-sectors transfers. When set to Auto, the data transfer from and to the device occurs multiple sectors at a time if the device supports multi-sector transfer feature. When set to [Disabled], the data transfer from and to the device occurs one sector at a time.

Configuration options: [Disabled] [Auto]

### **PIO Mode [Auto]**

Selects the PIO mode.

Configuration options: [Auto] [0] [1] [2] [3] [4]

### **DMA Mode [Auto]**

Selects the DMA mode. Configuration options: [Auto] [SWDMA0]

[SWDMA1] [SWDMA2] [MWDMA0] [MWDMA1] [MWDMA2] [UDMA0]

[UDMA1] [UDMA2] [UDMA3] [UDMA04] [UDMA5] [UDMA6]

### **SMART Monitoring [Auto]**

Sets the Smart Monitoring, Analysis, and Reporting Technology.

Configuration options: [Auto] [Disabled] [Enabled]

### **32Bit Data Transfer [Enabled]**

Enables or disables 32-bit data transfer.

Configuration options: [Disabled] [Enabled]

## **2.3.5 System Information**

This menu gives you an overview of the general system specifications. The BIOS automatically detects the items in this menu.

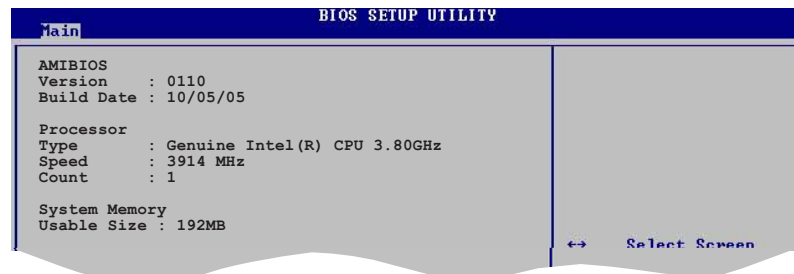

### **AMI BIOS**

Displays the auto-detected BIOS information

### **Processor**

Displays the auto-detected CPU specification

### **System Memory**

Displays the auto-detected system memory

## 2.4 Advanced menu

The Advanced menu items allow you to change the settings for the CPU and other system devices.



Take caution when changing the settings of the Advanced menu items. Incorrect field values may cause the system to malfunction.

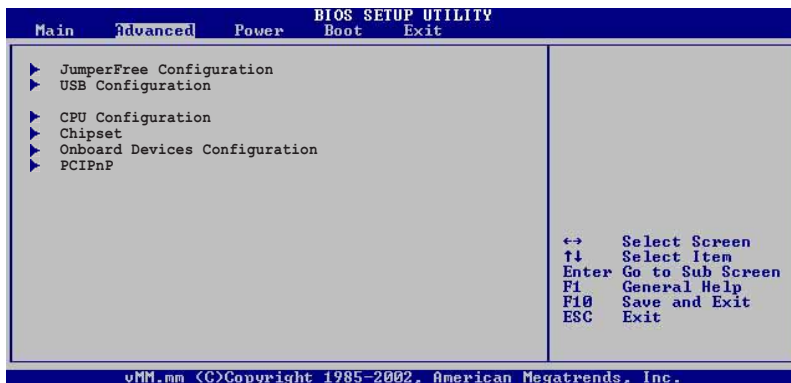

### 2.4.1 JumperFree Configuration

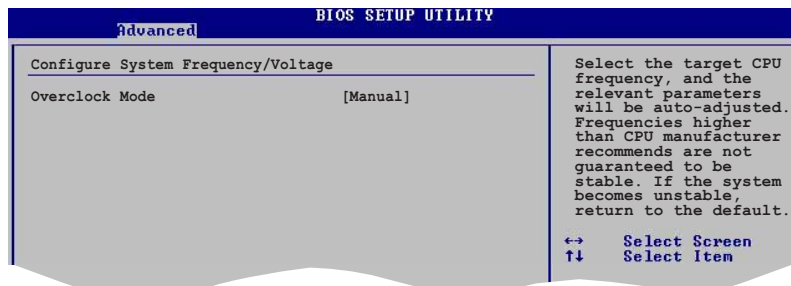

#### Overclock Mode [Auto]

Allows selection of CPU overclocking options to achieve desired CPU internal frequency. Select either one of the preset overclocking configuration options:

**Manual** - allows you to individually set overclocking parameters.

**Auto** - loads the optimal settings for the system.

#### *CPU Frequency [200 MHz]*

Displays the frequency sent by the clock generator to the system bus and PCI bus. The value of this item is auto-detected by the BIOS. Use the <+> and <-> keys to adjust the CPU frequency. You can also type the desired CPU frequency using the numeric keypad. The values range from 100 to 400.

## 2.4.2 USB Configuration

The items in this menu allows you to change the USB-related features. Select an item then press Enter to display the configuration options.

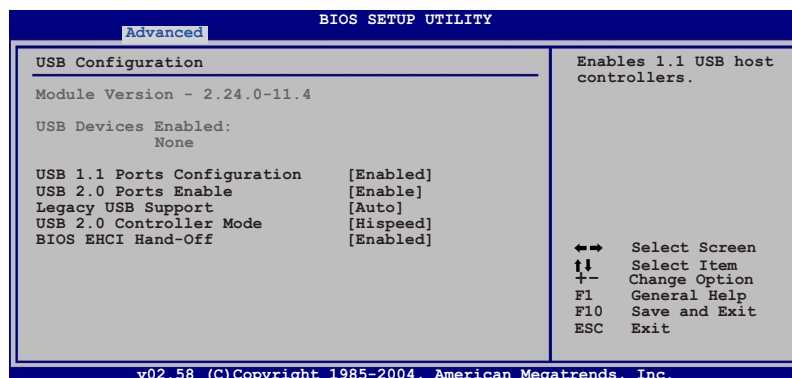

The Module Version and USB Devices Enabled items show the auto-detected values. If no USB device is detected, the item shows None.

### USB 1.1 Ports Configuration [Enabled]

Allows you to choose the number of USB 1.1 ports to enable. Setting to [Disabled] disables the USB 1.1 host controllers. Configuration options: [Disabled] [Enabled]

### USB 2.0 Ports Enable [Enable]

Allows you to enable or disable the USB 2.0 host controllers. Configuration options: [Disabled] [Enable]

### Legacy USB Support [Auto]

Allows you to enable or disable support for legacy USB devices. Setting to Auto allows the system to detect the presence of USB devices at startup. If detected, the USB controller legacy mode is enabled. If no USB device is detected, the legacy USB support is disabled. Configuration options: [Disabled] [Enabled] [Auto]

### USB 2.0 Controller Mode [Hispeed]

Allows you to configure the USB 2.0 controller in HiSpeed (480 Mbps) or Full Speed (12 Mbps). Configuration options: [FullSpeed] [HiSpeed]



## BIOS EHCI Hand-Off [Enabled]

Allows you to enable support for operating systems without an EHCI hand-off feature. Configuration options: [Disabled] [Enabled]



Do not disable the BIOS EHCI Hand-Off option if you are running a Windows® operating system with USB device.

## 2.4.3 CPU Configuration

The items in this menu show the CPU-related information auto-detected by BIOS.

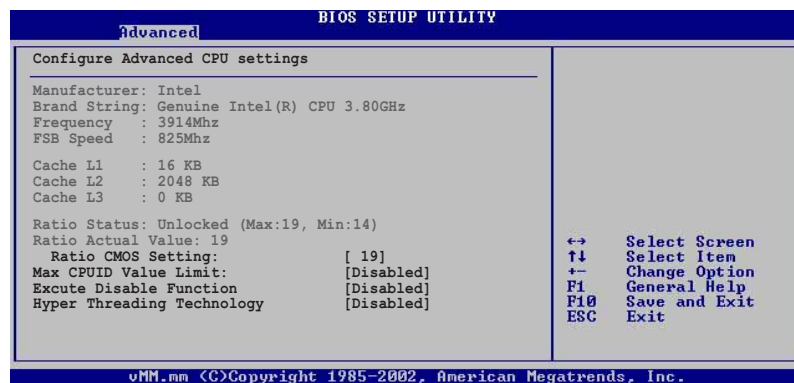

### Ratio CMOS Setting [ 16]

Sets the ratio between the CPU Core Clock and the Front Side Bus frequency. The default value of this item is auto-detected by BIOS. Use the <+> or <-> keys to adjust the values.

### Max CPUID Value Limit [Disabled]

Enable this item to boot legacy operating systems that cannot support CPUs with extended CPUID functions.  
Configuration options: [Disabled] [Enabled]

### Execute Disable Function [Disabled]

Enables or disables the Execute Disable function. This item appears only when you install a processor with the Execute Disable function.  
Configuration options: [Disabled] [Enabled]

### Hyper-Threading Technology [Disabled]

This item allows you to enable or disable the processor Hyper-Threading Technology. Configuration options: [Disabled] [Enabled]

## 2.4.4 Chipset

The Chipset menu items allow you to change the advanced chipset settings. Select an item then press <Enter> to display the sub-menu.

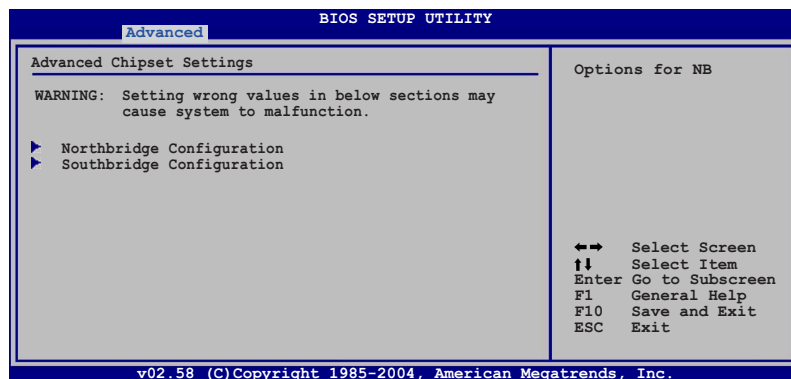

### NorthBridge Configuration

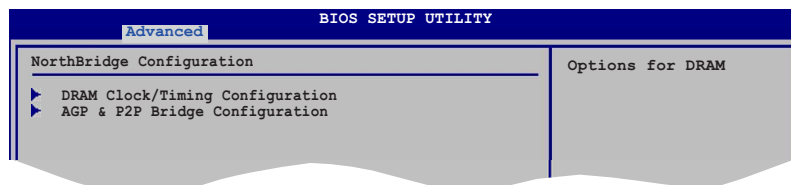

## DRAM Frequency/Timing Configuration

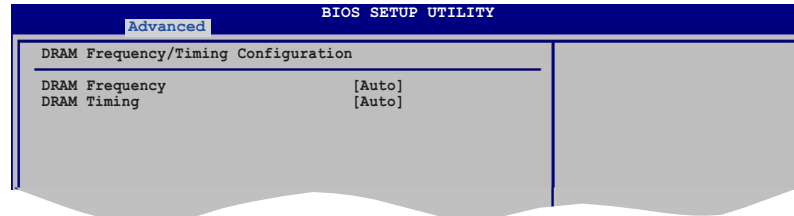

### DRAM Frequency [Auto]

Sets the DDR/DDR2 operating frequency. Configuration options when install DDR memory modules: [Auto] [266 MHz] [333 MHz] [400 MHz]; Configuration options when install DDR2 memory modules: [Auto] [400 MHz] [533 MHz]

### DRAM Timing [Auto]

Configuration options: [Manual] [Auto]



The following items only appear when the DRAM Timing item is set to [Manual].

#### *DRAM CAS# Latency [DDR/DDR2] [2.5/4]*

Configuration options: [1.5/2] [2.0/3] [2.5/4] [3.0/5]

#### *Precharge to Active (Trp) [4T]*

Configuration options: [2T] [3T] [4T] [5T]

#### *Active to Precharge (Tras) [7T]*

Configuration options: [5T] [6T] [7T] [8T] [9T] [10T] [11T] [12T] [13T] [14T] [15T] [16T] [17T] [18T] [19T] [20T]

#### *REF to ACT/REF to REF (Trfc) [25T]*

Configuration options: [24T] [25T] [26T] [27T] [28T] [29T] [30T] [31T] [32T] ~ [39T]

#### *Active to Command (Trcd) [4T]*

Configuration options: [2T] [3T] [4T] [5T]

## AGP & P2P Bridge Configuration

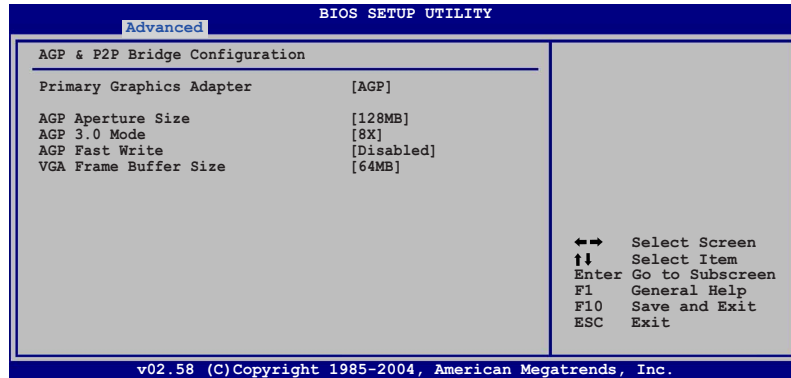

### Primary Graphics Adapter [AGP]

Allows selection of the graphics controller to use as primary boot device.  
Configuration options: [PCI] [AGP]

### AGP Aperture Size [128MB]

Allows you to set the graphics aperture size.  
Configuration options: [32MB] [64MB] [128MB] [256MB] [512MB] [1GB]

### AGP 3.0 Mode [8X]

Allows you to set the AGP 3.0 mode.  
Configuration options: [8X] [4X]

### AGP Fast Write [Disabled]

Allows you to enable or disable the AGP Fast Write feature.  
Configuration options: [Disabled] [Enabled]

### VGA Frame Buffer Size [64MB]

Allows you to set the frame buffer size.  
Configuration options: [16MB] [32MB] [64MB]

## SouthBridge Configuration

Advanced		BIOS SETUP UTILITY	
* Serial ATA Controller	[SATA]		
* Onboard LAN	[Enabled]		
LAN Optional ROM	[Disabled]		
* AC'97 Audio Controller	[Enabled]		

### Serial ATA Controller [SATA]

Allows you to set the Serial ATA mode.

Configuration options: [Disabled] [SATA] [RAID]

### Onboard LAN [Enabled]

Allows you to enable or disable the onboard LAN.

Configuration options: [Disabled] [Enabled]

### LAN Optional ROM [Disabled]

Allows you to enable or disable the onboard LAN optional ROM. The item appears only when the **LAN Controller** item is set to **Enabled**.

Configuration options: [Disabled] [Enabled]

### AC'97 Audio Controller [Enabled]

Allows you to enable or disable the AC'97 Audio.

Configuration options: [Disabled] [Enabled]

## 2.4.5 Onboard Devices Configuration

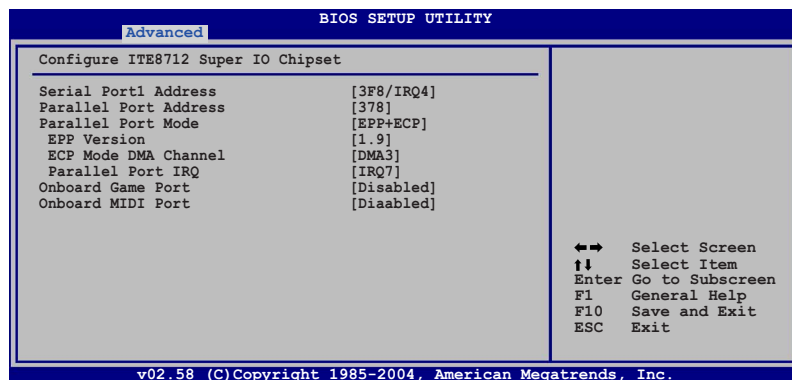

### Serial Port1 Address [3F8/IRQ4]

Allows you to select the Serial Port1 base address.

Configuration options: [Disabled] [3F8/IRQ4] [2F8/IRQ3] [3E8/IRQ4] [2E8/IRQ3]

### Parallel Port Address [378]

Allows you to select the Parallel Port base addresses. Configuration options: [Disabled] [378] [278]

### Parallel Port Mode [EPP+ECP]

Allows you to select the Parallel Port mode. Configuration options: [Normal] [EPP] [ECP] [EPP+ECP]

### EPP Version [1.9]

Allows selection of the Parallel Port EPP version. This item appears only when the **Parallel Port Mode** is set to **EPP**.

Configuration options: [1.9] [1.7]

### ECP Mode DMA Channel [DMA3]

Allows selection of the Parallel Port ECP DMA channel. This item appears only when the **Parallel Port Mode** is set to **ECP**. Configuration options: [DMA0] [DMA1] [DMA3]

### Parallel Port IRQ [IRQ7]

Allows you to select the Parallel Port IRQ. Configuration options: [IRQ5] [IRQ7]

### Onboard Game Port [Disabled]

Allows you to enable or disable the onboard Game port. Configuration options: [Disabled] [Enabled]

### Onboard MIDI Port [Disabled]

Allows you to enable or disable the onboard MIDI port. Configuration options: [Disabled] [300] [330]

## 2.4.6 PCI PnP

The PCI PnP menu items allow you to change the advanced settings for PCI/PnP devices. The menu includes setting IRQ and DMA channel resources for either PCI/PnP or legacy ISA devices, and setting the memory size block for legacy ISA devices.



Take caution when changing the settings of the PCI PnP menu items. Incorrect field values can cause the system to malfunction.



### Plug and Play O/S [No]

When set to [No], BIOS configures all the devices in the system. When set to [Yes] and if you install a Plug and Play operating system, the operating system configures the Plug and Play devices not required for boot. Configuration options: [No] [Yes]

### PCI Latency Timer [64]

Allows you to select the value in units of PCI clocks for the PCI device latency timer register. Configuration options: [32] [64] [96] [128] [160] [192] [224] [248]

**Allocate IRQ to PCI VGA [Yes]**

When set to [Yes], BIOS assigns an IRQ to PCI VGA card if the card requests for an IRQ. When set to [No], BIOS does not assign an IRQ to the PCI VGA card even if requested. Configuration options: [Yes] [No]

**Palette Snooping [Disabled]**

When set to [Enabled], the palette snooping feature informs the PCI devices that an ISA graphics device is installed in the system so that the latter can function correctly. Configuration options: [Disabled] [Enabled]

**IRQ-xx assigned to [PCI Device]**

When set to [PCI Device], the specific IRQ is free for use of PCI/PnP devices. When set to [Reserved], the IRQ is reserved for legacy ISA devices. Configuration options: [PCI Device] [Reserved]



## 2.5 Power menu

The Power menu items allow you to change the settings for the Advanced Configuration and Power Interface (ACPI) and the Advanced Power Management (APM). Select an item then press <Enter> to display the configuration options.

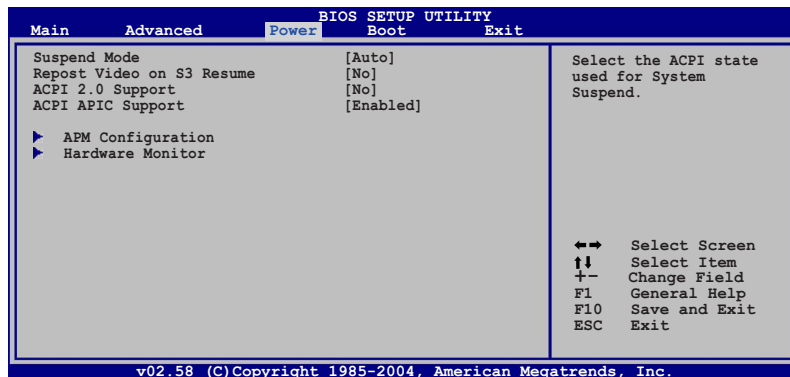

### 2.5.1 Suspend Mode [Auto]

Allows you to select the Advanced Configuration and Power Interface (ACPI) state to be used for system suspend.

Configuration options: [S1 (POS) Only] [S3 Only] [Auto]

### 2.5.2 Repost Video on S3 Resume [No]

Determines whether to invoke VGA BIOS POST on S3/STR resume.

Configuration options: [No] [Yes]

### 2.5.3 ACPI 2.0 Support [No]

Allows you to add more tables for Advanced Configuration and Power Interface (ACPI) 2.0 specifications. Configuration options: [No] [Yes]

### 2.5.4 ACPI APIC Support [Enabled]

Allows you to enable or disable the Advanced Configuration and Power Interface (ACPI) support in the Application-Specific Integrated Circuit (ASIC). When set to Enabled, the ACPI APIC table pointer is included in the RSDT pointer list. Configuration options: [Disabled] [Enabled]

## 2.5.5 APM Configuration

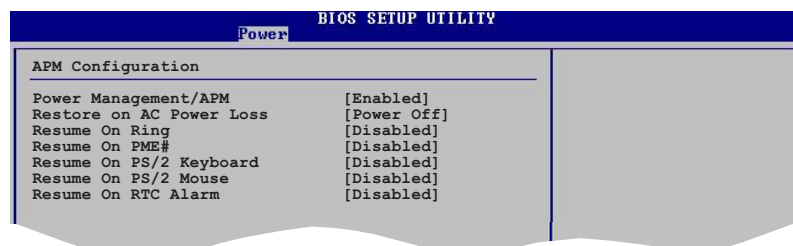

### **Power Management/APM [Enabled]**

Allows you to enable or disable the advanced power management feature.  
Configuration options: [Disabled] [Enabled]

### **Restore on AC Power Loss [Power Off]**

When set to Power Off, the system goes into off state after an AC power loss. When set to Power On, the system goes on after an AC power loss. When set to Last State, the system goes into either off or on state, whatever the system state was before the AC power loss.  
Configuration options: [Power OFF] [Power On] [Last State]

### **Resume On Ring [Disabled]**

When set to [Enabled], the system enables the RI to generate a wake event while the computer is in Soft-off mode.  
Configuration options: [Disabled] [Enabled]

### **Resume On PME# [Disabled]**

When set to [Enabled], the system enables the PME to generate a wake event while the computer is in Soft-off mode.  
Configuration options: [Disabled] [Enabled]

### **Resume On PS/2 Keyboard [Disabled]**

Allows you to disable the PS/2 Power-On by keyboard feature or use specific keys on the keyboard to turn on the system. This feature requires an ATX power supply that provides at least 1A on the +5VSB lead.  
Configuration options: [Disabled] [Enabled]

### **Resume On PS/2 Mouse [Disabled]**

When set to [Enabled], this parameter allows you to use the PS/2 mouse to turn on the system. This feature requires an ATX power supply that provides at least 1A on the +5VSB lead. Configuration options: [Disabled] [Enabled]

## Resume On RTC Alarm [Disabled]

Allows you to enable or disable RTC to generate a wake event. When this item is set to **Enabled**, the items RTC Alarm Date, RTC Alarm Hour, RTC Alarm Minute, and RTC Alarm Second appear with set values. Configuration options: [Disabled] [Enabled]

## 2.5.6 Hardware Monitor

Power		BIOS SETUP UTILITY	
Hardware Monitor			
CPU Temperature	[51°C/122.5°F]		
MB Temperature	[41°C/105.5°F]		
CPU Fan Speed	[3813 RPM]		
Chassis Fan Speed	[N/A]		
VCORE Voltage	[ 1.320V]		
3.3V Voltage	[ 3.345V]		
5V Voltage	[ 5.094V]		
12V Voltage	[11.880V]		
Q-FAN Function	[Disabled]	↔	Select Screen
		↑↓	Select Item
		+−	Change Option
		F1	General Help

### CPU Temperature [xxxC/xxxF]

### MB Temperature [xxxC/xxxF]

The onboard hardware monitor automatically detects and displays the motherboard and CPU temperatures. Select Ignored if you do not wish to display the detected temperatures.

### CPU Fan Speed [xxxxRPM] or [N/A]

The onboard hardware monitor automatically detects and displays the CPU fan speed in rotations per minute (RPM). If the fan is not connected to the motherboard, the field shows N/A. Select Ignored if you do not wish to display the detected fan speed.

### Chassis Fan Speed [xxxxRPM] or [N/A]

The onboard hardware monitor automatically detects and displays the chassis fan speed in rotations per minute (RPM). If the fan is not connected to the chassis, the specific field shows N/A. Select Ignored if you do not wish to display the detected fan speed.

## VCORE Voltage, 3.3V Voltage, 5V Voltage, 12V Voltage

The onboard hardware monitor automatically detects the voltage output through the onboard voltage regulators.

## Q-FAN Function [Disabled]

Allows you to disable or enable the Q-Fan function that monitors the CPU/System temperature and smartly adjust the fan speed. Configuration options: [Disabled] [Enabled]



The CPU Fan Ratio item appears when you enable the CPU Q-Fan Function.

## CPU Fan Ratio [Auto]

Allows you to select the appropriate CPU fan speed ratio for the system. The default [Auto] automatically selects the fan speed ratio when operate the low CPU temperature. Select a higher ratio if you installed additional devices and the system requires more ventilation. This item appears only when the CPU Q-Fan Function is Enabled. Configuration options: Configuration options: [Auto] [90%] [80%]~[20%]

## 2.6 Boot menu

The Boot menu items allow you to change the system boot options. Select an item then press <Enter> to display the sub-menu.

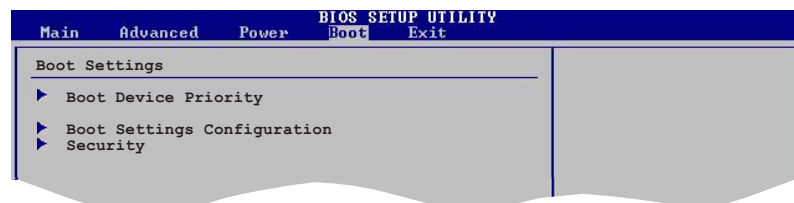

### 2.6.1 Boot Device Priority

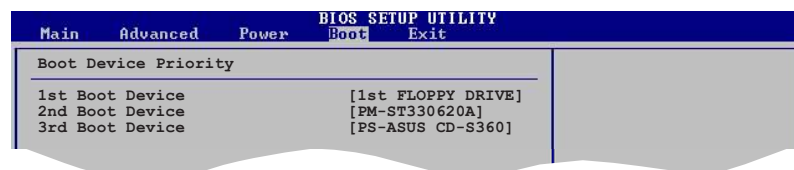

#### 1st ~ xxth Boot Device [1st Floppy Drive]

These items specify the boot device priority sequence from the available devices. The number of device items that appears on the screen depends on the number of devices installed in the system.

Configuration options: [xxxxx Drive] [Disabled]

## 2.6.2 Boot Settings Configuration

BIOS SETUP UTILITY				
Main	Advanced	Power	Boot	Exit
Boot Settings Configuration				Allows BIOS to skip certain tests while booting. This will decrease the time needed to boot the system.
Quick Boot			[Enabled]	
Full Screen Logo			[Enabled]	
AddOn ROM Display Mode			[Force BIOS]	
Bootup Num-Lock			[On]	
Wait For 'F1' If Error			[Enabled]	
Hit 'DEL' Message Display			[Enabled]	
Interrupt 19 Capture			[Disabled]	

### Quick Boot [Enabled]

Enabling this item allows the BIOS to skip some power on self tests (POST) while booting to decrease the time needed to boot the system. When set to [Disabled], BIOS performs all the POST items.

Configuration options: [Disabled] [Enabled]

### Full Screen Logo [Enabled]

This allows you to enable or disable the full screen logo display feature.

Configuration options: [Disabled] [Enabled]



Set this item to [Enabled] to use the ASUS MyLogo™ feature.

### Add On ROM Display Mode [Force BIOS]

Sets the display mode for option ROM.

Configuration options: [Force BIOS] [Keep Current]

### Bootup Num-Lock [On]

Allows you to select the power-on state for the NumLock.

Configuration options: [Off] [On]

### Wait for 'F1' If Error [Enabled]

When set to Enabled, the system waits for the F1 key to be pressed when error occurs. Configuration options: [Disabled] [Enabled]

### Hit 'DEL' Message Display [Enabled]

When set to Enabled, the system displays the message "Press DEL to run Setup" during POST. Configuration options: [Disabled] [Enabled]

### Interrupt 19 Capture [Disabled]

When set to [Enabled], this function allows the option ROMs to trap Interrupt 19. Configuration options: [Disabled] [Enabled]

### 2.6.3 Security

The Security menu items allow you to change the system security settings. Select an item then press <Enter> to display the configuration options.

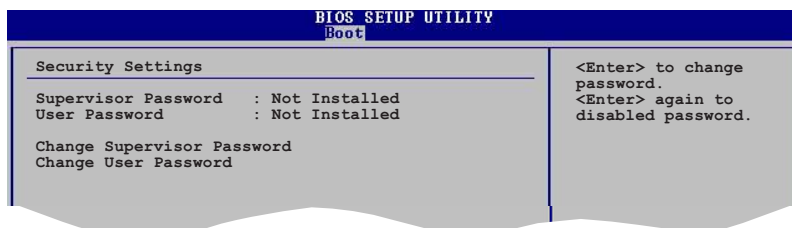

#### Change Supervisor Password

Select this item to set or change the supervisor password. The Supervisor Password item on top of the screen shows the default **Not Installed**. After you set a password, this item shows **Installed**.

To set a Supervisor Password:

1. Select the Change Supervisor Password item and press <Enter>.
2. From the password box, type a password composed of at least six letters and/or numbers, then press <Enter>.
3. Confirm the password when prompted.

The message "Password Installed" appears after you successfully set your password.

To change the supervisor password, follow the same steps as in setting a user password.

To clear the supervisor password, select the Change Supervisor Password then press <Enter>. The message "Password Uninstalled" appears.



If you forget your BIOS password, you can clear it by erasing the CMOS Real Time Clock (RTC) RAM. See section "1.9 Jumpers" for information on how to erase the RTC RAM.

After you have set a supervisor password, the other items appear to allow you to change other security settings.

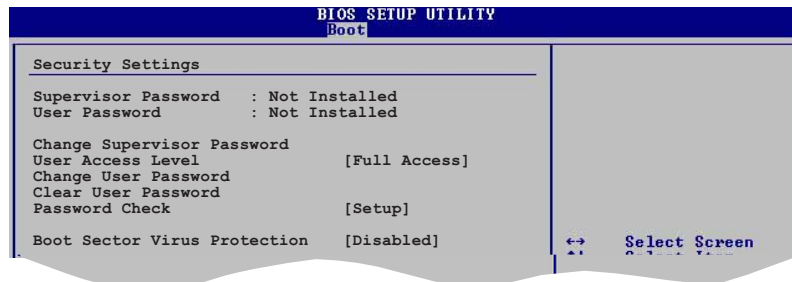

### User Access Level (Full Access]

This item allows you to select the access restriction to the Setup items. Configuration options: [No Access] [View Only] [Limited] [Full Access]

**No Access** prevents user access to the Setup utility.

**View Only** allows access but does not allow change to any field.

**Limited** allows changes only to selected fields, such as Date and Time.

**Full Access** allows viewing and changing all the fields in the Setup utility.

### Change User Password

Select this item to set or change the user password. The User Password item on top of the screen shows the default **Not Installed**. After you set a password, this item shows **Installed**.

To set a User Password:

1. Select the Change User Password item and press <Enter>.
2. On the password box that appears, type a password composed of at least six letters and/or numbers, then press <Enter>.
3. Confirm the password when prompted.

The message "Password Installed" appears after you set your password successfully.

To change the user password, follow the same steps as in setting a user password.

### Clear User Password

Select this item to clear the user password.

## Password Check [Setup]

When set to [Setup], BIOS checks for user password when accessing the Setup utility. When set to [Always], BIOS checks for user password both when accessing Setup and booting the system.

Configuration options: [Setup] [Always]

## 2.7 Exit menu

The Exit menu items allow you to load the optimal or failsafe default values for the BIOS items, and save or discard your changes to the BIOS items.

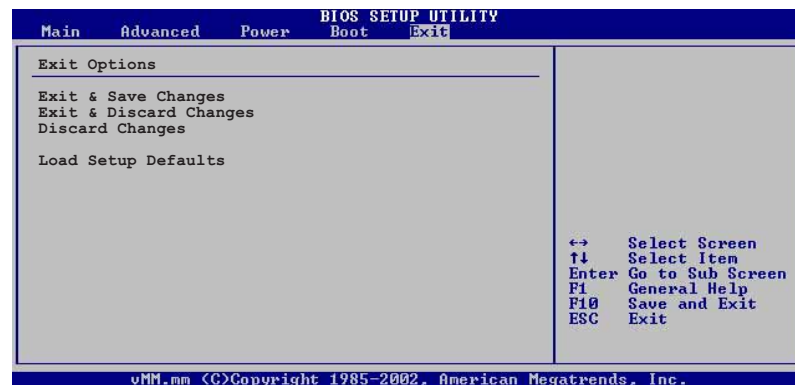

Pressing <Esc> does not immediately exit this menu. Select one of the options from this menu or <F10> from the legend bar to exit.

### Exit & Save Changes

Once you are finished making your selections, choose this option from the Exit menu to ensure the values you selected are saved to the CMOS RAM. An onboard backup battery sustains the CMOS RAM so it stays on even when the PC is turned off. When you select this option, a confirmation window appears. Select **Yes** to save changes and exit.





---

If you attempt to exit the Setup program without saving your changes, the program prompts you with a message asking if you want to save your changes before exiting. Press <Enter> to save the changes while exiting.

---

### **Exit & Discard Changes**

Select this option only if you do not want to save the changes that you made to the Setup program. If you made changes to fields other than System Date, System Time, and Password, the BIOS asks for a confirmation before exiting.

### **Discard Changes**

This option allows you to discard the selections you made and restore the previously saved values. After selecting this option, a confirmation appears. Select **Yes** to discard any changes and load the previously saved values.

### **Load Setup Defaults**

This option allows you to load the default values for each of the parameters on the Setup menus. When you select this option or if you press <F5>, a confirmation window appears. Select **Yes** to load default values. Select **Exit & Save Changes** or make other changes before saving the values to the non-volatile RAM.



This chapter describes the contents of the support CD that comes with the motherboard package.

# Software support

A large, light gray, stylized number '3' is positioned behind the words 'Software' and 'support', partially overlapping them.

## 3.1 Installing an operating system

This motherboard supports Windows® 2000/XP/2003 Server operating systems (OS). Always install the latest OS version and corresponding updates to maximize the features of your hardware.



- Motherboard settings and hardware options vary. Use the setup procedures presented in this chapter for reference only. Refer to your OS documentation for detailed information.
- Make sure that you install Windows® 2000 Service Pack 4 or the Windows® XP Service Pack 1 or later versions before installing the drivers for better compatibility and system stability.

## 3.2 Support CD information

The support CD that came with the motherboard package contains the drivers, software applications, and utilities that you can install to avail all motherboard features.



The contents of the support CD are subject to change at any time without notice. Visit the ASUS website([www.asus.com](http://www.asus.com)) for updates.

### 3.2.1 Running the support CD

Place the support CD to the optical drive. The CD automatically displays the **Drivers** menu if Autorun is enabled in your computer.

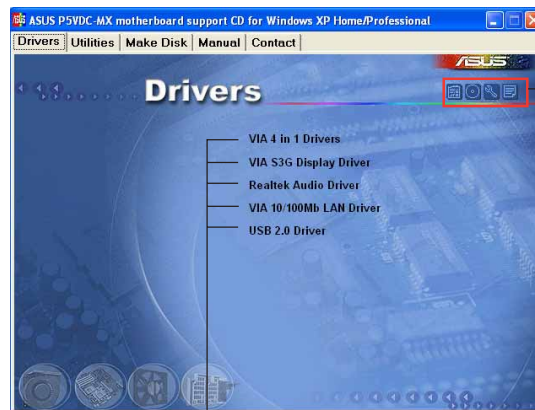

Click an icon to display support CD/motherboard information

Click an item to install



If **Autorun** is NOT enabled in your computer, browse the contents of the support CD to locate the file **ASSETUP.EXE** from the BIN folder. Double-click the **ASSETUP.EXE** to run the CD.

### 3.2.2 Drivers menu

The drivers menu shows the available device drivers if the system detects installed devices. Install the necessary drivers to activate the devices.

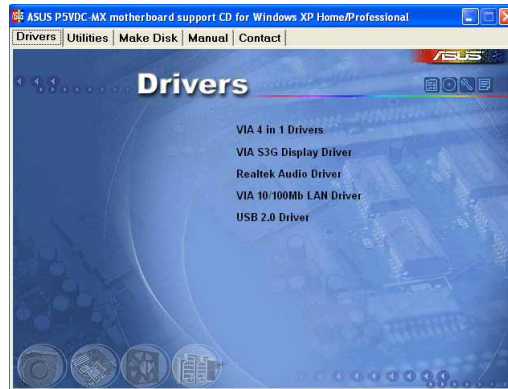

#### **VIA VT8251 Chipset Driver**

Install the VIA VT8251 Chipset Driver.

#### **VIA/S3G Display Driver**

Install the VIA/S3G UniChrome Family Display Driver.

#### **Realtek Audio Driver**

Executes the wizard to install the Realtek ALC653 Audio Driver.

#### **VIA 10/100Mb LAN Driver**

Install the VIA Ethernet Driver.

#### **USB 2.0 Driver**

Installs the USB 2.0 driver.

### 3.2.3 Utilities menu

The Utilities menu shows the applications and other software that the motherboard supports.

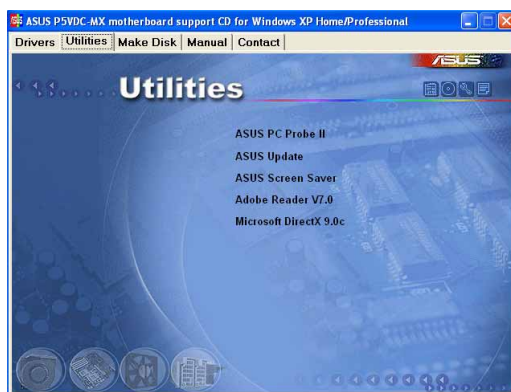

#### ASUS PC Probe II

This smart utility monitors the fan speed, CPU temperature, and system voltages, and alerts you of any detected problems. This utility helps you keep your computer in healthy operating condition.



---

This utility only support 2000/XP/XP 64bit/2003 server 64bit.

---

#### ASUS Update

The ASUS Update utility allows you to update the motherboard BIOS in a Windows® environment. This utility requires an Internet connection either through a network or an Internet Service Provider (ISP). See page 2-8 for details.

#### ASUS Screen Saver

Installs the ASUS screen saver.

#### ADOBE Reader V7.0

Installs the Adobe® Acrobat® Reader V7.0.

#### Microsoft DirectX 9.0c

Installs the Microsoft® DirectX 9.0c driver.

#### Anti-Virus Utility

Installs the anti-virus program. View the online help for detailed information.

### 3.2.4 Make Disk menu

The Make Disk menu allows you to make a RAID driver disk.



#### Make VIA SATA Driver Disk

Allows you to create a VIA VT8251 32/64bit RAID driver disk.

### 3.2.5 Manuals menu

The Manuals menu contains a list of supplementary user manuals. Click an item to open the folder of the user manual.



Most user manual files are in Portable Document Format (PDF). Install the Adobe® Acrobat® Reader from the **Utilities menu** before opening a user manual file.

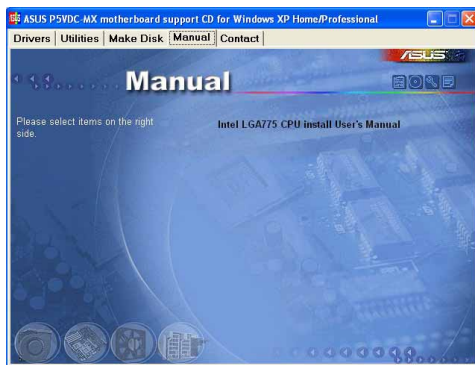

#### Intel LGA775 CPU Install User's Manual

Allows you to open the Intel® LGA775 CPU installation guide.

### 3.2.6 ASUS Contact information

Click the **Contact** tab to display the ASUS contact information. You can also find this information on the inside front cover of this user guide.

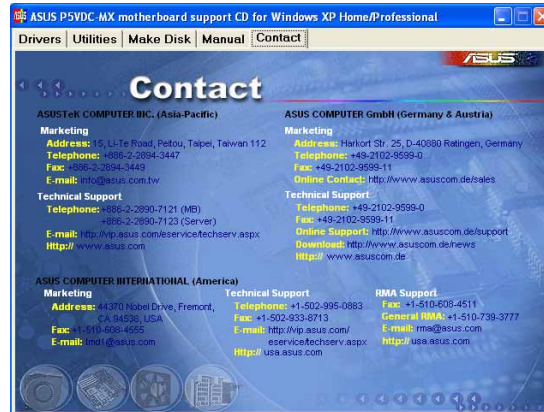



### 3.3 RAID configurations

The motherboard supports the following RAID configurations.

**RAID 0** (*Data striping*) optimizes two identical hard disk drives to read and write data in parallel, interleaved stacks. Two hard disks perform the same work as a single drive but at a sustained data transfer rate, double that of a single disk alone, thus improving data access and storage. Use of two new identical hard disk drives is required for this setup.

**RAID 1** (*Data mirroring*) copies and maintains an identical image of data from one drive to a second drive. If one drive fails, the disk array management software directs all applications to the surviving drive as it contains a complete copy of the data in the other drive. This RAID configuration provides data protection and increases fault tolerance to the entire system. Use two new drives or use an existing drive and a new drive for this setup. The new drive must be of the same size or larger than the existing drive.

**RAID 0+1** is *data striping* and *data mirroring* combined without parity (redundancy data) having to be calculated and written. With the RAID 0+1 configuration you get all the benefits of both RAID 0 and RAID 1 configurations. Use four new hard disk drives or use an existing drive and three new drives for this setup.

**JBOD** (*Spanning*) stands for **Just a Bunch of Disks** and refers to hard disk drives that are not yet configured as a RAID set. This configuration stores the same data redundantly on multiple disks that appear as a single disk on the operating system. Spanning does not deliver any advantage over using separate disks independently and does not provide fault tolerance or other RAID performance benefits.



---

If you want to boot the system from a hard disk drive included in a RAID set, copy first the RAID driver from the support CD to a floppy disk before you install an operating system to a selected hard disk drive. Refer to section “3.4 Creating a RAID driver disk” for details.

---

### 3.3.1 Installing hard disks

The motherboard supports RAID function on Serial ATA hard disk drives. For optimal performance, install identical drives of the same model and capacity when creating a disk array.

#### Installing Serial ATA (SATA) hard disks

To install the SATA hard disks for a RAID configuration:

1. Install the SATA hard disks into the drive bays.
2. Connect the SATA signal cables.
3. Connect a SATA power cable to the power connector on each drive.



---

Refer to the RAID controllers user manual in the motherboard support CD for detailed information on RAID configurations. See section “3.2.4 Manuals menu”.

---

#### Entering VIA Tech RAID BIOS Utility

1. Boot-up your computer.
2. During POST, press <Tab> to enter VIA RAID configuration utility. The following menu options will appear.



---

The RAID BIOS information on the setup screen shown below is for reference only. What you see on your screen may not exactly match what is shown here.

---

## Create Array

From the VIA RAID BIOS utility main menu, select **Create Array** then press **<Enter>**. The main menu items on the upper-left corner of the screen are replaced with create array menu options.

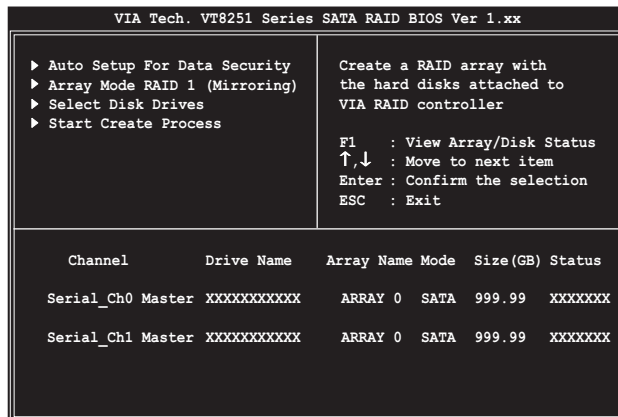

### RAID 0 for performance

1. From the create array menu, select **Array Mode**, then press **<Enter>**. The supported RAID configurations appear on a pop-up menu.

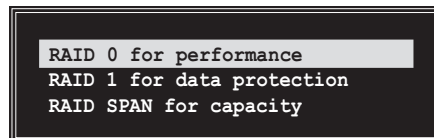

2. Select **RAID 0 for performance** then press **<Enter>**.  
From this point, you may choose to auto-configure the RAID array by selecting **Auto Setup for Performance** or manually configure the RAID array for striped sets. If you want to auto-configure, proceed to the next step, otherwise, skip to step 5.
3. Select **Auto Setup for Performance** and press **<Enter>**. The following confirmation message appears.

```
Auto create array will destroy all
data on disks, Continue? (Y/N)
```

4. Press <Y> to confirm or <N> to return to the configuration options. If you selected <Y>, proceed to step 9.
5. Select **Select Disk Drives**, then press <Enter>. Use arrow keys to select disk drive, then press <Enter> to mark selected drive. An asterisk appears before a selected drive.
6. Select **Block Size**, then press <Enter> to set array block size. A list of valid array block sizes are displayed on a pop-up menu.

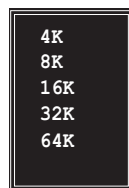

**TIP:** For server systems, use of a lower array block size is recommended. For multimedia computer systems used mainly for audio and video editing, a higher array block size is recommended for optimum performance.

Use arrow keys to move selection bar on items and press <Enter> to select.

7. Select **Start Create Process** and press <Enter> to set up hard disk for RAID system. The following confirmation message appears:

```
The data on the selected disks will
be destroyed. Continue? (Y/N)
```

8. Press <Y> to confirm or <N> to return to the configuration options.
9. Press <Esc> to go back to main menu.

### ***RAID 1 for data protection***

1. From the create array menu, select **Array Mode**, then press <Enter>. The supported RAID configurations appear on a pop-up menu.

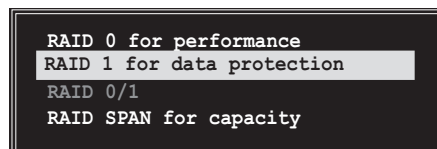

2. Select **RAID 1 for data protection** then press <Enter>.

3. From this point, you can auto-configure the RAID array by selecting **Auto Setup for Data Security** or manually configure the RAID array for mirrored sets. If you want to auto-configure, proceed to the next step, otherwise, skip to step 6.
4. Select **Auto Setup for Data Security** and press <Enter>. The following confirmation message appears.

```
Auto create array will destroy all
data on disks, Continue? (Y/N)
```

5. Press <Y> to confirm or <N> to return to the configuration options. If you selected <Y>, proceed to step 11.
6. Select **Select Disk Drives**, then press <Enter>. Use arrow keys to select disk drive/s, then press <Enter>. An asterisk appears before a selected drive.
7. Select **Start Create Process** and press <Enter> to setup hard disk for RAID system. The following inquiry appears:

```
Save the data on source disk to
mirror after creation? (Y/N)
```

8. If you select <Y> the utility will duplicate your data. Press <Y> anytime if you want to exit the duplication process.

```
Duplicating...
Press Yes (Y) to Escape
```

9. If you select <N>, the following confirmation message appears.

```
The data on the selected disks will
be destroyed. Continue? (Y/N)
```

10. Press <Y> to confirm or <N> to return to the configuration options.
11. Press <Esc> to go back to main menu.

### 3.4 Creating a RAID driver disk

A floppy disk with the RAID driver is required when installing Windows® 2000/XP or later operating system on a hard disk drive that is included in a RAID set.

To create a RAID driver disk:

1. Place the motherboard support CD into the CD-ROM drive.
2. When the **Drivers** menu appears, click **Make VIA VT8251 32/64bit RAID Driver Disk** to create a VIA RAID driver disk

Or

Browse the contents of the support CD to locate the driver disk utility and go to **\Drivers\Chipset\EIA 4 in 1\Disk** for the VIA RAID driver disk utility



---

Refer to section "3.2.2 Drivers menu" for details.

---

3. Insert floppy disk to floppy disk drive.
4. Follow succeeding screen information to complete process.
5. Write-protect the floppy disk to avoid computer virus infection.

To install the RAID driver:

1. During the OS installation, the system prompts you to press the F6 key to install third-party SCSI or RAID driver.
2. Press <F6> then insert the floppy disk with RAID driver into the floppy disk drive.
3. Follow the succeeding screen instructions to complete the installation.

## Free Manuals Download Website

<http://myh66.com>

<http://usermanuals.us>

<http://www.somanuals.com>

<http://www.4manuals.cc>

<http://www.manual-lib.com>

<http://www.404manual.com>

<http://www.luxmanual.com>

<http://aubethermostatmanual.com>

Golf course search by state

<http://golfingnear.com>

Email search by domain

<http://emailbydomain.com>

Auto manuals search

<http://auto.somanuals.com>

TV manuals search

<http://tv.somanuals.com>