

Barco iD H250/500



Owners manual

R9010520
R9010570

R59770079/01
23/07/2007

BARCO

Visibly yours

Product revision

Firmware: V1.20

Barco nv Presentations
Noordlaan 5, 8520 Kuurne
Phone: +32 56.36.82.11
Fax: +32 56.35.86.51
E-mail: presentations.bid@barco.com
Visit us at the web: www.barco.com

Printed in Belgium

Changes

Barco provides this manual 'as is' without warranty of any kind, either expressed or implied, including but not limited to the implied warranties or merchantability and fitness for a particular purpose. Barco may make improvements and/or changes to the product(s) and/or the program(s) described in this publication at any time without notice.

This publication could contain technical inaccuracies or typographical errors. Changes are periodically made to the information in this publication; these changes are incorporated in new editions of this publication.

Copyright ©

All rights reserved. No part of this document may be copied, reproduced or translated. It shall not otherwise be recorded, transmitted or stored in a retrieval system without the prior written consent of Barco.

eCos

The software in this product uses eCos, the Embedded Configurable Operating System.

This is the license for eCos:

Copyright (C) 1998, 1999, 2000, 2001, 2002, 2003 Red Hat, Inc.

Copyright (C) 2002, 2003 John Dallaway

Copyright (C) 2002, 2003 Nick Garnett

Copyright (C) 2002, 2003 Jonathan Larmour

Copyright (C) 2002, 2003 Andrew Lunn

Copyright (C) 2002, 2003 Gary Thomas

Copyright (C) 2002, 2003 Bart Veer

eCos is free software; you can redistribute it and/or modify it under the terms of the GNU General Public License as published by the Free Software Foundation; either version 2 or (at your option) any later version.

eCos is distributed in the hope that it will be useful, but WITHOUT ANY WARRANTY; without even the implied warranty of MERCHANTABILITY or FITNESS FOR A PARTICULAR PURPOSE. See the GNU General Public License for more details.

You should have received a copy of the GNU General Public License along with eCos; if not, write to the Free Software Foundation, Inc., 59 Temple Place, Suite 330, Boston, MA 02111-1307 USA.

As a special exception, if other files instantiate templates or use macros or inline functions from this file, or you compile this file and link it with other works to produce a work based on this file, this file does not by itself cause the resulting work to be covered by the GNU General Public License. However the source code for this file must still be made available in accordance with section (3) of the GNU General Public License.

This exception does not invalidate any other reasons why a work based on this file might be covered by the GNU General Public License.

The eCos source used to build the software used in the Barco iCon is available on request from Barco.

EN55022/CISPR22 Class A ITE (Information Technology Equipment)

Class A ITE is a category of all other ITE which satisfies the class A ITE limits but not the class B ITE limits. Such equipment should not be restricted in its sale but the following warning shall be included in the instructions for use:

Warning : This is a class A product. In a domestic environment this product may cause radio interference in which case the user may be required to take adequate measures.

Guarantee and Compensation

Barco provides a guarantee relating to perfect manufacturing as part of the legally stipulated terms of guarantee. On receipt, the purchaser must immediately inspect all delivered goods for damage incurred during transport, as well as for material and manufacturing faults Barco must be informed immediately in writing of any complaints.

The period of guarantee begins on the date of transfer of risks, in the case of special systems and software on the date of commissioning, at latest 30 days after the transfer of risks. In the event of justified notice of complaint, Barco can repair the fault or provide a replacement at its own discretion within an appropriate period. If this measure proves to be impossible or unsuccessful, the purchaser can demand a reduction in the purchase price or cancellation of the contract. All other claims, in particular those relating to compensation for direct or indirect damage, and also damage attributed to the operation of software as well as to other services provided by Barco, being a component of the system or independent service, will be deemed invalid provided the damage is not proven to be attributed to the absence of properties guaranteed in writing or due to the intent or gross negligence or part of Barco.

If the purchaser or a third party carries out modifications or repairs on goods delivered by Barco, or if the goods are handled incorrectly, in particular if the systems are commissioned operated incorrectly or if, after the transfer of risks, the goods are subject to influences not agreed upon in the contract, all guarantee claims of the purchaser will be rendered invalid. Not included in the guarantee coverage are system failures which are attributed to programs or special electronic circuitry provided by the purchaser, e.g. interfaces. Normal wear as well as normal maintenance are not subject to the guarantee provided by Barco either.

The environmental conditions as well as the servicing and maintenance regulations specified in the this manual must be complied with by the customer.

Trademarks

Brand and product names mentioned in this manual may be trademarks, registered trademarks or copyrights of their respective holders. All brand and product names mentioned in this manual serve as comments or examples and are not to be understood as advertising for the products or their manufactures.

TABLE OF CONTENTS

1. Packaging	3
1.1 Unpacking	3
2. Installation guidelines	5
2.1 Safety warnings.....	5
2.2 Installation guidelines	5
3. Installation	7
3.1 Battery installation in the RCU	8
3.2 Lens installation	8
3.3 Removing the lens.....	9
3.4 Lens range.....	9
3.5 Lens Formulas.....	10
3.6 Projector configuration	10
3.7 Positioning the projector.....	11
4. Connections	15
4.1 Power connection	15
4.2 Signal connections	15
4.2.1 The input section.....	15
4.2.2 Connecting a Composite video signal.....	17
4.2.3 Connecting an S-Video signal.....	17
4.2.4 Connecting an RGB signal	17
4.2.5 Connecting a Component Video signal	18
4.2.6 Connecting a DVI signal	19
4.2.7 Connecting a computer signal	20
4.2.8 The DVI output.....	20
4.3 Communication connections	21
4.3.1 RS232/RS422 Connections	22
4.3.2 Ethernet Connections.....	22
5. Setup	25
5.1 RCU & Local keypad	25
5.2 Terminology overview	27
5.3 Switching on	28
5.4 Setting up the RCU address	29
5.5 Setting up the projector address (only if necessary)	30
5.6 Setting up the orientation	31
5.7 Adjusting the lens.....	31
5.8 Setup the baudrate for serial communication.....	33
5.9 Network settings.....	34
5.10 Preferences.....	35
5.10.1 Language setting.....	35
5.10.2 Automatic startup	36
6. Getting started	39
6.1 Start up	39
6.2 Selecting a source	39
6.3 Adjusting the image	39
7. Advanced	41
7.1 The OSD Menu	41
7.2 Using the Dialog boxes.....	42
7.3 Source selection	43
7.3.1 Source selection	43
7.3.2 Composite video	43
7.3.3 S-Video.....	44
7.3.4 RGB-YUV	44
7.3.5 PC	45
7.3.6 DVI	45
7.4 General	46
7.4.1 Pause.....	46
7.4.2 Freeze.....	47
7.4.3 Identification.....	47
7.5 Image	48
7.5.1 Image settings	49
7.5.1.1 Setting the Contrast	49
7.5.1.2 Setting the Brightness.....	49
7.5.1.3 Color	50
7.5.1.4 Tint (NTSC video signals only).....	50
7.5.1.5 Sharpness	50
7.5.1.6 Gamma	51
7.5.1.7 Phase (RGB signals only).....	51

Table of contents

7.5.1.8	Noise Reduction (only for video signals)	52
7.5.2	Aspect ratio	53
7.5.3	Color temperature	56
7.5.4	Film mode detection (video only)	57
7.5.5	Input balance	58
7.5.6	Automatic gain control (AGC)	61
7.5.7	Manual gain control	62
7.6	Lamp management	62
7.6.1	Runtimes	62
7.6.2	Lamp mode	63
7.6.3	History	65
7.6.4	Reset lamp Runtime	65
7.6.5	Clear lamp error	66
7.6.6	Lamp runtime warning	67
7.7	Image files	68
7.7.1	Introduction to Image files	68
7.7.2	Load file	69
7.7.3	Forced file load	70
7.7.4	Auto Image	71
7.7.5	Edit file	72
7.7.6	Save as (create a custom file)	74
7.7.7	Rename file	74
7.7.8	Copy	75
7.7.9	Delete	76
7.8	Display setup	77
7.8.1	Dynacolor™	77
7.8.2	Brilliant Color™ mode	86
7.8.3	Full screen synchronous representation	87
7.8.4	Text box	87
7.8.5	Menu bar position	88
7.8.6	Status bar position	88
7.8.7	Sliderbox position	89
7.8.8	Softedge	90
7.8.8.1	Softedge Border	90
7.8.8.2	Black level	91
8.	Maintenance	93
8.1	Cleaning the lens	93
9.	Image files	95
9.1	Image files	95
10.	Troubleshooting	99
10.1	Using the OSD	99
Index		101

1. PACKAGING

1.1 Unpacking



CEE7

European power plug to connect the power cord to the wall outlet.



ANSI 73.11

American power plug to connect the power cord to the wall outlet.

Content

- 1 projector (weight \pm 14 kg or 31 lbs)
- 1 remote control unit RCU + 2 batteries.
- 2 power cables with outlet plug type CEE7 and ANSI 73.11.
- 1 owners manual
- 1 safety manual
- 1 CDROM (containing manuals)

Form

The projector is packed in a carton box. To provide protection during transportation, the projector is surrounded with foam. The package is secured with banding and fastening clips.

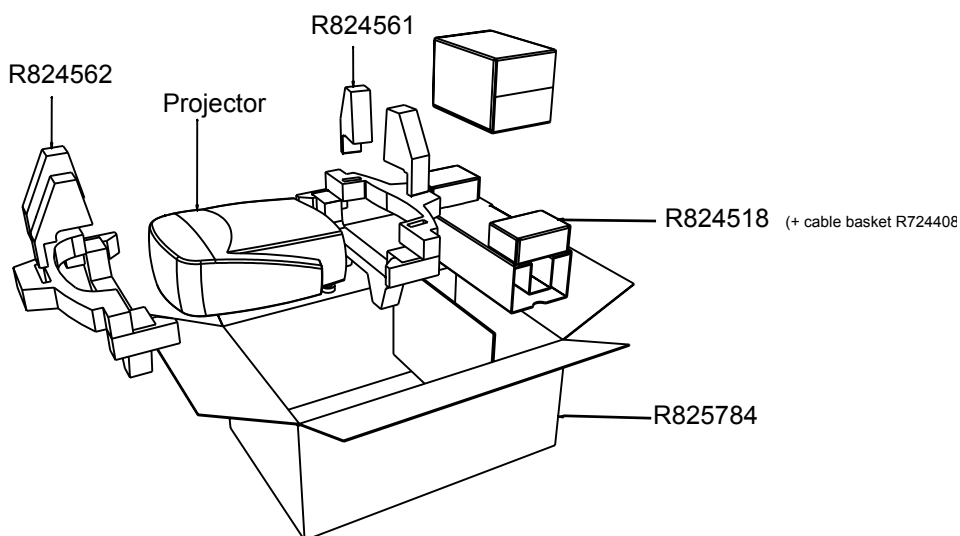

Image 1-1

Lens packaging

The Lens is supplied as an individual item.

The lens is packed in a carton box.



Save the original shipping cardboard and packing material, they will be necessary if you ever have to transport the lens.



**CAUTION: Never transport the projector with the lens mounted on it !
Always remove the lens before transporting the projector.**

How to unpack the projector

1. Release the cord straps.

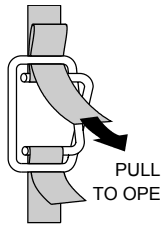

Image 1-2

2. Remove the assembly from the pallet
3. Remove the cardboard cover
4. Remove the large cardboard
5. Remove the 8 foam parts
6. Loosen and remove the 3 screws spacers fixing the projector to the wooden board
7. Remove the projector from the board



Save the original shipping carton and packing material, they will be necessary if you ever have to ship your projector. For maximum protection, repack your projector as it was originally packed at the factory.

2. INSTALLATION GUIDELINES

Overview

- Safety warnings
- Installation guidelines

2.1 Safety warnings



WARNING: Before installing the projector, read first the safety instructions in the safety manual (R5975258) delivered with the projector.

Insure that the projector is installed in an easy to evacuate room in case of a lamp explosion.

Mercury Vapor Warnings

Keep the following warnings in mind when using the projector. The lamp used in the projector contains mercury. In case of a lamp rupture, explosion there will be a mercury vapor emission. In order to minimize the potential risk of inhaling mercury vapors:

- Ensure the projector is installed only in ventilated rooms.
- Replace the lamp module before the end of its operational life.
- Promptly ventilate the room after a lamp rupture, explosion has occurred, evacuate the room (particularly in case of a pregnant woman).
- Seek medical attention if unusual health conditions occur after a lamp rupture, explosion, such as headache, fatigue, shortness of breath, chest-tightening coughing or nausea.

2.2 Installation guidelines

Ambient temperature check

Careful consideration of things such as image size, ambient light level, projector placement and type of screen to use are critical to the optimum use of the projection system.

Max. ambient temperature : 40 °C or 104 °F

Min. ambient temperature : 0 °C or 32 °F

The projector will not operate if ambient air temperature falls outside this range (0°C- 40°C or 32°F-104°F).

Environment

Do not install the projection system in a site near heat sources such as radiators or air ducts, or in a place subject to direct sunlight, excessive dust or humidity. Be aware that room heat rises to the ceiling; check that temperature near the installation site is not excessive



CAUTION: Harmful Environmental Contamination Precaution

Environment condition check

A projector must always be mounted in a manner which ensures the free flow of clean air into the projectors ventilation inlets as well as free flow at the ventilation outlets. The installation must also allow easy access to the consumable parts (dustfilters, lamps, ...) For installations in environments where the projector is subject to airborne contaminants such as that produced by smoke machines or similar (these deposit a thin layer of greasy residue upon the projectors internal optics and imaging electronic surfaces, degrading performance), then it is highly advisable and desirable to have this contamination removed prior to it reaching the projectors clean air supply. Devices or structures to extract or shield contaminated air well away from the projector are a prerequisite, if this is not a feasible solution then measures to relocate the projector to a clean air environment should be considered. Make sure that the projector never runs with dirty dustfilters as this will dramatically reduce the lifetime of the consumables. It is advised to clean the dustfilters on a regular basis and to replace them at any lamp change. Barco reserves itself the right to refuse warranty replacement of consumables if they have been used in a projector with dirty airfilters. Only use the manufactures recommended cleaning kit which has been specifically designed for cleaning optical parts, never use industrial strength cleaners on a projectors optics as these will degrade optical coatings and damage sensitive optoelectronics .

Failure to take suitable precautions to protect the projector from the effects of persistent and prolonged air contaminants will culminate in extensive and irreversible ingrained optical damage. At this stage cleaning of the internal optical units will be non-effective and impracticable. Damage of this nature is under no circumstances covered under the manufactures warranty and may deem the

warranty null and void. In such a case the client shall be held solely responsible for all costs incurred during any repair. It is the clients responsibility to ensure at all times that the projector is protected from the harmful effects of hostile airborne particles in the environment of the projector. The manufacture reserves the right to refuse warranty repair if a projector has been subject to wantful neglect, abandon or improper use.

What about ambient light ?

The ambient light level of any room is made up of direct or indirect sunlight and the light fixtures in the room. The amount of ambient light will determine how bright the image will appear. So, avoid direct light on the screen. Windows that face the screen should be covered by opaque drapery while the set is being viewed. It is desirable to install the projection system in a room whose walls and floor are of non-reflecting material. The use of recessed ceiling lights and a method of dimming those lights to an acceptable level is also important. Too much ambient light will 'wash out' of the projected image. This appears as less contrast between the darkest and lightest parts of the image. With bigger screens, the 'wash out' becomes more important. As a general rule, darken the room to the point where there is just sufficient light to read or write comfortably. Spot lighting is desirable for illuminating small areas so that interference with the screen is minimal.

Which screen type ?

There are two major categories of screens used for projection equipment. Those used for front projected images and those for rear projection applications. Screens are rated by how much light they reflect (or transmit in the case of rear projection systems) given a determined amount of light projected toward them. The 'GAIN' of a screen is the term used. Front and rear screens are both rated in terms of gain. The gain of screens range from a white matte screen with a gain of 1 (x1) to a brushed aluminized screen with a gain of 10 (x10) or more. The choice between higher and lower gain screens is largely a matter of personal preference and another consideration called the Viewing angle. In considering the type of screen to choose, determine where the viewers will be located and go for the highest gain screen possible. A high gain screen will provide a brighter picture but reduce the viewing angle. For more information about screens, contact your local screen supplier.

Image size

The projector is designed for projecting an image size with a screenwidth from 1.00m (3.3ft) to 6.00m (19.7ft) with an aspect ratio of 16 to 9.

3. INSTALLATION

Overview

- Battery installation in the RCU
- Lens installation
- Removing the lens
- Lens range
- Lens Formulas
- Projector configuration
- Positioning the projector

Dimensions

Dimensions are given in mm and inch (1inch = 25.4 mm)

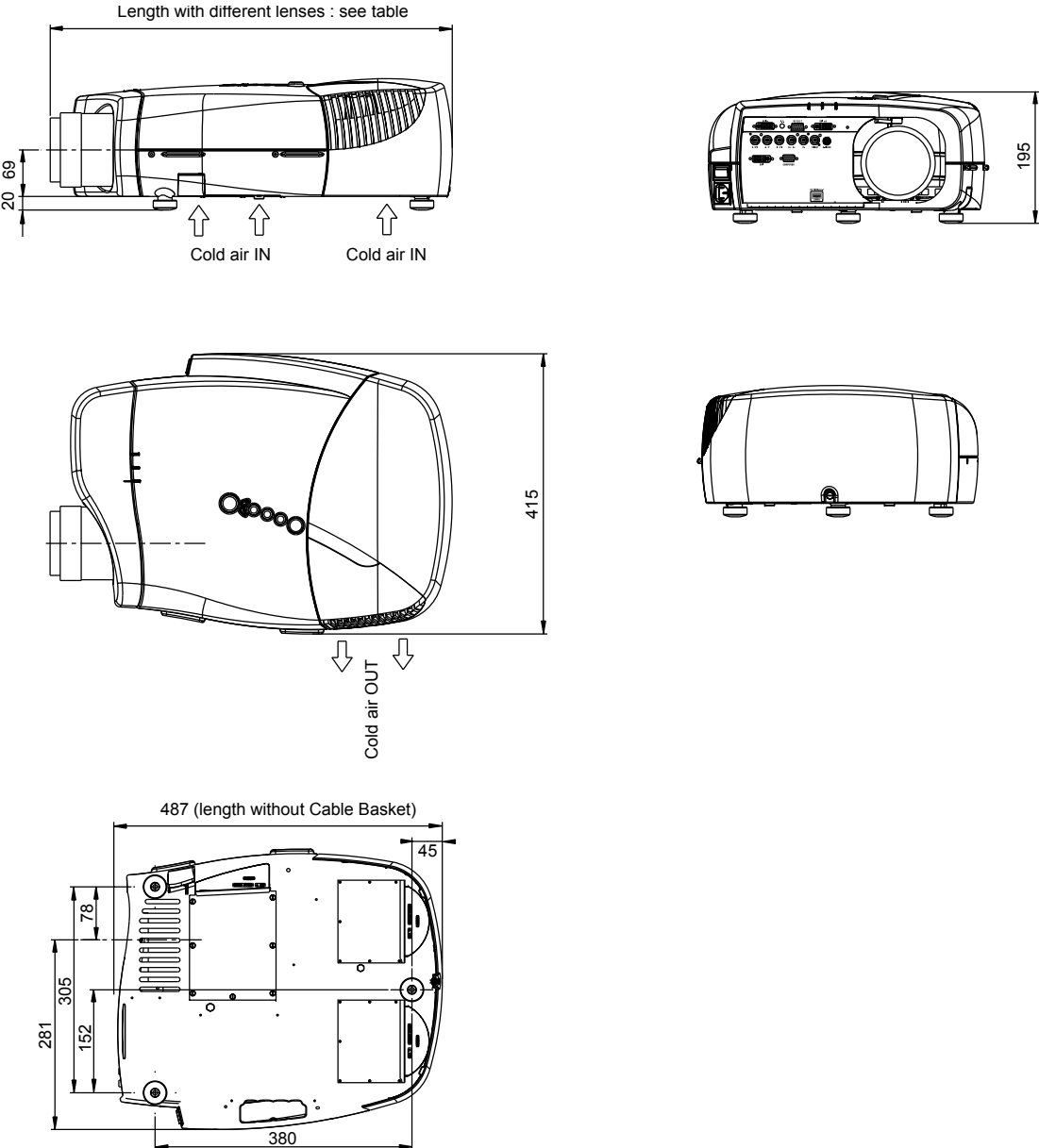

3. Installation

3.1 Battery installation in the RCU

How to install the battery

Two batteries are packed together with the RCU. Before using your RCU, install first these batteries.

1. Remove the battery cover on the backside by pushing the handle a little towards the bottom of the RCU.
2. Lift up the top side of the cover at the same time.
3. Insert the batteries as indicated in the RCU.
4. Put the battery cover on its place.

How to replace the batteries in the RCU

To replace the batteries :

1. Remove the battery cover on the backside by pushing the handle a little towards the bottom of the RCU.
2. Lift up the top side of the cover at the same time.
3. Push on the + side of the battery towards the - side
4. Lift up the battery at the same time.
5. Repeat for the second battery.
6. Insert the batteries as indicated in the RCU (battery type AA or LR6 or equivalent).
7. Put the battery cover on its place.

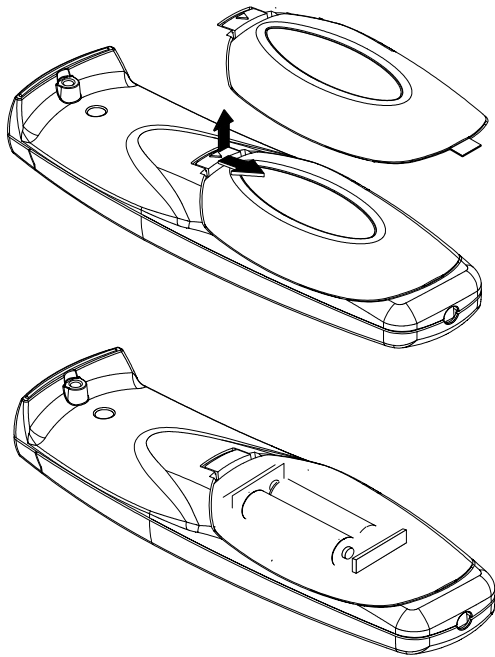

Image 3-2

3.2 Lens installation

How to install ?

1. Take the lens out of its packing material
2. Fix the lens by placing it in the housing



Image 3-3

Note: In case of a motorized lens the female jack must be in front of the male jack located in the upper-left part of the housing in the projector

- 3. Push carefully to lock the lens in the housing

3.3 Removing the lens

How to remove the lens ?

- 1. Unlock the lens by pulling the handle located on the right side of the projector



Image 3-4



Image 3-5
location of the lens handle

- 2. Remove the lens out of its housing



CAUTION: Never transport the projector with the lens mounted on it !
Always remove the lens before transporting the projector.

3.4 Lens range

Overview table

Lens	Partnumber
QCLD (0.85:1)	R9849860
QCLD (1.1-1.3:1)	R9849850
CLD (1.2-1.6:1)	R9849870

3. Installation

Lens	Partnumber
CLD (1.6-2.4:1)	R9849880
CLD (2.4-4.3:1)	R9849890



See the Maintenance appendix for more information about lens cleaning.



When using a HD projector (for example an iCon) in retro projection, it is advised to use a QCLD lens.

3.5 Lens Formulas

Formulas

Lenses	Metric Formulas (meter)	Inch formulas (inch)
QCLD (0.85:1)	$PD = 0.79 \times SW + 0.06$	$PD = 0.79 \times SW + 2.36$
QCLD (1.1-1.3:1)	$PD_{min} = 1.02 \times SW + 0.05$ $PD_{max} = 1.2 \times SW + 0.06$	$PD_{min} = 1.02 \times SW + 1.97$ $PD_{max} = 1.2 \times SW + 2.36$
CLD (1.2-1.6:1)	$PD_{min} = 1.1 \times SW + 0.02$ $PD_{max} = 1.51 \times SW + 0.02$	$PD_{min} = 1.1 \times SW + 0.79$ $PD_{max} = 1.51 \times SW + 0.79$
CLD (1.6-2.4:1)	$PD_{min} = 1.46 \times SW + 0.00$ $PD_{max} = 2.21 \times SW - 0.02$	$PD_{min} = 1.46 \times SW + 0.00$ $PD_{max} = 2.21 \times SW - 0.79$
CLD (2.4-4.3:1)	$PD_{min} = 2.2 \times SW - 0.03$ $PD_{max} = 3.99 \times SW - 0.01$	$PD_{min} = 2.2 \times SW - 1.18$ $PD_{max} = 3.99 \times SW - 0.39$

3.6 Projector configuration

The different configurations

Depending on the installation the projector can be mounted in different ways, the 4 different configurations are:

1. Rear/Ceiling
2. Rear/Table
3. Front/Ceiling
4. Front/Table

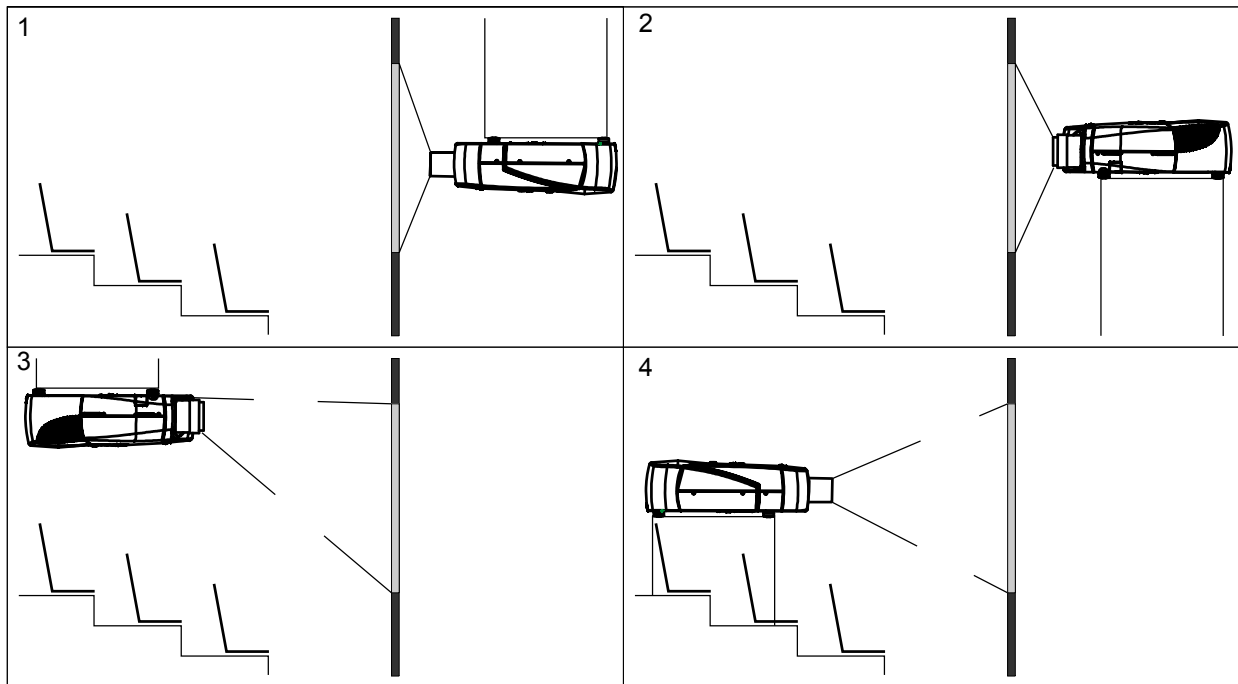

Image 3-6



The configuration should also be communicated to the projector. This is done in the *Installation* menu through the *Projector Configuration* parameter. (See Setup section)

3.7 Positioning the projector



On-Axis projection

Projection where the projector is positioned so as to have the centre of the lens coinciding with the centre of the screen.

Positioning the projector

The position of the projector with reference to the screen may also be different depending on the installation. Basically the projector can be positioned in an On-Axis or Off-Axis configuration. Several parameters can be calculated determining the position in any installation.

3. Installation

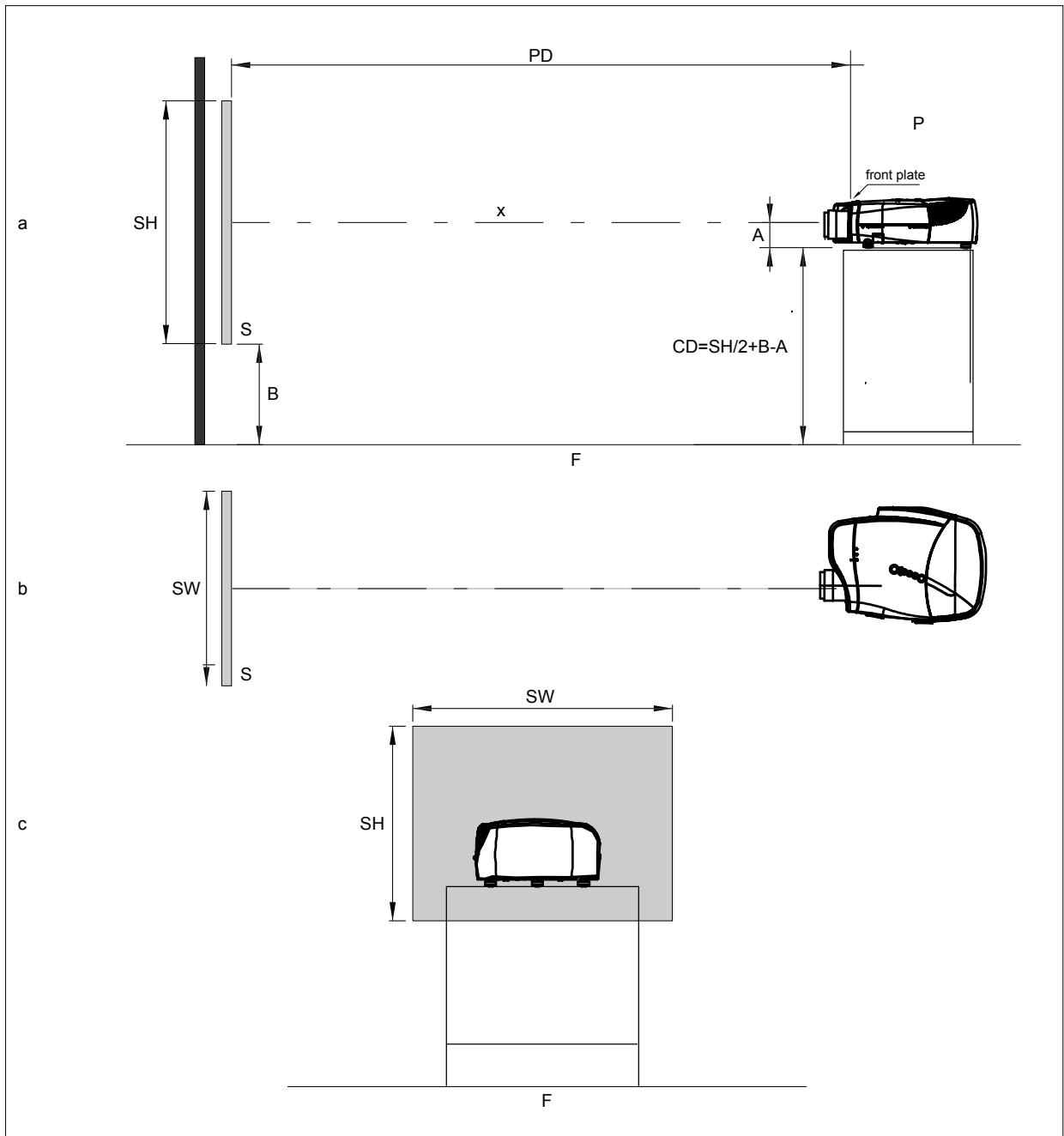

Image 3-7

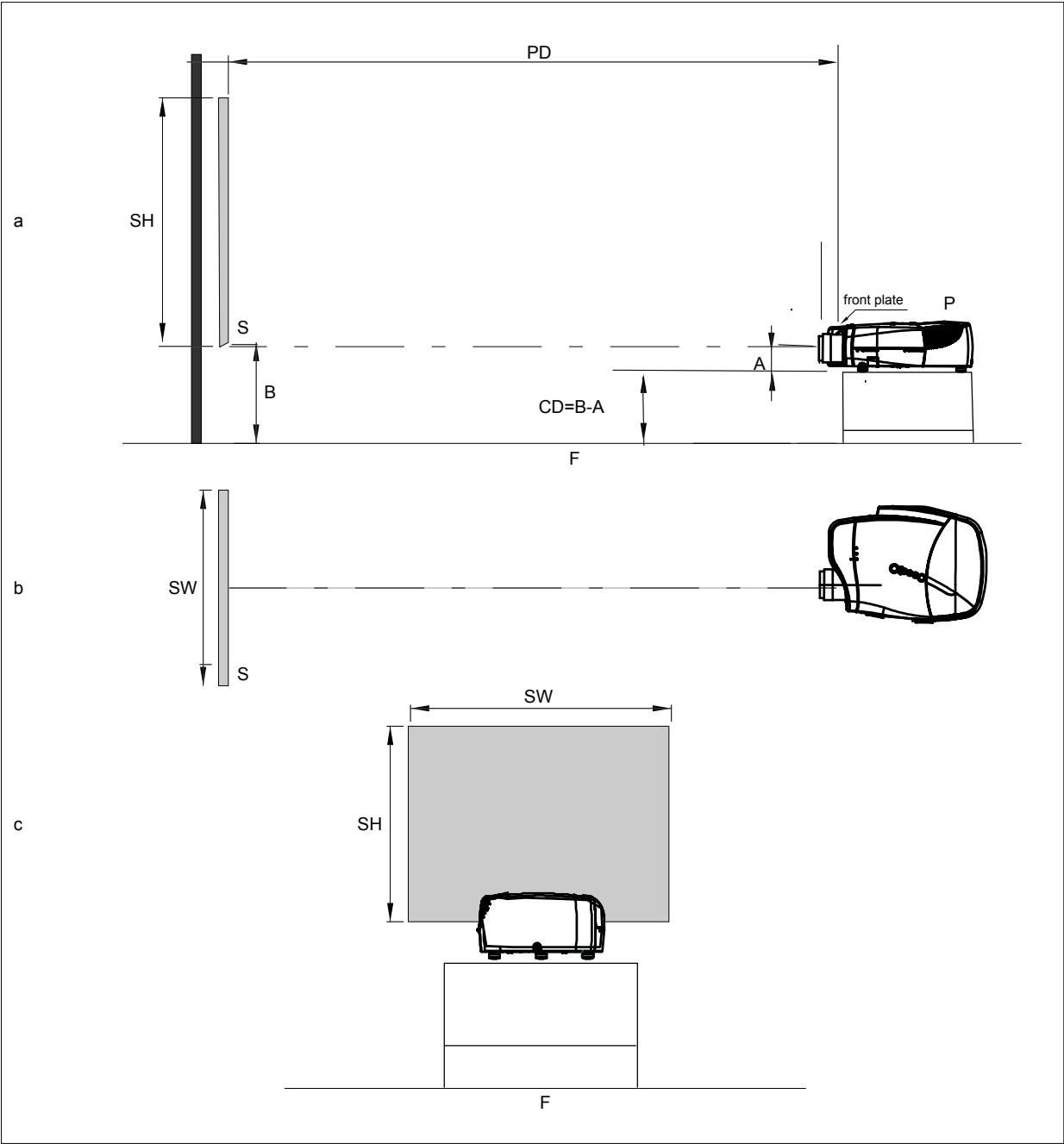

Image 3-8



A 100% Off-Axis position means that the position of the centre of the lens is shifted by half the screen height.



Never use a short throw lens in an Off-Axis installation. Shifting the lens will not guarantee optimal image quality.



CAUTION: Only for projectors containing a Server (Single Board Computer) : The harddisk in the server is formatted in horizontal position but can operate in all axes (6 directions). The projector should not be tilted more then +/- 5 degrees from these positions, otherwise error rates will increase.



CAUTION: Never place the projector on either side !

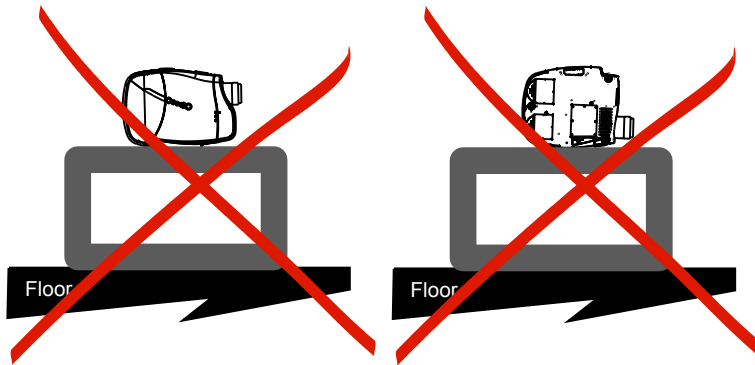

Image 3-9

4. CONNECTIONS

Overview

- Power connection
- Signal connections
- Communication connections

4.1 Power connection

Power connection

1. Use the supplied power cord to connect the projector to the power outlet.
2. Plug the female power connector into the male connector at the front of the projector.

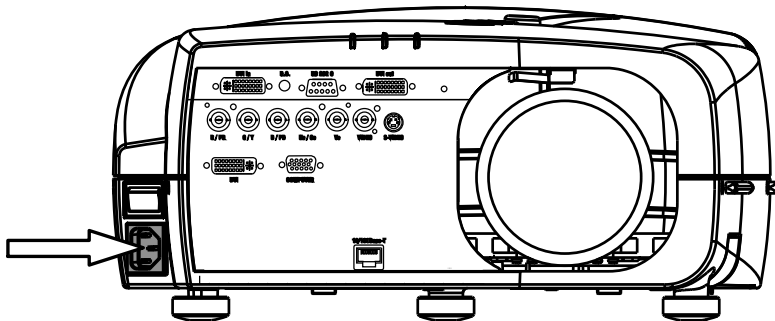

Image 4-1
Power connections

4.2 Signal connections

Overview

- The input section
- Connecting a Composite video signal
- Connecting an S-Video signal
- Connecting an RGB signal
- Connecting a Component Video signal
- Connecting a DVI signal
- Connecting a computer signal
- The DVI output

4.2.1 The input section

Input layers

The input section is located at the front of the projector and is composed of 3 layers which can be equipped with different input modules depending on the ordered options .

The standard layers :

- Layer 1: DVI Input/Output module:
- Layer 2: RGBHV & Video analog input module
- Layer 3: DVI & Computer (D15) input module
- Layer 4 : Ethernet card

The different available options :

4. Connections

- HD SDI/SDI input output module on Layer 3



When using the HD SDI option, there is always a possibility to connect a VGA signal on the RGBHV input using an adapter.

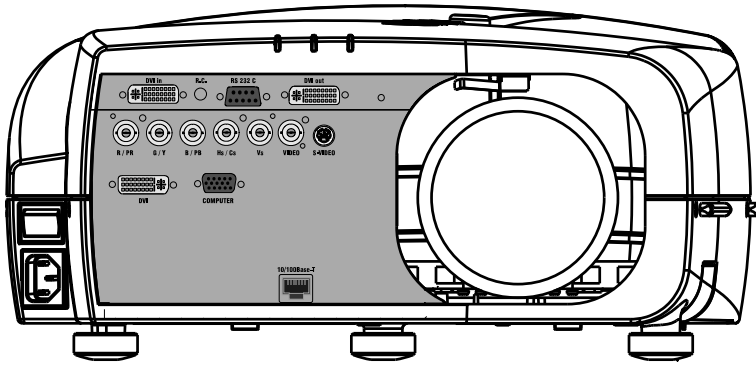

Image 4-2

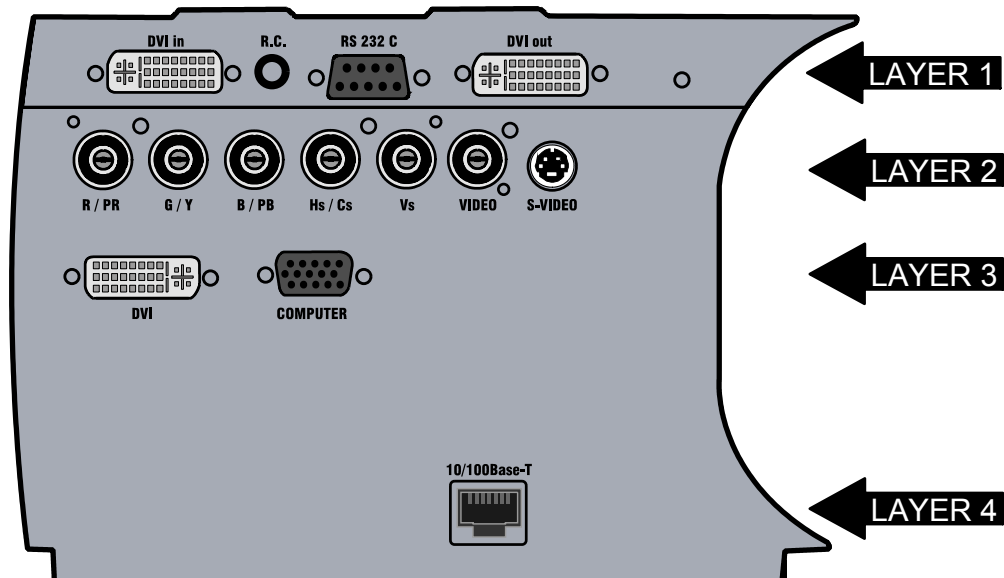

Image 4-3
Input section

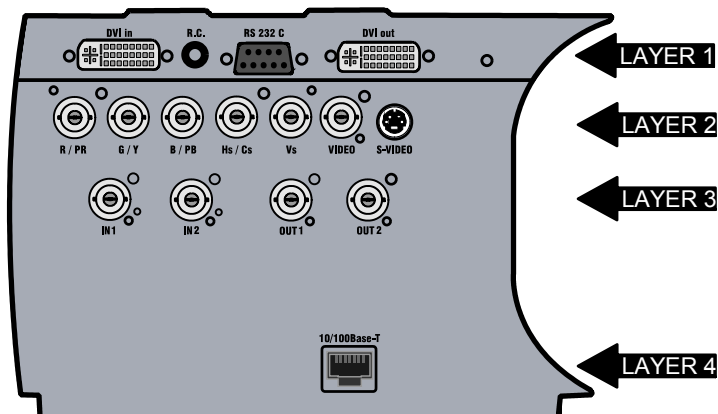

Image 4-4
Input with HDSDI/SDI module (ordered with HDSDI/SDI option)

4.2.2 Connecting a Composite video signal

Composite video connection

A Composite video signal is often available on a yellow cinch connector of a Camera, VCR or DVD player, in this case you will need an adapter cable cinch/BNC to connect to Video input of the RGB board.

How to connect a composite video signal ?

1. Connect the BNC connector to the projector's BNC video input

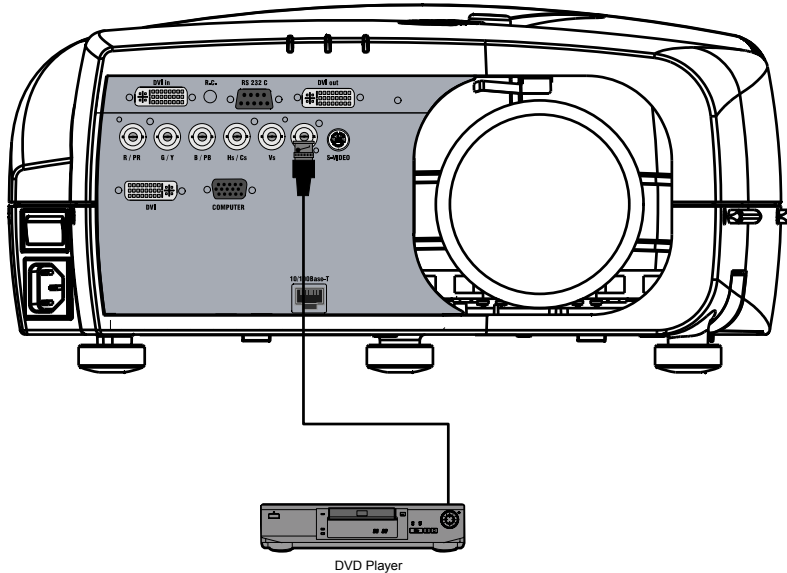

Image 4-5

4.2.3 Connecting an S-Video signal

S-Video connection

An S-Video signal is available on the Mini-Din connector of a camera, VCR or DVD player.

How to connect an S-Video connection ?

1. Connect the mini din connector to the projector's S-Video input

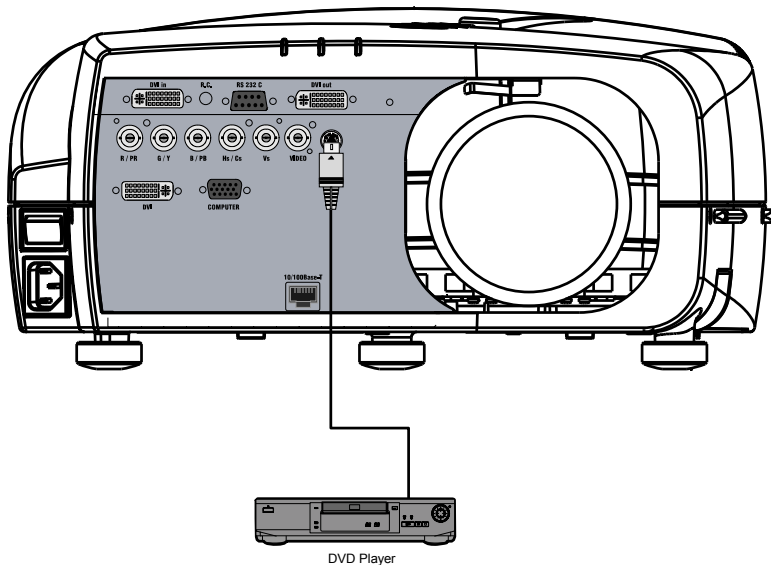

Image 4-6

4.2.4 Connecting an RGB signal

RGB data connection

The RGB input consists of 5 BNC

4. Connections

- 3 for the color signals R,G,B
- 2 for the sync signals H (horizontal sync), V (vertical sync)

RG_BV : If the source disposes of a composite sync output i.e. one wire includes the horizontal **and** the vertical sync than the V BNC must not be connected, resulting in 4 BNC being connected (V is free).

RG_sB : If the source disposes of a sync on Green output i.e. the Green color signal includes the horizontal **and** the vertical sync than the H and V BNC's must not be connected, resulting in 3 BNC being connected (H and V are free).

	BNC Connector				
	R	G	B	H	V
RGBHV	R	G	B	H	V
RG _s B	R	G _s	B	-	-
RGBS	R	G	B	S	-

Table 4-1
How to use the BNC's in case of different RGB signals



The RGB 5 BNC input can also be used to connect a component video source : see *Connecting a Component video source*.

How to connect an RGB signal ?

1. Connect the 5 or 4 BNC cables to the projector's RGB input

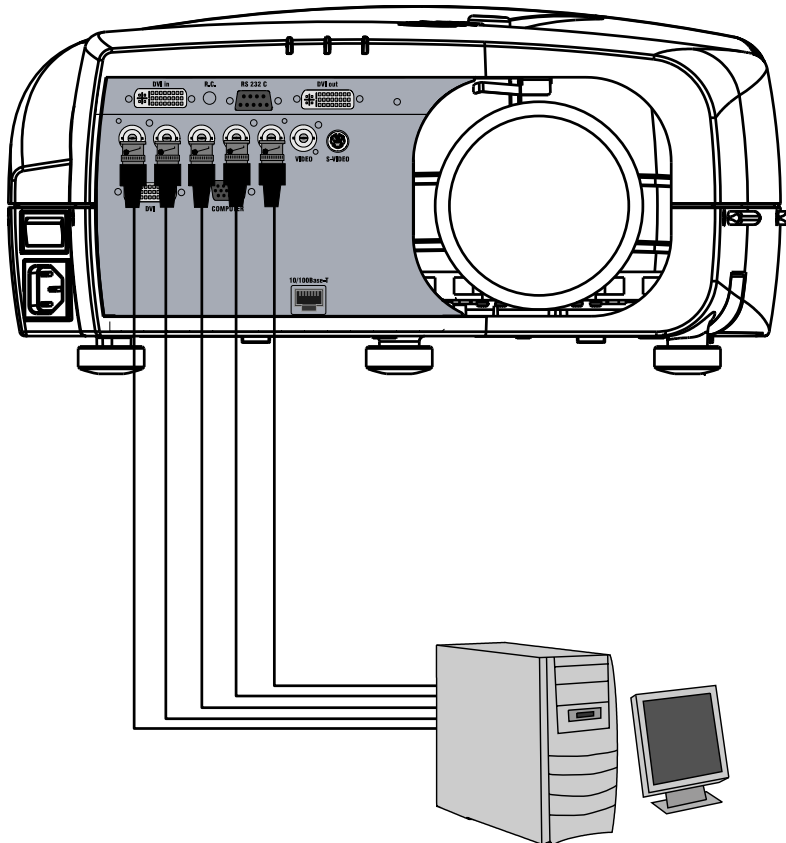

Image 4-7

4.2.5 Connecting a Component Video signal



Component Video

In Component Video the term component describes a number (3) of elements that are needed to make up the video picture, these components are R-Y/Y-B-Y. A composite video signal on the other hand contains all the information needed for the color picture in a single channel of information

How to connect a Component video signal ?

1. Connect the 3 BNC connectors to the projector's RGB input

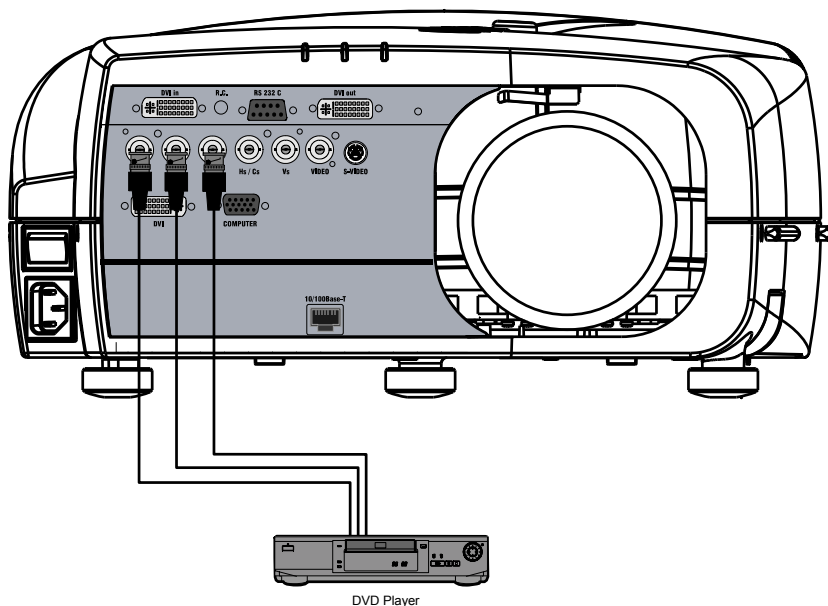

Image 4-8



In case of a “progressive scan” component video source, the notation used is PR/Y/PB

4.2.6 Connecting a DVI signal



DVI

Digital Visual Interface is a display interface developed in response to the proliferation of digital flat panel displays.

The digital video connectivity standard that was developed by DDWG (Digital Display Work Group). This connection standard offers two different connectors: one with 24 pins that handles digital video signals only, and one with 29 pins that handles both digital and analog video. This standard uses TMDS (Transition Minimized Differential Signal) from Silicon Image and DDC (Display Data Channel) from VESA (Video Electronics Standards Association).

DVI can be single or dual link.

Input specifications

Single link DVI

Differential input voltage: 200 mV - 800mV

How to connect a DVI signal ?

1. Connect the DVI cable to the DVI input on Layer 0 or on Layer 2

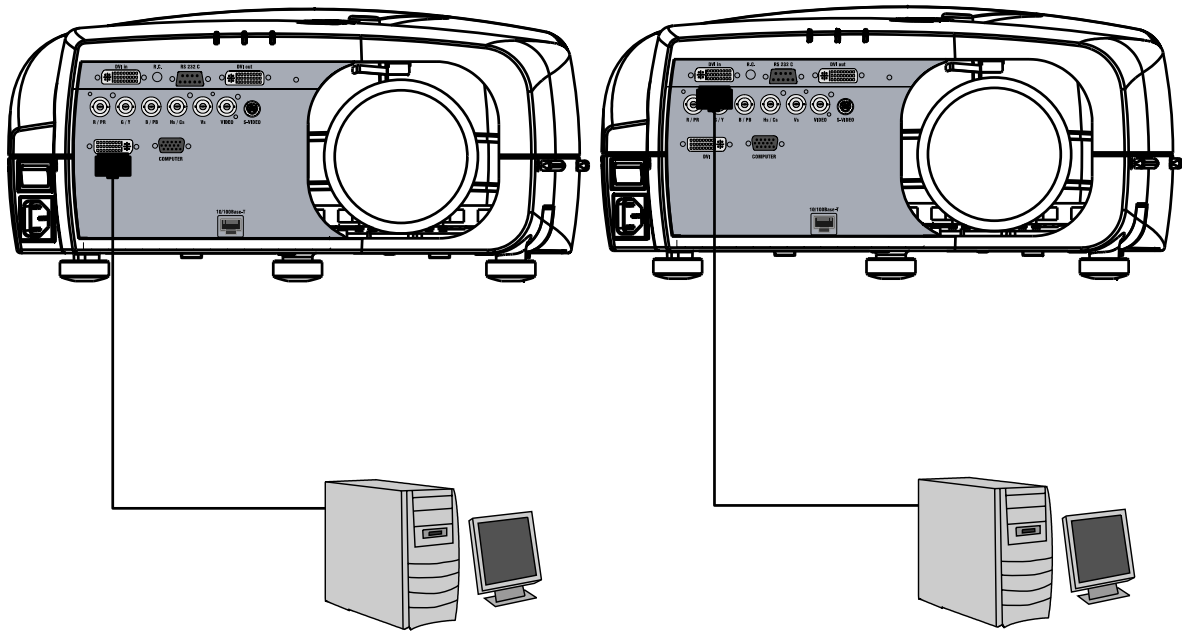

Image 4-9



Note that the 2 DVI outputs are identical and are processed in the same way in the projector

4.2.7 Connecting a computer signal

How to connect a computer signal ?

1. Connect the D15 connector to the projector's Computer input

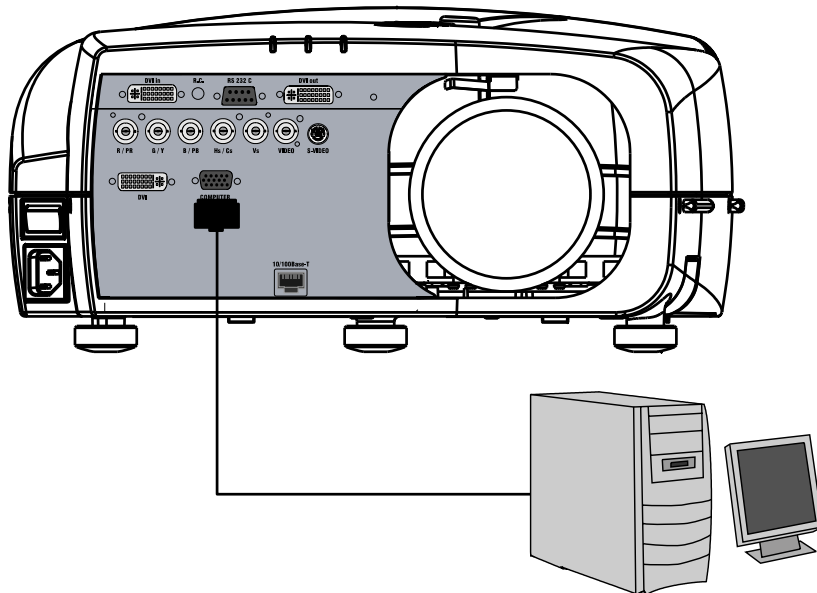

Image 4-10

4.2.8 The DVI output

What can be done ?

The DVI output is a copy of the displayed image (without the OSD menu) and can be connected to an external monitor. Some monitors can fail to synchronize on the DVI signal, in this case disable the *Full screen synchronous representation* function in the *Display Settings* menu.

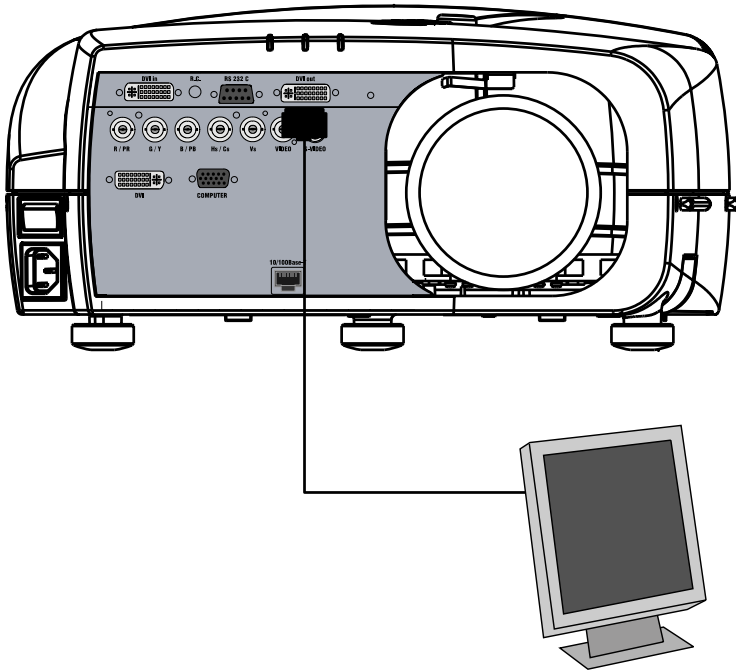

Image 4-11



The DVI output is at 1920x1080 (projector's native resolution)

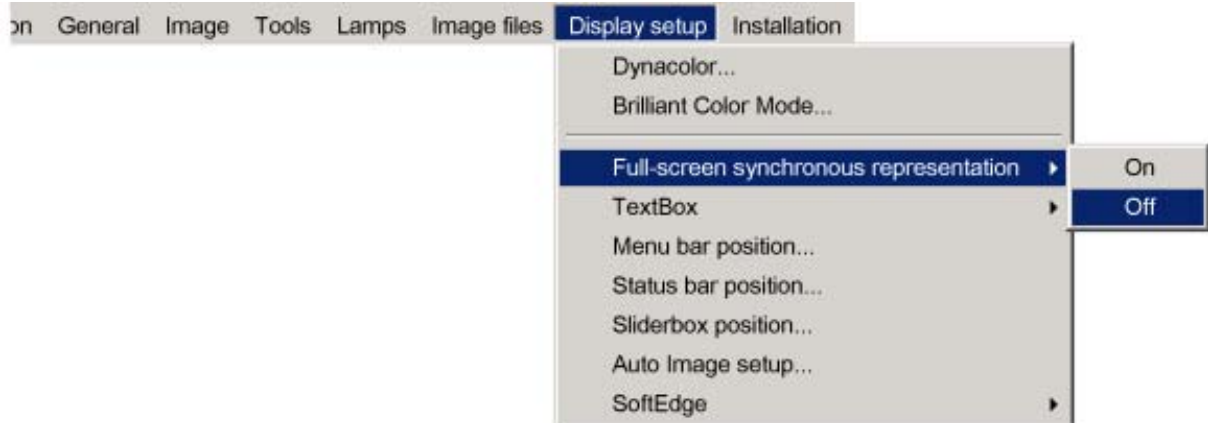

Image 4-12

4.3 Communication connections

Overview

- RS232/RS422 Connections
- Ethernet Connections

4.3.1 RS232/RS422 Connections

What is possible with the RS232/RS422 Connections?

1. Remote control :
 - easy adjustment of projector when connected to an IBM PC (or compatible) or Apple computer.
 - allow storage of multiple projector configurations and set ups.
 - wide range of control possibilities.
 - address range from 0 to 255.
2. Data communications: sending data to the projector or copying the data from the projector to a memory device (hard disc, floppy, etc.).

How to connect the RS232/RS422 ports?

1. Connect the D9 connector from the RS232/RS422 cable to the RS Input on the projector.

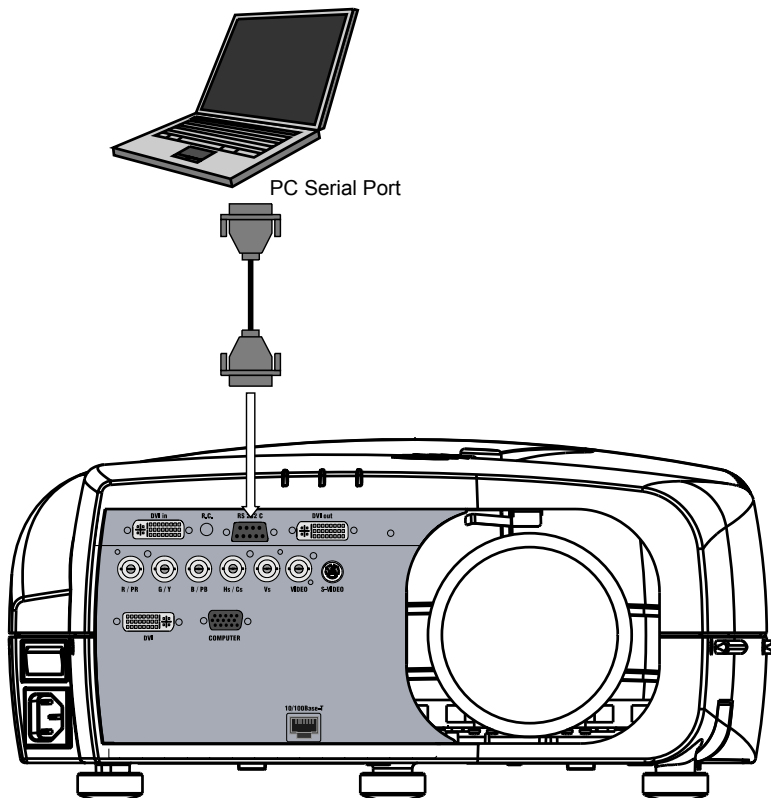

Image 4-13
RS232 connection

2. When applicable connect the RS232/RS422 Output to the next projector in the daisy chain setup.



See the **Setup** section for the baudrate and address setting

4.3.2 Ethernet Connections

What is possible with the Ethernet Connections?

The Ethernet Connections can be used to:

- Upload or download projector software.
- Set up RS232 communication (TCP-packets) with the projector.

How to connect the Ethernet ports?

1. Plug one end of the TCP/IP cable into the PC or the network socket.

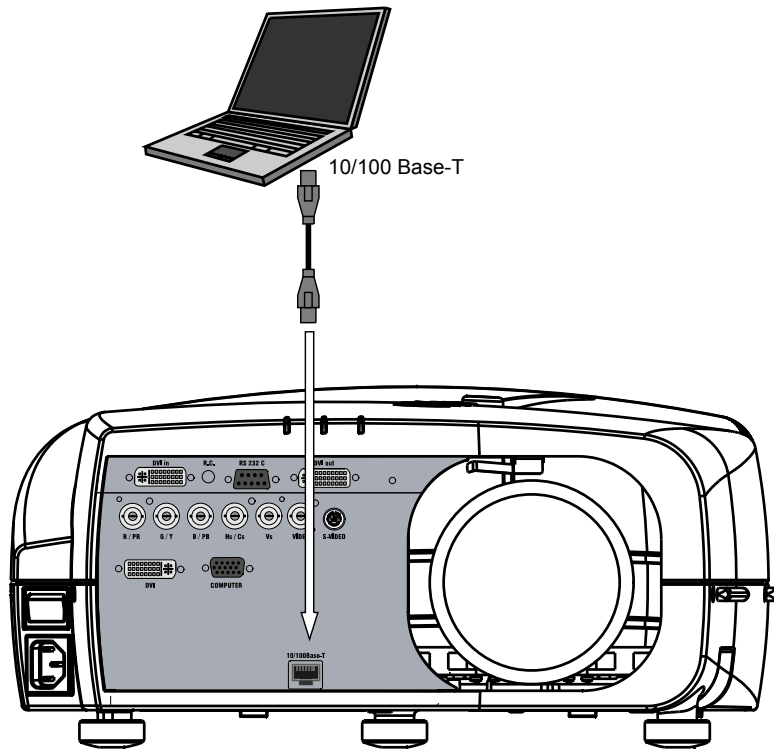

Image 4-14
Ethernet connection

2. Connect the other end of the TCP/IP cable into the '10/100Base-T' port on the projector.
The orange led will light up when network activity is detected.



See the *Setup* section for the network setting

5. SETUP

Overview

- RCU & Local keypad
- Terminology overview
- Switching on
- Setting up the RCU address
- Setting up the projector address (only if necessary)
- Setting up the orientation
- Adjusting the lens
- Setup the baudrate for serial communication
- Network settings
- Preferences

5.1 RCU & Local keypad

How controlling the projector ?

The projector can be controlled by the local keypad or by the remote control unit.

Location of the local keypad ?

The local keypad is located on the topside of the projector.

For key overview: "Terminology overview", page 27

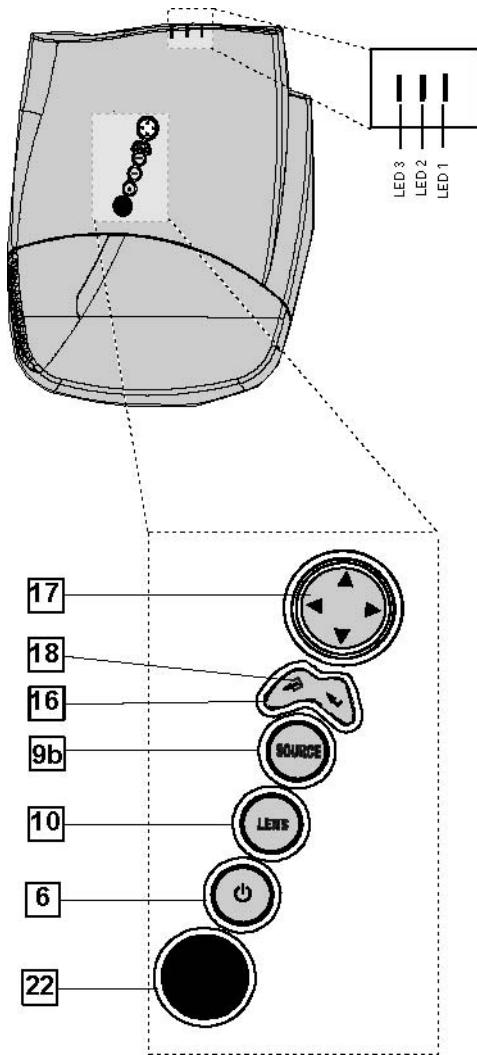

Image 5-1
Local keypad layout

Remote control functions.

This remote control includes a battery powered infrared (IR) transmitter that allows the user to control the projector remotely. This remote control is used for source selection, control, adaptation and set up. It includes automatic storing of picture controls (Brightness, Sharpness...) and settings.

Other functions of the remote control are :

- switching between stand by and operational mode.
- switching to "pause" (blanked picture, full power for immediate restarting)
- direct access to all connected sources.

Diagnose LED's

	Green	Red
LED1	cool down sequence: flickers 60 seconds (120 seconds in case of iQ 400 series) after switching to standby	rescue program (software error)
LED2	only for the versions containing a server: shows when projector is in standby and server is active.	hardware error
LED3	IR acknowledgement	continue : standby flickers : Security = ON

5.2 Terminology overview

Overview

The following table gives an overview of the keys.

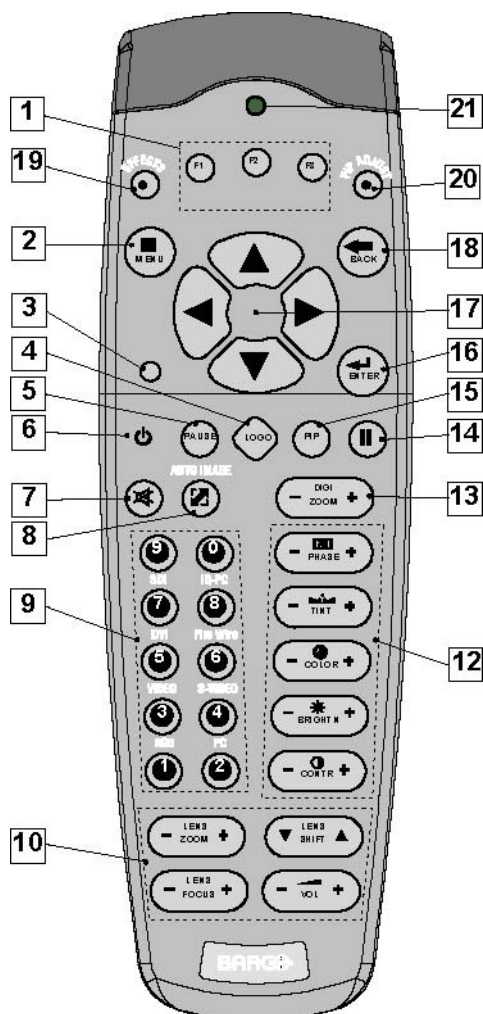

Image 5-2

1	Function keys	user programmable keys with functions for direct access.
2	MENU	Menu key, to enter or exit the Toolbar menu.
3	Address key	(recessed key), to enter the address of the projector (between 0 and 9). Press the recessed address key with a pencil, followed by pressing one digit button between 0 and 9.
4	LOGO key	allows to recall the stored Logo (not in PiP mode)
5	PAUSE	to stop projection for a short time, press 'PAUSE'. The image disappears but full power is retained for immediate restarting.
6	STBY	standby button, to start projector when the power switch is switched on and to switch off the projector without switching off the power switch. Attention : Switching to Standby. When the projector is running and you want to go to standby, press the standby key for 2 seconds.
7	MUTE	to interrupt the sound reproduction (audio = optional).
8	AUTOIMAGE	Auto image, to center the image on the active LCD surface.
9	Digit buttons	direct input selection.
9b	SOURCE button	this button allows to switch through the active (scanned) inputs

5. Setup

10	Lens control	use these buttons to obtain the desired ZOOM, SHIFT, FOCUS.
11	VOL	use this button to obtain the desired sound level (audio = optional)
12	Picture controls	use these buttons to obtain the desired picture analog level.
13	DIGI ZOOM	allows a digital Zoom of a part of the image
14	FREEZ	press to freeze the projected image.
15	PIP	allows to activate the PICTURE IN PICTURE mode
16	ENTER	to confirm an adjustment or selection in the MENU. On the local keypad the ENTER button additionally accesses the PIP window resize function
17	Cursor keys	Cursor Keys on RCU or on the local keypad : to make menu selections or to access the toolbar.
18	BACK	to leave the selected menu or item (go upwards to previous menu).
19	EFFECTS	not yet implemented
20	PIP ADJUST	allows to select a PiP window and change its configuration on screen
21	RC operating indication	lights up when a button on the remote control is pressed. (This is a visual indicator to check the operation of the remote control)
22	IR receiver	IR receiver

Table 5-2



ordernumber RCU: R763794K



Depending on the projectors some functions like LOGO, DIGI ZOOM, PiP, ... are not supported.

5.3 Switching on

How to switch on.

1. Press the power switch to switch on the projector.
 - When '0' is pushed in, the projector is switched off.
 - When '1' is pushed in, the projector is switched on

The projector starts in standby mode, LED3 is red.

Starting image projection.

1. Press **Standby** key once on the local keypad or on the remote control.

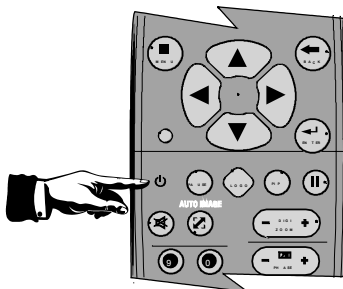

Image 5-3



It may take about 60 seconds before image projection, i.e. no projection until the completion of several operations (software initialization,...).



If the Security mode is enabled, a textbox will be displayed for PIN code entry, see *Security* setting in the *Installation* menu

5.4 Setting up the RCU address

What has to be done ?

To allow the communication between the RCU and the projector the RCU has to be programmed with the same address as the projector.

This address must be in the range 0–9.

To know the address of the projector, one can visualize it in projection mode (on screen) as well as in standby mode (shown with the LED's on top cover of the projector).



For more info on addresses see the appendix



At this stage the image projected may happen to be upside down or mirrored, this can be set in the *Installation* menu under *Projector orientation* (see further setting up the projector's orientation).

Displaying the Projector Address in Standby mode

1. Press the **Address** key (recessed key on the RCU) with a pencil.

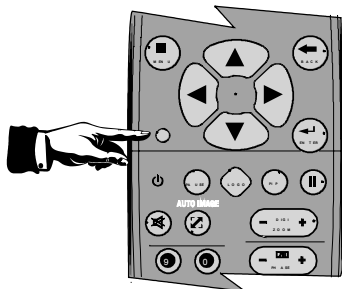

Image 5-4

All the LED's (3) on the top cover of the projector go out.

Then LED1 starts blinking green the number of hundreds. After that LED2 starts blinking the number of tens. Finally LED3 starts blinking green the number of units. If this is done, the original status of the LED's is restored.

Displaying the Projector Address in projection mode)

1. Press the **Address** key (recessed key on the RCU) with a pencil.

The projector's address will be displayed on the screen in a Textbox

Programming the RCU

1. Push the address key If the address is not entered within 5 seconds, the RCU returns to its default address (zero address) and controls then all projectors in the room.
2. Enter the same address with the digit buttons **within 5 seconds** after pushing the address key.
The projector can now be controlled with the RCU.



For example : if the projector address is 3, then press "3" on the RCU to set the RCU's address to match the projector's address.



Common address/Projector address : Beside the projector address, the projector disposes also of a Common address which can be set to "0" or "1" (by default "0").

In other words, an RCU set to address "0" will always control a projector regardless of its projector address (since it uses the common address).

5.5 Setting up the projector address (only if necessary)

What can be done ?

The projector is shipped with projector address set to "0"

In some cases the projector address must be changed, for example if an unique RCU is used to control 2 or more projectors (independently).

In the OSD menu *Projector Address*, the following addresses can be programmed :

- Projector address: address defined by the user, may be from 0 to 255
0-9 is used for RCU communication, 0-255 being used for RS232 serial communication.
- Common address : address may be 0 or 1



For more info on addresses see the appendix

How to change the projector's address ?

1. Press **MENU** to activate the Tool bar
2. Press → to select the *Installation*
3. Press ↓ to Pull down the *Installation* menu
4. Use ↑ or ↓ to select *Projector address*

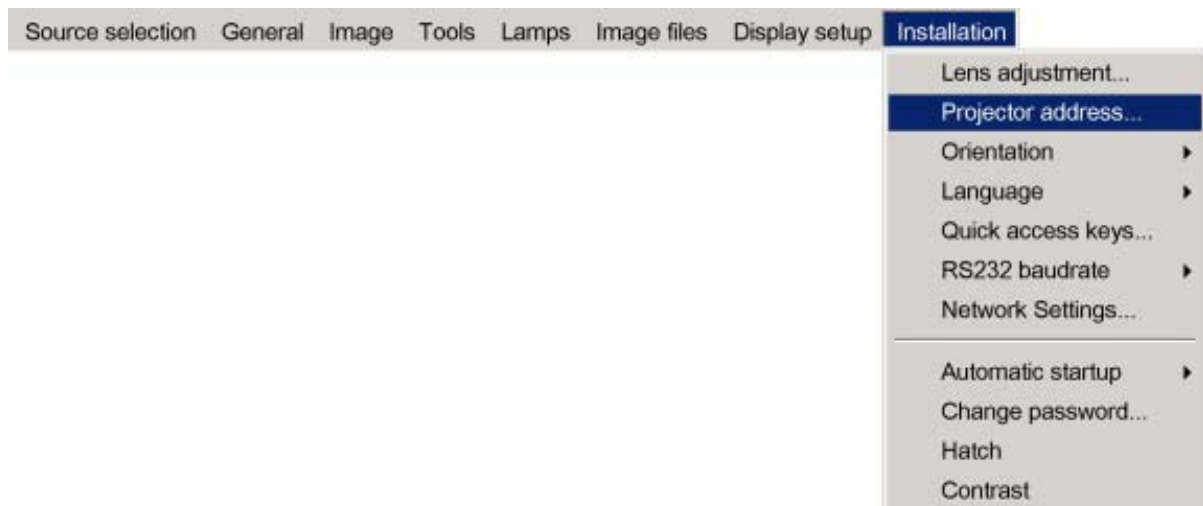

Image 5-5

5. Press **ENTER**

A dialog box appears on the screen

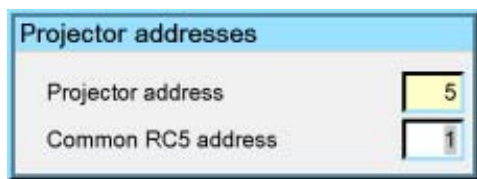

Image 5-6

6. Enter the new projector address with the digit keys on the RCU, the local keypad or the cursor keys.

How to change the common address ?

1. Proceed in the same way as for the projector address

5.6 Setting up the orientation

What must be done ?

Depending on the mechanical orientation of the projector, the projector's internal settings have to be adapted.

The projector is shipped (default) with a table/front orientation.

How to set the orientation ?

1. Press **MENU** to activate the Tool bar
2. Press → to select the *Installation* item
3. Press ↓ to Pull down the *Installation* menu
4. Use ↑ or ↓ to select *Orientation*
5. Press → to pull down the menu
6. Use ↓ or ↑ to select the desired orientation

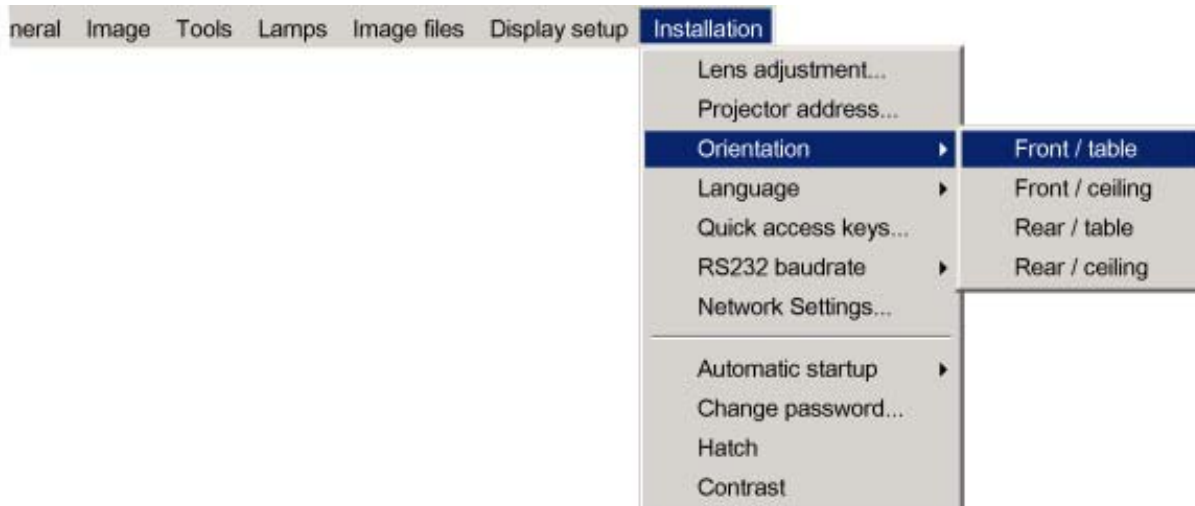

Image 5-7

7. Press **ENTER**

The projection is adapted and a bullet shows the active configuration.

5.7 Adjusting the lens

What must be done ?

Depending on the projection distance and the lens used, the image may not be at the desired size, position and/or may be out of focus.

The projector will always allow you to shift your image vertically as well as horizontally (when available) to position it on the screen. In addition, motorized lenses will also allow you to Zoom and focus the image.

5. Setup

All these lens parameters can be adjusted using the RCU, the local keypad or in the Installation menu of the projector's OSD.

- Zoom (only for motorized lenses)
- Focus (only for motorized lenses)
- Vertical Shift



The lens can also be adjusted via the dedicated keys on the remote.

How to Zoom/focus or shift via the RCU (or keypad)

1. Press **LENS ZOOM** or **LENS FOCUS** or **LENS SHIFT** on the RCU

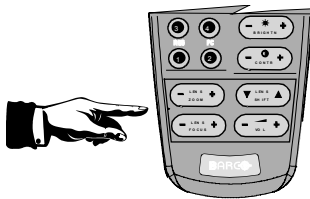

Image 5-8

2. Use the arrow keys to adjust

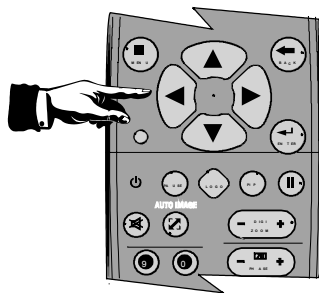

Image 5-9

How to Zoom/focus or shift in the OSD ?

1. Press **MENU** to activate the Tool bar
2. Press **→** to select the *Installation*
3. Press **↓** to Pull down the *Installation* menu
4. Use **↑** or **↓** to select *Lens Adjustments...*

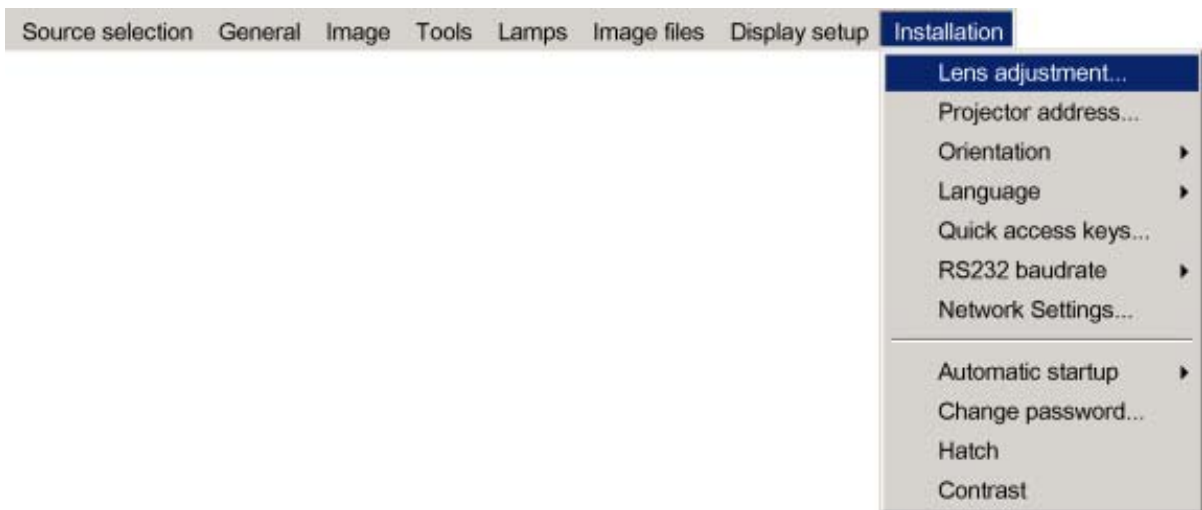

Image 5-10

5. Press **ENTER**

A text box appears on the screen, follow the instructions.

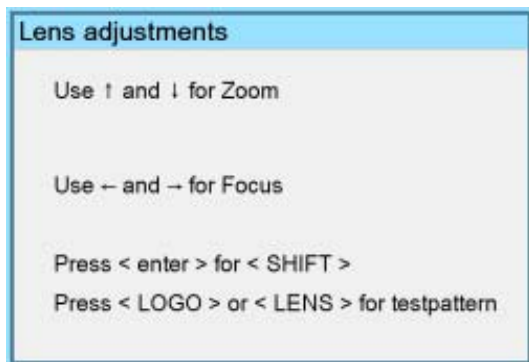

Image 5-11

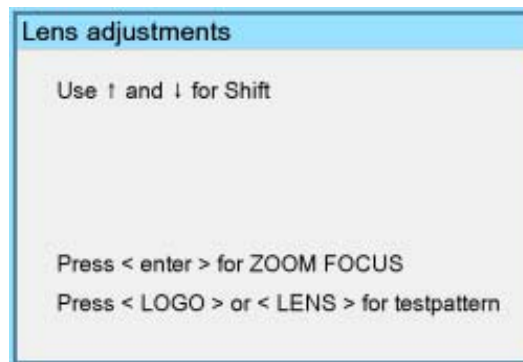

Image 5-12



The use of a sheet of paper held in front of the screen can be useful to determine the focus plane (position for best focus)



Vertical shift range : -25%(down) to 140%(up)
 Except for the QCLD (0.85:1) : -25%(down) to 30%(up)

5.8 Setup the baudrate for serial communication

What can be done ?

The RS232 IN port of the projector allows you to communicate with any other equipment disposing of an RS232 port (generally a PC used to upgrade the projector's firmware) using the RS232 protocol. The baudrate must be set to the same value on both the projector and the other equipment.

How to change the baudrate?

1. Press **MENU** to activate the Tool bar
2. Press → to select the *Installation* item
3. Press ↓ to Pull down the *Installation* menu
4. Use ↑ or ↓ to select *RS232 baudrate*

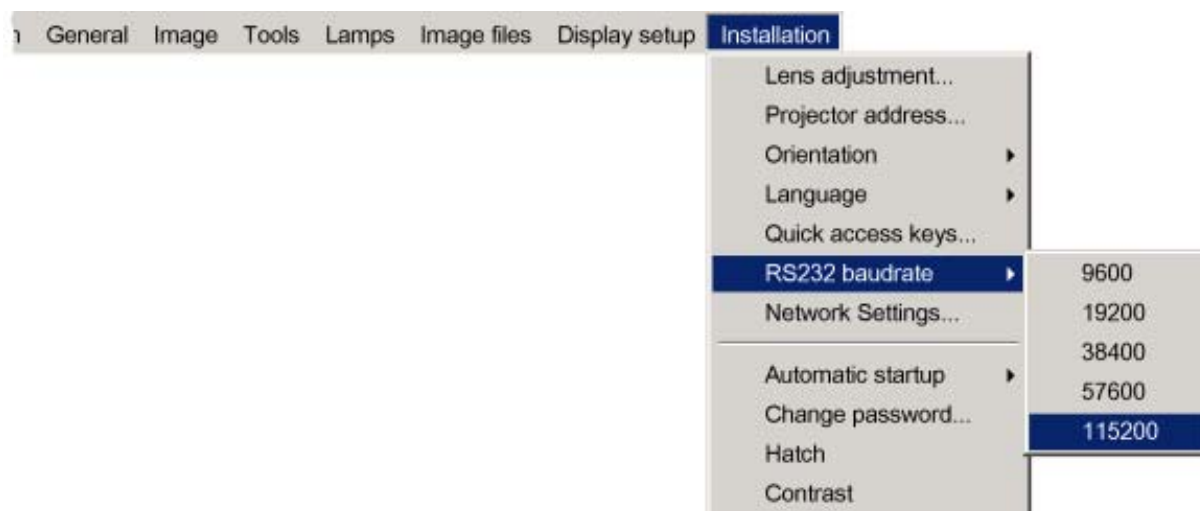

Image 5-13

5. Press → to pull down the menu
6. Use ↓ or ↑ to select the desired baudrate

5. Setup

7. Press **ENTER**



Always select the highest rate (115200) unless otherwise specified.

5.9 Network settings

What can be done?

These settings are used to set the Ethernet Communication parameters.

The Ethernet connection can be used to upload/download projector software and/or to set up communication (TCP-packets) with the projector.

Following parameters are available :

MAC Address	MAC Address of the projector (This is a non-adjustable value programmed into the Ethernet board).
IP Address (Current)	IP Address of the projector (This is a non-adjustable value).
Subnet Mask	Subnet Mask (This is a non-adjustable value)
Gateway	Gateway (This is a non-adjustable value)
DHCP	DHCP setting: <ul style="list-style-type: none">• Yes: The projector will dynamically obtain its IP address from the DHCP server.• No: The IP address needs to be entered manually. Note that when selecting Fixed IP the IP settings fields are enabled
IP Address	Fixed IP Address of the projector : this field can be edited when Fixed IP is selected
Subnet Mask	Subnet Mask : this field can be edited when Fixed IP is selected
Gateway	Gateway : this field can be edited when Fixed IP is selected
Hostname	Hostname : this field can be edited when DHCP is selected

How to set up the network settings ?

1. Press the **MENU** key to activate the Menu bar.
2. Push the cursor key ← or → to highlight *Installation* in the menu bar.
3. Push the ↓ key to pull down the *Installation* menu.
4. Push the cursor key ↑ or ↓ to highlight *Network settings* and press **ENTER** to select.

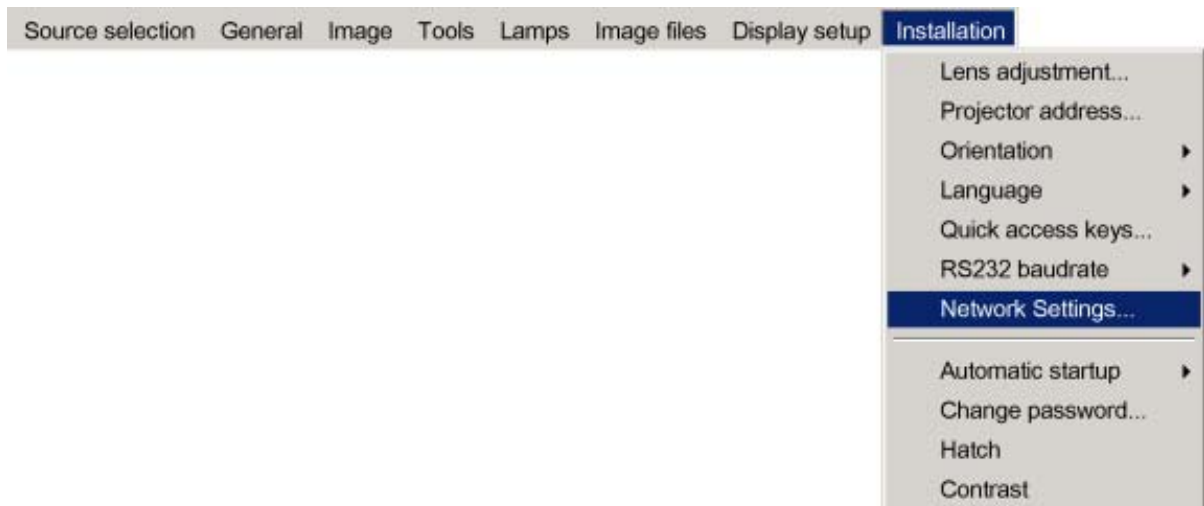

Image 5-14

A dialog box will be displayed.

The image shows a 'Network Settings' dialog box with three sections: 'Current', 'Fixed IP settings', and 'DHCP settings'. The 'Current' section has fields for MAC Address (00.04.a5.00.0e.06), IP Address (150.158.193.179), Subnet Mask (256.256.248.000), and Gateway (150.158.192.001). Below these are radio buttons for 'Use Fixed IP' (unselected) and 'Use DHCP' (selected). The 'Fixed IP settings' section has fields for Ip Address (150.158.193.179), Subnet Mask (255.255.248.000), and Gateway (160.159.192.001). The 'DHCP settings' section has a 'Hostname' field. At the bottom are 'Apply settings' and 'Cancel' buttons.

Image 5-15

5. Push the cursor key ↑ or ↓ to highlight the desired parameter.
6. Use the cursor key ← or →, the numeric keys on the RCU, or the local keypad, to edit and change the values.
7. Press **Apply settings** to apply the changes

A dialog box is shown. The different executed operations are shown with a checkbox. The last operation *Restarting network* takes a few seconds more.

The image shows a 'Please wait while updating settings...' dialog box with a list of operations, each with an unchecked checkbox: 'Writing new IP Address', 'Writing new Subnet Mask', 'Writing new Gateway Address', 'Writing new hostname', 'Writing new DHCP on/off state', and 'Restarting network'.

Image 5-16

5.10 Preferences

Overview

- Language setting
- Automatic startup

5.10.1 Language setting

List of languages

The list of selectable languages depends on the software version of the projector.

How to change the Language ?

1. Press **MENU** to activate the Tool bar

5. Setup

2. Press → to select the *Installation* item
3. Press ↓ to Pull down the *Installation* menu
4. Use ↑ or ↓ to select *Language*
5. Press → to pull down the menu
6. Use ↓ or ↑ to select the desired language

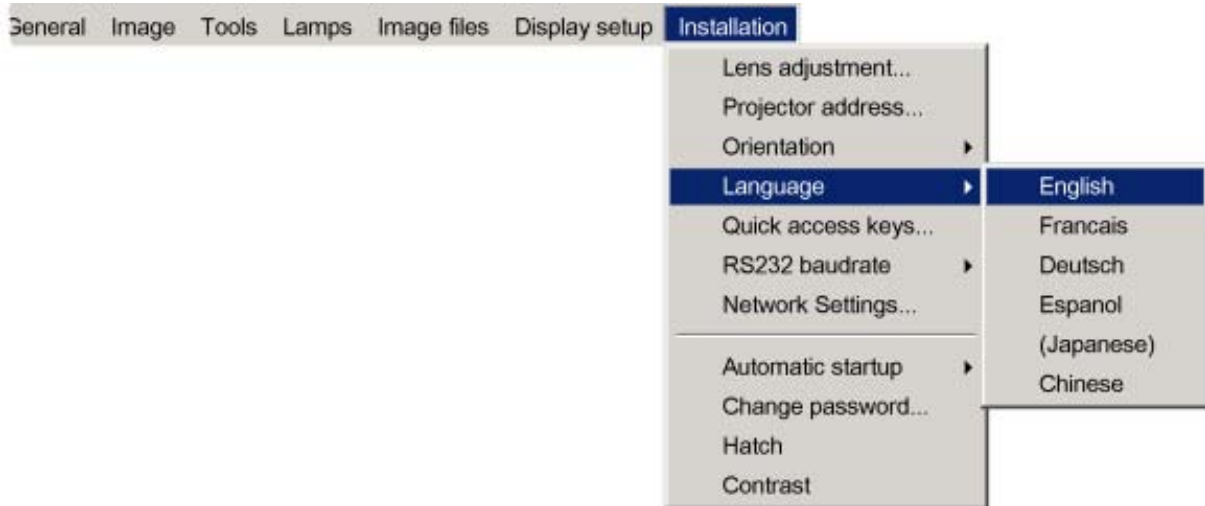

Image 5-17

7. Press **ENTER**

The language is adapted and a bullet shows the active selection.

5.10.2 Automatic startup

What can be done ?

The automatic startup allows to bypass the standby state i.e. start up without going in standby state after switching on the projector.

This means that the automatic startup allows immediate restart of the projector after a power failure (breakdown), i.e. without passing through the standby state, by recovering the previous settings (previous source,...).

This function can be disabled if undesired or inadequate for safety reasons, etc.



CAUTION: If the Automatic startup function is enabled one must be aware of the fact that it involves safety precautions

Make sure that the projector (or the operators!) will not be affected by altered environmental conditions when restarting at power resume.



Unless it is required, it is advised to leave this setting OFF.

In case of a power breakdown, this may introduce unwanted conditions at power resume : projector starting up with high lamp temperature conditions, bad PC status, ...

How to enable/disable the Automatic startup?

1. Press **MENU** to activate the Tool bar
2. Press → to select the *Installation* item
3. Press ↓ to Pull down the *Installation* menu
4. Use ↑ or ↓ to select *Automatic startup*
5. Press → to pull down the menu
6. Use ↓ or ↑ to enable/disable the automatic startup

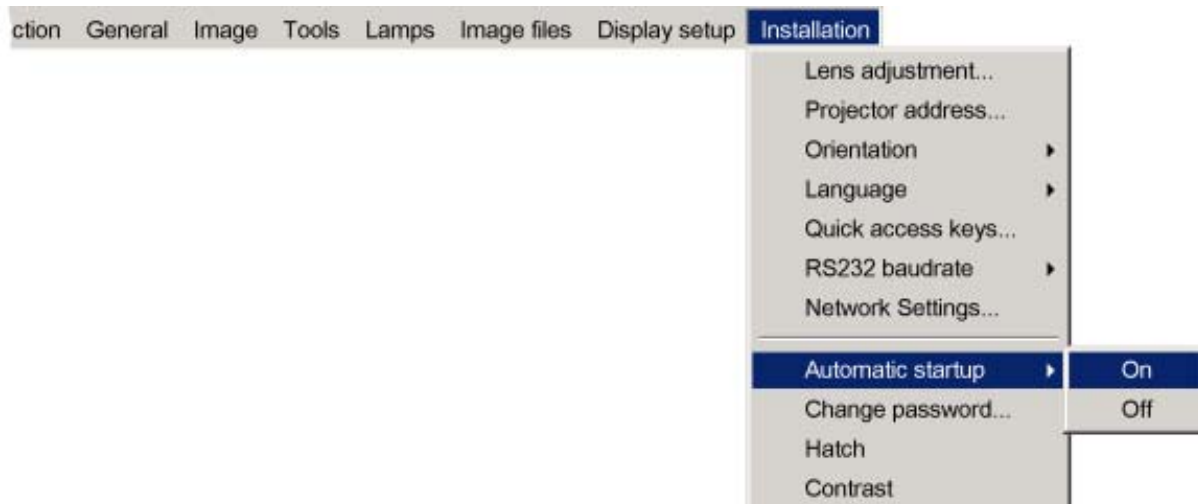

Image 5-18

7. Press **ENTER**

6. GETTING STARTED

Overview

- Start up
- Selecting a source
- Adjusting the image

6.1 Start up

How to start up the projector ?

1. Press the Standby button on the RCU or the local keypad

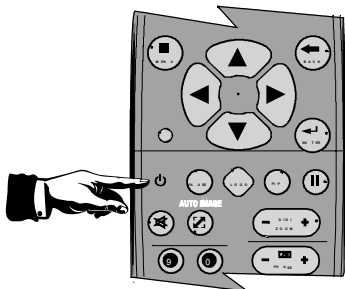

Image 6-1

The last selected source is displayed

6.2 Selecting a source

How to select a source ?

1. Press the digit, corresponding to the desired source, on the remote control .

6.3 Adjusting the image

How to adjust the image ?

1. Use the Image setting buttons on the RCU

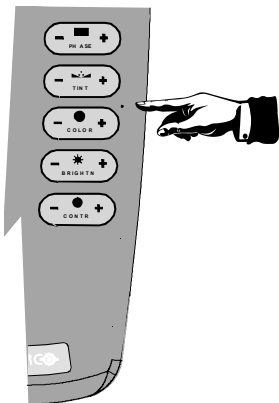

Image 6-2

7. ADVANCED



Note that the *Installation* menu is handled in the Installation chapter and the *Tools* menu is handled in the Troubleshooting section.

Overview

- The OSD Menu
- Using the Dialog boxes
- Source selection
- General
- Image
- Lamp management
- Image files
- Display setup

7.1 The OSD Menu

Structure

The projector has a build in tool bar menu which allows easy access to different parameters for projector setup.

The menu is activated by pressing **MENU**, it contains 2 levels depending on the type of user:

- Level 1: Standard user
- Level 2: Advanced user
Level 2 is password protected, the advanced parameters are only visible when the correct password has been entered (factory password = "0000")



When the advanced parameters are not visible they are replaced by "*More ...*"
Menu items which are not applicable are greyed out.

Menu Layout

A grey line gives the transition between standard and advanced parameters.

The existence of a submenu is indicated by a white arrow.

Three suspension points indicate that the menu item hides a dialog box or a text box.



The menus inserted in this manual are of the advanced type: all the items are visible The menus seen by a standard user on the screen will hence not correspond with the menus in the manual i.e. the advanced items will not be visible, they will be replaced with "*More...*"

Greyed out menus or items are not available in this software version

How to pull down a menu ?

1. Use ↓ to pull down a menu

How to pull down a submenu ?

1. Use → to pull down a submenu

How to exit the submenu ?

1. Press **BACK** to exit a submenu



Press **MENU** to exit the menu



When the menu has been exited for more than 1 minute, the advanced user password has to be re entered.

7.2 Using the Dialog boxes

How to use the dialog boxes ?

Some parameters are modified by means of a dialog box, where selections can be made and/or values can be entered.

The values can be entered in several ways:

Entering numeric values using the numeric keys on the remote control

1. Press **ENTER** to activate the input field.

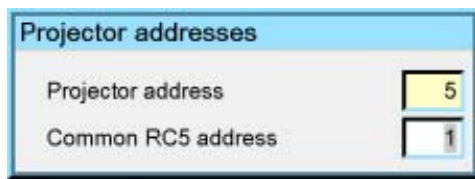

Image 7-1

2. Key in the desired value.

Entering numeric values using the arrow keys on the remote control

1. Press **ENTER** to activate the input field.
2. Press ← or → to select the digit to be changed.

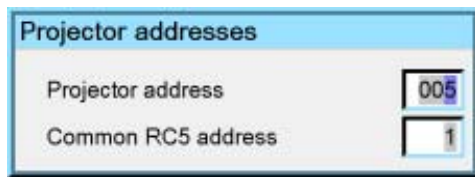

Image 7-2

3. Press ↓ or ↑ to increase or decrease the value.

Entering numeric values using the arrow keys on the local keypad

1. Press **ENTER** to activate the input field.
2. Press ← or → to select the digit to be changed.
3. Press ↓ or ↑ to increase or decrease the value.



To confirm the changes always press **ENTER**.

Use ↓ or ↑ to browse between the different fields.



In some cases an alphanumeric value (file name, ...) has to be entered. Use ↑ or ↓ to scroll through the character values once the input field is activated.

Following characters can be browsed in this particular order:

Decimal scroll list: 0123456789

Signed decimal scroll list: 0123456789-

ASCII scroll list: ABCDEFGHIJKLMNOPQRSTUVWXYZ0123456789+~*/&@#.;:abcdefghijklmnopqrstuvwxyz

7.3 Source selection

Overview

- Source selection
- Composite video
- S-Video
- RGB-YUV
- PC
- DVI

7.3.1 Source selection

Selecting a source

The Source selection menu allows to select one of the different inputs. Another method to select an input source is via the remote control using the numeric keys or by using the local keypad.

Selecting a source from the menu bar (OSD) will always display that source in a **full screen** mode.



When selecting a source with a different resolution (and/or aspect ratio) than the projector's resolution (and/or aspect ratio), the source can be shown in its native resolution or can be re-scaled to the projector's resolution, the latter case brings of course some loss of quality.



The resolution of the projector is 1920x1080 with an aspect ratio of 16:9



Selecting a source via the local keypad : the Source button on the local keypad allows to access the *Source selection* menu, continue with the arrow buttons and the ENTER button to select a source via the local Keypad

7.3.2 Composite video

When

Select composite video when you are in presence of a PAL or NTSC video signal.

A composite video signal is often available on a yellow cinch connector of a Camera, VCR or DVD player.

How to select the composite video input ?

1. Press **MENU** to activate the Tool bar
2. Press ↓ to Pull down the Source Selection menu
3. Use ↑ or ↓ to select *L2 Video*



Image 7-3

4. Press **ENTER** to confirm your choice

A bullet indicates the selected composite video source which now appears on the screen.

Adjustments on a Composite video signal

The projector allows different adjustments on a composite video signal. Depending on the type of signal (NTSC /PAL) the terminology may differ :

- Contrast
- Brightness
- Color : adjusts the level of color saturation in a PAL signal
- Tint : adjusts the level of color saturation in an NTSC signal
- AGC: Automatic Gain Control

7.3.3 S-Video

When

Select the S-Video input when in presence of a video signal also called S-VHS signal.

An S-Video signal is available on the Mini-Din connector of a camera, VCR or DVD player.

Adjustments on a S-Video signal

The projector allows different adjustment on a video signal. Depending on the type of signal (NTSC /PAL) the terms differ :

- Color : adjusts the level of color saturation in a PAL signal
- Tint : adjusts the level of color saturation in an NTSC signal

How to select the S-Video input ?

1. Press **MENU** to activate the Tool bar
2. Press **↓** to Pull down the Source Selection menu
3. Use **↑** or **↓** to select *L2 S-Video*



Image 7-4

4. Press **ENTER** to confirm your choice

A bullet indicates the selected composite video source which now appears on the screen.

7.3.4 RGB-YUV

When

Select RGB-YUV when in presence of a data signal of the type RGB+ sync connected to the RGB input (5 BNC's) or a component signal of the type (R-Y)/Y/(B-Y). The submenu of RGB-YUV allows to select whether it is an RGB signal or a component signal YUV.

These signals are often available on a VGA D15 connector of a PC or another image generator.



An RGB data signal can have its sync signal added in different ways, refer to the Installation section for more information on the RGB+sync signals accepted by the RGB input.

How to select the RGB input ?

1. Press **MENU** to activate the Tool bar
2. Press **↓** to Pull down the Source Selection menu
3. Use **↑** or **↓** to select *L2 RGB-YUV*
4. Use **→** to open the menu

5. Use ↑ or ↓ to select *RGB* or *YUV*



Image 7-5

6. Press **ENTER** to confirm your choice

A bullet indicates the selected source which now appears on the screen.

Adjustments on an RGB signal

The projector allows different adjustments on an RGB signal :

- Contrast
- Brightness
- Phase
- Input balance
- AutoImage : or manual edit of the image file settings

7.3.5 PC

When

Select PC when you are in presence of a data signal of the RGB + sync form connected to the D15 input connector of the projector.



An RGB data signal can have its sync signal added in different ways, refer to the Installation section for more information on the RGB+sync signals accepted by the PC input.

How to select the PC input ?

1. Press **MENU** to activate the Tool bar
2. Press ↓ to Pull down the Source Selection menu
3. Use ↑ or ↓ to select *L3 PC*



Image 7-6

4. Press **ENTER** to confirm your choice

A bullet indicates the selected composite video source which now appears on the screen.

7.3.6 DVI

When

The projector is equipped with 2 DVI inputs, one located on the layer 1 and the other on layer 3.

7. Advanced

Select DVI when in presence of digital data signal connected to a DVI input of the projector. These signals are often available on a PC or other image generator.

How to select the DVI input on layer 1 ?

1. Press **MENU** to activate the Tool bar
2. Press **↓** to Pull down the Source Selection menu
3. Use **↑** or **↓** to select *L1 DVI*



Image 7-7

4. Press **ENTER** to confirm your choice
A bullet indicates the selected composite video source which now appears on the screen.

How to select the DVI input on layer 3?

1. Press **MENU** to activate the Tool bar
2. Press **↓** to Pull down the Source Selection menu
3. Use **↑** or **↓** to select *L3 DVI*



Image 7-8

4. Press **ENTER** to confirm your choice
A bullet indicates the selected composite video source which now appears on the screen.

Adjustments on a DVI signal

The digital nature of this signal eliminates the need of a large number of adjustments

7.4 General

Overview

- Pause
- Freeze
- Identification

7.4.1 Pause

Pause

The Pause function allows to stop the image display, the projector remaining with full power for immediate restart. The image display is interrupted and the projected background is black.

How to pause the image display?

1. Press **MENU** to activate the Tool bar
2. Press → to select *General*
3. Press ↓ to Pull down the General menu
4. Use ↑ or ↓ to select *Pause*

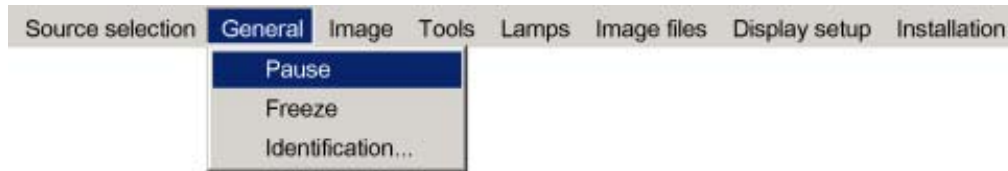

Image 7-9

5. Press **ENTER**



The projection can also be interrupted using the **PAUSE** key on the RCU. To restart the image projection press **PAUSE**

7.4.2 Freeze

Freezing the image

With the Freeze function, the image can be frozen. To restart the image, reuse the Freeze function or press the **FREEZE** button on the remote.

How to freeze the image ?

1. Press **MENU** to activate the Tool bar
2. Press → to select *General*
3. Press ↓ to Pull down the General menu
4. Use ↑ or ↓ to select *Freeze*



Image 7-10

5. Press **ENTER** to activate the Freeze function



The image can also be frozen using the **FREEZE** key on the RCU

7.4.3 Identification

The projector's identification screen

The identification screen displays the projector's main characteristics

How to display the identification screen ?

1. Press **MENU** to activate the Tool bar
2. Press → to select *General*
3. Press ↓ to Pull down the General menu
4. Use ↑ or ↓ to select *Identification*

7. Advanced



Image 7-11

5. Press **ENTER**

On the screen appears a text box.

In this case the projector is an iCon H400



Image 7-12

6. Press **MENU** or **BACK** to exit or to go back to the previous menu

7.5 Image

Overview

- Image settings
- Aspect ratio
- Color temperature
- Film mode detection (video only)
- Input balance
- Automatic gain control (AGC)
- Manual gain control

What can be done ?

Correct image settings are important for a good image reproduction. The image settings are made through a dialog box with a scroll bar. Minimal, maximal and actual values are indicated. These settings can also be done directly via the RCU's dedicated buttons, except for the sharpness.

All the image settings like contrast can be done in the *Image/Settings* menu.

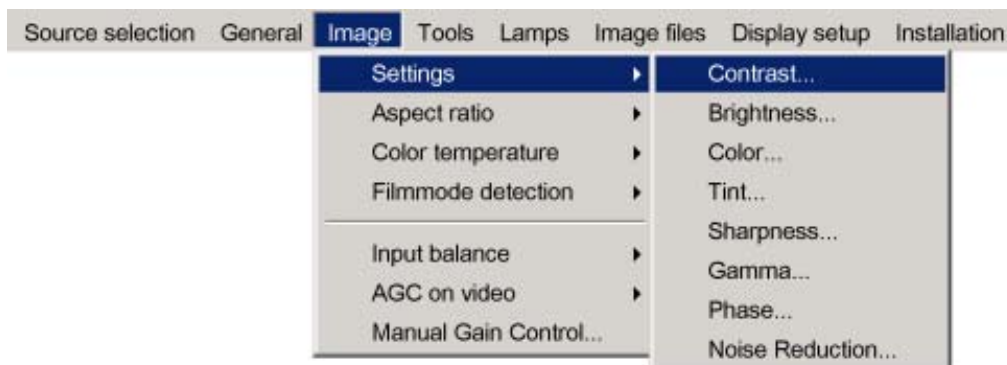

Image 7-13

7.5.1 Image settings

7.5.1.1 Setting the Contrast

Contrast adjustments

Adjust the contrast to “brighten” the white parts of the image.



It is recommended to adjust the brightness before adjusting the contrast.

How to change the Contrast

1. Press **MENU** to activate the Tool bar
2. Press **→** to select the *Image* item
3. Press **↓** to Pull down the *Image* menu
4. Use **↑** or **↓** to select *settings*
5. Press **→** to pull down the menu
6. Use **↑** or **↓** to select *Contrast*
7. Press **ENTER**

On the screen appears now a slider box

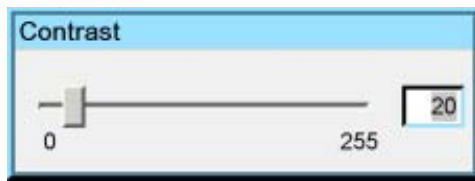

Image 7-14

8. Use **←** or **→**, the numeric keys on the remote, or the keypad to change the contrast

7.5.1.2 Setting the Brightness

Brightness adjustment

Adjusting the brightness will affect the dark areas of the image. Increase the brightness to “lighten” up the parts that are too dark.

How to change the Brightness

1. Press **MENU** to activate the Tool bar
2. Press **→** to select the *Image* item
3. Press **↓** to Pull down the *Image* menu
4. Use **↑** or **↓** to select *settings*
5. Press **→** to pull down the menu
6. Use **↑** or **↓** to select *Brightness*
7. Press **ENTER**

On the screen appears now a slider box



Image 7-15

8. Use **←** or **→**, the numeric keys on the remote, or the keypad to change the brightness

7.5.1.3 Color

Color adjustment

Adjust the Color to obtain more or less saturated colors.

How to change the Color

1. Press **MENU** to activate the Tool bar
2. Press → to select the *Image* item
3. Press ↓ to Pull down the *Image* menu
4. Use ↑ or ↓ to select *settings*
5. Press → to pull down the menu
6. Use ↑ or ↓ to select *Color*
7. Press **ENTER**

On the screen appears now a slider box

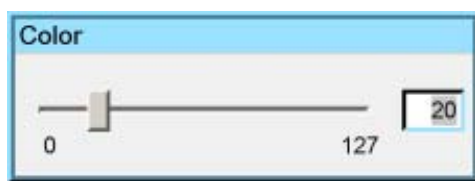

Image 7-16

8. Use ← or → , the numeric keys on the remote, or the keypad to change the color

7.5.1.4 Tint (NTSC video signals only)

Tint adjustment

Tint adjustment is only applicable for NTSC video signals. The tint adjustment allows the reddish and greenish tones to be corrected.

How to change the Tint

1. Press **MENU** to activate the Tool bar
2. Press → to select the *Image* item
3. Press ↓ to Pull down the *Image* menu
4. Use ↑ or ↓ to select *settings*
5. Press → to pull down the menu
6. Use ↑ or ↓ to select *Tint*
7. Press **ENTER**

On the screen appears now a slider box

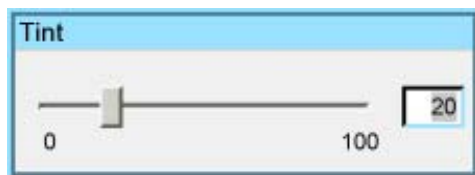

Image 7-17

8. Use ← or → , the numeric keys on the remote, or the keypad to change the Tint

7.5.1.5 Sharpness

How to adjust the Sharpness

1. Press **MENU** to activate the Tool bar
2. Press → to select the *Image* item
3. Press ↓ to Pull down the *Image* menu
4. Use ↑ or ↓ to select *settings*

5. Press → to pull down the menu
6. Use ↑ or ↓ to select *Sharpness*
7. Press **ENTER**

On the screen appears now a slider box



Image 7-18

8. Use ← or → , the numeric keys on the remote, or the keypad to change the Sharpness

7.5.1.6 Gamma

Gamma adjustment

The gamma parameter determines the way your encoded (luminance) signal is transformed into brightness at the output of the projector. A correct gamma setting will allow the use of a maximum of gradations (brightness levels) in the projected image.

How to adjust the Gamma

1. Press **MENU** to activate the Tool bar
2. Press → to select the *Image* item
3. Press ↓ to Pull down the *Image* menu
4. Use ↑ or ↓ to select *settings*
5. Press → to pull down the menu
6. Use ↑ or ↓ to select *Gamma*
7. Press **ENTER**

On the screen appears now a slider box



Image 7-19

8. Use ← or → , the numeric keys on the remote, or the keypad to change the Gamma

7.5.1.7 Phase (RGB signals only)

Phase adjustment

A bad phase adjustment will result in bad transitions and sometimes noise. (for example text will not be clear).

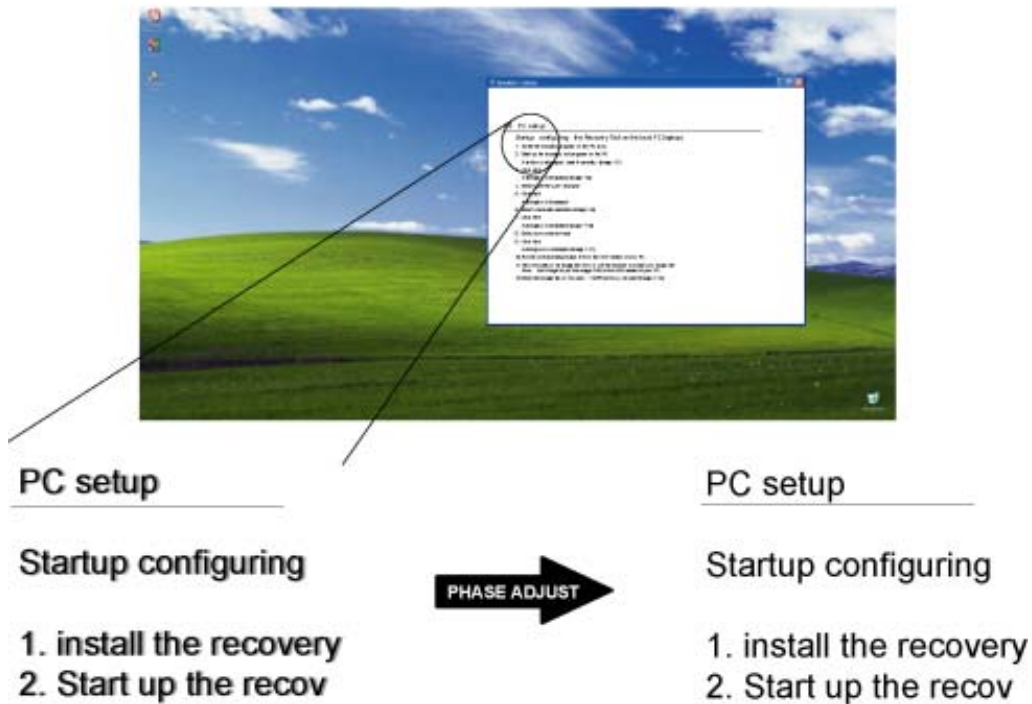

Image 7-20

How to adjust the Phase

1. Press **MENU** to activate the Tool bar
2. Press → to select the *Image* item
3. Press ↓ to Pull down the *Image* menu
4. Use ↑ or ↓ to select *settings*
5. Press → to pull down the menu
6. Use ↑ or ↓ to select *Phase*
7. Press **ENTER**

On the screen appears now a slider box

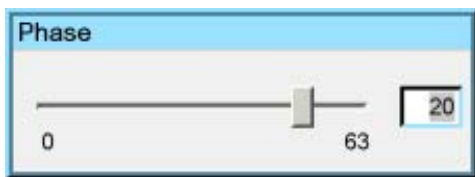

Image 7-21

8. Use ← or → , the numeric keys on the remote, or the keypad to change the Phase

7.5.1.8 Noise Reduction (only for video signals)

How to remove noise in the image

1. Press **MENU** to activate the Tool bar
2. Press → to select the *Image* item
3. Press ↓ to Pull down the *Image* menu
4. Use ↑ or ↓ to select *settings*
5. Press → to pull down the menu
6. Use ↑ or ↓ to select *Noise Reduction*
7. Press **ENTER**

On the screen appears now a slider box

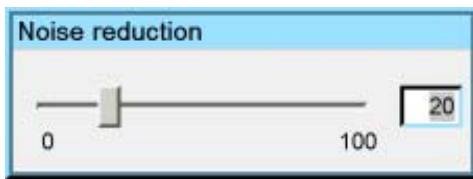

Image 7-22

8. Use ← or →, the numeric keys on the remote, or the keypad to change the Noise Reduction

7.5.2 Aspect ratio

Aspect ratios

The standard aspect ratio used in broadcast television is the 4:3 ratio. However, most of the DVD sources use nowadays the wide screen 16:9 or even the Cinemascope™ 2.35:1 aspect ratio.

Some DVD sources may even use the anamorphic 16:9 or anamorphic 2.35:1 to take advantage of the higher vertical resolution offered by the 4:3 ratio. The "anamorphic" term means that the original wide screen image is squeezed in order to fit the 4:3 aspect ratio.

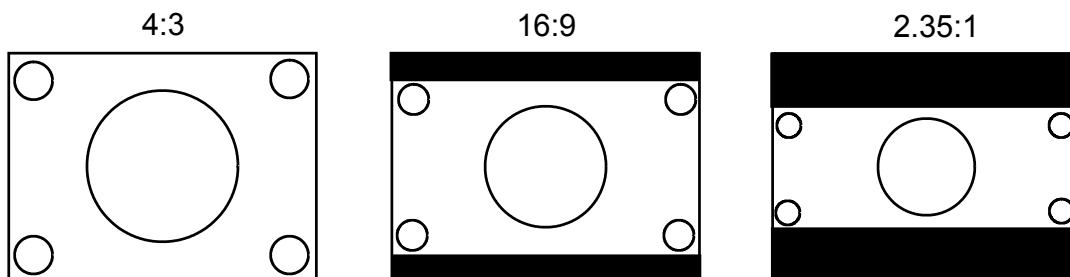

Image 7-23

Common non- anamorphic aspect ratios in DVD sources

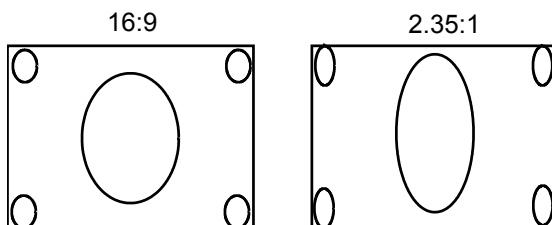

Image 7-24

Anamorphic aspect ratios in DVD sources

What can be done ?

The aspect ratio setting forces the projector to project an image using a defined aspect ratio :

- 4:3
- 16:9
- 5:4
- Auto



The settings do not refer to the aspect ratio of the source !

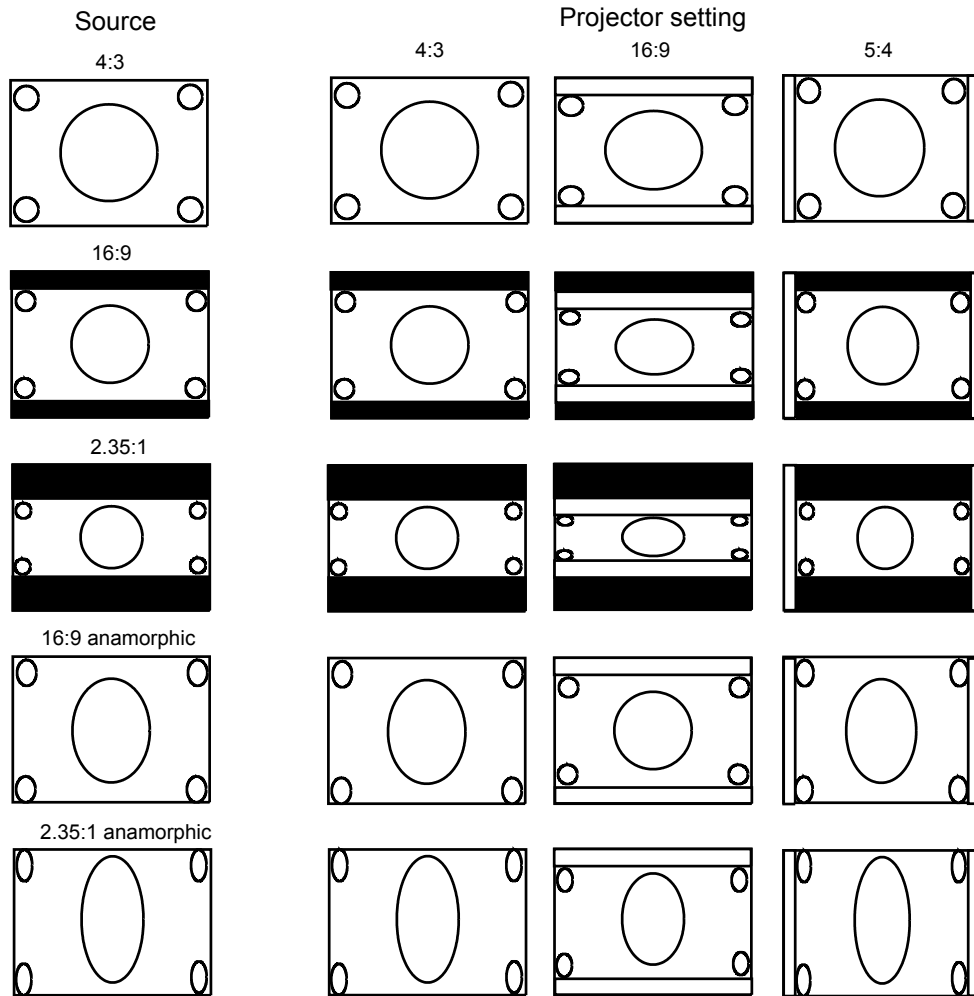

Image 7-25
Possible aspect ratio settings and their effect on different sources

We can conclude that the thumb rule for DVD projection is to always leave the projector in 4:3 format except when dealing with anamorphic sources where the 16:9 setting allows the best reproduction.

The Auto function calculates an aspect ratio based on the information stored in the image files.



Selecting Auto in case of a Video source may shrink the image horizontally



The aspect ratio setting affects only the active source window, the desktop being locked on the native aspect ratio.

How to change the Aspect ratio ?

1. Press **MENU** to activate the Tool bar
2. Press **→** to select *Image*
3. Press **↓** to Pull down the *Image* menu

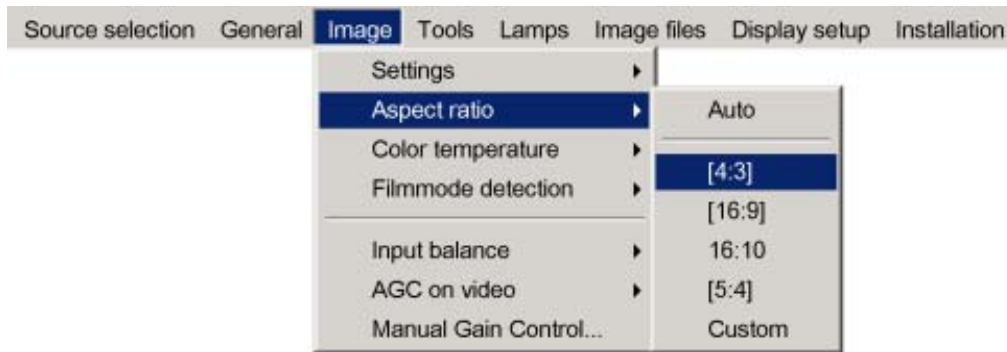

Image 7-26

4. Use ↑ or ↓ to select *Aspect ratio*
5. Use → to open the *Aspect ratio* menu
6. Use ↑ or ↓ to select the desired ratio
7. Press **ENTER** to confirm



The aspect ratio settings are greyed out in case the *Show native resolution* or the *Full screen representation* setting is enabled.

How to set a custom Aspect ratio ?

1. Press **MENU** to activate the Tool bar
2. Press → to select *Image*
3. Press ↓ to Pull down the *Image* menu



Image 7-27

4. Use ↑ or ↓ to select *Aspect ratio*
5. Use → to open the *Aspect ratio* menu
6. Use ↑ or ↓ to select *Custom*
7. Press **ENTER** to confirm

A dialog box is displayed

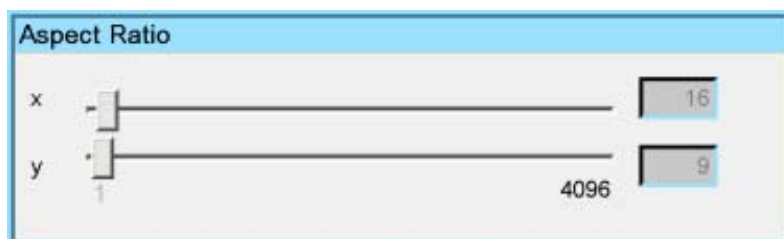

Image 7-28

8. Enter the values for width and height of the image
The image aspect ratio is updated.

7.5.3 Color temperature

What can be done ?

The color temperature can be selected according to the type of source:

There are 4 different preset color temperatures:

- Projector white
- computer : 9300 K
- Video : 6500 K
- Film : 5400 K
- Broadcast : 3200 K

These calibrated presets can be selected and will provide optimum color tracking, the projector allows however the setting of a personal color temperature, this is done in *custom*.

How to select a preset color temperature ?

1. Press **MENU** to activate the Tool bar
2. Press → to select the *Image* item
3. Press ↓ to Pull down the *Image* menu
4. Use ↑ or ↓ to select *Color temperature*
5. Press → to pull down the menu
6. Use ↓ or ↑ to select the desired preset color temperature
7. Press **ENTER**

The color temperature of the image is adapted and a bullet shows the active setting.

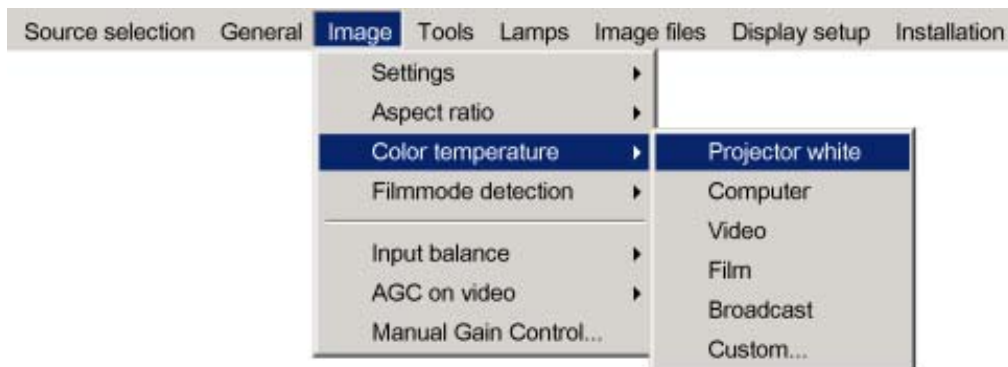

Image 7-29

How to set a custom color temperature ?

1. Press **MENU** to activate the Tool bar
2. Press → to select the *Image* item
3. Press ↓ to Pull down the *Image* menu
4. Use ↑ or ↓ to select *Color temperature*
5. Press → to pull down the menu
6. Use ↓ or ↑ to select *custom*
7. Press **ENTER**

A slider box for the red custom setting is displayed as well as a wizard text box in the lower part of the screen.

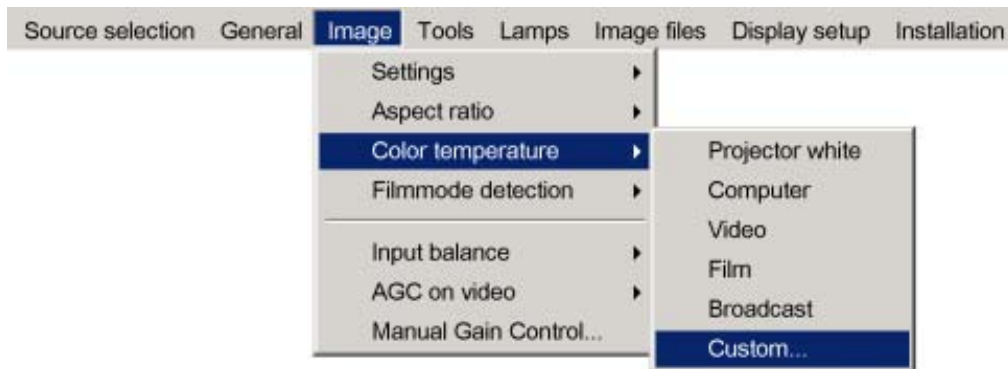

Image 7-30

Follow the instructions on the wizard text box.



Image 7-31



Image 7-32

7.5.4 Film mode detection (video only)

What can be done ?

Some sources like common DVD material are derived from cinema 24 Hz sources (2/2 or 3/2 pull down method).

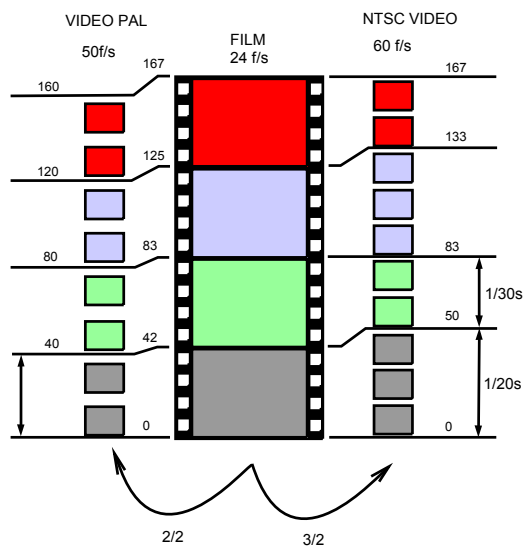

Image 7-33
film to video conversion: 2/2 and 2/3 pull down method

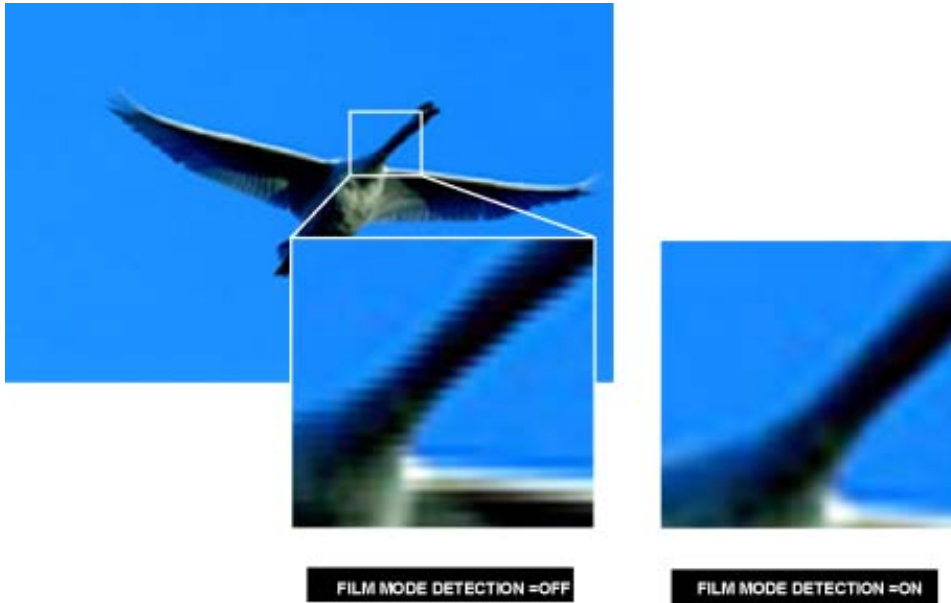

Image 7-34

The film mode detection insures that these converted signals are shown without artefacts, especially motion artefacts due to bad de-interlacing.



This function may cause undesired effects on standard sources, therefore it can be disabled (OFF) at any time

Enabling/disabling the film mode detection

1. Press **MENU** to activate the Tool bar
2. Press **→** to select the *Image* item
3. Press **↓** to Pull down the *Image* menu
4. Use **↑** or **↓** to select *Film mode detection*
5. Press **→** to pull down the menu
6. Use **↓** or **↑** to enable or disable the Film mode detection

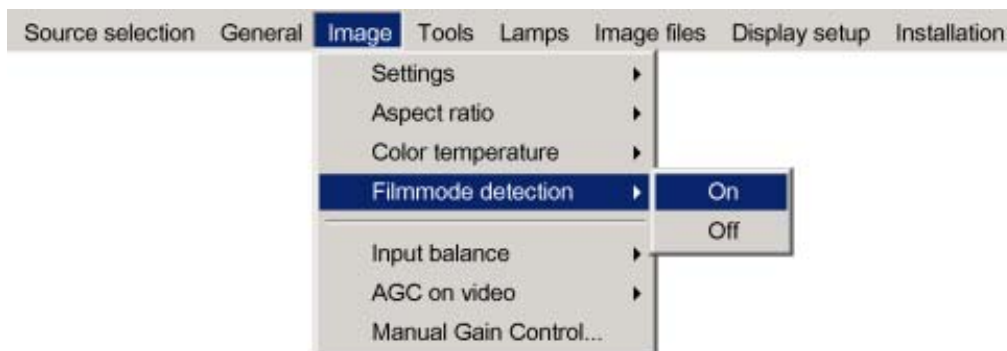

Image 7-35

7. Press **ENTER**

A white bullet shows the active setting

7.5.5 Input balance

Introduction: Unbalanced color signals

When transporting signals, there is always a risk of deterioration of the information contained in the signals.

The alterations of the three color signals will happen independently i.e. the colors will end to be unbalanced,

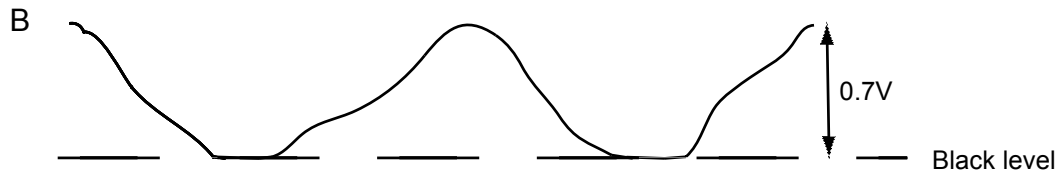

Image 7-36

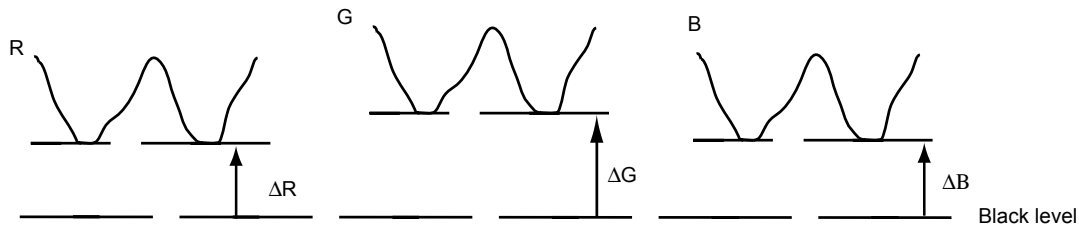

Image 7-37

The objective of input balancing

The objective in input balancing is to "set" the same black level and the same white level for the three colors of a particular input source.



Black level setting : brightness

White level setting : contrast

The same absolute black and white level for the three colors allows the same reference for Brightness and contrast control of the picture !

These two references also set the range in which the ADC will work for that particular source (this explains also why each input balance setting is linked to a particular source and thus saved in the image file).

How can it be done ?

To balance the three color signals of a particular source there are conditions; in fact we must know the black and the white level of the source i.e. :

1. the source in question must be able to generate a white signal, ideally a 100% white (background) full screen pattern
2. the source in question must be able to generate a black signal, ideally a 100 % black (background) full screen pattern



Image 7-38

White balance : In the projector, we will set the contrast for each color until we get a 100% light output picture when projecting a 100% white image (image A)

Black balance : In the projector, we will set the brightness for each color until we get a 0% light output picture when projecting a 100% black image (image B).



The changeover from min to max is indicated by the apparition of bright spots also called "digital noise"



An alternative to a full screen White/black pattern is the standard gray scale pattern, the white bar will be used for white balance and the black bar for black balance.

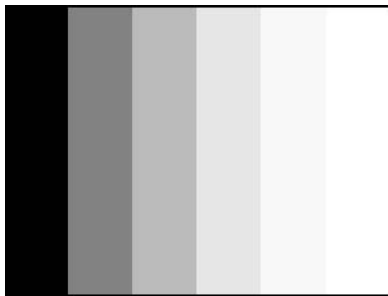

Image 7-39



It is not necessary to adjust the black balance. Its value is automatically set to an optimal value (512).

Performing White input balance

1. Select a black pattern (or gray scale as alternative)
2. Press **MENU** to activate the Tool bar
3. Press → to select the *Image* item
4. Press ↓ to Pull down the *Image* menu
5. Use ↑ or ↓ to select *Input balance*
6. Press → to pull down the menu
7. Use ↓ or ↑ to select *White balance*

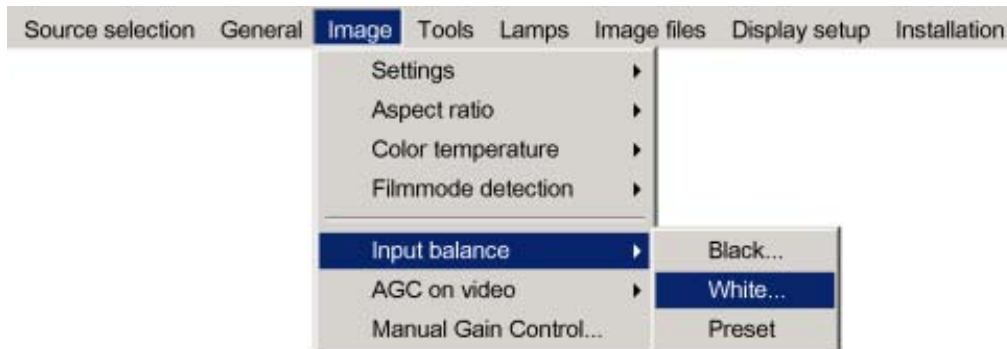

Image 7-40

8. Adjust the red white level (gain) on a minimal value

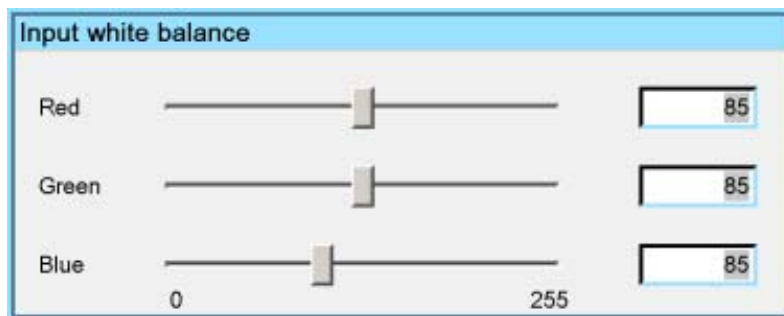

Image 7-41

9. Adjust the blue white level (gain) on a minimal value

Note: *this minimal value is not necessary , provided that the 2 other colors are not influencing too much the color to be adjusted, in fact the aim is to minimize the effect of the two other colors since there is a risk of reaching too soon the transition (bright spots) due to the contribution of these two other colors signals.*

10. Adjust the Green white level (gain) until bright spots appear on the white part of the image
 11. Adjust the Blue white level (gain) until bright spots appear on the white part of the image
 12. Adjust the Red white level (gain) until bright spots appear on the white part of the image
- The projected image should now be noisy neutral grey.



if one uses a gray scale pattern, the bright spots should appear in the white bar.



Selecting *Preset* restores the factory input balance setting



The input balance settings are stored in the image file, each source has its own input balance.

7.5.6 Automatic gain control (AGC)



AGC is only for Video signals

Enabling/disabling the AGC

1. Press **MENU** to activate the Tool bar
2. Press **→** to select the *Image* item
3. Press **↓** to Pull down the *Image* menu
4. Use **↑** or **↓** to select *AGC on Video*
5. Press **→** to pull down the menu
6. Use **↓** or **↑** to enable or disable the AGC
7. Press **ENTER**

A white bullet shows the active setting

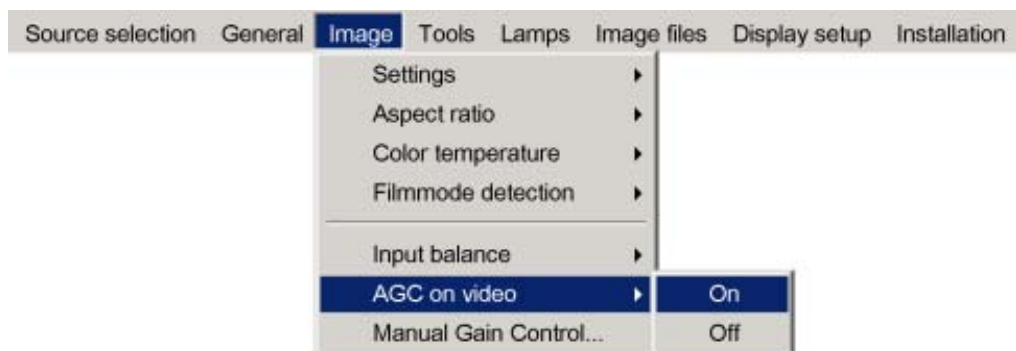

Image 7-42



The AGC can be disturbing in case of Macrovision encoded signals, therefore the AGC can be disabled (OFF) at any time

7.5.7 Manual gain control

What can be done ?

Beside the AGC there is the possibility to manually set the gain of the incoming video signal. When the AGC is enabled (ON), the manual setting does not affect the gain, AGC must therefore be disabled. The manual gain control must be done on an external pattern with white areas (grey scale bar pattern)

How to set the Manual Gain Control ?

1. Press **MENU** to activate the Tool bar
2. Press → to select the *Image* item
3. Press ↓ to Pull down the *Image* menu
4. Use ↑ or ↓ to select *Manual Gain Control*



Image 7-43

5. Press **ENTER**
A scroll bar is displayed

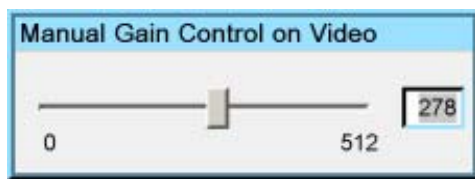

Image 7-44

6. Use ← or →, the numeric keys on the remote, or the keypad to change the gain so as to obtain homogeneous white parts in the image.

7.6 Lamp management

Overview

- Runtimes
- Lamp mode
- History
- Reset lamp Runtime
- Clear lamp error
- Lamp runtime warning

7.6.1 Runtimes

How to display the runtimes ?

1. Press **MENU** to activate the Tool bar
2. Press → to select the *Lamp* item
3. Press ↓ to Pull down the *Lamp* menu
4. Use ↑ or ↓ to select *Runtimes*

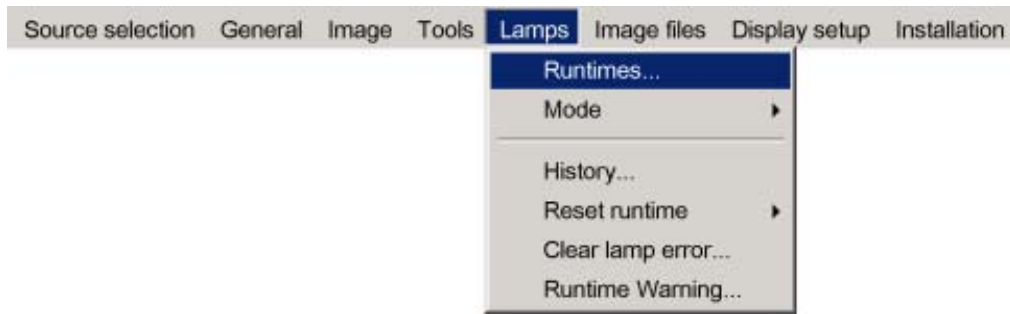

Image 7-45

5. Press **ENTER**

A text box is displayed

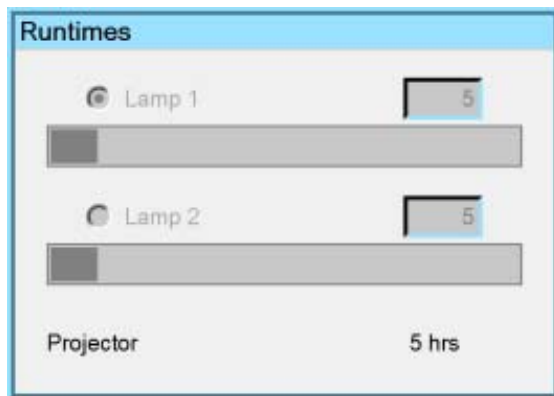

Image 7-46

7.6.2 Lamp mode

Single mode

The projector will always switch to the lamp with the shortest runtime when the difference between the runtimes of lamp 1 and lamp 2 reaches **100 hours**, switching from one lamp to another happens only at switching on of the projector and not during operation.

When the lamp fails or reaches its maximum runtime the projector switches automatically to the other lamp without interrupting the projection



In case of a lamp failure a lamp error is logged and showed on the screen.

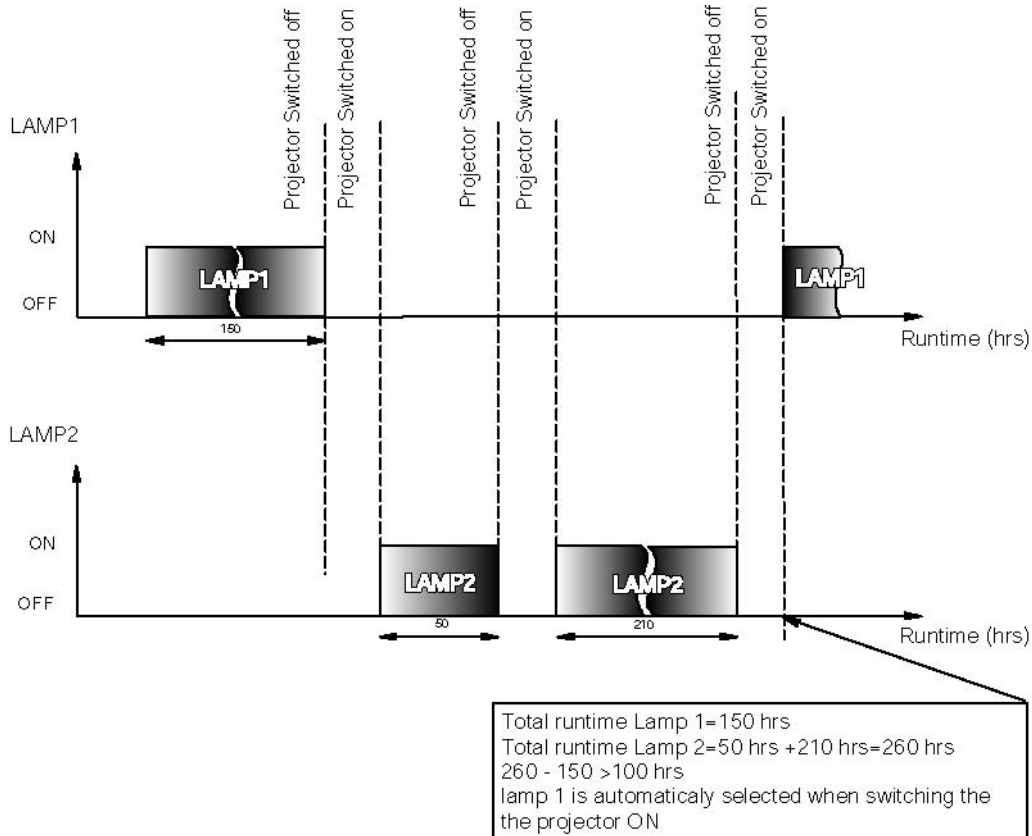

Image 7-47
Single mode operation: switching principle

Dual mode

Both lamps are working at the same time.

When one lamp fails, the projector continues the projection using the remaining lamp. Again the lamp error is logged and shown on the screen.

How to select the lamp mode ?

1. Press **MENU** to activate the Tool bar
2. Press **→** to select the *Lamp* item
3. Press **↓** to Pull down the *Lamp* menu
4. Use **↑** or **↓** to select *Mode*
5. Press **→** to pull down the menu
6. Use **↑** or **↓** to select the desired mode

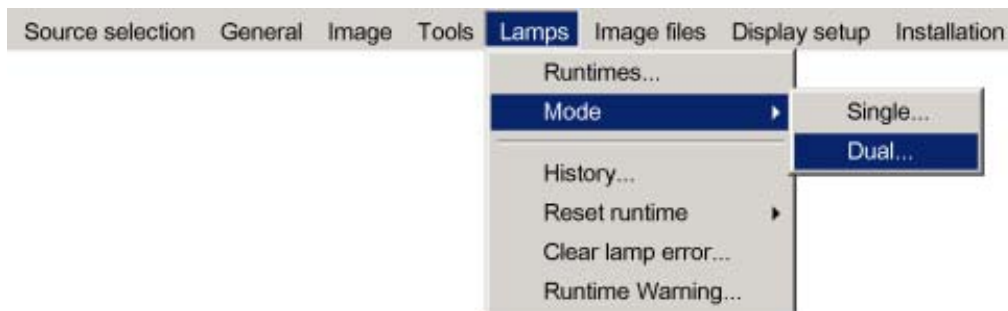

Image 7-48

7. Press **ENTER**

A bullet shows the active mode.



When switching from the dual mode to the single mode the lamp with the longest runtime is switched off.
If the runtimes are equal (if the projector has always been operated in dual mode) then lamp 1 is switched out.



When switching to single mode, returning to the dual mode will not be possible in the first 60 seconds, *Dual* in the menu is greyed out and the LED is flickering, showing that hot restrike (restart) of the lamp is impossible during that time laps (60 sec).

7.6.3 History

How to view the history ?

1. Press **MENU** to activate the Tool bar
2. Press → to select the *Lamp* item
3. Press ↓ to Pull down the *Lamp* menu
4. Use ↑ or ↓ to select *History*

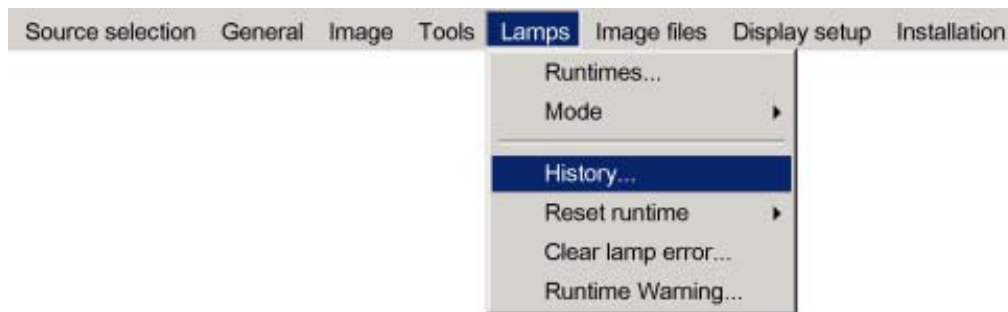

Image 7-49

5. Press **ENTER**

A text box is displayed

Lamp history		
Lamp	Serial no.	Runtime
L1	0001230	900
L2	0001222	900
Current lamps		
L1	0001240	900
L2	0001242	900

Image 7-50

7.6.4 Reset lamp Runtime

When to reset the lamp runtime ?

Reset the lamp runtime whenever you replace a lamp



WARNING: Lamp runtime reset as well as the lamp replacement can only be done by a Barco authorized technician.

How to reset the lamp runtime ?

1. Press **MENU** to activate the Tool bar
2. Press **→** to select the *Lamp* item
3. Press **↓** to Pull down the *Lamp* menu
4. Use **↑** or **↓** to select *Reset runtime*
5. Press **→** to pull down the menu
6. Use **↑** or **↓** to select the lamp to be reset



Image 7-51

7. Press **ENTER**

A dialog box is displayed



Image 7-52

8. Use **←** or **→**, the numeric keys on the remote, or the keypad to enter the serial number of the new lamp (serial number 0000000 will not be accepted).

7.6.5 Clear lamp error

Lamp error

When a failure of one of the lamps has occurred, a lamp logo is displayed in the left corner of the screen. This logo will thus always inform the user on a previous lamp error.



Image 7-53

Once the error has been solved or/and the lamp has been replaced one can remove (clear) the lamp error.

If the error has been cleared without solving the lamp problem the logo will be shown at next lamp startup (projector startup for example)



A lamp failing to startup will be noticed by a low light output of the projector since the projector goes in single lamp mode.



In case of a lamp error contact the local Barco authorized technician

How to clear the lamp error ?

1. Press **MENU** to activate the Tool bar
2. Press → to select the *Lamp* item
3. Press ↓ to Pull down the *Lamp* menu
4. Use ↑ or ↓ to select *Clear lamp error*



Image 7-54

5. Press **ENTER**

A dialog box will be shown to confirm the lamp error removal. Confirm.

The lamp error logo is removed from the screen

7.6.6 Lamp runtime warning

What can be done ?

When the lamp has reached a predetermined runtime , a warning message will be displayed on the screen. The lamp runtime warning can be set in a range from 30 to 200 hours. The runtime warning is displayed by default at 30 hours before end of lamp lifetime.

How to set the lamp runtime warning?

1. Press **MENU** to activate the Tool bar
2. Press → to select the *Lamp* item
3. Press ↓ to Pull down the *Lamp* menu
4. Use ↑ or ↓ to select *Runtime warning*

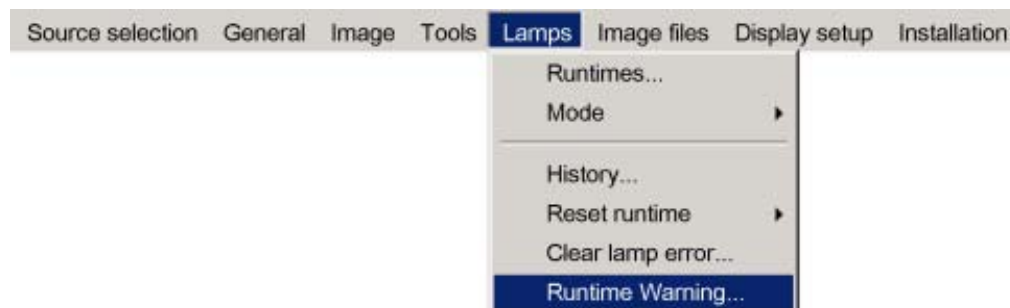

Image 7-55

5. Press **ENTER**

7. Advanced

A dialog box is displayed

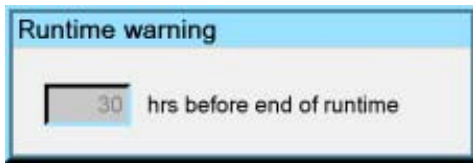

Image 7-56

6. Use ← or →, the numeric keys on the remote, or the keypad to change the runtime warning setting.



WARNING: Lamp runtime reset as well as the lamp replacement can only be done by a Barco authorized technician.

7.7 Image files

Overview

- Introduction to Image files
- Load file
- Forced file load
- Auto Image
- Edit file
- Save as (create a custom file)
- Rename file
- Copy
- Delete

7.7.1 Introduction to Image files

Image files

An image file contains the main characteristics of a source (number of active lines,...). The projector's memory contains a list of files corresponding to the most common sources : standard files.

When a new source corresponds to one of these files, a custom file is created. The file is not automatically saved as a custom file. The Save as... function allows to create and save a custom file.

The active file can always be edited in order to fit exactly the source specifications.



Autolmage creates automatically the best suited image file (custom file) for a new source. Autolmage is used when :

- a new source is detected: Autolmage creates a new custom file which can always be edited if necessary.
- the Autolmage is launched via the button on the RCU, the projector's OSD or from the desktop's OSD

File notation

The notation of the image file happens as follows :

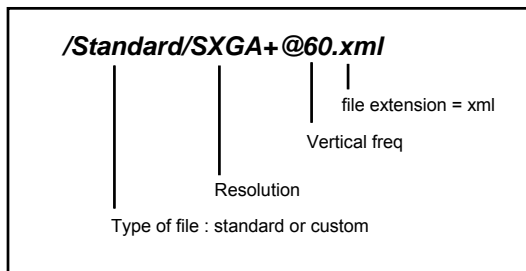

Image 7-57

7.7.2 Load file

When to load a file ?

In some cases the user wants a particular file to be used for the display of a particular source. In this case the user should load the desired file from the image files menu. The load file option will allow the user to choose between several files corresponding more or less to the active source specifications.



In normal operation the file selection (load) will be done automatically by AutoImage.

How to load a file ?

1. Press **MENU** to activate the Tool bar
2. Press → to select the *Image files* item
3. Press ↓ to Pull down the *Image files* menu
4. Use ↑ or ↓ to select *Load*

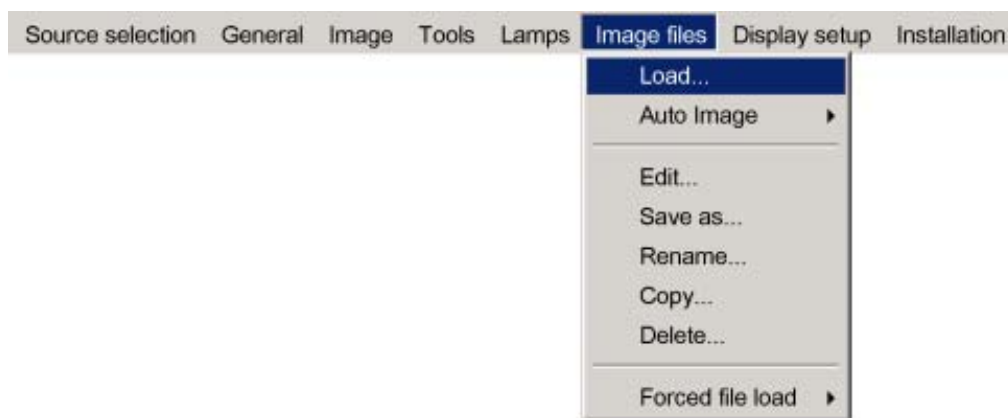

Image 7-58

5. Press **ENTER**
A dialog box is displayed



Image 7-59

6. Use ↑ or ↓ to select the desired file
Tip: For more information (specifications) on the image files see the Appendix section
7. Press **ENTER**
The file is loaded and the image is adapted.



The list of files which may be loaded will be of the data type if the active window is a data window, or they will be of the video type if the active window is a video window.

What to do if the image is not perfect ?

If the displayed image is not correct after AutoImage or after selecting the best fitting file, go to the Edit menu, select the active file and change the settings.

7.7.3 Forced file load

Forced file load

In some cases the user wants only one particular file to be loaded for a particular input (source) i.e. to prevent the (automatic) load of an inadequate file.

One can link a file to every possible input of each layer.

If a file is already selected (forced) to that particular input it will be indicated in the menu.

How to force a file to be loaded ?

1. Press **MENU** to activate the Tool bar
2. Press **→** to select the *Image files* item
3. Press **↓** to Pull down the *Image files* menu
4. Use **↑** or **↓** to select *Forced file load*
5. Press **→** to open the menu
6. Use **↑** or **↓** to select the desired layer (for example Layer 1)
7. Use **↑** or **↓** to select the desired input (for example Data on BNC)

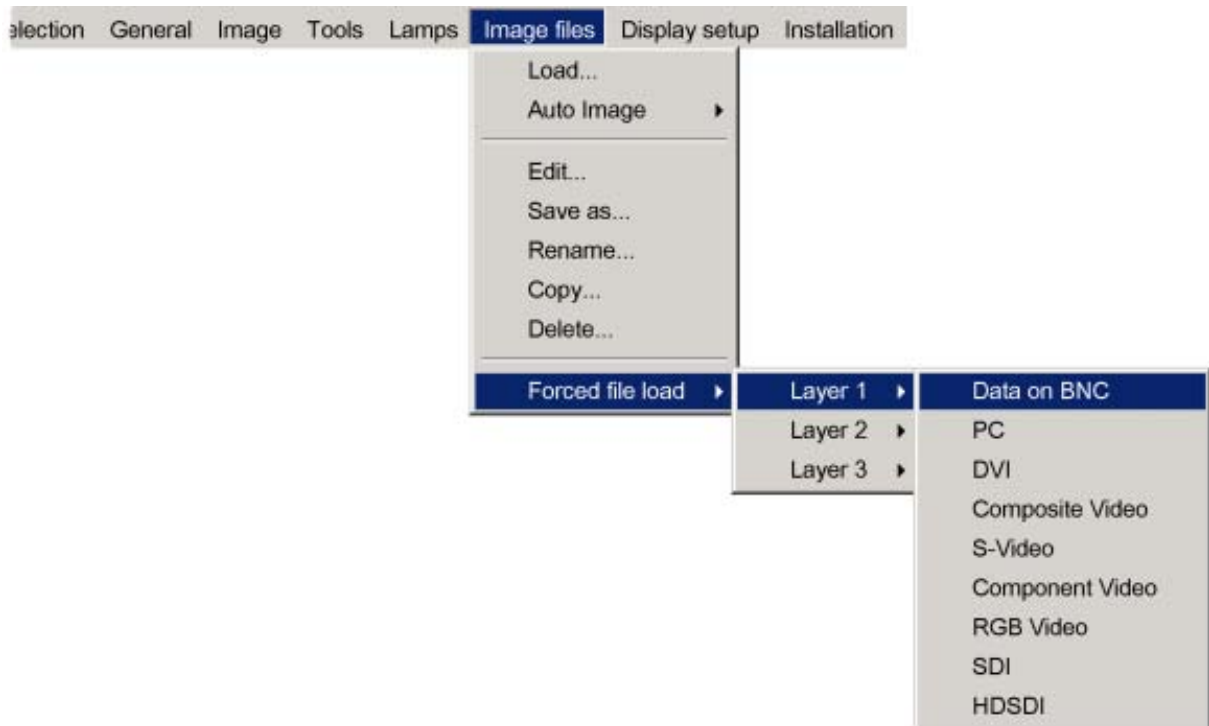

Image 7-60

Note: Inputs that are not hardware compatible with this layer are greyed out.

Note: if a file is already forced for that input it will be shown on the right.

8. Press **ENTER**
The *Load* dialog box is displayed
9. Use **↑** or **↓** to select the desired file (for example */Standard/SXGA+@60.xml*)
10. Press **ENTER**
The file is selected and will be loaded in the future.



To delete the forced file, go to the desired input and press **ENTER**.

7.7.4 Auto Image

What can be done ?

AutoImage creates the best suited image file for the connected source.

It calculates/measures several source parameters :

- Total pixels per line
- Start pixel
- Phase
- Contrast/Brightness levels



Auto Image works only for data images.

The measure of the total number of pixels per line can be done through 2 methods

- Limited scan: a windowing system is used to allow fast tracking.
The operation takes about 20 seconds (depending on file)
- Full scan: tracking is done over the full range.
The operation takes about 1.5 minutes (depending on file)

How to launch Auto Image?

1. Press **MENU** to activate the Tool bar
2. Press → to select the *Image files* item
3. Press ↓ to Pull down the *Image files* menu
4. Use ↑ or ↓ to select *Auto Image*
5. Press → to open the menu
6. Use ↑ or ↓ to select the desired file scan method

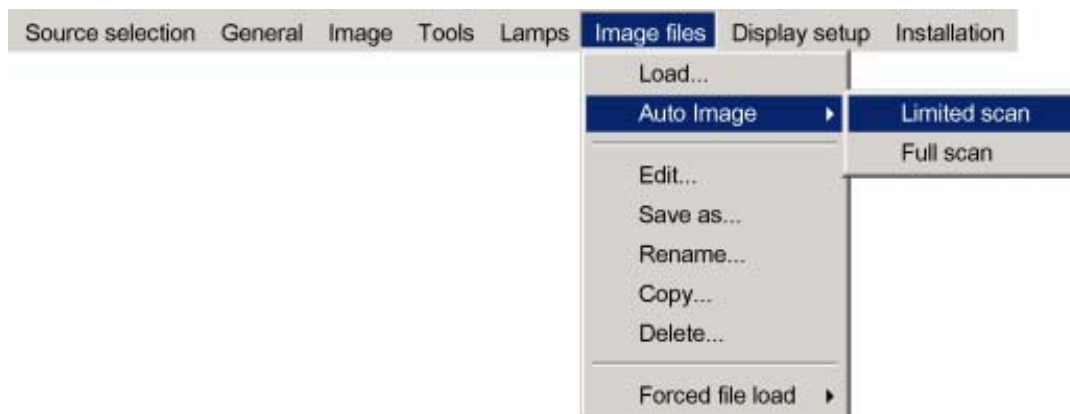

Image 7-61

7. Press **ENTER**



AutoImage acts on the active window. The image in the window may move and change in aspect during the AutoImage process.



Auto Image can also be launched via the RCU with the dedicated AutoImage key.

7.7.5 Edit file

What can be done with the Edit file menu ?

The Edit file menu makes it possible to change the settings of the file according to the real settings of the connected source. Consult the source specifications before entering the data.



only the active file can be edited

How to edit a file ?

1. Press **MENU** to activate the Tool bar
2. Press **→** to select the *Image files* item
3. Press **↓** to Pull down the *Image files* menu
4. Use **↑** or **↓** to select *Edit*

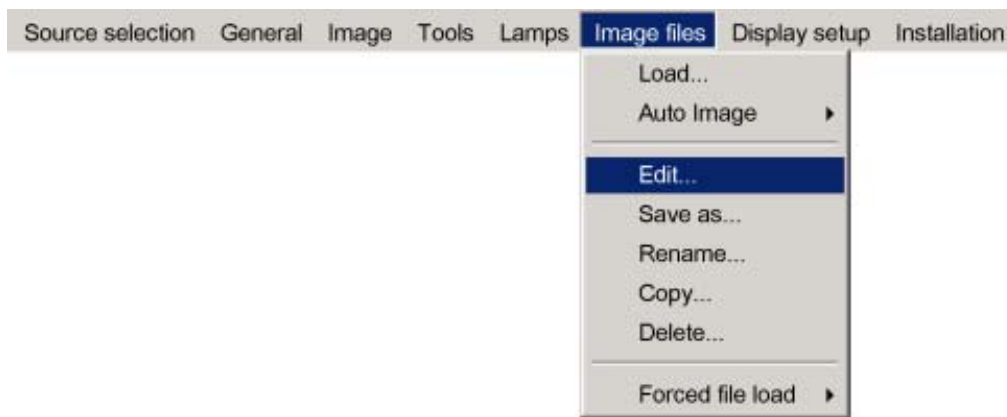

Image 7-62

5. Press **ENTER**
A dialog box containing the active file is displayed

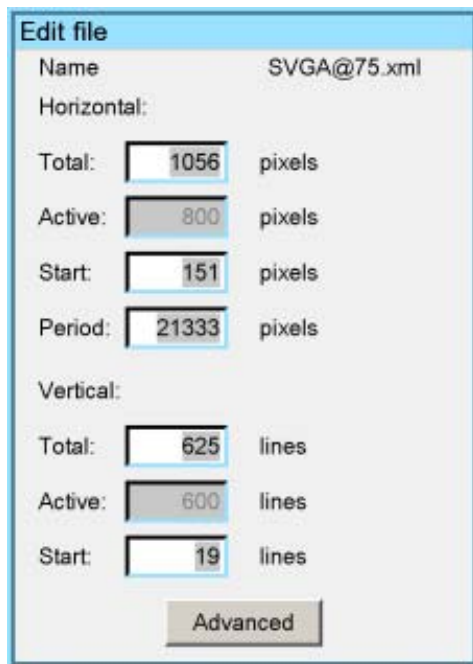

Image 7-63

6. Use **←** or **→**, the numeric keys on the remote, or the keypad to edit and change the values, confirm with **ENTER**
Note: greyed out fields can not be updated (total pixels)

Which items can be adjusted ?

The following items can be adjusted :

- Active horizontal pixels
- Horizontal start in pixels
- Horizontal period in ns
- Active vertical lines
- Vertical start in lines

Advanced video settings

The **advanced** button enables the advanced settings for a video source.

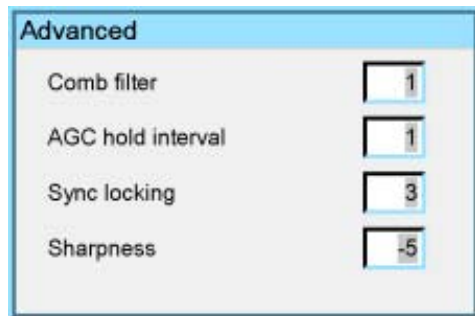

Image 7-64

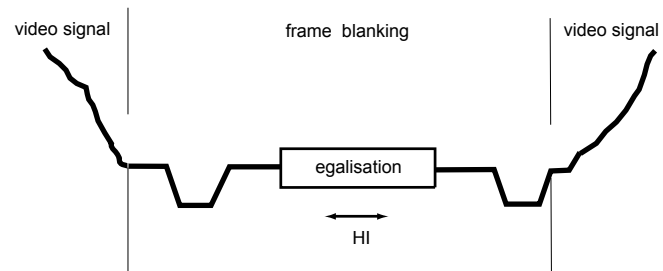

Image 7-65
HI AGC Hold interval

The **Comb filter** is by default enabled.

The **AGC hold interval** is the time interval in which the AGC is inhibited (AGC hold = no update in video amplitude measurement), the advanced parameter allows to choose a short or long hold interval.

A long AGC hold interval eliminates Macrovision® disturbances since the AGC is hold during a long interval, thus reducing the probability to encounter a Macrovision® pulse.

The **sync locking setting** is recommended for poor video signals (ex: poor TV signals).

Sharpness adjustment can be chosen to be coarse or fine.



It is recommended to use the default values.

Advanced Data settings

The **advanced** button enables the advanced settings for a data source.

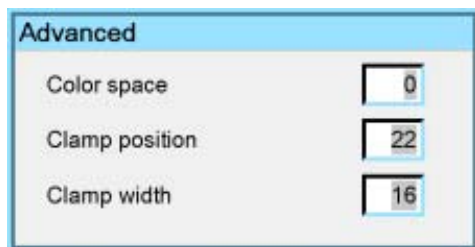

Image 7-66

- color space : allows to select between 5 different color spaces
 - RGB
 - ITU_BT_709
 - SMPTE_240M
 - ITU_BT_601
 - EBU
- Clamp position : allows to set the clamp pulse position in the clamping circuit
- Clamp width : allows to set the width of clamp pulse in the clamping circuit

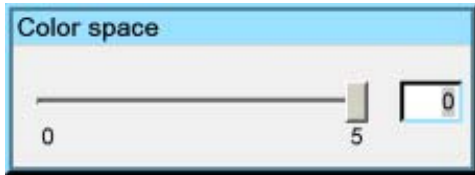

Image 7-67



It is recommended to use the default values.

7.7.6 Save as (create a custom file)

Creating a custom file

When the loaded file is a standard file there is a possibility of saving it as a custom file (= creating a custom file) , this is done with the save as function. The saved file will always be a custom file (saved in the custom directory)



For sources that are often used, a custom file should be created. This custom file will then be loaded automatically and will prevent the AutoImage from being launched.

How to save a file ?

1. Press **MENU** to activate the Tool bar
2. Press → to select the *Image files* item
3. Press ↓ to Pull down the *Image files* menu
4. Use ↑ or ↓ to select *Save as...*

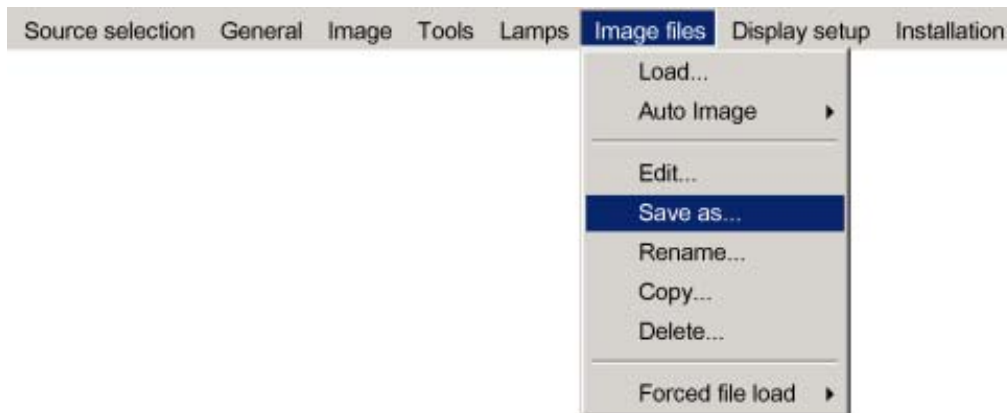

Image 7-68

5. Press **ENTER**
A dialog box is displayed
Use ← or →, ↓ or ↑ the numeric keys on the remote, or the keypad to edit and change the file name, confirm with ENTER.

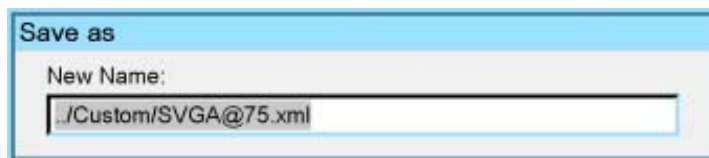

Image 7-69

7.7.7 Rename file

How to rename a file ?

1. Press **MENU** to activate the Tool bar
2. Press → to select the *Image files* item

3. Press ↓ to Pull down the *Image files* menu
4. Use ↑ or ↓ to select *Rename*

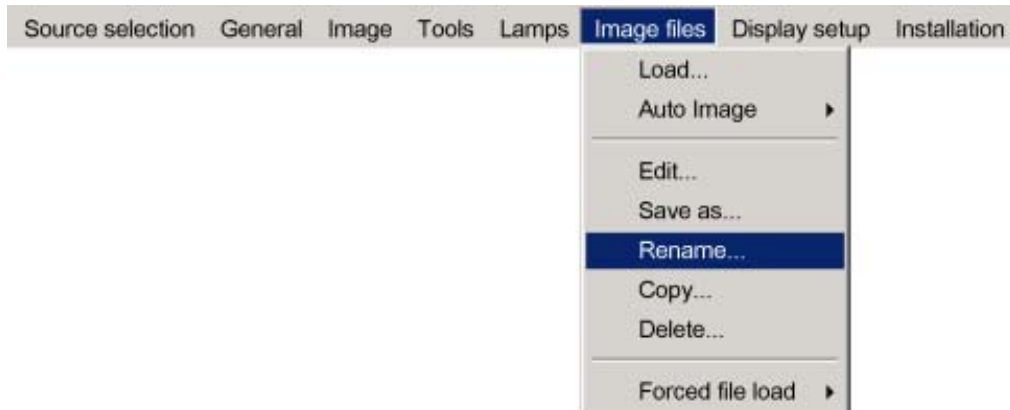

Image 7-70

5. Press **ENTER**
A dialog box is displayed
Use ← or →, ↓ or ↑ the numeric keys on the remote, or the keypad to edit and change the values, confirm with ENTER.

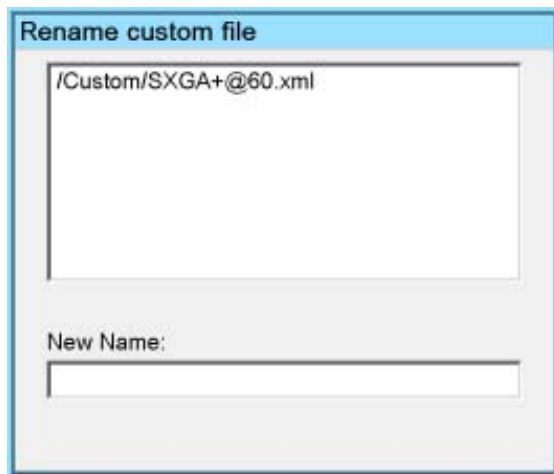

Image 7-71

7.7.8 Copy

Copy a file

The copy function allows to copy a file (standard or custom) to a custom file (to the custom directory).

How to copy a file ?

1. Press **MENU** to activate the Tool bar
2. Press → to select the *Image files* item
3. Press ↓ to Pull down the *Image files* menu
4. Use ↑ or ↓ to select *copy*

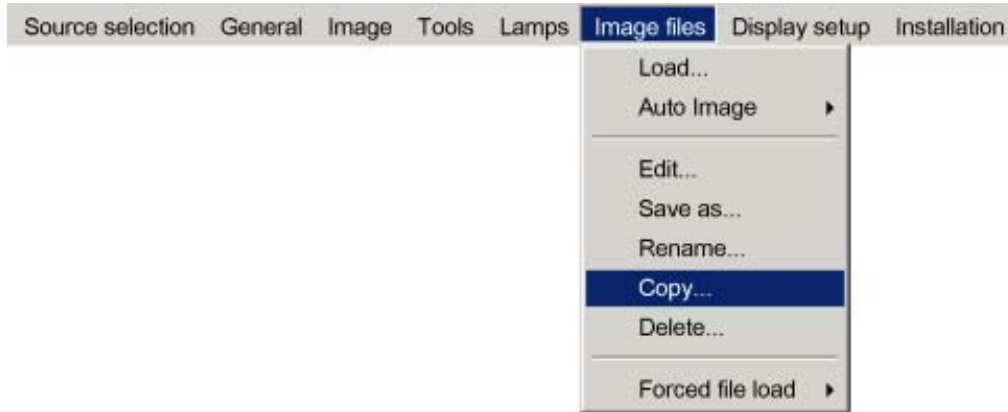

Image 7-72

5. Press **ENTER**
A dialog box is displayed

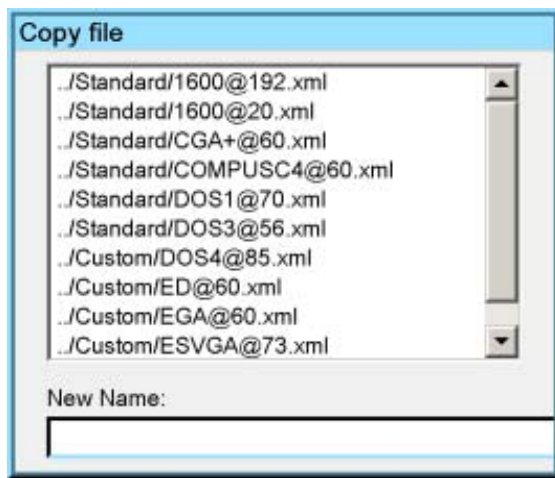

Image 7-73

6. Use ↑ or ↓ to select the file to be copied
7. Press **ENTER**
The file name is copied in the edit field
8. Use the keys on the remote to change the name of the destination file

7.7.9 Delete

How to delete a file ?

1. Press **MENU** to activate the Tool bar
2. Press → to select the *Image files* item
3. Press ↓ to Pull down the *Image files* menu
4. Use ↑ or ↓ to select *delete*

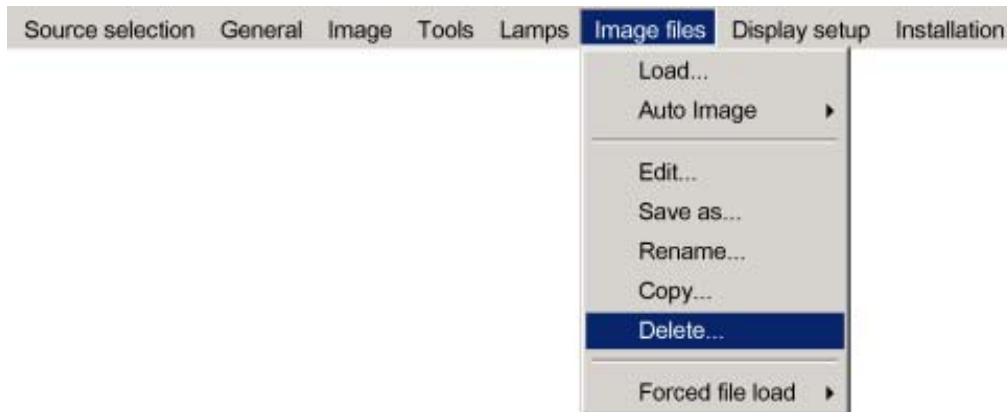

Image 7-74

5. Press **ENTER**
A dialog box is displayed

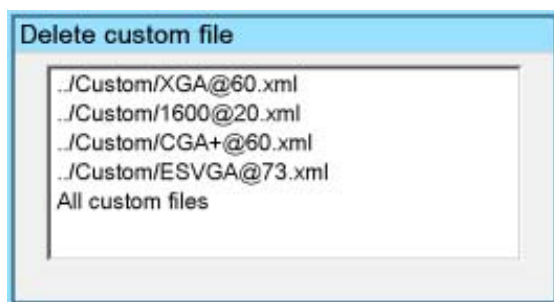

Image 7-75

6. Use ↑ or ↓ to select the desired file
7. Press **ENTER**
The selected file is deleted and is removed from the list

7.8 Display setup

Overview

- Dynacolor™
- Brilliant Color™ mode
- Full screen synchronous representation
- Text box
- Menu bar position
- Status bar position
- Sliderbox position
- Softedge

7.8.1 Dynacolor™

What can be done?

DynaColor™ will eliminate channel-to-channel color variations.

How to define color?

The CIE chromaticity diagram is one way to plot the colors the human eye can see.

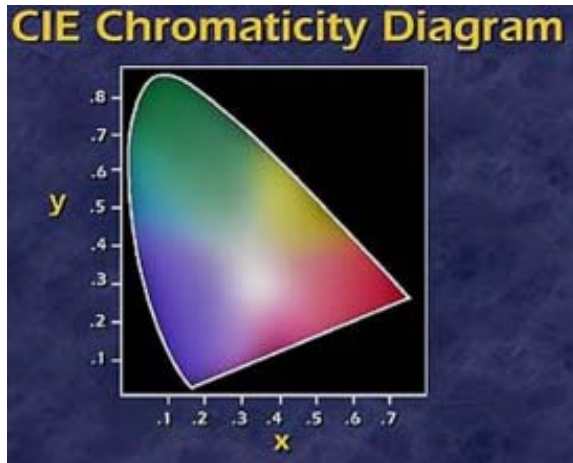

Image 7-76
The CIE chromaticity diagram

A projector can only reproduce a certain color gamut within this diagram. This color gamut is defined by the triangle formed by the x, y coordinates of Red Green and Blue. These parameters are used by the DynaColor™ adjustment.

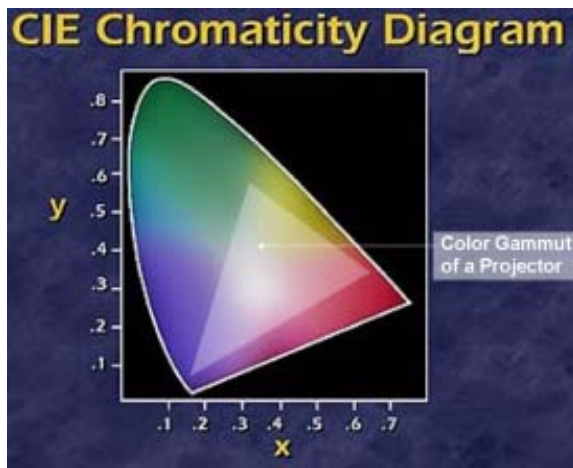

Image 7-77
The projector color gamut is defined by the triangle formed by the x, y coordinates of Red Green and Blue

Due to the tolerance on optical components the x, y values of this color gamut of each projector will differ.

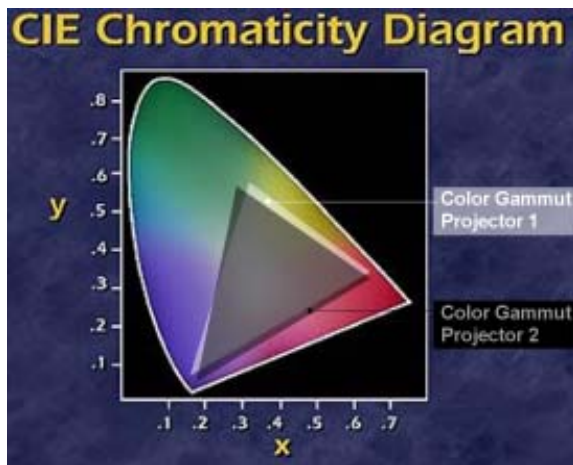

Image 7-78
The color gamut of each projector will differ

When working with a multichannel setup, these color differences between different projectors can be smoothed out by matching the color gamuts of the different projectors to a Common Color Gamut.

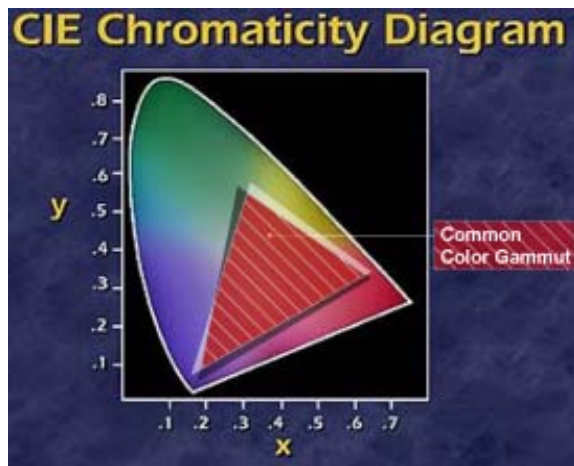

Image 7-79
Common Color Gamut

The Common Color Gamut

In a basic setup with 2 projectors, the perimeter of the Common Color Gamut is described by the 6 points of intersection of the 2 separate color gamuts.

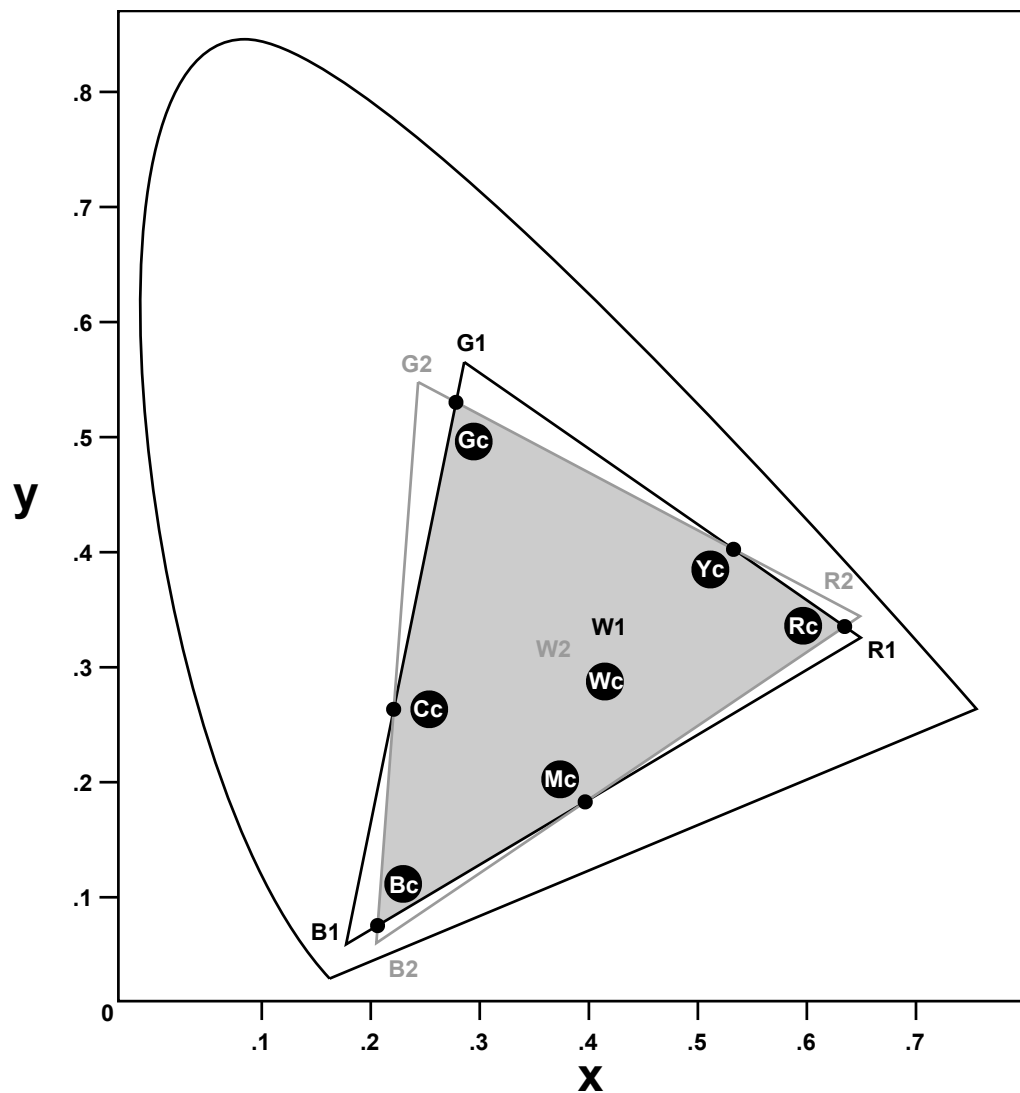

Image 7-80
The Common Color Gamut

R1 Red projector 1
R2 Red projector 2
G1 Green Projector 1

G2 Green Projector 2
B1 Blue Projector 1
B2 Blue Projector 2
W1 White Projector 1
W2 White Projector 2
Rc Red Common Color Gamut
Gc Green Common Color Gamut
Bc Blue Common Color Gamut
Cc Cyan Common Color Gamut
Mc Magenta Common Color Gamut
Yc Yellow Common Color Gamut
Wc White Common Color Gamut

The following parameters can be adjusted within DynaColor™:

- the x, y coordinates and g(Light Output) of the 6 Common Color Gamut perimeter points.
- the x, y coordinates and g(Light Output) of the White point of the Common Color Gamut.

How to Start up Dynacolor™?

1. Press the **MENU** key to activate the Menu bar.
2. Push the cursor key ← or → to highlight *Display setup* in the menu bar.
3. Push the ↓ key to pull down the *Display setup* menu.
4. Push the cursor key ↑ or ↓ to highlight *Dynacolor* and press **ENTER** to select.



Image 7-81

The Dynacolor dialog box will be displayed.

Dynacolor

MEASURED

	x	y	L
Red	0.6620	0.3230	0.0350
Green	0.3410	0.5500	0.3640
Blue	0.1440	0.1010	0.0550
White	0.2860	0.3450	0.4550

DESIRED

	x	y	g
Red	0.6620	0.3230	0.0350
Green	0.3410	0.5500	0.3640
Blue	0.1440	0.1010	0.0550
Cyan	0.2520	0.3470	0.4200
Yellow	0.3860	0.5170	0.4000
Magenta	0.2310	0.1390	0.0910
White	0.2990	0.3400	1.0000

Enabled
 Disabled

< ENTER > to edit/confirm
 or
 < EXIT > to return

Factory Preset

Image 7-82

5. Push the cursor key ← or → select enable/disable and then **ENTER**.

Dynacolor™ g (Light Output) Value

The value g in the Dynacolor™ interface represents a relative light output.

g=1 is the maximum available light output.



Assume we have a projector. L=1 in the Dynacolor™ interface will correspond with a 'maximum full white light' output of x Lumens.

The Dynacolor™ Interface

Following parameters are available in the Dyancolor™ Interface:

Measured Values	These are the colors the projector displays when no color changes are made
Red x, y	Coördinates for the Red point
Green x, y	Coördinates for the Green point
Blue x, y	Coördinates for the Blue point
White x, y	Coördinates for the White point
Red L	Red Light output
Green L	Green Light output
Blue L	Blue Light output
White L	White Light Output

Desired Values	These are the colors you want the projector to display when the status is enabled
Red x, y	Coördinates for the Red point
Green x, y	Coördinates for the Green point
Blue x, y	Coördinates for the Blue point
Cyan x, y	Coördinates for the Cyan point
Yellow x, y	Coördinates for the Yellow point
Magenta x, y	Coördinates for the Magenta point
White x, y	Coördinates for the White point
Red g	Red Light Gain
Green g	Green Light Gain
Blue g	Blue Light Gain
Cyan g	Cyan Light Gain
Yellow g	Yellow Light Gain
Magenta g	Magenta Light Gain
White g	White Light Gain

Status	Enables or disables Dynacolor™
Factory Preset	Sets the measured parameters back to the factory preset for the current set

Basic Dynacolor™ Adjustment

We assume we have a basic setup with 2 projectors, the Dynacolor™ adjustment is done by using only the Dynacolor™ menu:

1. Enable Dynacolor™ on both projectors.
2. Assume the first projector has the following measured values.

Dynacolor

MEASURED

	x	y	L
Red	0.6620	0.3230	0.0350
Green	0.3410	0.5500	0.3640
Blue	0.1440	0.1010	0.0550
White	0.2860	0.3450	0.4550

DESIRED

	x	y	g
Red	0.6620	0.3230	0.0350
Green	0.3410	0.5500	0.3640
Blue	0.1440	0.1010	0.0550
Cyan	0.2520	0.3470	0.4200
Yellow	0.3860	0.5170	0.4000
Magenta	0.2310	0.1390	0.0910
White	0.2990	0.3400	1.0000

Enabled Disabled

< ENTER > to edit/confirm
or
< EXIT > to return

Factory Preset

Image 7-83

3. Assume the second projector has the following measured values.

Dynacolor

MEASURED

	x	y	L
Red	0.6580	0.3050	0.0420
Green	0.3270	0.5460	0.3370
Blue	0.1390	0.1000	0.0450
White	0.2900	0.3530	0.4230

DESIRED

	x	y	g
Red	0.6580	0.3300	0.0420
Green	0.3270	0.5460	0.3360
Blue	0.1390	0.1000	0.0460
Cyan	0.2460	0.3560	0.3810
Yellow	0.3810	0.5050	0.3770
Magenta	0.2510	0.1480	0.0860
White	0.3040	0.3510	1.0000

Enabled Disabled

< ENTER > to edit/confirm
 or
 < EXIT > to return

Factory Preset

Image 7-84

4. We start by setting both projectors to the common red coordinate.

Tip: Draw a quick sketch of both gamuts as a graphical help.

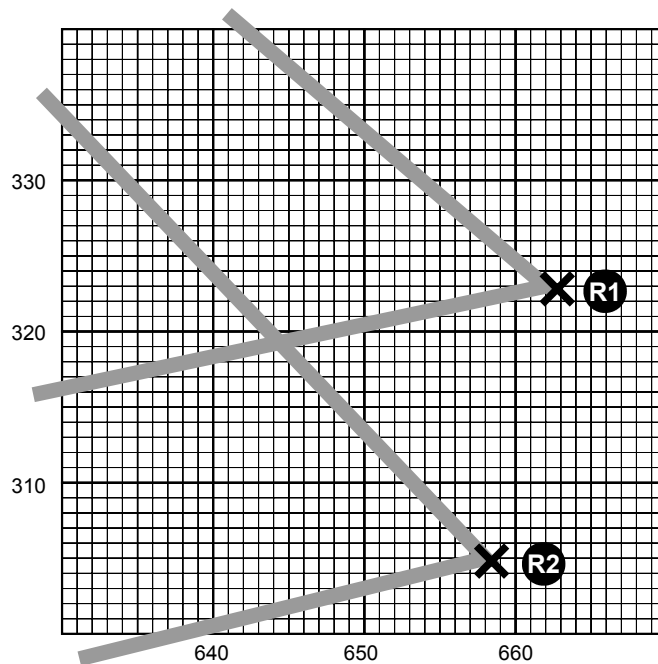

Image 7-85
Red coordinates for both projectors

5. Display the internal color bar pattern on both projectors.
6. In the desired values, adjust the red coordinate to a common value for both projectors.

Tip: The color bar of the adjusted coordinate will no longer be displayed in case the coordinate is not present within the gamut of the adjusted projector e.g. with the desired values for red set to $x=660$ and $y=318$.

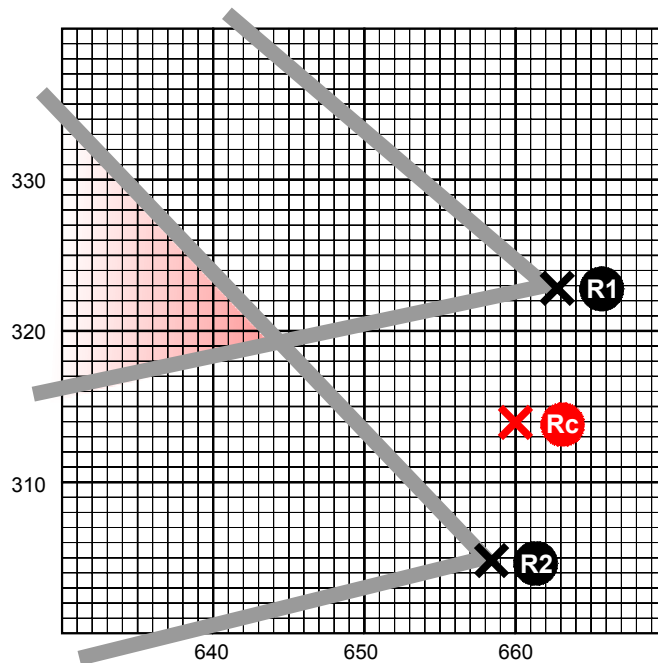

Image 7-86
Coordinate is not present within the gamut of the adjusted projector

Select a coordinate that is present in the common gamut e.g. with the desired values for red set to x=633 and y= 328.

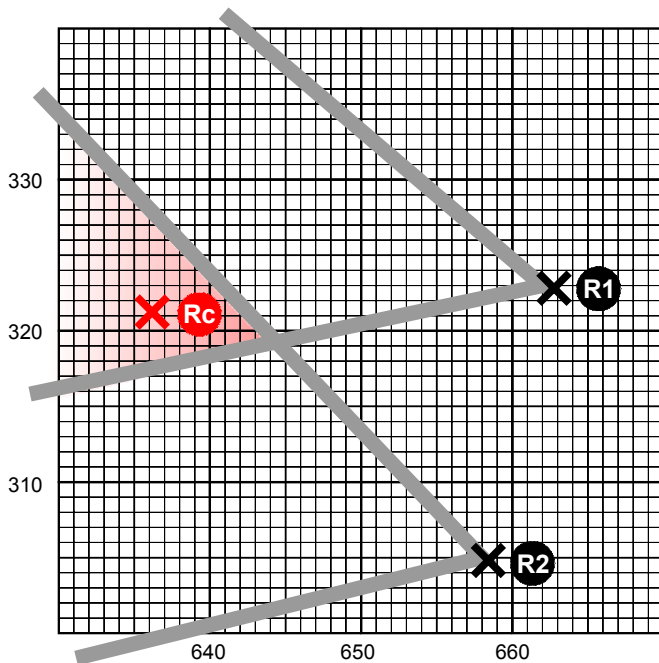

Image 7-87
Select a coordinate that is present in the common gamut

- Repeat step 5 to 6 for all coordinates on both projectors.
Both projectors will now operate within the same color gamut.



Another way to determine the new coordinates is to use the DynacolorTool (software tool running on a laptop or PC), contact Barco for more information.

7.8.2 Brilliant Color™ mode

What can be done ?

Brilliant Color™ (Texas Instruments™ technology) allows to use secondary colors in the process of the image (cyan, magenta, and yellow), resulting in an increase of the color gamut and the overall brightness.

How to activate the Brilliant color mode ?

- Press the **MENU** key to activate the Menu bar.
- Push the cursor key ← or → to highlight *Display setup* in the menu bar.
- Push the ↓ key to pull down the *Display setup* menu.
- Push the cursor key ↑ or ↓ to highlight *Brilliant Color mode* and press **ENTER** to select.

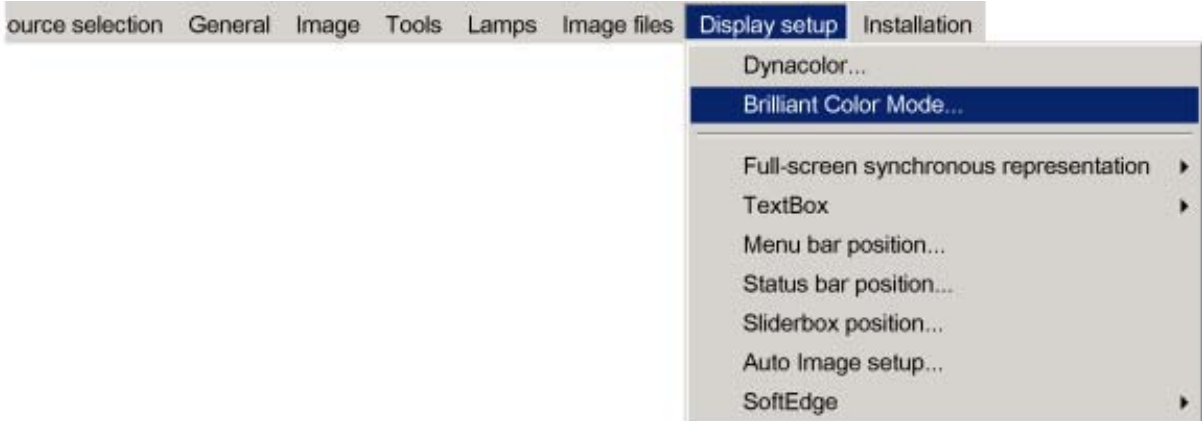

Image 7-88

A slider box is displayed.

- Put the slider box on '0' (Brilliant color disabled) or on '1' (Brilliant color enabled)

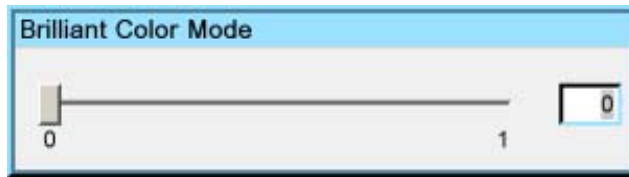

Image 7-89

7.8.3 Full screen synchronous representation

What can be done ?

In the full screen mode, the projector will always try to lock on the input source. Some monitors (connected on the DVI output of the projector) may fail to synchronize on this type of signal (number of total lines may vary in such a signal).

The *Full-screen synchronous representation* function in the *Display setup* menu allows to disable this mode.



Note that disabling the synchronous mode may introduce some image artefacts in the displayed DVI output signal (on the monitor)

How to enable/disable the full-screen synchronous representation ?

- Press **MENU** to activate the Tool bar
- Press → to select the *Display setup* item
- Press ↓ to Pull down the *Display setup* menu
- Use ↑ or ↓ to select *Full-screen synchronous representation*
- Press → to open the menu
- Use ↑ or ↓ to select ON(enable)/OFF(disable)
- Press **ENTER**

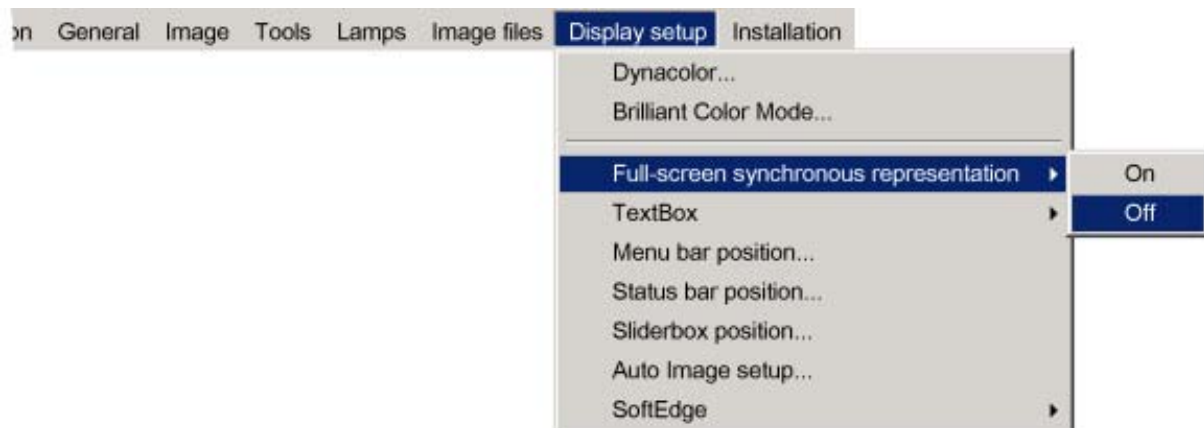

Image 7-90

7.8.4 Text box

What can be done ?

The Text box function allows to display or not the different text boxes used for instance for picture settings (contrast,...), it also affects the source information windows (displayed in the right lower corner of the screen).

How to enable/disable the Text box ?

- Press **MENU** to activate the Tool bar
- Press → to select the *Display setup* item
- Press ↓ to Pull down the *Display setup* menu
- Use ↑ or ↓ to select *Text box*

7. Advanced

5. Press → to pull down the menu
6. Use ↓ or ↑ to enable/disable the text box

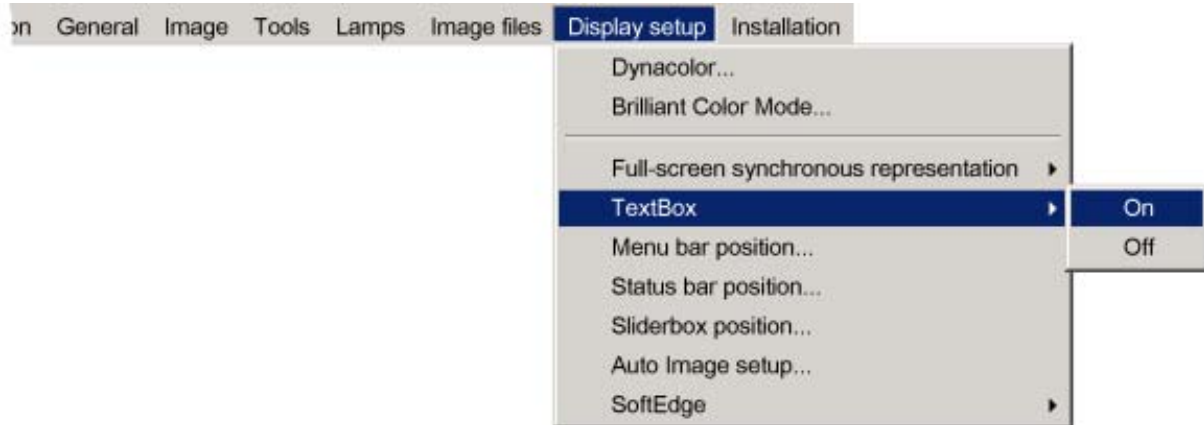

Image 7-91

7. Press **ENTER**

7.8.5 Menu bar position

What can be done ?

The menu tool bar can be centered vertically, the range being from top of the screen to the middle of the screen. This can be useful in applications where the top image content is not displayed.

How to center the menu ?

1. Press **MENU** to activate the Tool bar
2. Press → to select the *Display setup* item
3. Press ↓ to Pull down the *Display setup* menu
4. Use ↑ or ↓ to select *Menu bar position menu*
5. Press **ENTER**

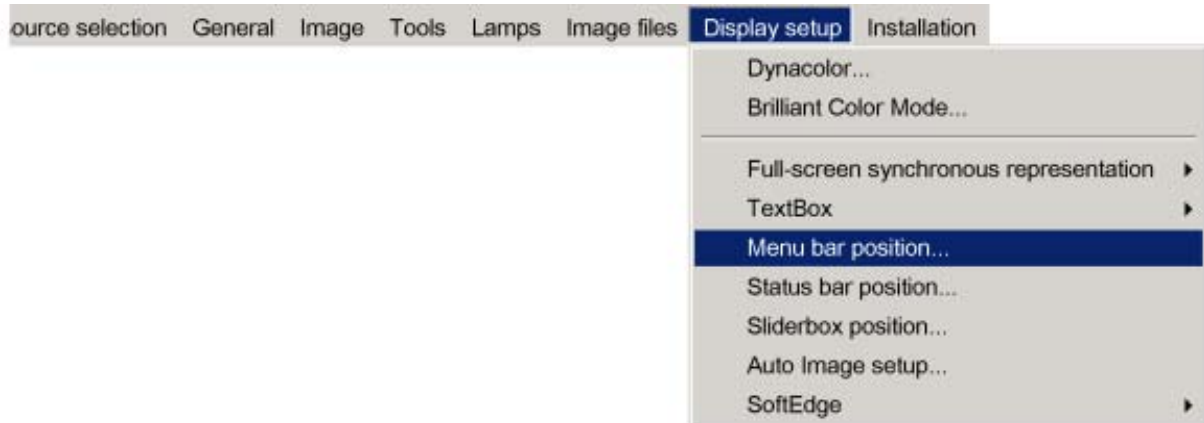

Image 7-92

6. Use ↑ or ↓ to position the Menu bar

7.8.6 Status bar position

What can be done ?

The status bar (wizard menu) can be centered vertically, the range being from bottom of the screen to the middle of the screen. This can be useful in applications where the bottom image content is not displayed.

How to center the menu ?

1. Press **MENU** to activate the Tool bar
2. Press → to select the *Display setup* item

3. Press ↓ to Pull down the *Display setup* menu
4. Use ↑ or ↓ to select *Status bar position*

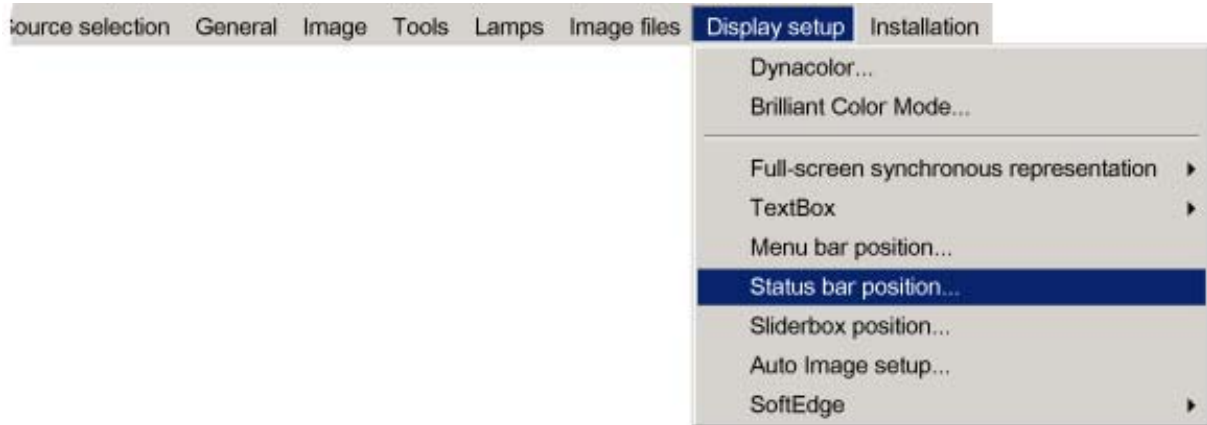

Image 7-93

5. Press **ENTER**
6. Use ↑ or ↓ to position the status bar

7.8.7 Sliderbox position

What can be done ?

The slider box can be displayed anywhere on the screen, the position can be set in this menu.

How to reposition the slider box?

1. Press **MENU** to activate the Tool bar
2. Press → to select the *Display setup* item
3. Press ↓ to Pull down the *Display setup* menu
4. Use ↑ or ↓ to select *Slider box position*

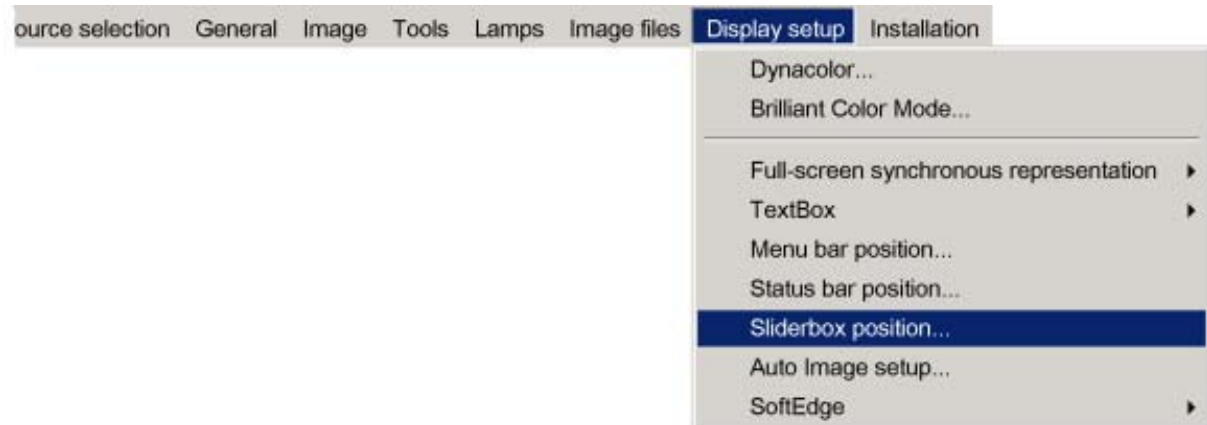

Image 7-94

5. Press **ENTER**

A slider box is displayed. Use the 4 arrow keys to drag the box to the desired position.



There is a coarse and a fine adjustment of the position, use ENTER (when slider box is displayed) to switch between the two.

7.8.8 Softedge

Overview

- Softedge Border
- Black level

7.8.8.1 Softedge Border

What can be done?

Before creating a softedge, an overlap zone had to be defined. The width of this overlap zone is fully adjustable.

The width can be adjusted for the top, bottom, left and right side of the image. The adjustment range for each border is half of the full native size i.e 960 for the left and right side and 540 for the top and bottom.

Softedge Width setting

1. Press **MENU** to activate the Tool bar
2. Press **→** to select the *Display setup* item
3. Press **↓** to Pull down the *Display setup* menu
4. Use **↑** or **↓** to select *Softedge*
5. Press **→** to open the menu
6. Use **↑** or **↓** to select *Border*

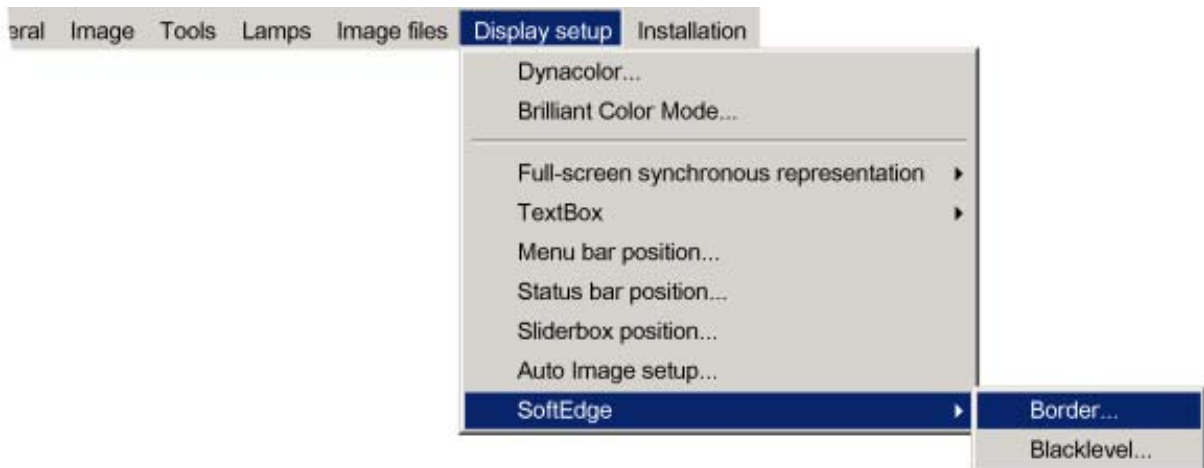

Image 7-95

7. Press **ENTER**

A dialog box is displayed.

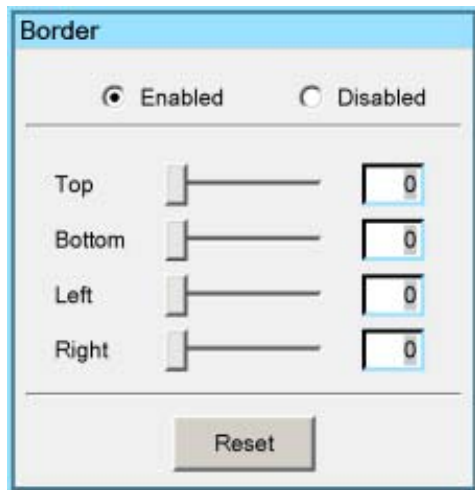

Image 7-96

8. Push the cursor key **←** or **→** to select *Enabled* or *Disabled* to enable or disable the Softedge, press **ENTER** to select.

9. Use ↑ or ↓ to select *Top*, *Bottom*, *Left* or *Right* and use ← or → to adjust the width (or use the text field with ↑ or ↓)

10. Press **BACK**

A message box is displayed, press **ENTER** to save or **BACK** to cancel

7.8.8.2 Black level

What can be done?

The black level of the image outside the overlap can be adjusted to get rid of the “double-brightness” zones and thus obtain a uniform total image. This can be done for each color (Red, green, Blue) separately or for the 3 colors together.

How to adjust the black level ?

1. Press **MENU** to activate the Tool bar
2. Press → to select the *Display setup* item
3. Press ↓ to Pull down the *Display setup* menu
4. Use ↑ or ↓ to select *Softedge*
5. Press → to open the menu
6. Use ↑ or ↓ to select *Black level*

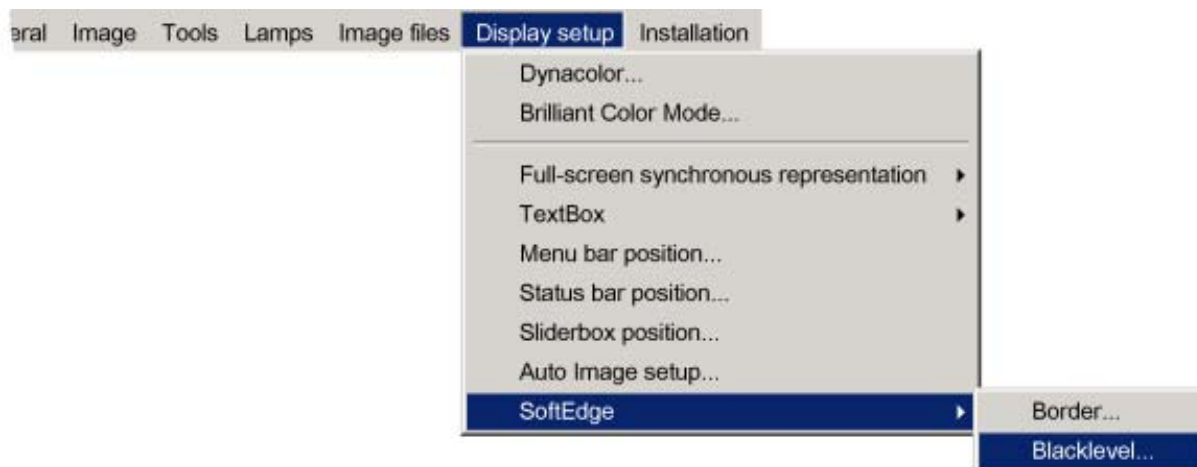

Image 7-97

7. Press **ENTER**

A dialog box is displayed.

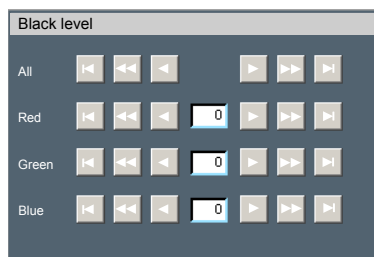

Image 7-98

8. Push the cursor key ← or →, ↑ or ↓ to select the desired button and adjust the value

9. Press **BACK**

A message box is displayed, press **ENTER** to save or **BACK** to cancel

8. MAINTENANCE

8.1 Cleaning the lens



To minimize the possibility of damage to optical coatings, or scratches to lens surfaces, we have developed recommendations for cleaning. **FIRST**, we recommend you try to remove any material from the lens by blowing it off with clean, dry deionized air. **DO NOT** use any liquid to clean the lenses.

Necessary tools

Toraysee™ cloth (delivered together with the lens kit). Order number : R379058.

How to clean the lens ?

Proceed as follow :

1. Always wipe lenses with a CLEAN Toraysee™ cloth.
 2. Always wipe lenses in a single direction.
Warning: *Do not wipe back and forwards across the lens surface as this tends to grind dirt into the coating.*
 3. Do not leave cleaning cloth in either an open room or lab coat pocket, as doing so can contaminate the cloth.
 4. If smears occur when cleaning lenses, replace the cloth. Smears are the first indication of a dirty cloth.
-



CAUTION: Do not use fabric softener when washing the cleaning cloth or softener sheets when drying the cloth.

Do not use liquid cleaners on the cloth as doing so will contaminate the cloth.



Other lenses can also be cleaned safely with this Toraysee™ cloth.

9. IMAGE FILES

9.1 Image files

Table overview

The following standard image files are pre-programmed in the projector.

Name ¹	Resolution ²	Fvert Hz ³	FHor kHz ⁴	Fpix MHz ⁵	Ptot ⁶	Pact ⁷	Ltot ⁸	Lact ⁹
1600@48V	1600x600i	48,040	62,500	135,000	2160	1600	651	600
1600@60V	1600x900	60	56	119	2128	1600	932	900
1600@192	1600x600	96	63	135	2160	1600	651	600
1920x1440@60	1920x1440	60	90	234	2600	1920	1500	1440
CGA	640x200i	59,924	15,700	14,318	912	640	262	200
COMPUSC4	1024x480i	29,945	30,694	39,779	1296	1024	512	480
DOS3@56	640x400	56	24,800	21,030	848	640	440	400
EGA	640x350	59,702	21,851	16,257	744	640	366	350
ESVGA@75	832x624	73	47,900	53,648	1120	832	660	624
EXGA@60	1152x864	60	54,900	79,934	1456	1152	916	864
EXGA@80	1152x864	80,000	76,499	110,159	1140	1152	958	864
EXGA@85	1152x864	85,000	77,202	121,671	1576	1152	907	864
EXGA1@70	1152x864	70	63,800	94,424	1480	1152	912	864
EXGA2@70	1152x864	70	66,098	99,941	1512	1152	945	864
EXGA2@75	1152x864	75	75,199	110,092	1464	1152	1002	864
FMR	640x400i	42,323	36,440	28,570	784	640	431	400
GE@50	640x400	50	31,200	44,928	1440	1163	625	522
GE@60	1085x480	60	30,700	41,261	1344	1085	512	480
hd@1080i	1920x540	60	33,750	74,249	2200	1920	563	540
hd@24p	1920x1080	24,000	27,000	74,000	2750	1920	1125	1080
hd@24sf	1950x540	48,000	27,000	74,000	2750	1950	562	540
hd@25i	1920x540	50,000	28,125	74,000	2640	1920	562	540
hd@25p	1920x1080	25,000	28,125	74,000	2640	1920	1125	1080

1. Name: name of file, contains the settings.
2. Resolution: image resolution, when followed by ..i means interlaced.
3. Fvert Hz: vertical frame frequency of the source
4. FHor kHz: horizontal frequency of the source
5. Fpix MHz: pixel frequency
6. Ptot : total pixels on one horizontal line.
7. Pact: active pixels on one horizontal line.
8. Ltot: total lines in one field
9. Lact: active lines in one field.

9. Image files

Name ¹	Resolution ²	Fvert Hz ³	FHor kHz ⁴	Fpix MHz ⁵	Ptot ⁶	Pact ⁷	Ltot ⁸	Lact ⁹
hd@30p	1920x1080	30,000	33,750	74,000	2200	1920	1125	1080
hd@60p	1280x720	60,000	45,000	74,000	1650	1280	750	720
INTER_GR	1184x886	67,170	61,796	92,941	1504	1184	920	886
IQPC_SXGA_2	1366x1024	59	62,933	106,230	1688	1366	1067	1024
IQPC_SXGA_D	1280x1024	60	63,857	107,791	1688	1280	1063	1024
IQPC_XGA_1	1024x768	61	49,005	65,863	1344	1024	807	768
IQPC_XGA_2	1024x768	60	48,485	65,164	1344	1024	807	768
IQPC_XGA_D	1024x768	61	49,005	65,863	1344	1024	806	768
MAC_3	512x384	60,147	24,480	15,667	640	512	407	384
MAC_5	512x342	60,158	22,259	16,670	704	512	370	342
MAC_6	832x624	74,546	49,722	57,280	1152	832	667	624
MAC_7	1024x768	74,907	60,150	80,000	1330	1024	803	768
MAC_POR	640x870	74,996	68,846	57,280	932	640	918	870
MXGA@100	1152x864	100	92,997	145,820	1568	1152	930	864
NTSC	675x240	60	15,748	13,512	858	675	263	240
NTSC_LIMO_x2	834x482	60	31,496	32,252	1024	834	525	482
PAL	675x286	50	15,625	13,500	864	675	313	286
PAL_LIMO_x2	834x574	50	31,250	32,000	1024	834	626	574
PAL_LIMO_x3	834x850	50	46,296	47,407	1024	834	926	850
PAL_LIMO_x4	834x1146	50	62,500	64,000	1024	834	1250	1146
PAM500	640x400	60,000	26,400	22,810	864	640	440	400
PAM800	1120x375i	44,936	36,443	50,000	1372	1120	406	375
PC98_2	1120x375i	39,994	32,835	47,840	1457	1120	411	375
PC98_3	1120x750	60,000	50,000	78,569	1571	1120	833	750
QXGA@56	2048x1536	56	89	247	2784	2048	1586	1536
QXGA@60	2048x1536	60	95	267	2800	2048	1589	1536
S1152@66	1152x900	66,004	61,846	94,500	1528	1152	937	900
S1152@76	1152x900	76,637	71,809	108,000	1504	1152	937	900
S1600@67	1600x1280	67	89,286	200,000	2240	1600	1334	1280
SDI_625	675x278i	25,000	15,625	13,500	864	720	313	278
SDI_525	675x240i	29,970	15,734	13,500	858	720	263	240
SG@50	1600x1200	50,000	62,500	130,313	2085	1600	1250	1200

Name ¹	Resolution ²	Fvert Hz ³	FHor kHz ⁴	Fpix MHz ⁵	Ptot ⁶	Pact ⁷	Ltot ⁸	Lact ⁹
SG@60_1	1280x1024	60,000	63,900	107,352	1680	1280	1065	1024
SG@60_3	960x680	60,000	43,200	54,432	1260	960	720	680
SG@60_4	1600x1200	60,000	75,000	156,375	2085	1600	1250	1200
STOR@100	764x287	100	31,300	30,361	970	764	313	287
STOR@50	1024x512	50	31,300	40,064	1280	1024	625	512
STOR@60	1024x512	60	31,300	40,064	1280	1024	525	512
SUNews@76	1280x1024	76,107	81,130	135,000	1664	1280	1066	1024
SUP_MAC	1024x768	60,000	48,780	63,999	1312	1024	813	768
SVGA_@56V	800x600	56,250	35,156	36,000	1024	800	625	600
SVGA_@60V	800x600	60,317	37,879	40,000	1056	800	628	600
SVGA_@72_1	800x600	72,084	48,080	50,003	1040	800	666	600
SVGA_@75	800x600	75,000	46,875	75,000	1056	800	625	600
SVGA_@85	800x600	85,000	53,635	56,250	1048	800	631	600
SXGA_@72_1	1280x1024	72	76,699	128,854	1680	1280	1061	1024
SXGA_@72_2	1280x1024	72	76,970	130,080	1690	1280	1069	1024
SXGA_@75	1280x1024	75	79,974	134,997	1688	1280	1066	1024
SXGA_@76	1280x1024	76	81,103	134,955	1664	1280	1066	1024
SXGA_@85	1280x1024	85	91,149	157,506	1728	1280	1072	1024
SXGA_L	1280x1024	60	62,500	84,000	1344	1280	1041	1024
SXGA+1_60	1400x1050	60	63,980	107,997	1688	1400	1066	1050
SXGA+2_60	1400x1050	60	65	123	1880	1400	1087	1050
SXGA2@60	1280x960	60	59,999	107,998	1800	1280	1000	960
SXGA2@85	1280x960	85	85,940	148,505	1728	1280	1011	960
SXGA@50	1280x1024	50	52,351	88,368	1688	1280	1047	1024
SXGAP@70	1024x1280	70	92,902	133,779	1440	1024	1326	1280
SXGAP2@60	1024x1280	60	79,498	110,661	1392	1024	1325	1280
UXGA@60	1600x1200	60	75,002	162,004	2160	1600	1250	1200
UXGA@70	1600x1200	70	87,497	188,993	2160	1600	1250	1200
UXGA@75	1600x1200	75	93,747	202,494	2160	1600	1250	1200
UXGA@85	1600x1200	85	106,247	229,494	2160	1600	1250	1200

9. Image files

Name ¹	Resolution ²	Fvert Hz ³	FHor kHz ⁴	Fpix MHz ⁵	Ptot ⁶	Pact ⁷	Ltot ⁸	Lact ⁹
UXGAP1@59	1200x1600	59	95,804	119,946	1252	1200	1620	1600
UXGAP2@60	1200x1600	60	99,404	163,817	1648	1200	1656	1600
VGA@60	640x480	60	31,326	25,061	800	640	525	480
VGA@66	640x480	67	35,100	30,326	864	640	525	480
VGA@73	640x480	73	37,860	31,500	832	640	520	480
VGA@75	640x480	75,000	37,500	31,500	840	640	500	480
VGA1@85	640x480	85,000	43,369	36,000	832	640	509	480
VGA75ISO	640x480	75,000	39,375	31,500	800	640	525	480
VIDEO525	1302x239i	29,970	15,734	32,207	1302	1024	263	239
VIDEO625	1024x278i	25,000	15,625	31,984	1310	1024	313	278
WSXGA@60	1600x1024	60	64	137	2144	1600	1060	1024
WSXGA+@60	1680x1050	60	79	178	2272	1680	1304	1050
WUXGA@60	1920x1200	60	75	194	2592	1920	1245	1200
WUXGA_2@60	1920x1200	60	89	234	2624	1920	1490	1200
XGA@43	1024x384	87	35,500	44,872	1264	1024	409	384
XGA@60	1024x768	60,000	48,360	64,996	1344	1024	806	768
XGA@70_1	1024x768	70,000	56,475	74,999	1328	1024	806	768
XGA@70_2	1024x768	70,000	57,052	78,047	1368	1024	815	768
XGA@72	1024x768	71,955	58,140	80,000	1376	1024	808	768
XGA@75_1	1024x768	75	60,024	78,752	1312	1024	800	768
XGA@85	1024x768	85,000	68,680	94,500	1376	1024	808	768
XGA@87	1024x768	43	36	45	1264	1024	817	768
XGA@75_GS	1024x768	74,534	59,701	79,284	1328	1024	801	768

Table 9-1

10. TROUBLESHOOTING

10.1 Using the OSD

What can be done ?

The projector bus allows the diagnostic of different hardware components divided in two main groups.

- I²C diagnostics : a number of internal electronic boards can be diagnosed and a graphical interface shows whether there is an error
- Lamps and power supply : lamp temperature and power related failures are logged and can be checked at any time.

How to display the I²C diagnostics menu ?

1. Press **MENU** to activate the Tool bar
2. Press → to select the *Tools* item
3. Press ↓ to Pull down the *Tools* menu
4. Use ↑ or ↓ to select *Diagnostics*
5. Press → to pull down the menu
6. Press **ENTER** to select I²C



Image 10-1

A textbox is displayed

How to display the Lamps and power supply menu ?

1. Press **MENU** to activate the Tool bar
2. Press → to select the *Tools* item
3. Press ↓ to Pull down the *Tools* menu
4. Use ↑ or ↓ to select *Diagnostics*
5. Press → to pull down the menu
6. Press **ENTER** to select *Lamps and power supply*



Image 10-2

A textbox is displayed

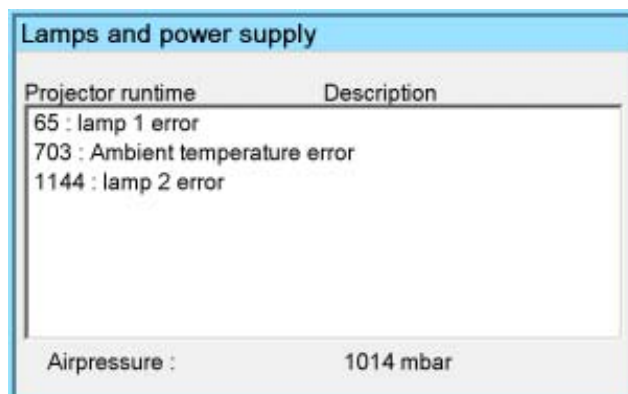

Image 10-3



Only when applicable : the air pressure value shown is the actually set environmental air pressure (note that in case of extreme air pressures, this can be set via RS232, the default/factory value set being 1014 mbar)



For Barco certified service technicians only: For more information on possible hardware failures refer to the Service Manual.

INDEX

A

address 29
 RCU 29
 Address 30
 Projector address 30
 Advanced 41
 AGC 61
 Auto Image 71
 automatic startup 36

B

Black level 91
 brightness 49
 brilliant color 86

C

Cleaning 93
 Lens 93
 color 50
 Communication 22
 Connections 22
 Ethernet 22
 Communication connections 21
 configuration 10
 connection 17–18, 20
 Component video 18
 computer 20
 RGB 17
 S-Video 17
 connections 15
 input 15
 signal 15
 Connections 15
 contrast 49

D

Digital 19
 DVI 19
 display 87
 synchronous 87
 Display setup 77
 Dyancolor™ 81–82
 Interface 82
 L (Light Output) 81
 Dynacolor™ 77, 80, 82
 Basic 82
 Adjustment 82
 Start up 80

E

Ethernet 22, 34
 Connections 22
 settings 34

F

File 72, 74–76
 copy 75
 delete 76
 edit 72
 rename 74
 save 74
 files 95
 freeze 47

G

gain control 62
 manual 62
 gamma 51
 General 46
 getting started 39
 adjust 39
 source selection 39
 Getting started 39

I

Identification 47
 image 49, 52, 56
 Color temperature 56
 noise reduction 52
 settings 49
 Image 48, 77
 Dynacolor™ 77
 image files 68
 introduction 68
 Image files 95
 Input 19
 Input source connection 19
 DVI 19
 input balance 58
 installation 8, 11, 15, 17, 29, 31
 address 29
 connection 15, 17
 composite video 17
 power 15
 lens adjustments 31
 positioning 11
 RCU 8
 setup 31
 orientation 31
 Installation 5, 7
 guidelines 5
 Installation guidelines 5
 guidelines 5
 Safety 5
 safety warnings 5

L

lamp 62–63, 65–67
 error 66
 clear 66
 history 65
 mode 63
 reset runtime 65
 runtime 67
 warning 67
 runtimes 62
 lens 9
 range 9
 Lens 9–10, 93
 Cleaning 93
 Formulas 10
 removing 9
 Lenses 8
 installation 8
 Load file 69–70
 Local keypad 25

M

Maintenance 93
 menu 41
 Menu 30, 42, 53, 57, 72, 74–76, 87
 Image files menu 72, 74–76

- copy file 75
- custom file 74
- delete file 76
- edit file 72
- rename file 74
- Image menu 53, 57
 - aspect ratio 53
 - film mode detection 57
- Installation 30
 - projector address 30
- Installation menu 87
 - text box 87
- Using the dialog boxes 42
- menu bar 88
- Menu structure 42
 - Using the dialog boxes 42

O

- OSD 41
- output 20
 - DVI 20

P

- Packaging 3
- pause 46
- phase 51
- Preferences 35
- Projector 28
 - Switch on 28

R

- RCU 25, 27
 - Terminology 27
 - Overview 27
- Removing 9
 - lens 9
- representation 87
 - synchronous 87
- RS232 22

- Connections 22
- RS422 22
 - Connections 22

S

- S-Video 44
- Selecting a source 39
- serial comms 33
 - baudrate 33
- setup 33, 35–36
 - automatic startup 36
 - baudrate 33
 - language 35
- Setup 25
- sharpness 50
- sliderbox 89
- Softedge 90
 - border 90
- Source 43
 - selection 43
- source selection 43–45
 - composite video 43
 - PC 45
 - RGB-YUV 44
- Source selection 45
 - DVI 45
- Source Selection 43
- Start up 39
- status bar 88

T

- Text box 87
- tint 50
- troubleshoot 99
 - OSD 99
- Troubleshooting 99

U

- Unpacking 3

Free Manuals Download Website

<http://myh66.com>

<http://usermanuals.us>

<http://www.somanuals.com>

<http://www.4manuals.cc>

<http://www.manual-lib.com>

<http://www.404manual.com>

<http://www.luxmanual.com>

<http://aubethermostatmanual.com>

Golf course search by state

<http://golfingnear.com>

Email search by domain

<http://emailbydomain.com>

Auto manuals search

<http://auto.somanuals.com>

TV manuals search

<http://tv.somanuals.com>