

The 4000/7000DLT  
Tabletop Series

# Installation and Operation Guide

---

---

© Copyright 1999 all rights reserved.

Quantum<sup>®</sup> is a registered trademark and DLT<sup>™</sup> is a trademark of Quantum Corporation. All other trademarks are property of their respective owners.

Document number: 62-0162-01 Rev A  
First published: March 1999

Printed in the USA

# Contents

## 1

---

### Introduction

- Overview ..... 1-3
- Intended Audience ..... 1-3
- Organization ..... 1-3
- Associated Documents ..... 1-4
- Explanation of Symbols and Notes ..... 1-4

## 2

---

### Description

- Overview ..... 2-3
- Description ..... 2-3
  - Front Panel Controls and Indicators ..... 2-5
- Other Requirements ..... 2-11
  - SCSI Host Adapter ..... 2-11
  - SCSI Interface Cable ..... 2-12
  - Application Software ..... 2-12

---

---

|                        |      |
|------------------------|------|
| Additional Items ..... | 2-12 |
|------------------------|------|

## 3

---

### Safety

|                          |     |
|--------------------------|-----|
| Safety Conventions ..... | 3-3 |
| Precautions .....        | 3-4 |

## 4

---

### Installation

|  |     |
|--|-----|
| Overview .....                                     | 4-3 |
| Unpacking and Inspecting .....                     | 4-3 |
| Installing the Host Adapter .....                  | 4-3 |
| Connecting the Interface Cable .....               | 4-3 |
| Connecting More than One 4000/7000DLT Series ..... | 4-4 |
| Setting the SCSI ID .....                          | 4-5 |
| Check the SCSI Bus Termination .....               | 4-6 |
| Connecting Power and Turning On .....              | 4-7 |
| Installing the Backup Software .....               | 4-7 |

## 5

---

### Operation and Maintenance

|                          |     |
|--------------------------|-----|
| Overview .....           | 5-3 |
| Power-on Self-Test ..... | 5-3 |
| Drive Status .....       | 5-4 |

---



---

|                                   |      |
|-----------------------------------|------|
| LED Indicators .....              | 5-4  |
| LCD Messages .....                | 5-5  |
| Drive Operating Conditions .....  | 5-6  |
| LED Indicators .....              | 5-6  |
| LCD Messages .....                | 5-8  |
| Loading the Data Cartridge .....  | 5-12 |
| Data Protection .....             | 5-13 |
| Tape in Use .....                 | 5-13 |
| Removing the Data Cartridge ..... | 5-14 |
| Cleaning the Tape Head .....      | 5-15 |
| Cleaning the Enclosure .....      | 5-18 |

## 6

---

### Troubleshooting and Diagnostic

|  |     |
|--|-----|
| Overview .....                                     | 7-3 |
| Troubleshooting Chart .....                        | 7-3 |
| Use Cleaning Tape LED .....                        | 7-5 |
| Why the Use Cleaning Tape LED Gets Turned ON ..... | 7-6 |
| High Humidity .....                                | 7-7 |

## A

---

### Specification

|                             |     |
|-----------------------------|-----|
| General Specification ..... | A-3 |
|-----------------------------|-----|

---

---

# B

---

## Drive Configuration

|   |     |
|---|-----|
| Drive Dependent Configuration .....             | B-3 |
| SCSI Bus Parity .....                           | B-3 |
| DLT4000 Drives .....                            | B-3 |
| DLT7000 Drive .....                             | B-4 |
| SCSI Bus Termination and Terminator Power ..... | B-5 |
| DLT4000 Drives .....                            | B-5 |
| DLT7000 Drives .....                            | B-7 |

# C

---

## Regulatory Notices

|   |     |
|---|-----|
| FCC Notices (U.S. Only) .....                   | C-3 |
| Shielded Cables .....                           | C-3 |
| Product Type .....                              | C-4 |
| IC Notice (Canada Only) .....                   | C-4 |
| EN 55022 Compliance (Czech Republic Only) ..... | C-5 |
| CE Notice .....                                 | C-5 |
| VCCI Notices (Japan Only) .....                 | C-6 |

---

## Index

# Figures

|                   |  |      |
|-------------------|--|------|
| <b>Figure 2-1</b> | 7000DLT Front Panel. . . . .                           | 2-6  |
| <b>Figure 2-2</b> | 4000DLT Front Panel. . . . .                           | 2-7  |
| <b>Figure 2-3</b> | 7000DLT Series Rear Panel. . . . .                     | 2-9  |
| <b>Figure 2-4</b> | DLT Data Cartridge. . . . .                            | 2-11 |
| <b>Figure 4-1</b> | Cable Diagram for 4 4000/7000DLT Series Units. . . . . | 4-4  |
| <b>Figure 4-2</b> | SCSI ID Switch. . . . .                                | 4-5  |
| <b>Figure 5-1</b> | Loading a Data Cartridge. . . . .                      | 5-12 |
| <b>Figure B-1</b> | DLT4000 Tape Drive Connectors (Left Side). . . . .     | B-3  |
| <b>Figure B-2</b> | Disable Parity Pins on SCSI ID Connector. . . . .      | B-3  |
| <b>Figure B-3</b> | DLT7000 Tape Drive Connectors (Right Side) . . . . .   | B-4  |
| <b>Figure B-4</b> | Disable Parity Pins on DFDT Connector . . . . .        | B-4  |
| <b>Figure B-5</b> | DLT4000 Tape Drive Connectors (right side) . . . . .   | B-5  |
| <b>Figure B-6</b> | TRM PWR/TRM ENB Jumper Position. . . . .               | B-6  |
| <b>Figure B-7</b> | DLT7000 Tape Drive Connectors (right side) . . . . .   | B-7  |
| <b>Figure B-8</b> | Term Power Pins on TRM PWR Connector. . . . .          | B-7  |





# Tables

|                  |   |      |
|------------------|---|------|
| <b>Table 2-1</b> | Maximum Capacity . . . . .                    | 2-3  |
| <b>Table 2-2</b> | Transfer Rate (Compressed Mode) . . . . .     | 2-4  |
| <b>Table 2-3</b> | Drive to Model Identification . . . . .       | 2-5  |
| <b>Table 2-4</b> | Front Panel Indicators and Controls . . . . . | 2-7  |
| <b>Table 2-5</b> | Rear Panel Controls and Connectors . . . . .  | 2-9  |
| <b>Table 2-6</b> | Media Cartridge. . . . .                      | 2-10 |
| <b>Table 2-7</b> | Cartridge Requirements . . . . .              | 2-12 |
| <b>Table 3-1</b> | Hazard Alert Messages . . . . .               | 3-3  |
| <b>Table 5-1</b> | Drive States Indications . . . . .            | 5-4  |
| <b>Table 5-2</b> | Drive Status LCD Messages . . . . .           | 5-5  |
| <b>Table 5-3</b> | Operating Condition Indications . . . . .     | 5-6  |
| <b>Table 5-4</b> | Drive Operation LCD Messages . . . . .        | 5-8  |
| <b>Table 5-5</b> | Tape in Use Indications . . . . .             | 5-14 |
| <b>Table 5-6</b> | Using the Cleaning Tape . . . . .             | 5-16 |
| <b>Table 5-7</b> | Cleaning Cycle LCD Messages . . . . .         | 5-17 |
| <b>Table 6-1</b> | Problem Chart . . . . .                       | 7-3  |
| <b>Table A-1</b> | Specifications . . . . .                      | A-3  |



# 1

## Introduction

|  |     |
|--|-----|
| Overview .....                         | 1-3 |
| Intended Audience .....                | 1-3 |
| Organization .....                     | 1-3 |
| Associated Documents .....             | 1-4 |
| Explanation of Symbols and Notes ..... | 1-4 |



---

---

## Overview

This manual contains information and instructions necessary for the safe operation of the 4000/7000DLT Series. The topics discussed in this chapter are:

- Overview
- Intended Audience
- Organization
- Associated Documents
- Explanation of Symbols and Notes
- Assistance

## Intended Audience

This guide is intended for operators, trained customer specialists, and maintenance personnel of the service partner who interact with the 4000/7000DLT Series.

## Organization

This publication contains chapters detailing the operation of the 4000/7000DLT. The chapters topics include:

- |           |   |
|-----------|---|
| Chapter 1 | <i>Introduction</i> - Describes the overview, intended audience, organization, associated documents, explanation of symbols and notes, and how to obtain additional assistance. |
| Chapter 2 | <i>Description</i> - Describes general information about the 4000/7000DLT Series.   |
| Chapter 3 | <i>Safety</i> - Describes the hazard symbols, messages, safety features, and operational considerations for the safe operation of the 4000/7000DLT Series.                      |
| Chapter 4 | <i>Installation</i> - Describes the functional installation of the 4000/7000DLT Series.   |
| Chapter 5 | <i>Installation and Operation</i> - Describes the proper installation instructions and operational characteristics of the 4000/7000DLT Series.                                  |

---



---

|            |  |
|------------|--|
| Chapter 6  | <i>Troubleshooting and Diagnostic</i> - Describes the troubleshooting and diagnostic techniques for the 4000/7000DLT Series. |
| Appendix A | <i>Specifications</i> - Outlines the specifications of the 4000/7000DLT Series.  |
| Appendix B | <i>Drive Configuration</i> - Describes the specific information necessary to configure the 4000/7000DLT Series.              |
| Index      |  |

## ■ Associated Documents

None.

## ■ Explanation of Symbols and Notes

The following symbols and highlighted passages note important information. Detailed explanations of these symbols are found in *Hazard Alert Messages* on page 3-3.

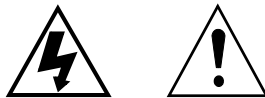

Detailed explanations for the above symbols are provided in *Hazard Alert Messages* on page 3-3.

|                |   |
|----------------|---|
| <1> + <2>      | Press these keys simultaneously.  |
| <i>Italics</i> | Headline, e. g., Chapter Name, <i>Description</i>                       |
| <b>Bold</b>    | Special Term, e. g., <b>Utilities</b> .                                 |
| Courier        | Terms appearing on the operating panel, switch position, e. g., ON, OFF |

# 2

## Description

|   |      |
|---|------|
| Overview .....                            | 2-3  |
| Description .....                         | 2-3  |
| Front Panel Controls and Indicators ..... | 2-5  |
| Other Requirements .....                  | 2-11 |
| SCSI Host Adapter .....                   | 2-11 |
| SCSI Interface Cable .....                | 2-12 |
| Application Software .....                | 2-12 |
| Additional Items .....                    | 2-12 |





---

---

## Overview

This section of the document provides a physical description of the switches, indicators and connectors on the front and rear panels of the 4000/7000DLT Series. Additional information describes other requirements (additional hardware and/or software) needed to utilize the 4000/7000DLT Series.

## Description

The 4000/7000DLT Series consists of two models, the DLT™4000 and the DLT™7000. They are all SCSI-2 compatible, high performance, streaming tape cartridge data storage devices designed for storage of near-line and off-line data. All models use data compression, compaction, and Digital Linear Tape (DLT) to obtain the capacities shown in Table 2-1. The 4000/7000DLT Series are equipped with a 2-line by 20-character backlit LCD display. The LCD displays drive status messages, error messages, and drive Power-On Self-Test (POST) results messages.

**Table 2-1** Maximum Capacity

| Model   | DLTTape III                          | DLTTape IIIXT                        | DLTTape IV                           |
|---------|--------------------------------------|--------------------------------------|--------------------------------------|
| 4000DLT | 10 GB (native)<br>20 GB (compressed) | 15 GB (native)<br>30 GB (compressed) | 20 GB (native)<br>40 GB (compressed) |
| 7000DLT | 10 GB (native)<br>20 GB (compressed) | 15 GB (native)<br>30 GB (compressed) | 35 GB (native)<br>70 GB (compressed) |

The 4000/7000DLT Series are equipped with a 5 1/4 inch form factor, half-inch tape drive. The design includes a dual-channel read/write head, Digital Lempel-Ziv (DLZ) high-efficiency data compression, and tape mark directory to maximize data throughput and minimize data access time.

Used for unattended backups or archiving, the 4000/7000DLT Series allows you to back up a higher data capacity at higher speed than either 8mm or 4mm DAT-based drives. Table 2-2 lists the maximum compressed mode transfer rates of the two models:

**Table 2-2** Transfer Rate (Compressed Mode)

| <b>Model</b> | <b>Sustained</b> | <b>Maximum<br/>(Write Operation)</b> | <b>Maximum<br/>(Read Operation)</b> |
|--------------|------------------|--------------------------------------|-------------------------------------|
| 4000DLT      | 3.0 MB/sec       | 3.0 MB/sec                           | 3.5 MB/sec                          |
| 7000DLT      | 10.0 MB/sec      | 10.0 MB/sec                          | 10.0 MB/sec                         |

The removable tape media cartridge allows long-term off-line and/or off-site data storage. The tape media is rated at up to 500,000 passes and has a shelf life of up to 30 years providing superior media durability and data reliability.

Table 2-3 on page 2-4 lists the drive models used in the 4000/7000DLT Series. Tape density is selected either from the drive front panel or the host. The 4000DLT, and 7000DLT drives can read/write 2.6, 6.0, and 10.0 GB formatted tapes for 100% interchange compatibility with earlier DLT drives.

**Table 2-3** Drive to Model Identification

| <b>Model</b> | <b>Drive Model</b> |
|--------------|--------------------|
| 4000DLT      | DLT4000            |
| 7000DLT      | DLT7000            |

The 4000/7000DLT Series includes Flash EEPROM technology that allows easy on-site installation of firmware updates from tape or from the host.

The 4000/7000DLT Series includes embedded diagnostic software that tells you when head cleaning is required, diagnostic results, and drive operating status. The drive has embedded data logging of errors for failure analysis.

## **Front Panel Controls and Indicators**

Figure 2-1 on page 2-5, and Figure 2-2 on page 2-6 show the controls and indicators located on the front panel of the 4000/7000DLT Series.

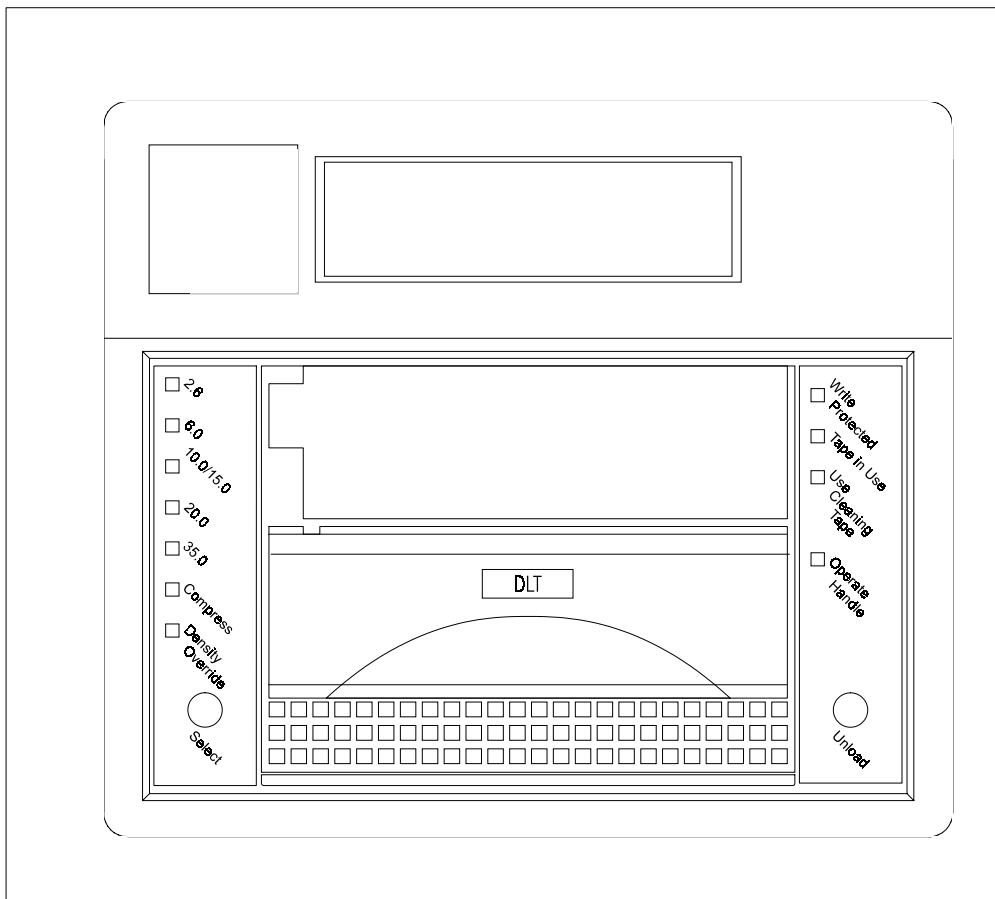

**Figure 2-1** 7000DLT Front Panel

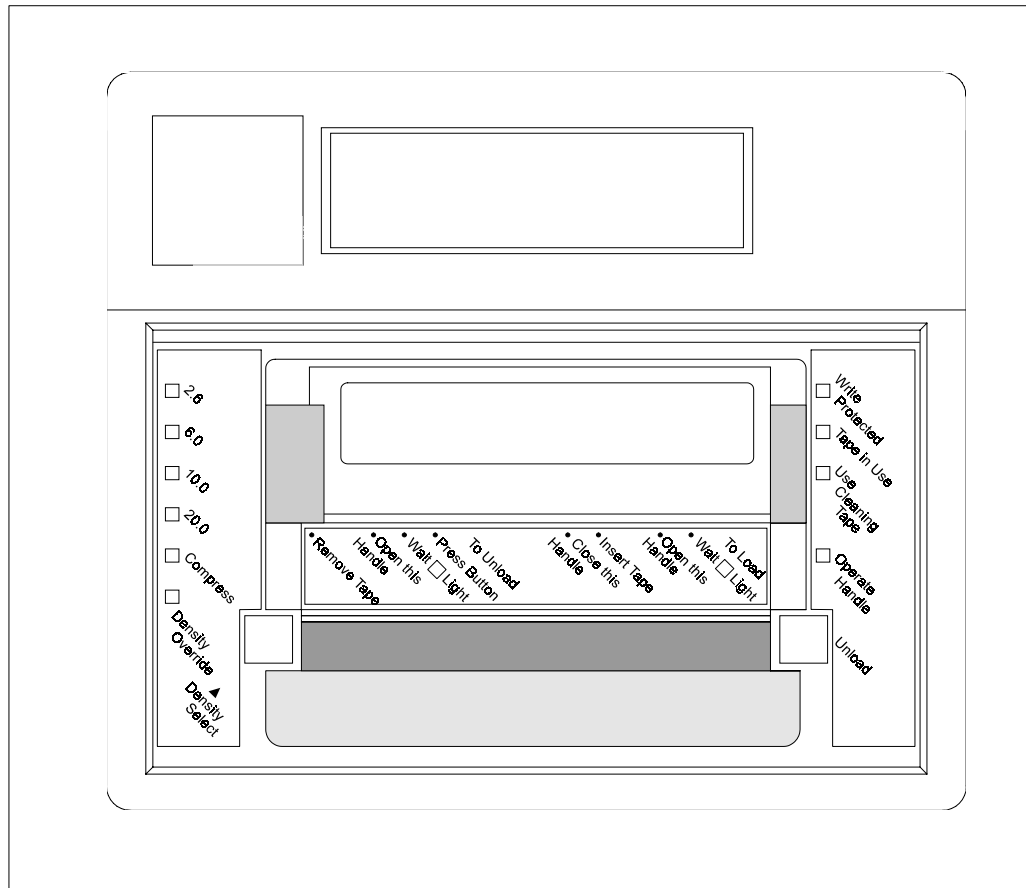

**Figure 2-2** 4000DLT Front Panel

**Table 2-4** Front Panel Indicators and Controls

|   |   |
|---|---|
| 2-line by 20-character LCD Display                    | Displays drive status, error messages, POST results   |
| Beeper  | Sounds whenever it is <b>OK</b> to operate the cartridge insert/release handle. The green Operate Handle LED should be <b>ON</b> whenever the Beeper sounds.  |
| <b>Write Protected</b><br>(orange)                    | <b>ON</b> = Tape write-protected.<br><b>OFF</b> = Tape write enabled.   |
| <b>Tape in Use</b><br>(yellow)                        | <b>Blinking</b> = Tape moving.<br><b>ON</b> = Tape loaded; ready for use.   |
| <b>Use Cleaning Tape</b><br>(yellow)                  | <b>ON</b> = Drive head needs cleaning, or the tape is bad.<br><b>OFF</b> = cleaning complete, or cleaning unnecessary.  |
| <b>Operate Handle</b><br>(green)                      | <b>ON</b> = OK to operate the cartridge insert/release handle.<br><b>OFF</b> = Do not operate the cartridge insert/release handle.  |
| <b>Density Select 2.6</b><br>(yellow)                 | <b>ON</b> = Tape is recorded in 2.6 GB format.<br><b>Blinking</b> = Tape is recorded in another density.  |
| <b>Density Select 6.0</b><br>(yellow)                 | <b>ON</b> = Tape is recorded in 6.0 GB format.<br><b>Blinking</b> = Tape is recorded in another density.  |
| <b>Density Select 10.0</b><br>(yellow)                | <b>ON</b> = Tape is recorded in 10.0 GB format.<br><b>Blinking</b> = Tape is recorded in another density.   |
| <b>Density Select 20.0</b><br>(yellow) [4000DLT only] | <b>ON</b> = Tape is recorded in 20.0 GB format.<br><b>Blinking</b> = Tape is recorded in another density.   |
| <b>Density Select 70.0</b><br>(yellow) [7000DLT only] | <b>ON</b> = Tape is recorded in 70.0 GB format.<br><b>Blinking</b> = Tape is recorded in another density.   |
| <b>Compress</b><br>(yellow)                           | <b>ON</b> = Compression mode enabled.<br><b>OFF</b> = Compression mode disabled.  |
| <b>Density Override</b><br>(yellow)                   | <b>ON</b> = Density selected from front panel.<br><b>OFF</b> (default) = Density selected from host.<br><b>Blinking</b> = In density selection mode.  |
| Unload Button   | Pressing this button initiates a manual unload of the tape. This may take from 10 seconds to 4 minutes depending on tape position.  |
| Cartridge Insert/Release Handle                       | Lift this handle (only when the <b>Operate Handle LED</b> is <b>ON</b> , and after the momentary beep sounds) to load or eject a cartridge from the drive. The handle lifts to the open position and lowers to the closed position. |

## Rear Panel Controls and Connectors

Figure 2-3 on page 2-8 shows the controls and connectors located on the rear panel of the 7000DLT Series.

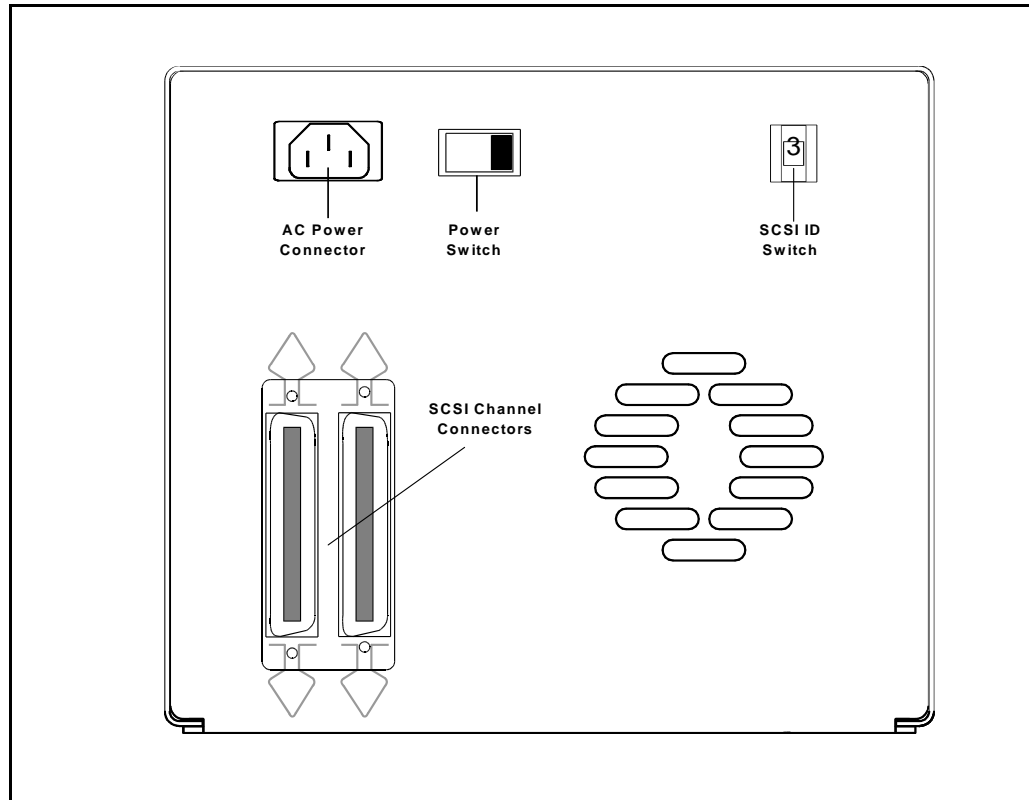

**Figure 2-3** 7000DLT Series Rear Panel

Table 2-5 describes the controls and connections.

**Table 2-5** Rear Panel Controls and Connectors

| Control or Connector    | Purpose   |
|-------------------------|---|
| Power Switch            | Turns power to the unit on and off.   |
| AC Power Connector      | Receptacle for AC power cord.   |
| SCSI Channel Connectors | Connections for the interface cable that connects the unit with the host computer and/or to other devices on the SCSI channel. The interface cable can be attached to either connector.<br>The 7000DLT, a fast, wide SCSI-2 device, uses a 68-pin high density SCSI device connector. |
| SCSI ID Switch          | Used to select the SCSI ID for the DLT drive. Factory set at 0.   |

---

---

## Data Cartridge

The data cartridges used in the DTL7000 Series are housed in 4-inch plastic cases and employ 1/2-inch metal particle tape. Table 2-6 describes and lists the media cartridges that can be used with the four models.

**Table 2-6** Media Cartridge

| Model   | Drive Model | Cartridge Model                         | Cartridge Color        | Tape Length                         |
|---------|-------------|---|------------------------|-------------------------------------|
| 4000DLT | DLT4000     | DLTape III<br>DLTape IIIXT<br>DLTape IV | gray<br>white<br>black | 1100 feet<br>1800 feet<br>1800 feet |
| 7000DLT | DLT7000     | DLTape III<br>DLTape IIIXT<br>DLTape IV | gray<br>white<br>black | 1100 feet<br>1800 feet<br>1800 feet |

The **Write-Protect** switch prevents accidental erasure of data. If the switch is moved all the way to the left, the cartridge is write-protected and the drive cannot write to, or erase data from, the cartridge. The small orange rectangle will be visible whenever the cartridge is write-protected. Additionally, an arrow (beneath the orange rectangle and above the two lines on the switch), lets you know that data cannot be written to the cartridge. If the switch is moved all the way to the right, the cartridge is write-enabled and the drive can write data to, or erase data from, the cartridge. The orange rectangle will not be visible whenever the cartridge is write-enabled. On the right side of the write-protect switch an arrow over one line indicates that if you slide the switch to the right, data can be written to the cartridge. Refer to Figure 2-4 on page 2-10.

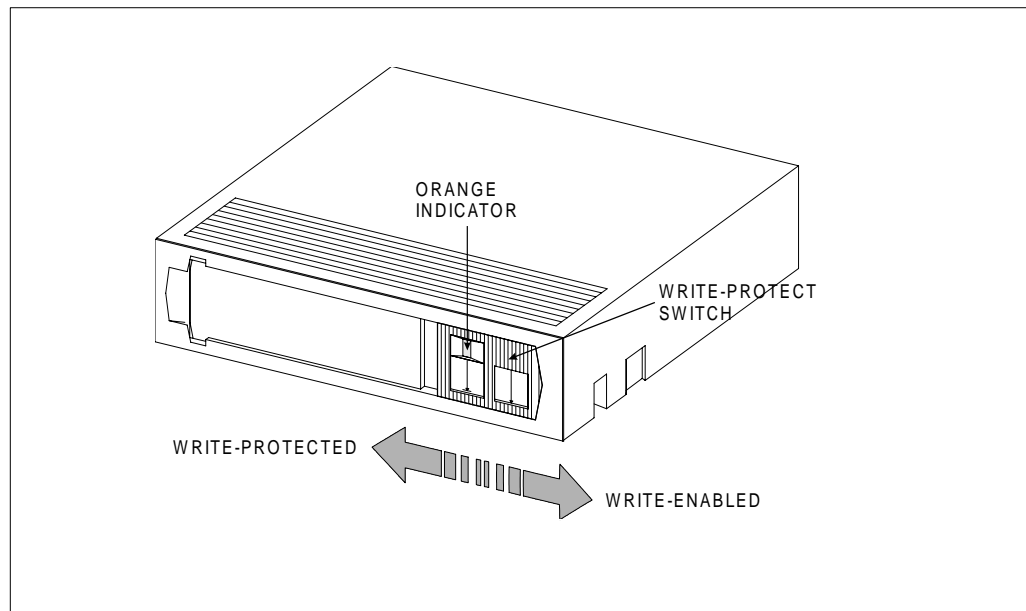

Figure 2-4 DLT Data Cartridge

**Caution**

Always remove any cartridge from the drive before turning off host system power. Failure to remove a cartridge can result in cartridge and drive damage.

When you remove the cartridge from the drive, return the cartridge to its plastic case to prolong the cartridge life.

## Other Requirements

### SCSI Host Adapter

If your host system does not have an integrated SCSI controller, a SCSI host adapter must be used to connect the host computer with the 7000DLT Series. The host adapter you choose will depend on your system requirements and your needs.



---

---

## ■ ■ ■ SCSI Interface Cable

The kind of cable you need will depend on the kind of SCSI bus connector on your host adapter. The 7000DLT, a fast, wide SCSI-2 device, uses a 68-pin high density SCSI device connector.

## ■ ■ ■ Application Software

The software you use will depend upon your storage needs and the system you are using.

## ■ ■ ■ Additional Items

- At least one data cartridge. See Table 2-7.

**Table 2-7** Cartridge Requirements

| <b>Model</b> | <b>Required Cartridge</b> |
|--------------|---------------------------|
| 4000DLT      | DLTTape IV                |
| 7000DLT      | DLTTape IV                |

- A SCSI bus active terminator.



# 3

## Safety





|                          |     |
|--------------------------|-----|
| Safety Conventions ..... | 3-3 |
| Precautions .....        | 3-4 |



# Safety Conventions

The following symbols are used throughout the document.

**Table 3-1** Hazard Alert Messages

| Symbol  | Damage to ... | Signal Word | Definition                              | Consequence                                   |
|---|---------------|-------------|---|---|
|    | Persons       |             | Imminent hazardous electrical situation | Death or serious injury                       |
|    | Material      | Caution     | Potential damaging situation            | Possibly damage to the product or environment |
|   |               | Note        | Tips for operators                      | No hazardous or damaging consequences         |
|  |               |             | Important or useful information         | No hazardous or damaging consequences         |



The danger exists of a fatal electric shock. At places designated with this symbol, electrical current can be present even after switching off the main switch. Before starting any work, always confirm that all electrical connections are free of electrical current.



This symbol means that specific regulations, rules, notices, and working procedures must be observed. Ignoring this symbol can lead to equipment damage or destruction or to other property damage.



This symbol draws attention to user tips. No dangerous or damaging consequences for personnel or property are associated with this symbol.



This symbol indicates useful information. No dangerous or damaging consequences for personnel or property are associated with this symbol.

---

---

**All safety and operating instructions should be read before this product is operated, and should be retained for future reference. This unit has been engineered and manufactured to assure your personal safety. Improper use can result in potential electrical shock or fire hazards. In order not to defeat the safeguards, observe the following basic rules for its installation, use and servicing.**

- Heed Warnings - All warnings on the product and in the operating instructions should be adhered to.
- Follow Instructions - All operating and use instructions should be followed.
- Power Sources - The product should be connected to a power source only of the type directed in the operating instructions or as marked on the product.
- Power Cord Protection - The AC line cord should be routed so that it is not likely to be walked on or pinched by items placed upon or against it, paying particular attention to the cord at the wall receptacle, and the point where the cord exits from the product.
- Power Switch - The power switch used in this product does not disconnect both supply conductors when placed in the **OFF** position. To completely disconnect power from this product, unplug the AC power cord from the receptacle on the back of the unit.
- Object and Liquid Entry - Care should be taken to insure that objects do not fall and liquids are not spilled into the product's enclosure through openings.
- Servicing - The user should not attempt to service the product beyond that described in the operating instructions. All other servicing should be referred to qualified service personnel.

## Precautions

Do not use oil, solvents, gasoline, paint thinner or insecticides on the unit.

Do not expose the unit to moisture, to temperatures higher than 140°F (60°C) or to extreme low temperatures.

Keep the unit away from direct sunlight, strong magnetic fields, excessive dust, humidity and electronic/electrical equipment which generates electrical noise.

Hold the AC power plug by the head when removing it from the AC source outlet; pulling the cord can damage the internal wires.

---

---

Use the unit on a firm level surface free from vibration, and do not place anything on top of unit.





# 4

## Installation

|  |     |
|--|-----|
| Overview .....                                     | 4-3 |
| Unpacking and Inspecting .....                     | 4-3 |
| Installing the Host Adapter .....                  | 4-3 |
| Connecting the Interface Cable .....               | 4-3 |
| Connecting More than One 4000/7000DLT Series ..... | 4-4 |
| Setting the SCSI ID .....                          | 4-5 |
| Check the SCSI Bus Termination .....               | 4-6 |
| Connecting Power and Turning On .....              | 4-7 |
| Installing the Backup Software .....               | 4-7 |



---

---

## Overview

This chapter explains the steps necessary to install and test your 4000/7000DLT Series. It also provides an information symbol for each event that you should verify as correct before continuing.

## Unpacking and Inspecting

Unpack all items from the carton.



**None of the components should have any damage.**

**Save the packing materials in case you need to move or ship the system in the future. You must ship the unit in the original or equivalent packing materials or your warranty may be invalidated.**

## Installing the Host Adapter

If your host computer does not have native SCSI capability and the host adapter you are using is not installed, please install it. Refer to the manual that came with your host adapter for specific directions.

## Connecting the Interface Cable



### Note

The bail (or other) locks at the ends of the SCSI cable must be securely fastened to insure communications between the 4000/7000DLT Series and the host computer.

Attach an interface cable between the host adapter and your 4000/7000DLT Series. The kind of cable you need depends on the kind of SCSI bus connector on your host adapter. The 4000/7000DLT Series has two SCSI device connectors on the rear panel. It does not matter which connector you use.



**Make sure that the SCSI cable between the host adapter and the 4000/7000DLT Series is secure and the connections are fastened correctly.**

## Connecting More than One 4000/7000DLT Series

**Note**  
Don't forget to install the SCSI terminator on the last device in the chain.

If you are connecting more than one 4000/7000DLT Series unit on the same SCSI channel, simply connect each unit to the previous unit with an additional interface cable. It doesn't matter which SCSI connector on each 4000/7000DLT Series unit you connect the interface cable to. Figure 4-1 shows a sample configuration.

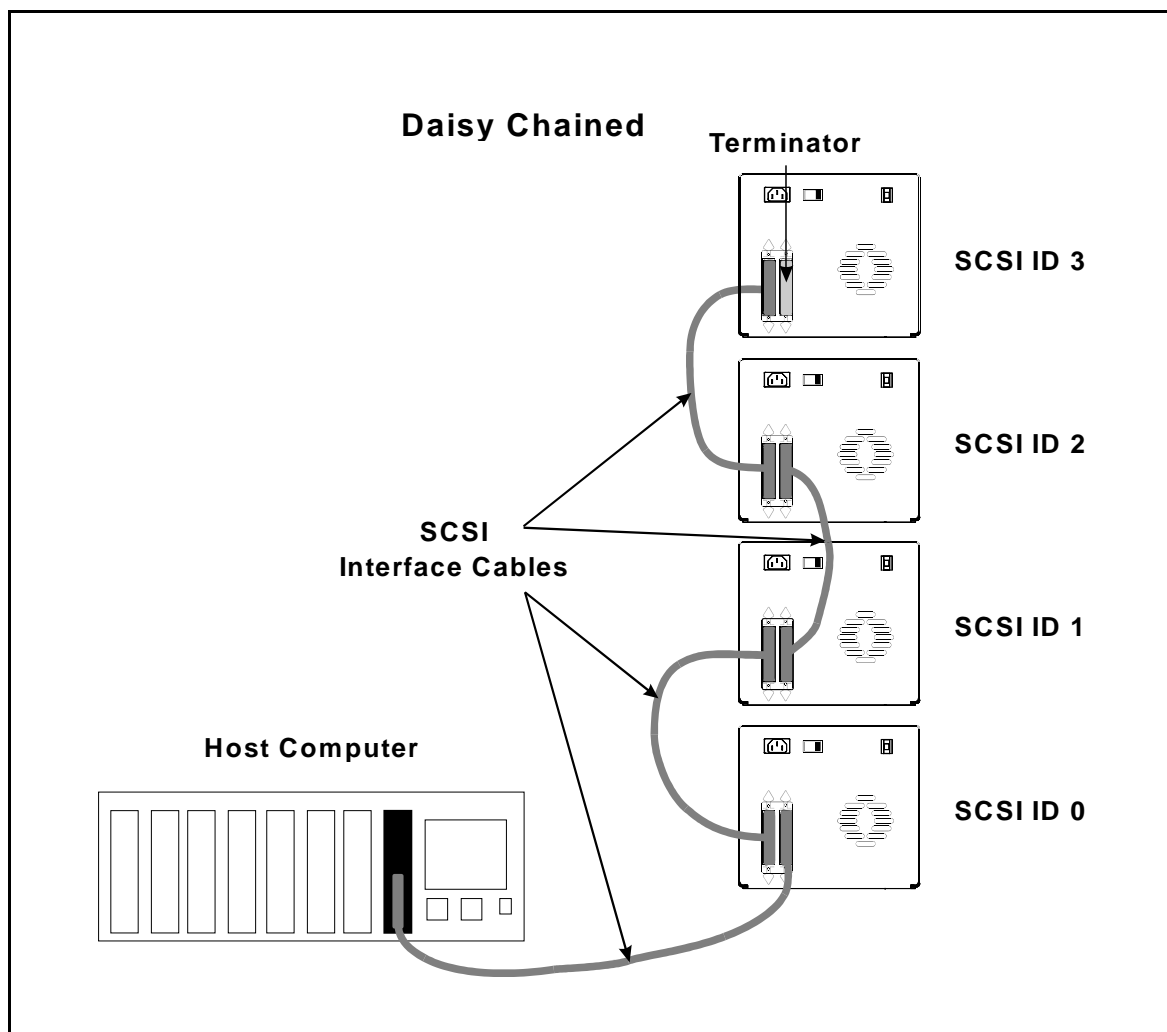

**Figure 4-1** Cable Diagram for 4 4000/7000DLT Series Units

---

---

## Setting the SCSI ID



### Note

The SCSI ID has been factory preset to 0. All devices on a SCSI bus must be set to a unique address.

Depending upon your setup, operating system and number of SCSI devices on the bus, you may have to change the SCSI address of the 4000/7000DLT Series. Each device on the bus must have its own unique address. See Figure 4-1 on page 4-4 and Figure 4-2.

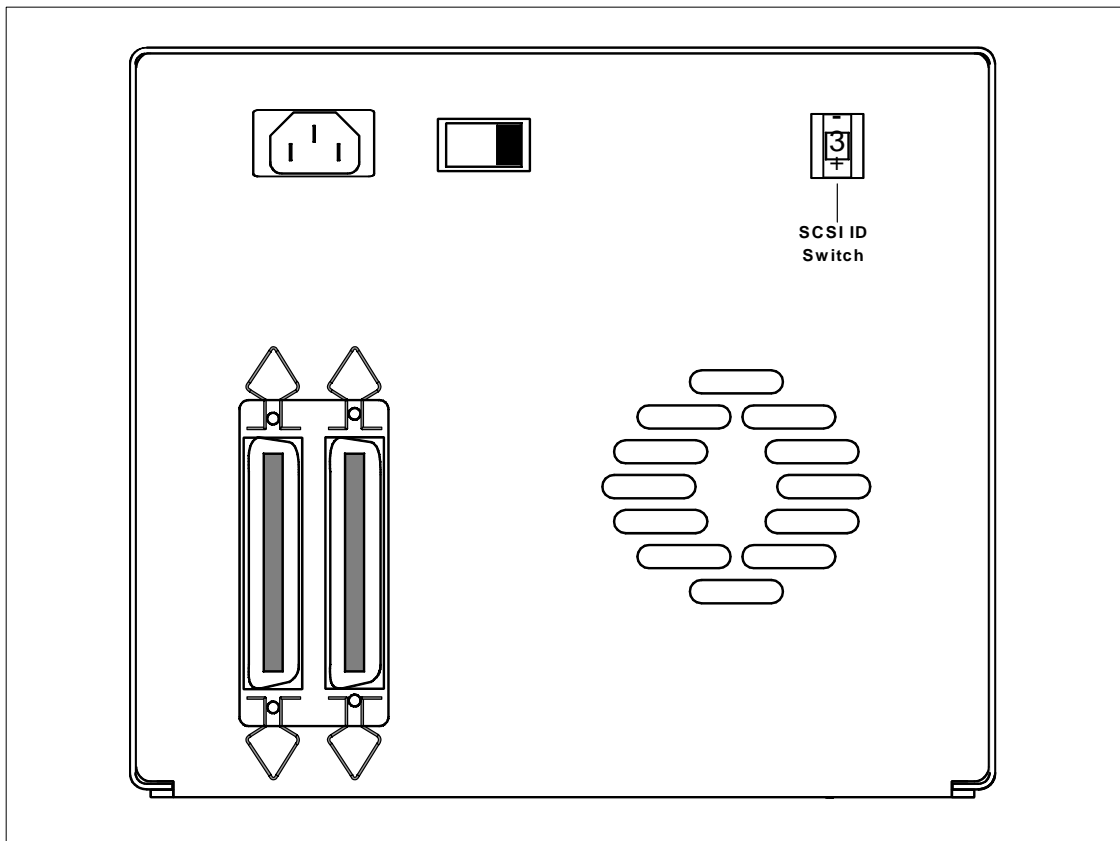

**Figure 4-2** SCSI ID Switch



### Note

All 4000/7000DLT Series models can be set to any SCSI ID between 0 and 7. The 7000DLT, a fast-wide SCSI-2 device, can be set to any SCSI ID between 0 and 15.

The SCSI ID switch is located on the rear of the 4000/7000DLT Series (see Figure 7). Use a small pointed object to press either the + button on the bottom, or the minus button on the top of the switch to select the proper ID.



Count each device's SCSI ID in sequence 0 to 7 (or 0 to 15), on each SCSI bus to confirm that no two devices have the same ID.

**Note**

The SCSI Host Adapter is normally set to SCSI ID 7, so this ID is usually not available for a device.

## Check the SCSI Bus Termination

SCSI buses require termination at each end for proper operation. A typical external subsystem installation would be terminated at the SCSI host adapter and at the last device in the chain.

If an external device is being used with an internal device (on the same channel), the SCSI host adapter would now be in the middle of the bus rather than at the end. In this case, the termination would be at the internal device and the last drive in the external chain. The terminators on the SCSI host adapter would be removed. See your SCSI host adapter manual for directions on removing the terminators on the board.



**Is there a terminator installed on each end of the SCSI bus?**

**Note**

For single-ended drives, recommends using an active single-ended SCSI terminator. For differential drives, use a passive differential terminator.

---

---

## Connecting Power and Turning On

- Step 1** Plug the power cord into the back of the 4000/7000DLT Series.
- Step 2** Plug the power cord from the 4000/7000DLT Series into a GROUNDED electrical outlet.
- Step 3** Plug the power cord from your host system into the same GROUNDED electrical circuit if possible. Computers and peripherals should always share the same grounds.
- Step 4** Turn **ON** the power to your host system.
- Step 5** Turn the 4000/7000DLT Series power **ON**.



### **Note**

Turning on the host computer first ensures that the SCSI bus terminators stabilize the bus signals before the tape drive is turned on.

---

---

## Installing the Backup Software

At this point, please refer to your backup software installation guide and install the backup software.



**After you have completed installation of your 4000/7000DLT Series and the backup software, you should run a small backup/restore and compare to confirm that your unit is working correctly. See your software installation guide for additional information.**





# 5

## Operation and Maintenance

|                                   |      |
|-----------------------------------|------|
| Overview .....                    | 5-3  |
| Power-on Self-Test .....          | 5-3  |
| Drive Status .....                | 5-4  |
| LED Indicators .....              | 5-4  |
| LCD Messages .....                | 5-5  |
| Drive Operating Conditions .....  | 5-6  |
| LED Indicators .....              | 5-6  |
| LCD Messages .....                | 5-8  |
| Loading the Data Cartridge .....  | 5-12 |
| Data Protection .....             | 5-13 |
| Tape in Use .....                 | 5-13 |
| Removing the Data Cartridge ..... | 5-14 |
| Cleaning the Tape Head .....      | 5-15 |
| Cleaning the Enclosure .....      | 5-18 |



---

---

## Overview

This section describes normal operating features of the 4000/7000DLT Series. Additionally, it explains how, and when, to clean the tape head. This section also describes how to clean the enclosure.

## Power-on Self-Test

When you turn system power **ON**, the DLT drive performs a Power-on Self-Test (POST). The sequence of events is:

- The LEDs on the right front panel of the DLT drive will turn on sequentially from top to bottom. All LEDs will remain **ON** for a few seconds.
- The LEDs on the left front panel will turn **ON** at the same time for about three seconds and then turn **OFF**.
- The **Operate Handle Write Protected** and **Use Cleaning Tape** LEDs will turn **OFF**. The **Tape in Use** LED will blink while the tape drive initializes.
- If your external SCSI bus terminator has a Term Power LED it should also be illuminated.

---

---

## Drive Status

### LED Indicators

After initialization, the drive will be in one of the four states listed in Table 5-1.



**Table 5-1** Drive States Indications

| Drive State  | LED Indicator Displays and Drive Actions   |
|--|--|
| No cartridge is present.   | The <b>Tape in Use</b> LED turns <b>OFF</b> .<br>The <b>Operate Handle</b> LED turns <b>ON</b> .<br>The handle is unlatched.<br>The drive beeps momentarily.   |
| A cartridge is present and the handle is down.                           | The drive loads the cartridge.<br>When the <b>Tape in Use</b> LED stops blinking and stays <b>ON</b> , the tape's actual density lights. For example, if the actual tape density is 2.6, then the LED turns <b>ON</b> next to the 2.6 label.<br>When the <b>Density Override</b> LED blinks, you can select a density. The drive is ready for use.                                     |
| A cartridge is present, but the handle is up ( <i>not recommended</i> ). | The <b>Tape in Use</b> LED turns <b>OFF</b> . The <b>Operate Handle</b> LED flashes.<br>When you lower the handle, the cartridge loads.  |
| The drive detects an error condition.                                    | Then all right or left side LEDs blink repeatedly. You may try to unload the tape (if present) and reinitialize the drive by pressing the <b>Unload</b> button or turn power <b>OFF</b> and then <b>ON</b> again. The right or left side LEDs stop blinking and the drive tries to reinitialize. The LEDs turn <b>ON</b> steadily again and then turn <b>OFF</b> if the test succeeds. |

## LCD Messages

Table 5-2 describes the messages displayed on the LCD during and immediately after the POST.

**Table 5-2** Drive Status LCD Messages

| Drive State   | LCD Message  |
|---|--|
| POST is executing.  | <p>Power On Self Test<br/>In Progress</p> <p>Will be displayed for 3 to 5 seconds, followed by:</p> <pre> DRV F/W XXXX LCD F/W vX.XX ID: X           </pre> <p>DRV F/W is the firmware version of the drive.<br/>LCD F/W is the firmware version of the LCD controller.<br/>ID is the SCSI ID setting of the drive.</p> <pre> CPH= XXXX TSL= XXXX DCL= XXXX           </pre> <p>CPH is the cululative power on hours of the drive.<br/>TSL us the time since last cleaning cycle of the drive (resets to zero after every cleaning cycle if powered by a power cycle).<br/>DCL is the drive data cartridge load counter.</p> |
| POST completed, no cartridge is present, and the handle is down.<br> <b>Note</b><br>This is the <i>preferred</i> state for the 4000/7000DLT when powering up.                            | <p>7000DLT<br/>or '4000DLT' (DLT4000)</p>  |
| POST completed, a cartridge is present, but the handle is up ( <i>not recommended</i> ).<br> <b>Note</b><br>The 4000/7000DLT <i>should not</i> be left in this state when powering down. | <p>Operate Door Handle</p> <p>↓       ↓       ↓       ↓</p> <p>This message will appear after approximately 5 minutes.</p>   |
| The drive detects an error condition.   | <p>ERROR!<br/>HARDWARE FAULT</p>   |

POST completes in about 13 seconds and the drive responds normally to all commands. However, it may take longer for the media to become ready.

POST completes in about 13 seconds and the drive responds normally to all ommands. However, it may take longer for the media to become ready.

## ■ ■ Drive Operating Conditions

### ■ ■ LED Indicators

Use Table 5-3 on page 5-6 to determine the drive's operating condition.

**Table 5-3** Operating Condition Indications

| Right Indicator Panel LED   |        |   |  |
|---|--------|---|--|
| Label   | Color  | State   | Operating Condition  |
| Write Protected   | Orange | ON<br>OFF   | Tape is write-protected.<br>Tape is write-enabled.   |
| Tape in Use   | Yellow | Blinking<br>ON  | Tape is moving.<br>Tape is loaded; ready for use.  |
| Use Cleaning Tape   | Yellow | ON<br>Remains on<br>after unloading<br>cleaning tape<br>After cleaning,<br>turns on again<br>when reloading<br>data cartridge | Drive head needs cleaning,<br>or the tape is bad.<br>Cleaning attempted, but tape<br>expired, so cleaning not<br>performed.<br>Problem data cartridge. Try<br>another cartridge.                                   |
| Operate Handle  | Green  | ON<br>OFF<br>Blinking   | OK to operate the Cartridge<br>Insert/Release Handle.<br>Do not operate the Cartridge<br>Insert/Release Handle.<br>Drive was powered on with<br>door open. Close door and<br>let drive complete<br>initialization. |
| All Right Indicator<br>Panel LEDs or,<br>All Left Indicator<br>Panel LEDs | -      | ON<br>Blinking  | POST is starting.<br>An error has occurred.  |

**Table 5-3** Operating Condition Indications

| <b>Left Indicator Panel LED</b>                                   |              |                                 |   |
|---|--------------|---------------------------------|---|
| <b>Label</b>  | <b>Color</b> | <b>State</b>                    | <b>Operating Condition</b>  |
| 2.6   | Yellow       | ON<br>Blinking                  | Tape is recorded in 2.6 format.<br>Tape is recorded in another density. You selected this density for a write from BOT.                 |
| 6.0   | Yellow       | ON<br>Blinking                  | Tape is recorded in 6.0 format.<br>Tape is recorded in another density. You selected this density for a write from BOT.                 |
| 10.0  | Yellow       | ON (default)<br>Blinking        | Tape is recorded in 10.0 format.<br>Tape is recorded in another density. You selected this density for a write from BOT.                |
| 20.0 (4000/7000DLT)   | Yellow       | ON (default)<br>Blinking        | Tape is recorded in 20.0 format.<br>Tape is recorded in another density. You selected this density for a write from BOT.                |
| Compress  | Yellow       | ON<br>OFF                       | Compression mode enabled.<br>(Compression can be done only in 10.0, 15.0, 20.0, and 70.0 density.)<br>Compression mode disabled.        |
| Density Override  | Yellow       | ON<br>OFF (default)<br>Blinking | You selected a density from the front panel.<br>Density will be selected by the host (automatic).<br>You are in density selection mode. |
| All Right Indicator Panel LEDs, or, all Left Indicator Panel LEDs | -            | Blinking                        | A POST error has occurred.  |

## LCD Messages

Table 5-4 on page 5-8 describes the messages displayed by the LCD during normal operation:

**Table 5-4** Drive Operation LCD Messages

| Drive Operating Condition         | LCD Message   |
|-----------------------------------|---|
| No tape in drive.                 | <p style="text-align: center;">7000DLT<br/>or, '4000DLT' (DLT4000)</p>  |
| When loading or unloading a tape. | <p style="text-align: center;">DLTtype<br/>Loading &gt;&gt;&gt;</p> <p>DLTtype = DLT4000 (4000DLT), or DLT7000 (7000DLT).</p> <p>During the loading process the display may toggle between "Loading &gt;&gt;&gt;" and "Calibrating&gt;&gt;&gt;".</p> <p style="text-align: center;">DLTtype<br/>Calibrating &gt;&gt;&gt;</p> <p> <b>Note</b><br/>While loading the tape, the drive will enter a false Ready Mode condition for a short period. During this false state the Tape In Use LED will continue to blink. Do not attempt any operations while the LED is blinking.</p> <p style="text-align: center;">Write Protected<br/>Tape Inside Drive</p> |
| When tape is unloaded.            | <p style="text-align: center;">Operate Door Handle<br/>↓       ↓       ↓       ↓</p>  |



**Table 5-4** Drive Operation LCD Messages

|  |   |
|--|---|
| <p>When tape is loaded.</p>                | <pre>DLTtype   Compressed Ready Mode 15/30GB</pre> <p>DLTtype = DLT™4000 (4000DLT), or DLT™7000 (7000DLT).<br/>         Compressed if compression mode enabled or Standard if compression mode disabled.<br/>         20/40GB = DLT™4000, 35/70GB = DLT™7000.<br/>         This is the normal "Ready Screen".</p> |
| <p>If write-protected tape is inserted</p> | <p>During loading of a write-protected tape, the display will change from:<br/>         "Loading&gt;&gt;&gt;" to "Write Protected Tape Inside Drive", the LCD backlight will toggle on/off and an audible alarm will sound.</p>   |
| <p>Write-protected tape fully loaded.</p>  | <pre>DLTtype   Compressed Ready Mode      WPT</pre> <p>WPT = Write Protected Tape in unit.<br/>         WPT will toggle to GB and back to WPT and continue toggling until next drive action.</p> <pre>DLTtype   Compressed Ready Mode 15/30GB</pre>   |

**Table 5-4** Drive Operation LCD Messages

|   |   |
|---|---|
| <p>Whenever the system is writing to a tape, these two messages will alternate. Each message will be displayed for approximately 2.5 seconds.</p> | <pre>DLTtype    2.1:1 Writing &gt;&gt;&gt;</pre> <pre>DLTtype    Compressed Ready Mode  15/30GB</pre> <p>DLTtype = DLT™4000 (4000DLT), or DLT™7000 (7000DLT).<br/>Compressed if compression mode enabled, standard if compression mode disabled.<br/>Writing – indicates the system is writing to the tape.<br/>2.1:1 – indicates the current compression ratio being used.<br/>16GB – indicates the amount of tape still available to be written to.<br/>3 arrows in motion ( &gt;&gt;&gt; ) – indicate tape travel.</p> |
| <p>Whenever the system is reading a tape, this message will alternate with the ready screen.</p> <p>Whenever a tape is in motion.</p>             | <pre>DLTtype    Compressed Reading &gt;&gt;&gt;</pre> <p>Reading – indicates the system is reading from the tape.</p> <pre>DLTtype    Compressed Motion Message &gt;&gt;&gt;</pre> <p>Motion Messages = Loading, Unloading, Reading, Writing, Positioning, Erasing, Cleaning and Rewinding.<br/>3 arrows ( &gt;&gt;&gt; ) – indicate tape travel.</p>   |
| <p>Whenever an incorrect cartridge type is placed into a drive.</p>   | <pre>Format Not Valid For This Drive - Unload</pre> <p>The LCD will flash and the beeper will sound while this message is displayed.<br/>Press the Unload button, the drive will begin unloading the tape and the LCD will return to normal operation messages.</p>   |

**Table 5-4** Drive Operation LCD Messages

|  |  |
|--|--|
| <p>The drive head needs cleaning or the tape is bad.</p>     | <p>ATTENTION!<br/>High Data Error Rate<br/>followed by:<br/>Clean Heads or<br/>Use New Tape</p>  |
| <p>If new tape, or the drive cannot initialize the tape.</p> | <p>Initialization<br/>Time Out:<br/>followed by:<br/>If Using New Tape<br/>Drive Ready<br/>followed by:<br/>If Tape Has Data<br/>Unload &amp; Reload</p> |
| <p>A hardware error occurs during normal operation.</p>      | <p>ERROR!<br/>HARDWARE FAULT</p>   |

---

---

## Loading the Data Cartridge

 **Caution**

Due to static the label or other items included in this package will occasionally cling to the DLT cartridge.

Before loading into a drive, ensure that all other items from this package are separated from the cartridge.

Never press in on the hub portion of the data cartridge.

**Step 1** If you are planning to write data to, or erase data from, the cartridge, make sure the **Write-Protect** switch on the cartridge is in the write-enabled position (all the way to the right).

 **Caution**

A data cartridge can only be loaded when the **Operate Handle LED** is ON. Do not attempt to open the **Cartridge Insert/Release Handle** unless this LED is ON steady.

**Step 2** Lift up on the **Cartridge Insert/Release Handle**.

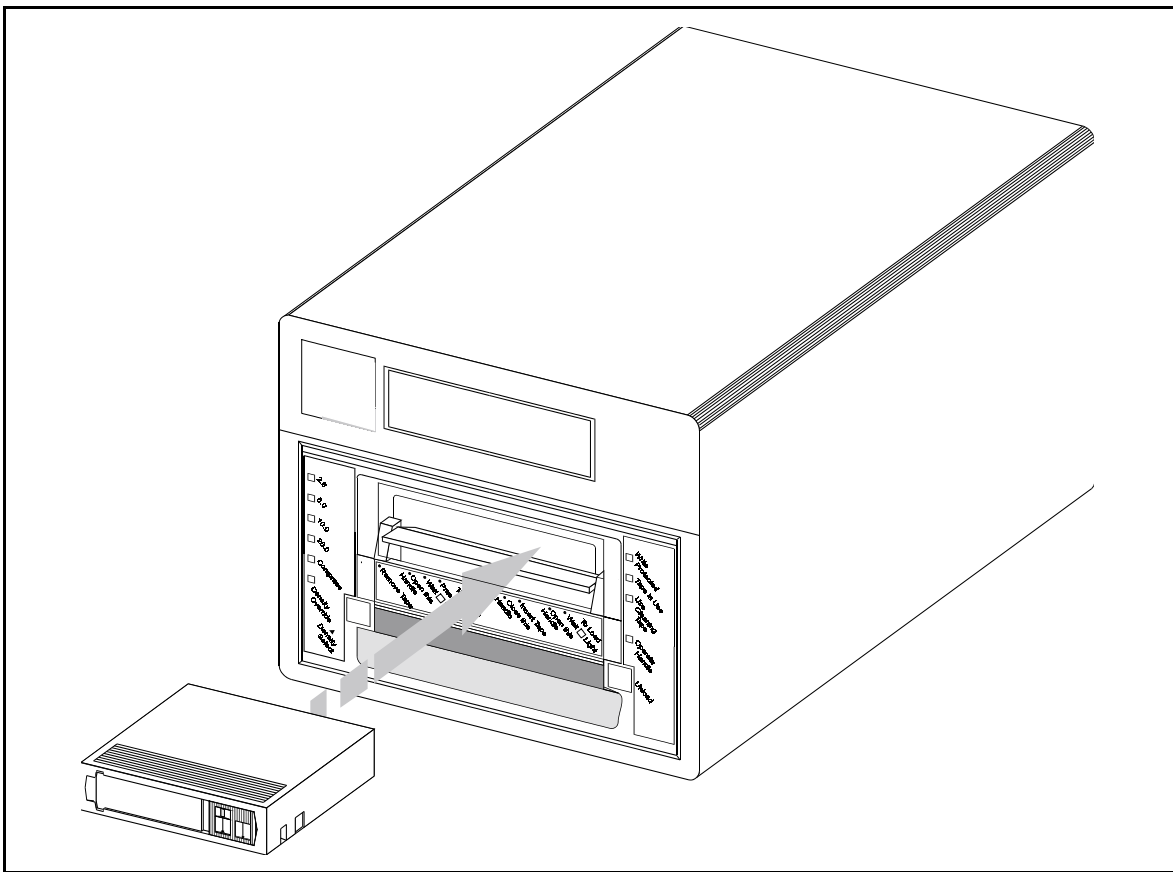

**Figure 5-1** Loading a Data Cartridge

- 
- 
- Step 3** Insert the data cartridge into the slot.
- Step 4** Push the cartridge into the drive.
- Step 5** Push the **Cartridge Insert/Release Handle** closed. The drive will go on-line.



A load sequence will initiate where the **Operate Handle LED** will turn OFF and the **Tape in Use LED** will blink while the drive moves the tape to BOT (Beginning of Tape). When the tape is at BOT, the **Tape in Use LED** will turn ON steady. Additionally, one of the compression density LEDs on the Left Indicator Panel may be illuminated or blinking. The tape is now ready for use.

## Data Protection



### Caution

The **Write-Protect** switch on the data cartridge can be moved while the cartridge is loaded into the drive. The drive will turn on the **Write-Protect LED** immediately. However, if the drive is writing to the tape, write protect does not take effect until the write operation completes.

Before loading the data cartridge, if you move the **Write-Protect** switch to the left, the tape is write-protected; the **Write Protected LED** (orange) is ON and data cannot be written to, or erased from, the tape.

Before loading the data cartridge, if you move the **Write-Protect** switch to the right, the tape is write-enabled and data can be written to, or erased from, the tape (if it is not software write-protected).

After loading the data cartridge and during operation, if you move the **Write-Protect** switch from the write-protected position (to the left) to the write-enabled position (to the right), the tape becomes write-enabled after a variable amount of time (seconds).

After loading the data cartridge and during operation, if you move the **Write-Protect** switch from the write-enabled position (to the right) to the write-protected position (to the left), the tape becomes write-protected after a variable amount of time (seconds).

## Tape in Use

Whenever the **Tape in Use LED** (yellow) is ON steady, the tape is ready to use. When the tape is being read, written, or rewound, **Tape in Use** blinks.

---

---

Table 5-5 indicates what is happening during cartridge use:

**Table 5-5** Tape in Use Indications

| <b>(Right Indicator Panel)</b> |   |  |
|--------------------------------|---|--|
| <b>LED</b>                     | <b>State</b>  | <b>Meaning</b>   |
| Tape in Use                    | ON steady<br>Blinks irregularly<br>Blinks regularly | A cartridge is loaded, but the tape is not moving. This can mean no application is communicating with the controller, or that the application is communicating but is not delivering commands for tape motion. A read or write is in progress. Tape is loading, unloading, or rewinding. |
| Operate Handle                 | ON and beeper sounds                                | Tape is unloaded into the cartridge and the cartridge can now be removed, or if the drive is unloaded, a cartridge can now be inserted.  |
| All LEDs                       | Blinking  | An error has occurred during operation.  |

## Removing the Data Cartridge

### **Caution**

Remove a cartridge from the drive before turning OFF host system power. Failure to remove a cartridge before turning OFF host system power can result in cartridge and drive damage.

To unload a cartridge from the drive perform the following steps

**Step 1** Push the **Unload** button.



The **Tape in Use LED** will blink as the tape rewinds.

### **Caution**

A data cartridge can only be unloaded when the **Operate Handle LED** is ON. Do not attempt to open the **Cartridge Insert/Release Handle** unless this LED is ON steady.

**Step 2** When the **Operate Handle LED** is ON (and the beeper has sounded), pull the **Cartridge Insert/Release Handle** open to eject the cartridge from the drive.

**Step 3** Remove the cartridge.

---

---

**Step 4** Push the **Cartridge Insert/Release Handle** closed.



When you remove the cartridge from the drive, return the cartridge to its plastic case to prolong the cartridge life.

## **Cleaning the Tape Head**

The 4000/7000DLT Series is a highly sophisticated unit. No routine maintenance is required apart from periodically cleaning the drive head whenever the **Use Cleaning Tape** LED is illuminated and the LCD displays the following message:

```
ATTENTION!  
High Data Error Rate
```

followed by

```
Clean Heads or  
Use New Tape
```

If your 4000/7000DLT Series fails to operate correctly, immediately call the customer service.

Cleaning the head should always be performed as the first step if the **Use Cleaning Tape** LED illuminates and the LCD displays the above message.

Table 5-6 on page 5-16 tells you when to use the cleaning tape.

**Table 5-6** Using the Cleaning Tape

| If . . .  | It means . . .   | You should . . .   |
|---|--|--|
| <p>While using a data cartridge, the <b>Use Cleaning Tape LED illuminates</b> and the front panel LCD displays:</p> <pre>ATTENTION! High Data Error Rate</pre> <p>and:</p> <pre>Clean Heads or Use New Tape</pre>           | <p>The drive head needs cleaning or the tape is bad</p>  | <p>Use the cleaning cartridge. Load the cleaning cartridge according to <i>Loading the Data Cartridge</i> on page 5-12.</p> <p>When cleaning is complete, the beeper will sound alerting you to remove the cleaning cartridge. Remove the cleaning cartridge from the drive according to <i>Removing the Data Cartridge</i> on page 5-14</p> |
| <p>While using a data cartridge, the <b>Use Cleaning Tape LED</b> begins to <b>blink</b> and the front panel LCD displays:</p> <pre>ATTENTION! High Data Error Rate</pre> <p>and</p> <pre>Clean Heads or Use New Tape</pre> | <p>The data cartridge may be damaged</p>   | <p>Back up the data from this cartridge onto another cartridge, it may be damaged. A damaged cartridge may cause unnecessary use of the cleaning cartridge.</p>  |
| <p><b>Use Cleaning Tape LED</b> still illuminates after you clean the drive head.</p>   | <p>Your data cartridge may be causing the problem</p>  | <p>Try another data cartridge.</p>   |
| <p><b>Use Cleaning Tape LED</b> illuminates after you load the cleaning cartridge</p>   | <p>Cleaning has <b>not</b> been accomplished and the cleaning cartridge has no remaining cycles available.</p> | <p>Replace the cleaning cartridge.</p>   |

 **Caution**

Using cloth swabs, cotton swabs, cleaning agents, or unapproved cleaning cartridges will void your warranty. Use only an approved cleaning cartridge.



To clean the head, use a cleaning cartridge. Inert the cleaning cartridge in the drive as described in *Loading the Data Cartridge* on page 5-12. The drive will automatically clean the head. When the cleaning operation is complete, the beeper will sound alerting you to remove the cleaning cartridge. The following messages will be displayed during the cleaning process.

**Table 5-7** Cleaning Cycle LCD Messages

|   |   |
|---|---|
| <p>When tape is loaded.</p>                   | <pre>DLTtype    Compressed Ready Mode  15/30GB</pre> <p>DLTtype = DLT™4000 (4000DLT), or DLT™7000 (7000DLT).<br/>Compressed if compression mode enabled or Standard if compression mode disabled.<br/>20/40GB = DLT4000, 35/70GB = DLT7000.<br/>This is the normal "Ready Screen".</p>  |
| <p>While loading the cleaning tape.</p>       | <pre>DLTtype Loading &gt;&gt;&gt;</pre> <p>DLTtype = DLT™4000 (4000DLT), or DLT™7000 (7000DLT).</p>   |
| <p>While the cleaning cycle is executing.</p> | <pre>DLTtype Cleaning &gt;&gt;&gt;</pre>  |
| <p>When cleaning cycle is completed.</p>      | <p>When the cleaning process is complete, the LCD will display the following for 3 to 5 seconds:</p> <pre>DLTtype    Compressed Ready Mode  15/30GB</pre> <p>CCL is the Cleaning Cartridge Load Counter and equals the number of times that a cleaning cartridge has been loaded in this drive.<br/>CCA is the cumulative number of times this cleaning cartridge has been used to clean a drive.</p> |

**Table 5-7** Cleaning Cycle LCD Messages

|                                 |                                |
|---------------------------------|--------------------------------|
| When cleaning tape is unloaded. | Operate Door Handle<br>↓ ↓ ↓ ↓ |
|---------------------------------|--------------------------------|

 **Caution**

**Do not remove the cleaning cartridge before the drive sounds the beeper.**

Remove the cleaning cartridge from the drive as described in *Removing the Data Cartridge* on page 5-14.



**If you load the cleaning cartridge into the drive after it has exhausted its cleaning cycles, it will not clean the head (the cycle is noticeably shorter) and the Use Cleaning Tape LED will be illuminated. Be sure to replace the cleaning cartridge when the cleaning cycle is noticeably shorter.**

## Cleaning the Enclosure

The outside of the enclosure can be cleaned with a damp towel. If you use a liquid all-purpose cleaner, apply it to the towel. Do not spray the enclosure.

# 6

## Troubleshooting and Diagnostic

|  |     |
|--|-----|
| Overview .....                                     | 7-3 |
| Troubleshooting Chart .....                        | 7-3 |
| Use Cleaning Tape LED .....                        | 7-5 |
| Why the Use Cleaning Tape LED Gets Turned ON ..... | 7-6 |
| High Humidity .....                                | 7-7 |



---

---

## Overview

This section lists a number of common problems and the actions to take to correct them. It provides information on why the DLT drive turns on the Use Cleaning Tape LED. The section also explains what to do when you need technical support.

## Troubleshooting Chart

If the 4000/7000DLT Series fails during POST or operation, use the following table to determine the problem and the action to take:

**Table 6-1** Problem Chart

| If . . .  | Then . . .   | You should . . .  |
|---|--|---|
| Your system does not recognize the 4000/7000DLT Series unit | Your system might not be configured to see the SCSI ID   | Configure your system to see the ID.  |
|   | The SCSI ID might not be unique                          | Change the SCSI ID and reconfigure the system. The new ID is effective at the next power-on.    |
|   | The parameters for your SCSI adapter may be incorrect    | Check your SCSI adapter installation.   |
|   | The SCSI signal cable may be loose                       | Make sure the connector on each end of the cable is fully seated and the bail locks are secure. |
|   | The SCSI terminator may not be present or might be loose | Install the terminator; make sure the terminator is fully seated and the bail locks are secure. |

**Table 6-1** Problem Chart

|  |   |   |
|--|---|---|
| <p>Your system does not recognize the 4000/7000DLT Series unit (Continued)</p> | <p>The SCSI bus may not be correctly terminated</p> <p>The SCSI terminator may not be at the end of the bus, or more than two terminators may be present</p> <p>The SCSI bus might be too long.</p> <p>Too many devices might be on the bus</p> | <p>If the 4000/7000DLT Series unit is the last or only device on the bus, make sure the terminator is installed on the 4000/7000DLT.</p> <p>If the 4000/7000DLT Series unit is not the last or only device on the bus, check the cable connections and make sure the terminator is installed at the end of the bus.</p> <p>Be sure to install a terminator at each end of the bus. One terminator is usually installed at the host system.</p> <p>Limit the bus length to the ANSI SCSI-2 standard of 6 meters (19 feet) for single ended buses [3 meters for the 7000DLT].</p> <p>Limit the number of devices on the bus (including the host system) to eight.</p> <p>Check your system configuration rules.</p> |
| <p>The 4000/7000DLT Series unit does not power up</p>                          | <p>The 4000/7000DLT Series unit has no power</p>  | <p>Check the 4000/7000 Series unit power cord connections with the 4000/7000DLT Series unit power switch OFF.</p>   |

**Table 6-1** Problem Chart

|   |   |  |
|---|---|--|
| All right or all left indicator panel LEDs on the drive front panel blink         | A drive fault has occurred  | Try to unload the tape and reinitialize the drive by pressing the Unload button or turn the 4000/7000DLT Series unit power off and then on again.<br><br>The LEDs will stop blinking and the drive will try to reinitialize. The LEDs will turn on steady again and go off if the test succeeds. |
| You are finding fatal or nonfatal errors for which you cannot determine the cause | The bus termination or SCSI signal cable connections might be incorrect<br><br>The AC power source grounding might be incorrect | Make sure the SCSI bus is terminated.<br><br>Use an AC outlet for the 4000/7000 Series unit on the same AC circuit as the AC line powering the host system.  |

## Use Cleaning Tape LED

If an excessive number of read-after-write errors are detected during normal operation of the 4000/7000DLT Series, the **Use Cleaning Tape LED** will be turned on by the drive.

Usually, the **Use Cleaning Tape LED** is turned on by the drive because of a dirty head, so the head should be cleaned and the operation tried again.

If the **Use Cleaning Tape LED** is again turned on and this seems to be a cartridge rather than a drive problem, make sure that all the data on that cartridge is backed up to a new cartridge by doing a complete backup from the source drive, if necessary. Then discard the old cartridge. If you are unsure of the problem source, call customer service.

The **Use Cleaning Tape LED** is normally turned off by executing a cleaning cycle or by cycling power to the 4000/7000DLT Series.

---

---

## Why the Use Cleaning Tape LED Gets Turned ON

The **Use Cleaning Tape** LED will be turned on whenever the drive has determined that low level error performance has degraded to a point where drive head cleaning is absolutely required. It does this by counting the number of C3 (soft) errors as well as the RAW (Read After Write) errors over a number of Mbytes. When a predetermined error rate threshold is reached, the drive displays the warning. Some drives display the warning after a specified number of hours of tape motion have been logged. When a tape is loaded, it may take several minutes for the indication to come on because the drive will wait for a specific number of bytes to be written. A hard (non-recoverable) error will cause the warning to be displayed immediately.

The most common reasons that the **Use Cleaning Tape** LED gets turned on for, in order of highest rate of occurrence, are listed below:

- Dirty ("Stained") heads.  
A cleaning cycle **must** be executed to clear this indication.
- Worn tape.  
DLT tapes are rated at 500,000 passes. Applications that overwrite small blocks of data cause "shoe shining" of the tape against the head and will reach the 500,000 passes sooner than might be expected.
- Bad environment.  
Data errors result from a number of factors, each of which subtract from the margin between good data recovery and an error. Electrical or magnetic interference can decrease this margin. High levels of dust contamination, high humidity, and heat can also be significant factors.



**Placing a CRT monitor on top of, or directly next to, a 4000/7000DLT Series should always be avoided.**

- Worn heads.  
The tape heads will eventually wear out causing the time between cleanings to get shorter and shorter. Tape head failure is usually predicted at about 12% of the MTBF rating (10,000 hours).
- Defective drive.  
Drive amplifier settings could be off, causing error rate degradation. The drive could simply have failed.



---

---

## High Humidity

To minimize the chance of condensation, please observe the following guidelines:

- If you expose cartridges to temperatures outside the operating limits (5-40°C/40-113°F), stabilize them before you use them. To do this, leave the cartridges in the operating temperature for a minimum of two hours.
- Avoid temperature problems by ensuring that the ventilator slots at the front of the drive and the grille on the bottom of the chassis are not obstructed so that the drive has adequate ventilation
- Position the drive where the temperature is relatively stable, for example, away from open windows, fan heaters, and doors.
- Avoid leaving cartridges in severe temperature conditions, for example, in a car standing in bright sunlight.
- Avoid transferring data (reading from and writing to cartridges) when the temperature is changing by more than 10°C per hour.



# A

## Specification

General Specification ..... A-3



---

---

## General Specification

This section contains specification information on the 4000/7000DLT Series. See Table A-1.

**Table A-1** Specifications

### Drive

|                    |                               |         |
|--------------------|-------------------------------|---------|
| Type:              | Quantum <sup>®</sup> DLT™4000 | 4000DLT |
|                    | Quantum <sup>®</sup> DLT™7000 | 7000DLT |
| Data Transfer Rate | 180 MB/min.                   | 4000DLT |
| (compressed mode): | 600 MB/min.                   | 7000DLT |

### Enclosure

|                       |   |         |
|-----------------------|---|---------|
| Electrical Interface: | SCSI-2  | 4000DLT |
|                       | SCSI-2 Fast, Wide   | 7000DLT |
| Physical Interface    | 50-pin, shielded, low-density device connector<br>68-pin, shielded, high-density device connector |         |

### Reliability

|             |   |  |
|-------------|---|--|
| Maintenance | Periodic cleaning of drive head using DLT cleaning cartridge. |  |
| MTBF:       | More than 80,000 power-on hours                               |  |
| MTTR:       | Within 30 minutes (drive replacement)                         |  |

### Physical

|             |                                    |  |
|-------------|------------------------------------|--|
| Dimensions: | 5.75"(h) x 10.50" (w) x 14.50" (d) |  |
| Weight:     | 14 lbs.                            |  |

### Environment

|                    |                                   |  |
|--------------------|-----------------------------------|--|
| Electrical:        | 100-240 vac, 50-60 Hz, 0.6 - 0.3A |  |
| Power Consumption: | less than 40 watts                |  |
| BTU/Hour:          | 170 to 205                        |  |

### Environment (continued)

|              |  |  |
|--------------|--|--|
| Temperature: | 5 ° C to 10° C (Operating)<br>-40° C to 66° C (Storage/Shipping) |  |
| Humidity:    | 20% to 80% (Operating)<br>10% to 95% (Storage/Shipping)          |  |

---

---

**Table A-1** Specifications

|            |  |
|------------|--|
| Vibration: | 0.25G (5-500 Hz) (Operating)<br>0.5G (5-500 Hz) (Storage/Shipping) |
| Shock:     | 2G Operating<br>30G Storage/Shipping                               |

# B

## Drive Configuration

|   |     |
|---|-----|
| Drive Dependent Configuration .....             | B-3 |
| SCSI Bus Parity .....                           | B-3 |
| DLT4000 Drives .....                            | B-3 |
| DLT7000 Drive .....                             | B-4 |
| SCSI Bus Termination and Terminator Power ..... | B-5 |
| DLT4000 Drives .....                            | B-5 |
| DLT7000 Drives .....                            | B-7 |





---

---

## ■ Drive Dependent Configuration

This section describes the options you can select by installing jumpers on the DLT Tape Drives.

## ■ SCSI Bus Parity

The following paragraphs detail information about parity selection on different drive types.

### ■ DLT4000 Drives

If your host computer system does not generate SCSI bus parity, you can disable parity checking in the DLT drives by installing a jumper over two pins on the SCSI ID connector. See Figure B-1 for location of the connector.

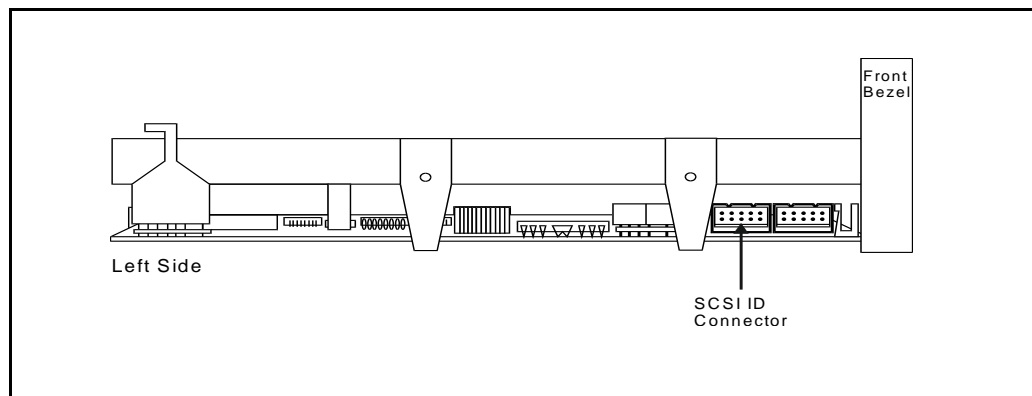

**Figure B-1** DLT4000 Tape Drive Connectors (Left Side)

Figure B-2 shows which pins of the SCSI ID connector have to be jumpered to disable parity.

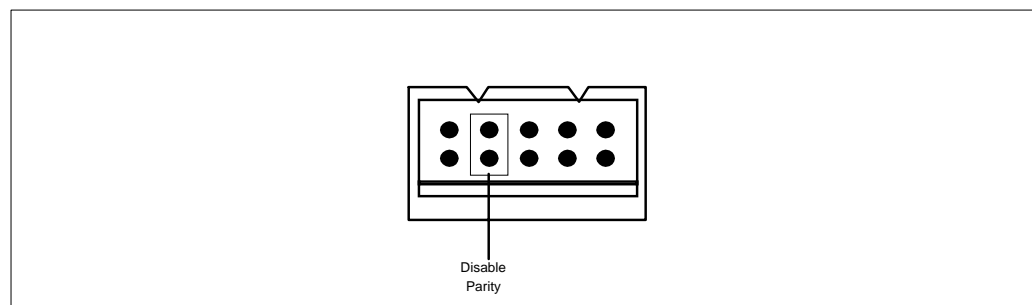

**Figure B-2** Disable Parity Pins on SCSI ID Connector

---

---

## DLT7000 Drive

If your host computer system does not generate SCSI bus parity, you can disable parity checking in the DLT7000 drive by installing a jumper over two pins on the DFDT connector. See Figure B-3 for location of the connector.

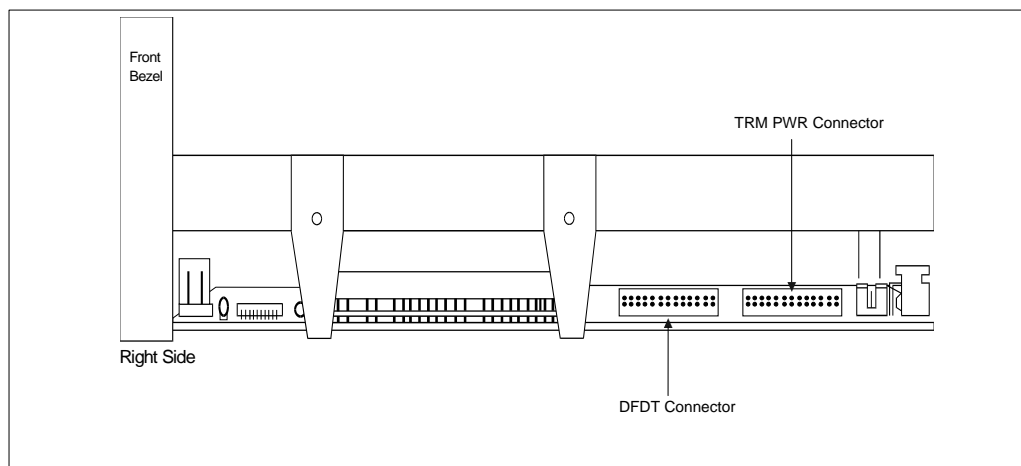

**Figure B-3** DLT7000 Tape Drive Connectors (Right Side)

Figure B-4 shows which pins of the DFDT connector have to be jumpered to disable parity.

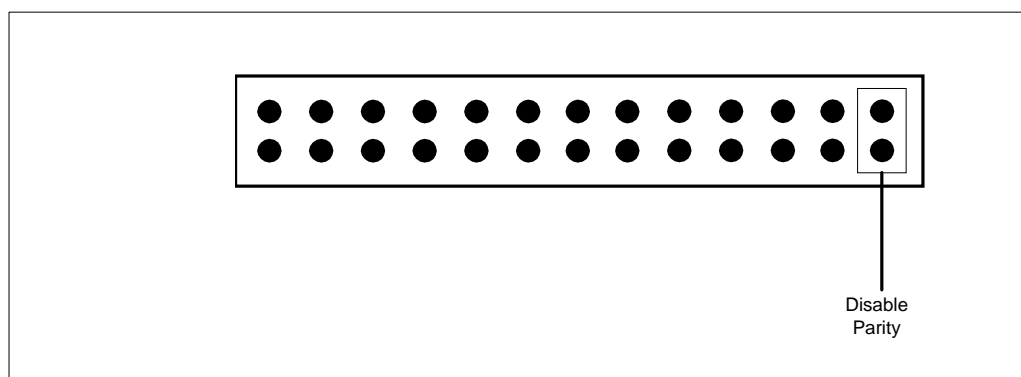

**Figure B-4** Disable Parity Pins on DFDT Connector

---

---

# SCSI Bus Termination and Terminator Power

 **Note**

The SCSI bus must be terminated at both ends, and at least one device must supply terminator power.

The following paragraphs describe information about termination selection on different drives.

## DLT4000 Drives

The DLT4000 drives can be configured to supply terminator power and termination on the bus, by jumpering specific pins on the TRM PWR/TRM ENB connector. See Figure B-5 for the location of the TRM PWR/TRM ENB connector).

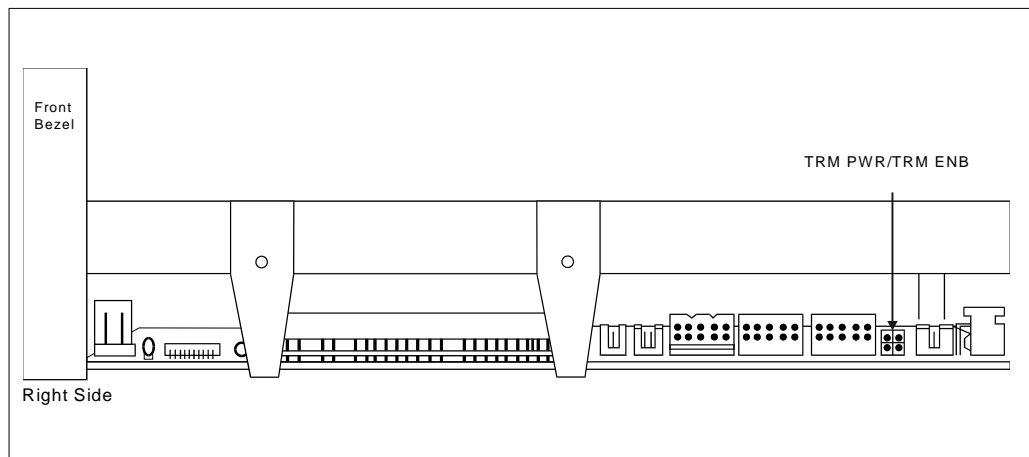
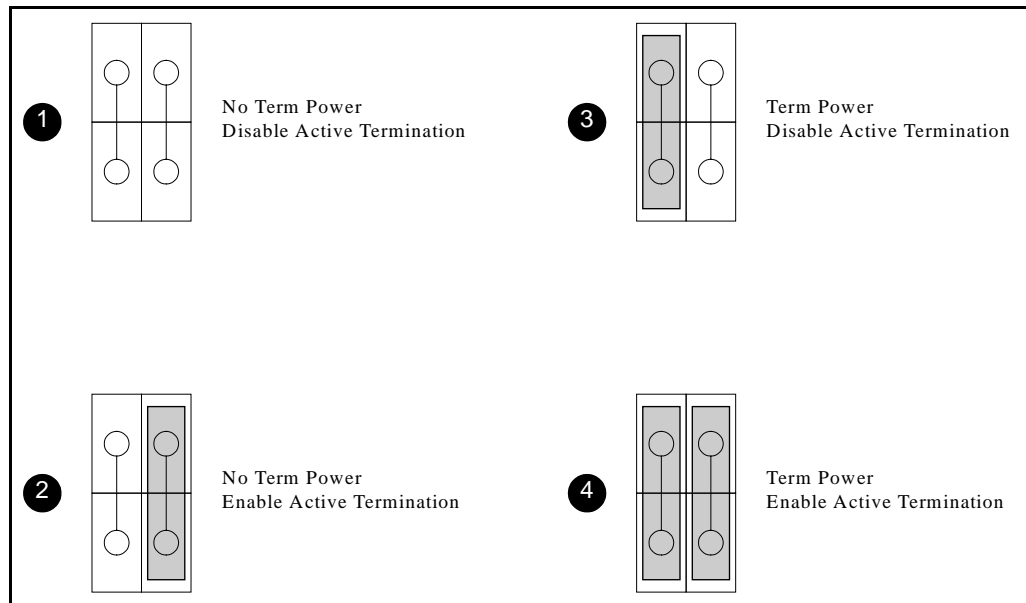

**Figure B-5** DLT4000 Tape Drive Connectors (right side)

Figure 14 and the table following it illustrate the possible position(s) for the TRM PWR/TRM ENB jumper(s).

 **Caution**

**If an external SCSI terminator is used, configurations 2 and 4 in Figure B-6 on page B-6 cannot be used.**



**Figure B-6** TRM PWR/TRM ENB Jumper Position

| If . . .  | And . . .  | Then You Should . . .               |
|---|--|-------------------------------------|
| Another device is providing terminator power                  | The 4000/7000DLT Series <b>is not</b> at the end of the SCSI bus chain | Connect jumpers as 1 in Figure B-6. |
| Another device is providing terminator power                  | The 4000/7000DLT Series <b>is</b> at the end of the SCSI bus chain     | Connect jumpers as 2 in Figure B-6. |
| No other device on the SCSI bus is providing terminator power | The 4000/7000DLT Series <b>is not</b> at the end of the SCSI bus chain | Connect jumpers as 3 in Figure B-6. |
| No other device on the SCSI bus is providing terminator power | The 4000/7000DLT Series <b>is</b> at the end of the SCSI bus chain     | Connect jumpers as 4 in Figure B-6. |

---

---

## DLT7000 Drives

The DLT7000 drive can be configured to supply terminator power, by jumpering specific pins on the TRM PWR connector. See Figure B-7 and Figure B-8 for the location of the TRM PWR connector.

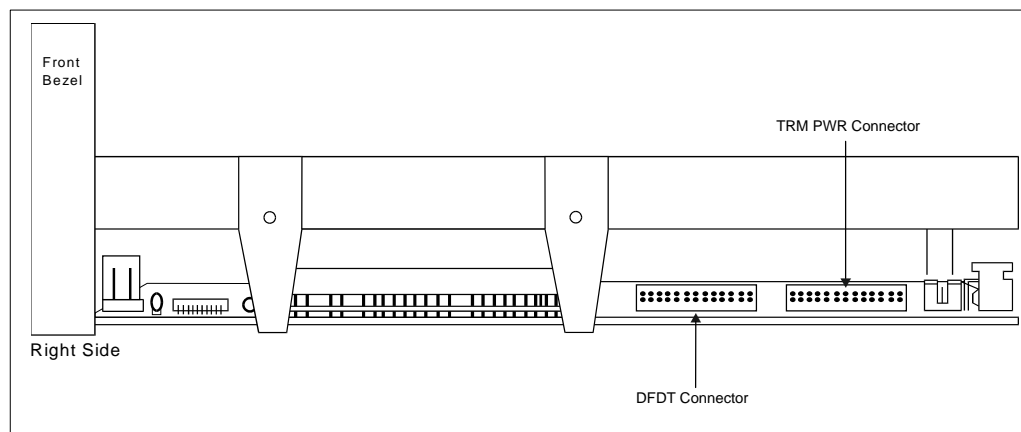

**Figure B-7** DLT7000 Tape Drive Connectors (right side)

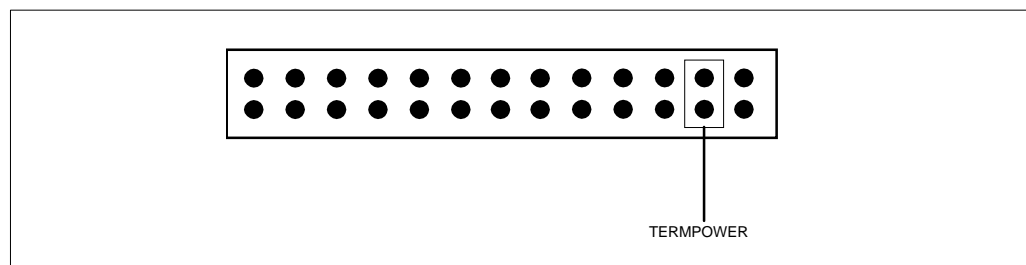

**Figure B-8** Term Power Pins on TRM PWR Connector



# C

## Regulatory Notices

|   |     |
|---|-----|
| FCC Notices (U.S. Only) .....                   | C-3 |
| Shielded Cables .....                           | C-3 |
| Product Type .....                              | C-4 |
| IC Notice (Canada Only) .....                   | C-4 |
| EN 55022 Compliance (Czech Republic Only) ..... | C-5 |
| CE Notice .....                                 | C-5 |
| VCCI Notices (Japan Only) .....                 | C-6 |





---

---

## FCC Notices (U.S. Only)

This equipment generates, uses, and can radiate radio frequency energy and, if not installed and used in accordance with the manufacturer's instruction manual, may cause interference with radio and television reception. This equipment has been tested and found to comply with the limits for a Class B digital device pursuant to Part 15 of the FCC Rules. These limits are designed to provide reasonable protection against harmful interference in a residential installation. However, there is no guarantee that interference will not occur in a particular installation. If this equipment does cause harmful interference with radio or television reception, which can be determined by turning the equipment off and on, you are encouraged to try to correct the interference by one or more of the following measures:

- Reorient the receiving antenna.
- Relocate the computer with respect to the receiver.
- Move the computer away from the receiver.
- Plug the computer into a different outlet so that the computer and the receiver are on different branch circuits.

If necessary, consult an experienced radio/television technician for additional suggestions. You may find the following booklet helpful:

- FCC Interference Handbook, 1986, available from the U.S. Government Printing Office, Washington, DC 20402, Stock No. 004-000-00450-7.

This device complies with Part 15 of the FCC Rules. Operation is subject to the following two conditions:

- This device may not cause harmful interference.
- This device must accept any interference received, including interference that may cause undesired operation.

## Shielded Cables

Use only shielded cables for connecting peripherals to this device to reduce the possibility of interference with radio and television reception. Using shielded cables ensures that you maintain the appropriate FCC radio frequency emissions compliance (for a Class A device) or FCC certification (for a Class B device) of this product.

---

---

## Product Type

The following information is provided on the device or devices covered in this document in compliance with FCC regulations:

Product Name 4000/7000DLT Tabletop Unit

Model number **TBD**

Company name Advanced Digital Information Corporation, PO Box 97057, Redmond, WA 98073-9757 USA

Phone number (425) 881-8004

## IC Notice (Canada Only)

Most tape libraries are classified by the Industry Canada (IC) Interference-Causing Equipment Standard #3 (ICES-003) as Class B digital devices. To determine which classification (Class A or B) applies to your tape library, examine all registration labels located on the bottom or the back panel of your library. A statement in the form of "IC Class A ICES-3" or "IC Class B ICES-3" will be located on one of these labels.

Note that Industry Canada regulations provide that changes or modifications not expressly approved by the tape library manufacturer could void your authority to operate this equipment.

This Class B (or Class A, if so indicated on the registration label) digital apparatus meets the requirements of the Canadian Interference-Causing Equipment Regulations.

Cet appareil numérique de la Classe B (ou Classe A, si ainsi indiqué sur l'étiquette d'enregistrement) respecte toutes les exigences du Règlement sur le Matériel Brouilleur du Canada.

---

---

## EN 55022 Compliance (Czech Republic Only)

This device belongs to category B devices as described in EN 55022, unless it is specifically stated that it is a category A device on the specification label. The following applies to devices in category A of EN 55022 (radius of protection up to 30 meters). The user of the device is obliged to take all steps necessary to remove sources of interference to telecommunication or other devices.

Pokud není na typovém štítku poříta uvedeno, že spadá do třídy A podle EN 55022, spadá automaticky do třídy B podle EN 55022. Pro zařazení zařazen do třídy A (ochranné pásmo 30m) podle EN 55022 platí následující. Dojde-li k rušení telekomunikačních nebo jiných zařazení, je uživatel povinen provést taková opatření, aby rušení odstranil.

## CE Notice

Marking by the symbol indicates compliance of this tape library to the EMC (Electro-magnetic Compatibility) directive of the European Community. Such marking is indicative that this tape library meets or exceeds the following technical standards:

|                 |   |
|-----------------|---|
| EN 55022        | "Limits and Methods of Measurement of Radio Interference Characteristics of Information Technology Equipment." This system is an EN 55022 Class B device.         |
| EN 50082-1:1997 | "Electromagnetic compatibility- Generic immunity standard Part 1: Residential, commercial, and light industry."   |
| EN 61000-4-2    | "Electromagnetic compatibility for industrial-process measurement and control equipment Part 2: Electrostatic discharge requirements." - Severity level 3.        |
| IEC 801-3       | "Electromagnetic compatibility for industrial-process measurement and control equipment Part 3: Radiated electromagnetic field requirements." - Severity level 2. |

---

---

EN 61000-4-4 "Electromagnetic compatibility for industrial-process measurement and control equipment Part 4: Electrical fast transient/burst requirements." - Severity level 2.

EN60950:1992 + Amd.1:1993 + Amd.2:1993 with considerations to Amd.3:1995

"Safety of Information Technology Equipment including Electrical Business Equipment."

A "Declaration of Conformity" in accordance with the preceding standards has been made and is on file at ADIC Europe, Z.A. du Bel-Air, 21 avenue Saint-Fiacre, F78100 - Saint-Germain en Laye, FRANCE.

## VCCI Notices (Japan Only)

This is a Class B product based on the standard of the Voluntary Control Council for Interference for information technology equipment. If this equipment is used near a radio or television receiver in a domestic environment, it may cause radio interference. Install and use the equipment according to the instruction manual.

Note that VCCI regulations provide that changes or modifications not expressly approved by the tape library manufacturer could void your authority to operate this equipment.

# Index

**- 1 -**  
10.0 format ..... 5-7  
10.0 GB format ..... 2-4, 2-8

**- 2 -**  
2.6 format ..... 5-6  
2.6 GB format ..... 2-4, 2-8  
20.0 format ..... 5-7  
20.0 GB format ..... 2-8

**- 6 -**  
6.0 format ..... 5-6  
6.0 GB format ..... 2-4, 2-8

**- 7 -**  
70.0 GB format ..... 2-8

**- A -**  
AC Power Connector ..... 2-9  
Application Software ..... 2-12  
archiving ..... 2-3  
Associated Documents ..... 1-4

**- B -**  
backup software ..... 4-7  
bail locks ..... 4-3, 7-3  
Beeper ..... 2-7  
beeper ..... 5-9

**- C -**  
Cartridge Insert/Release Handle 2-8, 5-6, 5-12,

5-13, ..... 5-14, 5-15  
cartridge insert/release handle ..... 2-7, 2-8  
Chapter Organization ..... 1-3  
cleaning cartridge ..... 5-16, 5-17, A-3  
cleaning the drive head ..... 5-15  
cleaning the enclosure ..... 5-17  
Cleaning the Tape Head ..... 5-15  
Compress LED ..... 2-8  
Compression mode ..... 2-8  
Compression mode disabled ..... 5-7  
compression mode disabled ..... 5-9  
Compression mode enabled ..... 5-7  
compression mode enabled ..... 5-9  
configuration ..... 4-4  
customer assistance ..... 7-5

**- D -**  
data capacity ..... 2-3  
Data cartridge ..... 5-12  
data cartridge 2-10, 2-11, 5-11, 5-12, 5-13, 5-16, B-5  
data compaction ..... 2-3  
data compression ..... 2-3  
data transfer rate ..... A-3  
Density Override LED ..... 2-8, 5-4  
Density Select 10.0 LED ..... 2-8  
Density Select 2.6 LED ..... 2-8  
Density Select 20.0 LED ..... 2-8  
Density Select 6.0 LED ..... 2-8  
Density Select 70.0 LED ..... 2-8  
density selection mode ..... 2-8, 5-7  
diagnostic results ..... 2-5  
Digital Linear Tape ..... 2-3  
dimensions ..... A-3

disable parity .....B-3, B-4  
drive error messages ..... 2-7  
Drive head ..... 2-7  
drive head ..... 5-11  
drive operating condition ..... 5-5  
Drive Operating Conditions ..... 5-5  
drive operating status ..... 2-5  
drive POST results ..... 2-7  
drive Power-On Self-Test (POST) ..... 2-3  
Drive Status ..... 5-3  
drive status messages ..... 2-3, 2-7  
drive type ..... A-3

**- E -**

electrical ..... A-3  
electrical interference ..... 7-6  
embedded data logging of errors ..... 2-5  
embedded diagnostic software ..... 2-5  
environment ..... 7-6  
environmental attributes ..... A-3  
error messages ..... 2-3

**- F -**

firmware updates ..... 2-5  
Flash EEPROM ..... 2-5  
front panel ..... 2-4, 2-5, 2-8, 5-3, 5-7, 7-5

**- H -**

hardware error ..... 5-11  
head cleaning ..... 2-5  
heads ..... 7-6  
host adapter ..... 4-3  
host computer ..... 2-9, 2-11, 4-3, 4-7, B-3, B-4  
Humidity ..... 7-7, A-4  
humidity ..... 7-6

**- I -**

Intended Audience ..... 1-3  
interchange compatibility ..... 2-4  
interface cable ..... 2-9, 4-3, 4-4

**- M -**

magnetic interference ..... 7-6  
maintenance ..... 5-15  
Mean Time Between Failures ..... 7-6, A-3  
Mean Time To Repair ..... A-3  
media ..... 2-4, 5-5

Motion Messages ..... 5-10

**- O -**

off-line storage ..... 2-4  
off-site data storage ..... 2-4  
Operate Handle LED 2-7, 2-8, 5-3, 5-4, 5-6, 5-12,  
5-13, ..... 5-14  
Organization  
Chapter ..... 1-3

**- P -**

packing materials ..... 4-3  
physical attributes ..... A-3  
POST ..... 5-3, 5-4, 5-5, 5-6, 5-7, 7-3  
power consumption ..... A-3  
Power LED ..... 5-3  
power switch ..... 2-9, 7-4  
Power-on Self-Test ..... 5-3

**- R -**

Ready Mode ..... 5-8  
rear panel ..... 2-8, 4-3  
reliability ..... A-3  
Removing the Data Cartridge ..... 5-14

**- S -**

Safety Instructions ..... 3-3  
SCSI adapter ..... 7-3  
SCSI address ..... 4-5  
SCSI bus ..... 4-6, 4-7, 7-4, 7-5, B-5, B-6  
SCSI bus chain ..... B-6  
SCSI bus connector ..... 2-12, 4-3  
SCSI Bus Parity ..... B-3  
SCSI bus parity ..... B-3, B-4  
SCSI Bus Termination ..... 4-6  
SCSI Bus Termination and Terminator Power B-5  
SCSI cable ..... 4-3  
SCSI channel ..... 2-9, 4-4  
SCSI Channel Connectors ..... 2-9  
SCSI connector ..... 4-4  
SCSI controller ..... 2-11  
SCSI device connectors ..... 4-3  
SCSI devices ..... 4-5  
SCSI Host Adapter ..... 4-6  
SCSI host adapter ..... 2-11, 2-12, 4-6  
SCSI ID ..... 2-9, 4-5, 4-6, 7-3  
SCSI ID connector ..... B-3, B-4  
SCSI ID Switch ..... 2-9

---

|                            |                               |
|----------------------------|-------------------------------|
| SCSI ID switch .....       | 4-5                           |
| SCSI Interface Cable ..... | 2-12                          |
| SCSI interface cable ..... | 4-3                           |
| SCSI signal cable .....    | 7-3                           |
| SCSI terminator ....       | 2-12, 4-4, 4-6, 5-3, 7-3, 7-4 |
| shelf life .....           | 2-4                           |
| Shock .....                | A-4                           |
| Symbols and Notes .....    | 1-4                           |
| system configuration ..... | 7-4                           |

**- T -**

|                            |                                |
|----------------------------|--------------------------------|
| Tape density .....         | 2-4                            |
| Tape In Use LED .....      | 5-8                            |
| Tape in Use LED ..         | 2-7, 5-3, 5-4, 5-6, 5-13, 5-14 |
| temperature .....          | 7-7, A-3                       |
| temperature problems ..... | 7-7                            |
| term power .....           | B-5, B-6, B-7                  |
| terminator .....           | 4-6                            |

**- U -**

|                       |                            |
|-----------------------|----------------------------|
| Unload Button .....   | 2-8                        |
| Unload button .....   | 5-4, 5-14, 7-5             |
| Use Cleaning Tape LED | 2-7, 5-3, 5-6, 5-15, 5-16, |
| 5-17, .....           | 7-5, 7-6                   |

**- V -**

|                   |     |
|-------------------|-----|
| ventilation ..... | 7-7 |
| Vibration .....   | A-4 |

**- W -**

|                            |                           |
|----------------------------|---------------------------|
| warranty .....             | 4-3, 5-16                 |
| weight .....               | A-3                       |
| write enabled .....        | 2-7                       |
| Write Protected LED .....  | 2-7, 5-3, 5-6, 5-13       |
| write-enabled .....        | 2-10, 5-6, 5-12, 5-13     |
| Write-Protect switch ..... | 2-10, 5-12, 5-13          |
| write-protected .....      | 2-7, 2-10, 5-6, 5-9, 5-13 |





## Free Manuals Download Website

<http://myh66.com>

<http://usermanuals.us>

<http://www.somanuals.com>

<http://www.4manuals.cc>

<http://www.manual-lib.com>

<http://www.404manual.com>

<http://www.luxmanual.com>

<http://aubethermostatmanual.com>

Golf course search by state

<http://golfingnear.com>

Email search by domain

<http://emailbydomain.com>

Auto manuals search

<http://auto.somanuals.com>

TV manuals search

<http://tv.somanuals.com>