

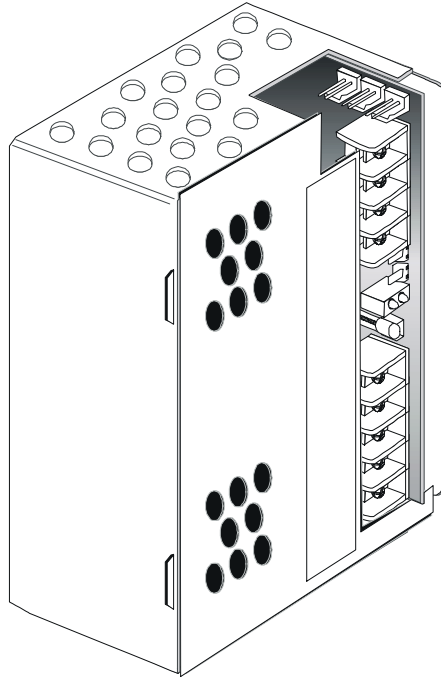

ADT Security Services, Inc.
1750 Clint Moore Road
Boca Raton, FL 33431
(561) 988-3600



ADT-APS-6R Auxiliary Power Supply Installation Instructions

Document 50935

07/21/2000

Revision:

B

PN 50935:B

ECN 00-317

Fire Alarm System Limitations

An automatic fire alarm system—typically made up of smoke detectors, heat detectors, manual pull stations, audible warning devices, and a fire alarm control with remote notification capability—can provide early warning of a developing fire. Such a system, however, does not assure protection against property damage or loss of life resulting from a fire.

The Manufacturer recommends that smoke and/or heat detectors be located throughout a protected premise following the recommendations of the current edition of the National Fire Protection Association Standard 72 (NFPA 72), manufacturer's recommendations, State and local codes, and the recommendations contained in the Guide for Proper Use of System Smoke Detectors, which is made available at no charge to all installing dealers. A study by the Federal Emergency Management Agency (an agency of the United States government) indicated that smoke detectors may not go off in as many as 35% of all fires. While fire alarm systems are designed to provide early warning against fire, they do not guarantee warning or protection against fire. A fire alarm system may not provide timely or adequate warning, or simply may not function, for a variety of reasons:

Smoke detectors may not sense fire where smoke cannot reach the detectors such as in chimneys, in or behind walls, on roofs, or on the other side of closed doors. Smoke detectors also may not sense a fire on another level or floor of a building. A second-floor detector, for example, may not sense a first-floor or basement fire.

Particles of combustion or "smoke" from a developing fire may not reach the sensing chambers of smoke detectors because:

- Barriers such as closed or partially closed doors, walls, or chimneys may inhibit particle or smoke flow.
- Smoke particles may become "cold," stratify, and not reach the ceiling or upper walls where detectors are located.
- Smoke particles may be blown away from detectors by air outlets.
- Smoke detectors may be drawn into air returns before reaching the detector.

The amount of "smoke" present may be insufficient to alarm smoke detectors. Smoke detectors are designed to alarm at various levels of smoke density. If such density levels are not created by a developing fire at the location of detectors, the detectors will not go into alarm.

Smoke detectors, even when working properly, have sensing limitations. Detectors that have photoelectric sensing chambers tend to detect smoldering fires better than flaming fires, which have little visible smoke. Detectors that have ionizing-type sensing chambers tend to detect fast-flaming fires better than smoldering fires. Because fires develop in different ways and are often unpredictable in their growth, neither type of detector is necessarily best and a given type of detector may not provide adequate warning of a fire.

Smoke detectors cannot be expected to provide adequate warning of fires caused by arson, children playing with matches (especially in bedrooms), smoking in bed, and violent explosions (caused by escaping gas, improper storage of flammable materials, etc.).

While a fire alarm system may lower insurance rates, it is not a substitute for fire insurance!

Heat detectors do not sense particles of combustion and alarm only when heat on their sensors increases at a predetermined rate or reaches a predetermined level. Rate-of-rise heat detectors may be subject to reduced sensitivity over time. For this reason, the rate-of-rise feature of each detector should be tested at least once per year by a qualified fire protection specialist. *Heat detectors are designed to protect property, not life.*

IMPORTANT! Smoke detectors must be installed in the same room as the control panel and in rooms used by the system for the connection of alarm transmission wiring, communications, signaling, and/or power. If detectors are not so located, a developing fire may damage the alarm system, crippling its ability to report a fire.

Audible warning devices such as bells may not alert people if these devices are located on the other side of closed or partly open doors or are located on another floor of a building. Any warning device may fail to alert people with a disability or those who have recently consumed drugs, alcohol or medication. Please note that:

- Strobes can, under certain circumstances, cause seizures in people with conditions such as epilepsy.
- Studies have shown that certain people, even when they hear a fire alarm signal, do not respond or comprehend the meaning of the signal. It is the property owner's responsibility to conduct fire drills and other training exercise to make people aware of fire alarm signals and instruct them on the proper reaction to alarm signals.
- In rare instances, the sounding of a warning device can cause temporary or permanent hearing loss.

A fire alarm system will not operate without any electrical power. If AC power fails, the system will operate from standby batteries only for a specified time and only if the batteries have been properly maintained and replaced regularly.

Equipment used in the system may not be technically compatible with the control. It is essential to use only equipment listed for service with your control panel.

Telephone lines needed to transmit alarm signals from a premise to a central monitoring station may be out of service or temporarily disabled. For added protection against telephone line failure, backup radio transmission systems are recommended.

The most common cause of fire alarm malfunction is inadequate maintenance. To keep the entire fire alarm system in excellent working order, ongoing maintenance is required per the manufacturer's recommendations, and UL and NFPA standards. At a minimum, the requirements of Chapter 7 of NFPA 72 shall be followed. Environments with large amounts of dust, dirt or high air velocity require more frequent maintenance. A maintenance agreement should be arranged through the local manufacturer's representative. Maintenance should be scheduled monthly or as required by National and/or local fire codes and should be performed by authorized professional fire alarm installers only. Adequate written records of all inspections should be kept.

Installation Precautions

WARNING - Several different sources of power can be connected to the fire alarm control panel. Disconnect all sources of power before servicing. Control unit and associated equipment may be damaged by removing and/or inserting cards, modules, or interconnecting cables while the unit is energized. Do not attempt to install, service, or operate this unit until this manual is read and understood.

CAUTION - *System Reacceptance Test after Software Changes.* To ensure proper system operation, this product must be tested in accordance with NFPA 72 Chapter 7 after any programming operation or change in site-specific software. Reacceptance testing is required after any change, addition or deletion of system components, or after any modification, repair or adjustment to system hardware or wiring.

All components, circuits, system operations, or software functions known to be affected by a change must be 100% tested. In addition, to ensure that other operations are not inadvertently affected, at least 10% of initiating devices that are not directly affected by the change, up to a maximum of 50 devices, must also be tested and proper system operation verified.

This system meets NFPA requirements for operation at 0-49° C/32-120° F and at a relative humidity of 85% RH (non-condensing) at 30° C/86° F. However, the useful life of the system's standby batteries and the electronic components may be adversely affected by extreme temperature ranges and humidity. Therefore, it is recommended that this system and all peripherals be installed in an environment with a nominal room temperature of 15-27° C/60-80° F.

Verify that wire sizes are adequate for all initiating and indicating device loops. Most devices cannot tolerate more than a 10% I.R. drop from the specified device voltage.

Adherence to the following will aid in problem-free installation with long-term reliability:

Like all solid state electronic devices, this system may operate erratically or can be damaged when subjected to lightning-induced transients. Although no system is completely immune from lightning transients and interferences, proper grounding will reduce susceptibility. *Overhead or outside aerial wiring is not recommended, due to an increased susceptibility to nearby lightning strikes.* Consult with the Technical Services Department if any problems are anticipated or encountered.

Disconnect AC power and batteries prior to removing or inserting circuit boards. Failure to do so can damage circuits.

Remove all electronic assemblies prior to any drilling, filing, reaming, or punching of the enclosure. When possible, make all cable entries from the sides or rear. Before making modifications, verify that they will not interfere with battery, transformer, and printed circuit board location.

Do not tighten screw terminals more than 9 in-lbs. Over-tightening may damage threads, resulting in reduced terminal contact pressure and difficulty with screw terminal removal.

Though designed to last many years, system components can fail at any time. This system contains static-sensitive components. Always ground yourself with a proper wrist strap before handling any circuits so that static charges are removed from the body. Use static-suppressive packaging to protect electronic assemblies removed from the unit.

Follow the instructions in the installation, operating, and programming manuals. These instructions must be followed to avoid damage to the control panel and associated equipment. FACP operation and reliability depend upon proper installation by authorized personnel.

FCC Warning

WARNING: This equipment generates, uses, and can radiate radio frequency energy and if not installed and used in accordance with the instruction manual, may cause interference to radio communications. It has been tested and found to comply with the limits for class A computing device pursuant to Subpart B of Part 15 of FCC Rules, which is designed to provide reasonable protection against such interference when operated in a commercial environment. Operation of this equipment in a residential area is likely to cause interference, in which case the user will be required to correct the interference at his own expense.

Canadian Requirements

This digital apparatus does not exceed the Class A limits for radiation noise emissions from digital apparatus set out in the Radio Interference Regulations of the Canadian Department of Communications.

Le présent appareil numérique n'émet pas de bruits radioélectriques dépassant les limites applicables aux appareils numériques de la classe A prescrites dans le Règlement sur le brouillage radioélectrique édicté par le ministère des Communications du Canada.

Table of Contents

Table of Contents

1. Overview

Introduction	5
Description	5
Specifications	7

2. Installation

Introduction	9
Mounting an ADT-APS-6R in a ADT-CAB-400AA Backbox.....	10
Mounting in ADT-CAB-3 Series Cabinets	11
Instructions for mounting:	11
CHS-4 Series Chassis Mounting.....	11
Wiring the ADT-APS-6R	12
Field Wiring an ADT-APS-6R	12
Connecting Multiple ADT-APS-6R Power Supplies	13
Wiring Applications	14
Connecting the ADT-APS-6R to an ICM-4/ICE-4 Module	14
Supplying Power to a M300CADT Module	15
Configuring the ADT-APS-6R	16
Servicing the ADT-APS-6R	17

Appendix A - Unimode 4-16

Connecting the ADT-APS-6R to an MPS-24B.....	19
--	----

Appendix B - Unimode 300/400

Connecting the ADT-APS-6R to an MPS-400	21
---	----

Appendix C - Unimode II & Unimode 2020

Connecting the ADT-APS-6R to an MPS-24A	23
Connecting the ADT-APS-6R to an MPS-24B.....	24

1. Overview

Introduction

This document contains information for installing, servicing, and configuring the ADT-APS-6R Auxiliary Power Supply. The table below contains a list of document sources for supplemental information:

Control Panels	Refer to...	Part Number
Unimode 4-16	Unimode 4-16 Installation Manual	A15019
Unimode II Series	Unimode II Installation Manual	A15583
Unimode 400 Series	Unimode 400 Installation Manual	50710
Unimode 2020	Unimode 2020 Installation Manual	51167
ADT Transponder Series	ADT Transponder Manual	50928
All	ADT Device Compatibility Document	51352

Table 1 Supplemental Documentation

Description

The ADT-APS-6R Auxiliary Power Supply is a 150W cabinet-mounted power supply, designed to power devices that require filtered, regulated, non-resettable power, such as XP Transponder modules, Notification Appliance Circuit Modules and Control Modules. The ADT-APS-6R provides three 24 VDC (filtered) output circuits.

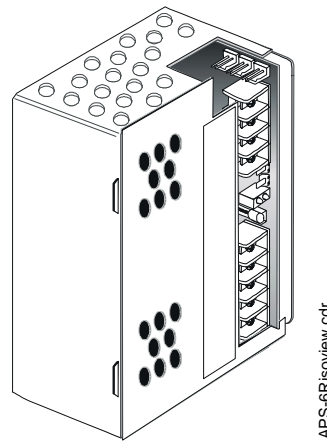

Figure 1 ADT-APS-6R Auxilliary Power Supply

1. Overview

Description

The figures below identify the features of the ADT-APS-6R power supply:

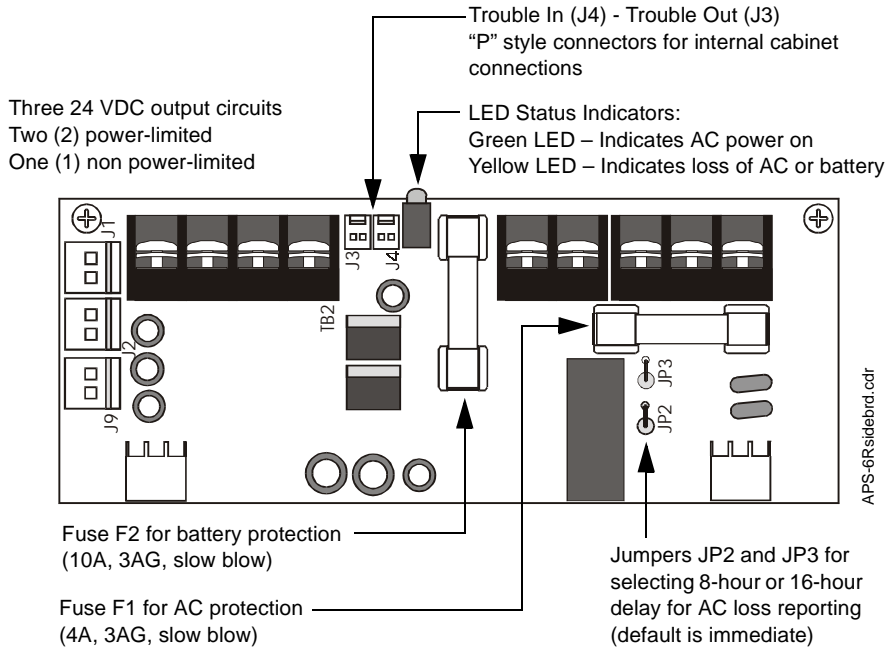

Figure 2 ADT-APS-6R Control Board

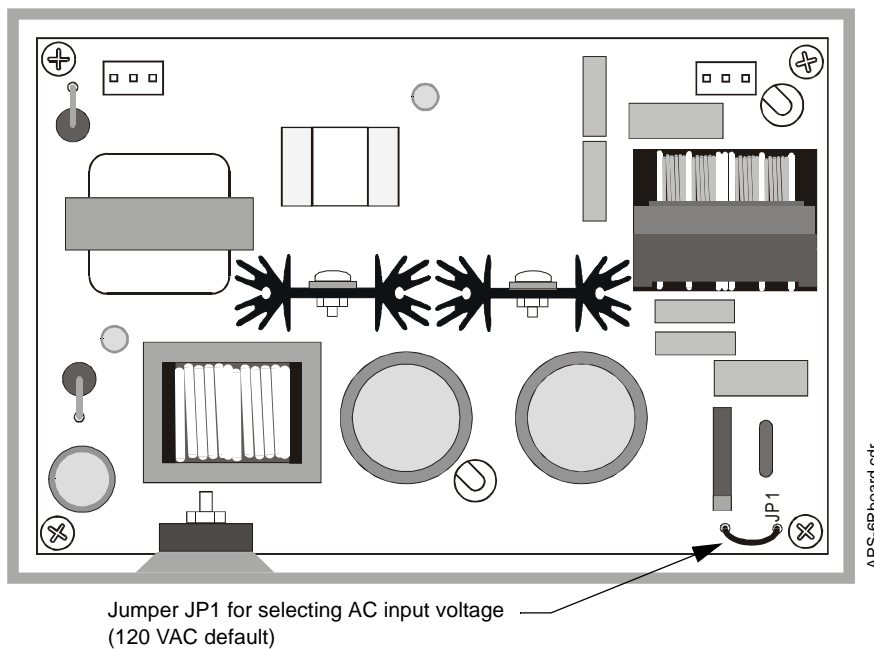

Figure 3 ADT-APS-6R Main Board

Specifications

The ADT-APS-6R is compatible with the Unimode II, Unimode 300/400, Unimode 4-16 and Unimode 2020 control panels. Specifications for the ADT-APS-6R are:

Electrical Specifications	
AC Primary Input Power	120 VAC, 60 Hz, 2.5 A
Wire Size: #14 AWG with 600 VAC insulation	240 VAC, 50 Hz, 1.2 A
24 VDC Secondary Input Power (lead-acid batteries only)	25 mA DC standby current 16 mA DC standby current (with AC fail delay operating)
Note: Batteries are charged by the system power supply.	
24 VDC output power	Total 6 A (4 A continuous)
Circuit 1	3 A @24 VDC power-limited (+10, -15%)
Circuit 2	3 A @24 VDC power-limited (+10, -15%)
Circuit 3	6 A @24 VDC non power-limited (+10, -15%)
Fuses	
F1 (AC supervision)	250 VAC, 4A, 3 AG, slow blow
F2 (battery supervision)	32 VAC, 10 A, 3 AG, slow blow
Trouble supervision bus	
J3 output	Form A contact (open collector)
J4 input	Form A contact (open collector)
Note: J3 and J4 can be interchanged.	
Loss of AC Indication	Immediate indication (default) 8 or 16 hour delay
Mechanical Specifications	
Size of ADT-APS-6R in enclosure	6.09 in. x 4.23 in. x 2.92 in.
Cabinets for mounting	ADT-CAB-3 Series, using CHS-4 and CHS-4L chassis, for Unimode 400, unimode II and Unimode 2020 control panels. ADT-CAB-400AA for Unimode 300/400 control panel; accepts one APS-6R. Unimode 4-16 can accept one ADT-APS-6R.
Note: An optional module (such as an ICM-4) without an expansion card can mount above an ADT-APS-6R in a CHS-4, a Unimode 4-16, and a ADT-CAB-400AA.	

Table 2 ADT-APS-6R Specifications

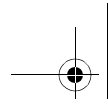

1. Overview

Specifications

NOTES

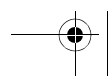
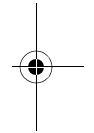
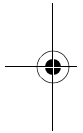

2. Installation



WARNING: Use extreme caution when working with the APS-6R. High voltage and AC line-connected circuits are present. Turn off and remove all power sources. To reduce the risk of electric shock make sure to properly ground the unit.

Introduction

This section contains instructions for mounting, wiring, configuring and servicing the ADT-APS-6R.

Installation topics covered in detail:

Topic	Refer to...
Mounting to a ADT-CAB-400AA Backbox	"Mounting an ADT-APS-6R in a ADT-CAB-400AA Backbox" on page 10
Mounting to a ADT-CAB-3 Series Cabinet	"Mounting in ADT-CAB-3 Series Cabinets" on page 11
Field Wiring	"Field Wiring an ADT-APS-6R" on page 12
Wiring Multiple ADT-APS-6Rs	"Connecting Multiple ADT-APS-6R Power Supplies" on page 13
Connecting to an ICM/ICE	"Connecting the ADT-APS-6R to an ICM-4/ICE-4 Module" on page 14
Powering an M300CADT	"Supplying Power to a M300CADT Module" on page 15
Configuring	"Configuring the ADT-APS-6R" on page 16
Servicing	"Servicing the ADT-APS-6R" on page 17

2. Installation

*Mounting an ADT-APS-6R in a ADT-CAB-400AA Backbox***Mounting an ADT-APS-6R in a ADT-CAB-400AA Backbox**

An Auxiliary Power Supply is mounted as shown in the figure below.

To mount the ADT-APS-6R, follow these instructions:

Step	Action
1	Remove plastic cover from APS-6R.
2	If 240 VAC is to be used, cut JP1 jumper at this time. See "Configuring the ADT-APS-6R" on page 16.
3	Place the APS-6R onto the mounting studs in the backbox.
4	Insert a standoff through each of the printed circuit board mounting holes, threading each standoff to the mounting studs.
5	Tighten the standoffs until the APS-6R is securely fastened to the backbox.
6	Reinstall the plastic chassis cover.

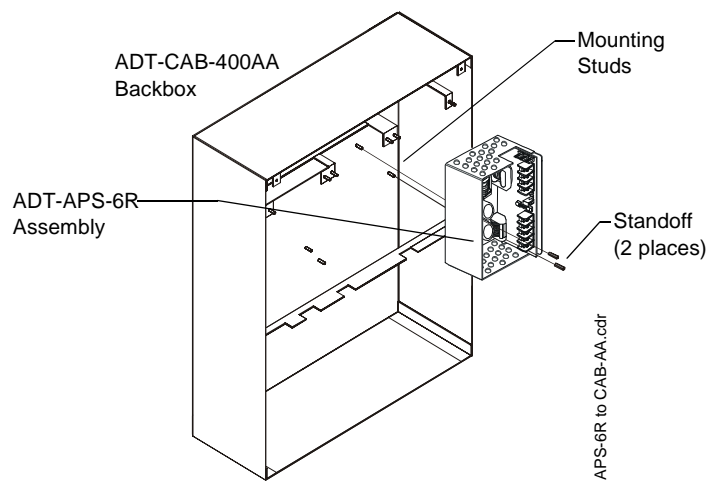

Figure 4 Mounting an ADT-APS-6R to a ADT-CAB-400AA Backbox

Mounting in ADT-CAB-3 Series Cabinets

This section contains instructions for the installation of the Auxiliary Power Supply into a ADT-CAB-3 Series cabinet (ADT-CAB-A3, ADT-CAB-B3, ADT-CAB-C3 and ADT-CAB-D3).

These cabinets use a CHS-4L or CHS-4 Chassis to mount the ADT-APS-6R.

Instructions for mounting:

Step	Action
1	Remove plastic cover from APS-6R.
2	If 240 VAC is to be used, cut JP1 jumper at this time. See "Configuring the ADT-APS-6R" on page 16.
3	Place the APS-6R onto the mounting studs of the chassis (Figure 5 on page 11).
4	Insert a standoff through each of the printed circuit board mounting holes, threading each standoff to the mounting studs on the chassis.
5	Tighten the standoffs until the APS-6R is securely fastened to the chassis.
6	Reinstall the plastic chassis cover.

CHS-4 Series Chassis Mounting

The illustration below shows an ADT-APS-6R being mounted in a CHS-4L chassis. Mounting in a CHS-4 chassis is accomplished in the same way.

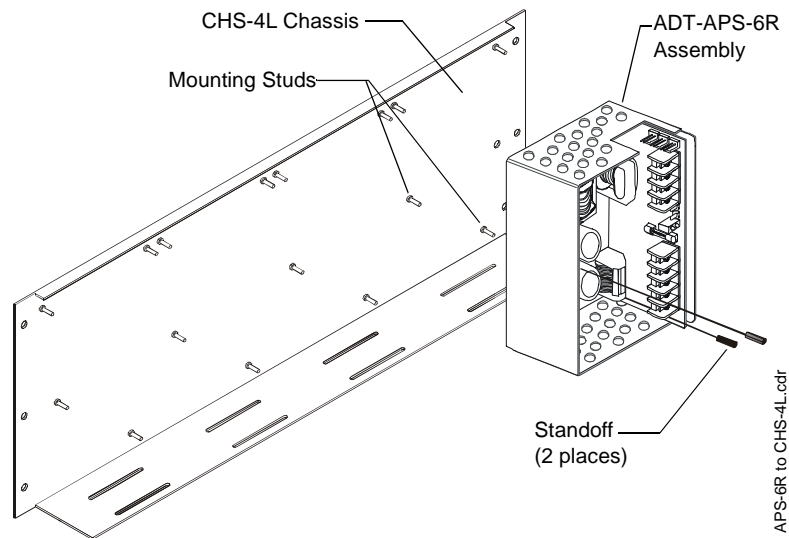

Figure 5 Mounting an ADT-APS-6R to a CHS-4L Chassis

2. Installation

Wiring the ADT-APS-6R

Wiring the ADT-APS-6R

This section contains instructions for wiring the Auxiliary Power Supply as follows:

- Typical field wiring from an ADT-APS-6R to a control panel and optional devices.
- Wiring multiple ADT-APS-6R power supplies.

Field Wiring an ADT-APS-6R

You can use J1 and J2 in place of TB2 when the ADT-APS-6R is powering internal modules (such as an ICM-4, ICE-4, ADT-UZC-256, XPC-8) with compatible connectors.

Output Circuit 3 (J9) can be used as a source of power for the XPIQ Audio Transponder only.

Note: When using the J9 connector do not use the J2 connector. This will satisfy the 0.25 (6.35mm) requirement for separation between power-limited and nonpower-limited circuits.

Primary and Secondary Power Connections - See appendix for your specific system information.



Caution: When finished wiring AC connections, install the press-fit terminal block cover over TB1 AC connections.

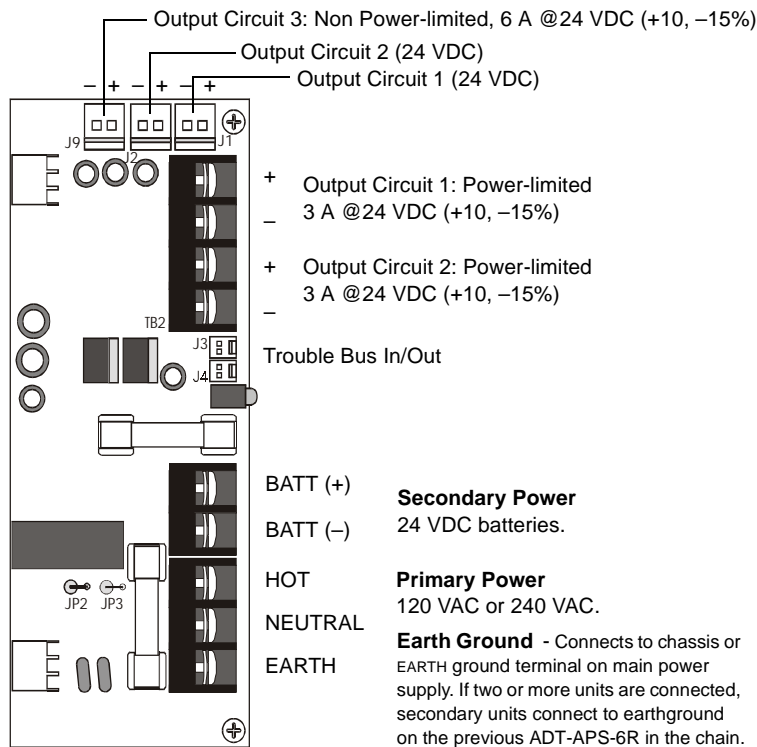

Figure 6 Typical Wiring for an ADT-APS-6R

Connecting Multiple ADT-APS-6R Power Supplies

Typical trouble bus connections for multiple ADT-APS-6R power supplies using trouble connectors J3 and J4.

Use Cable 71033 or 75098 (same cables; different lengths) for all wiring.

See appendix on your system for specific "Trouble Input" connection.

Note: J3 and J4 can be interchanged.

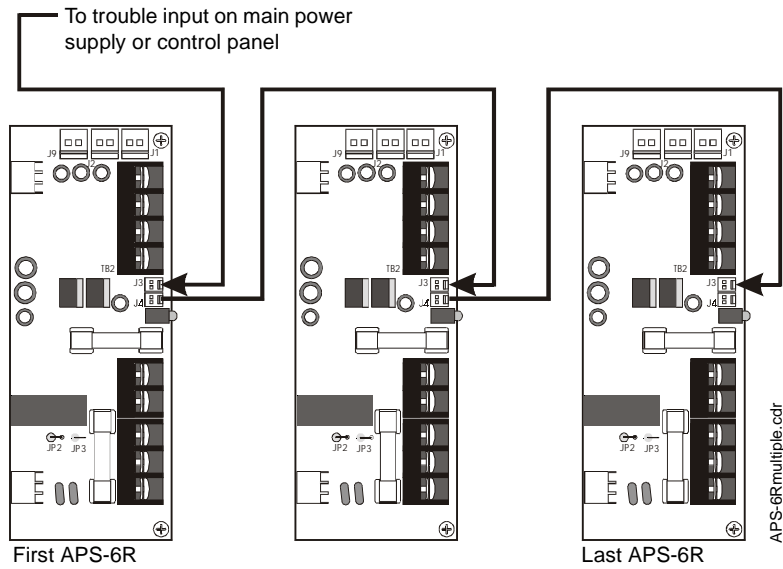

Figure 7 Trouble Bus Connections for Multiple ADT-APS-6R Configurations

2. Installation

Wiring Applications

Wiring Applications

This section contains instructions for wiring the ADT-APS-6R assembly as follows:

- Connecting the ADT-APS-6R to an ICM-4/ICE-4 module
- Supplying notification appliance power to a FCM module

Connecting the ADT-APS-6R to an ICM-4/ICE-4 Module

All four (4) NACs on the ICM-4 are powered from the ADT-APS-6R output circuit 2 (J2) and the four (4) NACs on the ICE-4 are powered from circuit 1 (J1). The NACs share the total 3A available from each circuit.

Typical connections for wiring:

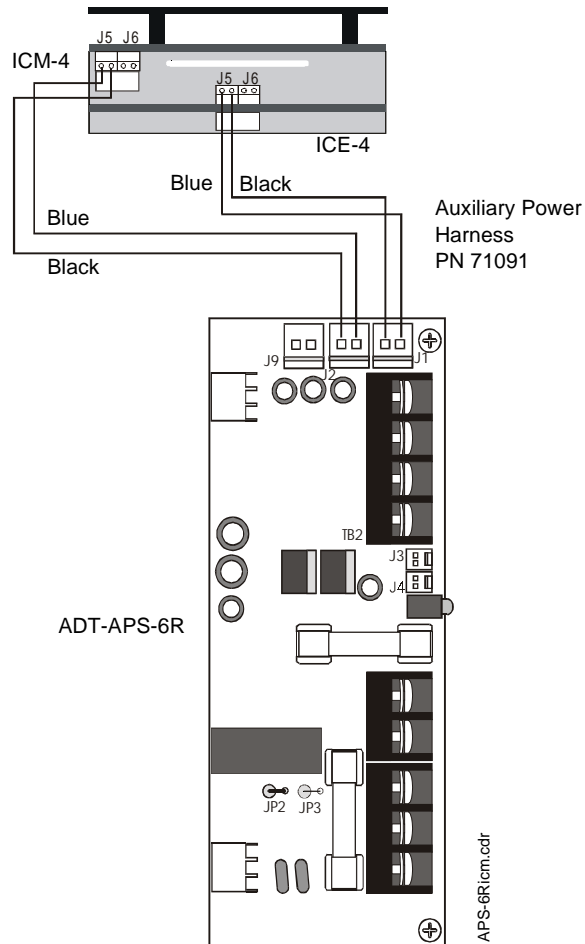

Figure 8 Typical ADT-APS-6R Wiring to an ICM-4/ICE-4 Module

Supplying Power to a M300CADT Module

The circuit is supervised and power-limited.

Typical connections for wiring:

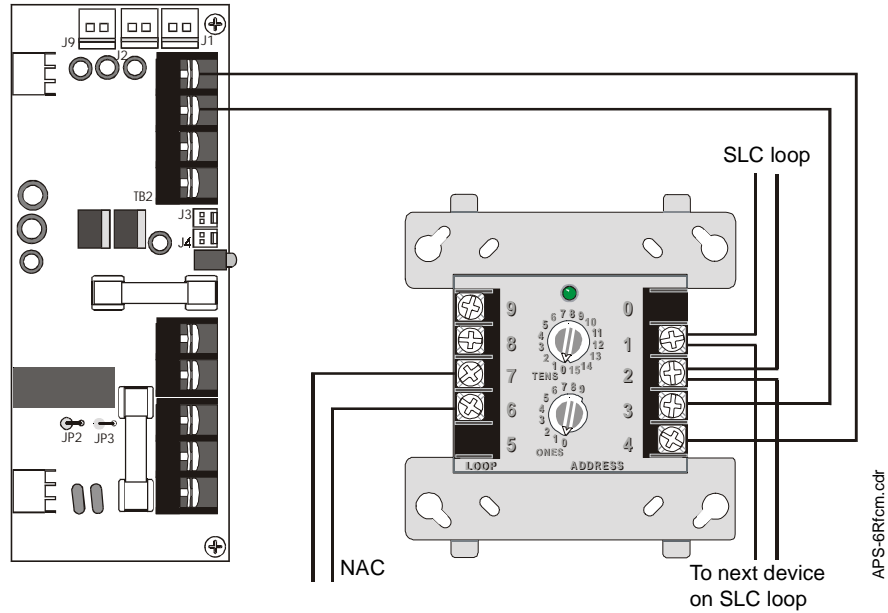

Figure 9 Typical ADT-APS-6R Wiring to a M300CADT Module

2. Installation

Configuring the ADT-APS-6R

Configuring the ADT-APS-6R

The ADT-APS-6R may be configured for the following:

- 8-hour delay for reporting loss of AC: cut jumper JP2.
- 16-hour delay for reporting loss of AC: cut jumper JP2 and JP3.
- 240 VAC operation: cut jumper JP1.

The figure below illustrates the location of the jumpers:

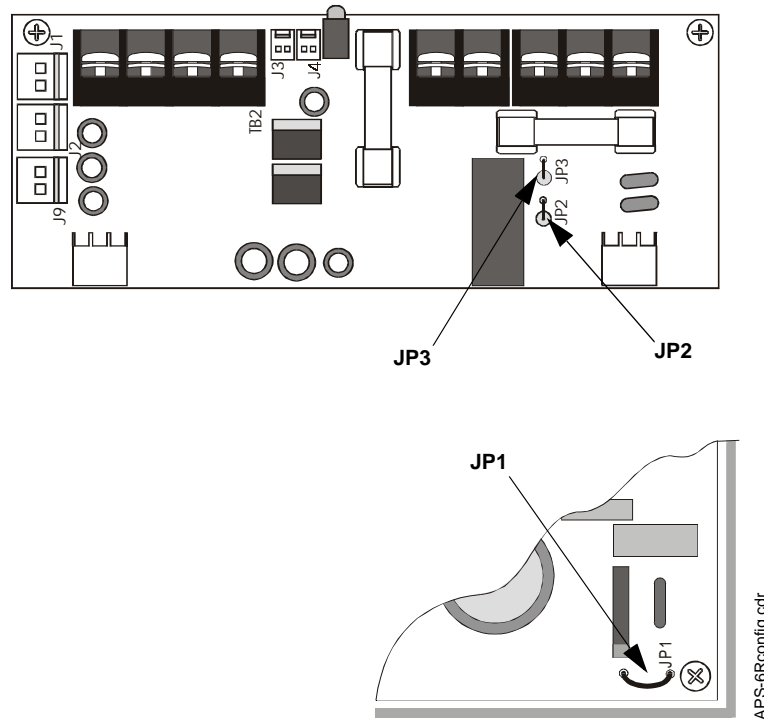

Figure 10 Configuring the ADT-APS-6R

Servicing the ADT-APS-6R

The only serviceable components on the ADT-APS-6R are fuses F1 and F2. If a fuse fails, replace it with a fuse of the same type and rating:

- **F1** AC protection - 4A, 3 AG
- **F2** Battery protection - 10A, 3 AG

To replace either fuse remove the vertical PC board as follows:

1. Turn off and remove all power sources.
2. Remove plastic cover.
3. Remove the two retaining screws securing vertical board.
4. Unplug the vertical PC board from the connectors.
5. Replace fuses as required.
6. Reinstall board in reverse order, install plastic cover and connect all power.

The figure below illustrates the location of the fuses.

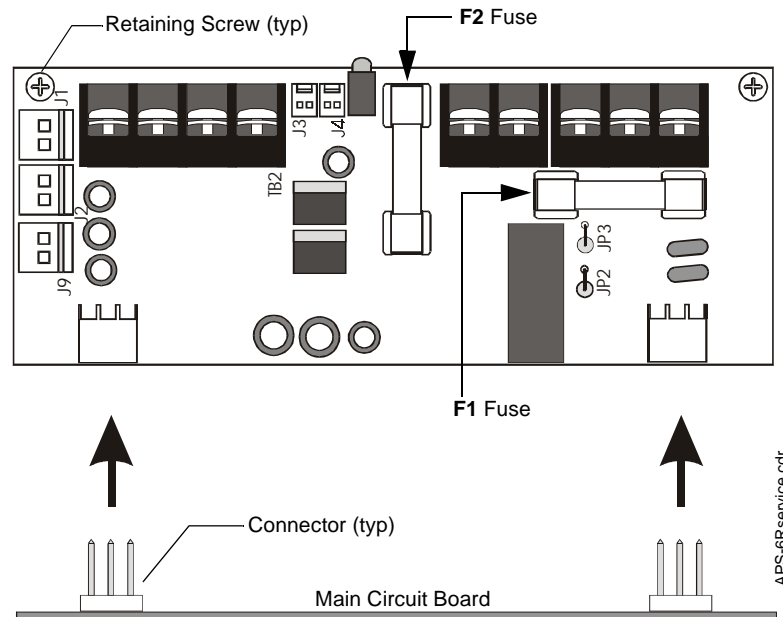
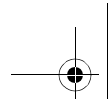

Figure 11 Servicing the ADT-APS-6R



2. Installation

Servicing the ADT-APS-6R

NOTES

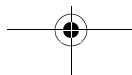
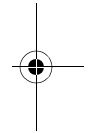
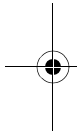

Appendix A - Unimode 4-16

Connecting the ADT-APS-6R to an MPS-24B

Make the following connections as shown in the figure below.

- Connect primary power from **TB1** to MPS-24B terminal block **TB1**, Pin **3**(NEUT) and Pin **4**(HOT)
- Connect secondary power from **TB3** to MPS-24B terminal block **TB3**, Pin **1**(+) and Pin **2**(-)
- Connect trouble input from **J3** to MPS-24B terminal block **P4**

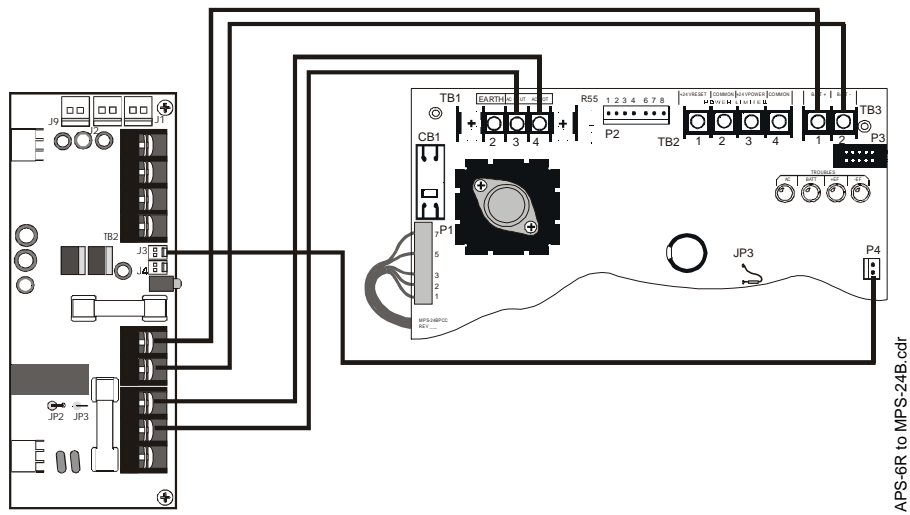
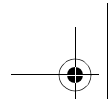

Figure 12 Wiring to MPS-24B

APS-6R to MPS-24B.cdr



Appendix A - Unimode 4-16

Connecting the ADT-APS-6R to an MPS-24B

NOTES

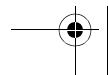
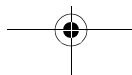
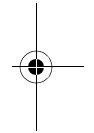
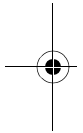

Appendix B - Unimode 300/400

Connecting the ADT-APS-6R to an MPS-400

Make the following connections as shown in the figure below.

- Connect primary power from **TB1** to MPS-400 terminal block **TB1** (NEU and HOT)
- Connect secondary power from **TB3** to MPS-400 terminal block **TB1** (+ and -)
- Connect trouble input from **J3** to MPS-400 terminal block **J4**

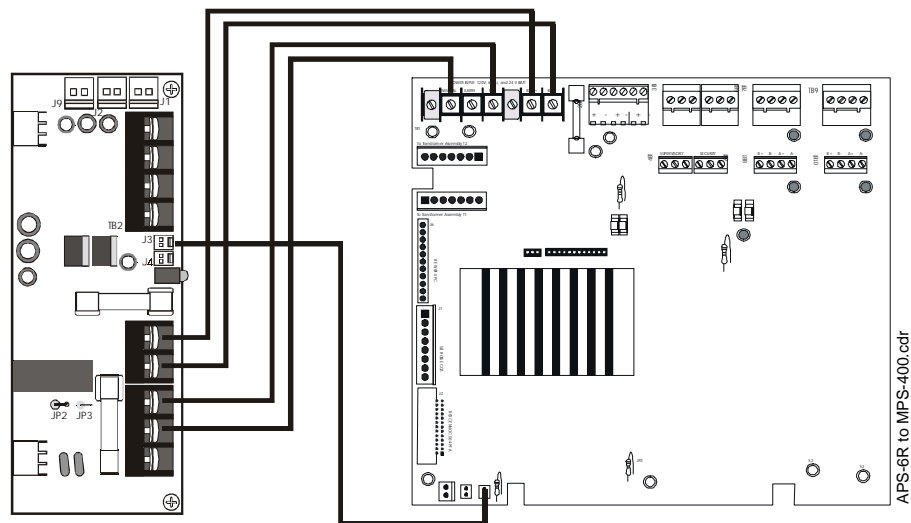
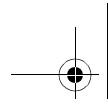

Figure 13 Wiring to MPS-400



Appendix B - Unimode 300/400

Connecting the ADT-APS-6R to an MPS-400

NOTES

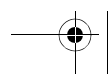
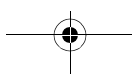
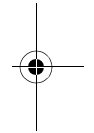
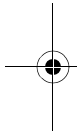

Appendix C - Unimode II & Unimode 2020

Connecting the ADT-APS-6R to an MPS-24A

Make the following connections as shown in the figure below.

- Connect primary power from **TB1** to MPS-24A terminal block **TB1**, Pin 5(NEUT) and Pin 7(HOT)
- Connect secondary power from **TB3** to MPS-24A terminal block **TB2**, Pin 1(+) and Pin 2(-)
- Connect trouble input from **J3** to MPS-24A terminal block **P5**

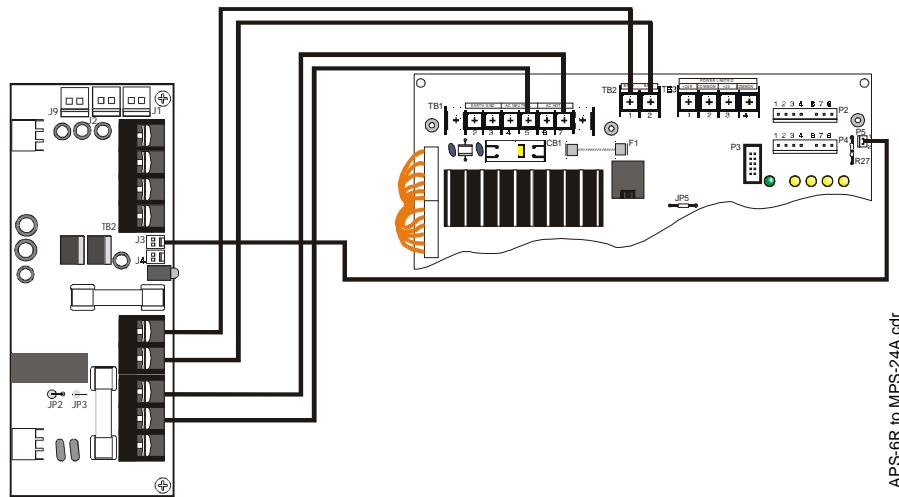

Figure 14 Wiring to MPS-24A

Appendix C - Unimode II & Unimode 2020 *Connecting the ADT-APS-6R to an MPS-24B*

Connecting the ADT-APS-6R to an MPS-24B

Make the following connections as shown in the figure below.

- Connect primary power from **TB1** to MPS-24B terminal block **TB1**, Pin **3**(NEUT) and Pin **4**(HOT)
- Connect secondary power from **TB3** to MPS-24B terminal block **TB3**, Pin **1**(+) and Pin **2**(-)
- Connect trouble input from **J3** to MPS-24B terminal block **P4**

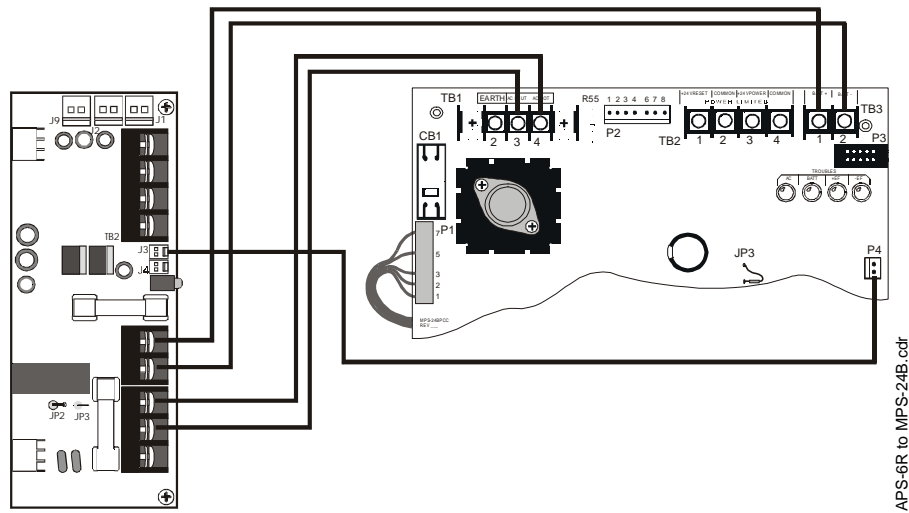

Figure 15 Wiring to MPS-24B

Index

Numerics

16-hour delay 16
240 VAC
 operation 16
 use of 10, 11
8-hour delay 16

A

AC protection 17
ADT-CAB-3 Series cabinet 11
ADT-CAB-400AA 10
ADT-UZC-256 12

B

backbox 10
Battery protection 17

C

cable 13
chassis 11
 mounting 11
CHS-4 11
CHS-4L 11
configuring 16
connections
 MPS-24A 23
 MPS-24B 24
 MPS-24BPCA 19
 MPS-400 21

Control Modules 5

D

document sources, list of 5

E

Earth Ground 12
Electrical Specifications 7

F

features of the APS-6R 6
field wiring 12
fuses 17

H

High Voltage Warning 9

I

ICM/ICE-4 12, 14
 connections to 14
Installation topics 9
internal modules 12

J

J1 connection 12
J2 connection 12
J3 connection 13
J4 connection 13
J9 connection 12
JP1 jumper 10, 11, 16
JP2 jumper 16
JP3 jumper 16
jumpers, location of 16

M

M300CADT Module, connections to 15
Mechanical Specifications 7
MPS-24A 23
MPS-24B 19, 24
MPS-400 21
multiple power supplies 13

N

NAC Modules 5
NACs 14
Non Power-limited circuit 12

O

Output Circuit
 Non Power-limited 12
 Power-limited 12

P

PC board, vertical 17
Power-limited circuit 12
Primary Power 12
primary power 19, 21, 23, 24

Index

S

Secondary Power 12
secondary power 19, 21, 23, 24
serviceable components 17
Specifications 7
standoff 10, 11

T

TB2 12
terminal block cover 12
Trouble Bus 12
trouble connectors 13
trouble input 19, 21, 23, 24

U

Unimode 300/400 21
Unimode 4-16 19
Unimode II 23
Unimode2020 23

W

Warning, High Voltage 9
wiring 12

X

XP Transponder 5
XPC-8 12

Free Manuals Download Website

<http://myh66.com>

<http://usermanuals.us>

<http://www.somanuals.com>

<http://www.4manuals.cc>

<http://www.manual-lib.com>

<http://www.404manual.com>

<http://www.luxmanual.com>

<http://aubethermostatmanual.com>

Golf course search by state

<http://golfingnear.com>

Email search by domain

<http://emailbydomain.com>

Auto manuals search

<http://auto.somanuals.com>

TV manuals search

<http://tv.somanuals.com>