



**TSU 600
&
TSU 600e
User Manual**

**Part Numbers
1202076L1
1202076L1#DC
1202076L2
1202076L2#DC**

**October 1998
61202076L1-1C**

Trademarks:

Windows is a registered trademark of Microsoft Corp.

T-Watch is a trademark of ADTRAN, Inc.

SLC96 is a registered trademark of AT&T



901 Explorer Boulevard
P.O. Box 140000
Huntsville, AL 35814-4000
Phone: (256) 963-8000

© 1998 ADTRAN, Inc.
All rights reserved.
Printed in USA.

YEAR 2000 Compliance

All ADTRAN transmission hardware and software products have been tested and found to be fully compliant with the YEAR 2000 requirements. This is true for all models and revisions regardless of the date of manufacture or delivery.

Users who wish to independently verify that specific products are in compliance may contact ADTRAN Technical Support at **1-888-423-8726** for additional information

FCC REGULATIONS REQUIRE THAT THE FOLLOWING INFORMATION BE PROVIDED TO THE CUSTOMER IN THIS MANUAL

1. This equipment complies with Part 68 of the FCC rules. The required label is attached to the bottom of the chassis.
2. An FCC compliant telephone cord and modular plug is provided with this equipment. This equipment is designed to be connected to the telephone network or premises wiring using a compatible modular jack which is Part 68 compliant. See installation instructions for details.
3. If your Product causes harm to the telephone network, the Telephone Company may discontinue your service temporarily. If possible, they will notify you in advance. If advance notice is not practical, you will be notified as soon as possible. You will be advised of your right to file a complaint with the FCC.
4. Your telephone company may make changes in its facilities, equipment, operations, or procedures that could affect the proper operation of your equipment. If they do, you will be given advance notice so as to give you an opportunity to maintain uninterrupted service.
5. If you experience trouble with the equipment Product, please contact ADTRAN at (256) 963-8000 for repair/warranty information. The telephone company may ask you to disconnect this equipment from the network until the problem has been corrected, or until you are sure the equipment is not malfunctioning.
6. This unit contains no user serviceable parts.
7. The following information may be required when applying to your local telephone company for leased line facilities.

Service Type	REN/SOC	FIC	USOC
1.544 Mbps -SF	6.0N	04DU9-BN	RJ-48C
1.544 Mbps - SF and B8ZS	6.0N	04DU9-DN	RJ-48C
1.544 Mbps - ESF	6.0N	04DU9-1KN	RJ-48C
1.544 Mbps - ESF and B8ZS	6.0N	04DU9-1SN	RJ-48C

FEDERAL COMMUNICATIONS COMMISSION RADIO FREQUENCY
INTERFERENCE STATEMENT

This equipment has been tested and found to comply with the limits for a Class A digital device, pursuant to Part 15 of the FCC Rules. These limits are designed to provide reasonable protection against harmful interference when the equipment is operated in a commercial environment. This equipment generates, uses, and can radiate radio frequency energy and, if not installed and used in accordance with the instruction manual, may cause harmful interference to radio frequencies. Operation of this equipment in a residential area is likely to cause harmful interference in which case the user will be required to correct the interference at his own expense.

Shielded cables must be used with this unit to ensure compliance with Class A FCC limits.

WARNING

Changes or modifications to this unit not expressly approved by the party responsible for compliance could void the user's authority to operate the equipment.

CANADIAN EMISSIONS REQUIREMENTS

This digital apparatus does not exceed the Class A limits for radio noise emissions from digital apparatus as set out in the interference-causing equipment standard entitled "Digital Apparatus," ICES-003 of the Department of Communications.

Cet appareil numérique respecte les limites de bruits radioélectriques applicables aux appareils numériques de Class A prescrites dans la norme sur le matériel brouilleur: "Appareils Numériques," NMB-003 édictée par le ministre des Communications.

CANADIAN EQUIPMENT LIMITATIONS

WARNING

The Industry Canada Certification label identifies certified equipment. This certification means that the equipment meets certain telecommunications network protective, operational, and safety requirements. The Department does not guarantee the equipment will operate to the user's satisfaction.

Before installing this equipment, users should ensure that it is permissible to be connected to the facilities of the local telecommunications company. The equipment must also be installed using an acceptable method of connection. In some cases, the company's inside wiring associated with a single line individual service may be extended by means of a certified connector assembly (telephone extension cord). The customer should be aware that compliance with the above conditions may not prevent degradation of service in some situations.

Repairs to certified equipment should be made by an authorized Canadian maintenance facility designated by the supplier. Any repairs or alterations made by the user to this equipment, or equipment malfunctions, may give the telecommunications company cause to request the user to disconnect the equipment.

Users should ensure for their own protection that the electrical ground connections of the power utility, telephone lines and internal metallic waterpipe system, if present, are connected together. This precaution may be particularly important in rural areas.



Users should not attempt to make such connections themselves, but should contact the appropriate electric inspection authority, or an electrician, as appropriate.

The Load Number (LN) assigned to each terminal device denotes the percentage of the total load to be connected to a telephone loop which is used by the device, to prevent overloading. The termination on a loop may consist of any combination of devices subject only to the equipment that the total of the LNs of all devices does not exceed 100.

The ringer equivalence number (REN) assigned to each terminal adapter is used to determine the total number of devices that may be connected to each circuit. The sum of the RENs from all devices in the circuit should not exceed a total of 5.0.

**AFFIDAVIT REQUIREMENTS FOR CONNECTION
TO DIGITAL SERVICES**

- An affidavit is required to be given to the telephone company whenever digital terminal equipment without encoded analog content and billing protection is used to transmit digital signals containing encoded analog content which are intended for eventual conversion into voiceband analog signals and transmitted on the network.
- The affidavit shall affirm that either no encoded analog content or billing information is being transmitted or that the output of the device meets Part 68 encoded analog content or billing protection specifications.
- End user/customer will be responsible to file an affidavit with the local exchange carrier when connecting unprotected CPE to a 1.544 Mbps or subrate digital services.
- Until such time as subrate digital terminal equipment is registered for voice applications, the affidavit requirement for subrate services is waived.

**AFFIDAVIT FOR CONNECTION OF CUSTOMER PREMISES
EQUIPMENT TO 1.544 MBPS AND/OR SUBRATE DIGITAL SERVICES**

For the work to be performed in the certified territory of
_____ (telco name)

State of _____

County of _____

I, _____ (name),

(business address), _____ (telephone number) being
duly sworn, state:

I have responsibility for the operation and maintenance of the terminal equipment to be connected to 1.544 Mbps and/or _____ subrate digital services. The terminal equipment to be connected complies with Part 68 of the FCC rules except for the encoded analog content and billing protection specifications. With respect to encoded analog content and billing protection:

I attest that all operations associated with the establishment, maintenance, and adjustment of the digital CPE with respect to analog content and encoded billing protection information continuously complies with Part 68 of the FCC Rules and Regulations.

The digital CPE does not transmit digital signals containing encoded analog content or billing information which is intended to be decoded within the telecommunications network.

The encoded analog content and billing protection is factory set and is not under the control of the customer.

I attest that the operator(s)/maintainer(s) of the digital CPE responsible for the establishment, maintenance, and adjustment of the encoded analog content and billing information has (have) been trained to perform these functions by successfully having completed one of the following (check appropriate blocks):

A. A training course provided by the manufacturer/grantee of the equipment used to encode analog signals; or

() B. A training course provided by the customer or authorized representative, using training materials and instructions provided by the manufacturer/grantee of the equipment used to encode analog signals; or

() C. An independent training course (e.g., trade school or technical institution) recognized by the manufacturer/grantee of the equipment used to encode analog signals; or

() D. In lieu of the preceding training requirements, the operator(s)/maintainer(s) is (are) under the control of a supervisor trained in accordance with _____ (circle one) above.

I agree to provide _____ (telco's name) with proper documentation to demonstrate compliance with the information as provided in the preceding paragraph, if so requested.

_____ Signature

_____ Title

_____ Date

Transcribed and sworn to before me

This _____ day of _____, 199____

Notary Public

My commission expires:

IMPORTANT SAFETY INSTRUCTIONS

When using your telephone equipment, please follow these basic safety precautions to reduce the risk of fire, electrical shock, or personal injury:

- 1 Do not use this product near water, such as near a bath tub, wash bowl, kitchen sink, laundry tub, in a wet basement, or near a swimming pool.
- 2 Avoid using a telephone (other than a cordless-type) during an electrical storm. There is a remote risk of shock from lightning.
- 3 Do not use the telephone to report a gas leak in the vicinity of the leak.
- 4 Use only the power cord, power supply, and/or batteries indicated in the manual. Do not dispose of batteries in a fire. They may explode. Check with local codes for special disposal instructions.

SAVE THESE INSTRUCTIONS

Warranty and Customer Service

ADTRAN will replace or repair this product within five years from the date of shipment if the product does not meet its published specifications or if it fails while in service. For detailed warranty, repair, and return information refer to the ADTRAN Equipment Warranty and Repair and Return Policy Procedure.

Return Material Authorization (RMA) is required prior to returning equipment to ADTRAN.

For Service, RMA requests, or more information, contact ADTRAN Customer Service listed on the inside back cover of this manual.

Table of Contents

Chapter 1 Introduction	1-1
TSU 600 Overview	1-1
Product Description	1-1
Standard Features in the TSU 600.....	1-2
TSU Option Modules.....	1-3
Option Module Architecture.....	1-4
TSU 600 Configuration Applications	1-5
Router, PBX, Video Conferencing Application.....	1-5
Drop and Insert, Voice, and Router Application.....	1-6
Chapter 2 Installation	2-1
Unpack, Inspect, Power Up	2-1
Receipt Inspection.....	2-1
ADTRAN Shipments Include.....	2-1
Customer Provides.....	2-1
Power Connection.....	2-2
DC Powered Units	2-2
Backup Power Supply (600e only)	2-2
Installing and Replacing the Power Supply	2-3
Grounding Instructions	2-4
Identification of Rear Panel Layout	2-5
TSU 600 Interfaces.....	2-9
Network Interface	2-9
Network Test Interface	2-9
Control Port Input	2-9
Chain Port Output	2-9
10BaseT Interface (600e only)	2-10
Option Slot Arrangement.....	2-10
Power-up Testing	2-11
Self-Test	2-11
Board level tests	2-12
Unit level tests	2-12
Initialization	2-12

Table of Contents

Set User Passcode	2-12
Set Unit Identification	2-12
Set Control Port	2-13
Chain-In (PC)	2-13
Chain In/Chain Out	2-13
Normal Power-Up Procedure.....	2-14
Chapter 3 Operation	3-1
Front Panel	3-1
CSU Status LEDs	3-2
Module Status LEDs	3-3
Operation Keys	3-5
General Menu Operation	3-5
Selecting and Activating a Menu Item	3-6
Editing the Data Field	3-7
Display Only Data Fields	3-8
Exit Any Menu Field Operation Or Display	3-8
Data Port Identification	3-9
Front Panel Menu Structure.....	3-10
Alternate Methods of Control.....	3-11
T-Watch PRO (ADTRAN PC Program)	3-11
T-Watch PRO/LAN Connection	3-11
T-Watch PRO/EIA-232 Connection	3-12
SNMP	3-12
Terminal Mode Connection	3-13
Telnet Connection	3-13
Chapter 4 Status Menu	4-1
Network Performance Reports (NI PERF RPTS).....	4-2
Network Interface Errors (NI ERRORS)	4-3
Active Alarms	4-4
View History	4-4
Port Status.....	4-5
Remote Port.....	4-5
Clear Port Alarm.....	4-5
ENET Status (600e only).....	4-6
PS Status (600e only).....	4-6
Chapter 5 Configuration Menu	5-1
Network (NI)	5-2
Network (NI) Menu Items	5-2
TSU 600 Clock Sources	5-4
Network Timing	5-4
DTE Timing	5-5
U-BR1TE (Slot 1)	5-5

Internal Timing	5-6
Secondary Timing	5-7
Normal (CSU) Timing	5-8
Unit Menu	5-9
Map Exchange (Map Xchg) Menu	5-11
MAP In Use: A(B) Menu	5-11
DS0 Map A and DS0 Map B Menu	5-12
Create Temp Example	5-13
Port Configuration (Port Config)	5-15
Chapter 6 Utility Menu	6-1
Time/Date	6-2
Factory Restore	6-2
Set Passcode	6-2
Enter Passcode from Other Menus	6-2
Change/Set a Passcode	6-3
Automatic Time-out Feature	6-3
No Passcode Desired	6-3
Unit ID	6-3
Setting the Unit Identification	6-4
No Unit ID Desired	6-4
Software Revision (Software Rev)	6-4
Port Utility	6-4
ENET Address (600e only)	6-4
CMD Mode	6-4
Chapter 7 Test Menu	7-1
Network Tests	7-2
Loopback Tests	7-2
Network Interface Loopbacks	7-3
Local Loopbck	7-3
Remote Loopbk	7-4
Test Pattern	7-5
QRSS Pattern	7-5
Pattern Result	7-6
Run Self-Test	7-7
Board level tests	7-7
Unit level tests	7-7
Port Tests	7-8
Cancel Tests	7-8
Chapter 8 Telnet/Terminal Menus	8-1
Main Menu	8-1
Status, Config, Util, and Test Menu Options	8-2
DS0 Maps Configuration Menu	8-2

Table of Contents

Initializing the Temp Map	8-3
Editing the Temp Map	8-4
Applying the Temp Map	8-4
Reviewing Maps.....	8-4
Remote Menu Access	8-5
Management Configuration.....	8-5
Unit Access Table	8-5
Add New Unit.....	8-6
Modify Unit	8-6
Delete Unit	8-6
Default Unit Passcode	8-7
OK	8-7
SNMP Read Community.....	8-7
SNMP Read/Write Community	8-7
SNMP Trap Community	8-8
System Name	8-8
System Contact	8-8
System Location	8-8
Auto. Fail Traps Sent	8-9
Poll Link Status Traps Sent	8-9
Ping IP Host	8-9
Telnet/Terminal Time-out	8-9
Telnet/Terminal Password	8-9
Exit	8-9
Flash Download.....	8-9
Quit Session.....	8-9
Appendix A Understanding SNMP	A-1
Appendix B Understanding TR-08.....	B-1
Appendix C Network Pinouts.....	C-1
Appendix D System Messages.....	D-1
Appendix E Specifications.....	E-1
Index.....	Index-1

List of Figures

Figure 1-1. TSU 600 Option Modules	1-4
Figure 1-2. Router, PBX, Video Conferencing Application Set Up	1-5
Figure 1-3. Drop and Insert, Voice, and Router Application Set Up	1-6
Figure 2-1a. TSU 600 Rear Panel	2-5
Figure 2-1b. TSU 600 with DC Power Rear Panel.....	2-6
Figure 2-1c. TSU 600e Rear Panel.....	2-7
Figure 2-1d. TSU 600e with DC Power Rear Panel.....	2-8
Figure 2-2. TSU 600 Interfaces	2-9
Figure 2-3. TSU 600 Slot Designation (Rear View)	2-10
Figure 2-4. Example of Chain In.....	2-13
Figure 3-1. TSU 600 Front Panel Layout	3-4
Figure 3-2. Example of Basic Front Panel Menu Travel.....	3-6
Figure 3-3. Display and Data Fields.....	3-8
Figure 3-4. Module Slots, TSU 600	3-9
Figure 4-1. Complete Status Menu.....	4-1
Figure 4-2. Network Interface Performance Report	4-2
Figure 4-3. Display of Alarm Messages	4-4
Figure 5-1. Configuration Menu.....	5-1
Figure 5-2. Network Timed Clock Source.....	5-4
Figure 5-3. DTE Timed Clock Source	5-5
Figure 5-4. Internal Clock Source	5-6
Figure 5-5. Secondary Clock Source	5-7
Figure 5-6. Normal (CSU).....	5-8
Figure 5-7. DS0 Map Designations.....	5-12
Figure 5-8. Create Temp Selection Screen.....	5-14
Figure 6-1. Utility Menu Tree	6-1
Figure 7-1. Test Menu	7-1
Figure 7-2. Network Loopback Tests.....	7-3
Figure 8-1. Telnet/Terminal Main Menu	8-1
Figure 8-2. DS0 Temp Map	8-2
Figure 8-3. Unit Access Table	8-6

List of Figures

List of Tables

Table B-1. Alarm Conditions	B-2
Table B-2. TR-08 DS0 Conversion Table	B-3
Table C-1. Network Pinouts.....	C-1
Table C-2. Control In/Chain In Pinout	C-2
Table C-3. Chain-Out Pinout	C-3
Table C-4. 10BaseT Ethernet	C-4

List of Tables

TSU 600 OVERVIEW

This manual covers the use of the following products:

- TSU 600
- TSU 600 with DC power
- TSU 600e
- TSU 600e with DC power

Unless otherwise stated, the TSU 600 refers to all four products.

Product Description

The TSU 600 is a T1/FT1 multiplexer with six option slots and embedded SNMP management. The TSU 600's six option slots accept one of many available option modules for voice and data applications. Each module offers up to four ports for a total of 24 possible voice or data ports.

The TSU 600 serves as the link between user data sources such as:

- local area network (LAN) bridges
- routers,
- computers,
- CAD systems,
- teleconferencing equipment, and
- PBXs.

Through the use of multiple data ports, the TSU 600 can simultaneously connect one or more of these devices to a T1 circuit. The amount of bandwidth allocated to each port is custom-programmable. You can manually allocate bandwidth or set the bandwidth to change automatically at predetermined times to use the available bandwidth most advantageously.

Changes in the configuration do not disrupt data flow in channels that are not being reconfigured. The unique architecture and the availability of option modules provides a path for growth to accommodate future requirements.

The TSU 600 offers a wide variety of network management options. You can manage via SNMP through the 10BaseT (600e only) or chain-in ports. If you are using T-Watch PRO, a Microsoft Windows® program, you can manage the TSU 600 via the same 10BaseT (600e only) or chain-in ports. An enhanced VT-100 terminal interface is also provided.

Standard Features in the TSU 600

The standard features of the TSU 600 are listed below:

- A single T1 interface
- Six slots to house option modules with up to four additional data ports, including voice
- Architecture that allows mix of port types to meet the data interface requirements
- Easy configuration capabilities using simplistic menus displayed in a liquid crystal display (LCD) window operated by a front panel keypad
- SNMP, Telnet, and T-Watch PRO management via SLIP or 10BaseT (600e only)
- Ability to proxy for “agentless” units
- Enhanced terminal mode
- Support for a redundant AC power supply (600e only)
- Two programmable configuration maps that define the bandwidth allocation between data ports
- Data drop and insert, as well as full drop and insert
- Flash memory for software updates
- Timing selectable from the network, from the slot 1 data port, internally, or from a secondary interface
- QRSS; 511 test patterns using Nx option
- Fractional T1 loopbacks as defined in annex B of ANSI T1.403-1995
- Extensive self-testing and monitoring to ensure proper operation

TSU Option Modules

Module Name	Description
DSX1	Short haul T1 interface for operation with a PBX (Terminal Interface).
Full Drop and Insert	Permits the dropping of data and insertion of new data into the same DS0 time slot. This module includes a long haul DS1 interface. It can also be used as a second DS1 interface to provide up to 3 MB aggregate throughput.
Nx56/64 Serial Interface	Provides a V.35 serial interface in either single or dual versions.
NxIQ	Frame-relay aware device that provides detailed information regarding the health and performance of the frame relay circuit.
Voice Interface	2/4 channel FXS/FX0/E&M.
OCU DP	Interfaces to DDS or 4-wire Switched-56.
DSU DP	Provides two sync or async ports (232 or V.35).
Dial Backup	Allows for backup of data upon network T1 failure.
U-BR1TE	Allows ISDN lines to be extended over a T1 line.

Option Module Architecture

The TSU 600 features a unique architecture that allows the addition of six option modules and plug-on boards, providing an opportunity for growth to accommodate many applications. See *Figure 1-1*. This unique approach allows you to mix interface types to meet any application.

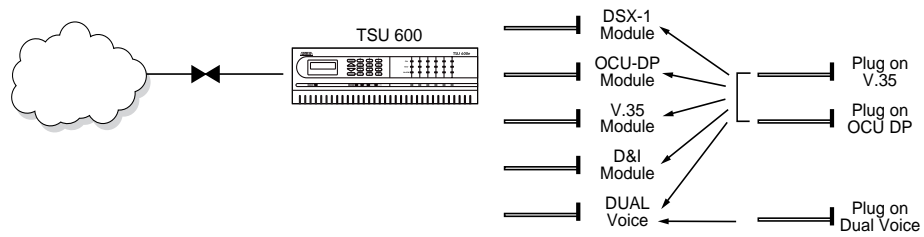

Figure 1-1. TSU 600 Option Modules

TSU 600 CONFIGURATION APPLICATIONS

The following examples illustrate possible configurations of TSU 600 applications.

Router, PBX, Video Conferencing Application

In this application, an Nx54/64 module provides a V.35 interface to a router. The PBX is interfaced to the TSU 600 with the DSX-1 module. An OCU DP module and OCU DP plug-on board provide two switched 56 circuits for video conferencing. The SLIP port or 10BaseT port (600e only) allows SNMP network management over the LAN. See *Figure 1-2*.

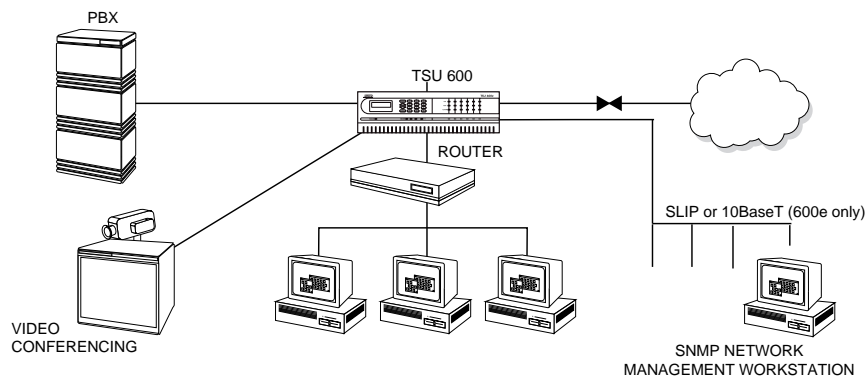

Figure 1-2. Router, PBX, Video Conferencing Application Set Up

Drop and Insert, Voice, and Router Application

The TSU 600 provides a router interface with an Nx56/64 module. A drop and insert module provides a second T1 interface to a remote TSU. T-WATCH PRO (which runs on a PC) easily manages the network. FXO modules are used to provide PBX extensions to remote sites. See *Figure 1-3*.

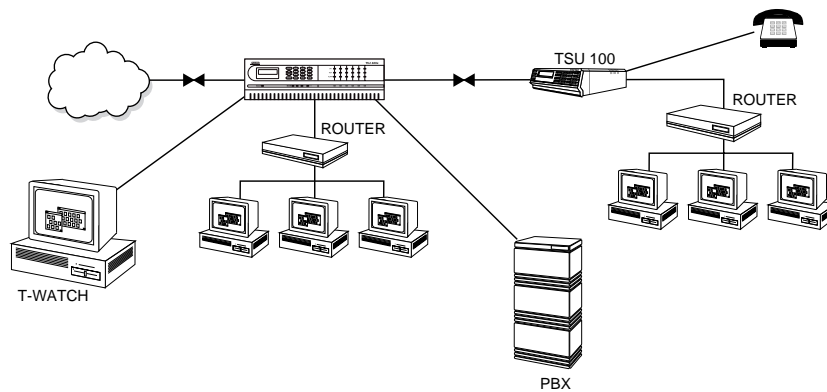

Figure 1-3. Drop and Insert, Voice, and Router Application Set Up

UNPACK, INSPECT, POWER UP**Receipt Inspection**

Carefully inspect the TSU 600 for shipping damages. If you suspect damage, file a claim immediately with the carrier and then contact ADTRAN Customer Service (see the inside last page of this manual). If possible, keep the original shipping container for use in shipping the TSU 600 back for repair or for verification of damage during shipment.

ADTRAN Shipments Include

- The TSU 600
- A line interface cable: an 8-position modular to 8-position modular (15 ft.)
- A DB-25 to modular adapter
- An 8-position, 6-foot modular cable for the Chain-In port connection
- The User Manual
- Rackmount Brackets
- Rackmount Data Sheet

Customer Provides

- Cables for any expansion modules to be used with the TSU 600
- 10BaseT cable for connection to a LAN or router (if you plan to use remote management features). This is for 600e only.

Power Connection

The AC- powered TSU 600 is equipped with a captive, 8-foot power cord, terminated by a 3-prong plug which connects to a grounded power receptacle.



Power to the TSU 600 must be from a grounded 90-120 VAC, 50/60Hz source.

DC Powered Units

The DC-powered TSU 600 (1202076L1#DC or 1202076L2#DC) is equipped with a terminal strip on the rear of the unit. The power source should be connected to the terminal strip according to the polarity markings on the unit.

Example:

A -48V source would be connected with the -48V return attached to the (+) terminal and the -48VDC attached to the (-) terminal. Power must be from a DC source in the range of 21 to 26 VDC or in the range of 40 to 56VDC.

The protective cover should be reinstalled over the terminal strip once the power source is connected.

The DC-powered TSU 600 is to be installed only in restricted areas (dedicated equipment rooms, equipment closets, etc.) in accordance with Articles 110-16 and 110-18 of the National Electric Code, ANSI/NFPA 70.

Backup Power Supply (600e only)

The TSU 600e has two power supply slots on the right side of the chassis. The base unit is shipped with a single power supply. The TSU 600e is fully operational with only a single power supply, which may be installed on either the left (power supply A) or the right (power supply B). You can install a backup supply in the unused slot. The red System Alarm LED on the front panel will indicate failure of either supply.

Installing and Replacing the Power Supply

The following steps show how to install a new supply or replace a failed supply.



Power does not have to be turned off on a working supply to add a new supply or replace a failed one.

Step	Action
1	<p><i>One Power Supply</i> If only one supply is installed in the chassis, remove the blank panel covering the unused power supply slot.</p> <p><i>Two Power Supplies</i> If two power supplies are installed, the failed supply can be identified by the alarm on the front panel LCD. The alarm message will identify a failure on Power Supply A or Power Supply B. The option slot legend on the rear panel shows the location of each power supply. Turn the power switch to Off on the failed supply and unplug the power cord from the power source.</p>
2	Remove the two screws that secure the power supply module to the TSU 600e chassis and remove the failed power supply module.
3	Remove the new power supply from the shipping container. Make sure the power switch is in the Off position.
4	Plug the new supply into the open power supply slot and install the two screws on the power supply module
5	Plug the new power supply cord into a grounded 115 VAC, 50/60 Hz power receptable.
6	Turn the power switch On .

GROUNDING INSTRUCTIONS

The grounding instruction information is from the Underwriters' *Laboratory UL 1950, 3rd Edition*.

An equipment grounding conductor that is not smaller in size than the ungrounded branch-circuit supply conductors is to be installed as part of the circuit that supplies the product or system.

- Bare, covered, or insulated grounding conductors are acceptable.
- Individually covered or insulated equipment grounding conductors shall have a continuous outer finish that is either green, or green with one or more yellow stripes.
- The equipment grounding conductor is to be connected to ground at the service equipment.
- The attachment-plug receptacles in the vicinity of the product or system are all to be of a grounding type.
- The equipment grounding conductors serving these receptacles are to be connected to earth ground at the service equipment.
- A supplementary equipment grounding conductor shall be installed between the product or system and ground that is in addition to the equipment grounding conductor in the power-supply cord.
- The supplementary equipment grounding conductor shall not be smaller in size than the ungrounded branch-circuit supply conductors.
- The supplementary equipment grounding conductor shall be connected to the product at the terminal provided, and shall be connected to ground in a manner that will retain the ground connection when the product is unplugged from the receptacle.
- The connection to ground of the supplementary equipment grounding conductor shall be in compliance with the rules for terminating bonding jumpers at Part K or Article 250 of the National Electrical Code, ANSI/NFPA 70.
- Termination of the supplementary equipment grounding conductor is permitted to be made to building steel, to a metal electrical raceway system, or to any grounded item that is permanently and reliably connected to the electrical service equipment ground.
- The supplemental grounding conductor shall be connected to the equipment using a number 8 ring terminal.
- The terminal should be fastened to the grounding lug provided on the rear panel of the equipment.
- The ring terminal should be installed using the appropriate crimping tool (AMP P/N 59250 T-EAD Crimping Tool or equivalent).

IDENTIFICATION OF REAR PANEL LAYOUT

Figures 2-1a, Figure 2-1b, Figure 2-1c, and Figure 2-1d show the configuration for the rear panels of the TSU 600, TSU 600 with DC Power, TSU 600e, and TSU 600e with DC power.

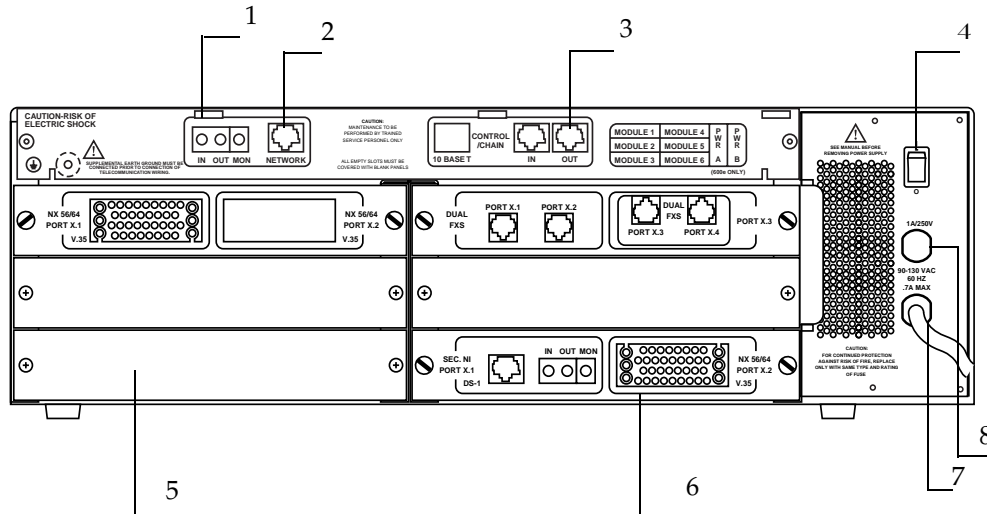

1	T1 Monitor/Test Jacks
2	T1 Network Connection
3	Control In/Out Connection
4	Power Switch
5	Blank panel covering an unused option slot
6	Example of option modules installed
7	Power Cord
8	1A/250V Fuse

Figure 2-1a. TSU 600 Rear Panel

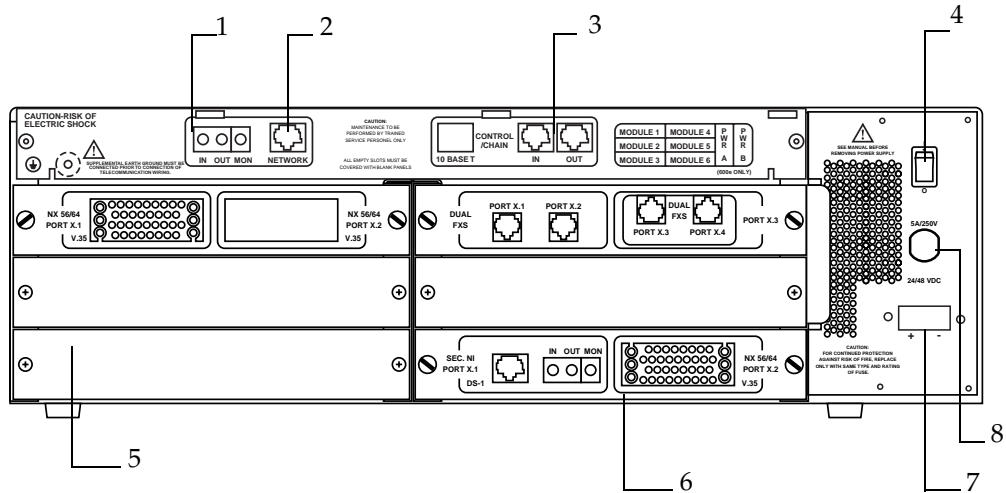

1	T1 Monitor/Test Jacks
2	T1 Network Connection
3	Control In/Out Connection
4	Power Switch
5	Blank panel covering an unused option slot
6	Example of option modules installed
7	Power Input Terminals
8	5A/250V Fuse

Figure 2-1b. TSU 600 with DC Power Rear Panel

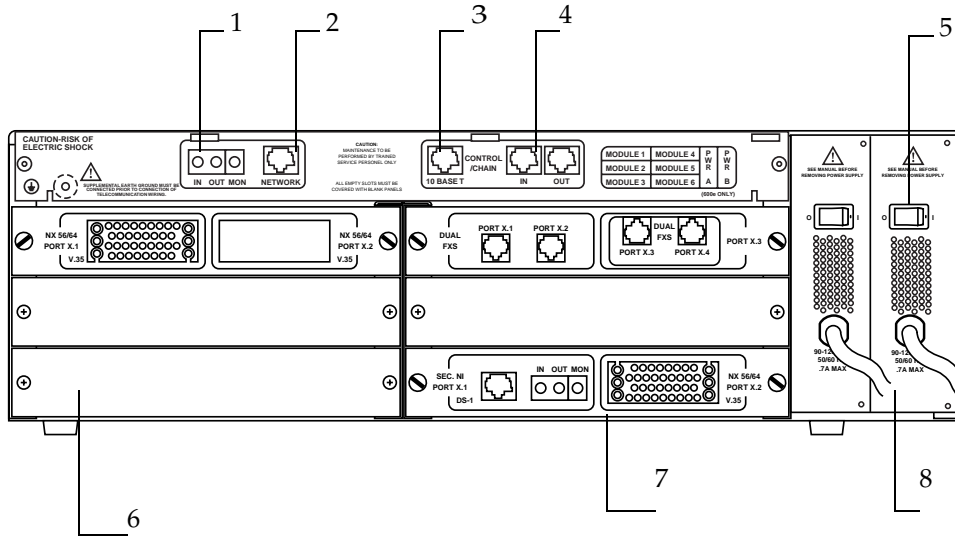

1	T1 Monitor/Test Jacks
2	T1 Network Connection
3	10BaseT Connection
4	Control In/Out Connection
5	Power Switch
6	Blank panel covering an unused option slot
7	Example of option modules installed
8	Power Supply B (if installed)

Figure 2-1c. TSU 600e Rear Panel

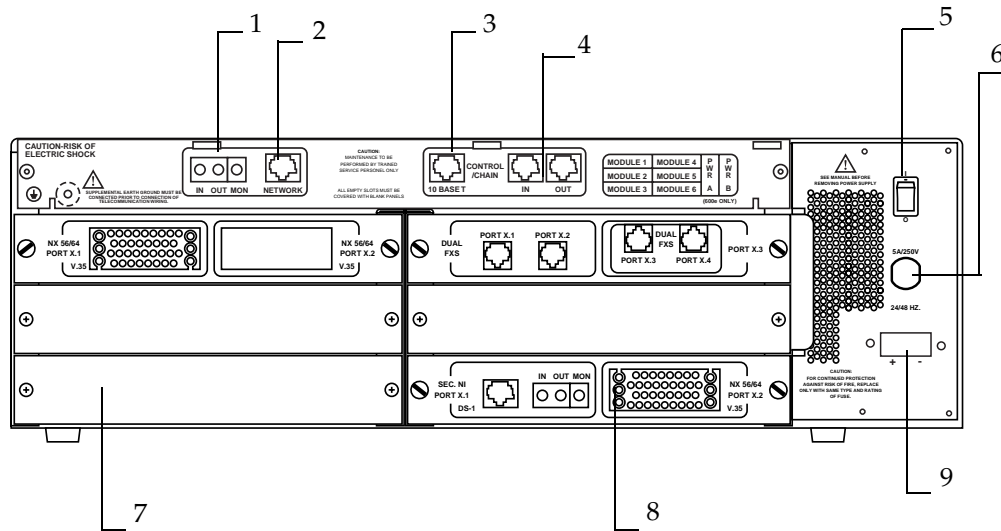

1	T1 Monitor/Test Jacks
2	T1 Network Connection
3	10BaseT Connection
4	Control In/Out Connection
5	Power Switch
6	5A/250V Fuse
7	Blank panel covering an unused option slot
8	Example of option modules installed
9	Power Input Terminals

Figure 2-1d. TSU 600e with DC Power Rear Panel

TSU 600 Interfaces

The TSU 600 is equipped with six option slots, management interfaces, and a T1 interface, in the rear panel. See *Figure 2-2*.

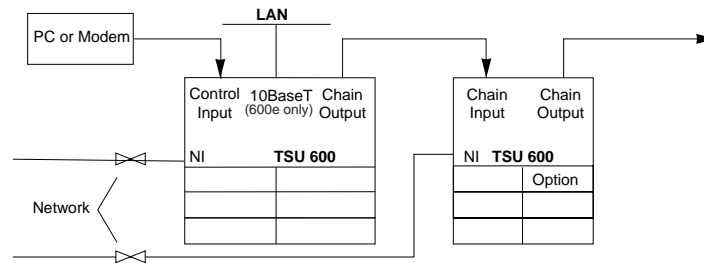

Figure 2-2. TSU 600 Interfaces

Network Interface

The network interface (NI) port provides the connection to the T1. This port complies with the applicable ANSI and AT&T standards. For more information, see *Wiring* on page B-1.

Network Test Interface

The IN and OUT **test jacks** for the network interface provide intrusive test capability for the incoming T1. By connecting to these jacks with test equipment, the T1 connection will be broken, and the test equipment will terminate the incoming T1. The **MON test jack** provides a bridged access jack for non-intrusive monitoring of the incoming T1. When connected to this jack, the test equipment should be configured for a bridged termination.

Control Port Input

The control port input provides an EIA-232 input from a PC or a modem for control of the TSU 600. You can also use it as a chain input from another TSU 600 or TSU 100. For more information, see *Wiring* on page C-1.

Chain Port Output

The chain port output provides an EIA-232 output to chain control to other TSUs. For more information, see *Wiring* on page C-1.

10BaseT Interface (600e only)

The 10BaseT interface provides the LAN interface for managing the TSU 600e with SNMP or T-watch PRO. For more information, see *Wiring* on page C-1.

Option Slot Arrangement

As viewed from the rear of the TSU 600, the slots are numbered as shown in Figure 2-3. All slots are functionally identical except slots one, two, and six. These slots offer additional functions.

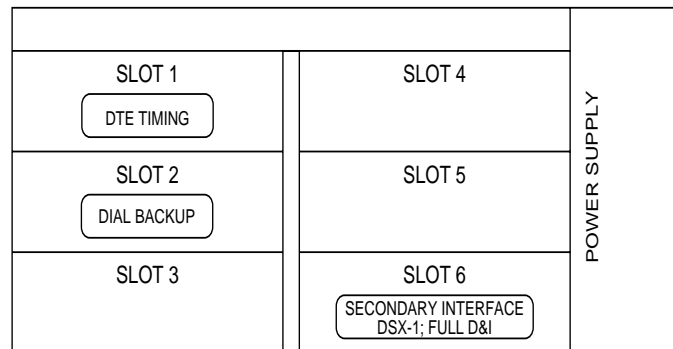



Figure 2-3. TSU 600 Slot Designation (Rear View)

- Slot 1** Slot 1 is used as the source of DTE timing when the DTE timing mode is selected or as the source of UBR1TE timing when the UBR1TE timing mode is selected. If DTE timing is desired, the DTE interface port sourcing the timing must be connected to Slot 1. This slot will accept all other interface types except Secondary Network interface option modules, including DSX-1 (PBX), the Full Drop and Insert (D&I) network interface, or the multiport Dial Backup (DBU).
- Slot 2** Slot 2 is used for the multiport Dial Backup module if it is installed. This slot accepts all other interface types except Secondary Network interface option modules, including DSX-1 (PBX) and the Full Drop and Insert (D&I) network interface.

- Slots 3-5** Slots 3-5 will accept any interface type except secondary interface, the interface for DTE timing, or the multipoint DBU. If other interfaces have any restriction on their location, this will be specified in the individual option card manual (provided with the option cards).
- Slot 6** Slot 6 services any option module type including secondary network interface ports (DSX-1 (PBX) and Full D&I), but not the DTE timing source. If a secondary network interface port is to be used, it must be installed in slot 6.

 **NOTE** You can use NxDBU modules in any slot.

Power-up Testing

When shipped from the factory, the TSU 600 is set to factory default conditions. At the first application of power, the unit automatically executes a memory self-test. A full self-test can be run from the front panel, and a passcode and unit ID may be set using the UTIL menu.

Self-Test

Upon a power-up, the LCD displays **Memory Test Now Testing** and the Test LEDs are illuminated.

When . . .	Then . . .
the self-test is complete with no failures detected	the OK LED lights up and the LCD momentarily displays All Tests Passed .
a failure is detected	a list of failures is displayed in the LCD window

The full self-test procedure (invoked from the front panel or T-Watch PRO) consists of the following tests:

Board level tests

Each of the TSU 600 boards contains an on-board processor which executes a series of tests checking the circuitry on the board.

- RAM and EPROM tests
- Verify on-board circuitry

Unit level tests

- Front panel LED verification
- Board-to-board interface test

A test pattern is sent from the controller through a loopback on all other boards and checked on the controller. This verifies the data path, clocks, and control signals for the entire chassis.

Initialization

Set User Passcode

The TSU 600 is designed to operate with or without the use of a passcode. The default condition is without a passcode.



If the unit is to be remotely accessed using T-Watch PRO, you must enter a passcode. When managing a number of units, the passcode can be the same for all the units.

The passcode should be a number easily remembered. Once entered, the passcode is required to access any operation other than viewing. See *Set Passcode* on page 6-2.

Set Unit Identification

The Unit ID sets the unit to respond to remote control (controlled by a device other than the front panel or terminal). If no Unit ID is recorded it is not possible to operate from any remote control device, including the local PC for T-Watch PRO or SNMP. See *Unit ID* on page 6-3 for details.

Set Control Port

The TSU 600 can be configured from the control port when T-Watch PRO, SNMP, or the terminal interface is being used.

If the control port is to be used, the control port baud rate must also be selected.

Chain-In (PC)

The unit can be controlled from an external PC connected directly or via modem to the Chain-In port. When using Chain-In, the selection of the Control Port baud rate from 9600 (factory default), 1200, 2400, or 4800, 19200, or 38400 must be made using the Unit Configuration menu. Unless locked out externally, the front panel can also control the unit.

Chain In/Chain Out

TSU 600 units and other TSUs can be linked together to form a chain.

Figure 2-4 provides an example of a chain-in arrangement with a PC or a modem. The first TSU 600 in the chain receives controlling input from the PC or modem.

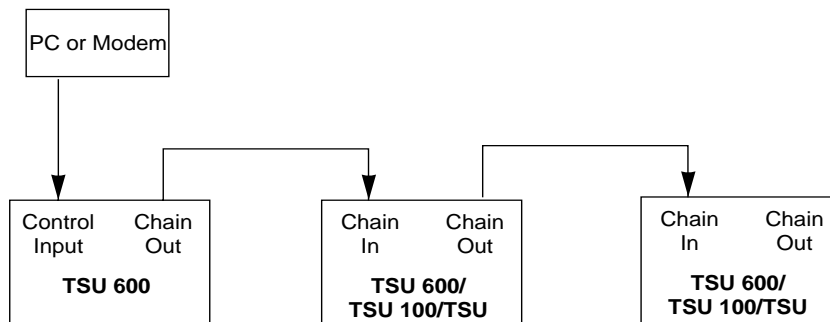

Figure 2-4. Example of Chain In

Subsequent TSUs in the chain are in a position to intake information from another TSU. This in-taking of information from another TSU in the chain is identified as Chain-In. The baud rate for the chained units must match that of the first unit.

Unless locked out externally, the front panel can also control the unit.

At this point, the Unit Initialization procedure is concluded. If the unit is to be configured remotely, there are no additional items necessary to complete prior to executing remote configuration.

The Passcode, the Unit ID, and the Control Port settings are stored in a nonvolatile memory. This ensures that they are operable for subsequent power-up sequences.

Normal Power-Up Procedure

After the unit has been put into operation with the initial power-up and initialization, subsequent power-up procedure includes only the Power-Up Self-Test followed by the request for a passcode (password) if this option was selected during initialization.

Use the number keys to key in the previously recorded passcode and press **Enter**.

FRONT PANEL

The TSU 600 front panel both monitors operation and controls the configuration of the unit. The TSU 600 front panel is shown in *Figure 3-1* on page 3-4. Descriptions of each part of the front panel follow.

Name	Description
LCD Window	Displays menu items and messages in two lines by 16 characters. It also displays alarm and status information.
Enter	Selects active menu items. To select a menu item, press the number of the item. The menu item flashes, indicating it is activated. Press Enter to select the menu item.
Up and down arrows	Up and down arrows are used to scroll through and activate the submenu items available in the current menu. When the submenu items are scrolled, the flashing cursor indicates the active parameters.
Cancel	Pressing the Cancel key stops the current activity and returns the display to the previous menu. Repeat until the desired menu level is reached. When a submenu item is displayed, press Cancel to exit the current display and return to the previous menu.
Numeric Keypad	The numeric keypad contains the numbers 0 through 9 which are used to activate menu items and enter information (such as the IP address).

Name	Description
Shift	<p>To enter special function keys, press and release Shift before pressing the key representing the desired character. See <i>Operation Keys</i> on page 3-5 for a description of the function keys.</p> <p>To activate a special function key rather than a number, press Shift and then the key. If you press the key without using Shift, the numbered item becomes active instead of the special function key.</p>

CSU Status LEDs

The CSU status LEDs display the operational condition of the network interface located on the controller board in the unit.

Name	Description
OK (green)	Indicates the operation is in the normal mode and no errors have been detected.
Test (yellow)	Indicates that the network interfaces are operating in a test mode. This includes a self-test or a test loopback. When lighted, this LED also indicates that normal data flow is not occurring on the network interface.
Error (red)	Indicates an error such as a BPV, OOF, or CRC.
Alarm (red)	<p>Indicates an alarm condition has been detected. When the alarm condition is no longer valid, the OK LED activates (turns on).</p> <p>To view an alarm condition, select the active alarm menu item or select Alarm by pressing Shift 8.</p> <p>If the alarm conditions have been corrected, the alarm which caused the activation of the Alarm LED can be viewed under the Unit History menu.</p>

Module Status LEDs

The module status LEDs display the operational condition of ports installed in the option slots.

Name	Description
OK (green)	Indicates the operation is in the normal mode and no errors have been detected.
Test (yellow)	Indicates that one of the interfaces is operating in a test mode. This includes a self-test or a test loopback. When lighted, this LED also indicates that normal data flow is not occurring in at least one of the module ports.
Alarm (red)	<p>Indicates an alarm condition has been detected. When the alarm condition is no longer valid, the OK LED activates (turns on).</p> <p>To view an alarm condition, select the active alarm menu item or select Alarm by pressing shift 8. If the alarm conditions have been corrected, the alarm which caused the activation of the Alarm LED can be viewed under the Unit History menu.</p>
System (green)	<p>Indicates the status of the power supplies.</p> <p>If the LED is illuminated green, all installed power supplies are functioning properly.</p> <p>If the LED is illuminated red, one or both power supplies are not functioning normally.</p> <p>This feature is for the AC-powered 600e only. For the TSU 600 and DC- powered 600e, the system LED is always green.</p>

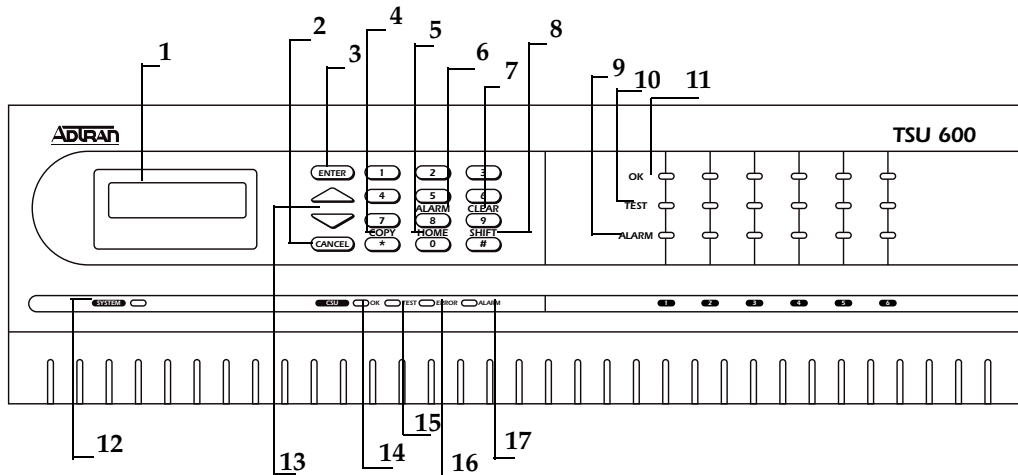

- | | |
|---------------------------------|--|
| 1. LCD Window | Displays menu items and messages in 2 lines by 16 characters. |
| 2. Cancel | Stops current activity and returns to the previous menu. |
| 3. Enter | Selects active menu item |
| 4. Copy | Copies last data entered into the current DS0. |
| 5. Home | Returns to the main menu. |
| 6. Alarm | Quick access to the active alarm display menus. |
| 7. Clear | Clears data/results fields |
| 8. Shift | Provides access to special function keys |
| 9. Alarm (Module Status) | Active when an alarm condition has been detected. |
| 10. Test (Module Status) | Active when the module is in test mode. |
| 11. OK (Module Status) | Operation is in normal mode with no detected errors. |
| 12. System LED | Indicates status of power supplies (600e only) |
| 13. Up and Down Arrows | Scroll through and activate the submenu items available in the current menu. The flashing cursor indicates the active parameter. |
| 14. OK (CSU Status) | Operation is in normal mode with no detected errors. |
| 15. Test (CSU Status) | Active when the network interface is in test mode. |
| 16. Error (CSU Status) | Indicates errors such as BPV, OOF, and CRC. |
| 17. Alarm (CSU Status) | Active when an alarm condition has been detected on the network interface. |

Figure 3-1. TSU 600 Front Panel Layout

Operation Keys

Name	Description
Copy	Used in the DS0 mapping menu operations to copy the last data entered into the current DS0. This key operates without pressing the Shift key.
Home	Returns home to the Main Menu from any menu location.
Alarm	Used as quick access to the active alarm display menus. This can be activated while any other menu item is in use. When the Alarm Menu is exited, the unit returns to the location of the same menu that was active when Alarm was selected.
Clear	Used in various menus to clear data/result fields.

General Menu Operation

The TSU 600 uses a multilevel menu structure containing both menu items and data fields. All menu operations and data are displayed in the LCD window. The menu items are numbered and can be viewed by scrolling with the **up** and **down arrows**.

Name	Description
Data Field	You can edit menu items followed by a colon (:)
Display Only Field	You cannot edit menu fields followed by an equal symbol (=). This symbol identifies a field used for value display only
Arrows	Menus that display small up or down arrows in the lower right corner indicate there are more menu items than are visible on a two-line LCD. Access the additional items with the up or down arrows . You can also access undisplayed menu items by using the appropriate menu number.

Selecting and Activating a Menu Item

Step	Action
1	Choose a menu item by placing the cursor on the desired menu item by either: <ol style="list-style-type: none"> 1. pressing the number corresponding to the menu item or, 2. highlighting it with the up and down arrows.
2	To activate the Alarm List option from the Status Menu do the following: <ol style="list-style-type: none"> 1. Activate the Status Menu using the arrow keys or by pressing 1. The cursor will flash on the number next to the activated selection. 2. Press Enter. 3. Use the arrow keys to view submenu items. 4. Choose an item on the submenu such as ACTIVE ALARMS. 5. Select the submenu with the arrow keys or by pressing 3. 6. Press Enter. 7. View the Alarm List using the arrow keys.

The front panel menu tree is shown below.

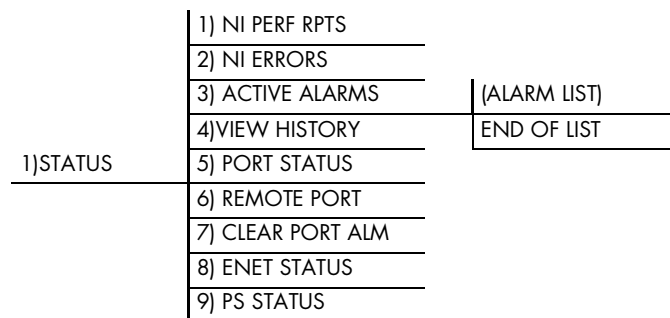

Figure 3-2. Example of Basic Front Panel Menu Travel

Editing the Data Field

Use the following steps to edit data fields preceded by a colon (:).

Step	Action	Result
1	Position the cursor on the submenu item number and press Enter .	The cursor moves to the data field (to the right of the submenu item name).
2	Using the arrows, scroll to scan the available value settings.	The value settings display one-at-a-time in the data field position.
3	When the desired value is displayed, press Enter to set that value.	When the value is set, the cursor moves back to the submenu item position, indicating the operation is complete.
4	Select another submenu field or press Cancel to return to the submenu.	Pressing Cancel before pressing Enter voids any data changes. The original data value is restored and the cursor returns to the submenu field.

Display Only Data Fields

Data fields preceded by an equal (=) symbol cannot be edited. See *Figure 3-3* and the instructions listed below.



Figure 3-3. Display and Data Fields

Step	Action
1	Press Enter to move the cursor to the data field.
2	Use arrows to select AUTO and press Enter . <ul style="list-style-type: none"> • The unit automatically sets the Line Build Out. • The display field shows the value actually set. • The equal symbol after LBO in the second line indicates the information that follows is displayed data and cannot be edited.

Exit Any Menu Field Operation Or Display

Press **Cancel** as many times as required to return to the desired menu level or press **Home** to return to the main menu.

Data Port Identification

When configuring the unit, menu selections will include options from data port submenus. Selecting of data ports is necessary because the TSU 600 uses a Slot-Port method to identify which data port the menu item is referencing. If a module containing a **PBX DSX-1 option card** with an **Nx56/64 plug-on interface** is installed in option slot 6, it would be designated as:

DSX-1 Passthru=6.1

Where slot=6 and port =1.

The DSX-1 is located in option slot 6 and is the first port in that slot.

Nx56/64=6.2

Where slot=6 and port=2.

The Nx is located in Slot 6 and is the second port in that slot.

Viewed from the rear of the TSU 600, the module slots are arranged as shown in Figure 3-4.

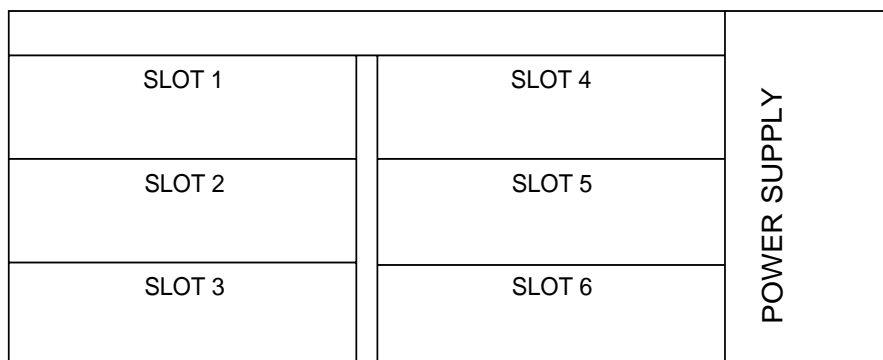

Figure 3-4. Module Slots, TSU 600

Front Panel Menu Structure

The TSU 600 uses a multilevel menu structure containing both menu items and data fields. All menu operations and data display in the LCD window.

The opening menu is the access point to all other operations. Each **Main Menu** item has several functions and submenus to identify and access specific parameters.

The front panel LCD of the **Main Menu** contains the following options:

Option	Description
Status	Displays all relevant information for the network and DTE interfaces. For detailed information on status options, see <i>Chapter 4, Status Menu</i> .
Config (Configuration)	Displays and sets the TSU 600 operational configuration, including all network interface parameters, the allocation of the DS0s, and the port parameters. For detailed information on configuration options, see <i>Chapter 5, Configuration Menu</i> .
Util (Utilities)	Displays and sets system parameters. For detailed information on utility options, see <i>Chapter 6, Utility Menu</i> .
Test	The Test menu initiates different types of unit tests and displays test results in the LCD window. For detailed information on test options, see <i>Chapter 7, Test Menu</i> .

Alternate Methods of Control

T-Watch PRO (ADTRAN PC Program)

T-Watch PRO is the ADTRAN PC control program. It provides complete control over the configuration of the TSU 600 using a graphical interface and displays the same status and performance data as the front panel LCD. This data is displayed in the form of tables and graphs.

The T-Watch PRO program has the following capabilities:

- Interfaces with a modem which permits dialing into a remote TSU 600 location to configure the unit or read the status or performance of the unit.
- Receives traps from any TSU product.
- Records and creates display performance data over a 30 day period.
- Accesses units via the local area network.

T-Watch PRO/LAN Connection

To set up the TSU 600 to work with T-Watch PRO over the LAN, follow these steps:

Step	Action
1	Set the Unit ID using the Front Panel. See <i>Unit ID</i> on page 6-3 for more information.
2	Set Control Port to SLIP or Normal for 10BaseT (600e only) using the Front Panel.
3	Configure the IP address default gateway , and subnet mask using the Front Panel.  NOTE <i>The default gateway and subnet masks are not used for SLIP mode.</i>
4	Follow the installation instructions for T-Watch PRO to start the program and connect to the unit.

T-Watch PRO/EIA-232 Connection

To set up the TSU 600 to work with T-Watch PRO over a direct EIA-232 connection, the following steps are required:

Step	Action
1	Set the Unit ID and the Passcode using the Front Panel. <i>See Unit ID on page 6-3 and Change/Set a Passcode on page 6-3 for more details.</i>
2	Set the Control Port rate to the same setting as the PC Com port.
3	Connect the PC Com port to the Chain-In port on the TSU 600 using the DB25 to modular adapter and 6-foot modular cable.
4	Follow the installation instructions for T-Watch PRO to start the program and connect to the unit.

SNMP

The ADTRAN TSU 600 supports the Simple Network Management Protocol (SNMP) through the chain-in (SLIP) interface or 10BaseT interface (600e only). See *Appendix B, Understanding SNMP* for detailed information.

To use SNMP with the TSU 600, do the following:

Step	Action
1	Set Control Port to SLIP for Chain-In Port or Normal for 10BaseT (600e only).
2	Set the IP address, default gateway, and subnet mask through the front panel.  NOTE <i>The default gateway and subnet mask are not used in SLIP mode.</i>
3	Load the appropriate MIB browser into the Network Management Station (available on the ADTRAN webpage at http://www.adtran.com). The MIB browser issues SNMP gets/sets to the TSU 600.

Terminal Mode Connection

The TSU 600 provides the front panel menus to a VT-100 type terminal. This mode can be used to configure and monitor the unit. Initiate this mode by typing **<ctrl> PTT** on the terminal once it is connected to the Chain-In port. For detailed information on this method of control, see *Telnet Terminal Menus* on page 8-1.

Telnet Connection

You can connect to the TSU 600 via telnet. Before attempting to connect via telnet, first define the IP address, the default gateway, and subnet mask using the front panel.



The default gateway and subnet mask are not used in SLIP mode.

When you begin the Telnet session, you will be prompted for a password. The default password is ADTRAN. You can change this password using the Management submenu. See *Default Unit Passcode* on page 8-7, for details. The telnet session will time-out after a predefined value that is also set in the Management Menu.



Only one telnet session can be active at one time.

The Status menu branch allows you to view the status of the TSU 600 operation. See *Figure 4-1*.

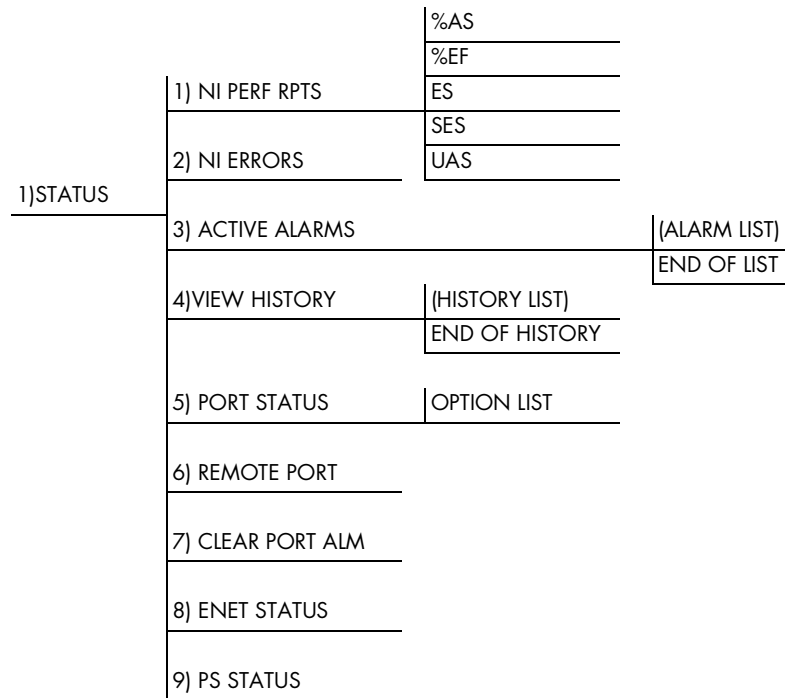

Figure 4-1. Complete Status Menu

Menu flow is normally depicted from left to right. Arrows on the lower right of the screen indicate the direction of scrolling to use to view additional menu items. At every level of the menu, pressing **Cancel** returns the system to the previous menu level. Press **Cancel** repeatedly to return the system to the main menu.

Network Performance Reports (NI PERF RPTS)

The Network Interface Performance Reports display the user copy of the performance data. See *Figure 4-2*. The TSU 600 maintains this performance data on the network in compliance with ANSI T1.403 and AT&T document TR54016. The data displayed is data accumulated over the last 15 minutes and over the last 24 hours.

Use the scroll keys to access the complete display of the following report fields:

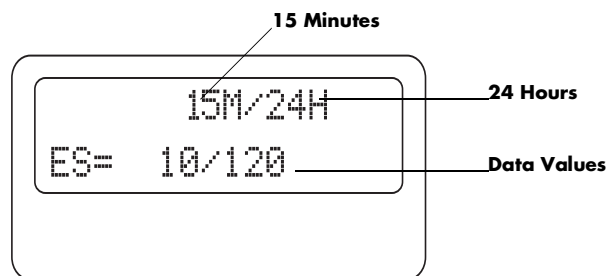

- %AS** % of available seconds
- %EF** % of error free seconds
- ES** Number of errored seconds (1 or more errors/second)
- SES** Number of severely errored seconds (more than 320 errors/second)
- UAS** Number of unavailable seconds (10 or more consecutive seconds)

Figure 4-2. Network Interface Performance Report

If insufficient time has passed to collect data, NA displays. Continue with standard operating procedures to exit the display.

When this menu is active, performance data can be cleared by pressing **Clear (Shift 9)** on the keypad. Only the user copy of the performance data is cleared.

Since only the user's copy of performance data is cleared by the TSU 600, the data displayed here might be different from the data sent to the network as PRM data.

Network Interface Errors (NI ERRORS)

The NI Errors submenu displays the types of errors the Network Interface (NI) detects. A blinking CSU error LED indicates that network errors are detected.

The asterisk (*) above an item indicates the type of errors detected. The error types are as follows:

- CRC** CRC-6 bit errors based on the FDL.
This is valid only in ESF mode.
- BPV** Bipolar violations.
- XS0** Excess zeros.
- FER** Framing errors.

Active Alarms

This menu item displays a list of current alarms reported by either the base controller or any of the ports. If no alarms are current, the menu item displays **End of List**. See *Figure 4-3*.

This display includes two lines of text. The top line is the alarm source. The bottom line is the alarm message. A list of alarm messages is found in *Appendix C, System Messages*, on page C-1.

In addition to normal menu operation, you can also access this menu item with the Alarm function (**Shift 8**) on the keypad. If one or more of the **Alarm LEDs** are illuminated, an alarm is present. Press **Cancel** to return to the previous menu item.

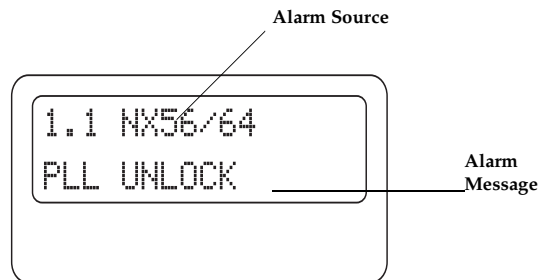

Figure 4-3. Display of Alarm Messages

View History

This menu item displays and clears the accumulated status changes of the unit.

View History displays a history of the first 20 status changes in the unit, including the date, time, and type of change. The unit also records for viewing the date and time an alarm became active and inactive, as well as the date and time of test activation and deactivation.

To clear the **View History** display, press **Clear (Shift 9)** with the **View History** menu active.

Port Status

Port Status displays the signals monitored on the data ports. For example, an Nx56/64 interface monitors the RTS, CTS, TD, and RD, along with other signal lines. When a port is selected, the LCD indicates whether the signal is present.

Remote Port

Remote Port displays the status of activity on the Chain-In remote port. This is useful for troubleshooting communication sessions, as well as verifying cabling.

RX Characters received at remote port.

ID Unit ID received at remote port.

CRC Correct CRC received.

PC Correct passcode received.

TX Characters transmitted from the remote port.

Clear Port Alarm

Clears the **Link Failed alarms** on option modules that have been removed from the TSU 600 chassis.

ENET Status (600e only)

TX Indicates that data is being transmitted from the 10BaseT port

RX Indicates that data is being received by the 10BaseT port

LNK Indicates the current status of the 10BaseT link integrity test.

 **NOTE** *This should always be on when the unit is connected to a functional 10BaseT hub.*

CPU Active when the CPE is accessing the 10BaseT interface.

PS Status (600e only)

Displays the status of **Power Supply A** (PSA) and **Power Supply B** (PSB) for AC powered units. Displays DC supply for DC Powered units.

Possible status: NOT PRESENT, INACTIVE, OK, DC Supply (DC units only)

Chapter 5 Configuration Menu

The Configuration menu sets the TSU 600 operational configuration, including all network interface parameters, the allocation of the DS0s, and the port parameters. See *Figure 5-1*.

	1) NETWORK (NI)	1) FORMAT 2) CODE 3) YEL ALARM 4) XMIT PRM 5) TIMING MODE 6) SET LBO 7) INBAND LPBCK 8) BIT STUFFING 9) TR-08 OPTIONS	A) ALARM REPORT B) ALARM FORMAT C) BPV THRESHOLD	1) CTL PORT RATE 2) TRAPS 3) ACCESS 4) INIT MODEM 5) CONTROL PORT 6) IP ADDRESS 7) SUBNET MASK 8) DEFAULT ROUTER 9) SLIP RATE A) SLIP FLOW CTL B) PROXY TRAPS
	2) UNIT			
	3) MAP XCHNG	OFF		
	4) MAP IN USE: A(B)	AUTO		1) MAP A @: HH:MM 2) MAP B @: HH:MM
2) CONFIG	5) DS0 MAP A			1) COPY A>TEMP 2) CREATE TEMP 3) REVIEW MAP A 4) REVIEW TEMP 5) EDIT TEMP 6) APPLY TEMP > A
	6) DS0 MAP B	1) COPY B > TEMP 2) CREATE TEMP 3) REVIEW MAP B 4) REVIEW TEMP 5) EDIT TEMP 6) APPLY TEMP > B		
	7) PORT CONFIG	(OPTION PORTS)		

Figure 5-1. Configuration Menu

Menu flow is normally depicted from left to right. Arrows on the lower right of the screen indicate the direction of scrolling to view additional menu items. At every level of the menu, pressing **Cancel** returns the system to the previous menu level. Pressing **Cancel** repeatedly returns the system to the Main menu.

NETWORK (NI)

This menu item accesses the configuration of parameters associated with the network interface in the base unit. There are nine submenu items that include setting the format, the **Line Build Out (LBO)**, and the timing mode. Submenu items do not include setting the parameters which may be necessary for a secondary interface (DSX-1 Passthru, etc.).

Network (NI) Menu Items

The menu items and their descriptions follow.

Menu Item	Description
Format	Sets the frame format for the NI. Choices: D4, ESF, SLC96  <i>D4 is equivalent to superframe format (SF).</i>
Code	Sets the line code for the NI. Choices: AMI, B8ZS.
YEL Alarm	Enables and disables the transmitting of yellow alarms. Choices: ENA, DISA
XMIT PRM	Enables and disables the sending of PRM data on the facility data link (FDL). The PRM data continues to be collected even if XMIT PRM is disabled (possible only with ESF Format). Choices: Off, On.
Timing Mode	Selects the clock source for transmission toward the network from the NI. See <i>TSU 600 Clock Sources</i> on page 5-4 for more information. Choices: Network, DTE (Slot 1), Normal (CSU), U-BR1TE (Slot 1), Internal, and Secondary (SI).

Menu Item	Description
SET LBO	<p>Selects the line build out for the network interface. In AUTO mode, the TSU 600 sets the LBO based on the strength of the receive signal and displays the selected value. Choices: 0.0 dB, 7.5 dB, 15 dB, 22 dB, and Auto</p> <p> NOTE <i>To activate the -36 dB receiver sensitivity, set the LBO to AUTO. This feature is useful in a point-to-point application where no network elements are involved. If a network element such as a Smart Jack is installed on the circuit, the LBO should be set to 0 dB.</i></p>
INBAND LPBCK	<p>Sets unit to accept or reject the network interface loop-up and loop-down codes as defined in ANSI T1.403. Choices: Accept, Reject</p>
BIT STUFFING	<p>When enabled, bit stuffing causes the TSU 600 to monitor for ones (1s) density violations and insert a one (1) when needed to maintain ones at 12.5%. Choices: Enable, Disable</p>
TR-08	<p>The TR-08 submenu configures the unit for TR-08 applications. The submenu items and their descriptions follow.</p> <p>Alarm Report Enables and disables the transmitting of alarm reports. Choices: SEND ALARMS, DISABLE ALARMS</p> <p>Alarm Format Sets the alarm frame format to 13 frames or 16 frames. Choices: ORB-13, ORB-16</p> <p>BPV Threshold Sets the threshold for BPVs to trigger an alarm. Choices: 10-4, 10-5, 10-6</p>

TSU 600 Clock Sources

The TSU 600 is operable from various clock sources, permitting it to perform properly in many different applications. The network interface timing mode is set by using the Network (NI) Configuration menu options. The following options are available:

- Network Timing
- DTE Timing
- UBR1TE
- Internal Timing
- Secondary Timing
- Normal (CSU) Timing

The selected clock option always designates the clock source for transmission. Clocking necessary for receiving data is always recovered from incoming data.

Network Timing

The network is the source of timing. The received data clocking is looped back to the network, where it is used to determine the transmission timing. This option is also referred to as loop timed as the transmission clock is derived from the received clock. See *Figure 5-2*.

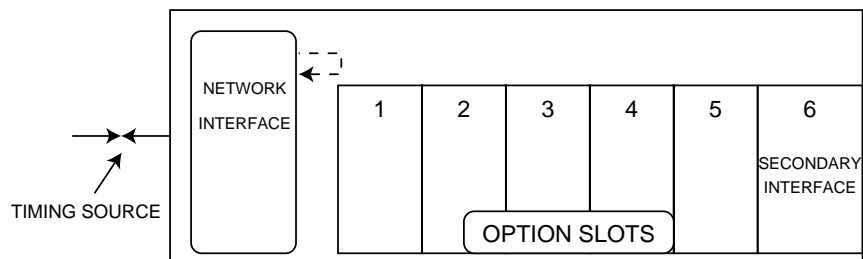

Figure 5-2. Network Timed Clock Source

DTE Timing

The DTE is the source of timing. The TSU 600 uses the incoming DTE clock to determine the transmission timing. This is typically used in applications where it is necessary to have the DTE as the primary clock source (such as limited distance line drivers). See *Figure 5-3*.

The DTE source timing is restricted from use when a secondary interface is used at the same time.

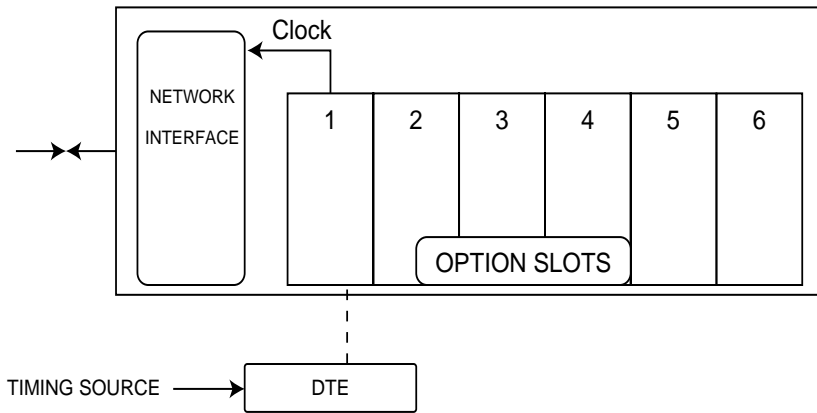

Figure 5-3. DTE Timed Clock Source

U-BR1TE (Slot 1)

The timing mode selection U-BR1TE (Slot 1) works much like DTE timing except that the clock is derived from the U interface.

Internal Timing

The TSU 600 is the source of timing. The TSU 600 is configured to use its own internal oscillator as the source of timing. Applications include private line driver circuits where one end is set to network and the other to internal. See *Figure 5-4*.

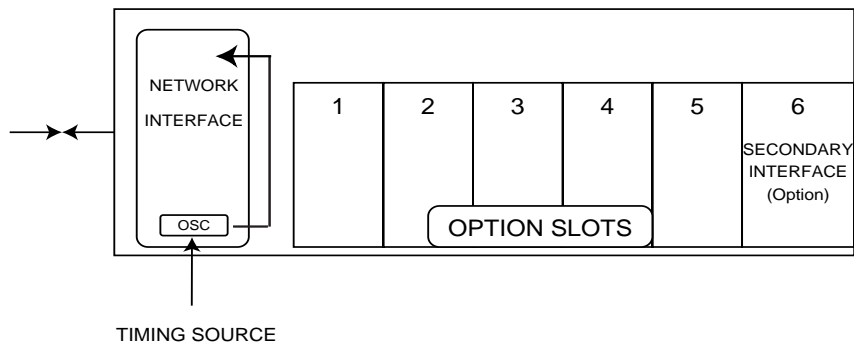

Figure 5-4. Internal Clock Source

Secondary Timing

The secondary interface is the source of timing. The TSU 600 uses the clock derived by the secondary interface for transmission timing. See *Figure 5-5*.

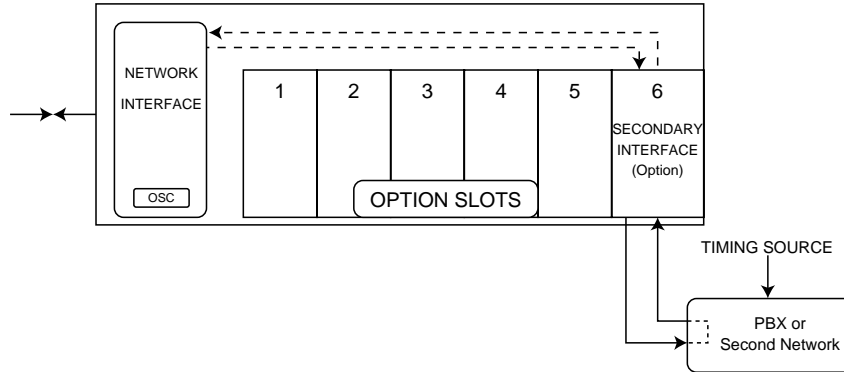

Figure 5-5. Secondary Clock Source

Normal (CSU) Timing

The typical timing option arrangement is shown in Figure 5-6. The PBX is looped timed to the TSU 600. The Network Interface (NI) is the actual source of timing. This timing option is the same as that typically used for CSUs. This is the preferred mode for use with a PBX application.

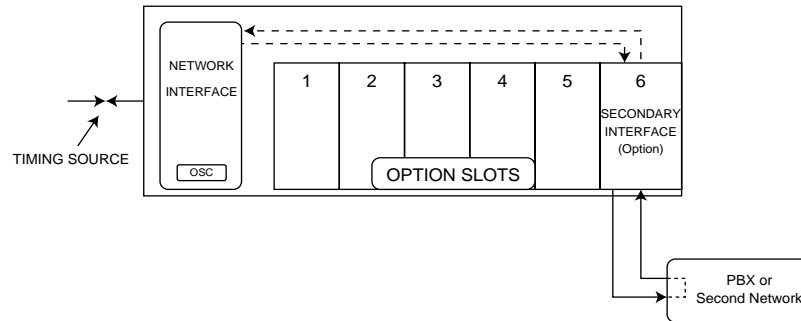



Figure 5-6. Normal (CSU)

Unit Menu

The Unit menu changes the baud rate of the Chain-In port and the setup of the Chain-Out port. The menu items are:

Menu Item	Description
Ctl Port Rate	Sets the baud rate for communication with the PC or modem. Choices: 1200, 2400, 9600, 19200 and 38400 kbps
Traps	Enables or disables the transmission of trap messages. Choices: Enable, Disable
Access	Sets the method of connection from the TSU 600 to T-Watch PRO/SNMP. Choices: Direct - Used if connected directly to the PC Dial - Used when connection is through a modem. The dial string is entered from T-Watch PRO/SNMP.
Init Modem	Allows you to choose an industry standard or a custom initialization string for a modem connected to the control port.
Control Port	Selects the TCP/IP physical interface. Choices: SLIP using the EIA-232 serial port or 10BaseT Ethernet (600e only).  NOTE <i>If this option is set to SLIP, the Chain-In port may not be used as a terminal interface.</i>
IP Address	Uniquely identifies the TSU 600 on a TCP/IP network. This address is composed of four decimal numbers, each in the range of 0 to 255, separated by periods.

Menu Item	Description
Subnet Mask	Defines which part of a destination IP address is the network number. Used along with the TSU 600e IP address to determine which nodes must be reached through the default IP Gateway. This value is set to 0.0.0.0 when the IP interface option is set to SLIP.
Default Router	All IP Packets destined for nodes not on the TSU 600e unit's local network are not forwarded through this IP address. Normally, this address defines a router connected to the TSU 600e unit's local network. This value is ignored when the IP interface is set to SLIP.
SLIP Rate	Sets the baud rate for the Chain-In port when used as the SLIP connection for SNMP management. Choices: 1200, 2400, 4800, 9600, 19200, 38400
SLIP Flow CTL	Used to activate flow control on the Chain-In port when used as the SLIP interface. Hardware mode uses RTS and CTS. Choices: None, Hardware
Proxy Traps	Enables or disables the transmission of trap messages from units being "proxied" for. Choices: Enable, Disable

Map Exchange (Map Xchg) Menu

The Map Exchange menu enables and sets the automatic time-of-day map switch. The unit provides selection of the hour, minute, and seconds for the map switching to take place.

The menu items are:

Menu Item	Description
OFF	Indicates the map in use does not change (disabled). Off disables the Automatic Map Change feature. Press Enter to activate the selection.
AUTO	Indicates that the map in use will change at a user-selected time of day. AUTO enables the Automatic Map Change feature. Press Enter to activate the selection When Auto is selected, the unit displays the screens to set times for switching. After editing Map A, press Enter to record the Map A settings and activate the selection fields for Map B. Use the same operation to edit switching time for Map B. When ESF is used with an FDL channel between units, the units automatically coordinate the automatic map switch by sending a map switch command from end-to-end over the FDL. Only one end needs to be set to Auto for this to work.

MAP In Use: A(B) Menu

This menu item controls the DS0 map the TSU 600 uses and displays the map in current use.

DS0 Map A and DS0 Map B Menu

The DS0 maps designate which DS0s are assigned to which port. See *Figure 5-7*. There are three maps: DS0 Map A, DS0 Map B, and the Temporary (Temp) map.

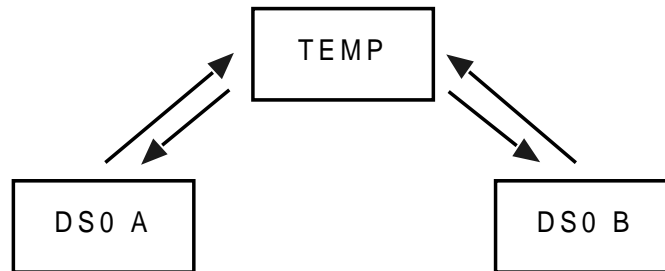

Figure 5-7. DS0 Map Designations

DS0 A and DS0 B are the current maps the TSU 600 uses.

The Temp Map generates a map before putting it into use.

You can copy DS0 A to DS0 B by copying the DS0 A map into the Temp map. Then apply (write) the Temp map into DS0 B.

The menu items are:

Menu Item	Description
COPY A >TEMP	Copies the current map (A or B) into a Temp map area. Permits modification without disturbing the existing map. When the modifications are completed, the Temp map is written to current MAP A (B) by selecting Apply .
CREATE TEMP	Creates a map by defining a port or Idle for all DS0s. When CREATE TEMP is first selected, all DS0s are set to Idle. See <i>Create Temp Example</i> on page 5-13 for more information.

Menu Item	Description
REVIEW MAP A(B)	Permits a quick review of the number of DS0s assigned to each port and the number of unassigned DS0s (<i>Idle</i> or <i>TST</i>) as defined in the currently applied Map A(B).
REVIEW TEMP	This menu item is operated the same for the Temp map as is REVIEW MAP A or Map B .
EDIT TEMP	The map in the Temp file can be edited to whatever configuration is desired. If Map A had been copied into the Temp file, then after editing, the Temp file could be applied to MAP A or MAP B. The menu operation is identical to CREATE TEMP with the exception that the existing port selections display.
APPLY TEMP > A	Writes the Temp map into Map A. Pressing Apply is usually the last step in updating a map and is accessed automatically at the end of editing or creating a temporary map. It can be bypassed at this time by selecting another menu choice.

Create Temp Example

A sample selection follows for **Create Temp**:

DS0: 01 to 24

PORT: *IDLE*, *TST*, + option module ports

TST designates which DS0s are used for QRSS testing when activated under the **TEST** Menu. When not used for testing, the *TST* designation is identical to *IDLE*.

1. With the cursor on **CREATE TEMP**, press **Enter**. The unit displays the selection screen with the cursor positioned on the first selection DS0 number. See *Figure 5-8*.



Figure 5-8. Create Temp Selection Screen

2. Enter the DS0 number by using either the **scroll method** or **numbers**. Do not mix the use of the keys.
3. Pressing **Enter** completes the selection and moves the cursor to **PORT**, the next field.
4. Scroll to select the port which is dependent on the installed option card.
5. Press **Enter** to complete the selection and move the cursor back to the DS0 field.

With the cursor on the DS0 field, the DS0 number can be incremented or decremented by scrolling. If you press **Copy**, the contents of the last DS0 entered are placed in the new DS0 number.

When all entries are complete, **Cancel** moves the cursor to the last of the submenu choices, **6)APPLY**. Either apply the newly created DS0 map or press **Cancel** to return to the DS0 Map A (B) submenu choices.



*Selecting **Apply** will not disrupt the operation of unmodified ports.*

Port Configuration (Port Config)

Port Configuration selects and configures the parameters associated with any data port in the unit. For example, parameters for the DSX-1 (PBX) interface are set through this menu. The items that can be set depend on which option module is installed. The list of option ports will vary with the configuration.

The TSU 600 is designed so that any additional ports developed in the future will contain the appropriate menu selections to provide access by use of this menu item.

The **Config menus** for options ports are described in separate sections of the manual supplied with the option card.

The utility menu tree displays and sets system parameters. See *Figure 6-1*. This includes setting the time and date, resetting all parameters to factory values, or re-initiating the unit. This menu also displays the unit software revision and the Unit ID setting.

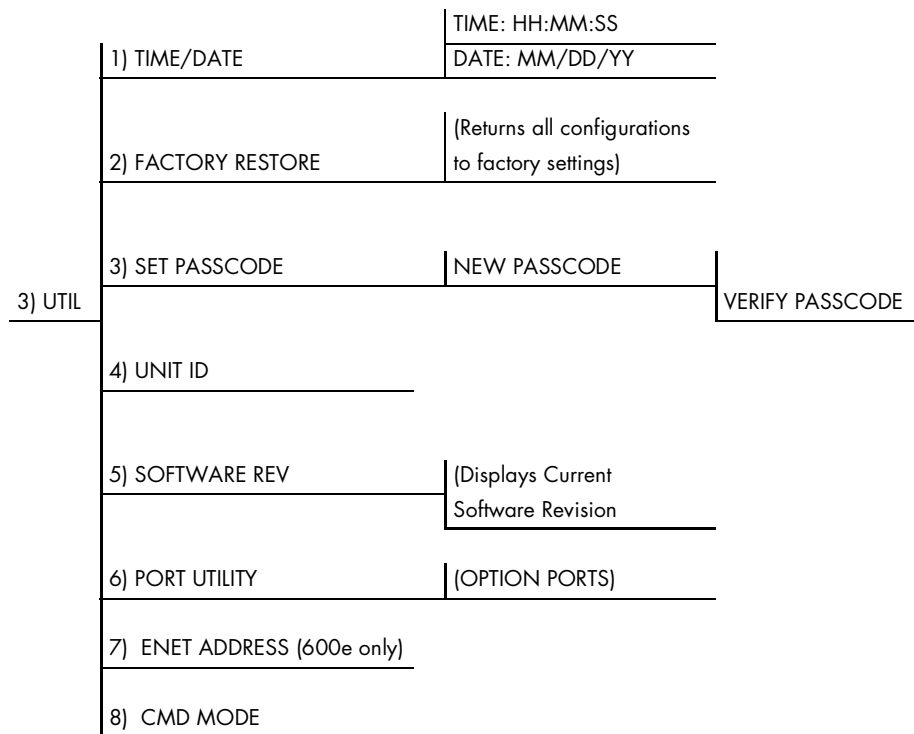

Figure 6-1. Utility Menu Tree

Menu flow is normally depicted from left to right. Arrows on the lower right of the screen indicate the scrolling direction to view additional menu items. At every level of the menu, press **Cancel** to return the system to the previous menu level. Pressing **Cancel** repeatedly returns the system to the Main menu.

Time/Date

This menu option displays or edits the current time and date. The TSU 600 maintains the time and date during power-off conditions.

If you want to...	Do this...
Record the entry and move to the next editing position	Press Enter after any numeric change
Move to a different field to edit	Press Enter at the editing position without making any changes, or Use the Up and Down Arrow keys
End the editing process	Press Cancel

Factory Restore

This menu item restores the factory default settings for all unit parameters, including configured DS0 maps.

Set Passcode

Enter Passcode from Other Menus

The *Passcode prompt* may make an unexpected appearance from other menu operations. This happens only when the unit is operating in the limited access mode, i.e., without an active passcode. The limited access mode may become active even if a passcode was entered, as it does when there is no activity for ten minutes. If the unit is to be remotely accessed using T-Watch PRO, a passcode must be entered. When managing a number of units, the passcode can be the same for all.

The unexpected appearance of the *Passcode prompt* occurs, for example, while operating in a limited access mode and attempting to change the data rate, (2)CONFIG, 2)UNIT, 1)CTL PORT RATE. Use the number keys to enter the correct passcode and press **Enter**. The unit displays *Access Granted*.

Pressing any key after entering a passcode causes the unit to return to the previous active menu. In this case it returns to **2)CONFIG, 2)UNIT, 1)CTL PORT RATE** to permit changing the data rate.

Change/Set a Passcode

The passcode can be changed or set at any time or eliminated altogether through the Utility menu item **3)SET PASSCODE**. This procedure requires the current passcode (if one is established) for operation.

The passcode can only be entered by using numbers. After entering the desired passcode, press **Enter**.

Set a null passcode at the **3)SET PASSCODE** menu by pressing **Enter** without any numbers. This sets a null passcode and grants unlimited access.

Automatic Time-out Feature

For added security protection, the unit is equipped with an automatic time-out for operation with the password. After ten minutes of inactivity, the unit reverts to limited access operation. To make changes in the configuration, the passcode can be reentered. See *Set Passcode* on page 6-2 for further information concerning passcode use, and both limited and editing access.

If the passcode number is lost, contact ADTRAN Customer Service for assistance.

No Passcode Desired

At the New Passcode prompt (in the Set Passcode menu), press **Enter** without any numerical entry. The system nullifies the need to enter a password for subsequent use and proceeds to the Unit ID prompt.

Unit ID

This menu is used to access the current Unit ID setting. Viewing is available in limited access mode. Editing or changing the Unit ID requires the use of a password as in editing mode. Unit Identification numbers must be between 2 and 999. If an out-of-range number is entered, the unit assumes the upper limit number of 999.

Setting the Unit Identification

In the **Unit ID menu** (item 4) under the **UTIL menu**, enter any value between 2 and 999. The number 1 is reserved for the PC.

Pressing **Enter** records the Unit ID number and establishes its availability for operation by remote control. The unit proceeds to the **Set Control Port** prompt.

No Unit ID Desired

Without entering any numbers at the **Unit ID** prompt, press **Enter**. Pressing **Enter** with no Unit ID recorded establishes the unit as unable to be operated by remote control.

Software Revision (Software Rev)

This menu provides access to the display of the current software revision level loaded into the base unit controller. This information is required when requesting assistance from ADTRAN Customer Service or when updates are needed.

Use **Cancel** to exit.

Port Utility

This menu provides access to the display of the current software information for each port installed in the unit. This information is required when requesting assistance from ADTRAN customer service or when updates are needed.

ENET Address (600e only)

Displays the Ethernet MAC address for the 10BaseT port.

CMD Mode

Reserved for factory use.

The Test menu initiates different types of unit tests and displays test results in the LCD window. The Test menu contains four items. See *Figure 7-1*.

Executing tests will disrupt some of the normal operation. See individual menu items concerning tests before executing.

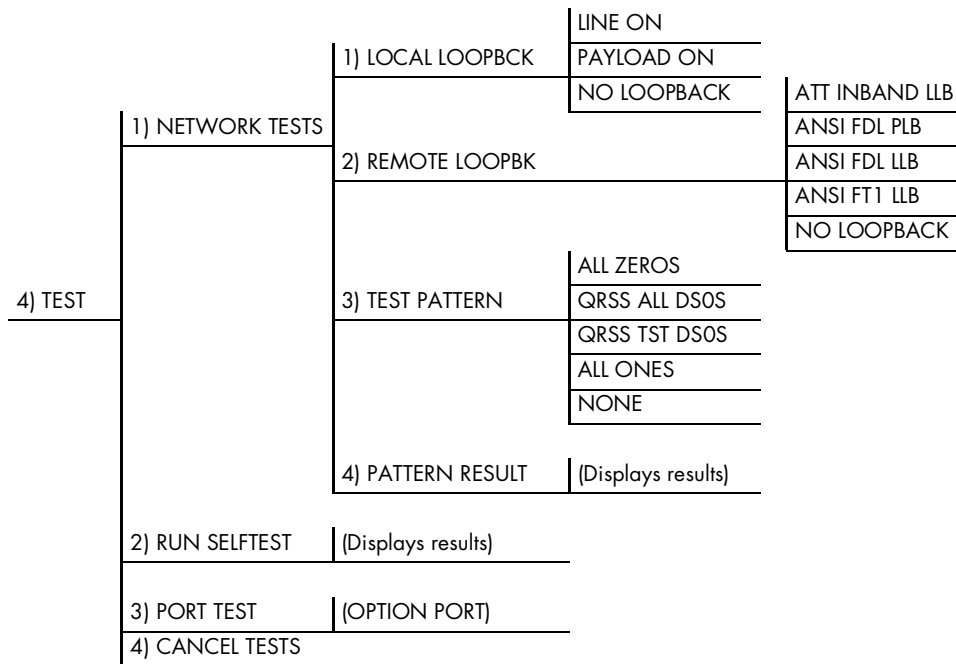

Figure 7-1. Test Menu

Menu flow is normally depicted from left to right. Arrows on the lower right of the screen indicate the scrolling direction to view additional menu items. At every level of the menu, pressing **Cancel** returns the system to the previous menu level. Pressing **Cancel** repeatedly returns the system to the Main menu.

Network Tests

Network tests control the activation of loopbacks and the initiation of data test patterns.

Network tests are run on the Network Interface (NI). You can select three different test configurations to determine the type of loopback and the pattern to run. Test results display in the LCD window.

Executing Network Tests will disrupt normal data flow unless only **TST DSOs** are selected for testing.

Loopback Tests

A number of different loopbacks can be invoked locally from the front panel, by T-Watch PRO commands, or remotely by using special in-band codes (AT&T D4 network loop up and loop down codes). Additionally, the loopbacks can be remotely controlled by means of out-of-band commands by the T1 ESF FDL or from T-Watch PRO by a modem connection. See *Figure 7-2*.

Network Interface Loopbacks

Network interface loopbacks affect the entire T1 data stream. There are two types of network loopbacks: line loopback and payload loopback.

Line loopback loops all of the received data back toward the network. The transmitted data is the identical line code that was received, including any bipolar violations or framing errors.

Payload loopback is similar to line loopback, except that the framing is extracted from the received data and then regenerated for the transmitted data.

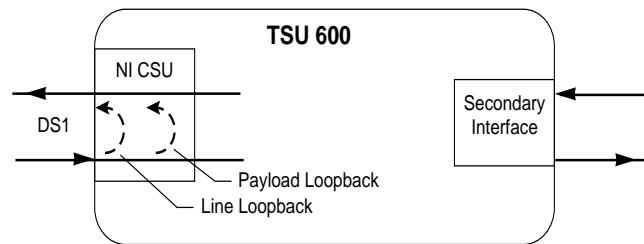

Figure 7-2. Network Loopback Tests

Local Loopback

There are three available choices for setting the local loopback:

Name	Description
Line On	Activates the line loopback
Payload On	Activates the payload loopback
No Loopback	Deactivates the loopback

Scroll to select a setting and record it by pressing **Enter**. The unit returns to the previous menu level.

Remote Loopbk

This activates the same loopbacks as Local Loopback but at the far end. It uses either the inband loopup code as specified by ANSI T1.403 for line loopback (ATT In-Band LLB), or the FDL as specified in ANSI T1.403 for payload and line loopback codes. The following options are available:

Name	Description
ATT In-Band LLB	Activates the line loopback using inband code
ANSI FDL PLB	Initiates the transmission of an FDL payload loopup code toward the far end
ANSI FDL LLB	Initiates the transmission of an FDL line loopup code toward the far end
ANSI FT1 LLB	Initiates the transmission of a FT1 loopback using the inband code described in T1.403.
No Loopback	Deactivates the loopback



Remote Loopback can only be used with Fractional T1 if the ANSI FT1 LLB is selected.

After a **Remote Loopback** option is selected, the TSU 600 verifies that the far end is actually in a loopback by checking for the receipt of a code looped back from the far end. Once the **Remote Loopback** type is selected, the LCD displays the loopback progress by displaying **Looping** until loopback is verified.

Test Pattern

Pattern	Description
All Ones	Sends an all ones pattern to the network
All Zeros	Sends an all zeros pattern to the network
QRSS All DS0s	Generates a QRSS test pattern and inserts the pattern into all DS0s
QRSS TST DS0s	Inserts a QRSS pattern in those DS0s mapped as TST in the currently active map (A or B)
None	Terminates pattern generation

QRSS Pattern

The QRSS pattern is commonly used to simulate real data in T1 interfaces. This pattern can be assigned to appear in all DS0s or only in **TST DS0s**. When QRSS is set in all DS0s and one of the network loopbacks previously described is activated at the far end, a total end-to-end integrity check can be run without the need for any external test equipment. When QRSS is assigned to **TST DS0s**, an integrity check of the link can be run along with normal data flow. The **TST DS0s** are user assigned as part of the DS0 Map.

This sets the pattern for the test and initiates the transmission of the pattern. The test is terminated by selecting **None**. The following patterns are available:



NOTE QRSS always runs at 64K/DS0.

Example:

1. Use the **up** and **down** key to select **QRSS ALL DS0s**.
2. Press **Enter** to record the selection. The TSU 600 starts to generate a QRSS test pattern and inserts the pattern into all DS0s.
3. Select **None** to end the test.

Pattern Result

Displays the results of the test currently active. Leaving and returning to this menu item does not interrupt the test.

Pressing **2** injects errors into the test pattern. These errors are detected by the device performing the pattern check.

Pattern	Description
ES	The number of seconds with at least 1 bit error
BES	The number of seconds with more than 1 bit error and less than 320
SES	The number of seconds with more than 320 bit errors
SYNC	Indicates if pattern sync is (yes) or is not (no) valid. An asterisk (*) indicates if pattern sync has been lost since the start of testing

Clear results by pressing **Shift 9**. The results are accumulated until the test pattern is set to **None** or **Cleared**.

Using **TST DS0s** for testing can be very useful, particularly in Fractional T1 applications. You can run an end-to-end test on the Fractional DS0s by:

- 1 Setting for Map B the **TST** in the same DS0 as used by Map A to receive data from an Nx56/64 port, and
- 2 Looping the far end using a V.54 loopback code on the Nx56/64 port. In addition, a single DS0 can be used for continuous testing while other DS0s are passing normal data.

This will also provide an end-to-end check on the entire link. Set each end to send QRSS in **TST DS0s** (using 1 DS0) and occasionally view the results on the Pattern Result Menu selection.

Run Self-Test

The self-test checks the integrity of the internal operation of the electronic components by performing memory tests and by sending and verifying data test patterns through all internal interfaces. Although actual user data cannot be passed during these tests, the self-test can be run with the network and DTE interfaces in place and will not disturb any external interface.

The memory portion of the self-test automatically executes upon power-up. A full self-test can be commanded from a front panel menu or from T-Watch PRO.

In addition to the specified self-tests, background tests are run on various parts of the internal electronics. These run during normal operation to confirm continued correct functioning.

This menu selection is used to execute a full internal self-test. The results of the self-tests are displayed in the LCD. Upon invoking the command, the LCD displays System Self-Test and the Test LEDs are illuminated. Test failures are displayed in the LCD window. The self-test consists of the following tests:

Board level tests

Each of the TSU 600 boards contain an on-board processor which executes a series of tests checking the circuitry on the board.

- RAM tests; EPROM checksum
- DS0 map tests
- On-board data path; sending a known test pattern through an on-board loop

Unit level tests

- Front panel LED verification
- Phase Lock Loop verify
- Board-to-board interface test

A test pattern is sent from the controller through a loopback on all other boards and is checked on the controller. This verifies the data path, clocks, and control signals.

If a failure is detected, note the failure number and contact ADTRAN Technical Support.

The execution of self-test will disrupt normal data flow and prevent remote communication until the self-test is completed.

Port Tests

The Port Tests menu is used to activate testing of specific data ports. It controls the activation of loopbacks and the initiation of data test patterns. Test results are displayed in the LCD window.

The execution of Port Tests will disrupt normal data flow in the port being tested.

Cancel Tests

Use this menu selection to deactivate all active tests, including tests on option modules.

Chapter 8 Telnet/Terminal Menus

MAIN MENU

The Telnet/Terminal Main Menu is the first menu displayed after the telnet/terminal session is established. See *Figure 8-1*. The default telnet/terminal password is ADTRAN.

 **NOTE** Only one telnet/terminal session may be active at a time.

```
ADTRAN - TSU 600
Password: XXXXXXXX
Main Menu
1) Status
2) Config
3) Util
4) Test
5) Remote Menu Access
6) Management Config
7) Flash Download
8) Quit Session
```

Figure 8-1. Telnet/Terminal Main Menu

Status, Config, Util, and Test Menu Options

These menu items can access the same modified menus that you can access through the front panel. For detailed information on the available menu options, refer to the following sections:

- *Status Menu* in Chapter 4.
- *Configuration Menu* in Chapter 5.
- *Utility Menu* in Chapter 6.
- *Test Menu* in Chapter 7.

DSO Maps Configuration Menu

The Telnet/Terminal version of the DSO maps configuration menu takes advantage of the 24-line VT 100 display. Upon entering this menu, the current Temp Map displays followed by nine selections that you can use for configuring and reviewing map information.

TEMP MAP			
DSO #	PORT	DSO #	PORT
1	IDLE	13	IDLE
2	IDLE	14	IDLE
3	IDLE	15	IDLE
4	IDLE	16	IDLE
5	IDLE	17	IDLE
6	IDLE	18	IDLE
7	IDLE	19	IDLE
8	IDLE	20	IDLE
9	IDLE	21	IDLE
10	IDLE	22	IDLE
11	IDLE	23	IDLE
12	IDLE	24	IDLE

- 1) COPY MAP A TO TEMP MAP
- 2) COPY MAP B TO TEMP MAP
- 3) CREATE TEMP MAP
- 4) REVIEW MAP A
- 5) REVIEW MAP B
- 6) REVIEW TEMP MAP
- 7) EDIT TEMP MAP
- 8) APPLY TEMP MAP TO MAP A
- 9) APPLY TEMP MAP TO MAP B

Figure 8-2. DSO Temp Map

- Use the **up** and **down arrows** or **number keys** to move the cursor from one selection to another.
- Use the **Enter** key to perform the action displayed in the LCD to the right of the cursor.

Normally, map configuration involves these steps.

Step	Action
1	Initializes the Temp Map to one of three configurations (current Map A, current Map B, or all IDLEs). This step is optional.
2	Edits the Temp Map so that it reflects the desired map configuration.
3	Replaces the current DS0 map A or B configuration with the Temp Map configuration.

Initializing the Temp Map

Upon entering the DS0 maps configuration menu, the Temp Map reflects its last configured state. You can then use the following selections.

Use selections...	To initialize...
1, 2, 3	the displayed Temp Map to one of three configurations.
1, 2	the Temp Map from its current configuration to one which reflects the currently stored Map A or B configurations, respectively.
3	the Temp Map to an all IDLE state.

Editing the Temp Map

If further changes to the Temp Map are needed, do the following:

Step	Action	Explanation
1	Use selection 7 to enter the Temp Map edit mode.	Upon entering this mode, the cursor location moves to DS0 number one in the DS0 field of the Temp Map. The cursor may be moved from one DS0 to another by using the up and down arrows until the cursor is located at the DS0 number whose assigned port needs to be changed.
2	Press the Enter key to cause the cursor to move into the Port field.	The up and down arrows are then used to scroll through the possible port selections.
3	Press the ESC key	This restores the previous port assignment and returns to the DS0 field.
4	Press the Enter key	This saves the current selected port and returns to the DS0 field. Once the cursor is again located in the Temp Map DS0 field, press the ESC key a second time to return to selection 1 below the Temp Map display.

Applying the Temp Map

Once the Temp Map reflects the desired configuration, use **selections 8** or **9** to apply this configuration to Map A or B, respectively.

Reviewing Maps

Selections 4 through **6** give a summary of the number of ports assigned to Map A, Map B, and the Temp Map, respectively.

Remote Menu Access

Displays telnet menus for a remote device (may be another TSU/TDU or any other ADTRAN product that supports telnet via its EIA-232 chain port). After selecting this option, you may choose to connect to a device entered in the Unit Access Table or enter a Unit ID for a unit not in the Unit Access Table. **CTRL + X** terminates the session and returns to the TSU 600 Main Menu.

Management Configuration

This menu sets management information, such as SNMP community names and trap destination addresses.

Unit Access Table

This menu edits and creates the Unit Access Table. This table stores the Unit ID, Passcode, and Unit Type for units connected via chain ports or connected remotely to the TSU/TDU (see *Figure 8-3* on page 8-6). An entry in the table is only required to support proxy SNMP MIB access or polling. For MIB access, an entry is required only if the unit's passcode is not the same as the Default Unit Passcode, or the unit is a single port TSU Stand-alone.



It is not necessary to have an entry in this table for a remote unit in order to telnet to it or forward SNMP traps from it. In the telnet case, the Remote Menu Access menu is selected from the Main menu and a Unit ID is entered which may or may not be in the Unit Access Table.

Units accessed via T-Watch PRO over TCP/IP use the Unit ID and passcode set by T-Watch PRO running on the PC.

Unit Access Table				
Unit ID	Passcode	Type	Polled	PollStatus
20	DEFAULT	Standard	No	
3	0033	Standard	Yes	UP
6	0095	TSU Stand Alone	No	
8	0022	Standard	Yes	UP
1) Add New Unit				
2) Modify Unit				
3) Delete Unit				
4) Default Unit Passcode 0022				
5) OK				

Figure 8-3. Unit Access Table

Add New Unit

This adds a new device to the table. You must enter a device Unit ID, passcode, unit type, and polled flag. The unit type can be Standard (which supports any TSU/TDU Multiplexer and the ISU 512) or TSU Standalone (a single port TSU with no option card slot). You can select a passcode of 0 to 9999 for each device or DEFAULT, in which the default passcode will be used. See *Figure 8-3*.

Traps are normally sent from the unit in alarm to the TSU 600. For units in the Unit Access Table that are not chained directly to the TSU 600 but are managed over Inband or the FDL, traps are not automatically forwarded. Polling must be enabled on the TSU 600 for these units in order to receive Traps on the NMS. The TSU 600 can be configured to poll selected units for traps by enabling the polled option when adding or modifying a unit entry.

Modify Unit

Allows Unit ID, passcode, device type, and polled flag to be changed for an existing entry in the table.

Delete Unit

Deletes an entry in the table.

Default Unit Passcode

Sets the default passcode for all devices in the table that have passcodes set to **DEFAULT**, or for any unit not listed in the table.

OK

Returns to the Configure Agent menu.

SNMP Read Community

SNMP Read Community Name defaults to public. NMSs using this community name have Read access for all supported MIB objects but do not have the ability to change MIB objects. This value must be set to the same value on both the TSU 600 and the NMS (OpenView®, etc.) in order for the NMS to have Read access to MIBs supported by the TSU 600. This value must be a text string of 16 characters or less.

SNMP Read/Write Community

SNMP NMS using this community name have full read/write access to all supported MIB objects (defaults to private). This setting must be the same value on both the TSU 600 and the NMS in order for the NMS to have read/write access to MIBS supported by the TSU 600. This value must be a text string that is 16 characters or less.



To access other units external to the TSU 600 (proxied units) using an SNMP MIB browser, append a period and the Unit ID of the external device to the Read Only and Read/Write community name used in the MIB Browser, for example, public.4. See Appendix A, Understanding SNMP on page A-1, for more information.

SNMP Trap Community

This community name is used for all SNMP traps forwarded by the TSU 600. Traps received from daisy chained units have a period and the Unit ID appended to the trap community name.

SNMP Trap Destination Address	Description
Host 1 Trap IP Address	This is the first of four entries for SNMP trap destination addresses. The TSU 600 forwards all SNMP traps to the IP address specified in this entry. If the address is set to the default value of 0.0.0.0, no traps are forwarded for this particular value.
Host 2 Trap IP Address	Defaults to 0.0.0.0. Second destination address for SNMP traps.
Host 3 Trap IP Address	Defaults to 0.0.0.0. Third destination address for SNMP traps.
Host 4 Trap IP Address	Defaults to 0.0.0.0. Fourth destination address for SNMP traps.

System Name

A text string that can uniquely identify an SNMP-managed node.

System Contact

A text string containing the name, phone number, etc. of the individual responsible for maintaining an SNMP-managed node.

System Location

A text string describing the physical location of an SNMP-managed node (for example, SECOND FLOOR PBX ROOM).

Auto. Fail Traps Sent

(DISABLED, ENABLED: defaults to DISABLED)

When enabled, the TSU 600 issues an SNMP trap when any SNMP request is received with an invalid community name. Can be used for security purposes.

Poll Link Status Traps Sent

(DISABLED, ENABLED, defaults to DISABLED)

When enabled, the TSU 600 sends an SNMP trap whenever a device configured to be polled fails to respond. When the device begins responding to polls, a poll link-up trap is sent. The formats of the traps are defined in the agent MIB.

Ping IP Host

Allows the user to Ping a specific IP address.

Telnet/Terminal Time-out

The TSU 600 terminates a telnet or terminal session if no activity is detected for this length of time. Only one telnet or terminal session may be active at one time. This time-out prevents an unattended session from blocking interactive access to the agent. The default value is five minutes.

Telnet/Terminal Password

This option allows modification of the password required for entry into a telnet or terminal session. The default value is ADTRAN.

Exit

Returns to the TSU 600 Main menu.

Flash Download

The TSU 600 uses flash memory that allows software updates via the chain-in port. This menu selection allows you to perform a flash download manually using XMODEM. T-Flash is also available to automate this process.

Quit Session

Terminates the telnet/terminal session.

Appendix A Understanding SNMP

As local area network (LAN) environments became standardized over the past ten years, multi-vendor equipment grew with competition. It became necessary to manage the various vendor equipment from a single control console. Thus, the SNMP emerged as the standard for managing commercial TCP/IP networks.

The term *SNMP* broadly refers to the message protocols used to exchange information between the network and the managed devices, as well as to the structure of network management databases.

Basic Components

SNMP has three basic components: **Network Manager**, **Agent**, and **MIB**.

Network Manager

This is a control program that collects, controls, and presents data pertinent to the operation of the network devices. It resides on a network management station.

Agent

This is a control program that responds to queries and commands from the network manager and returns requested information or invokes configuration changes initiated by the manager. It resides in each network device.

MIB

This is an index to the organized data within a network device. It defines the operating parameters that can be controlled or monitored. When requesting the network manager to retrieve or modify a particular piece of information about a network device, the network manager transmits the request to that network device. The agent in that device interprets the incoming request, performs the requested task, and sends its response to the network manager. The network manager collects all the data from the various network devices and presents it in a consistent form.

Commands

Using SNMP Version 1, the network manager can issue three types of commands: **GetRequest**, **GetNextRequest**, and **SetRequest**.

Command	Description
GetRequest	This command retrieves a single item or the first in a series from a network device.
GetNextRequest	This command retrieves the next item in a series from a network device.
SetRequest	This command writes information to a network device.

Message

The network device issues two types of messages: **GetResponse** and **Trap**.

Command	Description
GetResponse	This message is the response to a network manager GetRequest or GetNextRequest command.
Trap	This is an unsolicited message issued by a network device to report an operational anomaly or an alarm condition to the network manager. These messages are typically encased within informational packets and transported over the LAN or WAN (wide area network).

TSU 600 SNMP ACCESS

By default, SNMP MIB Browser access to the TSU 600 IP address with the configured community names, accesses the host. The TSU 600 can also act as an SNMP proxy agent for external units. To access MIB variables on externally chained devices, append a period and the Unit ID of the device to the **Read** and **Read/Write community names**.

Example:

If the **Read community** name configured in the TSU 600 is **public**, specifying "**public.3**" as the community name in the SNMP MIB Browser allows reading SNMP MIB variables from externally chained unit 3.

If the external unit's passcode is not the default, an entry must be added to the Unit Access Table for SNMP MIB access. See *Figure 8-3* on page 8-6 for a description of this operation. However, SNMP traps for the unit can be forwarded without the entry.

SNMP Trap Configuration

Traps received by the TSU 600 from external units and the host unit are converted into SNMP traps and forwarded to the configured NMS. The source of the trap is uniquely identified at the NMS by a combination of the IP address of the TSU 600, and the Unit ID of the sending device. The Unit ID is present in the trap packet appended to the end of the trap community packet name, for example **public.4**. It is also included as an Octet String variable (*adProdPhysAddress*) in the trap packet as defined in the individual product MIBs. The latest versions of the product MIBs by default display the appended trap community name in their descriptions.

Typical steps required for Management Station trap configuration are loading the device specific MIBs and loading or creating device specific Trap Definition Files. The current product MIBs contain keywords embedded in comments that can be used by some network management platforms to automatically generate Trap Definitions. Otherwise, the descriptions may be used as a template for Trap Definitions.

If individual option card port identification and slot identification are required, they are present in the four byte *adProdPhysAddress* field of the trap packet. The first two bytes are the Unit ID of the base controller (least significant byte first). The next two bytes are port and slot number. This field is the second object identifier in all traps sent from TSU/TDU products.

For traps from the ISU 512, the Unit ID is the first object identifier. See the product MIBs for more information.

Definitions for Poll Link Up/Down traps are included in the TSU 600 MIB file: 600e.MIB.

 **NOTE** *The TSU 600 and TSU 600e share the same MIB.*

SNMP MIB Browser Configuration

The steps required to configure Network Manager MIB variable access through the TSU 600 are as follows:

1. Load the desired product MIBs on the network management station. If, for example, the administrator is managing TSU 600 and ISU 512 devices, load TSU 600e.MIB, ISU512.MIB, and RFC1406.MIB.
2. Create device entries in the NMS database for all units that are to be managed through the TSU 600. The host unit should be configured as the Proxy agent for the external units. The IP address or host name used for the proxy designation is that of the TSU 600.
3. Set community names in the device's entries for external units to the TSU 600 community name with the device Unit ID appended as defined in the previous section, *TSU 600 SNMP ACCESS* on page A-3.
4. Set the device timeout for all device entries in the NMS device database to five seconds, including the host unit.

SNMP MIB Files

The TSU 600 supports several standard MIBs including MIB-II (RFC-1213), the **DS1 T1/E1 MIB (RFC-1406)**, and the **Ethernet MIB (RFC-1643; 600e only)**. It also supports several ADTRAN enterprise specific MIBs including the **ADTRAN Product MIB (ADTRAN.MIB)**, the **ADTRAN DS1 extensions MIB (ADS1.MIB)**, and all **TSU/TDU Enterprise MIBs**, such as **600e.MIB**. The standard MIB files are usually included with most SNMP network management software.

The latest versions of the ADTRAN enterprise-specific MIBs are available in the following locations:

- ADTRAN anonymous ftp site (<ftp.adtran.com>),
- By dial-up from the BBS (256-963-8169).
- ADTRAN web site at <http://www.adtran.com>.

Appendix B Understanding TR-08

The TSU 600 chassis functions as a **Remote Terminal in Digital Loop Carrier** and as **Integrated Digital Loop Carrier Systems** as described in TR-TSY 000008. The TSU 600 supports SLC96 framing, Mode I operation, ORB-13 and ORB-16 alarm formats, alarm reporting, and user-definable BPV threshold detection rate.

A basic familiarity with DLC systems, IDLC systems, and TR-TSY-000008 is assumed, but the following information will be useful:

- All received **TR-TSY-000008 specific alarms** are reported locally within the history feature of the TSU 600.
- When the **DISABLE ALARMS** option is selected, no alarms will be sent on the DLF, but received alarms will be reported locally in the history.
- Other alarms normally reported by the TSU 600 will also be placed in history.
- Each TSU 600 needs to be configured as the **A SHELF**, as it is provisioned as a separate entity.
- All alarms will refer to **A SHELF** when received from TSU 600.

The following table explains what conditions trigger alarms and how alarms are processed when received by the TSU 600.

Table B-1. Alarm Conditions

Name	Explanation
FELP	When the TSU 600 receives a FELP alarm, it will loop the incoming data directly to the outgoing data. LINE ON is placed in history. The alarms and loopback are cleared when FELP is no longer received.
Loss of Data	The TSU 600 will send MINOR ALARM and the A SHELF ALARM for 2.5s when it quits receiving the data link on the T-Span. It will also report TR-08 DL Down in the history. After 2.5s, MAJOR ALARM, A SHELF ALARM are sent across the Data Link.
OOF	The TSU will send MINOR ALARM and A SHELF ALARM upon receiving an out-of-frame condition. TR-08 DL Down and RED ALARM are declared in history for severe framing errors. After 2.5s, MAJOR ALARM, A SHELF ALARM are sent across the Data Link.
Loss of Signal	The TSU 600 will send MINOR ALARM and the A SHELF ALARM for 2.5s when it quits receiving a signal from the far end. It will also report TR-08 DL Down and LOS in the history. After 2.5s, MAJOR ALARM, A SHELF ALARM are sent across the Data Link, and RED ALARM is declared in history.
BPVs	BPVs that are received at a rate greater than the threshold set under TR-08 options, will cause MINOR ALARM and A SHELF ALARM to be sent on the DL. If the BPVs remain above the threshold for 2.5s, the TSU 600 will send MAJOR ALARM and on the DL. No events are placed in history.
Protection Line Switch	The TSU will not respond to this alarm.

TR-08 DSO Conversion Table

The following table contains the mapping conversions needed to map voice ports to the TR-08 network.

Table B-2. TR-08 DSO Conversion Table

DS0	TR-08 Channel Number	Port
1	1	1.1
3	2	1.2
5	3	1.3
7	4	1.4
9	5	2.1
11	6	2.2
13	7	2.3
15	8	2.4
17	9	3.1
19	10	3.2
21	11	3.3
23	12	3.4
2	13	4.1
4	14	4.2
6	15	4.3
8	16	4.4
10	17	5.1
12	18	5.2
14	19	5.3
16	20	5.4
18	21	6.1
20	22	6.2
22	23	6.3
24	24	6.4

WIRING**Network**

On the rear panel of the TSU 600 is an 8-position modular jack labeled NETWORK. This connector is used for connecting to the network. See *Table C-1, Network Pinouts* for the pinout for the network connector.

Network Connections

The network connections are as follows:

Connector Type	(USOC) RJ-48C
Part Number	AMP# 555164-2

Table C-1. Network Pinouts

Pin	Name	Description
1	R1 RXDATA-RING	Receive data from the network
2	T1 RXDATA-TIP	Receive data from the network
3	UNUSED	
4	R1 TXDATA-RING	Send data toward the network
5	T TXDATA-TIP	Send data toward the network
6,7,8	UNUSED	

Control In/Chain In

This is used as an EIA-232 port for connection to a computer or modem (Control-in) or to another TSU 600 or TSU 100 (chain-in). See *Table C-2, Control In/Chain In Pinout* for the pinout for the control-in/chain-in connector.

Chain-in Connections

The chain-in connections are as follows:

Connector Type	RJ-48
Part Number	AMP# 555164-2

Table C-2. Control In/Chain In Pinout

Pin	Name	Description
1	GND	Ground-connected to unit chassis
2	RTS	Request to send-flow control
3	RXDATA	Data received by the TSU 600
4	UNUSED	
5	TXDATA	Data transmitted by the TSU 600
6,7	UNUSED	
8	CTS	Clear to send -- flow control

Chain-Out

This is used to connect to another TSU 600 chain-in connector. See *Table C-3, Chain-Out Pinout* for the pinout for the chain-out connector.

Chain-out Connections

The chain-out connections are:

Connector Type	RJ-48
Part Number	AMP# 555164-2

Table C-3. Chain-Out Pinout

Pin	Name	Description
1	GND	Ground-connected to unit chassis. Connected to GND of next unit (pin 10).
2	UNUSED	
3	TX DATA	Data transmitted to chained units by the TSU 600. Connect to RX DATA of the next unit (chain-in pin 3).
4	UNUSED	
5	RX DATA	Data received from chained units by the TSU 600. Connect to TX DATA of the next unit (chain-in pin 5).
6,7,8	UNUSED	

10BaseT (600e only)

10BaseT is used to connect the TSU 600e to the Local Area Network. See Table C-4.

10BaseT Connections

The required wiring connections are:

Connector Type (USOC) RJ-45
Part Number AMP# 555164-1

Table C-4. 10BaseT Ethernet

Pin	To NIC
1	TX1
2	TX2
3	RX1
6	RX2

This appendix lists and defines the alarm and status messages that appear on the TSU 600 screen.

Alarm Messages: Network Interface (NI)

Message	Description
Red Alarm	NI unable to frame align with incoming signal
Yellow Alarm	Remote alarm indication (RAI) being received from far end
Blue Alarm	Unframed all ones (1s) (AIS) being received at NI
Loss of Signal	No signal detected at NI

Status Messages: Network Interface (NI)

Message	Description
Payload On	Payload loopback activated
Line On	Loopback off
Loopback Off	All loopbacks deactivated
Factory Restore	Factory setting restored
Power On	Unit powered on
Self-Test	Internal self-test performed
TR-08 DL Down*	TR-08 data link is down
TR-08 DL Up*	TR-08 data link is up
Minor Alarm*	Loss of sync, carrier loss, BPV threshold exceeded, or data link failure.
Major Alarm*	Conditions for a minor alarm have continued for greater than 2.5 seconds.



**TR-08 alarm messages appearing in the alarm or history log have been received from the far end. If the NI detects one of the above conditions, it will send the appropriate alarm (if enabled) to the far end but no message will appear in the alarm or history log.*

ELECTRICAL SPECIFICATIONS**T1/FT1 Interface**

T1 Line Rate	1.544 Mbits/s \pm 75bps
Line Code	Bipolar, RZ; AMI or B8ZS
Framing	D4(SF), ESF, or SLC96
FT1 Line Rate	DS0 Channelized (multiple of 64 kbps)
Transmit Timing	Network, DTE, U-BR1TE Secondary NI, Normal (CSU) or Internal
Input Signal	0 to -36 dB (DS-1)
Line Build-out	0, 7.5, 15, 22.5 dB, AUTO
Connector	RJ-45
Test Jacks	Bantam jacks: TX and RX (to Network) and MON

Compatibility

T1 Interface	Pub 62411
ESF Format Interface	TR. 194
ESF Performance Monitoring	TR. 54016 and T1.403
Approvals:	FCC Part 15 FCC Part 68 UL 1950

Management Interfaces

Chain-In/Chain-Out Ports

Interface Devices	PC Serial Port, Modem or SLIP connection to router
Interface Type	EIA-232
Data Rates	1200, 2400, 4800, 9600, 19200, 38400
Data Format	EIA-232 N81
Protocols	TWATCH/ADLP, ATEL/ADLP, SLIP, TCP/IP
Connector	RJ-45

Option Slot Interface

Slots 1-6

Interface	ADTRAN proprietary, accepts standard TSU Option Modules.
------------------	--

Chassis Specification

Height	Less than 5.25-inch (will fit in a 3U rack mount opening)
Width	Will fit within a 19-inch rack

Environmental Specifications

Input Power	TSU 600: 90 - 130 VAC 60 HZ TSU 600e: 90 - 120 VAC 50/60 HZ DC powered units: 21 - 26 VDC or 40 - 56 VDC
Fuse	AC powered units: 1A, 250V DC powered units: 5A, 250V
Operating Temperature	0 to 45 degrees C
Max Power Consumption	40 W
Max Current	AC powered units: 0.7A DC powered units: 3A

Index

Numerics

10BaseT Connections C-4
10BaseT Interface 2-10
10BaseT, interface with SNMP 3-12

A

Access, unit menu 5-9
Active Alarms 4-4
Add New Unit to unit access table, how to 8-6
ADTRAN PC Management Program, T-Watch PRO 3-11
ADTRAN PC Program, T-Watch PRO 3-11
ADTRAN Web page 3-12
Agent, SNMP component A-1
AIS Alarm, (Blue Alarm) network interface alarm message D-1
Alarm (red), LED description 3-2
Alarm (red), module status LED 3-3
Alarm Conditions, TR-08 B-2
Alarm Format, TR-08 5-3
Alarm Messages
 Network Interface (NI) D-1
Alarm Messages, Network Interface D-1
Alarm Report, TR-08 5-3
Alarm, operation key 3-5
ANSI FDL LLB, remote loopback 7-4

ANSI FDL PLB, remote loopback 7-4
ANSI FT1 LLB, remote loopback 7-4
APPLY TEMP > A, DS0 map menu item 5-13
Applying the Temp Map, how to 8-4
AS, available sec., NI errors 4-2
ATT In-Band LLB, remote loopback 7-4
Auto. Fail Traps Sent, SNMP 8-9

B

Backup Power Supply for TSU 600e 2-2
BES, pattern result, test menu 7-6
BIT STUFFING, network menu item 5-3
Blue Alarm, (AIS alarm), network interface alarm message D-1
Board level tests 2-12
Board level tests, run self-test 7-7
BPV Threshold, TR-08 5-3
BPV, TSU 600 T1 error 4-3, 5-3
BPVs, alarm condition TR-08 B-2

C

Cancel Tests, test menu 7-8
Cancel, front panel 3-1
Chain In/Chain Out 2-13

Index

Chain Port Output 2-9
Chain-In (PC) 2-13
Chain-in Connections C-2
Chain-out Connections C-3
Chain-Out Pinout C-3
Chassis Specification E-2
Clear alarm history 4-4
Clear Port Alarm 4-5
Clear,operation key 3-5
CMD Mode, utility menu 6-4
Config, front panel menu 3-10
configuration applications, TSU 600 1-5
Configuration Menu Tree 5-1
Control Port Input 2-9
Control Port, unit menu 5-9
COPY A >TEMP, DS0 map menu item 5-12
Copy, operation key 3-5
CRC, TSU 600 T1 error 4-3
CREATE TEMP, DS0 map menu item 5-12
Create Temp, example, how to 5-13
Ctl Port Rate, unit menu 5-9

D

Data Port Identification 3-9
data port identification 3-9
DC Powered TSU 600, about 2-2
Default Router,unit menu 5-10
Delete Unit in unit access table, how to 8-6
Dial Backup, option module for TSU 600 1-3
Display Only Data Fields 3-8
Drop and Insert, Voice and Router Application 1-6
DS0 Map A and DS0 Map B Menu 5-12
DS0 Maps Configuration Menu 8-2
DS0 Map A and DS0 Map B 5-12
DSU DP, option module for TSU 600

1-3
DSX1 , option module for TSU 600 1-3
DTE Timing 5-5

E

EDIT TEMP, DS0 map menu item 5-13
Editing the Data Field, how to 3-7
Editing the Temp Map, how to 8-4
EF, error free sec., NI errors 4-2
Electrical specifications, TSU 600 E-1
ENET Address, utility menu 6-4
ENET Status 4-6
Enter, front panel 3-1
Environmental Specifications E-3
Error (red), LED description 3-2
ES, Errored Sec., NI Errors 7-6
ES, errored sec., NI errors 4-2
Exit Any Menu Field Operation Or Display, how to 3-8

F

Factory Restore, network interface status message D-2
features, TSU 600 1-2
FELP, alarm condition TR-08 B-2
FER, TSU 600 T1 error 4-3
Flash Download 8-9
Flash Download, telnet/terminal menu 8-9
Front Panel Menu Structure 3-10
front panel menu tree 3-6
Front Panel, description 3-1
Full Drop and Insert, option module for TSU 600 1-3

G

GetNextRequest, SNMP command A-2
GetRequest, SNMP command A-2

-
- GetResponse, SNMP message A-2
 - Grounding Instructions 2-4
 - H**
 - Home, operation key 3-5
 - http
 - //www.adtran.com, ADTRAN Web page 3-12
 - I**
 - INBAND LPBCK, network menu item 5-3
 - Init Modem, unit menu 5-9
 - Initialization 2-12
 - Initializing the Temp Map, how to 8-3
 - Installing and Replacing the Power Supply, how to 2-3
 - Internal Timing 5-6
 - IP Address, unit menu 5-9
 - L**
 - LCD Menu Options 3-10
 - LCD Window, front panel 3-1
 - Line On, network interface status message D-2
 - Line On, setting local loopback 7-3
 - Local Loopback, test menu 7-3
 - Loopback Off, network interface status message D-2
 - Loopback Tests, test menu 7-2
 - Loss of Data, alarm condition TR-08 B-2
 - Loss of Signal, alarm condition TR-08 B-2
 - Loss of Signal, network interface alarm message D-1
 - M**
 - Major Alarm, network interface status message D-2
 - Management Configuration 8-5
 - Management software - T-Watch PRO 3-11
 - Map Exchange Menu 5-11
 - MAP In Use
 - A(B) Menu 5-11
 - MIB, SNMP component A-2
 - Minor Alarm, network interface status message D-2
 - Modify Unit to unit access table, how to 8-6
 - Module Status LEDs 3-5
 - N**
 - Network 7-2
 - Network (NI) Menu Item, configuration menu 5-2
 - Network (NI), configuration menu 5-2
 - network connections, pinouts C-1
 - Network Interface Errors 4-3
 - Network Interface Loopbacks, test menu 7-3
 - network interface, (NI) port 2-9
 - Network Manager, SNMP component A-1
 - Network Performance Reports 4-2
 - Network Test Interface 2-9
 - Network Tests, test menu 7-2
 - Network, pinouts C-1
 - NI errors, AS (available sec.) 4-2
 - NI errors, EF (error free sec.) 4-2
 - NI errors, ES (errored sec.) 4-2
 - NI Errors, ES, Errored Sec 7-6
 - NI errors, SES, Severly Errored Seconds 7-6
 - NI errors, SES, severly errored seconds 4-2
 - NI errors, UAS (unavailable errored sec.) 4-2
 - No Loopback, remote loopback 7-4
-

Index

No Loopback, setting local loopback 7-3
No Unit ID Desired, utility menu, what to do 6-4
Normal (CSU) Timing 5-8
Normal Power-Up Procedure 2-14
Numeric Keypad, front panel 3-1
Nx56 1-3
Nx56/64 module, router interface 1-6
Nx56/64 Serial Interface, option module for TSU 600 1-3
NxIQ, option module for TSU 600 1-3

O

OCU DP, option module for TSU 600 1-3
OFF, map exchange menu 5-11
OK (green), LED description 3-2
OK (green), module status LED 3-3
OOF, alarm condition TR-08 B-2
operation keys 3-5
Option Module Architecture 1-4
Option Module Architecture, for TSU 600 1-4
Option Slot Arrangement, for TSU 600 2-10

P

Pattern Result, test menu 7-6
Payload On, network interface status message D-2
Payload On, setting local loopback 7-3
Ping IP Host, SNMP 8-9
Poll Link Status Traps Sent, SNMP 8-9
port configuration 5-15
Port Status 4-5
Port Tests, test menu 7-8
Port Utility, utility menu 6-4
Power Connection for TSU 600 2-2
Power On, network interface status

message D-2
power-up procedure 2-14
Power-up Testing 2-11
Product Description, TSU 600 1-1
Product Overview, TSU 600 1-1
Protection Line Switch, alarm condition TR-08 B-2
Proxy Traps, unit menu 5-10
PS Status, power supply 4-6

Q

QRSS Pattern, test menu 7-5
Quit Session, telnet/terminal session 8-9

R

Rear Panel Layout, of TSU 600 2-5
Receipt Inspection, for TSU unit 2-1
Red Alarm, network interface alarm message D-1
Remote Loopbk 7-4
Remote Menu Access 8-5
Remote Port 4-5
REVIEW MAP A(B), DS0 map menu item 5-13
REVIEW TEMP, DS0 map menu item 5-13
Reviewing Maps, how to 8-4
router interface with Nx56/64 module 1-6
Router, PBX, Video Conferencing Application 1-5
Run Self-Test, test menu 7-7

S

Secondary Timing 5-7
Selecting and Activating a Menu Item, how to 3-6
Self-Test, network interface status message D-2
SES, Severly Errored Seconds, NI

errors 7-6
SES, severely errored seconds, NI errors 4-2
Set Control Port 2-13
SET LBO, network menu item 5-3
Set Passcode, how to 6-2
Set Unit Identification 2-12
Set User Passcode 2-12
SetRequest, SNMP command A-2
Setting the Unit Identification for utility menu, how to 6-4
Shift, front panel 3-2
shipping damages, what to do 2-1
Simple Network Management Protocol (SNMP) 3-12
SLIP Flow CTL, unit menu 5-10
SLIP Rate, unit menu 5-10
SNMP Commands A-2
SNMP Messages A-2
SNMP MIB Browser Configuration A-4
SNMP MIB Files A-4
SNMP Trap Community 8-8
SNMP Trap Configuration A-3
SNMP, Basic Components A-1
SNMP, how to use with TSU 600 3-12
Software Revision (Software Rev), utility menu 6-4
Status menu, description 4-1
Status Messages, Network Interface D-2
Status, Config, Util, and Test Menu Options 8-2
Status, front panel menu 3-10
Subnet Mask, unit menu 5-10
SYNC, pattern result, test menu 7-6
System (green), module status LED 3-3
system contact, SNMP text string 8-8
system location, SNMP text string 8-8
system name, SNMP text string 8-8

T

Telnet Connection 3-13
Telnet/Terminal Main Menu 8-1
Telnet/Terminal Password, SNMP 8-9
Telnet/Terminal Time-out, SNMP 8-9
Terminal Mode Connection 3-13
Test (yellow), LED description 3-2
Test (yellow), module status LED 3-3
Test menu 7-1
Test Pattern, test menu 7-5
Test, front panel menu 3-10
TR-08 alarm conditions B-2
TR-08 DL Down, network interface status message D-2
TR-08 DL Up, network interface status message D-2
TR-08 DS0 Conversion Table B-3
TR-08, network menu item 5-3
Trap, SNMP message A-2
Traps, unit menu 5-9
TSU 600 Clock Sources 5-4
TSU 600 Configuration Applications 1-5
TSU 600 Electrical specifications E-1
TSU 600 Front Panel Layout, with descriptions 3-4
TSU 600 General Menu Operation 3-5
TSU 600 Interfaces 2-6, 2-9
TSU 600 interfaces 2-6
TSU 600 Option Modules, option modules, for TSU 600 1-3
TSU 600 SNMP access A-3
TSU 600, Overview 1-1
TSU 600, power connection 2-2
TSU 600, Standard Features 1-2
TSU Product Description 1-1
T-Watch PRO 3-11
T-Watch PRO, modem connection 3-11
T-Watch PRO/EIA-232 Connection

Index

3-12

T-Watch PRO/LAN Connection 3-11

U

UAS, unavailable errored sec., NI errors 4-2

U-BR1TE (Slot 1) 5-5

U-BR1TE , option module for TSU 600 1-3

Unit Access Table 8-5

unit level tests 2-12

Unit level tests, run self-test 7-7

Unit Menu 5-9

Up and down arrows, front panel 3-1

Util, front panel menu 3-10

utility menu tree 6-1

V

Voice Interface, option module for TSU 600 1-3

W

Wiring, network pinouts C-1

X

XS0, TSU 600, T1 alarm 4-3

Y

Yellow Alarm, network interface alarm message D-1

Product Support Information

Presales Inquiries and Applications Support

Please contact your local distributor, ADTRAN Applications Engineering, or ADTRAN Sales:

Applications Engineering (800) 615-1176

Sales (800) 827-0807

Post-Sale Support

Please contact your local distributor first. If your local distributor cannot help, please contact ADTRAN Technical Support and have the unit serial number available.

Technical Support (888) 4ADTRAN

Repair and Return

If ADTRAN Technical Support determines that a repair is needed, Technical Support will coordinate with the Customer and Product Service (CaPS) department to issue an RMA number. For information regarding equipment currently in house or possible fees associated with repair, contact CaPS directly at the following number:

CaPS Department (256) 963-8722

Identify the RMA number clearly on the package (below address), and return to the following address:

ADTRAN, Inc.
CaPS Department
6767 Old Madison Pike
Progress Center
Building #6, Suite 690
Huntsville, AL 35807

RMA # _____

Free Manuals Download Website

<http://myh66.com>

<http://usermanuals.us>

<http://www.somanuals.com>

<http://www.4manuals.cc>

<http://www.manual-lib.com>

<http://www.404manual.com>

<http://www.luxmanual.com>

<http://aubethermostatmanual.com>

Golf course search by state

<http://golfingnear.com>

Email search by domain

<http://emailbydomain.com>

Auto manuals search

<http://auto.somanuals.com>

TV manuals search

<http://tv.somanuals.com>