



# Smart 16 Shelf

## User Manual

- 4202023L1**    **Smart 16, 2nd, AC Version**
- 4202023L2**    **Smart 16, 2nd, Dual AC Version**
- 4202023L3**    **Smart 16, 2nd, DC Version**
- 4202023L4**    **Smart 16, 2nd, Dual DC Version**

64202023L1-1A  
February 2002



901 Explorer Boulevard  
P.O. Box 140000  
Huntsville, AL 35814-4000  
(256) 963-8000

© 2002 ADTRAN, Inc.  
All Rights Reserved.  
Printed in U.S.A.

The following conventions are used in this manual.



*Notes provide additional useful information.*



*Cautions signify information that could prevent service interruption.*



*Warnings provide information that could prevent damage to the equipment or endangerment to human life.*

## **IMPORTANT SAFETY INFORMATION**

When using your telephone equipment, please follow these basic safety precautions to reduce the risk of fire, electrical shock, or personal injury:

1. Do not use this product near water, such as near a bath tub, wash bowl, kitchen sink, laundry tub, in a wet basement, or near a swimming pool.
2. Avoid using a telephone (other than a cordless-type) during an electrical storm. There is a remote risk of shock from lightning.
3. Do not use the telephone to report a gas leak in the vicinity of the leak.
4. Use only the power cord, power supply, and/or batteries indicated in the manual. Do not dispose of batteries in a fire. They may explode. Check with local codes for special disposal instructions.

**SAVE THESE INSTRUCTIONS**

## **Affidavit Requirements for Connection to Digital Services**

- An affidavit is required to be given to the telephone company whenever digital terminal equipment without encoded analog content and billing protection is used to transmit digital signals containing encoded analog content which are intended for eventual conversion into voice band analog signal and transmitted on the network.
- The affidavit shall affirm that either no encoded analog content or billing information is being transmitted or that the output of the device meets Part 68 encoded analog content or billing protection specification.
- End use/customer will be responsible to file an affidavit with the local exchange carrier when connecting unprotected CPE to a 1.544 Mbps or subrate digital service.
- Until such time as subrate digital terminal equipment is registered for voice applications, the affidavit requirements for subrate services are waived.

**Affidavit for Connection of Customer Premises Equipment to 1.544 MBPS and/or Subrate Digital Services**

For the work to be performed in the certified territory of \_\_\_\_\_ (telco name)

State of \_\_\_\_\_

County of \_\_\_\_\_

I, \_\_\_\_\_ (name), \_\_\_\_\_ (business address),  
\_\_\_\_\_ (telephone number) being duly sworn, state:

I have the responsibility for the operation and maintenance of the terminal equipment to be connected to 1.544 Mbps and/or \_\_\_\_\_ subrate digital services. The terminal equipment to be connected complies with Part 68 of the FCC rules except for the encoded analog content and billing protection specification. With respect to encoded analog content and billing protection:

( ) I attest that all operations associated with the establishment, maintenance and adjustment of the digital CPE with respect to encoded analog content and billing protection information continuously complies with Part 68 of the FCC rules and Regulations.

( ) The digital CPE does not transmit digital signals containing encoded analog content or billing information which is intended to be decoded within the telecommunications network.

( ) The encoded analog content and billing protection is factory set and is not under the control of the customer.

I attest that the operator(s) maintainer(s) of the digital CPE responsible for the establishment, maintenance and adjustment of the encoded analog content and billing information has (have) been trained to perform these functions by successfully having completed one of the following (check appropriate blocks):

( ) A. A training course provided by the manufacturer/grantee of the equipment used to encode analog signals; or

( ) B. A training course provided by the customer or authorized representative, using training materials and instructions provided by the manufacturer/grantee of the equipment used to encode analog signals; or

( ) C. An independent training course (e.g., trade school or technical institution) recognized by the manufacturer/grantee of the equipment used to encode analog signals; or

( ) D. In lieu of the preceding training requirements, the operator(s)/maintainer(S) is (are) under the control of a supervisor trained in accordance with \_\_\_\_\_ (circle one) above.

I agree to provide \_\_\_\_\_ (telco's name) with proper documentation to demonstrate compliance with the information in the preceding paragraph, if so requested.

\_\_\_\_\_ Signature

\_\_\_\_\_ Title

\_\_\_\_\_ Date

Subscribed and sworn to before me

This \_\_\_\_\_ day of \_\_\_\_\_, 20\_\_

\_\_\_\_\_  
Notary Public

My commission expires: \_\_\_\_\_

**FCC regulations require that the following information be provided in this manual:**

1. This equipment complies with Part 68 of the FCC rules. There is a label on the equipment that shows the FCC registration number and Ringer Equivalence Number (REN) for this equipment, if applicable. If required, this information must be given to the telephone company.
2. The following information may be required when applying to the local telephone company for leased line facilities.

<b>Service Type</b>	<b>Digital Facility Interface Code</b>	<b>Service Order Code</b>	<b>Network Jacks</b>
2.4 kbps Digital Interface	04DU5-24	6.0F	RJ-48S
4.8 kbps Digital Interface	04DU5-48	6.0F	RJ-48S
9.6 kbps Digital Interface	04DU5-96	6.0F	RJ-48S
19.2 kbps Digital Interface	04DU5-19	6.0F	RJ-48S
38.4 kbps Digital Interface	04DU5-38	6.0F	RJ-48S
56 kbps Digital Interface	04DU5-56	6.0F	RJ-48S
64 kbps Digital Interface	04DU5-64	6.0F	RJ-48S
Basic Rate ISDN	02IS5	6.0N	RJ-49C
1.544 Mbps-SF	04DU9-BN	6.0F	RJ-48C
1.544 Mbps-SF and B8ZS	04DU9-DN	6.0F	RJ-48C
1.544 Mbps-ESF	04DU9-1KN	6.0F	RJ-48C
1.544 Mbps-ESF and B8ZS	04DU9-1SN	6.0F	RJ-48C

3. An FCC compliant telephone cord with a modular plug may be provided with this equipment. This equipment is designed to be connected to the telephone network or premises wiring using a compatible modular jack, which is FCC Part 68 compliant. See installation instructions for details.
4. If this equipment causes harm to the telephone network, the telephone company may temporarily discontinue service. If possible, advance notification is given; otherwise, notification is given as soon as possible. The telephone company will advise the customer of the right to file a complaint with the FCC.
5. The telephone company may make changes in its facilities, equipment, operations, or procedures that could affect the proper operation of this equipment. If this happens, the telephone company will provide advance notification and the opportunity to make the necessary modifications to maintain uninterrupted service.



6. If experiencing difficulty with this equipment, please contact ADTRAN for repair and warranty information. If the equipment is causing harm to the network, the telephone company may request this equipment to be disconnected from the network until the problem is resolved or it is certain that the equipment is not malfunctioning.
7. This unit contains no user serviceable parts.
8. The FCC recommends that the AC outlet to which equipment requiring AC power is to be installed is provided with an AC surge arrester.

## Federal Communications Commission Radio Frequency Interference Statement

This equipment has been tested and found to comply with the limits for a Class A digital device, pursuant to Part 15 of the FCC Rules. These limits are designed to provide reasonable protection against harmful interference when the equipment is operated in a commercial environment. This equipment generates, uses, and can radiate radio frequency energy and, if not installed and used in accordance with the instruction manual, may cause harmful interference to radio frequencies. Operation of this equipment in a residential area is likely to cause harmful interference in which case the user will be required to correct the interference at his own expense.

Shielded cables must be used with this unit to ensure compliance with Class A FCC limits.



*Change or modifications to this unit not expressly approved by the party responsible for compliance could void the user's authority to operate the equipment.*

### **Industry Canada Compliance Information**

Notice: The Industry Canada label applied to the product (identified by the Industry Canada logo or the “IC:” in front of the certification/registration number) signifies that the Industry Canada technical specifications were met.

Notice: The Ringer Equivalence Number (REN) for this terminal equipment is supplied in the documentation or on the product labeling/markings. The REN assigned to each terminal device indicates the maximum number of terminals that can be connected to a telephone interface. The termination on an interface may consist of any combination of devices subject only to the requirement that the sum of the RENs of all the devices should not exceed five (5).

### **Canadian Emissions Requirements**

This digital apparatus does not exceed the Class A limits for radio noise emissions from digital apparatus as set out in the interference-causing equipment standard entitled “Digital Apparatus,” ICES-003 of the Department of Communications.

Cet appareil numérique respecte les limites de bruits radioélectriques applicables aux appareils numériques de Class A prescrites dans la norme sur le matériel brouilleur: “Appareils Numériques,” NMB-003 édictée par le ministre des Communications.

## LIMITED PRODUCT WARRANTY

ADTRAN warrants that for five (5) years from the date of shipment to Customer, all products manufactured by ADTRAN will be free from defects in materials and workmanship. ADTRAN also warrants that products will conform to the applicable specifications and drawings for such products, as contained in the Product Manual or in ADTRAN's internal specifications and drawings for such products (which may or may not be reflected in the Product Manual). This warranty only applies if Customer gives ADTRAN written notice of defects during the warranty period. Upon such notice, ADTRAN will, at its option, either repair or replace the defective item. If ADTRAN is unable, in a reasonable time, to repair or replace any equipment to a condition as warranted, Customer is entitled to a full refund of the purchase price upon return of the equipment to ADTRAN. This warranty applies only to the original purchaser and is not transferable without ADTRAN's express written permission. This warranty becomes null and void if Customer modifies or alters the equipment in any way, other than as specifically authorized by ADTRAN.

EXCEPT FOR THE LIMITED WARRANTY DESCRIBED ABOVE, THE FOREGOING CONSTITUTES THE SOLE AND EXCLUSIVE REMEDY OF THE CUSTOMER AND THE EXCLUSIVE LIABILITY OF ADTRAN AND IS IN LIEU OF ANY AND ALL OTHER WARRANTIES (EXPRESSED OR IMPLIED). ADTRAN SPECIFICALLY DISCLAIMS ALL OTHER WARRANTIES, INCLUDING (WITHOUT LIMITATION), ALL WARRANTIES OF MERCHANTABILITY AND FITNESS FOR A PARTICULAR PURPOSE. SOME STATES DO NOT ALLOW THE EXCLUSION OF IMPLIED WARRANTIES, SO THIS EXCLUSION MAY NOT APPLY TO CUSTOMER.

In no event will ADTRAN or its suppliers be liable to Customer for any incidental, special, punitive, exemplary or consequential damages experienced by either Customer or a third party (including, but not limited to, loss of data or information, loss of profits, or loss of use). ADTRAN is not liable for damages for any cause whatsoever (whether based in contract, tort, or otherwise) in excess of the amount paid for the item. Some states do not allow the limitation or exclusion of liability for incidental or consequential damages, so the above limitation or exclusion may not apply to Customer.

## **Customer Service, Product Support Information, and Training**

ADTRAN will repair and return this product if within five years from the date of shipment the product does not meet its published specification or the product fails while in service.

A return material authorization (RMA) is required prior to returning equipment to ADTRAN. For service, RMA requests, training, or more information, use the contact information given below.

### **Repair and Return**

If you determine that a repair is needed, please contact our Customer and Product Service (CAPS) department to have an RMA number issued. CAPS should also be contacted to obtain information regarding equipment currently in house or possible fees associated with repair.

CAPS Department                      (256) 963-8722

Identify the RMA number clearly on the package (below address), and return to the following address:

ADTRAN Customer and Product Service  
901 Explorer Blvd. (East Tower)  
Huntsville, Alabama 35806

RMA # \_\_\_\_\_

### **Pre-Sales Inquiries and Applications Support**

Your reseller should serve as the first point of contact for support. If additional pre-sales support is needed, the ADTRAN Support web site provides a variety of support services such as a searchable knowledge base, latest product documentation, application briefs, case studies, and a link to submit a question to an Applications Engineer. All of this, and more, is available at:

<http://support.adtran.com>

When needed, further pre-sales assistance is available by calling our Applications Engineering Department.

Applications Engineering    (800) 615-1176

## Post-Sale Support

Your reseller should serve as the first point of contact for support. If additional support is needed, the ADTRAN Support web site provides a variety of support services such as a searchable knowledge base, updated firmware releases, latest product documentation, service request ticket generation and trouble-shooting tools. All of this, and more, is available at:

<http://support.adtran.com>

When needed, further pre-sales assistance is available by calling our Technical Support Center. Please have your unit serial number available when you call.

Technical Support                      (888) 4ADTRAN

## Installation and Maintenance Support

The ADTRAN Custom Extended Services (ACES) program offers multiple types and levels of installation and maintenance services which allow you to choose the kind of assistance you need. This support is available at:

<http://www.adtran.com/aces>

For questions, call the ACES Help Desk.

ACES Help Desk                      (888) 874-ACES (2237)

## Training

The Enterprise Network (EN) Technical Training Department offers training on our most popular products. These courses include overviews on product features and functions while covering applications of ADTRAN's product lines. ADTRAN provides a variety of training options, including customized training and courses taught at our facilities or at your site. For more information about training, please contact your Territory Manager or the Enterprise Training Coordinator:

Training Phone                      (800) 615-1176, ext. 7500  
Training Fax                          (256) 963-6700  
Training Email                      training@adtran.com

# Table of Contents

---

<b>List of Figures</b> .....	<b>xvii</b>
<b>List of Tables</b> .....	<b>xix</b>
<b>Chapter 1. Introduction</b> .....	<b>21</b>
About This Manual .....	21
Product Overview .....	21
<b>Chapter 2. Installation</b> .....	<b>23</b>
Unpack, Inspect, Power Up .....	23
Receiving Inspection.....	23
ADTRAN Shipments Include.....	23
Customer Provides .....	24
Power Up.....	24
Installation into Cabinet or Rack .....	24
Installation of Power Supplies .....	25
Installation of Controller Card .....	26
Connecting Input Devices to the Controller Card .....	26
VT 100 Connection .....	27
Modem Connection .....	27
DATAMATE Connection .....	27
Multi-Shelf Connection (Daisy Chaining) .....	27
Alarm Connections .....	27
Fuses .....	29
AC/DC Power .....	29
<b>Chapter 3. Operation</b> .....	<b>35</b>
Local Operation .....	35
VT 100 Terminal .....	35
Operation .....	35

Connection .....	35
Jumper and Switch Settings .....	36
Main Menu .....	37
Select Unit Menu .....	39
Alarm View Menu .....	40
Utilities Menu .....	41
Factory Reset Menu .....	43
DATAMATE .....	43
Manual Operation and Button Functions .....	44
LCD Window .....	44
Enter .....	45
Numeric Keypad .....	45
Shift .....	45
Quick .....	45
Cancel .....	45
Up and Down Arrows .....	45
Remote Operation .....	47
Multi-Shelf Operation (Daisy Chaining) .....	49
Interpreting Alarms and Error Messages .....	52
Clearing DBU Alarms.....	54
DATAMATE Procedure .....	54
VT 100 Procedure .....	54
<b>Appendix A. Pinouts.....</b>	<b>55</b>
<b>Appendix B. Specifications .....</b>	<b>63</b>
<b>Index .....</b>	<b>67</b>



# List of Figures

---

Figure 1-1. Smart 16 Shelf .....	22
Figure 2-1. Alarm Connection .....	28
Figure 2-2. Single AC Version Rear Power Interface Card (4202023L1 Shelf) .....	30
Figure 2-3. Dual AC Version (4202023L2 Shelf) .....	31
Figure 2-4. Single DC Version (4202023L3 Shelf) .....	32
Figure 2-5. Dual DC Version (4202023L4 Shelf) .....	33
Figure 3-1. Jumper and Switch Locations .....	36
Figure 3-2. Main Menu .....	37
Figure 3-3. Local Configuration .....	38
Figure 3-4. Select Unit Menu with Enhanced Select Disabled .....	39
Figure 3-5. Select Unit Menu with Enhanced Select Enabled .....	40
Figure 3-6. Alarm 1 Menu .....	40
Figure 3-7. Utilities Menu .....	41
Figure 3-8. Factory Reset Menu .....	43
Figure 3-9. DATAMATE .....	44
Figure 3-10. DATAMATE Utility Menu .....	46
Figure 3-11. Remote Configuration .....	48
Figure 3-12. Controller Configuration Switch Positions .....	49
Figure 3-13. Multi-Shelf Application .....	50
Figure 3-14. Controller Card Front Panel .....	53



# List of Tables

---

Table 3-1. Switch 1 Shelf Numbering Settings .....	51
Table 3-2. Controller Card Error Messages.....	52
Table 3-3. LED Alarm Messages.....	54
Table A-1. EIA-232 Connector Pinout.....	55
Table A-2. CTRL In and CTRL Out Connector Pinouts .....	56
Table A-3. Alarm Connection Pinout .....	57
Table A-4. DC Power Supply Pinout .....	57
Table A-5. V.35 Pinout .....	58
Table A-6. Auxiliary 232/366 Port Pinout .....	59
Table A-7. Network Pinout .....	60
Table A-8. RS-530A Interface Pinout.....	61
Table A-9. RJ-45 Line 1 Pinout .....	62
Table A-10. RJ-45 Line 2 Pinout .....	62



# Chapter 1 Introduction

---

## ABOUT THIS MANUAL

This manual provides the information needed for the installation and operation of the Smart 16 Shelf (see Figure 1-1 on page 22). Operation instructions for the data communication devices used with the shelf are provided in the manuals furnished with those products.

## PRODUCT OVERVIEW

The ADTRAN Smart 16 Shelf provides convenient mounting for up to 16 data communications devices for large host-type applications. The shelf can be mounted in either 19" or 23" racks and cabinets by using a set of brackets mounted alongside the shelf.

The Smart 16 Shelf has an intelligent controller card designed to configure and control all devices in the local shelf. For larger applications, the controller can access up to 15 additional shelves by daisy-chaining the control ports. For SNMP applications, the Smart 16e with embedded SNMP is available in single and dual input power options (part numbers 4202023L5-L8).

There are two choices of input devices for the controller card:

- A VT 100 compatible terminal which can be connected to the EIA-232 interface, located at the rear of the rack. For remote applications, a modem can be used.



## Chapter 2 **Installation**

---

### **UNPACK, INSPECT, POWER UP**

#### **Receiving Inspection**

Carefully inspect the Smart 16 Shelf for any shipping damages. If damage is suspected, file a claim immediately with the carrier and contact ADTRAN Customer Service. If possible, keep the original shipping container for use in shipping the Smart 16 Shelf for repair or for verification of damage during shipment.

#### **ADTRAN Shipments Include**

The following items are included in ADTRAN shipments of the Smart 16 Shelf:

- Smart 16 chassis
- Controller card
- Power supply (AC or DC) (two included in 4202023L2 and L4)
- Blank power faceplate (only in 4202023L1 and L3)
- Rear panel segment for power input and controller operation
- Mounting brackets for shelf
- Smart 16 Shelf User Manual (provided on CD)

---

## Customer Provides

The customer must supply a PC capable of emulating VT 100 or a DATAMATE (part number 1200045L1) for configuring devices installed in the Smart 16 Shelf.

## Power Up

The shelf and installed units are internally powered by an AC or DC supply. An optional second power supply can be used for redundant protection.

The dual input power shelves 4202023L2 (AC) and 4202023L4 (DC) provide the user greater redundancy by allowing the shelf to be powered by two separate AC (or DC) circuits so that service will not be interrupted upon a single circuit breaker fault. Shelf power inputs can be both AC or both DC, but they can not be mixed.

## INSTALLATION INTO CABINET OR RACK

The set of brackets supplied with the Smart 16 Shelf can be used for either 19" or 23" applications. For 19" applications, the longer side of the bracket should be flush with the side of the chassis. For 23" applications, the short side of the bracket should be flush with the side of the chassis.

There are two sets of mounting holes for the brackets on the left and right sides of the Smart 16 Shelf. One set positions the front of the Smart 16 Shelf in line with the front of the rack. The other set extends the front of the Smart 16 Shelf beyond the front of the rack.



---

## INSTALLATION OF POWER SUPPLIES

### **WARNING**

*2nd generation dual power interface cards shipped with this shelf are ONLY for use in 2nd generation Smart 16/16e shelves. Shock hazard may result from accidentally plugging a 2nd generation dual power interface card into a 1st generation Smart 16/16e shelf (P/N 4200023L3 through 4200023L6).*

*Affected Power Interface Cards: Smart 16 Dual Input AC 1202035L2  
Smart 16 Dual Input DC 1202044L2  
Smart 16e Dual Input AC1202163L2  
Smart 16e Dual Input DC1202164L2*

*The 2nd generation dual power interface cards are, however, completely safe when properly installed in a 2nd generation Smart 16/16e shelf (P/N 4202023L1 through 4202023L8).*

The power supply can be installed in either of the two slots at the top of the Smart 16 Shelf. If only one power supply is used, the blank power supply faceplate furnished with the rack should be installed over the unused slot.

### **WARNING**

*Only people familiar with installation and maintenance of the Smart 16 Shelf should install or replace the power supplies. A shock hazard could be present if an empty power supply slot is left uncovered.*

The Smart 16 Shelf is fully operational with one power supply; however, a second supply can be added to provide backup for the power supply subsystem. With the two-supply configuration, one of the supplies will operate in a hot-standby mode (the corresponding output on the standby supply will automatically provide the power required if any of the four outputs from a supply fails or begins to operate out of specifications).



### **NOTE**

*The power supplies can be "hot swapped."*

Slide the power supply along the card guides of one of the top slots until it is fully seated in the connector and the faceplate is flush

---

with the chassis. Tighten the screws on the front of the power supply panel.

Each power supply has a green indicator that illuminates when the power supply output voltages (+5V, -5V, +12V, and -12V) are within compliance; the power supply LED illuminates red to indicate that a voltage is out of tolerance. Illumination of a green LED indicates that the corresponding voltages are operating properly. When operation of any of the four voltages drops out of specification, the green LED will go out and the red LED will come on. An SNMP trap will be sent from the controller when the power supply detects a voltage failure condition. Failing power supplies are not user serviceable and require replacement.

## INSTALLATION OF CONTROLLER CARD

The Smart 16 Shelf has 17 vertical slots in the front and rear of the chassis. The left-most front position is reserved for the Smart 16 Shelf controller card. All other front slots can be used in any order for rackmount cards. The PWR/CTRL power interface card occupies the slot behind the Smart 16 Shelf controller card. All other rear slots are for DTE/Network Interface Cards.

The controller card slides into the corresponding front slot until contact is made with both the backplane connector and the rear power interface connector and the panel is flush with the front of the chassis. The controller card may be inserted and removed while the Smart 16 Shelf is receiving power without affecting the data service on the other cards.



**NOTE**

*The controller card can appear to be operational (i.e., receiving power) and yet not be completely connected. The power interface card must be fully seated and the screws must be tight for proper operation.*

## Connecting Input Devices to the Controller Card

There are two choices of input devices for the Smart 16 controller card: a VT 100 terminal or the optional DATAMATE (part number 1200045L1).

---

## VT 100 Connection

The 25-pin EIA-232 connector (labelled DTE/DCE EIA 232) on the rear power interface of the controller card provides an interface for an asynchronous ASCII VT 100 terminal, used for both local and remote configuration. The terminal must be set to line wrap off, flow control off, and VT 100 mode. The controller card settings are as follows: autobauds from 2400 to 19.2 kbps baud rate, 8-bit character size, no parity, and one stop bit. For remote configuration, see the section *Modem Connection*. The pin assignments for the EIA-232 connector are listed in Appendix A, *Pinouts* on page 55.

## Modem Connection

The Smart 16 Shelf and any rackmount units in the shelf can be configured remotely using a modem. See Chapter 3, *Operation* on page 35 for more detailed information on remote operation.

## DATAMATE Connection

The optional DATAMATE is a hand-held device that plugs into the RJ-11 jack on the front of the controller card, or the RJ-11 jack at the top of the rear PWR/CTRL segment.

## Multi-Shelf Connection (Daisy Chaining)

For multi-shelf applications, the control port is daisy-chained through the two six-pin modular jacks labelled CTRL LINK. Cabling of a multi-shelf system is detailed in Chapter 3, *Operation* on page 35. This application requires a straight-through cable. If problems arise with the operation of one of the shelves in the chain, the malfunctioning shelf will be bypassed so that the chain will not be broken. See Appendix A, *Pinouts* on page 55 for the pin assignments for the CTRL IN and CTRL OUT connectors.

## Alarm Connections

The terminal strips located on the back of the Smart 16 Shelf controller card are labeled ALARM. They are used for audio or visual alarm indicators provided by the user. The top two terminals are a set and the bottom two are a set. The terminals are activated together when the cards inserted in the designated slots encounter an alarm condition such as primary link failure.

To verify operation of the terminal strip, measure the impedance across each set. The impedance should be open when the shelf is not in alarm and shorted (approximately 0.6 ohm) when in alarm. The two alarm sets operate identically and should have the same impedance. The power specifications for any alarms used are NEC Class 2 and 48 VDC @ 500 mA maximum. Figure 2-1 shows the alarm connection.

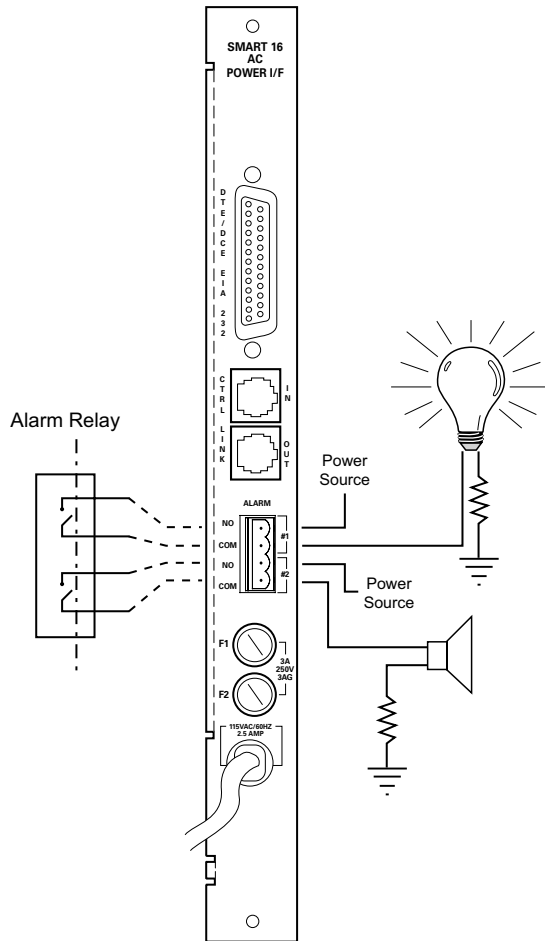

**Figure 2-1. Alarm Connection**

---

## Fuses

There are two fuses located on the rear panel. Fuse one (F1) corresponds to power supply 1 (left slot), and fuse two (F2) corresponds to power supply 2 (right slot). See *Specifications and Features* on page 63 for fuse ratings.

## AC/DC Power

The single and dual AC versions, illustrated in Figure 2-2 on page 30 and in Figure 2-3 on page 31, each have captive 8-foot power cords. The power cords are terminated by a three-prong plug which connects to a grounded power receptacle. The grounded power receptacle should be installed near the shelf and be easily accessible. The power receptacle should also have suitable disconnect devices that are provided as part of the building wiring. The power receptacle should be properly grounded. The protection of the telecommunications network relies on the protective grounding of the Smart 16 Shelf.

The single DC version, illustrated in Figure 2-4 on page 32, provides a 3-position screw terminal block for connection to a -48V source. The dual DC version, illustrated in Figure 2-5 on page 33, provides a 5-position screw terminal block for connection to both -48V sources. Pin 1 of the terminal block is frame ground.

The 2nd generation dual input power interface cards are not compatible with the 1st generation Smart 16/16e shelves (4200023L3-L6). These dual power cards are 2nd generation only and are listed below:

- Smart 16 Dual Input AC 1202035L2
- Smart 16 Dual Input DC 1202044L2
- Smart 16e Dual Input AC 1202163L2
- Smart 16e Dual Input DC 1202164L2

The 2nd generation single input power interface cards are fully compatible with the earlier 1st generation Smart 16/16e shelves. The single input power cards are listed below:

- Smart 16 AC 1202035L1
- Smart 16 DC 1202044L1
- Smart 16e AC 1202163L1
- Smart 16e DC 1202164L1

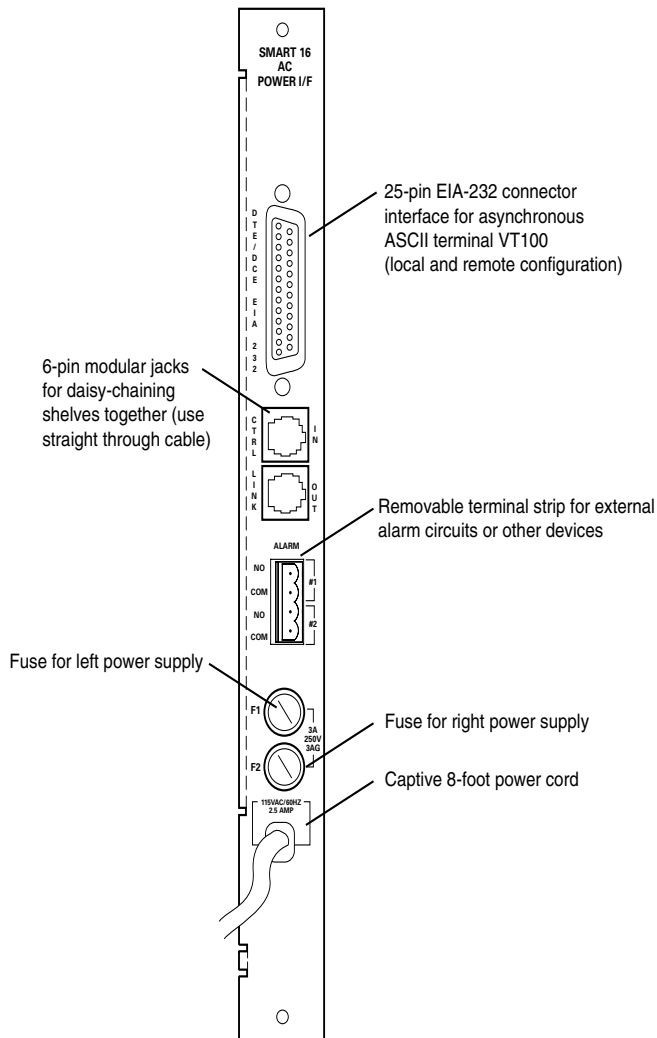

**Figure 2-2. Single AC Version Rear Power Interface Card (4202023L1 Shelf)**

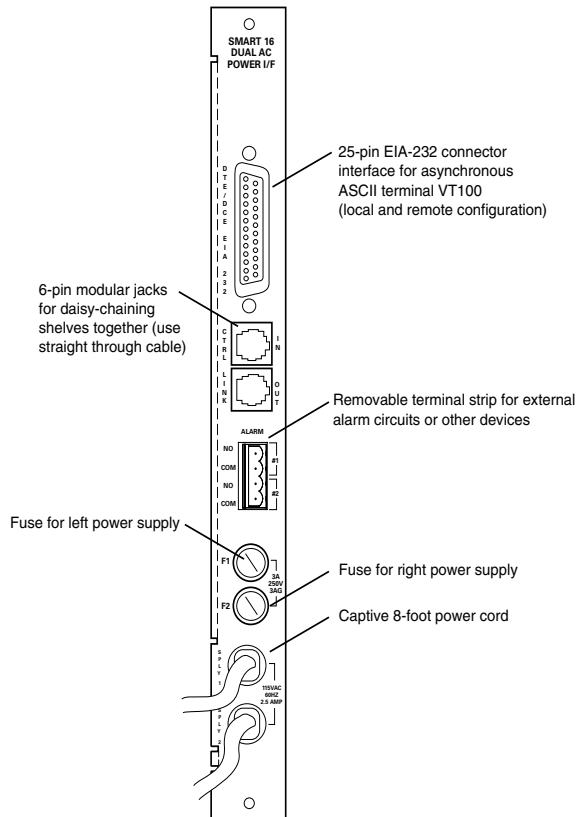

**WARNING** 2nd generation dual power interface cards shipped with this shelf are **ONLY** for use in 2nd generation Smart 16/16e shelves. Shock hazard may result from accidentally plugging a 2nd generation dual power interface card into a 1st generation Smart 16/16e shelf (P/N 4200023L3 through 4200023L6).

Affected Power Interface Cards: Smart 16 Dual Input AC 1202035L2  
 Smart 16 Dual Input DC 1202044L2  
 Smart 16e Dual Input AC 1202163L2  
 Smart 16e Dual Input DC 1202164L2

The 2nd generation dual power interface cards are, however, completely safe when properly installed in a 2nd generation Smart 16/16e shelf (P/N 4202023L1 through 4202023L8).

**Figure 2-3. Dual AC Version (4202023L2 Shelf)**

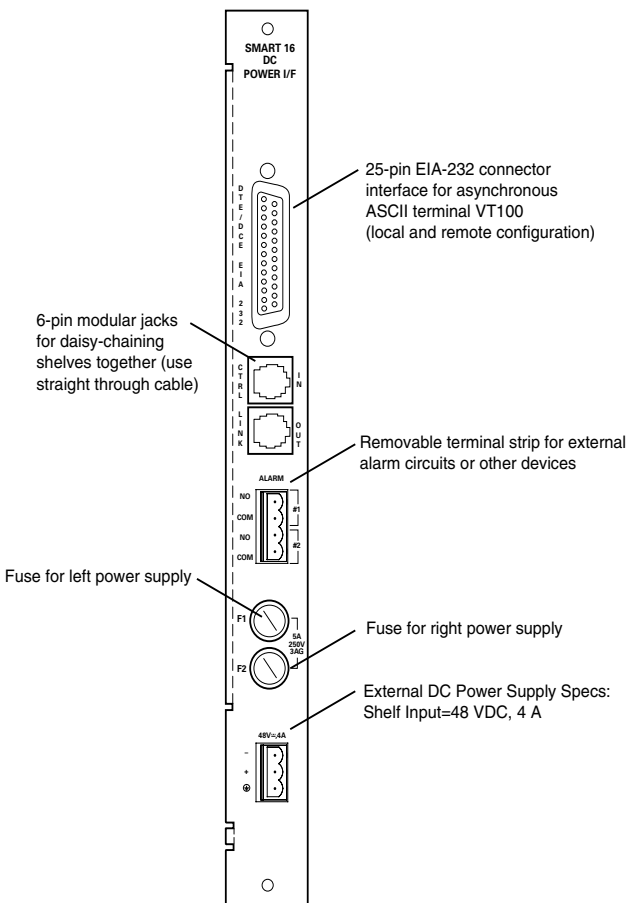

**Figure 2-4. Single DC Version (4202023L3 Shelf)**



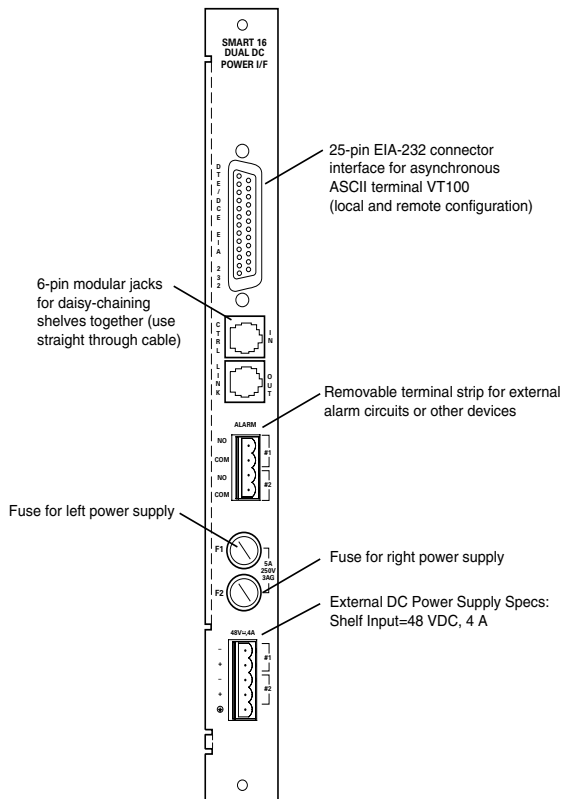

**WARNING** 2nd generation dual power interface cards shipped with this shelf are **ONLY** for use in 2nd generation Smart 16/16e shelves. Shock hazard may result from accidentally plugging a 2nd generation dual power interface card into a 1st generation Smart 16/16e shelf (P/N 4200023L3 through 4200023L6).

Affected Power Interface Cards: Smart 16 Dual Input AC 1202035L2  
 Smart 16 Dual Input DC 1202044L2  
 Smart 16e Dual Input AC 1202163L2  
 Smart 16e Dual Input DC 1202164L2

The 2nd generation dual power interface cards are, however, completely safe when properly installed in a 2nd generation Smart 16/16e shelf (P/N 4202023L1 through 4202023L8).

**Figure 2-5. Dual DC Version (4202023L4 Shelf)**



## Chapter 3 **Operation**

---

### **LOCAL OPERATION**

There are two methods of local configuration for the Smart 16 Shelf: a VT 100 terminal or a DATAMATE (part number 1200045L1).

Password parameters are set through the terminal or the DATAMATE.

### **VT 100 Terminal**

#### **Operation**

The Smart 16 Shelf may be configured by attaching the VT 100 compatible terminal or equivalent to the control port on the rear of the Smart 16 Shelf controller card. The terminal must be set to line wrap off, flow control off, and VT 100 mode. The controller card settings are as follows: autobauds from 2400 to 19.2 kbps baud rate, 8-bit character size, no parity, and one stop bit.

#### **Connection**

The connection to a terminal is made through the EIA-232 25-pin connector on the rear PWR/CTRL segment (see Figure 3-3 on page 38). This connection is used for both local and remote configuration.

## Jumper and Switch Settings

For local configuration (Direct Mode), place the jumper on the header of JP3 labeled DCE. If only one shelf is being used, the shelf must be configured as the master (SW1-8 on). See Figure 3-1 for jumper and switch locations. See *Multi-Shelf Operation (Daisy Chaining)* on page 49 for information on switch settings in a multiple shelf configuration.

**NOTE**

*If only one shelf is being used, the shelf must be configured as the master (SW1-8 on).*

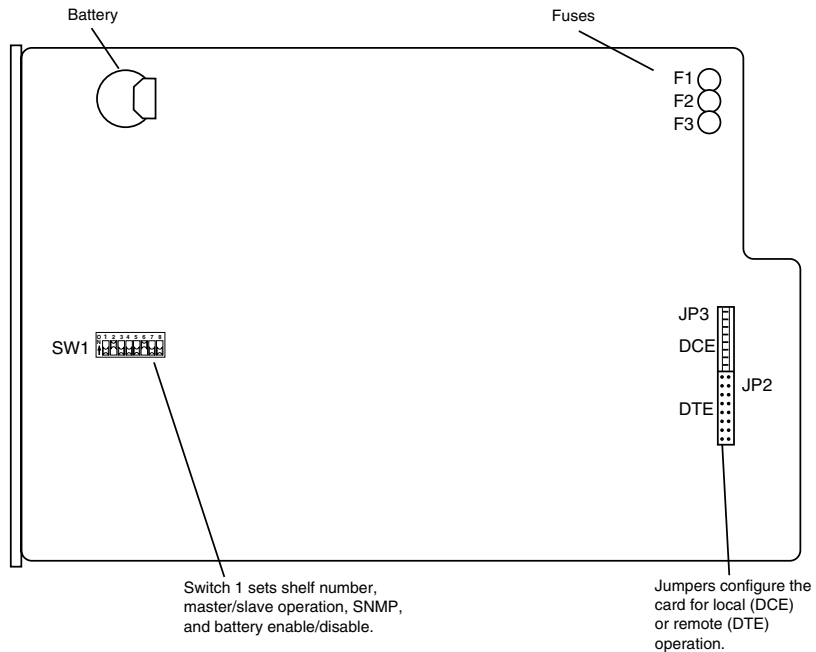

**Figure 3-1. Jumper and Switch Locations**

---

## Main Menu

After initiating terminal mode by pressing the carriage return key until the Main menu appears, the display will divide into three sections (see Figure 3-2 on page 37).

1. The main window which displays all options of a menu level.
2. The information window which lists all possible choices for a selected option
3. The command line which displays the current setting for the selected option. The setting can be updated by entering the number corresponding to the desired selection, followed by a carriage return. The new setting will be updated in the main window.

From the Main menu, select a unit, view alarms of individual units, access a utility menu, or reset the shelf.

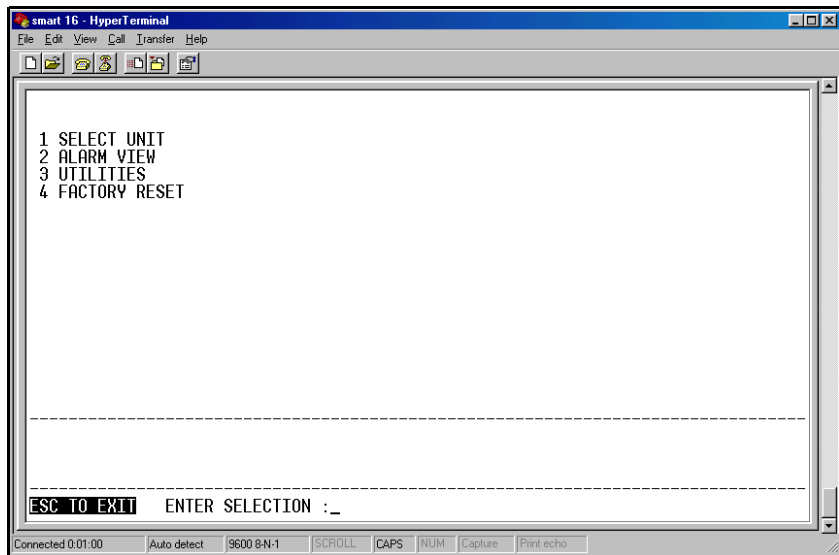

**Figure 3-2. Main Menu**

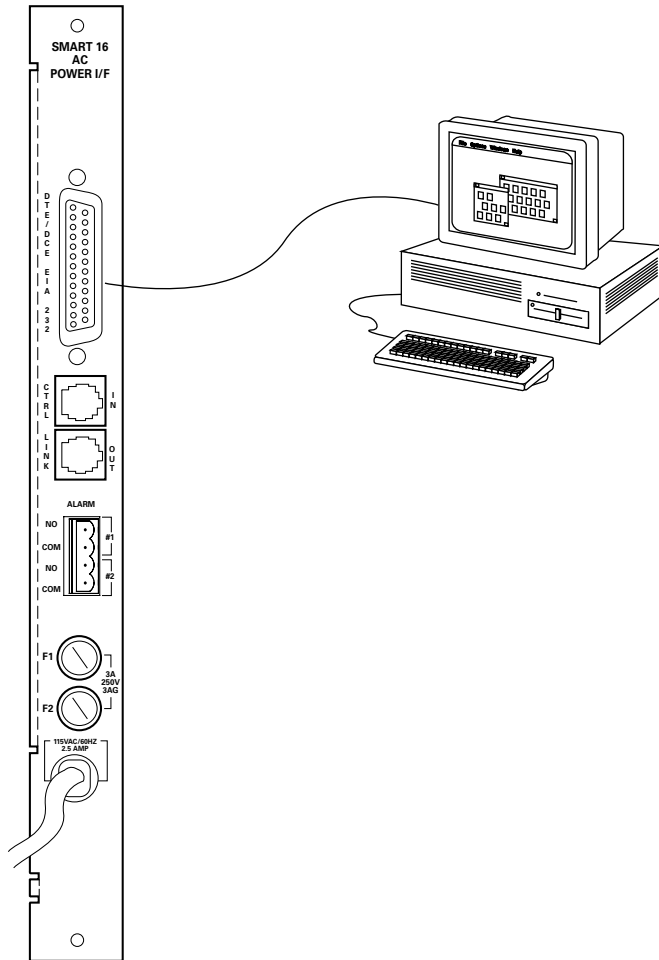

**Figure 3-3. Local Configuration**

---

## Select Unit Menu

The **SELECT UNIT** menu, illustrated in Figure 3-4, appears after selecting **1 SELECT UNIT** from the Main menu with **ENHANCED SELECT** in the Utilities disabled.

- Press 1 to select the shelf number (displayed on the front of the shelf controller card).
- Press 2 to select the slot number.
- Press 3 to execute the choices and begin configuring the rackmount unit.

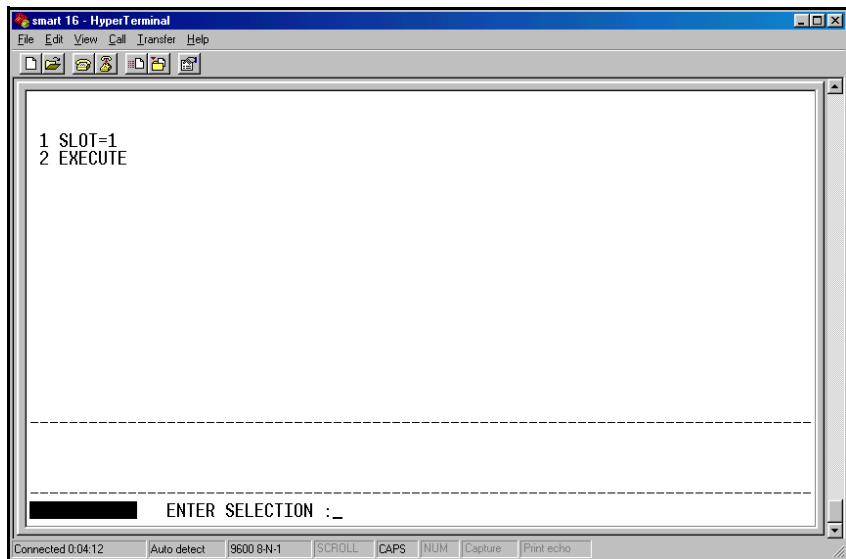

**Figure 3-4. Select Unit Menu with Enhanced Select Disabled**

If **ENHANCED SELECT** is enabled, the menu in Figure 3-5 will appear.

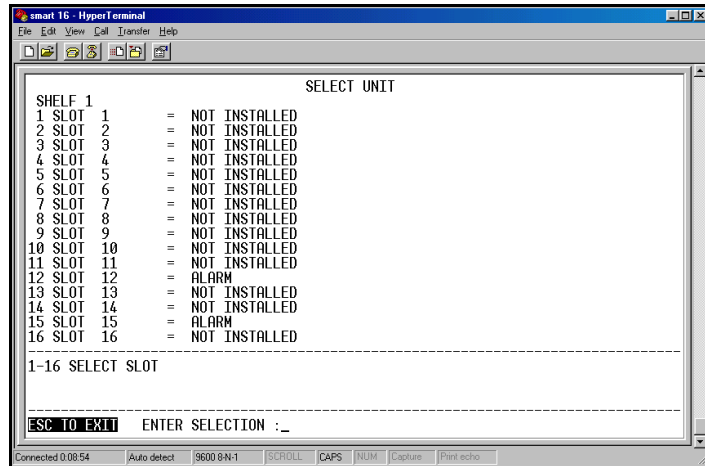

**Figure 3-5. Select Unit Menu with Enhanced Select Enabled**

## Alarm View Menu

The **ALARM** menu (Figure 3-6) appears after selecting **2 ALARM VIEW** from the Main menu. This menu displays the current system status. Select any active shelf and slot number to view its status.

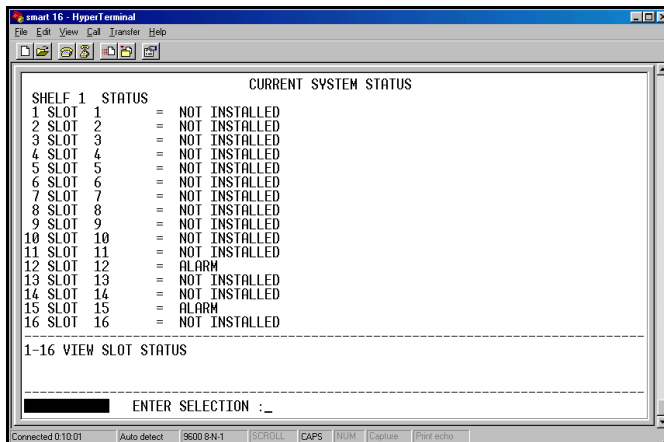

**Figure 3-6. Alarm 1 Menu**



---

## Utilities Menu

The **UTILITIES** menu (Figure 3-7) appears after selecting **3 UTILITIES** from the Main menu.

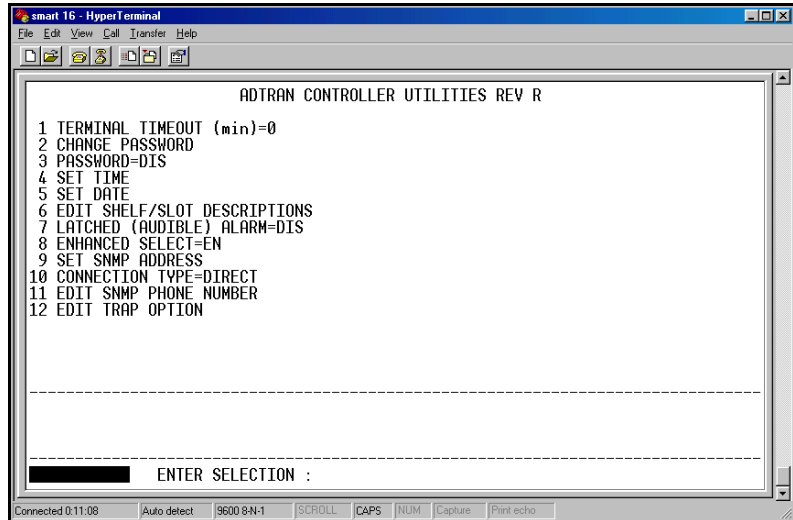

**Figure 3-7. Utilities Menu**

From the **UTILITIES** menu, perform the following functions:

**TERMINAL TIMEOUT (MIN) = NN**

Set how many minutes of keyboard inactivity can take place before the screen goes blank.

**CHANGE PASSWORD**

Set private password which will prevent unauthorized users from configuring or testing individual DSU cards. The default password for the controller card is **PASSWORD**.

**PASSWORD = DIS/EN**

Enable or disable password function.

**SET TIME**

Set time of day.

---

**SET DATE**

Set the date.

**EDIT SHELF/SLOT DESCRIPTIONS**

Assign names to the shelves and slots.

**LATCHED (AUDIBLE) ALARM = DIS/EN**

Enable or disable terminal alarm function.

**ENHANCED SELECT**

If enabled, the Select Unit menu shown in Figure 3-4 will be replaced by the menu in Figure 3-5.

**SET SNMP ADDRESS**

The controller supports SNMP Management of installed cards via the ADTRAN Advisor software. If this feature is enabled, an SNMP address must be selected.

**CONNECTION TYPE**

For SNMP applications, the controller must know whether a dial up or direct connection is being used.

**EDIT SNMP PHONE NUMBER**

For SNMP dial up operation, this is the phone number that the controller will call to send an SNMP trap.

---

## Factory Reset Menu

The **FACTORY RESET** menu (Figure 3-8) appears after selecting **4 FACTORY RESET** from the Main menu.

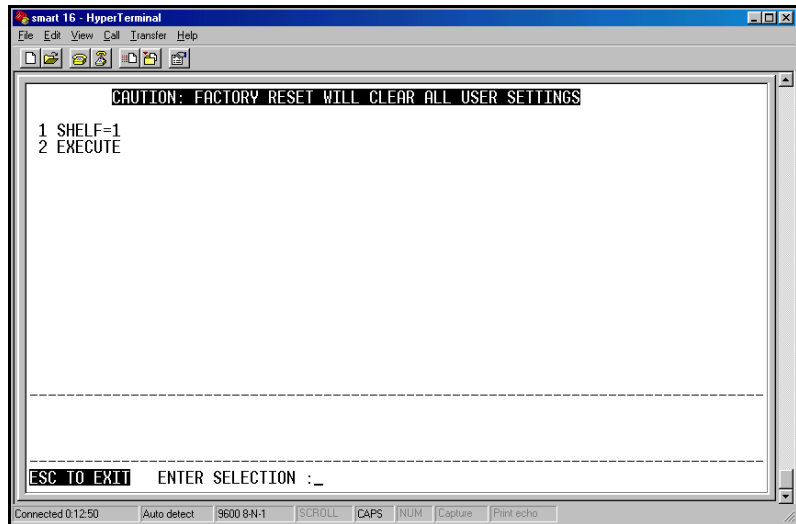

**Figure 3-8. Factory Reset Menu**

## DATAMATE

The DATAMATE, illustrated in Figure 3-9 on page 44, is a hand-held keypad with a 2x16 LCD display. The DATAMATE connects to the 6-pin modular jack on the front of the controller card. See Figure 3-14 on page 53 for jack locations.

**NOTE**

*While both controller input devices (DATAMATE and VT 100 terminal) can be installed at the same time, both devices cannot be active at the same time.*

With both devices installed, the DATAMATE is active until the terminal mode is selected. To enter terminal mode while the DATAMATE is installed, the DATAMATE must be in the top level of its menu tree (press **Cancel** until the menu level is reached). The terminal mode cannot be activated while communication between

---

the DATAMATE and the data communication product is in progress. The terminal mode is initiated by pressing the carriage return key until the Main menu is displayed. While in the terminal mode, the DATAMATE goes into standby mode and displays the following message:

**HOLD CANCEL KEY  
FOR SERVICE**

Control can be returned to the DATAMATE by pressing **Escape** until the terminal mode is exited or by holding the DATAMATE's **Cancel** key down. Once communication with an individual Rackmount unit has been established, menus identical to those of the standalone version of the product are displayed on the DATAMATE.

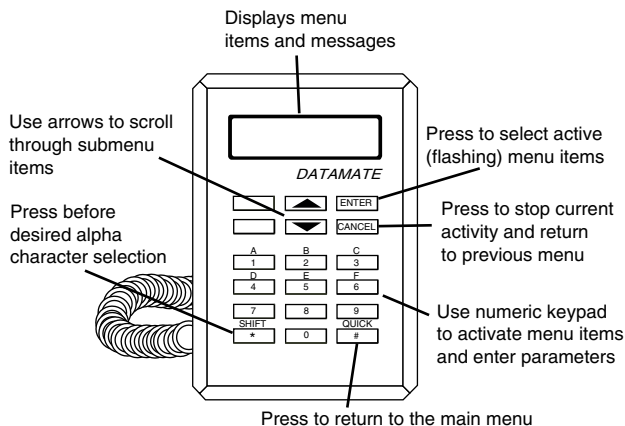

**Figure 3-9. DATAMATE**

### Manual Operation and Button Functions

The following function descriptions apply to the DATAMATE. The DATAMATE's **UTILITY** menu is provided in Figure 3-10 on page 46.

#### LCD Window

Displays menu items and messages in 2 lines by 16 characters.

---

### **Enter**

Selects active menu items. To activate a menu item, press the number of the item. When the menu item is flashing, press **Enter** to select it. This action displays a submenu item (if there is one) or sets the configuration parameter. The display of COMMAND ACCEPTED indicates a valid operation.

### **Numeric Keypad**

The numeric keypad contains the numbers 0 through 9 and alpha characters A through F, which are used to activate menu items. Numbers 0 through 9 are also used to enter parameters.

### **Shift**

Alpha characters are entered by pressing and releasing **Shift** before each desired character. To activate a menu item designated by an alpha character rather than a number, display the menu item using the up and down arrows, press **Shift** and then the letter. Press **Enter** to select the item.

If a key is pressed without using **Shift**, the numbered item becomes active instead of the alpha item. If this happens, repeat the correct procedure.

### **Quick**

During most operations, the **Quick** key returns the display to the Main menu. During a test, this key returns to the top of the **TEST** menu.

### **Cancel**

The **Cancel** key stops the current activity and returns to the previous menu. Press **Cancel** until the desired menu level is reached.

### **Up and Down Arrows**

These arrows scroll through the submenu items available in the current menu. Submenu items appear two at a time. When scrolled, they continuously appear from beginning to end in a forward (down arrow) or reverse (up arrow) pattern.

1=SELECT UNIT		SLOT=x	Yields individual unit's menu
2=UTILITIES		1=SET TIME	TIME 04:23:44 xx:xx:xx
		2=SET DATE	DATE 08-15-95 xx-xx-xx
		3=PORT CONFIG	1=PORT TYPE
			1=DIAL 2=DIRECT
			1=2400 2=4800 3=9600 4=19.2K
			1=7 BITS 2=8 BITS
			1=1 2=2
			1=NONE 2=EVEN 3=ODD
			1=ON 2=OFF
		4=TIMEOUT LIMIT	TIME OUT TIMER TIMER=0 MIN
		5=SOFTWARE REV	SOFTWARE REV=x CHECKSUM=xxxx
		6=SET SNMP ADDR	ENTER SHELF ADR SHELF=x (1-16)
		7=PHONE NUMBER	xxxxxxx
		8=SET PASSWORD	xxxxxxx
3=FACTORY RESET			
4=ALARM CLEAR			

**Figure 3-10. DATAMATE Utility Menu**

---

## REMOTE OPERATION

The Smart 16 Shelf and any rackmount units in the shelf can be configured remotely using a modem. See Figure 3-11 on page 48. Follow these steps to set up this application.

1. At the remote site, pull the controller card out of the shelf and locate the Jumper JP2 labeled DTE. Place the 16-pin jumper on the header.
2. Locate the EIA-232 interface on the back panel of the controller card. Connect the modem to this interface.
3. Make sure the shelf baud rate is not configured above 19.2 kbps.
4. Set the data format as follows: word length = 8 bits, parity = none, stop bit = 1.
5. When the call has been made and the local modem has connected to the remote unit, press the **Enter** key on the PC several times to bring the screen up.
6. Begin configuring the shelf from the local PC.

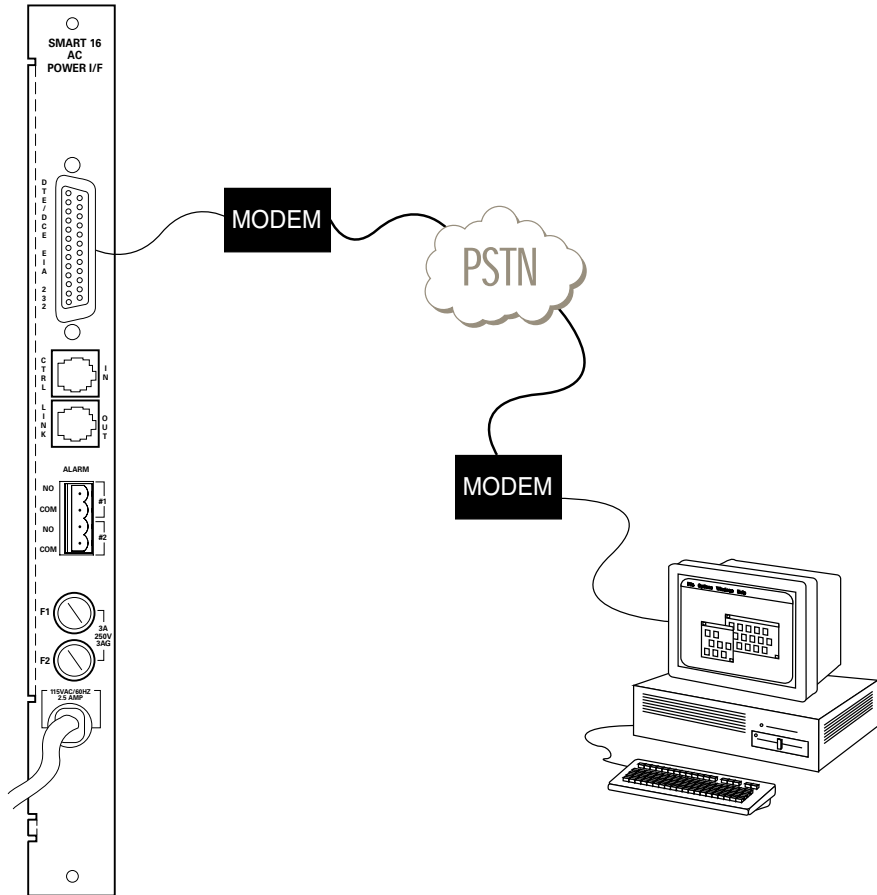

**Figure 3-11. Remote Configuration**



---

## MULTI-SHELF OPERATION (DAISY CHAINING)

For larger applications, the controller allows access to 15 additional Smart 16 Shelves. In these larger applications, one shelf controller is configured as the master and all other shelf controllers are configured as subcontrollers (see Figure 3-12 and Figure 3-13). This parameter is set through Switch 1 (SW1), the 8-position rocker switch on the controller card, as illustrated in Figure 3-12. Select either master (SW1-8 on) or subcontroller (SW1-8 off) by moving the switch to the desired position.

Using SW1-1 through SW1-4, set the shelf number from 1 to 16. Switch settings are detailed in Table 3-1 on page 51. The indicator display on the front of the controller card shows the current shelf number.

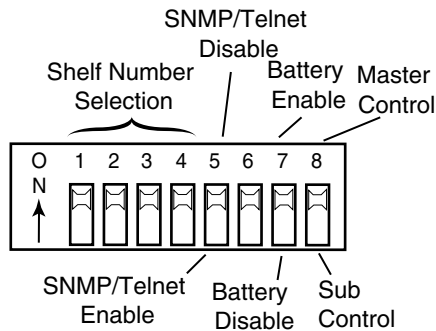

**Figure 3-12. Controller Configuration Switch Positions**

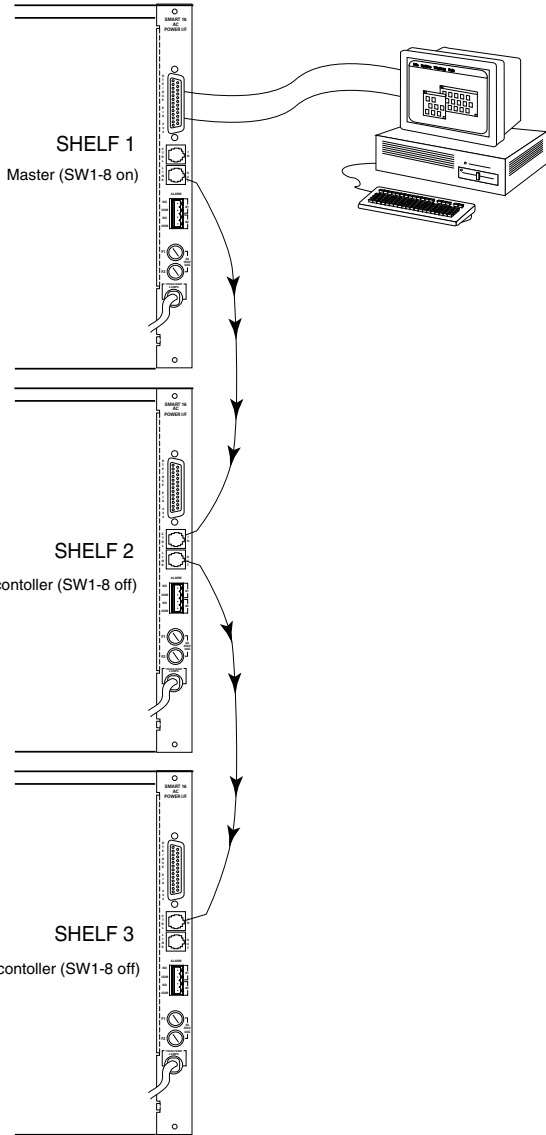

**Figure 3-13. Multi-Shelf Application**

---

**Table 3-1. Switch 1 Shelf Numbering Settings**

<b>Shelf Number</b>	<b>SW1-1</b>	<b>SW1-2</b>	<b>SW1-3</b>	<b>SW1-4</b>
1	On	On	On	On
2	Off	On	On	On
3	On	Off	On	On
4	Off	Off	On	On
5	On	On	Off	On
6	Off	On	Off	On
7	On	Off	Off	On
8	Off	Off	Off	On
9	On	On	On	Off
10	Off	On	On	Off
11	On	Off	On	Off
12	Off	Off	On	Off
13	On	On	Off	Off
14	Off	On	Off	Off
15	On	Off	Off	Off
16	Off	Off	Off	Off

---

## INTERPRETING ALARMS AND ERROR MESSAGES

The **ALARM** menu, illustrated in Figure 3-6, provides the status information of 16 individual units.

Four indicators on the front panel of the controller card show alarm conditions in the rack, as detailed in Figure 3-14.

Additional error messages are displayed in the numerical display of the controller card. The conditions, along with the numbers that represent them, are listed in Table 3-2.

These alarms, with the exception of the E2 alarm, cannot be resolved in the field and will require the unit to be returned to ADTRAN for service (see the front pages of this manual for repair and return information).

The E2 alarm can sometimes be caused by a blown fuse in one of the shelf cards. To determine if a fuse is the cause, begin taking one card out of the shelf until the E2 message clears. Replacing the problem card's fuse should solve the problem. If the problem continues, contact your ADTRAN customer service representative (see the front pages of this manual).

**Table 3-2. Controller Card Error Messages**

<b>Error Number</b>	<b>Condition</b>
E0	ROM error in the controller
E1	RAM error in the controller
E2	UART A1 failed in the controller
E3	UART B1 failed in the controller
E4	UART A2 failed in the controller
E5	UART B2 failed in the controller
E6	RTC error

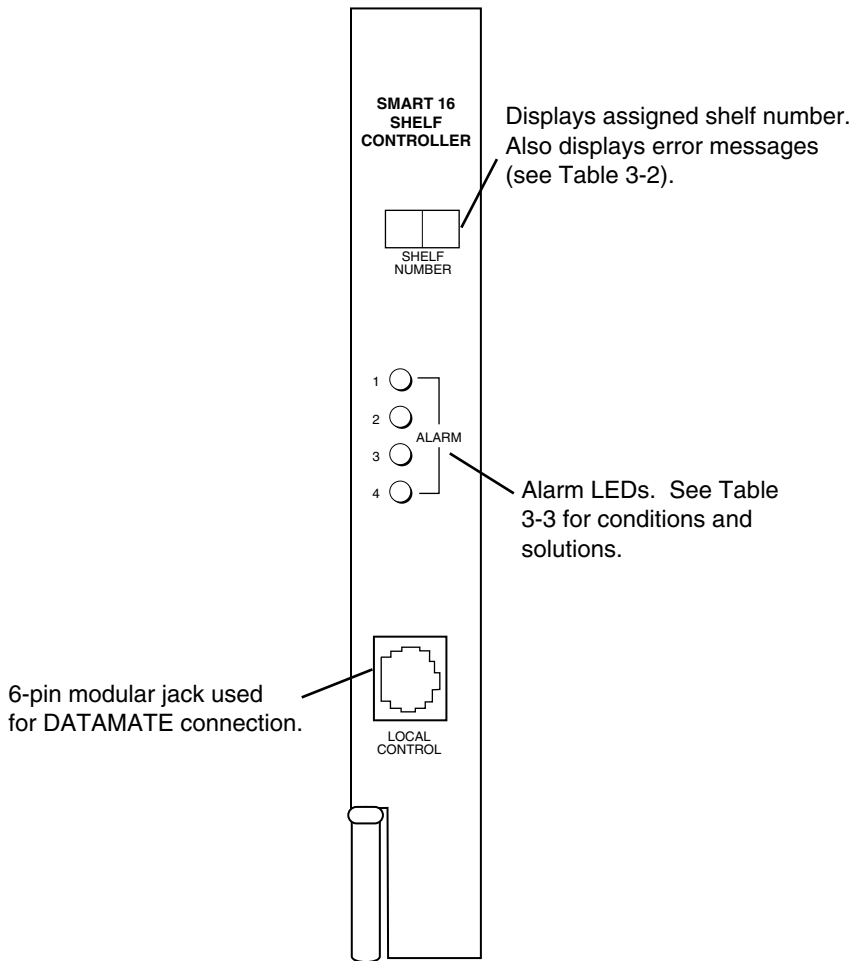

**Figure 3-14. Controller Card Front Panel**

---

**Table 3-3. LED Alarm Messages**

<b>Alarm Number</b>	<b>Condition</b>	<b>Solution</b>
1	Failure in left power supply.	Replace power supply.
2	Failure in right power supply.	Replace power supply.
3	Latched alarm (DBU has been activated).	Clear alarm by following the steps in the section <i>Clearing DBU Alarms</i> .
4	No activity in last 6500 ms (illuminates on subcontroller shelf only). The subcontroller shelf did not get a response from the master shelf.	Check for the following conditions: 1. Bad cable. 2. Backplane not seated correctly. 3. Chain in/Chain out scheme incorrect (see Figure 3-13).

## Clearing DBU Alarms

To clear DBU alarms from the controller card's front panel (indicated by ALARM LED 3), proceed with the steps listed below.

### DATAMATE Procedure

1. Clear the DBU alarm associated with the DSU card.
2. Press **4=ALARM CLEAR** from the Main menu.

### VT 100 Procedure

1. Clear the DBU alarm associated with the DSU card
2. Select **2=ALARM VIEW** from the Main menu.
3. Select the shelf number.
4. View latched alarms.
5. Select the slot number.
6. Clear latched alarms.

## Appendix A Pinouts

---

### EIA-232 Connector Pinout

The pinout for the EIA-232 connector is found below.

**Table A-1. EIA-232 Connector Pinout**

Pin	EIA	Description
1	AA	Protective Ground (PG)
2	BA	Transmit Data (TD)
3	BB	Receive Data (RD)
4	CA	Request to Send (RS)
5	CB	Clear to Send (CS)
6	CC	Data Set Ready (SR)
7	AB	Signal Ground (SG)
8	CF	Received Line Signal Detector (CD)
9	-	+12 Test Point
10	-	-12 Test Point
15	DB	Transmit Clock (TC)
17	DD	Receive Clock (RC)
18	-	Local Loopback (LL)
20	CD	Data Terminal Ready (TR)
21	-	Remote Loopback (RL)
22	CE	Ring Indicator (RI)
24	DA	External TX Clock (ETC)
25	-	Test Indicator (TI)

## CTRL IN and CTRL OUT Connector Pinouts

Use the CTRL IN connector as an RS-232 port for connection to a computer or modem (chain-in) or another TSU product (chain-out). Use the CTRL OUT connector to connect to another Smart 16 chain-in connector. The pinouts are found below.

Connector Type      RJ-48  
Product Number      AMP# 555164-2

**Table A-2. CTRL In and CTRL Out Connector Pinouts**

CTRL IN		CTRL OUT	
1	GND	1	GND
2	RX CTL IN -	2	TX CTL OUT -
3	RX CTL IN +	3	TX CTL OUT +
4	TX CTL IN -	4	RX CTL OUT -
5	TX CTL IN +	5	RX CTL OUT +
6	GND	6	GND

**NOTE**

*DTR, RI, and CD are used when the chain-in port is functioning as a DTE (connected to a modem). RTS and CTS are used when the chain-in port is functioning as a DCE (connected to a PC or a terminal).*



## Alarm Connection Pinout

The pinout for the alarm connection is found below.

**Table A-3. Alarm Connection Pinout**

Pin	Description
1	COM #2
2	NO #2
3	COM #1
4	NO #1

## DC Power Supply

The pinout for the DC power supply connection is found below.

**Table A-4. DC Power Supply Pinout**

Pin	Single DC Input	Dual DC Input
1	Frame Gnd	Frame Gnd
2	-48V Return	-48V Return #2
3	-48V	-48V #2
4	N/A	-48V Return #1
5	N/A	-48V #1

## V.35 Pinout

The pinout for this connector is shown below.

Connector Type      V.35  
 Product Number      AMP# 92-4883-3-1

**Table A-5. V.35 Pinout**

Pin	CCITT	Description
A	101	Protective ground (PG)
B	102	Signal ground (SG)
C	105	Request to send (RTS) from DTE
D	106	Clear to send (CTS) to DTE
E	107	Data set ready (DSR) to DTE
F	109	Received line signal detector (DCD) to DTE
H	-	Data terminal ready (DTR) from DTE
J	-	Ring indicator (RI)
L	-	Local loopback (LL)
N	-	Remote loopback (RL)
R	104	Received data (RD-A) to DTE
T	104	Received data (RD-B) to DTE
V	115	RX clock (RC-A) to DTE
X	115	RX clock (RC-B) to DTE
P	103	Transmitted data (TD-A) from DTE
S	103	Transmitted data (TD-B) from DTE
Y	114	TX clock (TC-A)
AA	114	TX clock (TC-B)
U	113	External TX clock (ETC-A) from DTE
W	113	External TX clock (ETC-B) from DTE
NN&K	-	Test mode (TM) to DTE

## Auxiliary 232/366 Port Pinout

The pinout for the Auxiliary 232/366 Port is shown below.

**Table A-6. Auxiliary 232/366 Port Pinout**

Pin	Name	I/O	Description
1	Shield	I/O	Shield for cable
2	DPR	I	Digit Present
3	ACR	O	Abandon Call and Retry
4	CRQ	I	Call Request
5	PND	O	Present Next Digit
6	PWI	O	Power Indication
7	SG	I/O	Signal Ground
13	DSC	O	Distant Station Connect
14	NB1	I	Digit LSB
15	NB2	I	Digit bit 2
16	NB4	I	Digit bit 3
17	NB8	I	Digit bit MSB
22	DLO	O	Data Line Occupied
8-12	NC	N/A	No Connection
18-21	NC	N/A	No Connection
23-25	NC	N/A	No Connection

## Network Pinout

On the rear panel, the Smart 16 has an eight-position modular jack labeled **NETWORK**. This connector is used for connecting to the network. The pinout is found below.

Connector Type      (USOC) RJ-48C  
Product Number      AMP# 555164-2

**Table A-7. Network Pinout**

<b>Pin</b>	<b>Name</b>	<b>Description</b>
1	R1 RXDATA-RING	Receive data from network-RNG
2	T1 RXDATA-TIP	Receive data from network-TIP
3	-	Not Used
4	R TXDATA-RING	Transmit data to network-RNG
5	T TDCDATA-TIP	Transmit data to network-TIP
6,7,8	-	Not Used

## RS-530A Interface Pinout

The pinout for the RS-530A interface is found below.

**Table A-8. RS-530A Interface Pinout**

Pin	Name	I/O	Description
1	Shield	I/O	Shield for cable
2	TD-A	I	Transmitted data
3	RD-A	O	Received data
4	RTS-A	I	Ready to send
5	CTS-A	O	Clear to send
6	DSR-A	O	Data set ready
7	SG	I/O	Signal ground
8	CD-A	O	Carrier detect
9	RC-B	O	Receive clock (return)
10	CD-B	O	Carrier detect (return)
11	ETC-B	I	External transmit clock (return)
12	TC-B	O	Transmit clock (return)
13	CTS-B	O	Clear to send (return)
14	TD-B	I	Transmit data (return)
15	TC-A	O	Transmit clock
16	RD-B	O	Receive data (return)
17	RC-A	O	Receive clock
18	NC	N/A	No connection
19	RTS-B	I	Ready to send (return)
20	DTR-A	I	Data terminal ready
21	NC	N/A	No Connection
22	DSR-B	O	Data set ready (return)
23	DTR-B	I	Data terminal ready (return)
24	ETC-A	I	External transmit clock
25	NC	N/A	No connection

## RJ-45 Line 1 Pinout

The pinout for the RJ-45 Line 1 is shown below.

**Table A-9. RJ-45 Line 1 Pinout**

<b>Pin</b>	<b>Name</b>	<b>Description</b>
1	R1	Transmit Data from DSU to Network-Ring 1
2	T1	Transmit Data from DSU to Network-Tip 1
3-6	-	Not Used
7	T	Receive Data from Network to DSU-Tip
8	R	Receive Data from Network to DSU-Ring

## RJ-45 Line 2 Pinout

The pinout for the RJ-45 Line 2 is shown below.

**Table A-10. RJ-45 Line 2 Pinout**

<b>Pin</b>	<b>Name</b>	<b>Description</b>
1-3	-	Not Used
4	T	Network-Tip
5	R	Network-Ring
6-8	-	Not Used

## Appendix B Specifications

---

### SPECIFICATIONS AND FEATURES

This section describes the standard specifications and features incorporated in the Smart 16 Shelf.

#### **Network Compatibility**

- DDS, 4-wire Switched 56, T1, FT1, ISDN

#### **Indicators and Controls**

##### **Faceplate**

- 4 LED alarm indicators
- Numerical display (Shelf Address)

##### **Rackmount Units**

- LED indicators (defined in each unit's user manual)
- Test push-buttons

##### **Power Supplies**

- AC and DC: LED indicators for +5V, -5V, +12V, -12V voltages ok (green) and voltages fail (red)

#### **Rear Panel Connections**

##### **Control Port**

- DB-25 (EIA-232)

##### **Control In and Out**

- RJ-45 6-pin

##### **DATAMATE**

- RJ-11

### **Rackmount Units**

- Up to 16 V.35 and EIA-232 DTE connectors
- Up to 32 RJ-45 network jacks for network connections

### **Captive Power Cord**

- AC versions with single or dual inputs

### **Screw Terminals**

- DC versions with single or dual inputs

### **Alarm**

- 4-screw terminals

## **Physical**

### **Size**

- 17.25" wide, 10.5" high, 14.875" deep

### **Weight**

- 20 pounds (empty)
- 45 pounds (full)

### **Mounting**

- 19" rack or cabinet
- 23" rack or cabinet

## **Power**

### **Inputs**

- AC voltage: 120 VAC  $\pm$ 20%
- Frequency: 47 - 63 Hz
- DC voltage: 30 - 72 VDC

### **Fuse Ratings**

- AC version: 3A, 3AG
- DC version: 5A, 3AG

### **Relay Contact Ratings**

- Noninductive load
- Maximum switched power: 60W or 125 VA
- Maximum switched current: 2 amps
- Maximum switched voltage: 150 VDC or 300 VAC
- U.L. Rating: 2 A @ 30 VDC; 1A @ 120 VAC



### **Power Supply Outputs to Shelf**

- +5 VDC @ 14 amps
- -5 VDC @ 1.5 amps
- +12 VDC @ 2 amps
- -12 VDC @ 2 amps

### **Environmental**

#### **Temperature**

- Operating : 0°C to 50°C (32°F to 122°F)
- Storage: -20°C to 70°C (-4°F to 158°F)

#### **Relative Humidity**

- Up to 95% non-condensing

### **Agency Approvals**

- UL and CUL
- FCC Part 15
- FCC Part 68



# Index

---

## A

- AC version 29
- affidavit v, vi
- alarm connections 27
- alarm menu 40
- alarm messages 52, 54
- alarms 52
  - clearing DBU alarms 54

## C

- change password 41
- connection 35
- connection type 42
- contents of shipment 23
- controller card
  - connecting input devices 26
  - error messages 52
  - front panel 53
  - installation 26
- CTRL OUT
  - pin assignments 56

## D

- daisy chaining 27, 49
- DATAMATE 22, 43, 44
  - arrow keys 45
  - cancel 45
  - connection to controller card 27
  - enter 45
  - LCD window 44
  - numeric keypad 45
  - quick 45
  - shift 45
- DBU alarms
  - clearing 54
- DC version 29

## E

- edit shelf/slot descriptions 42
- Edit SNMP phone number 42
- enhanced select 40, 42
- environmental
  - specifications, 65
- equipment included 23
- equipment needed 24
- error messages 52
  - controller card 52

## F

- factory reset menu 43
- FCC information x
- FCC regulations viii
- fuse ratings 64
- fuses 29

## I

- indicators 63
- input devices 21
- installation 23
  - cabinet/rack 24
  - controller card 26
  - power supply 25

## J

- jumper locations 36
- jumper settings 36

## L

- latched (audible) alarm 42
- LED alarm messages 54
- LEDs 54
- local configuration 35, 38
- local operation 35

## **M**

main menu 35, 37  
modem 47  
modem connection 27  
mounting 21  
multi-shelf connection 27  
multi-shelf operation 49

## **N**

network compatibility 63

## **O**

operation 35  
overview 21

## **P**

password 41  
power 29, 64  
power supplies 63  
power supply 22  
    installation 25  
power up 23, 24

## **R**

rear panel connections 63  
receipt inspection 23  
relay contact ratings 64  
remote configuration 48  
remote operation 47

## **S**

safety instructions iv  
select unit menu 39  
service type information viii  
set date 42  
set SNMP address 42  
set time 41  
shipment contents 23  
Smart 16 Shelf  
    features 63  
    specifications 63  
switch 1 shelf numbering 51  
switch locations 36  
switch positions 49  
switch settings 36, 49

## **T**

terminal timeout 41

## **U**

utilities menu 41

## **V**

VT 100 21, 35  
    connection to controller card 27

## **W**

warranty xii

## Free Manuals Download Website

<http://myh66.com>

<http://usermanuals.us>

<http://www.somanuals.com>

<http://www.4manuals.cc>

<http://www.manual-lib.com>

<http://www.404manual.com>

<http://www.luxmanual.com>

<http://aubethermostatmanual.com>

Golf course search by state

<http://golfingnear.com>

Email search by domain

<http://emailbydomain.com>

Auto manuals search

<http://auto.somanuals.com>

TV manuals search

<http://tv.somanuals.com>