



T1 ESF CSU ACE User Manual

1204025L1 T1 ESF CSU ACE

61204025L1-1B
September 2004

Trademarks

Any brand names and product names included in this manual are trademarks, registered trademarks, or trade names of their respective holders.

To the Holder of the Manual

The contents of this manual are current as of the date of publication. ADTRAN reserves the right to change the contents without prior notice.

In no event will ADTRAN be liable for any special, incidental, or consequential damages or for commercial losses even if ADTRAN has been advised thereof as a result of issue of this publication.



901 Explorer Boulevard
P.O. Box 140000
Huntsville, AL 35814-4000
Phone: (256) 963-8000

©2004 ADTRAN, Inc.
All Rights Reserved.
Printed in U.S.A.



Notes provide additional useful information.



Cautions signify information that could prevent service interruption.



Warnings provide information that could prevent damage to the equipment or endangerment to human life.

Safety Instructions

When using your telephone equipment, please follow these basic safety precautions to reduce the risk of fire, electrical shock, or personal injury:

1. Do not use this product near water, such as a bathtub, wash bowl, kitchen sink, laundry tub, in a wet basement, or near a swimming pool.
2. Avoid using a telephone (other than a cordless-type) during an electrical storm. There is a remote risk of shock from lightning.
3. Do not use the telephone to report a gas leak in the vicinity of the leak.
4. Use only the power cord, power supply, and/or batteries indicated in the manual. Do not dispose of batteries in a fire. They may explode. Check with local codes for special disposal instructions.

Save These Important Safety Instructions

Affidavit Requirements for Connection to Digital Services

- An affidavit is required to be given to the telephone company whenever digital terminal equipment without encoded analog content and billing protection is used to transmit digital signals containing encoded analog content which are intended for eventual conversion into voiceband analog signals and transmitted on the network.
- The affidavit shall affirm that either no encoded analog content or billing information is being transmitted or that the output of the device meets Part 68 encoded analog content or billing protection specifications.
- End user/customer will be responsible for filing an affidavit with the local exchange carrier when connecting unprotected customer premise equipment (CPE) to 1.544 Mbps or subrate digital services.

Until such time as subrate digital terminal equipment is registered for voice applications, the affidavit requirement for subrate services is waived.

Affidavit for Connection of Customer Premises Equipment to 1.544 Mbps and/or Subrate Digital Services

For the work to be performed in the certified territory of _____ (telco name)

State of _____

County of _____

I, _____ (name), _____ (business address),

_____ (telephone number) being duly sworn, state:

I have responsibility for the operation and maintenance of the terminal equipment to be connected to 1.544 Mbps and/or _____ subrate digital services. The terminal equipment to be connected complies with Part 68 of the FCC rules except for the encoded analog content and billing protection specifications. With respect to encoded analog content and billing protection:

- I attest that all operations associated with the establishment, maintenance, and adjustment of the digital CPE with respect to analog content and encoded billing protection information continuously complies with Part 68 of the FCC Rules and Regulations.
- The digital CPE does not transmit digital signals containing encoded analog content or billing information which is intended to be decoded within the telecommunications network.
- The encoded analog content and billing protection is factory set and is not under the control of the customer.

I attest that the operator(s)/maintainer(s) of the digital CPE responsible for the establishment, maintenance, and adjustment of the encoded analog content and billing information has (have) been trained to perform these functions by successfully having completed one of the following (check appropriate blocks):

- A. A training course provided by the manufacturer/grantee of the equipment used to encode analog signals; or
- B. A training course provided by the customer or authorized representative, using training materials and instructions provided by the manufacturer/grantee of the equipment used to encode analog signals; or
- C. An independent training course (e.g., trade school or technical institution) recognized by the manufacturer/grantee of the equipment used to encode analog signals; or
- D. In lieu of the preceding training requirements, the operator(s)/maintainer(s) is (are) under the control of a supervisor trained in accordance with _____ (circle one) above.

I agree to provide _____ (telco's name) with proper documentation to demonstrate compliance with the information as provided in the preceding paragraph, if so requested.

_____ **Signature**

_____ **Title**

_____ **Date**

Transcribed and sworn to before me

This _____ day of _____, _____

Notary Public

My commission expires:

FCC regulations require that the following information be provided in this manual:

1. This equipment complies with Part 68 of FCC rules and requirements adopted by ACTA. On the equipment housing is a label that contains, among other information, a product identifier in the format US: AAAEQ##TXXXX. If requested, provide this information to the telephone company.
2. If this equipment causes harm to the telephone network, the telephone company may temporarily discontinue service. If possible, advance notification is given; otherwise, notification is given as soon as possible. The telephone company will advise the customer of the right to file a complaint with the FCC.
3. The telephone company may make changes in its facilities, equipment, operations, or procedures that could affect the proper operation of this equipment. Advance notification and the opportunity to maintain uninterrupted service are given.
4. If experiencing difficulty with this equipment, please contact ADTRAN for repair and warranty information. The telephone company may require this equipment to be disconnected from the network until the problem is corrected or it is certain the equipment is not malfunctioning.
5. This unit contains no user-serviceable parts.
6. An FCC compliant telephone cord with a modular plug is provided with this equipment. This equipment is designed to be connected to the telephone network or premises wiring using an FCC compatible modular jack, which is compliant with Part 68 and requirements adopted by ACTA.
7. The following information may be required when applying to the local telephone company for a dial-up line for the V.34 modem:

Service Type	REN/SOC	FIC	USOC
1.544 Mbps - SF	6.0N	04DU9-BN	RJ48C
1.544 Mbps - SF and B8ZS	6.0N	04DU9-DN	RJ48C
1.544 Mbps - ESF	6.0N	04DU9-1KN	RJ48C
1.544 Mbps - ESF and B8ZS	6.0N	04DU9-1SN	RJ48C

8. The REN is useful in determining the quantity of devices you may connect to your telephone line and still have all of those devices ring when your number is called. In most areas, the sum of the RENs of all devices should not exceed five. To be certain of the number of devices you may connect to your line as determined by the REN, call your telephone company to determine the maximum REN for your calling area.
9. This equipment may not be used on coin service provided by the telephone company. Connection to party lines is subject to state tariffs. Contact your state public utility commission or corporation commission for information.

Federal Communications Commission Radio Frequency Interference Statement

This equipment has been tested and found to comply with the limits for a Class A digital device, pursuant to Part 15 of the FCC Rules. These limits are designed to provide reasonable protection against harmful interference when the equipment is operated in a commercial environment. This equipment generates, uses, and can radiate radio frequency energy and, if not installed and used in accordance with the instruction manual, may cause harmful interference to radio frequencies. Operation of this equipment in a residential area is likely to cause harmful interference in which case the user will be required to correct the interference at his own expense.



Shielded cables must be used with this unit to ensure compliance with Class A FCC limits.

WARNING

Changes or modifications to this unit not expressly approved by the party responsible for compliance could void the user's authority to operate the equipment.

Industry Canada Compliance Information

Notice: The Industry Canada label applied to the product (identified by the Industry Canada logo or the “IC:” in front of the certification/registration number) signifies that the Industry Canada technical specifications were met.

Notice: The Ringer Equivalence Number (REN) for this terminal equipment is supplied in the documentation or on the product labeling/markings. The REN assigned to each terminal device indicates the maximum number of terminals that can be connected to a telephone interface. The termination on an interface may consist of any combination of devices subject only to the requirement that the sum of the RENs of all the devices should not exceed five (5).

Canadian Emissions Requirements

This digital apparatus does not exceed the Class A limits for radio noise emissions from digital apparatus as set out in the interference-causing equipment standard entitled “Digital Apparatus,” ICES-003 of the Department of Communications.

Cet appareil numérique respecte les limites de bruits radioélectriques applicables aux appareils numériques de Class A prescrites dans la norme sur le matériel brouilleur: “Appareils Numériques,” NMB-003 édictée par le ministre des Communications.

Warranty and Customer Service

ADTRAN will repair and return this product within 5 years from the date of shipment if it does not meet its published specifications or fails while in service. For detailed warranty, repair, and return information refer to the ADTRAN Equipment Warranty and Repair and Return Policy Procedure.

Return Material Authorization (RMA) is required prior to returning equipment to ADTRAN.

For service, RMA requests, or further information, contact one of the numbers listed at the end of this section.

LIMITED PRODUCT WARRANTY

ADTRAN warrants that for 5 years from the date of shipment to Customer, all products manufactured by ADTRAN will be free from defects in materials and workmanship. ADTRAN also warrants that products will conform to the applicable specifications and drawings for such products, as contained in the Product Manual or in ADTRAN's internal specifications and drawings for such products (which may or may not be reflected in the Product Manual). This warranty only applies if Customer gives ADTRAN written notice of defects during the warranty period. Upon such notice, ADTRAN will, at its option, either repair or replace the defective item. If ADTRAN is unable, in a reasonable time, to repair or replace any equipment to a condition as warranted, Customer is entitled to a full refund of the purchase price upon return of the equipment to ADTRAN. This warranty applies only to the original purchaser and is not transferable without ADTRAN's express written permission. This warranty becomes null and void if Customer modifies or alters the equipment in any way, other than as specifically authorized by ADTRAN.

EXCEPT FOR THE LIMITED WARRANTY DESCRIBED ABOVE, THE FOREGOING CONSTITUTES THE SOLE AND EXCLUSIVE REMEDY OF THE CUSTOMER AND THE EXCLUSIVE LIABILITY OF ADTRAN AND IS IN LIEU OF ANY AND ALL OTHER WARRANTIES (EXPRESSED OR IMPLIED). ADTRAN SPECIFICALLY DISCLAIMS ALL OTHER WARRANTIES, INCLUDING (WITHOUT LIMITATION), ALL WARRANTIES OF MERCHANTABILITY AND FITNESS FOR A PARTICULAR PURPOSE. SOME STATES DO NOT ALLOW THE EXCLUSION OF IMPLIED WARRANTIES, SO THIS EXCLUSION MAY NOT APPLY TO CUSTOMER.

In no event will ADTRAN or its suppliers be liable to the Customer for any incidental, special, punitive, exemplary or consequential damages experienced by either the Customer or a third party (including, but not limited to, loss of data or information, loss of profits, or loss of use). ADTRAN is not liable for damages for any cause whatsoever (whether based in contract, tort, or otherwise) in excess of the amount paid for the item. Some states do not allow the limitation or exclusion of liability for incidental or consequential damages, so the above limitation or exclusion may not apply to the Customer.

Customer Service, Product Support Information, and Training

ADTRAN will repair and return this product if within 5 years from the date of shipment the product does not meet its published specification or the product fails while in service.

A return material authorization (RMA) is required prior to returning equipment to ADTRAN. For service, RMA requests, training, or more information, use the contact information given below.

Repair and Return

If you determine that a repair is needed, please contact our Customer and Product Service (CAPS) department to have an RMA number issued. CAPS should also be contacted to obtain information regarding equipment currently in house or possible fees associated with repair.

CAPS Department (256) 963-8722

Identify the RMA number clearly on the package (below address), and return to the following address:

ADTRAN Customer and Product Service
901 Explorer Blvd. (East Tower)
Huntsville, Alabama 35806

RMA # _____

Pre-Sales Inquiries and Applications Support

Your reseller should serve as the first point of contact for support. If additional pre-sales support is needed, the ADTRAN Support web site provides a variety of support services such as a searchable knowledge base, latest product documentation, application briefs, case studies, and a link to submit a question to an Applications Engineer. All of this, and more, is available at:

<http://support.adtran.com>

When needed, further pre-sales assistance is available by calling our Applications Engineering Department.

Applications Engineering (800) 615-1176

Post-Sale Support

Your reseller should serve as the first point of contact for support. If additional support is needed, the ADTRAN Support web site provides a variety of support services such as a searchable knowledge base, updated firmware releases, latest product documentation, service request ticket generation and troubleshooting tools. All of this, and more, is available at:

<http://support.adtran.com>

When needed, further post-sales assistance is available by calling our Technical Support Center. Please

Table of Contents

Chapter 1 Introduction	19
T1/FT1 Overview	19
T1 Service Offerings	19
T1 ESF CSU ACE Overview	19
Features	21
Interface Features	22
Four Methods of Control	23
Front Panel	23
ADTRAN PC Program	23
SNMP	23
ASCII Terminal	23
T1 ESF CSU ACE Testing	24
Self Test	24
Loopback Tests	25
Network Loopbacks	25
DTE Interface Loopbacks	25
Pattern Generation	26
All Ones	26
All Zeroes	26
1 in 8 (1:8)	26
Applications	26
Chapter 2 Installation	29
Unpack and Inspect	29
Shipped by ADTRAN	29
Provided by Customer	29
Power Connection	29
Wiring	30
RJ-48C Connectors	30
EIA-232 Connector	30
Power-Up Testing and Initialization	31
Self Test	31
Chapter 3 Operation	33
Front Panel Operation	33
General Front Panel Menu Operation	34
Description of Menu Tools	34
Data Field	34
Display Field	34
Arrows	34
Example Menu Operation	34

Selecting a Main Menu Item	34
Selecting a Submenu Item	35
Setting/Cancelling the Data Field	35
View Display Only Data Fields	36
Exiting or Returning to Previous Menus	36
Menu Structure	36
Detailed Menu Operation	38
1)STATUS	38
2)CONFIG	42
3)UTIL	46
4)TEST	48
Appendix A Pinouts	51
Appendix B Specification Summary	53
Specifications and Features	53
Appendix C Acronyms/Abbreviations	55
Appendix D Glossary	59

List of Figures

Figure 1-1. T1 ESF CSU ACE Application	20
Figure 1-2. T1 ESF CSU ACE Front View	20
Figure 1-3. T1 ESF CSU Rear View	21
Figure 1-4. Jack Signal Directions	21
Figure 1-5. Network Loopback Tests	25
Figure 1-6. DTE Interface Loopback	25
Figure 1-7. General Data Application	27
Figure 1-8. General Voice Application	28
Figure 1-9. Channel Bank Application	28
Figure 3-1. T1 ESF CSU ACE FRONT PANEL	33
Figure 3-2. Selecting a menu item from the Main Menu	34
Figure 3-3. Menu with Additional Item(s) Not Shown	34
Figure 3-4. Submenu Indicating Additional Items Not Shown	35
Figure 3-5. Editing a Data Field	35
Figure 3-6. The Four Opening Menus	36
Figure 3-7. T1 ESF CSU ACE Menu Tree	37
Figure 3-8. Four Opening Menus and First Level Submenus	38
Figure 3-9. Status Menu Tree	39
Figure 3-10. First Menu of NI PERF RPTS Menu	40
Figure 3-11. Performance Counter Screen	40
Figure 3-12. First Current NI Errors/Alarms Screen	41
Figure 3-13. Clear History Screen	41
Figure 3-14. Configuration Menu Tree	42
Figure 3-15. Network (NI) Submenu	42
Figure 3-16. First 2)UNIT Submenu SScreen	45
Figure 3-17. Utility Menu Tree	47
Figure 3-18. Re-initialize Unit/Address Screen	47
Figure 3-19. Test Menu Tree	48
Figure 3-20. Local Loopback Test Screen	49
Figure 3-21. Self Test Result Screen	50

List of Tables

Table A-1. RJ-48C Connector Pin Assignments.....	51
Table A-2. EIA-232 Connector Pin Assignments.....	51

T1/FT1 OVERVIEW

T1 digital communication links have been used by telcos for the transmission of voice since the early sixties. The D4 channel bank is an example of a T1 digital carrier system that was introduced in the mid-seventies and is still widely used by the telcos. Communication demands of business continued to grow to the point that the telcos began offering T1 service directly to the public. D4 channel banks were used for T1 in corporate network topographies for voice. The technological advances in computer development also created a demand for T1 data communication, which now is a large part of the T1 traffic.

T1 SERVICE OFFERINGS

T1 is a digital service delivered to the user over two pairs of wires from the service provider. The signal operates at 1.544 Mbps and is usually extended by repeaters installed approximately every mile after the first 6000 feet. The T1 signal is divided into 24 time slots which operate at 64 kbps (DS0s). Each time slot is occupied by digitized voice or by data.

The T1 signal originally used a type of framing known as D4 superframe (SF), which identifies how the T1 is multiplexed. An enhancement of that framing format, called extended superframe (ESF), is available. ESF provides a non-disruptive means of full-time monitoring on the digital facility. It was originally used by service providers to monitor the performance of their service offering. Since the introduction of ESF, equipment installed in private networks can also provide this performance information to the user.

T1 ESF CSU ACE OVERVIEW

Most carriers (regional or local telcos), when supplying a T1 line to customer premises equipment (CPE), require an interface to monitor the T1 line. The T1 ESF CSU ACE (extended superframe channel service unit advanced communication equipment) provides the required interface between the CPE (such as DSUs, channel banks, T1 multiplexers, and PBXs) and telco or private T1 facilities. Figure 1-1 depicts a typical application.

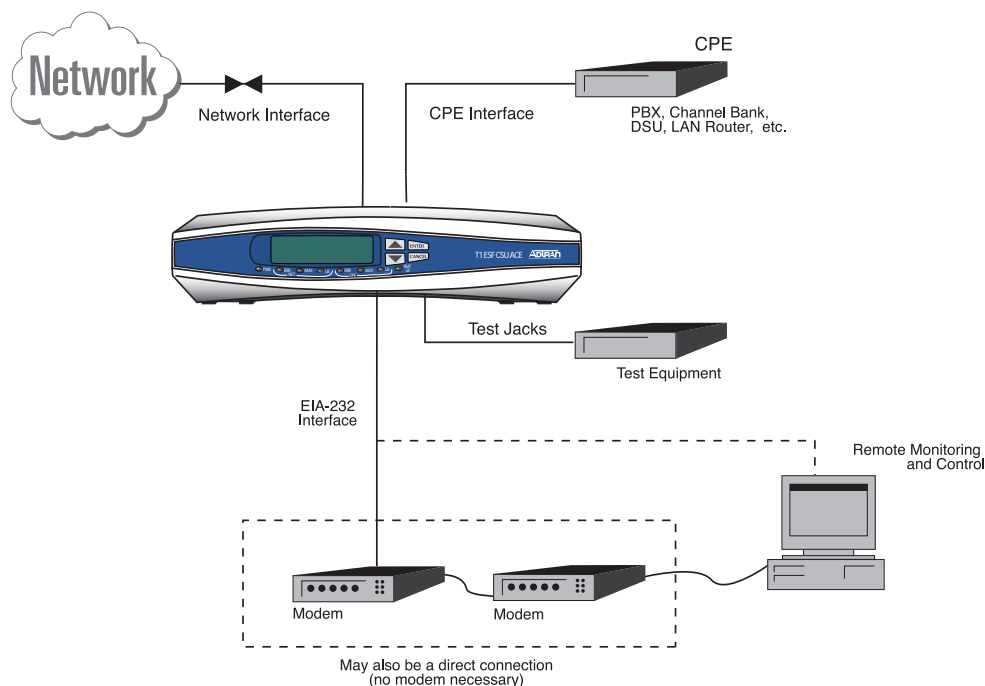

Figure 1-1. T1 ESF CSU ACE Application

The T1 ESF CSU ACE provides surge protection, signal regeneration, alarms, and loopbacks necessary for circuit operation and fault isolation. The unit provides the simultaneous use of performance report messages of ANSI T1.403 and maintenance messages of AT&T TR54016. The T1 ESF CSU ACE also provides conversion from SF to ESF framing formats, allowing older SF data terminal equipment (DTE) to take advantage of the superior diagnostic capabilities of ESF T1 facilities.

The unit complies with Part 68 of FCC Rules and with applicable sections of AT&T 62411, ANSI T1.102, and T1.403.

Figure 1-2 shows the front of the T1 ESF CSU ACE, and Figure 1-3 shows the back of the T1 ESF CSU ACE. Figure 1-4 shows the jack signal directions.

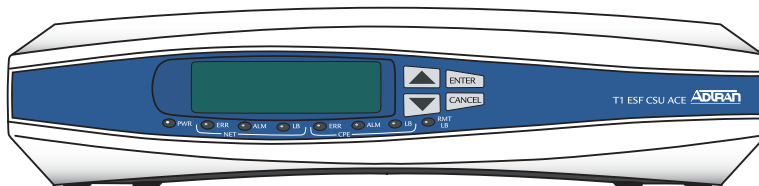

Figure 1-2. T1 ESF CSU ACE Front View

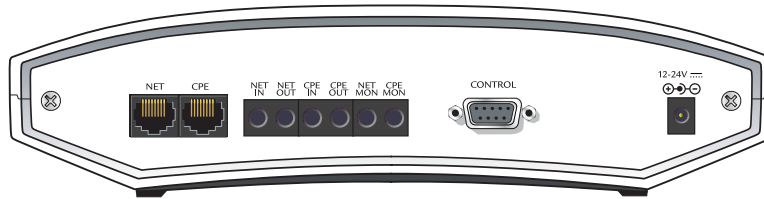

Figure 1-3. T1 ESF CSU Rear View

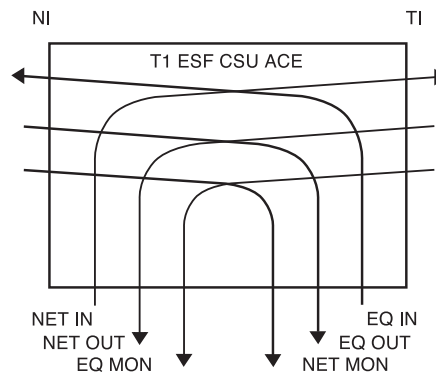

Figure 1-4. Jack Signal Directions

Features

The following features give the T1 ESF CSU ACE many advantages over other products of its kind:

- Smallest T1 ESF CSU ACE in the industry.
- Front panel interface eliminates the need for a terminal to configure the T1 ESF CSU ACE.
- Automatic ESF to D4 frame conversion.
- Wall mount NEC Class 2, 12 VDC power supply eliminates the need for an external power supply.
- Can be wall mounted to virtually any surface. There are rubber feet on the unit for use on a table top.
- Can configure a modem so that it does not have to be configured before installation.
- Backs up configuration data in EEPROM.

Interface Features

NI (Labeled NET)

The network interface (NI) port complies with the applicable ANSI and AT&T standards. Its features include the following:

- D4 or ESF framing
- AMI or B8ZS coding
- Configurable LBO
- Network performance monitoring and reporting
- Local and remote test loopbacks
- Extensive self test

TI (Labeled CPE)

Features of the terminal interface (TI) include the following:

- D4 or ESF framing (independent of NI)
- AMI or B8ZS coding
- Transmit LBO to 655 feet
- DTE loopback

Control Port Input (Labeled EIA-232)

Features of the control port include the following:

- EIA-232 input from a PC or a modem for control of the T1 ESF CSU ACE
- Up to 9600 baud operation
- Acts as input for PC or proxy agent control
- VT100 terminal interface

FOUR METHODS OF CONTROL

Front Panel

The front panel provides complete and easy control of all items that can be configured through menu-guided options. The front panel LCD displays the status of operation and performance reports for the unit. Chapter 3 contains information on front panel operation and all the menu options.

ADTRAN PC Program

T-Watch is the ADTRAN PC control program. It provides complete control over the configuration of the T1 ESF CSU ACE through a graphic interface. The T-Watch program displays the same status and performance data as the front panel LCD. This data is displayed in the form of tables and graphs.

The T-Watch program has the following capabilities:

- Interface with modem permits dialing into a remote T1 ESF CSU ACE location to configure the unit or read the unit's status or performance.
- Performance data read from the units can be exported in a file which is compatible with common spreadsheet programs.

SNMP

The ADTRAN T1 ESF CSU ACE supports the Simple Network Management Protocol (SNMP) through the ADTRAN Advisor SNMP Proxy Agent (1950007L1) to a network management system such as OpenView® or SunNet Manager™. The proxy agent runs on a PC and can interface to the T1 ESF CSU ACE directly or through a modem, in the same manner as the T-Watch PC programs.

ASCII Terminal

The ADTRAN T1 ESF CSU ACE recognizes an escape sequence that puts the unit into the ASCII terminal mode. After receiving the sequence, the T1 ESF CSU ACE sends front panel information to the terminal. This interface acts exactly like the front panel, but the advantage is that it can be accessed remotely (through a modem). The escape sequence is:

<CONTROL-A> <CONTROL-P> <CONTROL-T>

or

<CONTROL-P> <CONTROL-T> <CONTROL-T>



The terminal or terminal emulation software must be VT100 compatible.

T1 ESF CSU ACE TESTING

The T1 ESF CSU ACE offers three forms of testing:

- Self test
- Loopback tests
- Pattern generation

Self Test

The self test checks the integrity of the electronic components' internal operation by performing memory tests and sending and verifying data test patterns through all internal interfaces. Although actual user data cannot be passed during these tests, the self test can be run with the network and DTE interfaces in place and will not disturb any external interface.

The self test automatically executes upon power-up. It can also be initiated from a front panel menu or from the control port.

In addition to the specified self tests, background tests are run on various parts of the internal electronics. These run during normal operation to confirm continued correct functioning. The background tests include the standard background network performance monitoring as required by ANSI T1.403 and AT&T 54016, for which the results are stored.

Loopback Tests

A number of different loopbacks can be invoked locally from the front panel, by T-Watch commands, or remotely by using special inband codes (AT&T network loop-up and loop-down codes). Additionally, the loopbacks can be remotely controlled by out-of-band commands using the T1 ESF FDL, or from T-Watch using a modem connection. A discussion of network loopbacks and DTE interface loopbacks follows.

Network Loopbacks

There are two types of network loopbacks: line loopbacks and payload loopbacks. These are illustrated in Figure 1-5.

- Line Loopback - Loops all of the received data back toward the network. The transmitted data is the identical line code that was received, including any bipolar violations or framing errors.
- Payload Loopback - Similar to line loopback, except that the framing is extracted from the received data and then regenerated for the transmitted data.

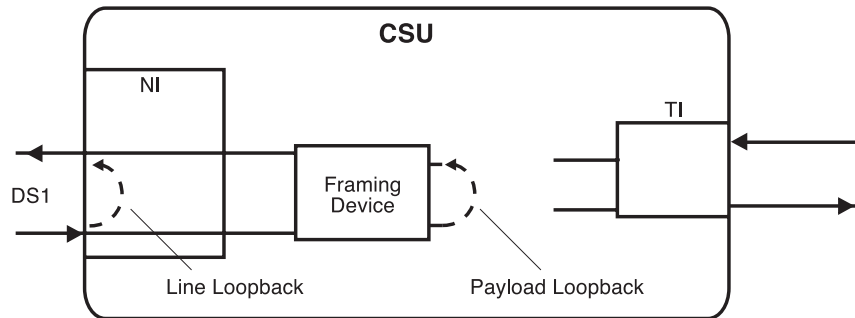

Figure 1-5. Network Loopback Tests

DTE Interface Loopbacks

Loops all data from the terminal interface (TI) back towards the TI. This loopback may be initiated using front panel, EIA-232 control port, or T-Watch commands. The DTE (or external test equipment) must provide any test pattern in order to check the DTE interface. See Figure 1-6.

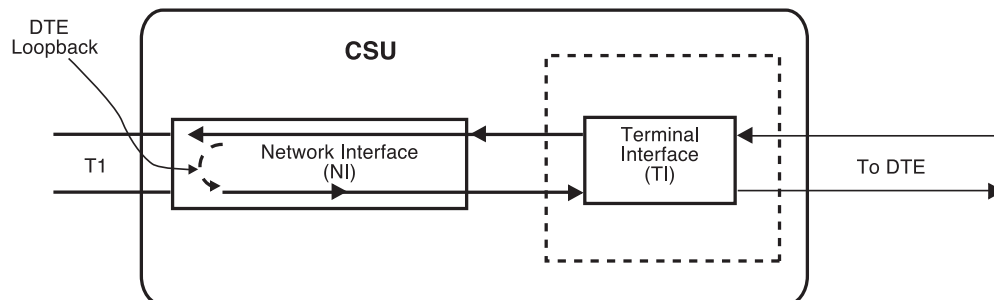

Figure 1-6. DTE Interface Loopback

Pattern Generation

The T1 ESF CSU ACE offers three test patterns: All Ones, All Zeros, and 1:8. These patterns can be initiated from the front panel, through the EIA-232 control port, or remotely via a management software like T-Watch.

All Ones

The All Ones pattern sends ones in all the payload bits.

All Zeroes

The All Zeros pattern sends zeros in all the payload bits and is useful for testing line code configuration (AMI/B8ZS mismatches).

1 in 8 (1:8)

Each channel of the T1 has only one bit set. This pattern is used in conjunction with external test equipment to determine whether the T1 line is performing acceptably under a stress condition.

APPLICATIONS

Three applications are shown in this section. Figure 1-7 on page 27 shows a general data application; Figure 1-8 on page 28 shows a general voice application; and Figure 1-9 on page 28 shows a channel bank application.

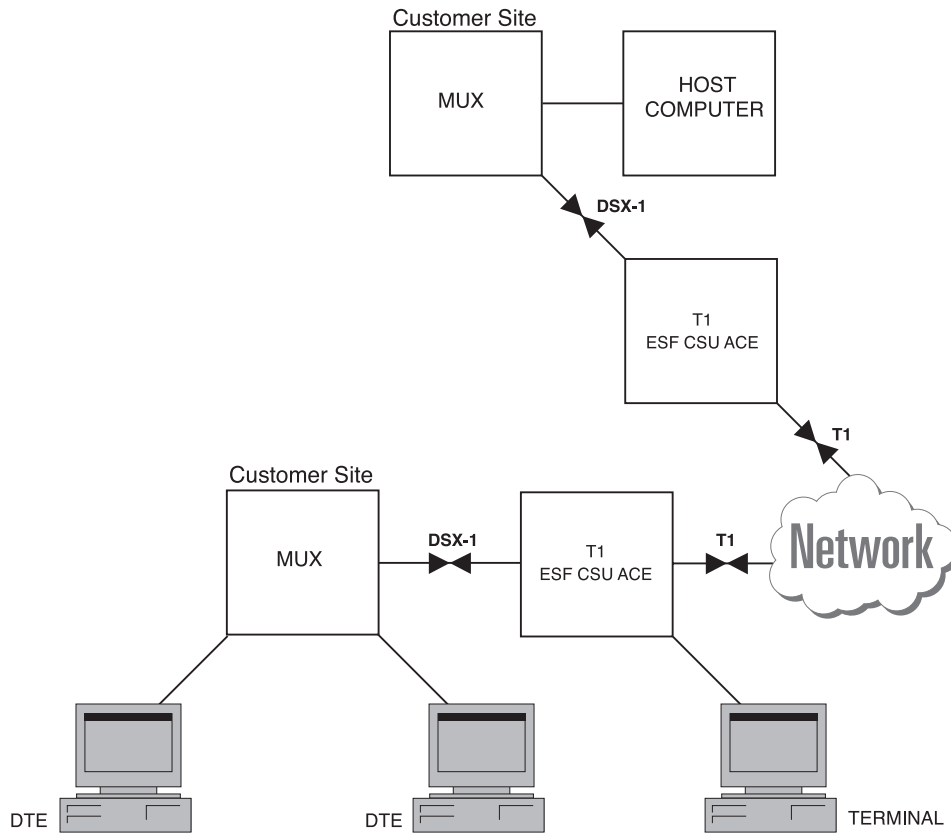

Figure 1-7. General Data Application

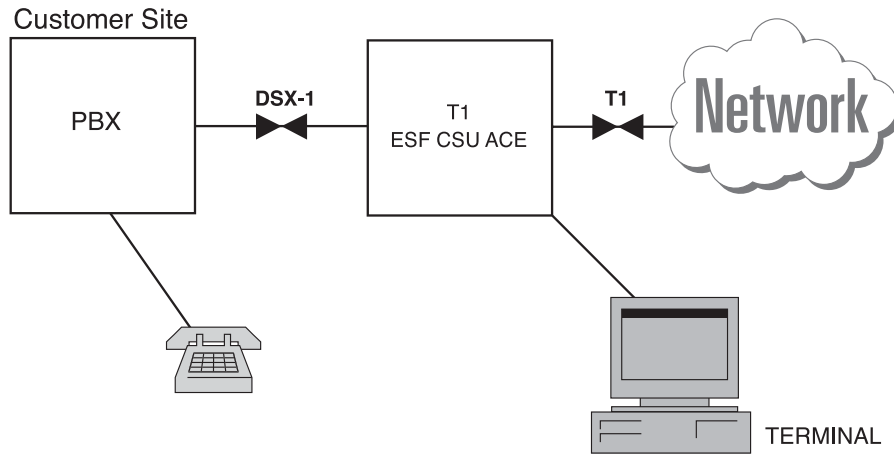

Figure 1-8. General Voice Application

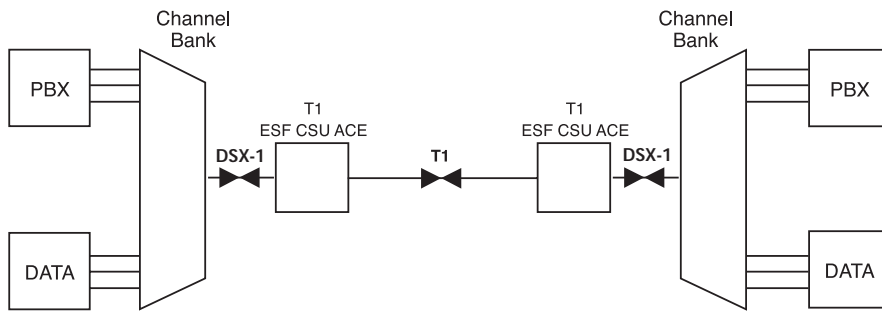

Figure 1-9. Channel Bank Application

Chapter 2 **Installation**

UNPACK AND INSPECT

Carefully inspect the T1 ESF CSU ACE for any shipping damages. If damage is suspected, file a claim immediately with the carrier and then contact ADTRAN Technical Support. If possible, keep the original shipping container to ship the T1 ESF CSU ACE back for repair or to verify damage during shipment.

Shipped by ADTRAN

The following items are included in the ADTRAN shipment:

- The T1 ESF CSU ACE
- Line interface cable: an 8-position/modular to 8-position/modular
- 12 VDC power supply
- TSU Single Port Family System Manual CD

Provided by Customer

The following items must be supplied by the customer:

- DTE cable(s)
- Cable for the EIA-232, if used

POWER CONNECTION

The unit may be powered by using the supplied NEC Class 2, 12 V wall mount power supply. It may also be locally powered by own 12 to 48 V power supply. Once power has been applied to the unit, the **PWR** LED illuminates.

The unit can be powered by either of the following methods:

Method 1
<ul style="list-style-type: none">• Use the included NEC Class 2, 12 V at 800 mA wall mount power supply. <p><i>Note: The wall outlet shall be near the equipment and readily accessible.</i></p>

OR

Method 2

- Connect to a reliably-grounded 12-48 Vdc source which is electrically isolated from the AC source having LPS or NEC Class 2 outputs

OR

- Use a Listed Class 2 Direct Plug-In Supply with an output rated 12-48 Vdc, minimum 350 mA, maximum 240 VA.

Note: The branch circuit overcurrent protection shall be a fuse or circuit breaker rated at a minimum of 48 V to a maximum of 10 A.

A readily accessible disconnect device that is suitably approved and rated, shall be incorporated in the field wiring.

The unit shall be installed in accordance with the requirements of NEC NFPA 70, where applicable.

To use the cable of the supplied power supply with a local supply, connect the black wire to the negative pole of the power supply and connect the black and white wire to the positive pole of the power supply. The outside contact point of the barrel plug connects to the negative pole and the center contact point of the barrel plug connects to the positive pole.

WIRING

The connectors are described in this section.

RJ-48C Connectors

Two RJ-48C connectors are located on the back end of the T1 ESF CSU ACE. The NET connector connects the unit to the network. The connector marked CPE connects the unit to the data terminal equipment. These connectors have exactly the same pinouts.



To reduce the risk of fire, use only No. 26 AWG or larger telecommunication line cord.

See Table A-1 on page 51 for the RJ-48 connector pin assignments.

EIA-232 Connector

The EIA-232 connector is used to connect the T1 ESF CSU ACE to a proxy agent, T-Watch, an ASCII terminal, or a modem.

See Table A-2 on page 51 for the connector pin assignments.

Connector Type = Female DB-9

POWER-UP TESTING AND INITIALIZATION

When shipped from the factory, the T1 ESF CSU ACE is set to factory default conditions. When power is applied, the unit automatically executes self test, followed by an initialization sequence that sets up the unit.

Self Test

Upon a power-up or self test, the LCD displays **ADTRAN T1 ESF CSU ACE INITIALIZING** and the LEDs illuminate momentarily. When the self test is completed with no failures detected, the LCD momentarily displays **ALL TESTS PASSED**. If a failure is detected, it is displayed in the LCD window. The automatic self test procedure consists of the following steps:

1. Board level tests - RAM tests; EPROM checksum
2. Unit level tests - Front panel LED verification

The T1 ESF CSU ACE can be configured and controlled via the local front panel, the EIA-232 control port, or T-Watch. This chapter describes configuration from the front panel.

FRONT PANEL OPERATION

The T1 ESF CSU ACE front panel operating functions are shown in Figure 3-1 and defined in this section.

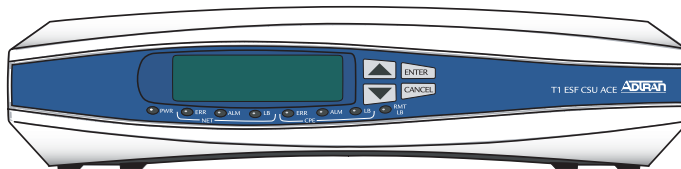

Item	Function
1. LCD Window	Displays menu items used in configuration and information useful in monitoring the unit.
2. Up/Down Scroll	Used to travel up/down menu trees, increase/decrease numeric values, and scroll through selections.
3. ENTER	Used to make selections.
4. CANCEL	Used to exit selections or menu tree branches.
5. POWER	LED on when power is received by ESF CSU.
6. ERRORS	LED on when errored events have occurred in the last second
7. ALARMS	LED on when an alarm condition exists.
8. LOOPBACK	LED on when until unit is in loopback or has placed a remote unit in loopback.
6. ERRORS	LED on when errored events have occurred in the last second
7. ALARMS	LED on when an alarm condition exists.
8. LOOPBACK	LED on when until unit is in loopback or has placed a remote unit in loopback.

Figure 3-1. T1 ESF CSU ACE FRONT PANEL

GENERAL FRONT PANEL MENU OPERATION

The T1 ESF CSU ACE uses a multilevel menu structure containing both menu items and data fields. All menu operations and data are displayed in the LCD window. The menu items are numbered and can be viewed by using the scroll keys (the arrow keys on the front panel).

Description of Menu Tools

Data Field

A menu item followed by a colon (:) identifies a field available for editing.

Display Field

This menu field contains alarm or error information.

Arrows

Menus that display small up or down arrows in the lower right corner indicate that there are more menu items viewable on the two-line LCD. Access additional menu items with the up or down scroll keys.

Example Menu Operation

Selecting a Main Menu Item

To select a menu item from the Main menu, follow these steps:

1. Use the up and down scroll keys to place the cursor on the desired menu item (in this example, 2)CONFIG). See Figure 3-2.

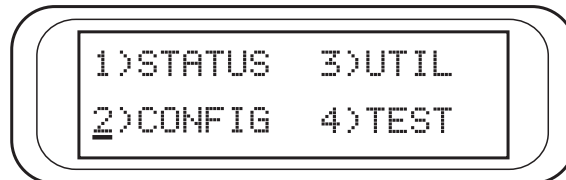

Figure 3-2. Selecting a menu item from the Main Menu

2. With the cursor on the number 2), press the **ENTER** key. The unit responds by displaying the first two available submenu fields. The cursor is on the first field. If there are more than two menu fields, a down arrow is visible on the lower right corner. See Figure 3-3.

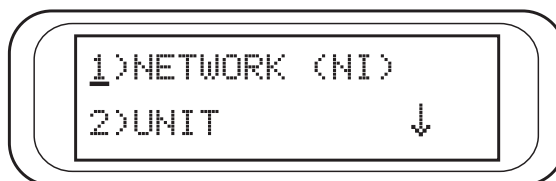

Figure 3-3. Menu with Additional Item(s) Not Shown

Selecting a Submenu Item

To select the desired submenu item (similar to selecting a Main menu item), follow these steps:

1. Use the up and down scroll keys to place the cursor on the desired menu item, in this example 1)NETWORK (NI). See Figure 3-3.
2. The unit responds by displaying the first two available data field items. The cursor is on the number of the first item. When there are more than two data field items for the selected submenu, a down arrow is visible on the lower right corner. See Figure 3-4.



Figure 3-4. Submenu Indicating Additional Items Not Shown

Setting/Cancelling the Data Field

Data fields available for editing are preceded by a colon (:). To set a data field, perform the following steps:

1. Press **ENTER** while the cursor is located on the submenu item number. The cursor moves to the data field (to the right of the submenu item name). See Figure 3-5.



Figure 3-5. Editing a Data Field

2. Use the up and down scroll keys to scan the available value settings displayed one at a time in the data field position.
3. When the desired value is in the data field position, press **ENTER** to set the value. The unit now is set for the value shown in the data field and the cursor moves back to the submenu item position, indicating that the operation is complete. Another submenu field may be selected, or use **CANCEL** to return to the submenu.



*Cancelling is available any time during the operation. If **CANCEL** is used prior to pressing **ENTER** after making a data change, the original data value is restored and the cursor returns to the submenu field.*

View Display Only Data Fields

Select the following menu choice to view an example of a display-only data field:

1. Select 1)STATUS from the Main menu.
2. Select submenu 2)NI ERR/ALM.
3. LOSS OF SIGNAL INACTIVE/ACTIVE displays, giving the current state of the alarm.

Exiting or Returning to Previous Menus

Press the **CANCEL** key to exit a menu field or return to a previous menu level.

MENU STRUCTURE

The T1 ESF CSU ACE uses hierarchical menus to access its many features. The top-most, or Main menu level (see Figure 3-6 and Figure 3-8) leads to submenus which are grouped by functionality. All menu operations are displayed in the LCD window.

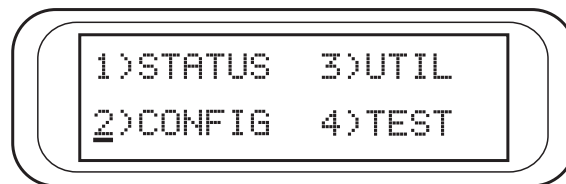
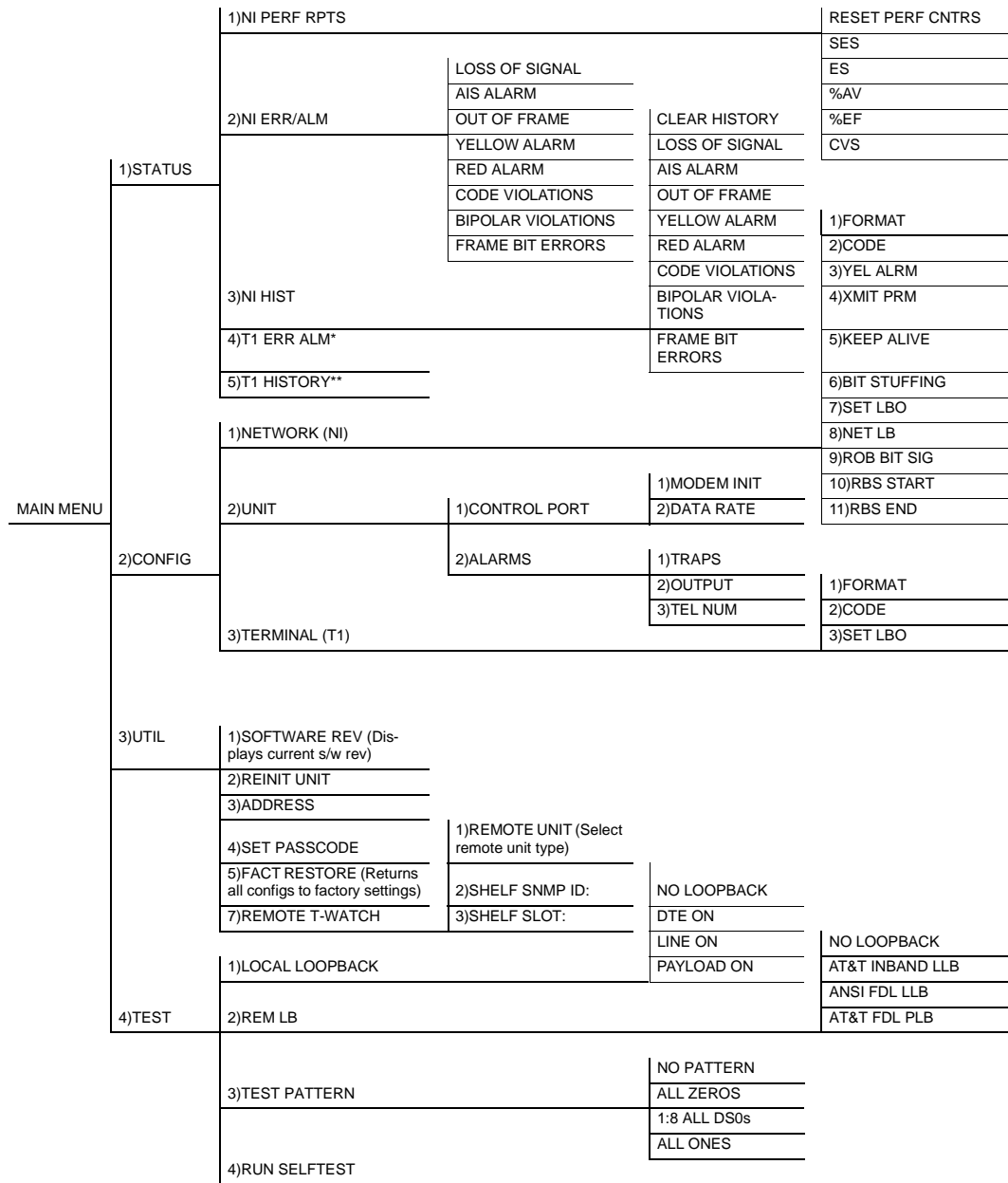

Figure 3-6. The Four Opening Menus

Figure 3-7 on page 37 shows the complete menu tree. Figure 3-8 on page 38 is a limited overview. Following this figure is a detailed description of each menu item, presented in menu order.



*T1 ERR/ALM has same menu sub-branches as NI ERR/ALM. **T1 HISTORY has same as NI HISTORY.

Figure 3-7. T1 ESF CSU ACE Menu Tree

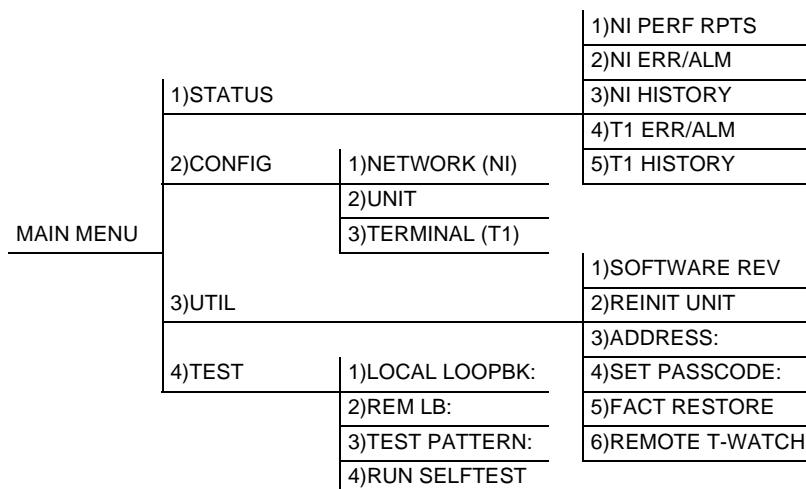

Figure 3-8. Four Opening Menus and First Level Submenus

Menu flow is normally depicted from left to right. Arrows on the lower right of the screen indicate the direction of scrolling to view additional menu items. At every level of the menu, pressing the **CANCEL** button returns the system to the previous menu level. Repeatedly pressing the **CANCEL** button returns the system to the Main menu.

The opening menu is the access point to all other operations. There are four Main menu items: STATUS, CONFIGURATION, UTILITY, and TEST. Each Main menu item has several functions and submenus to identify and access specific parameters. In the discussions that follow, each Main menu item contains a complete menu diagram to identify the location of each operation.

DETAILED MENU OPERATION

Menu flow is normally depicted from left to right. Arrows on the lower right of the screen indicate the direction of scrolling to view additional menu items. At every level of the menu, pressing the **CANCEL** button returns the system to the previous menu level. Repeatedly pressing the **CANCEL** button returns the system to the Main menu.

1)STATUS

The Status menu branch lets you view the status of the T1 ESF CSU ACE operation. See Figure 3-9.

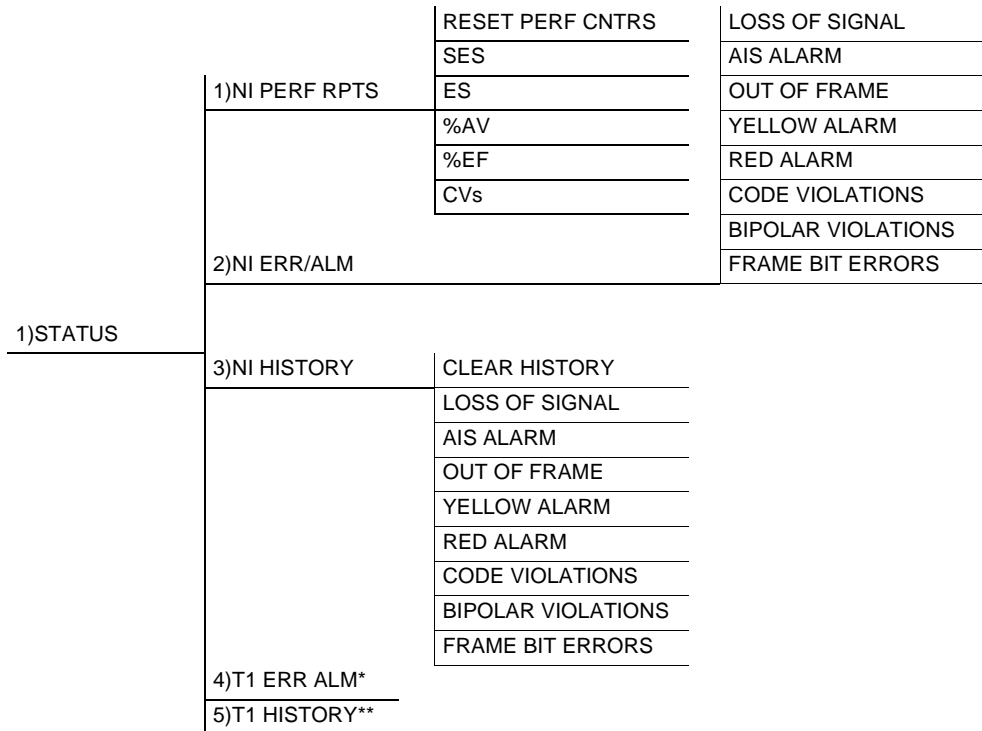

*T1 ERR/ALM has the same menu sub-branches as NI ERR/ALM.

**T1 HISTORY has the same sub-branches as NI HISTORY.

Figure 3-9. Status Menu Tree

1)NI PERF RPTS, Submenu of 1)STATUS

The Network Interface Performance Reports menu item displays the *user copy* of the performance data. The T1 ESF CSU ACE maintains this performance data on the network in compliance with ANSI T1.403 and AT&T document TR54016. The data displayed is data accumulated over the last 15 minutes and over the last 24 hours.



Figure 3-10. First Menu of NI PERF RPTS Menu

These fields cannot be edited, only cleared, as previously discussed. Only the user copy of the performance data is cleared. The network management performance data history remains unaffected.

Separate carrier totals are kept which can only be retrieved and reset from the network.

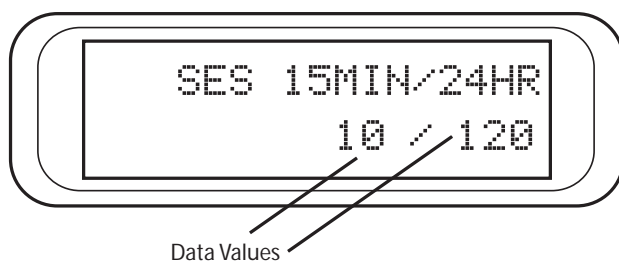

Figure 3-11. Performance Counter Screen

The counters used in the performance screens are defined below.

SES	Number of severely errored seconds
ES	Number of errored seconds
%AV	Percent of available seconds
%EF	Percent of error free seconds
CVs	Number of code violations

Continue with standard operation procedures to exit the display.



Since only the user's copy of performance data is cleared by the T1 ESF CSU ACE, the data displayed here might be different from the data being sent to the network as maintenance message data.

2)NI ERR/ALM, Submenu of 1)STATUS

The NI ERR/ALM menu is used for viewing currently active/inactive errors and alarms on the network interface.



Figure 3-12. First Current NI Errors/Alarms Screen

The up and down scroll keys are used to access the complete display of the errors/alarms that are currently active. The alarms and errors which can be seen are shown below:

Loss of Signal	No pulses received at NI
AIS Alarm	Unframed all-ones received at NI
Out of Frame	No framing pattern sync at NI
Yellow Alarm	Receiving yellow alarm pattern from NI
Red Alarm	LOS (loss of signal)/out of frame (OOF) causing red alarm at NI
Code Violations	Bipolar violations (BPVs), frame bit errors, and cyclic redundancy check (CRC) errors in ESF or BPVs and frame bit errors in SF were received at NI
Bipolar Violations	BPVs in SF or ESF at NI
Frame Bit Errors	Frame bits received incorrectly at NI

3)NI HISTORY, Submenu of 1)STATUS

The NI History menu is used for viewing the history of errors and alarms on the network interface. If an alarm has occurred since the last Clear History selection, the menu will be active. If the condition hasn't occurred, the menu will be inactive. The Clear History screen is shown in Figure 3-13.

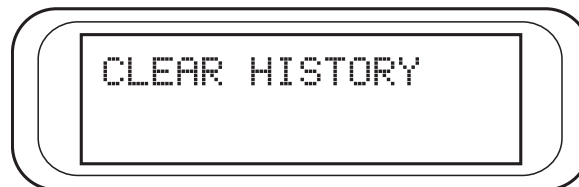

Figure 3-13. Clear History Screen

The conditions reported are the same as those in the NI ERR/ALM submenu but provide historical data on Alarms/Errors instead of *current* data on Alarm/Errors.

4)TI ERR/ALM, Submenu of 1)STATUS

The T1 ERR/ALM screens are the same as the NI ERR/ALM screens except that they correspond to the terminal interface.

5)TI HISTORY, Submenu of 1)STATUS

The T1 HISTORY screens are the same as the NI HISTORY screens except that they correspond to the terminal interface.

2)CONFIG

Use the Configuration menu to set the T1 ESF CSU ACE operational configuration, including all of the network interface parameters and the terminal interface parameters. See Figure 3-14.

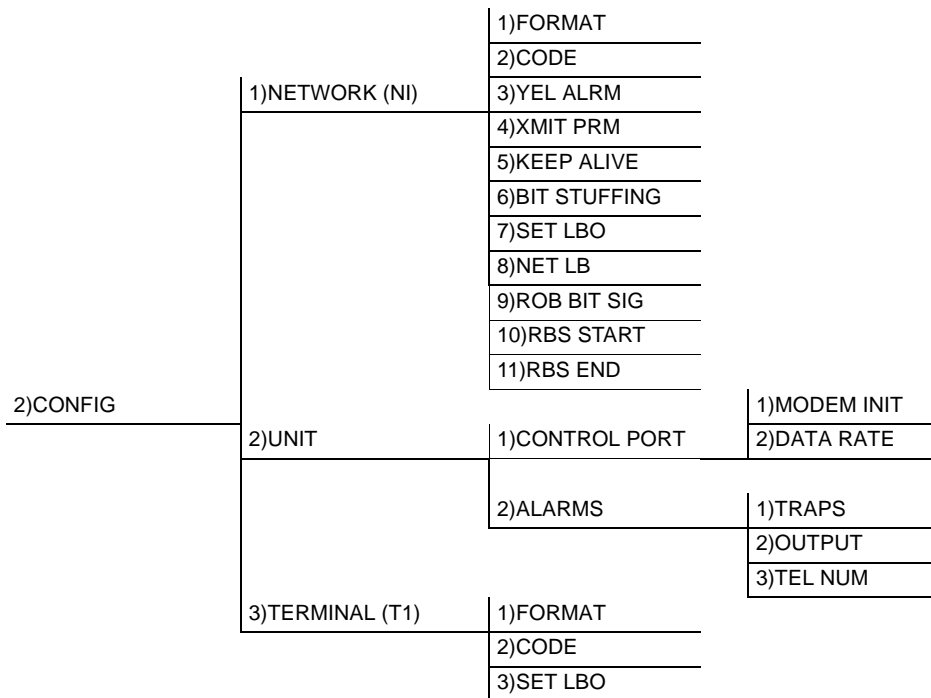

Figure 3-14. Configuration Menu Tree

1)NETWORK (NI), Submenu of 2)CONFIG

This menu is used to access the configuration of parameters associated with the network interface in the T1 ESF CSU ACE. There are nine submenu items that include setting the format and the line build out (LBO).



Figure 3-15. Network (NI) Submenu

Continue with standard operating procedures to edit the Network Interface parameters.

The fields and parameters available are as follows:

1)FORMAT

Sets the frame format for the NI. The factory default is ESF.

D4

ESF



D4 is equivalent to superframe format (SF).

2)CODE

Sets the line code for the NI. The factory default is B8ZS.

AMI

B8ZS

3)YEL ALRM

Enables and disables the transmission of yellow alarms. The factory default is ENABLED.

ENABLED

DISABLED

4)XMIT PRM

Enables and disables the transmitting of performance report messages (PRM) data on the facility data link (FDL). The PRM data continues to be collected even if PRM is disabled. (Possible only with ESF Format.) The factory default is OFF.

OFF

ON

5)KEEP ALIVE

Selects framed or unframed keep alive signal to be transmitted from NI when TI is in red alarm. The factory default is UNFRAMED.

FRAMED

UNFRAMED

6)BIT STUFFING

When enabled, bit stuffing causes the T1 ESF CSU ACE to monitor for ones (1s) density violations and inserts a one (1) when needed to maintain ones at 12.5 percent. This option should be disabled if B8ZS is enabled. The factory default is DISABLED.

ENABLED

DISABLED

7)SET LBO

Selects the line build out for the network interface. The factory default is 0 dB.

0 dB

-7.5 dB

-15 dB

-22.5 dB



When interfacing to a Smart jack, the 0 dB setting typically works best because most Smart jacks expect a strong receive level.

8)NET LB

When enabled, the T1 ESF CSU ACE responds to loopback codes from the network interface. The factory default is ENABLED.

ENABLED

DISABLED

9) ROB BIT SIG

Enables and disables robbed-bit signaling. This option should be enabled in applications when the terminal interface (TI) is connected to equipment for voice or dialed data services (PBX/SW56). When enabled, robbed bit signaling will occur in the user specified DS0s. The DS0s must be contiguous, and are defined by a starting and ending DS0. The factory default is Disabled.

ENABLE

DISABLE

10) RBS START

When robbed-bit signaling is enabled, enter the first DS0 in which robbed-bit signaling will occur (1-24). The factory default is 1.

11) RBS END

When robbed-bit signaling is enabled, enter the last DS0 in which robbed-bit signaling will occur (1-24). The factory default is 24.

2)UNIT, Submenu of 2)CONFIG

This menu is used to change control port and alarm trap options. See Figure 3-16.

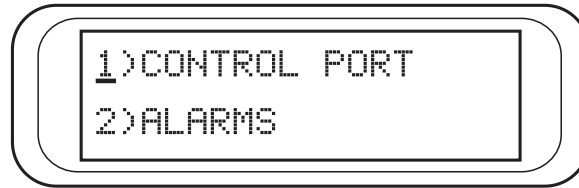

Figure 3-16. First 2)UNIT Submenu SScreen

1)CONTROL PORT

Used to set up the unit to initialize a modem and the control port data rate.

1)MODEM INIT - The T1 ESF CSU ACE is capable of initializing a modem. Prior to modem initialization it should be physically connected to the T1 ESF CSU ACE and the power turned on. At this point, an industry-standard AT command string is used to initialize the modem. The string is also used following future power-up sequences. The factory default is **DISABLED**.

ENABLED
DISABLED

2)DATA RATE - Selects the data rate for the control port. This should be consistent with the modem and/or PC/proxy agent serial port. The factory default is **9600**.

1200
2400
9600

2)ALARMS

Used to initialize the method by which the control port handles alarm conditions.

1)TRAPS - This setting determines whether alarm conditions should automatically send alarm messages (traps) to the controlling PC/proxy agent. The factory default is **DISABLED**.

ENABLED
DISABLED

2)OUTPUT - Selects whether the alarm traps (if enabled) are sent directly, or whether the telephone number stored in the T1 ESF CSU ACE should be dialed first (industry-standard AT dial command sent to modem). The factory default is **DIRECT**.

DIRECT
DIAL

3)TEL NUM - This is the telephone number dialed for alarm traps transmission. The string can be up to 20 characters in length and is terminated with a semicolon (;). A colon (:) is used to represent a pause in the dial string.

Example: Number 9:5551212; would dial 9, pause momentarily, and then send 5551212. This pause could be effected to access an outside line from a PBX, etc.

When editing a specific character, the scroll keys are used to scroll from 0 to 9, then colon(:) and semicolon (;). The new telephone number is entered into the T1 ESF CSU ACE only upon pressing **ENTER** after typing the semicolon (;).

Input - 20 digits (0 through 9, : and ;)



*The typed digits are accepted only after pressing **ENTER**. The telephone numbers can be cleared by entering a semicolon (;) as the first digit.*

3)TERMINAL (TI), Submenu of 2)CONFIG

This menu item is used to select and configure the parameters associated with the T1 ESF CSU ACE terminal interface.

1)FORMAT

Sets the frame format for the T1. The factory default is **ESF**.

D4
ESF

2)CODE

Sets the line code for the T1. The factory default is **B8ZS**.

AMI
B8ZS

3)SET LBO

Sets the transmit LBO for the T1. The factory default is **0 - 133 feet**.

0 - 133 feet
133 - 266 feet
266 - 399 feet
399 - 533 feet
533 - 655 feet
-7.5 dB

3)UTIL

Use the Utility menu to view and set system parameters. See Figure 3-17. This includes setting the time and date and resetting all parameters to factory values or to re-initialize the unit. This menu is also used to view the unit's software revision and ID setting.

3)UTIL	1)SOFTWARE REV	(Displays current software rev.)
	2)REINIT UNIT	
	3)ADDRESS	
	4)SET PASSCODE	
	5)FACT RESTORE	(Returns all configurations to factory settings.)
	6)REMOTE T-WATCH	1)ACCESS TYPE (Select remote unit type.)
	2)SHELF SNMP ID:	
	3)SHELF SLOT:	

Figure 3-17. Utility Menu Tree

1)SOFTWARE REV, Submenu of 3)UTIL

Use this submenu to display the current software revision level. This information is required when requesting assistance from ADTRAN Customer Service or when updates are needed. The top line gives the revision of interest. The bottom line displays information of use to ADTRAN only.

Follow standard operating procedures to access the 3)UTIL menu items.

2)REINIT UNIT, Submenu of 3)UTIL

Use this submenu to re-initialize the unit. This menu item does *not* restore factory default settings, but simply resets the unit and causes it to run through its self test and initialization cycles.

3)ADDRESS, Submenu of 3)UTIL

Use this submenu to access the current Unit Address setting. Unit identification numbers must be between 000 and 999. See Figure 3-18.

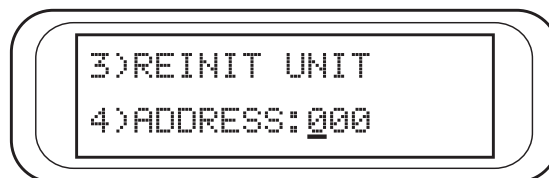

Figure 3-18. Re-initialize Unit/Address Screen

4)SET PASSCODE, Submenu of 3)UTIL

Use this submenu to access the passcode setting needed to control port access. The Unit Identification number is limited to four digits between 0001 and 9999.

5)FACT RESTORE, Submenu of 3)UTIL

Use this submenu to restore factory default settings for all unit parameters. This restores all parameters to the factory settings.

6)REMOTE T-WATCH, Submenu of 3)UTIL

To communicate with a far-end unit via the FDL (i.e., from a proxy such as T-Watch), identify the remote unit as a standalone or rackmount. Use this option to select the remote unit type, ID, and slot number. The ID and slot number are only applicable if the selected remote unit is rackmount, so these may be left blank if the remote unit is standalone.

1)ACCESS TYPE (REMOTE UNIT)

- 1)STANDALONE - The far-end unit is standalone.
- 2)RACKMOUNT - The far-end is a rackmount.

2)SHELF SNMP ID

Enter the SNMP ID of the far-end rackmount unit (0-255).

3)SHELF SLOT

Enter the slot number of the far-end rackmount unit (1-16).

NOTE *This type of communication may not be available with all T1 products.*

4)TEST

Use the Test menu to initiate different types of tests of the unit and view test results. The menu contains four sub-items. See Figure 3-19.

NOTE *The execution of tests disrupts some of the normal operation. See individual menu items concerning tests before executing.*

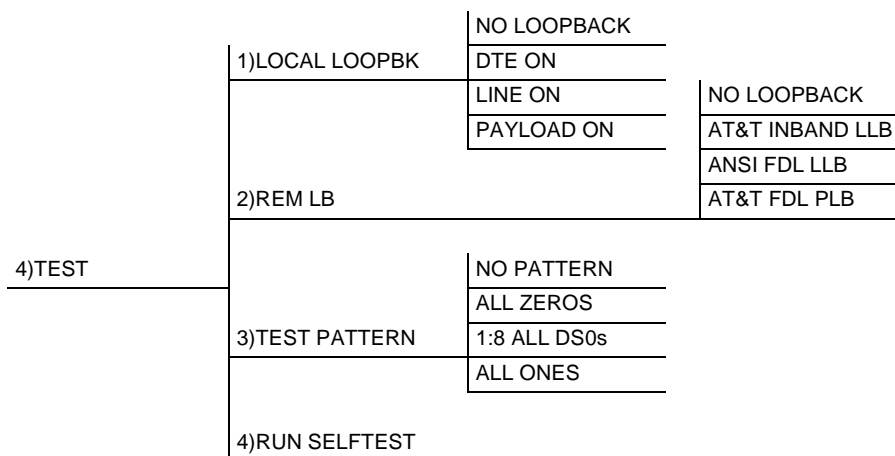

Figure 3-19. Test Menu Tree

Tests are used to control the activation of loopbacks, the initiation of data test patterns, and self test execution.

1)LOCAL LOOPBK, Submenu of 4)TEST

Four choices are available for setting the local loopback:

- NO LOOPBACK** Deactivates the loopback
- DTE ON** Activates the DTE loopback
- LINE ON** Activates the line loopback
- PAYLOAD ON** Activates the payload loopback



Figure 3-20. Local Loopback Test Screen

2)REM LB, Submenu of 4)TEST

Activates the same loopbacks as the LOCAL LOOPBK but at the far end. This uses either the inband loop-up code as specified by AT&T 62411 for line loopback (ATT In-Band LLB), or the FDL as specified in ANSI T1.403 for line loopback codes. An FDL (formerly TABS) maintenance message corresponding to AT&T TR54016 can be used for payload loopback as well:

- NO LOOPBACK** Deactivates the loopback.
- AT&T INBAND LLB** Activates the line loopback using inband code.
- ANSI FDL LLB** Initiates the transmission of an FDL line loop-up code toward the far end.
- AT&T FDL PLB** Initiates the transmission of the PLB maintenance messages on the FDL.



When a loopback method is selected, the T1 ESF CSU ACE displays LOOPING in the top right corner of the LCD and the yellow LOOPBACK LED is turned on. When the T1 ESF CSU ACE determines that the far-end T1 ESF CSU ACE has looped up, the T1 ESF CSU ACE displays LOOPED. If the T1 ESF CSU ACE does not recognize the remote T1 ESF CSU ACE looped up after about 10 seconds, the T1 ESF CSU ACE sends the appropriate loop-down code and displays FAILED, and the LOOPBACK LED is turned off.

Excessive errors on the T1 line can cause this failure. The FDL loopbacks fail if the FDL is not intact from one end point to the other. FDL loopbacks are valid only in the ESF framing mode.

3)TEST PATTERN, Submenu of 4)TEST

Sets the pattern for the test and initiates the transmission of the pattern. The test is terminated by selecting **NO PATTERN**. There are four patterns available:

NO PATTERN	Terminates pattern generation.
ALL ZEROS	Generates an all zeros pattern in every channel.
1:8 ALL DS0s	Generates a 1 in 8 pattern in all DS0s.
ALL ONES	Generates an all ones pattern in every channel.

Use up and down scroll keys	To select, for example, 1:8 ALL DS0s.
Press ENTER	To record selection.
Results	The T1 ESF CSU ACE starts to generate a 1:8 test pattern and inserts the pattern into all DS0s.
Select NO PATTERN	To end the test.

4)RUN SELFTEST, Submenu of 4)TEST

Use this menu selection to execute an internal self test. This is the same self test that is performed automatically at power-up. The results of the self tests are displayed in the LCD (see Figure 3-21). Upon invoking the command, the LCD displays **INITIALIZING** and test failures are displayed in the LCD window.

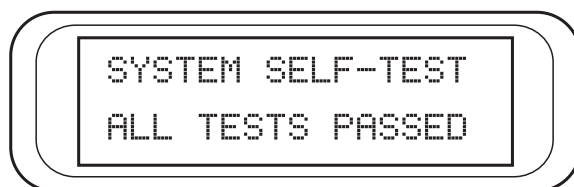

Figure 3-21. Self Test Result Screen

If a failure is detected, note the failure prior to contacting ADTRAN technical support.



The execution of a self test disrupts normal data flow and prevents remote communication until the self test is completed (approximately five seconds).

Appendix A Pinouts

Table A-1. RJ-48C Connector Pin Assignments

Pin	Description	NET	CPE
1	R1	Receive data (from network to CSU)	Transmit data (from CSU to DTE)
2	T1	Receive data (from network to CSU)	Transmit data (from CSU to DTE)
3	--	Not used	Not used
4	R	Transmit data (from CSU to network)	Receive data (from DTE to CSU)
5	T	Transmit data (from CSU to network)	Receive data (from DTE to CSU)
7	--	Not used	Not used
8	--	Not used	Not used

Table A-2. EIA-232 Connector Pin Assignments

Pin	Name	Description
2	TD	Data from DTE to CSU
3	RD	Data from CSU to DTE
7	SG	Signal ground

Appendix B **Specification Summary**

SPECIFICATIONS AND FEATURES

Specifications and features of the T1 ESF CSU ACE are provided in this chapter.

Network Interface

DSI interface per AT&T 62411 and ANSI T1.403

Network Framing Format

D4 (SF) or ESF

Network Line Code

AMI or B8ZS

Network TX LBO

Configurable from 0.0 to -22.5 dB

Performance Monitoring

As per ANSI T1.403 and AT&T 54016

DTE Interface

DSX-1 interface per ANSI T1.102

DTE Framing Format

D4 (SF) or ESF

DTE Line Code

AMI or B8ZS

DTE TX LBO

DSX-1 up to 655 feet of 22-gauge ADAM cable

Monitor and Configuration Access

- Front panel keypad and display
- EIA-232 control port
- T-Watch over FDL (ESF only)

Diagnostics

- Self Test
- Local Loopbacks
- Remote Loopbacks
- Test Patterns

Environment

Temperature:

Operating 0 to 50 deg C
 (32 to 122 deg F)

Storage -20 to 70 deg C
 (-4 to 158 deg F)

Relative humidity: Up to 95%, noncondensing

Hardware Specifications

- Dimensions: 1.75”H x 6.25”D x 9.25”W
- Weight: 1 lb.
- Power: -12 VDC @ 250 mA; 115 VAC @ 60 mA (Provided wall mount supply)
- MTBF: 784,314 hours
- CLEI: NCT1CD9BAA

Appendix C Acronyms/Abbreviations

ACK	acknowledgment
ANSI	American National Standards Institute
AR	access rate
ARP	address resolution protocol
async	asynchronous
BECN	backward explicit congestion notification
BOP	bit oriented protocol
CCITT	Consultive Committee for International Telephony and Telegraphy
CD	carrier detect
CO	central office
CPE	customer premise equipment
CRC	cyclic redundancy check
CS	clear to send
CSU	channel service unit
CTS	clear to send
dB	decibel
DBU	Dial backup
DCD	data carrier detect
DCE	data communications equipment
DDS	digital data service
DE	discard eligible
DLCI	data link connection identifier
DSAP	directory scope analysis program
DSR	data set ready
DSU	data service unit
DTE	data terminal equipment
DTR	data terminal ready
FDL	facility data link
FECN	forward explicit congestion notification
FEP	front end processor
FIFO	first in first out

FR	frame relay
FRAD	frame relay access device
FRF	frame relay forum
FSU	frame relay service unit
HDLC	high-speed data link control
IP	internet protocol
ISDN	integrated services digital network
ITU	International Telecommunications Union
KA	keep alive
LAN	local area network
LED	light emitting diode
LLC	logical link control
LMI	local management interface
LRC	lateral redundancy check
MIB	management information base
ms	millisecond
NRZ	non-return to zero
NRZI	non-return to zero inverted
OCU	office channel unit
OOS	out of service
PLAR	private line automatic ringdown
PPP	point to point protocol
PU	physical unit
PVC	permanent virtual circuit
RD	receive data
RDL	remote digital loopback
RFC	request for comments
RFECN	remote forward explicit congestion notification
RIP	routing information protocol
RMA	return material authorization
RR	receiver ready
RS	recommended standard
RTS	request to send
Rx	receive
SAP	service access point
SDLC	synchronous data link control
SLIP	serial line internet protocol

SNA	systems network architecture
SNMP	simple network management protocol
SNRM	set normal response mode
SR	data set ready
SVC	switched virtual circuit
SW56	switched 56
sync	synchronous
TD	transmit data
TR	data terminal ready
Tx	transmit
UNI	user-to-network interface
VRC	vertical redundancy check
WAN	wide area network
XID	exchange identification
XMIT	transmit

4-wire Switched 56

An AT&T proprietary 56/64 kbps switched digital data service offered by telco service providers and delivered to users over 4 copper wires. Compatible with the T1 ESF CSU ACE 4-wire Switched 56 DBU option.

ANSI

American National Standards Institute. Devices and proposes recommendations for international communications standards.

asynchronous

A method of data transmission which allows characters to be sent at irregular intervals by preceding each character with a start bit, followed by a stop bit.

bandwidth

The bandwidth determines the rate at which information can be sent through a channel (the greater the bandwidth, the more information that can be sent in a given amount of time).

BECN

backward explicit congestion notification. A bit set by a frame relay network to notify an interface device (DTE) that congestion avoidance procedures should be initiated by the sending device.

bridge

A device that supports LAN-to-LAN communications. Bridges may be equipped to provide frame relay support to the LAN devices they serve. A frame relay capable bridge encapsulates LAN frames in frame relay frames and feeds them to a frame relay switch for transmission across the network. A frame relay capable bridge also receives frame relay frames from the network, strips the frame relay frame off each LAN frame, and passes the LAN frame on to the end device. Bridges are generally used to connect LAN segments to other LAN segments or to a WAN. They route traffic on the Level 2 LAN protocol (e.g. the Media Access Control address), which occupies the lower sub-layer of the LAN OSI data link layer. See also *router*.

CCITT

Consultive Committee for International Telephony and Telegraphy. A standards organization that devises and proposes recommendations for international communications. See also *ANSI*.

CD

carrier detect. A signal generated by a modem or DSU/CSU. CD indicates the presence of a carrier signal on a communications link.

clocking

An oscillator-generated signal that provides a timing reference for a transmission link. A clock provides signals used in a transmission system to control the timing of certain functions. The clock has two functions, (1) to generate periodic signals for synchronization and (2) to provide a time base.

CPE

customer premise equipment. All telecommunications terminal equipment located on the customer premises, including telephone sets, private branch exchanges (PBXs), data terminals, and customer-owned coin-operated telephones.

CRC

cyclic redundancy check. A computational means to ensure the accuracy of frames transmitted between devices in a frame relay network. The mathematical function is computed, before the frame is transmitted, at the originating device. Its numerical value is computed based on the content of the frame. This value is compared with a recomputed value of the function at the destination device. See also *FCS*.

CS

See *CTS*.

CSU

channel service unit. A device used to connect a digital phone line (T1 or Switched 56 line) coming in from the phone company to either a multiplexer, channel bank, or directly to another device producing a digital signal; for example, a digital PBX, a PC, or data communications device. A CSU performs certain line-conditioning and equalization functions, and responds to loopback commands sent from the central office. A CSU regenerates digital signals. It monitors them for problems, and provides a way of testing the digital circuit.

CTS

clear to send. A signal on the DTE interface indicating that the DCE is clear to send data.

dB

decibel. A unit of measure of signal strength, usually the relation between a transmitted signal and a standard signal source.

DCE

data communications equipment. Device that provides all the functions required for connection to telephone company lines and for converting signals between telephone lines and DTE. Also see *DTE*.

DDS

digital data service. A private line digital service, for transmitting data end-to-end at speeds of 2.4, 4.8, 9.6, and 56 kbps and in some cases 19.2, 38.4, or 64 kbps. The systems can use central hub offices for obtaining test access, bridging legs of multipoint circuits, and cross connecting equipment. DDS is offered on an inter-LATA basis by AT&T and on an intra-LATA basis by the Bell operating companies.

DE

discard eligibility. A user-set bit indicating that a frame may be discarded in preference to other frames if congestion occurs, to maintain the committed quality of service within the network. Frames with the DE bit set are considered excess data.

DLCI

data link connection identifier. A unique number assigned to a PVC end point in a frame relay network. Identifies a particular PVC endpoint within a user's access channel in a frame relay network and has local significance only to that channel.

DSU

data service unit. A device designed to transmit and receive digital data on digital transmission facilities.

DSU loopback

A telco initiated test which loops the DSU back to the telco and is used to test the DDS circuit as well as the DSU/CSU.

DTE

data terminal equipment. The end-user terminal or computer that plugs into the termination point (DCE) of a communications circuit. The main difference between the DCE and the DTE is that pins two and three are reversed.

encapsulation

A process by which an interface device places an end device's protocol-specific frames inside a frame relay frame. The network accepts only frames formatted specifically for frame relay; therefore interface devices acting as interfaces to a frame relay network must perform encapsulation. See also *interface device* or *frame relay capable interface device*.

end device

The ultimate source or destination of data flowing through a frame relay network sometimes referred to as DTE. As a source device, it sends data to an interface device for encapsulation in a frame relay frame. As a destination device, it receives de-encapsulated data (i.e., the frame relay frame is stripped off, leaving only the user's data) from the interface device.

FCS

frame check sequence. The standard 16-bit cyclic redundancy check used for HDLC and frame relay frames. The FCS detects bit errors occurring in the bits of the frame between the opening flag and the FCS, and is only effective in detecting errors in frames no larger than 4096 octets. See also *CRC*.

FDL

facility data link. A 4 bit/s non-disruptive management channel provided in ESF framing mode. This data link conforms to ANSI T1.403 and AT&T TR 54016 specifications.

FECN

forward explicit congestion notification. A bit set by a frame relay network to notify an interface device (DTE) that congestion avoidance procedures should be initiated by the receiving device. See also *BECN*.

file server

In the context of frame relay network supporting LAN-to-LAN communications, a device connecting a series of workstations within a given LAN. The device performs error recover and flow control functions as well as end-to-end acknowledgment of data during data transfer, thereby significantly reducing overhead within the frame relay network.

frame-relay-capable interface device

A communications device that performs encapsulation. Frame-relay-capable routers and bridges are examples of interface devices used to interface the customer's equipment to frame relay network. See also *interface device* and *encapsulation*.

frame relay frame

A variable-length unit of data, in frame-relay format that is transmitted through a frame relay network as pure data. Contrast with *packet*. See also *Q.922A*.

frame relay network

A telecommunications network based on frame relay technology. Data is multiplexed. Contrast with packet switching network.

HDLC

high level data link control. A generic link-level communications protocol developed by the International Organization for Standardization (ISO). HDLC manages synchronous code-transparent, serial information transfer over a link connection. See also *SDLC*.

hop

A single trunk line between two switches in a frame relay network. An established PVC consists of a certain number of hops, spanning the distance from the ingress access interface to the egress access interface within the network.

host computer

The primary or controlling computer in a multiple computer operation.

in-band

Signaling (dialing, diagnostics, management, configuration, etc.) over the same channel used for data.

ingress

Frame relay frames leaving from an access device in a direction toward the frame relay network.

interface device

Provides the interface between the end device(s) and a frame relay network by encapsulating the user's native protocol in frame relay frames and sending the frames across the frame relay backbone. See also *encapsulation* and *frame-relay-capable interface device*.

ISDN

Integrated Services Digital Network. A network architecture that enables end-to-end digital connections. The network supports diverse services through integrated access arrangements and defines a limited set of standard, multipurpose interfaces for equipment vendors, network providers, and customers. Networking with a public switched telephone network is retained.

LAN

local area network. A privately owned network that offers high-speed communications channels to connect information processing equipment in a limited geographic area.

out-of-band

Signaling that is separated from the channel carrying information (voice, data, video, etc.). Typically the separation is accomplished by a filter. The signaling includes dialing and other supervisory signals.

packet

A message containing both control information and data. The control information is used for routing the packet through a network to its final destination. Contrast with *frame relay frame*.

packet-switching network

A telecommunications network based on packet-switching technology, wherein a transmission channel is occupied only for the duration of the transmission of the packet. Contrast with *frame relay network*.

parameter

A numerical code that controls an aspect of terminal and/or network operation. Parameters control such aspects as page size, data transmission speed, and timing options.

ping

An internet protocol standard that provides loopback on demand for any device in an IP network. One device “pings” another by sending a loopback request to the device's IP address.

point-to-point

Type of communications link that connects a single device to another single device, such as a remote terminal to a host computer.

PVC

permanent virtual circuit. A frame relay logical link, whose endpoints and class of service are defined by network management. Analogous to an X.25 permanent virtual circuit, a PVC consists of the originating frame relay network element address, originating data link control identifier, terminating frame relay network element address, and termination data link control identifier. Originating refers to the access interface from which the PVC is initiated. Terminating refers to the access interface at which the PVC stops. Many data network customers require a PVC between two points. Data terminating equipment with a need for continuous communication use PVCs. See also *DLCI*.

remote configuration

A feature designed into ADTRAN DSU/CSU products that allow remote DSU/CSU to be configured from a local DSU/CSU or VT100 compatible terminal.

router

A device that supports LAN-to-LAN communications. Routers may be equipped to provide frame relay support to the LAN devices they serve. A frame-relay-capable router encapsulates LAN frames in a frame relay frames and feeds those frame relay frames to a frame relay switch for transmission across the network. A frame-relay-capable router also receives frame relay frames from the network, strips the frame relay frame off each frame to produce the original LAN frame, and passes the LAN frame on to the end device. Routers connect multiple LAN segments to each other or to a WAN. Routers route traffic on the Level 3 LAN protocol (e.g., the internet protocol address). See also *bridge*.

SDLC

synchronous data link control. A link-level communications protocol used in an international business machines (IBM) systems Network Architecture (SNA) network that manages synchronous, code-transparent, serial information transfer over a link connection. SDLC is a subset of the HDLC protocol developed by ISO.

service

The provision of telecommunications to customers by a common carrier, administration, or private operating agency, using voice, data, and/or video technologies.

SNMP

simple network management protocol. A control and reporting scheme widely used to manage devices from different vendors. SNMP operates on top of the Internet protocol.

SR

data set ready. A signal on the EIA-232 interface that indicates if the communications is connected and ready to start handshaking control signals so communications can begin.

statistical multiplexing

Interleaving the data input of two or more devices on a single channel or access line for transmission through a frame relay network. Interleaving of data is accomplished using the DLCI.

switched network

The network of dial-up telephone lines using circuit switching to provide communications services to network users.

synchronous

Communications in which the timing is achieved by sharing a single clock. Each end of the transmission synchronizes itself with the use of clocks and information sent along with the transmitted data.

T1

Transmission rate of 1.544 Mbps on T1 communication lines. A T1 facility carries a 1.544 Mbps digital signal. Also referred to as digital signal level 1 (DS-1). See also *E1*.

trunk line

A communications line connecting two frame relay switches to each other.

VT100

A non-intelligent terminal or terminal emulation mode used for asynchronous communications. Used to configure the T1 ESF CSU ACE.

Index

Numerics

1 in 8 pattern 26

A

ACCESS TYPE (REMOTE UNIT) 48

ADDRESS 47

ADTRAN PC program 23

ALARMS 45

all ones pattern 26

all zeroes pattern 26

applications 26

arrows, menus 34

ASCII terminal 23

B

BIT STUFFING 44

C

channel bank application 28

CODE 43, 46

CONFIG 42

Configuration menu 42

connectors

 EIA-232 30

 RJ-48C 30

control methods 23

 ASCII terminal 23

 front panel 23

CONTROL PORT 45

control port 22

D

D4 superframe 19

DATA RATE 45

display field 34

DTE interface loopback 25

E

EAI-232 connector 30

ESF CSU

 applications 26

 control methods 23

 features 21

 front view 20

 operation 33

 overview 19

T1 application 20

testing 24

F

FACT RESTORE 47

features 21

FORMAT 43, 46

front panel 20

 control 23

 operation 33

G

general data application 27

general menu operation 34

general voice application 28

I

initialization 31

Installation 29

interface loopbacks 25

interfaces 22

 control port 22

 network interface 22

 T1 (CPE) 22

J

jack signal directions 21

K

KEEP ALIVE 43

L

line loopback 25

LOCAL LOOPBK 49

loopback tests 25

M

menu

 arrows 34

 Configuration 42

 data field 34

 example operation 34

 exiting or returning to previous menus 36

 selecting menu item 34

 selecting submenu item 35

- setting/cancelling data field 35
- Status 38
- structure 36
- Test 48
- tools 34
- Utility 46

methods of control 23
MODEM INIT 45

N

NET LB 44
NETWORK (NI) 42
network interface port 22
network loopbacks 25
NI ERR/ALM 41
NI HISTORY 41
NI PERF RPT 40

O

Operation 33
operation

- via front panel 33

operation of unit 33
OUTPUT 45

P

packaging 29
pattern generation 26
payload loopback 25
PC control 23
pinouts 51, 53
power connection 29
power-up testing 31

R

REINIT UNIT 47
REM LB 49
REMOTE T-WATCH 48
RJ-48C connector 30
RUN SELFTTEST 50

S

self test 24, 31
SET LBO 44, 46

setting/cancelling data field 35
SHELF SLOT 48
SHELF SNMP ID 48
shipping contents 29
signal directions 21
Simple Network Management Protocol 23
SNMP 23
SOFTWARE REV 47
STATUS 38
Status menu 38
superframe 19

T

T1 application 20
T1 ERR/ALM 41
T1 interface 22
T1 service 19
TEL NUM 46
TERMINAL (TI) 46
TEST 46, 48
Test menu 48
TEST PATTERN 50
test pattern 26
testing 24

- interface loopbacks 25
- network loopbacks 25
- self test 24

TI HISTORY 42
TRAPS 45
T-Watch 23

U

UNIT 45
UTIL 46
Utility menu 46

W

wiring 30

X

XMIT PRM 43

Y

YEL ALRM 43

Free Manuals Download Website

<http://myh66.com>

<http://usermanuals.us>

<http://www.somanuals.com>

<http://www.4manuals.cc>

<http://www.manual-lib.com>

<http://www.404manual.com>

<http://www.luxmanual.com>

<http://aubethermostatmanual.com>

Golf course search by state

<http://golfingnear.com>

Email search by domain

<http://emailbydomain.com>

Auto manuals search

<http://auto.somanuals.com>

TV manuals search

<http://tv.somanuals.com>