



Express XL and Express XLT ISDN Router/Bridge

USER MANUAL

Express XL, Data Only	1200070L1
Express XLT with POTS Option	1200070L2

61200.070L1-1B
February 1998

Trademark:

DMS-100 is a trademark of Northern Telecom, Inc.

Ethernet is a trademark of Digital Equipment Corporation, Intel Corporation, and Xerox Corporation.

ExpertISDN (patent number 5,715,241) is a trademark of ADTRAN, Inc.

Macintosh is a registered trademark of Apple Computer, Inc.

Novell, NetWare, and Internetwork Packet Exchange (IPX) are registered trademarks of Novell, Inc.

Windows is a registered trademark of Microsoft Corporation.

5ESS is a registered trademark of AT&T.

The Express XL and Express XLT incorporate Synchronous Data Compression based on either IBM or hi/fn proprietary intellectual property depending on the time of manufacture. The following trademarks and copyrights are applicable:

Stacker LZS Compression

Copyright © 1989 Carnegie Mellon University

All rights reserved.

Redistribution and use in source and binary forms are permitted provided that the above copyright notice and this paragraph are duplicated in all such forms and that any documentation, advertising materials, and other materials related to such distribution and use acknowledge that the software was developed by Carnegie Mellon University. The name of the University may not be used to endorse or promote products derived from this software without specific prior written permission. This software is provided "as is" and without any express or implied warranties, including, without limitation, the implied warranties of merchantability and fitness for a particular purpose.

hi/fn

5993 Avenida Encinas

Carlsbad, CA

STACKER
LZS
COMPRESSION

ADTRAN

901 Explorer Boulevard

P.O. Box 140000

Huntsville, AL 35814-4000

Phone: (205) 963-8000

© 1998 ADTRAN, Inc.

All rights reserved.

Printed in USA.

FCC regulations require that the following information be provided in this manual:

1. If this equipment causes harm to the telephone network, the telephone company may temporarily discontinue service. If possible, advance notification is given; otherwise, notification is given as soon as possible. The telephone company will advise the customer of the right to file a complaint with the FCC.
2. The telephone company may make changes in its facilities, equipment, operations, or procedures that could affect the proper operation of this equipment; advance notification and the opportunity to maintain uninterrupted service are given.
3. If experiencing difficulty with this equipment, please contact ADTRAN (see inside back cover) for repair and warranty information. The telephone company may require this equipment to be disconnected from the network until the problem is corrected, or it is certain the equipment is not malfunctioning.
4. This unit contains no user serviceable parts.

To ADTRAN service personnel: For continued protection against risk of fire, replace F1 with the same type and rating of fuse only: .2A, 250 V.

FEDERAL COMMUNICATIONS COMMISSION RADIO FREQUENCY INTERFERENCE STATEMENT

This equipment has been tested and found to comply with the limits for a Class B digital device, pursuant to Part 15 of the FCC Rules. These limits are designed to provide reasonable protection against harmful interference in a residential environment. This equipment generates, uses, and can radiate radio frequency energy and, if not installed and used in accordance with the instructions, may cause harmful interference to radio or TV reception, which can be determined by turning the equipment off and on. The user is encouraged to try to correct the interference by one or more of the following measures:

- Reorient or relocate the receiving antenna.
- Increase the separation between the equipment and receiver.
- Connect the equipment into an outlet on a circuit different from that to which the receiver is connected.
- Consult the dealer or an experienced radio/TV technician for help.

WARNING

Changes or modifications to this unit not expressly approved by ADTRAN will void the user's authority to operate the equipment.

CANADIAN EMISSIONS REQUIREMENTS

This digital apparatus does not exceed the Class B limits for radio noise emissions from digital apparatus as set out in the interference-causing equipment standard entitled "Digital Apparatus," ICES-003 of the Department of Communications.

Cet appareil numérique respecte les limites de bruits radioélectriques applicables aux appareils numériques de Class B prescrites dans la norme sur le matériel brouilleur: "Appareils Numériques," NMB-003 édictée par le ministre des Communications.

CANADIAN EQUIPMENT LIMITATIONS

Notice: The Canadian Industry and Science Canada label identifies certified equipment. This certification means that the equipment meets certain telecommunications network protective, operational, and safety requirements. The Department does not guarantee the equipment will operate to the user's satisfaction.

Before installing this equipment, ensure that it is permissible to be connected to the facilities of the local telecommunications company. The equipment must also be installed using an acceptable method of connection. In some cases, the company's inside wiring associated with a single-line individual service may be extended by means of a certified connector assembly (telephone extension cord). Compliance with the above conditions may not prevent degradation of service in some situations.

Repairs to certified equipment should be made by an authorized Canadian maintenance facility designated by the supplier. Any repairs or alterations made by the user to this equipment, or equipment malfunctions, may give the telecommunications company cause to request the user to disconnect the equipment.

Users should ensure for their own protection that the electrical ground connections of the power utility, telephone lines, and internal metallic water pipe system, if present, are connected together. This precaution may be particularly important in rural areas.



Users should not attempt to make such connections themselves, but should contact the appropriate electric inspection authority, or an electrician, as appropriate.

The **Load Number** (LN) assigned to each terminal device denotes the percentage of the total load to be connected to a telephone loop which is used by the device, to prevent overloading. The termination on a loop may consist of any combination of devices subject only to the requirement that the total of the Load Numbers of all devices does not exceed 100.

Table of Contents

Quick Startup Guide	1
Setting up the ISDN Line	1
Connecting to an Internet Service Provider	2
Multiprotocol Routing Between Two LANs	3
Chapter 1. Understanding ISDN and the Express XL/XLT	7
ISDN Overview	7
THE EXPRESS XL/XLT.....	7
Applications	8
Single User to Corporate LAN.....	8
Single User IP to Internet Service Provider (ISP) using Network Address Translation (NAT).....	9
Multiple Users to Internet Service Provider (ISP) using NAT	10
Small Office - Home Office (SOHO) to Corporate LAN	11
Demand Routing and Bridging with the Express XL/XLT.....	12
Factory Default.....	12
Bridging.....	13
IP Routing	14
IPX Routing.....	15
Connection List - Simplifying and Enhancing the Dial Function.....	15
Concurrent Routing And Bridging.....	15
Routing over PPP Bridging.....	15
Network Address Translation Mode.....	16
Front Panel.....	16
LAN Indicators.....	16
WAN Indicators	17
Test Indicators	17
Pushbutton Tests.....	17
ISDN Connection.....	18
Ordering ISDN.....	19
Interoperability	19
Connecting to the Internet.....	19
Configuration	20
Security.....	20
Chapter 2. Installation	21
ISDN Network Connection.....	21
Local Area Network Connection	21
Telephone Connection (XLT Only).....	22
Basic Telephone Service.....	22
Supplementary Services	22
DTMF Keypad.....	22
Customer Premises Wiring	23

Chapter 3. Terminal Menu Operation and Structure	27
Terminal Menu Structure	27
Configuration	27
Dial	27
Status	29
Test	29
Logs	29
Utilities	29
Navigating the Terminal Menus	30
General Layout	30
Menu Path	30
Moving Around	30
Submenus [+] or [DATA]	30
Activation Field <+>	30
Editable Data Field	30
Read-Only Field	30
Navigation with the Keyboard	31
Security Levels	33
Configuration Menu	34
Configuration/System Info	34
System Name	34
System Location	34
System Contact	35
Firmware Revision	35
System Uptime	35
Date/Time	35
Configuration/WAN	36
WAN/ISDN	36
ISDN/Dial Line	36
Dial Line/ExpertISDN	36
Dial Line/Switch Protocol	37
Dial Line/Area Code	37
Dial Line/SPID 1	37
Dial Line/LDN 1 or 2	38
ISDN/Leased Line	38
Leased Line/Clock Mode	38
Leased Line/Channel Rate	38
ISDN/NEBEs	38
ISDN/FEBEs	39
WAN/POTS	39
POTS/POTS Assignment	39
POTS/NI-1 Conference FI	39
POTS/NI-1 Transfer FI	39
POTS/Speech Calltype Routing	39
Configuration/IP	40
IP/IP Address	40
IP/Subnet Mask	40
IP/Default Gateway	41

IP/Static Routes	41
Static Routes/Active	41
Static Routes/IP Address.....	41
Static Routes/Subnet Mask.....	41
Static Routes/Gateway.....	41
Static Routes/Hops.....	41
Static Routes/Private.....	42
IP/IP Router	42
IP Router/Mode	42
IP/RIP	42
RIP/Mode	42
RIP/Protocol	42
RIP/Method.....	43
RIP/Direction	43
RIP/V2 Secret	43
IP/NAT	43
NAT/DHCP Mode	43
NAT/DHCP Renewal Time	44
NAT/Web Server	44
IP/DNS.....	44
DNS/Domain Name.....	44
DNS/Server 1	44
DNS/Server 2	44
IP/UDP Relay.....	45
UDP Relay/Mode	45
UDP Relay/UDP Relay List.....	45
UDP Relay List/Relay Address.....	45
UDP Relay List/UDP Port Type	45
UDP Relay List/UDP Port 1, UDP Port 2, UDP Port 3	45
IP/Proxy ARP	46
Configuration/IPX	47
IPX/Mode	47
IPX/Network.....	47
IPX/Frame Type	48
IPX/Seed Status	48
IPX/RIP Timer	48
IPX/SAP Timer	49
Configuration/Bridge.....	50
Bridge/Mode.....	50
Bridge/WAN IP Bridge	50
WAN IP Bridge/Network	51
WAN IP Bridge/Netmask	51
WAN IP Bridge/Triggered.....	51
WAN IP Bridge/Proxy ARP.....	51
Bridge/WAN IPX Bridge	51
WAN IPX Bridge/Network.....	52
WAN IPX Bridge/Frame Type	52
WAN IPX Bridge/Seed Status	52
WAN IPX Bridge/Triggered	52

Table of Contents

Bridge/Spanning Tree.....	52
Spanning Tree/Mode	52
Spanning Tree/Priority	53
Spanning Tree/Maximum Age	53
Spanning Tree/Hello Time	53
Spanning Tree/Forward Delay	53
Spanning Tree/LAN Port	53
LAN Port/Active	53
LAN Port/Path Cost.....	54
LAN Port/Priority	54
Spanning Tree/WAN Port 0.....	54
WAN Port 0/Active.....	54
WAN Port 0/Path Cost	54
WAN Port 0/Priority	54
Spanning Tree/WAN Port 1	54
WAN Port 1/Active.....	55
WAN Port 1/Path Cost	55
WAN Port 1/Priority.....	55
Bridge/Address Table.....	55
Address Table/Aging.....	55
Address Table/Forward Policy.....	55
Configuration/Security	56
Security/Authentication	56
Security/When.....	57
Security/Radius Server.....	57
Radius Server/Primary Server.....	57
Radius Server/Secondary Server.....	57
Radius Server/UDP Port.....	57
Radius Server/Secret	57
Radius Server/Retry Count	58
Security/PPP	58
Security/Filter Defines.....	59
Filter Defines /MAC Filter Defines	59
Filter Defines /Pattern Filter Defines	60
Filter Defines /IP Filter Defines	60
Filter Defines /IPX Filter Defines.....	61
Configuration/Connection List.....	63
Connection List/Description.....	64
Connection List/Active.....	64
Connection List/Authentication.....	64
Authentication/Tx Method	65
Authentication/Tx Username	66
Authentication/Tx Password.....	66
Authentication/Rx Username.....	66
Authentication/Rx Password.....	66
Authentication/Caller ID.....	66
Authentication/Call ID 1	67
Authentication/Call ID 2	67

Connection List/IP	67
IP/Mode	67
IP/NAT	67
IP/Route	67
Route/IP/Net	68
Route/Netmask	68
Route/Static Route	68
Route/Private	68
Route/Hops	68
Route/Force IP	68
IP/RIP	69
RIP/Mode	69
RIP/Protocol	69
RIP/Method	69
RIP/Direction	69
RIP/Triggered	69
RIP/Retain	70
Connection List/IPX	70
IPX/Mode	70
IPX/Remote Network	70
IPX/Triggered	70
IPX/Retain	71
IPX/Type 20 Packets	71
Connection List/Bridge	72
Bridge/Mode	72
Connection List/Probe	72
Probe/Active	72
Probe/Interval	72
Probe/Update Window	73
Connection List/PPP	73
PPP/Multilink	73
Multilink/Mode	73
Multilink/Fragment	73
Multilink/BACP	73
PPP/Compression	74
PPP/VJ Compression	74
PPP/Max Config	74
PPP/Max Timer	74
PPP/Max Failure	75
Connection List/Dial Out	75
Dial Out/Number 1	75
Dial Out/Number 2	75
Dial Out/Call Type	75
Dial Out/Redial at 56K	76
Dial Out/Delay	76
Dial Out/Connection Timeout	76
Dial Out/Attempts	76
Dial Out/Initial Channels	77

Table of Contents

Connection List/Bandwidth	77
Bandwidth/On Demand	77
Bandwidth/Mode	77
Bandwidth/Idle Timeout.....	77
Bandwidth/Preempt Time	77
Bandwidth/Upper Threshold.....	78
Bandwidth/Lower Threshold.....	78
Bandwidth/Min Channels	78
Bandwidth/Max Channels.....	78
Bandwidth/Samples.....	78
Samples/Sample Rate	78
Samples/Samples.....	78
Samples/Time Between Changes.....	79
Connection List/Filters	79
Filters/WAN-to-LAN (In).....	79
Filters/In Exceptions.....	80
Filters/LAN-to-WAN (Out)	80
Filters/Out Exceptions	81
Filters/Demand Dial.....	81
Filters/Dem Dial Exceptions	82
Configuration/Management	83
Management/Telnet.....	83
Telnet/Server Access	83
Telnet/User List.....	84
User List/Name.....	84
User List/Authen Method.....	84
User List/Password	84
User List/Idle Time	84
User List/Level.....	84
Management/SNMP	85
SNMP Access	85
SNMP/Communities.....	85
Communities/Name	85
Communities/Privilege	85
Communities/Manager IP.....	85
SNMP/Traps.....	85
Traps/Manager Name	86
Traps/Manager IP	86
Management/Maint Port.....	86
Maint Port/Password Protect.....	86
Maint Port/Password	86
Maint Port/Baud Rate	86
Maint Port/Data Bits	86
Maint Port/Parity.....	87
Maint Port/Stop Bits.....	87
Configuration/Terminal Mode	87

Dial Menu.....	88
Dial/Description.....	88
Dial/Dial.....	88
Dial/Hang Up.....	89
Dial/Status	89
Dial/Channels.....	89
Dial/Number 1	89
Dial/Number 2	89
Status Menu	90
Status/Call Sessions.....	90
Call Sessions/Session1 and Call Sessions/Session2.....	91
Call Sessions/Spanning Tree	92
Status/ARP Cache.....	92
Status/Bridge Table	93
Status/IP Routes.....	93
Status/IPX Routes	94
Status/IPX Servers	95
Status/WAN Stats	95
Status/LAN Stats	96
Status/IP Stats.....	96
Test Menu.....	98
Test Menu/Echo Request.....	98
Test Menu/Dial Self.....	98
Logs Menu.....	99
Logs/Sys log Host.....	99
Logs/PPP Log.....	99
PPP Log/Active	100
PPP Log/Wrap.....	100
PPP Log/Level.....	100
PPP Log/View	100
PPP Log/Clear	100
Logs/Call Log.....	100
Call Log/Active	100
Call Log/Wrap.....	101
Call Log/Level.....	101
Call Log/View.....	101
Call Log/Clear	101
Logs/Network Log.....	101
Network Log/Active.....	101
Network Log/Wrap	101
Network Log/Level	102
Network Log/View.....	102
Network Log/Clear.....	102
Utilities Menu	103
Utilities/Ping	103
Utilities/Telnet Client.....	104
Utilities/Upgrade Menu	104
Upgrade/Transfer Method	104

Table of Contents

Upgrade/TFTP Host	104
Upgrade/Filename	104
Upgrade/Status.....	104
Upgrade/Start Transfer	105
Upgrade/Abort Transfer	105
Upgrade/TFTP Server.....	105
Utilities/Exit.....	105
Chapter 4. Troubleshooting.....	107
If Self Test Fails	107
If the Express XL/XLT Does Not Read Ready	107
If You are Unable to Connect Calls.....	113
Chapter 5. Specifications	115
Specifications and Features.....	115
Network Interface.....	115
Ethernet Interface (LAN).....	115
Switch Compatibility	115
POTS Interface	115
Display	116
Environmental	116
Physical	116
Power.....	116
Appendix A. Loop Status Messages	117
Appendix B. Log Messages.....	121
Appendix C. SNMP.....	139
Appendix D. Connector Pinouts	143
Appendix E. Terminal Mode Commands.....	145
Glossary.....	149
Acronyms	159
Index	161

List of Figures

Figure 1-1:	Express XL/XLT	7
Figure 1-2:	Single User to Corporate LAN	8
Figure 1-3:	Single User to Internet Service Provider	9
Figure 1-4:	Multiple User to Internet Service Provider.....	10
Figure 1-5:	SOHO to Corporate LAN.....	11
Figure 1-6:	Express XL/XLT LEDs	17
Figure 1-7:	Express XL/XLT Rear Panels	18
Figure 2-1:	Wiring Scheme 1	24
Figure 2-2:	Wiring Scheme 2.....	25
Figure 3-1:	Top Level Terminal Menu.....	28
Figure 3-2:	Configuration/System Info Screen.....	34
Figure 3-3:	Configuration/WAN Screen	36
Figure 3-4:	Configuration/IP Screen	40
Figure 3-5:	Configuration/IPX Screen	47
Figure 3-6:	Configuration/Bridge Screen	50
Figure 3-7:	Configuration/Security Screen	56
Figure 3-8:	Configuration/Connection List Screen.....	63
Figure 3-9:	Configuration/Management Screen.....	83
Figure 3-10:	Dial Screen.....	88
Figure 3-11:	Status Screen.....	90
Figure 3-12:	Test Screen	98
Figure 3-13:	Logs Screen.....	99
Figure 3-14:	Utilities Screen	103

List of Figures

List of Tables

Table 2-A:	Using the Flash-Hook	22
Table 4-A:	Troubleshooting Calls.....	113
Table D-A:	IBM/AT Style EIA-232 Interface	143
Table D-B:	RJ-45 ISDN BRI U	143
Table D-C:	RJ-11 POTS.....	144
Table D-D:	10BaseT Ethernet	144

List of Tables

Quick Startup Guide

SETTING UP THE ISDN LINE

Before configuring the Express XL/XLT, ensure that the telephone service has provided the switch type, service profile identification (SPID), and local directory number (LDN).

Example:	Switch Type	National ISDN-1
	SPID1	20555512120100
	SPID2	20555512130100
	LDN1	5551212
	LDN2	5551213

1. Connect a VT 100 async terminal, or personal computer with a terminal emulator running 9600 N-8-1, to the **MAINTENANCE** port.
2. Hold down the **Control** key and press **R**; then press **Enter** to display the top menu.
3. Using the arrow keys and **Enter** key to navigate the menu, go to the **Configuration/WAN/ISDN/Dial Line** menu. Enter the SPIDs, LDNs, and switch type.
4. Use the left arrow key or the **Escape** key to go back up the menu tree. When asked to save ISDN parameters, type **y**.
5. Connect the ISDN line to the RJ-45 jack labeled **ISDN BRI U** on the rear panel.
6. When the Loop LED remains solid, the Express XL/XLT is ready for calling.
7. If using a POTS Phone with the Express XLT, connect the POTS telephone to the POTS port.



NOTE

*If the SPID(s) does not work or is unknown, try activating the ExpertISDN™ feature. First enter the area code and local directory number(s); then press the **Enter** key over the ExpertISDN activator.*

CONNECTING TO AN INTERNET SERVICE PROVIDER

Internet Access using Network Address Translation (NAT)

1. Connect the 10BaseT cable from the PC's network card to the Express XL/XLT. Select **TO NIC** on the Express XL/XLT back panel.
2. Go to the **Configuration/Connection List** menu, and then press the right arrow key to place the cursor on the **Num** column.
3. Type **I** to insert a new Connection List entry.
4. Using the arrow keys, move the cursor over the **Num** column for the inserted entry. Press **Enter** to place the subentries into the right pane.
5. Set the **Description** to an identifiable name (i.e., ISP).
6. Go into the **Authentication** field and select **PAP** or **CHAP** for the **Tx Method**.
7. Enter your user name and password (provided by your ISP) into the **Tx Username** and **Tx Password** fields.
8. Move the cursor to the left pane and highlight the IP parameters.
9. Set the **NAT** item to **Yes**. This is a very important step. The Express XL/XLT will need to translate the "fake" IP address(es) on the PC(s) to the "real" address provided dynamically by the ISP. See *IP/NAT* on page 43 for more details.
10. All other IP parameters should be left at their default settings. Navigate over to the **Dial Out** parameters.
11. Enter the number into **Number 1**. If configured for two B-channel (PPP Multilink) by the ISP, enter **Number 2** if it exists and set **Initial Channels** to **2**.
12. Arrow left until the message **Save Connection List Changes** appears. Type **y** to save.
13. Go to the **Configuration/IP** menu and enter an IP address and net mask into the **IP Address** and **Subnet Mask** fields. The factory default setting will work just as well (10.0.0.1, 255.255.255.0).
14. Go into the **Configuration/IP/NAT** submenu and set **DHCP Mode** to **On**.
15. Arrow left to save the configuration.
16. Go into the **Dial** menu.
17. Set the cursor over the **Dial** parameter for the Connection List profile you just set up.
18. Press **Enter**; the Express XL/XLT will start dialing.

19. If the call is successful, the **Status** column will read **active**. If not, make sure the number(s) are correct or reference *Chapter 4* on page 107 (the troubleshooting chapter) before going on to the next step.
20. Once the call is up, the PC must generate a DHCP request to obtain the IP parameters needed to get on the Internet. Refer to your PC's user manual or help screen.

MULTIPROTOCOL ROUTING BETWEEN TWO LANS

Remote/Home Office Accessing the Corporate LAN

The following steps can be used to set up the Express XL/XLT on a remote LAN to access a corporate or central LAN using demand dial and dynamic bandwidth management.

1. Connect the 10BaseT cable from the hub to the Express XL/XLT. Select **TO HUB** on the Express XL/XLT back panel. The **LI** indicator should be illuminated.
2. Set the **IP address** and **Subnet Mask** assigned by the network administrator in the **Configuration/IP** menu.
3. For the **Default Gateway**, enter the IP address of the access server at the remote site. This creates a default route in the IP routing table that will be used with the dial-on-demand feature in the Express XL/XLT.
4. Use the arrow keys to get to the **Configuration/IPX** menu. Set the **Network value** to the IPX network supplied by the network administrator. Set the **Seed Status** to **Seed**. Arrow left and save the changes with a **y** when prompted.
5. Move to the **Configuration/Connection List**. Use the arrow keys to move the cursor over the **Num** column. Type **I** to insert a new entry.
6. Move the cursor over the **Description** field and press **Enter**. A pop up window appears in which to enter a name for this Connection List profile.
7. Move the cursor over the **Authentication** menu and press **Return**. This will place the authentication parameters into the right pane.
8. Enter the username and password under **Tx Username** and **Tx Password**. These items should be provided by the administrator at the site being dialed.
9. Use the down arrow to display the **IP** menu parameters in the right pane.
10. Move the cursor over the **Route** menu and press **Return**.

11. Enter the **IP address** and **Netmask** parameters of the access server at the remote site. This creates a static route to the access server's network which is entered into the Express XL/XLT's IP route table.
12. Move the cursor over the **RIP** menu. Check with the network administrator for the type of routing protocol used. The Express XL/XLT supports RIP versions 1 and 2. The protocol is set in the **Protocol** parameter.
13. Select **Yes** for the **Triggered** parameter. This will prevent periodic RIP updates that keep the ISDN link from going "idle."
14. Select **Yes** for the **Retain** parameter. This will allow the routes learned from the access server to be saved in the IP routing table. Access to any of those networks from the workstation will cause this profile to be dialed.
15. Use the left arrow to get back to the previous menu. Use the down arrow to view the **IPX** menu parameters in the right pane.
16. This is similar to steps 13 and 14. Select **Yes** for **Triggered** and **Yes** for **Retain**. This will allow the ISDN link to go to an idle state and permit the Express XL/XLT to "spoof" the server information obtained from the access server. A similar configuration must be selected on the access server.
17. Use the arrows to get the **Dial Out** menu parameters for this profile.
18. Enter the phone number of the access server in **Number 1**. If configured by the administrator to use two B-channels using Multilink PPP, set the **Initial Channels** field to **2**. Some PPP protocols, if they exist in the access server, will allow the second channel to come into play only if the bandwidth is needed. If this is the case, the Express XL/XLT will automatically negotiate this with the access server.
19. Now move to the **Bandwidth** menu for this profile. Once there, use the right arrow to move to the **On Demand** submenu.
20. Set the **Mode** parameter to **On**. This enables the dynamic bandwidth features of the Express XL/XLT.
21. Select the **Idle Timeout** parameter and enter the number of seconds the Express XL/XLT should wait before hanging up the connection when no traffic is present. A value of 120 seconds is typical. A value of 0 means never idle the link.
22. All the parameters for this Connection List profile are complete. To save them, press the left arrow to get to the top (main) menu; when prompted **Save Connection List changes?** enter **y**.
23. Set up the computer workstation's IP and IPX parameters as instructed by the network administrator. The Express XL/XLT's IP address should be the computer's default gateway.

When the computer which is attached to the local LAN attempts to access a host on the access server, the Express XL/XLT will dial the number provided in the Connection List profile. The Express XL/XLT will provide one of two B-channels based on traffic demand and POTS port usage (Express XLT model only). If no packet traffic is transmitted or received for the specified number of seconds, the Express XL/XLT will disconnect the link until a computer on the local LAN again attempts to access a host on the access server.

If Novell's IPX protocol is being used, the link must be dialed first in the **Dial** menu to obtain the server and route information needed by the computer to boot up. Advanced users can use the Express XL/XLT's Probe feature to periodically dial the access server to obtain the route and server information, thereby removing the need to manually dial the first time.

Chapter 1

Understanding ISDN and the Express XL/XLT

ISDN OVERVIEW

The Integrated Services Digital Network (ISDN) is a public or private switched digital network. ISDN is an international standard for digital communications, allowing a full range of enhanced services supporting voice, data, and image applications through standard interfaces over a single telephone wire. ISDN provides a means of integrating these services and modernizing communication networks for information movement and management efficiency.

THE EXPRESS XL/XLT

The Express XL/XLT is a standalone device that links two Local Area Networks (LANs) using a high-speed ISDN public network or leased two-wire line. Optionally, the Express XLT has a plain old telephone service (POTS) connector that is used for voice/modem applications

See Figure 1-1 for an illustration of the Express XL/XLT. The 10BaseT connector operates at 10 megabits per second half duplex and accepts standard ethernet packets encapsulated using IEEE 802.3 or Ethernet II (DIX). Because the 10BaseT is a four-wire interface, a crossover switch permits the user to connect to either a hub-concentrator or network interface card without the need for special cabling. The maintenance port can connect to any asynchronous terminal emulating a VT 100 terminal for configuration.

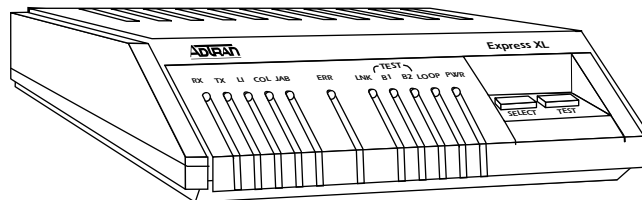

Figure 1-1
Express XL/XLT

Applications

Single User to Corporate LAN

- Telecommuter/Home Office Access to the corporate LAN
- Single device access
- User Datagram Protocol (UDP) broadcasts are “relayed” to corporate LAN.
- Client device can obtain the Internet Protocol (IP) address dynamically using Dynamic Host Configuration Protocol (DHCP).
- Compatible with popular central site LAN access devices

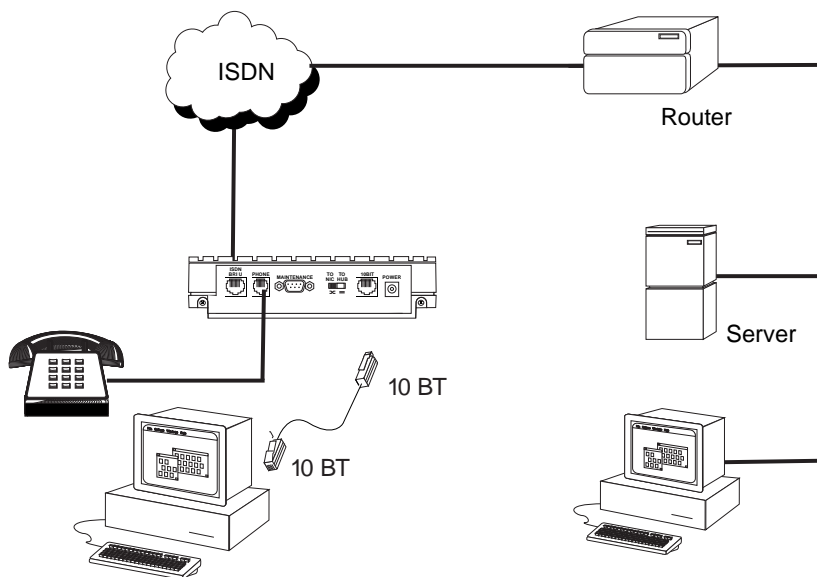

Figure 1-2
Single User to Corporate LAN

Single User IP to Internet Service Provider (ISP) using Network Address Translation (NAT)

- Provides high speed home access to the Internet
- NAT provides translation from user assigned IP addresses to ISP assigned IP addresses.
- The PC's IP address can be dynamically assigned by the Express XL/XLT.
- Overcomes the serial port speed limitations of current terminal adapter solutions
- Multilink Point-to-Point Protocol (PPP) plus compression yields effective throughput greater than 256 kbps.
- Compatible with popular ISP access devices

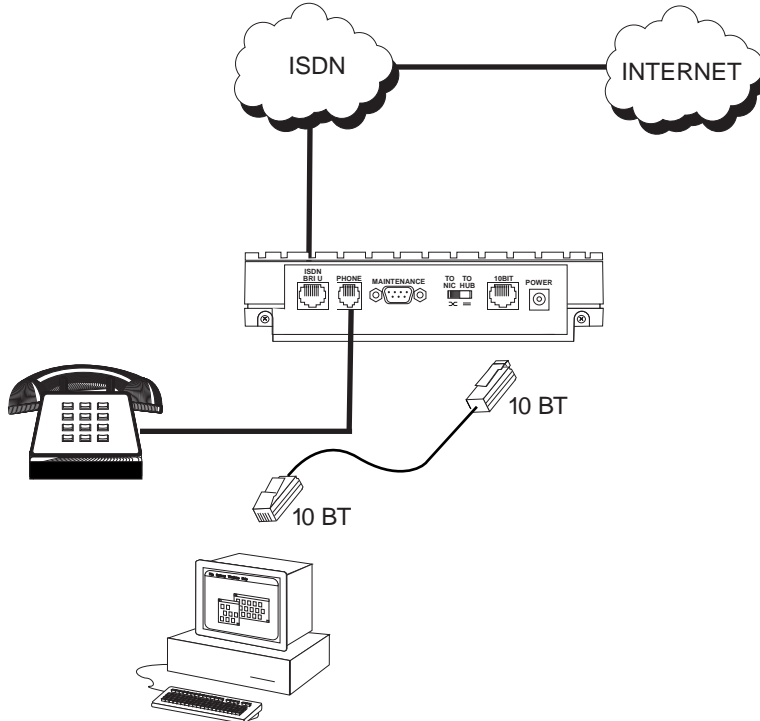

Figure 1-3
Single User to Internet Service Provider

Multiple Users to Internet Service Provider (ISP) using NAT

- Provides high speed home access to the Internet
- Multiple and simultaneous access
- The PC's IP address can be dynamically assigned by the Express XL/XLT.
- On-demand Internet access
- Multilink PPP plus compression yields effective throughput greater than 256 kbps.
- Compatible with popular ISP access devices

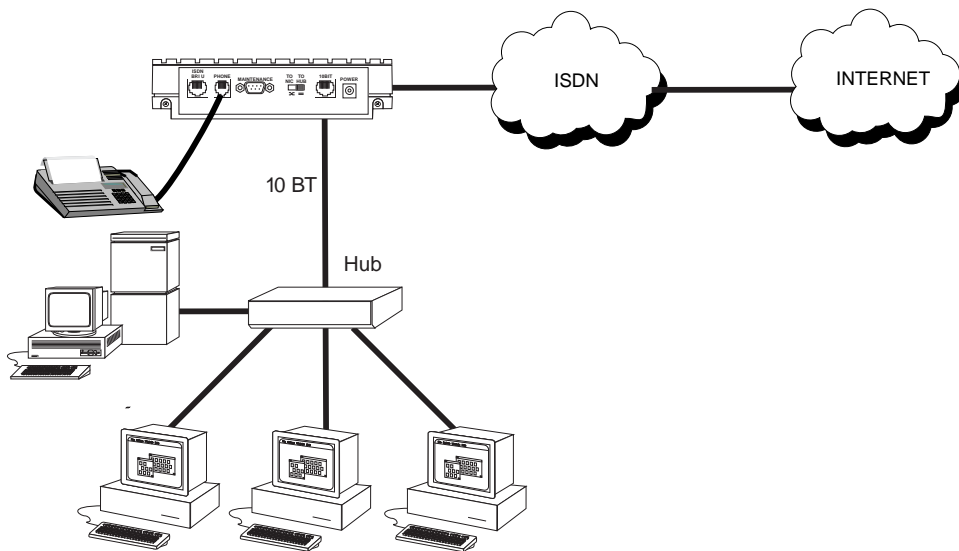

Figure 1-4
Multiple User to Internet Service Provider

Small Office - Home Office (SOHO) to Corporate LAN

- Connects the small office or home office to the corporate LAN
- Routes IP and Internet Packet Exchange (IPX) traffic from multiple devices to the corporate LAN
- Bridges all non-routed traffic (e.g., AppleTalk)
- Provides dedicated or on-demand services
- Low cost alternative to buying a high-end router
- Compatible with popular central site LAN access devices

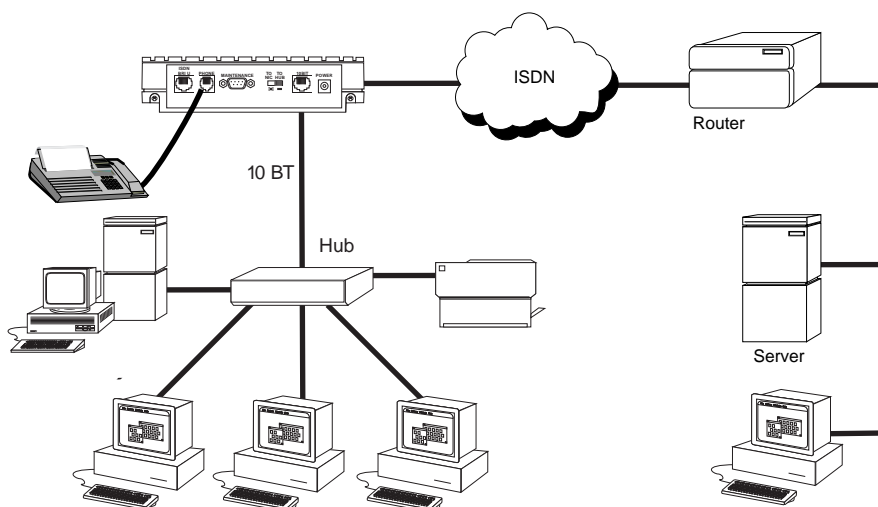

Figure 1-5
SOHO to Corporate LAN

The Express XL/XLT provides the following basic functions:

1. **LAN Bridge:** Bridging provides a point-to-point connection between two LANs. The bridge learning function scans the source and destination media access control (MAC) addresses of all packets on its local LAN and determines which packets should be transmitted over the ISDN link. Applications include connectivity between single user or small offices to corporate LANs. The Express XL/XLT uses the Spanning Tree Algorithm (IEEE 802.1d-ISO/IEC10038), which provides a loop-free topology and redundancy.

2. **IP Router:** The Express XL/XLT can function as an IP router using the Routing Information Protocol (RIP) for advertising and learning routes among other routers. Static routes may also be entered into the routing table.
3. **IPX Router:** IPX routers and services can be exchanged between the Express XL/XLT and other devices using RIP and Service Advertising Protocol (SAP). Watch dog serialization filtering and spoofing can permit the ISDN to be idle during no application traffic periods.
4. **Network Address Translation (NAT):** Single networks can connect to the Internet with this function. The Express XL/XLT translates outgoing IP packets over the ISDN to the IP router at the Internet Service Provider. Popular Internet applications are supported.
5. **POTS:** The POTS interface can be used for interfacing to dual tone multi-frequency (DTMF) analog devices such as telephones, modems, fax machines, etc. The Express XLT POTS option is available on part number 1200070L2 only.

Demand Routing and Bridging with the Express XL/XLT

The Express XL/XLT is a dial-up ISDN IP Router and Transparent Learning Bridge that provides Dial-On-Demand and Dynamic Bandwidth Management. Its features can be easily configured and used once several basic concepts are understood.

Factory Default

The Express XL/XLT comes from the factory configured for MAC Bridging, IP routing and IPX routing with no filters or connection information defined. An IP address of 10.0.0.1 with a network mask of 255.255.255.0 is preloaded. Dynamic Bandwidth Management features are disabled. Although dynamic assignment of a B-channel for the analog (POTS) port on the Express XLT model is always available, link idle time-out and adding/removing of B-channels based on traffic is initially disabled.

Bridging

In Bridge Mode, the Express XL/XLT can communicate with two remote networks at a time. The destination is dialed by setting up a Connection List profile and choosing **Dial** on the Dial menu. See *Configuration/Connection List* on page 63 for instructions on setting up a Connection List profile.

During a two B-channel PPP Multilink call, the Express XLT automatically drops one B-channel and provides it to the POTS port when a telephone call is placed or answered. When a POTS telephone call terminates, the Express XL redials the second B-channel and supplies the bandwidth back to the LAN connection. Since other bandwidth management features are disabled in the factory default configuration, the dialed links remain active until the **Hang-up** command is entered from the Dial menu, terminating the session with the selected remote network.

The Connection List described in the next section may be used to automate dialing and to store additional information specific to the remote site being dialed (phone numbers, number of B-channels to dial, authentication information, Caller ID, etc.). In addition, Demand Dialing may be enabled to allow idle links to disconnect when not being used to reduce line charges.

Simple Demand Bridging may be configured by enabling the Idle Time-Out parameter under the **Configuration/ Connection List [1]/Bandwidth/On Demand** option on the Connection List. Setting this parameter to a non-zero value allows a bridge connection to disconnect after the specified number of seconds with no traffic crossing the ISDN link. Bandwidth can be controlled using the Express XL/XLT's advanced filtering capability. When new traffic needs to be transmitted, the Express XL/XLT will run each packet through its Demand filters defined for each Connection List profile. If a packet can pass through the filter, then the numbers for that profile are dialed. In addition, when both B-channels are selected for use, the link may be configured to add/remove the second B-channel based on the amount of traffic crossing the link. The bridged connection is terminated when the **Hang-up** option is selected from the Dial menu, but will redial if the demand filter condition is met.

IP Routing

The Express XL/XLT operates as a dial-up IP router when the **Configuration/IP/IP Router/Mode** option is configured to **On**. The Express XL/XLT uses an IP unnumbered WAN interface; the IP address and mask assigned to the unit's LAN interface apply to all routing and IP operations for the unit. If a default gateway is specified on the network of the Ethernet interface, the unit attempts to reach the gateway through that interface. If the gateway is specified on an unknown network, the unknown network is assigned to the router table and remains unused until that gateway becomes the peer on a WAN connection. If no default gateway is specified, the first connected peer on the WAN interface becomes the default gateway (recommended for remote applications when there are no other routers on the remote LAN).

For each profile in the Connection List that includes an IP address and has the **Configuration/Connection List/IP/Route/Static Route** option set to **Yes**, the Network Address of the specified IP address is added to the router table with the Host Address as the gateway. If the **Configuration/Connection List/IP/Route/Private** option is set to **No**, the route is advertised at the specified metric through the unit's interfaces as if a connection is active to that network. These routes are referred to as *spoofed routes*.

Attempts by any computer connected to the LAN interface to access a host on a spoofed network causes a connection to be attempted using the information from that Connection List profile. Once connected, routes advertised by the peer router are learned and advertised to the local LAN. If Bandwidth-On-Demand is enabled and an Idle Time-out value is specified, expiration of the Idle Timer causes the link to be disconnected; the routes learned from the peer router are retained if the **Configuration/Connection List/IP/RIP/Retain** option is set to **Yes** and advertised as if the connection is still active. These routes are referred to as *retained routes*. Attempts by any connected computer to access a host on any of the retained routes causes the link to be redialed. If **Hang Up** is activated from the Dial menu when the link is down, the retained routes are removed.

The Express XL/XLT can be connected to two WAN destinations at the same time. Each B-channel is dialed to a different location. Routes learned from one WAN destination are advertised to the other using RIP.

IPX Routing

Like IP routing, the Express XL/XLT can connect to two different sites and exchange IPX packets. Network routes and services are learned and advertised using Novell's RIP and SAP. Routes and services learned from a separate site can be retained in the Express XL/XLT when the connection goes idle. While retained, the Express XL/XLT can spoof RIP/SAP and watch-dog and filter serialization packets that would normally be required between the Novell server and client.

Connection List - Simplifying and Enhancing the Dial Function

The Connection List, which is accessed from the Configuration menu, provides a location to define information regarding 15 individual destinations that may be dialed. A Connection List entry is required for each destination since authentication information (method, username, password), number of B-channels, telephone numbers, Caller ID, IP, or IPX address (for routed connections), and other information can be stored for each destination defined. Defined destinations may be dialed by selecting the **Dial** activator in the Dial menu or by demand for the desired Connection List profile.

Concurrent Routing And Bridging

The Express XL/XLT can route IP and IPX as well as bridge non-IP/IPX packets simultaneously. The Connection List profile will by default negotiate PPP network protocols to support the transmission and reception of IP, IPX, and Bridge packets. If the PPP peer does not accept a protocol, the Express XL/XLT will fall back to any combination of routing and bridging.

Routing over PPP Bridging

The Express XL/XLT can support legacy equipment which does not support PPP IP (IPCP) or IPX (IPXCP) protocols by allowing routing packets over the WAN connection using PPP Bridging (BCP). To perform this, the Express XL/XLT uses a "virtual" ethernet port. This port is set up under the **Configuration/Bridge** menu.

Network Address Translation Mode

NAT is a special mode of operation in which the Express XL/XLT obtains a dynamically assigned IP address from the peer router (typically an Internet Service Provider). This allows a network of computers to benefit from Ethernet to ISDN speeds while still appearing to the Internet Service Provider (or central site router) as a single IP address which is typical of PC based serial dial-up solutions.

A call is initiated to the ISP using the Dial menu or demand for a Connection List profile that has the IP parameter **NAT** set to **Yes**. The network computer's IP stack may use DHCP to request an IP address, default gateway address, and domain name server addresses from the Express XL/XLT.

Front Panel

Figure 1-6 on page 17 shows the front panel of the Express XL/XLT. The indicators are divided into LAN functions, WAN functions, and Test functions.

LAN Indicators

RX	Flashes when receiving data from the 10BaseT connector.
TX	Flashes when transmitting data onto the 10BaseT connector.
LI	Link integrity. Illuminates when there is a good connection between the Express XL/XLT and the Hub/NIC card.
COL	Illuminates when a collision occurs on the 10BaseT.
JAB	Indicates a jabber condition on the 10BaseT.

WAN Indicators

LNK	Flashes when the link is being negotiated; solid when the link is active.
B1	Flashes when a call on the B1 channel is in progress; solid when a call is connected.
B2	Flashes when a call on the B2 channel is in progress; solid when a call is connected.
Loop	Indicates ISDN layers status. Indicator is off when layer 1 is down. A fast flash indicates layer 1 is up and layer 2 is down. A slow flash indicates layer 2 is up and layer 3 is down. A solid illumination indicates all layers are up.
PWR	Flashes when self-test has failed; solid when unit is powered on and self-test has passed.

Test Indicators

ERR	Illuminates when self-test or front panel test has failed.
B1/B2	Indicates test selected by front panel buttons.

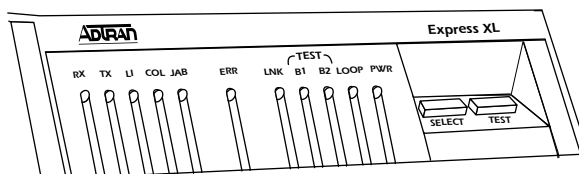

Figure 1-6
Express XL/XLT LEDs

Pushbutton Tests

The echo request test can be executed by pressing the **SELECT** button one time and pressing **TEST**. A ping test is executed by pressing the **SELECT** button twice and pressing **TEST**. The IP address pinged comes from the previously pinged address set in the menu. If it is blank, the default gateway is used. If the default gateway is blank, an error is indicated. The **ERR** indicator illuminates if any pings are not returned. The dial self-test is invoked from the front panel if the **SELECT** button is pressed three times. The LDN(s) must be already programmed for this test to work.

ISDN Connection

From the network, ISDN is delivered by a single 2-wire 2B1Q U-interface which is connected directly to the Express XL/XLT. ISDN network termination is designed into the Express XL/XLT, eliminating the need and expense of a separate NT1. For network testing, the Express XL/XLT responds to NT1 test commands from the telephone company central office (CO).

The Express XL/XLT has one RJ-45 jack, labeled **ISDN BRI U** on the rear panel for network connection (see Figure 1-7). ISDN basic rate service divides a standard telephone line into three digital channels capable of simultaneous voice and data transmission. The three channels are comprised of two bearer (B) channels at 64 kbps and one data (D) channel at 16 kbps, known as 2B+D.

The Express XL/XLT also supports a leased digital connection allowing data to be transferred at up to 144 kbps over a 2-wire facility using the same RJ-45 jack. This type of service is a permanent connection between endpoints and is sometimes referred to as a leased connection, a dedicated connection, a nailed-up connection, or a private circuit. Leased connection or leased line is used in this manual to represent these types of services.

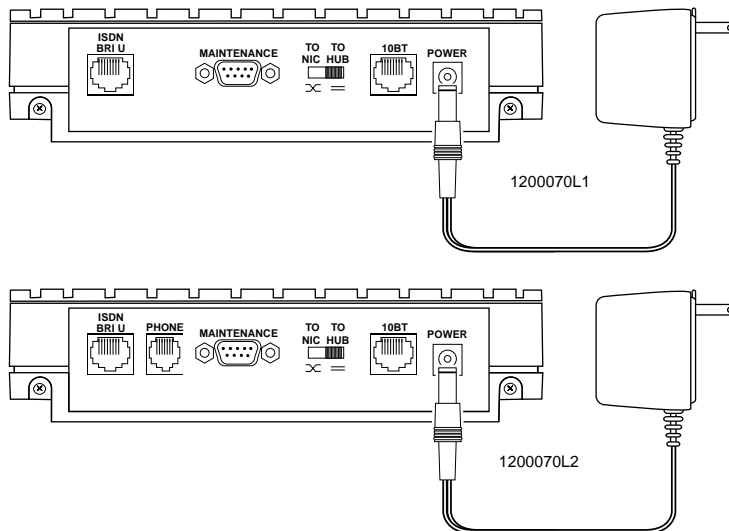

Figure 1-7
Express XL/XLT Rear Panels

Ordering ISDN

When ordering ISDN from the telephone company, request **EZ-ISDN 1** (Capability Package U) to ensure it is set up properly. EZ-ISDN 1 is recommended by the industry for most home office/small business applications. If this is not available from your service provider or you would like more information regarding ordering ISDN, see the ADTRAN document *Ordering ISDN Service User Guide* part number 60000.015-8 or contact your telephone company for alternative line configurations. The *Ordering ISDN Service User Guide* is available on the ADTRAN home page at <http://www.adtran.com> or by calling ADTRAN.

Interoperability

The Express XL/XLT is standards based and uses PPP developed by Internet Engineering Task Force (IETF). PPP provides a standard method of transporting multi-protocol datagrams over point-to-point links. PPP is widely accepted by many ISDN bridge/router manufacturers. The Express XL/XLT will negotiate Multilink PPP when connecting both B-channels. The Bandwidth Allocation Protocol (BAP) may also negotiate, which enhances the management of adding and removing a B-channel. Data compression is also supported using LZS[®] technology from hi/fn[™].

Connecting to the Internet

Internet Service Providers (ISPs) assign an IP address to use when connected to their service using PPP negotiation. This assignment is based on the assumption that the user has an ISDN terminal adapter running PPP async-to-sync conversion or another rate adaption where the PPP negotiation is terminated inside the PCs IP stack. However, if an ISDN-ethernet gateway device is used, the ISP must preassign the customer a subnet which uses multiple IP addresses. This may result in a much higher cost to the user.

The Express XL/XLT permits the user to assign any IP addresses to the unit and computers. Operations on the network can occur normally. In fact, one B-channel can connect to the ISP using NAT while the other B-channel connects to another “private” or “fake” network. All packets transmitted or received over the ISP connection are translated. The Express XL/XLT keeps track of the computers that request services over the Internet. A web server address can

be assigned under the **Configuration/IP/NAT** menu that allows incoming HTTP, FTP, and mail server requests from the Internet to be translated and forwarded to this address on the user network.

Configuration

The Express XL/XLT is configured using a menu-based interface. This interface can be accessed via the maintenance port using any asynchronous VT100 terminal or personal computer running a terminal emulation program, or via the LAN using a Telnet client program. To use the Telnet interface, the Express XL/XLT must first have an IP address programmed into it via the maintenance port. The factory default is 10.0.0.1.

Security

Security on network devices is a major concern for almost anyone with a network. The Express XL/XLT provides many tools for securing the local network from hostile users. Incoming calls can be authenticated using passwords and Caller ID. A RADIUS client can also be used.

The Telnet configuration can also be protected using the same authentication methods. Each menu item in the Express XL/XLT has a security level associated with it. A telnet session is assigned a privilege level which determines which menu items are accessible to the telnet client. See *Security Levels* on page 33 (in Chapter 3) for more information on menu security levels.

Filters can be defined to prevent certain addresses or protocols from being transferred from LAN-to-WAN, WAN-to-LAN, or WAN-to-WAN.

Chapter 2

Installation

After unpacking the unit, immediately inspect it for possible shipping damage. If damage is discovered, file a claim immediately with the shipping carrier; then contact the ADTRAN Repair and Return department.

ISDN NETWORK CONNECTION

The Express XL/XLT supports either dial or leased operation. A single RJ-45 modular jack labeled **ISDN BRI U** on the rear panel provides connection to either network service.

Dial operation allows the user to dial out or receive calls over the public network.

The leased operation mode supports dedicated 2B1Q data service at rates up to 144 kbps by using a nailed up circuit, or a permanent connection between end points.

See *Appendix D* on page 143 for ISDN network connector pin assignments.

LOCAL AREA NETWORK CONNECTION

The Express XL/XLT has a 10BaseT connector that provides half-duplex 10 Mbps operation over a four-wire twisted pair. Place the switch in the **TO HUB** position when connecting to a 10BaseT concentrator or Hub. Place the switch in the **TO NIC** position when connecting directly to a computer's 10BaseT network interface card.

Other types of ethernet interfaces (i.e., AUI, 10Base2, etc.) can be accommodated by obtaining an appropriate converter.

TELEPHONE CONNECTION (XLT ONLY)

Basic Telephone Service

The Express XLT supports an analog DTMF telephone type (AT&T 2500) with the POTS interface, part number 1200070L2. The telephone or other analog device (like a fax machine or modem) plugs into an RJ-11 jack labeled **PHONE** located on the rear of the unit. Using a multipoint line allows the POTS and data port to have unique phone numbers.

Supplementary Services

Supplementary services such as call holding, three- or six-way conferencing, call transfer, and call waiting are fully supported by the Express XL/XLT on a touch-tone telephone. Table 2-A explains how the flash-hook is used for handling multi-call situations.

DTMF Keypad

The following functions are performed on a touch-tone phone:

- Disable call waiting: Press ****0**
- Enable call waiting: Press ****1**
- Redial last number: Press ****5**
- Enable ExpertISDN: Press ****6**
- Enter Area Code: Press ****7XXX**
(where XXX is a 3-digit area code.
This must be entered first, before enabling ExpertISDN.)
- Enter Phone Number 1: Press ****8XXXXXXXX**
(where XXXXXXXX is the 7-digit phone number. This must be entered before enabling ExpertISDN.)
- Enter Phone Number 2: Press ****9XXXXXXXX**
(where XXXXXXXX is the 7-digit phone number. If only one phone number is assigned, this does not have to be entered.)

Table 2-A
*Using the Flash-Hook***Calling a second party with an active call.**

Flash-hook to place active call on hold and dial new number. Hanging up will terminate the call.

Answering an incoming call with an active call at call waiting.

Flash-hook to place active call on hold and answer incoming call. Hanging up will terminate both calls.

Conferencing Calls.

With an outgoing call on hold, and a second outgoing call active, flash-hook to conference calls. Hanging up will transfer second call.

With an incoming call on hold, and outgoing call active, flash-hook to conference calls. Hanging up will transfer calls.

With two incoming calls (one on hold and one active) flash hook to conference calls. Hanging up transfers calls.

Answering calls on hold, and holding incoming active calls.

Flash-hook places the incoming call on hold and reconnects to outgoing call. Hanging up will terminate both calls.



*When connecting to a National ISDN 1 switch, call conferencing and call transferring are assigned a unique feature identifier number. This number may not be the same in all areas. The **Configuration/WAN/POTS** menu contains the feature identifier numbers for conference and transfer. If these features do not work, contact your ISDN provider. They can determine the numbers for these features that can then be programmed into the Express XL/XLT.*

Customer Premises Wiring

Customer premises wiring requirements for the Express XL/XLT vary depending on the application and existing wiring. It may be simpler for the ISDN provider to deliver another line to your location. This would eliminate the need to modify existing wiring. Figures 2-1 and 2-2 illustrate two wiring scheme possibilities.

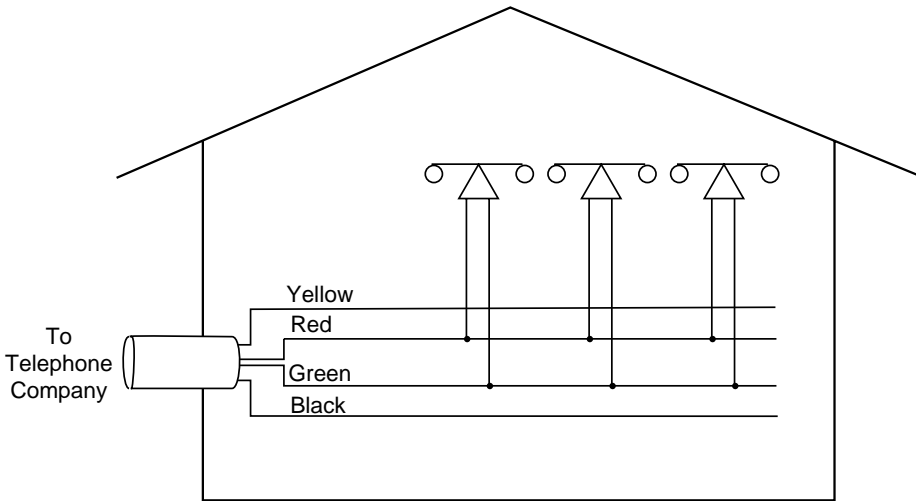

New Wiring Scheme

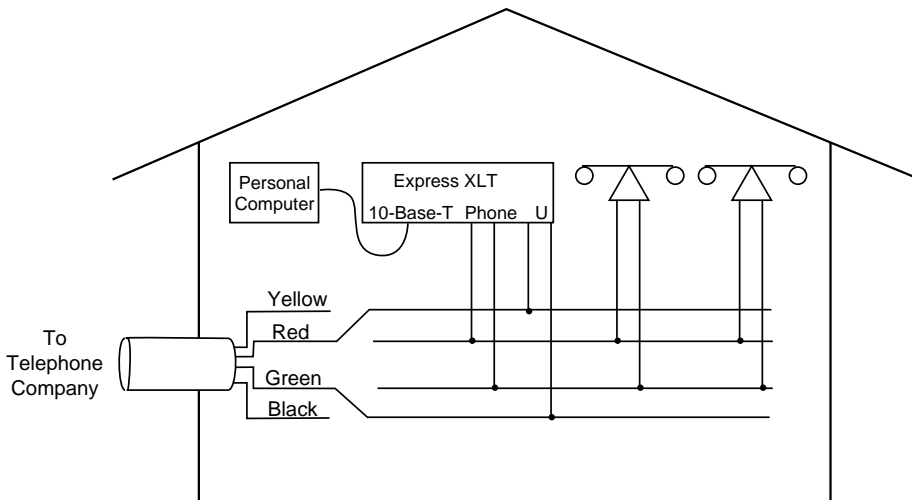
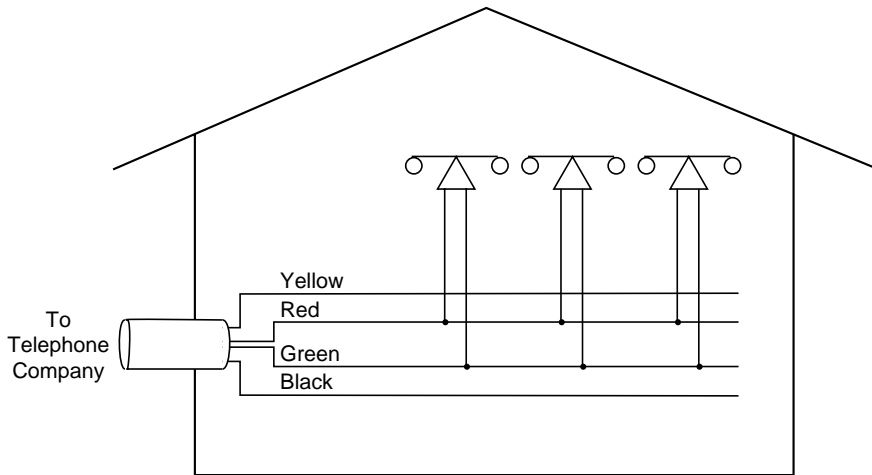

Figure 2-1

*Wiring Scheme 1:
Use existing analog telephone equipment, but replace
single analog telephone service with ISDN service*



New Wiring Scheme

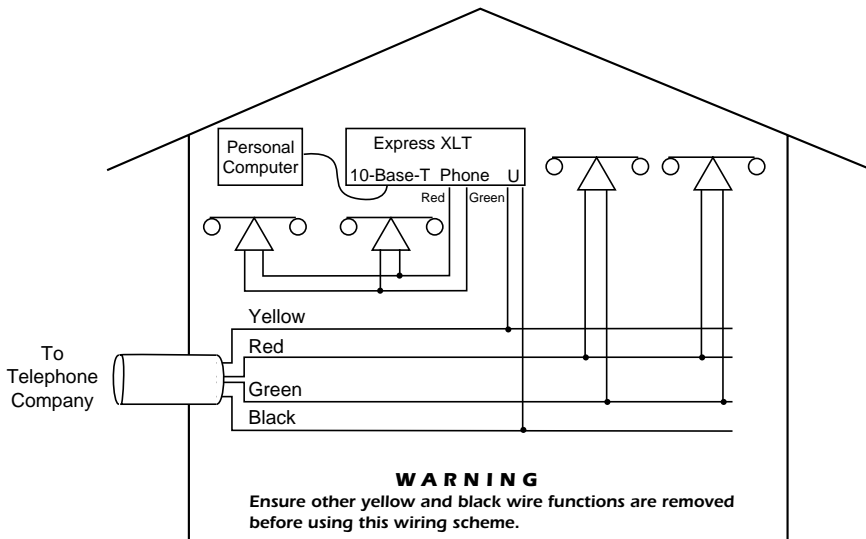

Figure 2-2

*Wiring Scheme 2:
Retain single analog telephone
service and add ISDN service*

Chapter 3

Terminal Menu Operation and Structure

TERMINAL MENU STRUCTURE

The Express XL/XLT uses a multilevel menu structure containing both menu items and data fields. All menu operations and data display in the terminal menu window. The Express XL/XLT is shipped in the Factory Default configuration. Connect any VT 100 or VT 220 type terminal emulator to the maintenance port. The default rate is 9600 baud 8-N-1. The terminal emulator can flow the Express XL/XLT off using software flow control. Hardware flow control is not used.

The opening menu (the Main menu, or top-level menu) is the access point to all other operations. Each Main menu item has several functions and sub-menus to identify and access specific parameters. *Figure 3-1* on page 28 shows the top-level terminal menu.



In order to edit items in the terminal menus, you must have the appropriate security level. Each menu description in this section indicates the required security level required for write access. The maintenance port is always at security level 0, giving full access to all configuration items.

The Main menu contains the following options.

Configuration

The Configuration menu provides options to set up the operational configuration for the Express XL/XLT. See the section *Configuration Menu* on page 34 for detailed information on the available options.

Dial

The Dial menu is used to connect to different sites based on the Connection List. See the section *Dial Menu* on page 88 for more details.

Top Level Terminal Menu
Figure 3-1

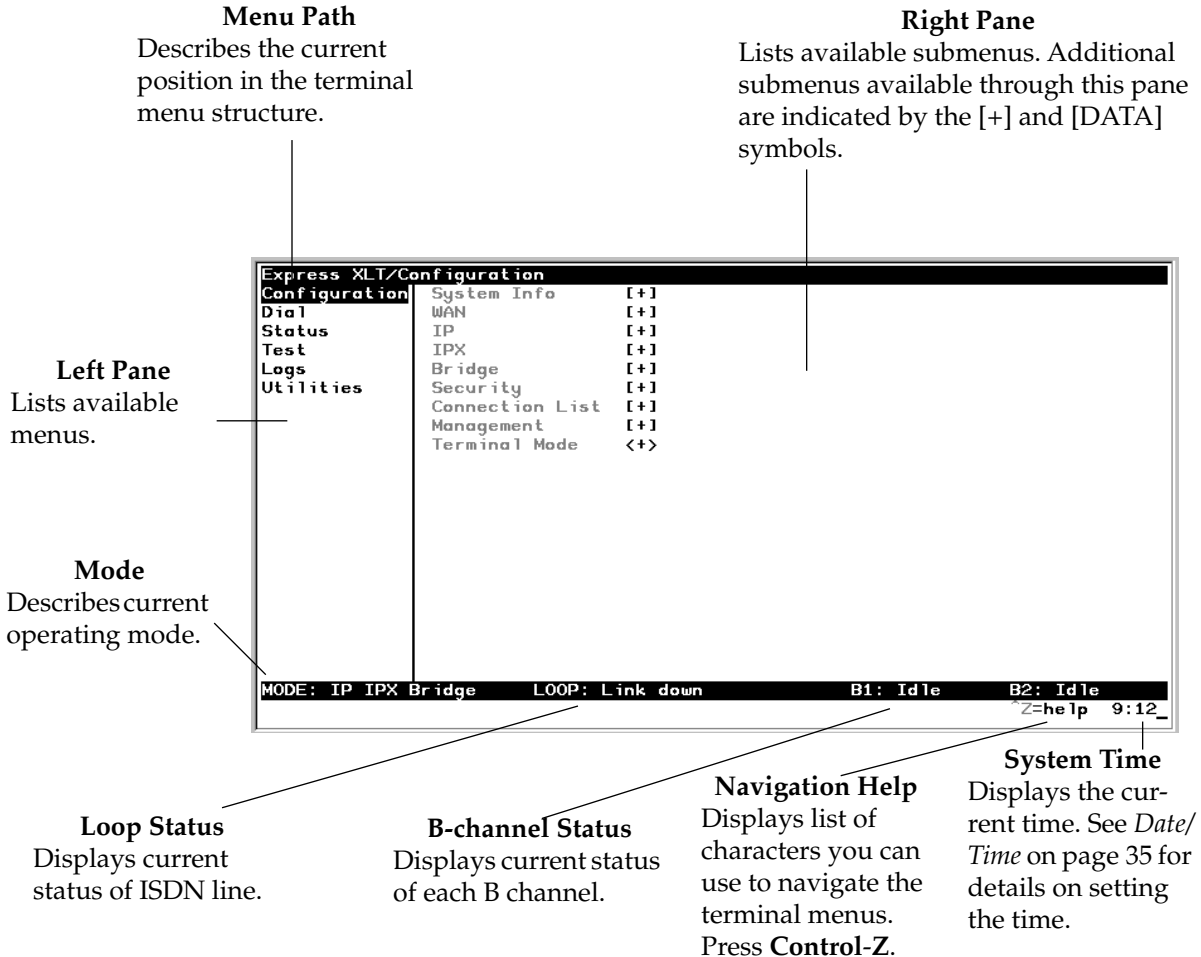

Status

The Status menu provides options to review and monitor the status of the Express XL/XLT system. See the section *Status Menu* on page 90 for detailed information on the available options.

Test

The Test menu can be used for performing diagnostic testing of the Express XL/XLT. See the section *Test Menu* on page 98 for detailed information on the tests available.

Logs

The Logs menu can be used for viewing the operational logs for the Express XL/XLT. See the section *Logs Menu* on page 99 for detailed information on the available options.

Utilities

The Utilities menu provides tools for system diagnostics and upgrading the Express XL/XLT. See the section *Utilities Menu* on page 103 for detailed information on the available options.

NAVIGATING THE TERMINAL MENUS

The following sections provide information on how to navigate through the terminal menus.

General Layout

When you first start a terminal mode session, the window shown in *Figure 3-1* on page 28 displays. The screen is divided into left and right panes. The left pane shows the current list of submenus, while the right pane shows the contents of a selected submenu.

Menu Path

The top line of the display shows this session's current position (path) in the menu tree. *Figure 3-1* shows the top menu level with the cursor on the Configuration submenu, so the path display shows **Express XLT/Configuration**.

Moving Around

Press **Tab** or the right arrow key to move the cursor from the left pane to the right pane. Press **Tab** or the left arrow key to move the cursor from the right pane back to the left pane. Use the up and down arrows to move around within each pane. Press **Enter** to activate a menu. Press the left arrow key or the **Escape** key to go back up the menu. The following options display throughout the menus.

Submenus [+] or **[DATA]**

Menus that display **[+]** or **[DATA]** indicate that more items are available when selected.

Activation Field <+>

Menus that display **<+>** indicate that an action is to be taken, such as activating a test.

Editable Data Field

A highlighted menu item indicates that you can enter data in that field.

Read-Only Field

An underlined field is a display field that contains read-only information.

Navigation with the Keyboard

You can use different keystrokes to navigate through the terminal menu. Press **Control-Z** to activate a pop-up screen with the available keystrokes. The following section provides a list of the available keystrokes and the results:

General Navigation

H	Returns to the home screen.
J	Jumps between two menu items. Press J while on a menu item of interest, and you will jump back to the main screen. Go to another menu item of interest, Press J , and you will jump back to the screen that was displayed the first time you pressed J . Press J anytime you want to jump between these items.
Arrow Keys	Selects items and moves between the left and right panes. The left arrow key allows you to go back up the menu.
Enter	Activates an item or moves into submenu.
Escape	Cancels an edit. Allows you to go back up the menu. Also will dismiss the pop-up help screens.
Tab	Moves between the left and right panes.
A	Moves to the top of a screen.
Z	Moves to the bottom of a screen.
Backspace	Ascends one menu level.

Session Management

Control-L	Logs out of the session.
Control-S	Invalidates the password entry and returns to the login screen. The Password prompt will display.
Control-R	Refreshes the screen. To save time, only the portion of the screen that has changed is refreshed. This option should be necessary only if the display picks up incorrect characters.

Configuration

- F** Restores factory default settings. This setting restores the factory defaults based on the location of the cursor. Entire submenus can be factory defaulted.
- C** Copies selected items to the clipboard. The amount of information you can copy depends on the cursor location when you press **C**. For example, if the cursor is over an editable field, only that item is copied. If the cursor is over the index number of a list, then all of the items in the row of the list are copied. For example, if the cursor is over the **Num** field in the Connection List screen, all of the information associated with the Connection List entry is copied.
- P** Pastes the item stored in the clipboard, if the information is compatible. You must confirm all pastes except those to a single editable field.
- >** For certain types of fields, when you paste information into the field, the value increments by 1.
- <** For certain types of fields, when you paste information into the field, the value decrements by 1.
- I** Inserts a new item in a list. For example, add a new item to the Connection List by pressing **I** while the cursor is over the index number.
- D** Deletes a list item. For example, delete an item from the Connection List by pressing **D** while the index number is active.

Security Levels

Each menu item on the configuration screens has an associated security level. The security level ranges from 0 (highest security level) to 5 (lowest security level). This level determines whether a Telnet session can access that menu item. The Telnet session is assigned a security level set by the user. Passwords can only be accessed as security level 0. The maintenance port is always at security level 0.

The security levels are assigned as follows:

Level

0	Access all parameters including passwords
1	Access all parameters except passwords
2	Access all parameters except passwords and authentication methods
3	Access all parameters except passwords, authentication methods, and ISDN parameters
4	Access only test and status menus
5	Access status menus only

CONFIGURATION MENU

Configuration/System Info

The System Info menu provides basic information about the unit and displays data fields for editing information. Figure 3-2 displays the submenus available under this menu item.

```

Express XLT/Configuration/System Info
System Info
WAN
IP
IPX
Bridge
Security
Connection List
Management
System Name
System Location
System Contact      Adtran Customer Service (888)423-8726
Firmware Revision   0.15
System Uptime       1 days, 17 hours, 48 mins, 15 secs
Date/Time           Wednesday January 14 09:16:34 1998

MODE: IP IPX Bridge      LOOP: Link down      B1: Idle      B2: Idle
                        Z=help  9:16_

```

Figure 3-2
Configuration/System Info Screen

System Name

Write security: 3; Read security: 5

Provides a user configurable text string for the name of the Express XL/XLT. This name can help distinguish between different installations. You can enter up to 31 alpha-numeric characters in this field, including spaces and special characters (such as an under bar). The system name is also used for PPP authentication and IPX service name.

System Location

Write security: 3; Read security: 5

Provides a user configurable text string for the location of the Express XL/XLT. This helps to keep track of the physical location of the unit. You can enter

up to 31 alpha-numeric characters in this field, including spaces and special characters (such as an under bar).

System Contact

Write security: 3; Read security: 5

Provides a user configurable text string for the contact name. This field can contain a name, phone number, or e-mail address of a person responsible for the Express XL/XLT. You can enter up to 31 alpha-numeric characters in this field, including spaces and special characters (such as an under bar).

Firmware Revision

Read security: 5

Displays the current firmware revision level of the Express XL/XLT. This field is a read-only field.

System Uptime

Read security: 5

Displays the length of time the Express XL/XLT has been running since power up or reset. This field is a read-only field.

Date/Time

Write security: 3; Read security: 5

Displays the current data and time as programmed in the real time clock. This field can be edited. Enter the time in 24-hour format (such as 23:00:00 to represent 11:00 PM). Enter the data in mm-dd-yyyy format (for example, 09-30-1997).

Configuration/WAN

The WAN menu is used to set up the ISDN parameters for the Express XL/XLT. Also, for the Express XLT, a POTS menu is provided. Figure 3-3 shows the WAN menu.

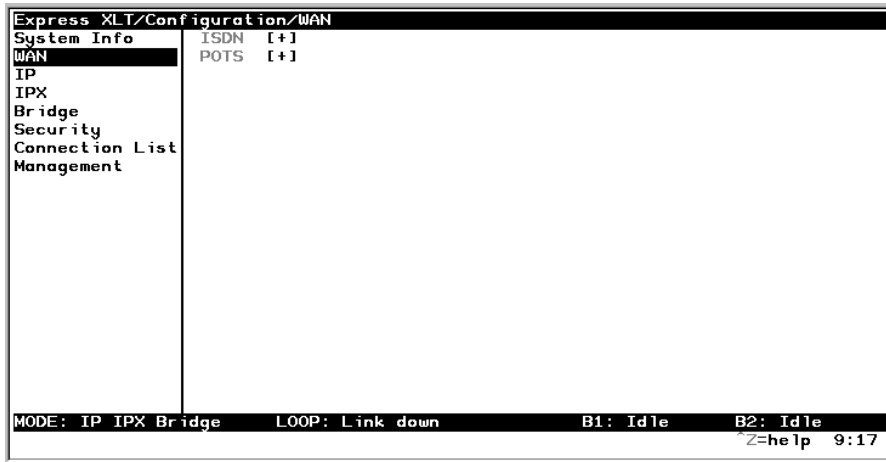

Figure 3-3
Configuration/WAN Screen

WAN/ISDN

Write security: 2; Read security: 5

Selects the mode the ISDN line is in. If connecting to the public network, select **Dial** (def). If connecting to a leased wire for back-to-back operation, select **Leased**.

ISDN/Dial Line

Dial Line parameters are entered under this menu.

Dial Line/ExpertISDN

Write security: 2; Read security: 5

The **ExpertISDN** option allows automatic determination of Service Profile Identifier (SPID) 1 and SPID 2 with entry of the Local Directory Number(s) (LDN(s)) and area code. Enter the 7-digit LDN in LDN 1 and LDN 2 (if a second number exists). The area code must be entered. The message **Auto Spid Success** will appear in the Call Log to indicate success in determining the SPID. See *Appendix B* on page 121 for additional messages and their definitions.

Dial Line/Switch Protocol

Write security: 2; Read security: 5

Find out what kind of ISDN switch protocol the local CO is using by asking the local telephone administrator or the telephone company representative.

The Express XL/XLT can be configured for the following:

AT&T 5ESS (def) AT&T 5ESS© Custom

DMS-100 Northern Telecom DMS-100™ Custom

National ISDN1 National ISDN-1 (could be a NorTel, AT&T, or Siemens EWSD)

NEC Nippon Electric Company Switch

Dial Line/Area Code

Write security: 2; Read security: 5

Enter 3-digit area code when using ExpertISDN.

Dial Line/SPID 1

Write security: 2; Read security: 5

The SPID is a sequence of digits used to identify ISDN terminal equipment to the ISDN switch. The SPID is assigned by the local phone company when the ISDN line is installed and it usually looks similar to the phone number. Obtain SPIDs from the telephone administrator or local telephone representative.

The number of SPIDs required (0, 1, or 2) depends on how your ISDN line is configured. For instance, a point-to-point line has no SPID. Multipoint lines may have one or two SPIDs. The Express XL/XLT uses the presence of SPID 1 to determine if the line is multipoint. If the line has only one SPID, then it must be entered in SPID 1.

SPID 1 =	0	1	5	5	5	1	2	1	2	0
SPID 2 =	0	1	5	5	5	1	2	1	3	0



National ISDN-1 switches require the addition of a two-digit terminal identifier (TID) at the end of the SPID.

Dial Line/LDN 1 or 2

Write security: 2; Read security: 5

This option allows the entry of 0, 1, or 2 LDNs. The LDN is used when placing or receiving calls. The LDN is the local phone number assigned to the line.

```
LDN 1 = 5 5 5 1 2 1 2
LDN 2 = 5 5 5 1 2 1 3
```



NOTE

Disconnect the network interface from the unit before initially entering or altering the SPIDs and LDNs.

ISDN/Leased Line

Write security: 2; Read security: 5

Leased Line parameters are entered under this menu. Leased mode would be used for permanent circuits.

Leased Line/Clock Mode

Write security: 2; Read security: 5

The clock mode determines which unit will supply the clock for synchronization. If the two units are connected through channel banks, both units should be configured for Slave mode.

Slave (def)

Timing is derived from the master unit.

Master

Timing is derived from this unit.

Leased Line/Channel Rate

Write security: 2; Read security: 5

64k

Only B1 is used.

2x64k

B1 and B2 go to different locations.

128k (def)

B1 and B2 are used together.

144k

B1, B2 and D are used together.

ISDN/NEBEs

Read security: 5

This contains the number of Near-End-Block-Errors (NEBEs) that have been detected by the Express XL/XLT's ISDN circuitry. Continuous errors can indicate a line problem, but a burst at one time is normal.

ISDN/FEBEs

Read security: 5

This contains the number of Far-End-Block-Errors (FEBEs) that have been detected by the ISDN circuitry on the other end of the link. Continuous errors can indicate a line problem, but a burst at one time is normal.

WAN/POTS

Write security: 2; Read security: 5

POTS parameters are under this menu. They appear only under the Express XLT version.

POTS/POTS Assignment

Write security: 2; Read security: 5

The Express XLT can assign the POTS interface either **LDN 1** or **LDN 2** (def). Once assigned, all incoming and outgoing calls are placed to/from this number.

POTS/NI-1 Conference FI

Write security: 2; Read security: 5

National ISDN Conference feature indication number is placed here. Most COs use the default of 60.

POTS/NI-1 Transfer FI

Write security: 2; Read security: 5

National ISDN Transfer feature indication number is placed here. Most COs use the default of 61.

POTS/Speech Calltype Routing

Write security: 2; Read security: 5

This allows the Express XLT to treat incoming calls as “data over speech” when selected as **LAN**. Otherwise, when set to **POTS** (def), incoming speech calls are sent to the POTS when the destination number is the same as the POTS assignment.

Configuration/IP

The IP menu is used to set up the IP parameters for the Express XL/XLT. Any general IP-related configuration item is under this menu. Figure 3-4 shows the IP menu.

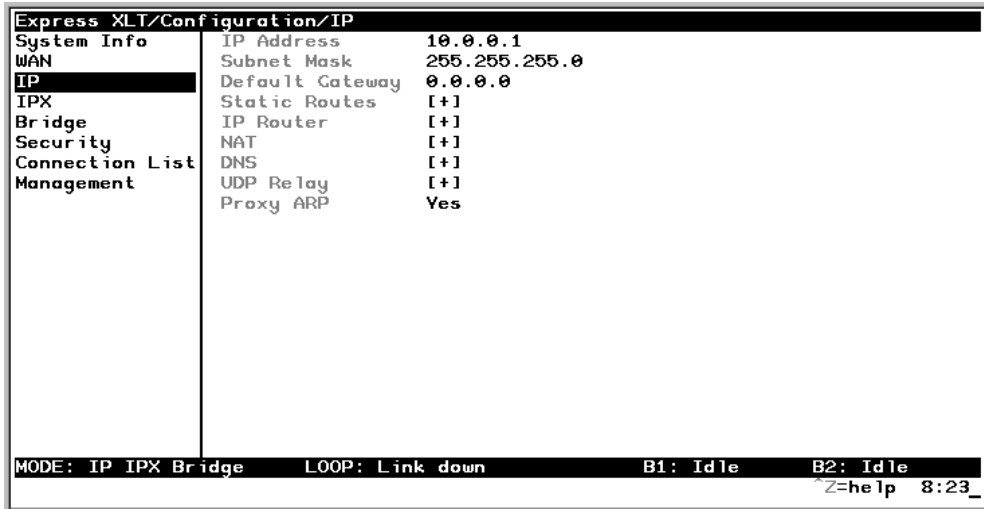

Figure 3-4
Configuration/IP Screen

IP/IP Address

Write security: 2; Read security: 5

The IP address assigned to the Express XL/XLT's Ethernet port is set here. This address must be unique within the network. Factory default is 10.0.0.1.

IP/Subnet Mask

Write security: 2; Read security: 5

The IP network mask to be applied to the Express XL/XLT's Ethernet port is set here. Factory default is 255.255.255.0.

IP/Default Gateway

Write security: 3; Read security: 5

The default gateway is used by the Express XL/XLT for sending IP packets whose destination address is not found in the route table. If this address is all zeros, then the first WAN connection becomes the default gateway. If the address entered is not on the Ethernet segment, then an "idle route" entry is added to the route table.

IP/Static Routes

Static Routes can be inserted under this menu.

Static Routes/Active

Write security: 4; Read security: 5

Adds this static route entry to the IP routing table when set to **Yes** (def) and removes it (if it was previously added) if set to **No**.

Static Routes/IP Address

Write security: 4; Read security: 5

This is the IP address of the host or network address of the network.

Static Routes/Subnet Mask

Write security: 4; Read security: 5

This mask determines the bits in the previous IP address that are used. If this is to be a host route, it must be set to all ones (255.255.255.255).

Static Routes/Gateway

Write security: 4; Read security: 5

This is the IP address of the router to receive the forwarded IP packet.

Static Routes/Hops

Write security: 4; Read security: 5

This is the number of router hops required to get to the network or host. Maximum distance is 15 hops.

Static Routes/Private

Write security: 4; Read security: 5

When set to **No**, the Express XL/XLT will advertise this static route using RIP. Otherwise, setting to **Yes** means that the route is kept private.

IP/IP Router

The IP router is configured under this menu as follows.

IP Router/Mode

Write security: 3; Read security: 5

When this option is set to **On** (def), the Express XL/XLT will advertise and listen to routes from other IP routers. If **Off**, the route table is still used but only static routes are used for routing IP packets and only the Ethernet port is used. IP packets can be sent over the WAN, but only when bridged.

IP/RIP

Write security: 3; Read security: 5

The Routing Information Protocol (RIP) is supported by the Express XL/XLT. The following parameters are required for setting up the mode on the Ethernet port:

RIP/Mode

Write security: 3; Read security: 5

This option turns RIP **On** (def) or **Off**

RIP/Protocol

Write security: 3; Read security: 5

Version can be **V1** (def) or **V2**

RIP/Method

Write security: 3; Read security: 5

Split Horizon - Only routes not learned on the Ethernet port are advertised.

Poison Reverse (def) - All routes are advertised, including routes learned from the Ethernet port. These routes are poisoned.

None - All routes are advertised, including routes learned from the Ethernet port. No attempt is made to poison these routes.

RIP/Direction

Write security: 3; Read security: 5

Tx and Rx (def)- RIP advertisements are transmitted and listened to on the Ethernet port.

Tx only - RIP advertisements are transmitted and not listened to.

Rx only - RIP advertisements are listened to but not transmitted.

RIP/V2 Secret

Write security: 0; Read security: 0

This is a text string used for authenticating advertised routes.

IP/NAT

The Network Address Translation general parameters are set up under this menu.

NAT/DHCP Mode

Write security: 3; Read security: 5

When this option is set to **On**, the Express XL/XLT acts as a DHCP server and will dynamically assign IP, network mask, default gateway, and DNS addresses to any device which transmits a broadcast DHCP request. The addresses assigned are based on the Express XL/XLT's own IP address and will be within the same network. This mode is most commonly used with the NAT functionality. The default is **Off**.

NAT/DHCP Renewal Time

Write security: 3; Read security: 5

This is the number of hours that the DHCP server should allow the device before it is required to send a new DHCP request. The default is 15 hours, and 0 represents an infinite lease.

NAT/Web Server

Write security: 3; Read security: 5

This is the IP address of a web server on the Ethernet network. When an active NAT connection is made to the Internet, any HTTP, FTP, or Mail server requests from the WAN are translated and sent to this web server.

IP/DNS

The Domain Name Server parameters used by the Express XL/XLT are specified here. The DNS server addresses can be exchanged between PPP peers. When a connection occurs and IPCP is negotiated, the Express XL/XLT will get the DNS server addresses from the PPP peer. If the configured DNS server addresses (**Server 1** and **Server 2**) are all zeros, the addresses from the PPP peer are used. In NAT mode, the PPP peer's DNS addresses are always used. The DNS addresses set in **Server 1** and **Server 2** are offered to a PPP peer if so requested.

DNS/Domain Name

Write security: 3; Read security: 5

This is a text string used to represent the domain name used by the Express XL/XLT.

DNS/Server 1

Write security: 3; Read security: 5

This is the IP address for the primary DNS device. It is the first server that domain name requests are sent.

DNS/Server 2

Write security: 3; Read security: 5

This is the IP address for the secondary DNS device. It is used as a back-up in case the primary address does not respond to the request.

IP/UDP Relay

The Express XL/XLT can be configured as a relay agent for UDP broadcast packets. Normally, a router will not forward UDP broadcast packets. However, many network application use UDP broadcasts to configure addresses, host names, and other information. If hosts using these protocols are not on the same network segment as the servers providing the information, the client programs will not receive a response without enabling the UDP relay agent.

UDP Relay/Mode

Write security: 3; Read security: 5

When this option is set to **On** (def), the Express XL/XLT will act as a relay agent.

UDP Relay/UDP Relay List

Up to four relay destination servers can be specified in this list.

UDP Relay List/Relay Address

Write security: 3; Read security: 5

This is the IP address of the server that will receive the relay packet.

UDP Relay List/UDP Port Type

Write security: 3; Read security: 5

Standard (def) - The following standard UDP protocols are relayed when set: DHCP, TFTP, DNS, NTP (Network Time Protocol, port 123). NBNS (NetBIOS Name Server, port 137), NBDG (NetBIOS Datagram, port 138), and BootP.

Specified - When set, the UDP port (1 to 65535) can be specified in the UDP Port columns. (up to a maximum of three per server)

UDP Relay List/UDP Port 1, UDP Port 2, UDP Port 3

Write security: 3; Read security: 5

UDP Port 1, UDP Port 2, and UDP Port 3 are used for specifying UDP ports to be relayed. These fields only apply when **UDP Port Type** is set to **Specified**.

IP/Proxy ARP

Write security: 4; Read security: 5

This feature allows the network portion of a group of addresses to be shared between several physical network segments. The ARP protocol itself provides a way for devices to create a mapping between physical (i.e., Ethernet) addresses and logical IP addresses. Proxy ARP makes use of this mapping feature by instructing a router to answer ARP requests as a “proxy” for the IP addresses behind one of its ports. The device which sent the ARP request will then correctly assume that it can reach the requested IP address by sending packets to the physical address that was returned to it. This technique effectively hides the fact that a network has been (further) subnetted. If this option is set to **Yes** (def), when an ARP request is received on the Ethernet port the address is looked up in the IP routing table. If the forwarding port is not on the Ethernet port and the route is not the default route, the Express XL/XLT will answer the request with its own hardware address. If set to **No**, the Express XL/XLT will only respond to ARP requests received for its own IP address.

Configuration/IPX

The IPX menu is used to set up the IPX parameters for the Express XL/XLT. Any general IPX-related configuration item can be found under this menu. Figure 3-5 shows the IPX menu.

```

Express XL/Configuration/IPX
System Info      Mode                On
WAN              Network            00:00:00:00
IP               Frame Type         Ether Type II
IPX              Seed Status        Non-Seed
Bridge           RIP Timer (10-180) 60
Security         SAP Timer (10-180) 60
Connection List
Management

MODE: IP IPX Bridge   LOOP: Link down   B1: Idle   B2: Idle
^Z=help  9:20_

```

Figure 3-5
Configuration/IPX Screen

IPX/Mode

Write security: 2; Read security: 5

When this option is set to **On** (def), the Express XL/XLT will route IPX. Setting it to **Off** will disable all IPX functionality.

IPX/Network

Write security: 2; Read security: 5

The IPX network address for the Ethernet port is set here. This is an eight-digit hexadecimal value that uniquely identifies the network segment of the Ethernet port. Accidental selection of an IPX network which is already in use on another network segment may cause hard-to-diagnose problems. IPX network numbers should be carefully tracked.

IPX/Frame Type

Write security: 2; Read security: 5

The Express XL/XLT supports all four defined IPX frame types. The possible frame types are: **Ether Type II (def)**, **Ether 802.3 (Raw)**, **Ether 802.2**, or **Ether SNAP (802.2 SNAP)**. Only one frame type can be used at one time.

IPX/Seed Status

Write security: 2; Read security: 5

The seed status defines what the Express XL/XLT is to do with the network information on the selected frame type during startup. There are three possible seeding selections specified:

Seed - The Express XL/XLT will listen for an IPX network number being sent by another router (including Novell software routers residing on servers) on the Ethernet segment connected to this port and use this number if it exists. If it doesn't discover a number in use, the Express XL/XLT will use the configured IPX network number for the Ethernet segment.

Non-Seed (def) - The Express XL/XLT will listen for an IPX network number being sent by another router (including Novell software routers residing on servers) on the Ethernet segment connected to this port and use this number if it exists. If it doesn't discover a number in use, the Express XL/XLT will wait indefinitely until a number is sent by another router on the Ethernet segment.

Auto-Seed - The Express XL/XLT will listen for an IPX network number being sent by another router (including Novell software routers residing on servers) on the Ethernet segment connected to this port and use this number if it exists. If it doesn't discover a number in use, the Express XL/XLT will auto-generate a valid number using its routing tables.

IPX/RIP Timer

Write security: 3; Read security: 5

This value specifies how often the Express XL/XLT sends out IPX RIP packets on the network segment attached to the Ethernet port. The RIP packets sent contain routing information about the networks for which this Express XL/XLT is responsible. The default value is 60 seconds.

IPX/SAP Timer

Write security: 3; Read security: 5

This value specifies how often the Express XL/XLT sends out IPX SAP (Service Access Protocol) packets on the network segment attached to the Ethernet port. The SAP packets sent contain information about the services (such as servers, printers, etc.) for which this Express XL/XLT is responsible. The default value is 60 seconds.

Configuration/Bridge

The Bridge menu is used to set up the bridge parameters for the Express XL/XLT. The bridging function runs at the Media Access Control (MAC) level which allows any protocol packets that run over Ethernet to be forwarded. Bridging can run concurrently with the IP and IPX routing. However, certain rules apply for when packets are bridged across a WAN connection. When IP routing is active, IP packets (which include ARP packets) are not bridged. When IPX routing is active, IPX packets are not bridged. Also, the WAN IP Bridge and WAN IPX Bridge menus allow the WAN connection to bridge packets to the Express XL/XLT but get routed as soon as they arrive at the unit. Figure 3-6 shows the Bridge menu.

```

Express XL/Configuration/Bridge
System Info      Mode           On
WAN              WAN IP Bridge  [+1]
IP               WAN IPX Bridge [+1]
IPX              Spanning Tree  [+1]
Bridge           Address Table  [+1]
Security
Connection List
Management

MODE: IP IPX Bridge      LOOP: Link down      B1: Idle      B2: Idle
                             Z=he Ip  9:21_

```

Figure 3-6
Configuration/Bridge Screen

Bridge/Mode

Write security: 2; Read security: 5

When this option is set to **On** (def), the Express XL/XLT bridge function will be enabled. Setting it to **Off** will disable all bridge functionality.

Bridge/WAN IP Bridge

When IP routing is active, the Express XL/XLT will allow another WAN device to bridge IP packets to it using PPP BCP. Normally, two IP routers would

negotiate PPP IPCP to exchange IP packets. However, if a device can only support PPP BCP, IP packets are encapsulated by the device as bridge packets. The Express XL/XLT can treat the WAN IP Bridge as a virtual Ethernet port connected only to a WAN device which has negotiated PPP BCP. This menu allows the IP parameters for this virtual Ethernet to be setup.

WAN IP Bridge/Network

Write security: 2; Read security: 5
This is the IP address of the virtual Ethernet port.

WAN IP Bridge/Netmask

Write security: 2; Read security: 5
This is the network mask to be applied to the virtual Ethernet port.

WAN IP Bridge/Triggered

Write security: 2; Read security: 5
When set to **Yes**, only IP RIP updates are sent when the routing table has changed. When set to **No** (def), updates are sent periodically. RIP version, method, and direction are determined by the Ethernet parameters set in the **Configuration/IP/IP Router/RIP** menu.

WAN IP Bridge/Proxy ARP

If this option is set to **Yes** (def), the Express XL/XLT will proxy ARP on the bridge IP port. See the section *IP/Proxy ARP* on page 46 for an explanation of the proxy ARP function.

Bridge/WAN IPX Bridge

When IPX routing is active, the Express XL/XLT will allow another WAN device to bridge IPX packets to it using PPP BCP. Normally, two IPX routers would negotiate PPP IPXCP to exchange IPX packets. However, if a device can only support PPP BCP, IPX packets are encapsulated by the device as bridge packets. The Express XL/XLT can treat the WAN IPX Bridge as a virtual Ethernet port connected only to a WAN device which has negotiated PPP BCP. This menu allows the IPX parameters for this virtual Ethernet to be setup.

WAN IPX Bridge/Network

Write security: 2; Read security: 5

This is the network address of the virtual Ethernet port. See *IPX/Network* on page 47 for explanation of the IPX network number.

WAN IPX Bridge/Frame Type

Write security: 2; Read security: 5

This is the frame type used for the virtual Ethernet port. See *IPX/Frame Type* on page 48 for an explanation of the IPX frame type.

WAN IPX Bridge/Seed Status

Write security: 2; Read security: 5

This is the seed status used for the virtual Ethernet port. See *IPX/Seed Status* on page 48 menu for an explanation of the IPX seed status.

WAN IPX Bridge/Triggered

Write security: 2; Read security: 5

When set to **Yes**, only IPX RIP and SAP updates are sent when the routing or service table has changed. When set to **No** (def), updates are sent at the same rate set for the Ethernet port (see *IPX/RIP Timer* on page 48 and *IPX/SAP Timer* on page 49).

Bridge/Spanning Tree

The Spanning Tree Algorithm and Protocol ensures a loop-free topology and provides redundancy. The protocol parameters can be specifically tuned from their defaults, though most applications require no adjustment.

Spanning Tree/Mode

Write security: 2; Read security: 5

When the mode is set to **On**, the Express XL/XLT will participate in the spanning tree protocol between other bridges. When **Off** (def), all bridge ports remain permanently open for forwarding.

Spanning Tree/Priority

Write security: 2; Read security: 5

This assigns a priority to the Express XL/XLT that permits the relative priority of multiple bridges to be managed. The range is 0 to 65535 with a default of 32768.

Spanning Tree/Maximum Age

Write security: 2; Read security: 5

This is the timeout value used by the Express XL/XLT to test against the root device. The value is in one-tenth seconds with a range between 60 (6.0 seconds) and 400 (40.0 seconds). The default is 200 (20.0 seconds).

Spanning Tree/Hello Time

Write security: 2; Read security: 5

This is the time between the generation of configuration BPDUs (Bridging Protocol Data Units) by the root bridge. The value is in one-tenth seconds with a range between 10 (1.0 second) and 100 (10.0 seconds). The default is 20 (2.0 seconds).

Spanning Tree/Forward Delay

Write security: 2; Read security: 5

This is the time spent in the listening and learning state while moving from the blocking state to the forwarding state. The value is in one-tenth seconds with a range between 40 (4.0 seconds) and 300 (30.0 seconds). The default is 150 (15.0 seconds).

Spanning Tree/LAN Port

The path cost and priority parameters for the Ethernet port are specified under this menu.

LAN Port/Active

Write security: 2; Read security: 5

The Ethernet port can be disabled when set to **No**. In this mode, no bridge traffic will be forwarded in or out. Setting to **Yes** (def) allows the port to participate in the spanning tree topology.

LAN Port/Path Cost

Write security: 2; Read security: 5

This is the cost of using the Ethernet port in the total cost of the path. The range is from 1 to 65535 with a default of 100 (for 10 Mbits/second).

LAN Port/Priority

Write security: 2; Read security: 5

The priority adjusts the relative priority of the Ethernet port among the multiple bridge ports. The range is 0 to 255 with a default of 128.

Spanning Tree/WAN Port 0

The WAN port 0 is considered to be the first PPP BCP connection that occurs over the ISDN link. It can be a single B channel or two B channels running PPP Multilink.

WAN Port 0/Active

Write security: 2; Read security: 5

The WAN 0 port can be disabled when set to **No**. In this mode, no bridge traffic will be forwarded in or out. Setting to **Yes** (def) allows the port to participate in the spanning tree topology.

WAN Port 0/Path Cost

Write security: 2; Read security: 5

This is the cost of using the WAN port 0 in the total cost of the path. The range is from 1 to 65535 with a default of 15625 (for 64 kbits/second). Note that when running over two B channels using PPP Multilink, the range does not adjust itself. If it is known that the only WAN port will be WAN port 0 over two B-channels, then the path cost for this port should be changed 7812 (128 Kbits/second).

WAN Port 0/Priority

Write security: 2; Read security: 5

The priority adjusts the relative priority of the WAN port 0 among the multiple bridge ports. The range is 0 to 255 with a default of 128.

Spanning Tree/WAN Port 1

WAN port 1 is considered to be the second B channel PPP BCP connection made. This port is only used when the first B channel (WAN Port 0) is going to an entirely different bridge.

WAN Port 1/Active

Write security: 2; Read security: 5
This setup is exactly like WAN Port 0 above.

WAN Port 1/Path Cost

Write security: 2; Read security: 5
This setup is exactly like WAN Port 0 above.

WAN Port 1/Priority

Write security: 2; Read security: 5
This setup is exactly like WAN Port 0 above.

Bridge/Address Table

The Express XL/XLT automatically maintains a table of MAC addresses detected and associates those addresses with the LAN, WAN0, or WAN1 port from which they were received. This menu permits the user to adjust the parameters or rules for the table as addresses are learned.

Address Table/Aging

Write security: 3; Read security: 5
This is the maximum time an idle MAC address remains in the table before being removed. The value is in minutes and can range from 0 (which means never age) to 65535. The default is 5.

Address Table/Forward Policy

Write security: 3; Read security: 5
When this parameter is set to **Unknown** (def), any bridge packet with a destination MAC address that is not in the bridge table is forwarded to all other ports. When set to **Known**, the packet with the unknown destination MAC address is dropped and is not forwarded.

Configuration/Security

The Security menu is used to set up the authentication parameters needed to authenticate PPP connection over the ISDN B-channels. Also, the filter defines are placed under this menu. Figure 3-7 shows the Security menu.

```

Express XL/Configuration/Security
System Info      Authentication  None
WAN              When            Answer Only
IP               Radius Server  [+]
IPX              PPP             CHAP or EAP
Bridge          Filter Defines  [+]
Security
Connection List
Management

MODE: IP IPX Bridge      LOOP: Link down      B1: Idle      B2: Idle
                               Z=help  9:23_

```

Figure 3-7
Configuration/Security Screen

Security/Authentication

Write security: 1; Read security: 2

The method used for authenticating the PPP peer is selected here. The possible values are:

None (def) - No attempt is made to authenticate the PPP peer.

Radius - The Express XL/XLT will act as a RADIUS client and authenticate the PPP peer using the RADIUS server. The Radius server parameters must be set up properly for this to work.

Connection List - The Connection List profile is used to authenticate the PPP peer.

See *Configuration/Connection List* on page 63 for more information on authenticating.

Security/When

Write security: 1; Read security: 2

The Express XL/XLT can be configured to authenticate the PPP peer (using the above method) for incoming calls using **Answer Only** (def), or for outgoing and incoming calls using **Originate and Answer**.

Security/Radius Server

The parameters for the radius server are configured in this menu. The RADIUS server can be used for authenticating a PPP peer (if defined under **Security/Authentication**) and for Telnet server sessions.

Radius Server/Primary Server

Write security: 1; Read security: 2

This is the IP address of the first RADIUS server that the Express XL/XLT should attempt to communicate with when authenticating a PPP peer.

Radius Server/Secondary Server

Write security: 1; Read security: 2

This is the IP address of the back-up RADIUS server that the Express XL/XLT should attempt to communicate with when the primary server does not respond.

Radius Server/UDP Port

Write security: 1; Read security: 2

This is the UDP port that the Express XL/XLT should use when communicating with the RADIUS server. The default is 1645, which is the commonly used port.

Radius Server/Secret

Write security: 0; Read security: 1

The RADIUS server and Express XL/XLT share this text string, which is used by the RADIUS sever to authenticate the Express XL/XLT that is the RADIUS client. The factory default is to not use a secret.

Radius Server/Retry Count

Write security: 1; Read security: 2

This is the number of times the Express XL/XLT should send a request packet to the RADIUS server without a response before giving up. If the number of attempts to communicate with the primary server is equal to the retry count, the secondary server (if defined) is tried. If the secondary server does not respond within the retry count, the PPP peer (or Telnet session) is not authenticated and is dropped. The default is 5.

Security/PPP

Write security: 1; Read security: 2

The PPP peer can be authenticated using three standard methods: PAP (Password Authentication Protocol), CHAP (Challenge Handshake Protocol) and EAP (Extensible Authentication Protocol). The strength of the authentication is determined in the order EAP, CHAP, followed by PAP, where EAP is the strongest and PAP is the weakest. PAP is a clear-text protocol, which means it is sent over the PPP link in a readable format. Care must be taken not to allow highly sensitive passwords to become compromised using this method. CHAP and EAP use a one-way hashing algorithm which make it virtually impossible to determine the password. EAP has other capabilities which allow more flexibility than CHAP.

The following selections are possible:

PAP, CHAP or EAP (def) - The Express XL/XLT will ask for EAP during the first PPP LCP negotiation and allow the PPP peer to negotiate down to CHAP or PAP.

CHAP or EAP - The Express XL/XLT will ask for EAP during the first PPP LCP negotiation and allow the PPP peer to negotiate down to CHAP but not PAP.

EAP - The Express XL/XLT will only allow EAP to be negotiated. If the PPP peer is not capable of doing EAP, then the connection will not succeed.

Security/Filter Defines

The Express XL/XLT can filter packets based on certain parameters within the packet. The method used by the Express XL/XLT allows the highest flexibility for defining filters and assigning them to a Connection List profile. The filters are set up in two steps: (1) defining the packet types, and (2) adding them to a list under the Connection List profile. See the section *Connection List/Filters* on page 79 for examples of how to set up filter profiles. This menu is used to define the individual filter defines based on packet type.

Filter Defines /MAC Filter Defines

Write security: 2; Read security: 3

The MAC filter is applied to bridge packets only. Bridge packets which are forwarded by the bridge functionality of the Express XL/XLT are defined here. Up to 32 MAC defines can be specified.

Name	Identifies the filter entry
Src Addr	48-bit MAC source address used for comparison. (hexadecimal format)
Src Mask	Bits in the MAC source address which are compared. (hexadecimal format)
Dest Addr	48-bit MAC destination address used for comparison. (hexadecimal format)
Dest Mask	Bits in the MAC destination address used for comparison. (hexadecimal format)
MAC Type	16-bit MAC type field used for comparison. (hexadecimal format)
Type Msk	Bits in the MAC type field used for comparison. (hexadecimal format)

Filter Defines /Pattern Filter Defines

Write security: 2; Read security: 3

The pattern filter is applied to bridge packets only. That is any packet which is forwarded by the bridge functionality of the Express XL/XLT. Up to 32 pattern defines can be specified.

Name	Identifies the filter entry
Offset	Offset from beginning of packet of where to start the pattern comparison
Pattern	64 bits used for comparison. (hexadecimal format)
Mask	Bits in the pattern to be compared. (hexadecimal format)

Filter Defines /IP Filter Defines

Write security: 2; Read security: 3

The IP filter defines apply to any IP packet, whether it is routed or bridged. Up to 32 IP defines can be specified.

Name	Identifies the filter entry
IP Src	IP address compared to the source address. (dotted decimal format)
Src Mask	Bits which are used in the source comparison. (dotted decimal format)
IP Dest	IP address compared to the destination address. (dotted decimal format)
Dest Mask	Bits which are used in the destination comparison. (dotted decimal format)
Src Port	IP source port number used for comparison Range: 0 to 65535. (decimal format)
Src Port Cmpr	Type of comparison that is performed = - means ports equal to not = - means port not equal to > - means port greater than < - means port less than None - means the source port is not compared
Dst Port	IP destination port number used for comparison Range: 0 to 65535. (decimal format)

Dst Port Cmpr	Type of comparison that is performed = - means ports equal to not = - means port not equal to > - means port greater than < - means port less than None - means the destination port is not compared
Proto	Protocol used for comparison. Range: 0 to 255. (decimal format)
Proto Cmpr	Type of comparison that is performed = - means protocols equal to not = - means protocols not equal to > - means protocols greater than < - means protocols less than None - means the protocol is not compared
TCP Est	Yes - only when TCP established No - only when TCP not established Ignore - ignore TCP flags

Filter Defines /IPX Filter Defines

Write security: 2; Read security: 3

The IPX filter defines apply to any IPX packet whether it is routed or bridged. Also, any IPX encapsulation type will be accounted for. Up to 32 IPX defines can be specified.

Name	Identifies the filter entry (15 characters max)
Src Net	32-bit source network address
Src Mask	Bits in the source network address which are compared. (hexadecimal format)
Dest Net	32-bit destination network address
Dest Mask	Bits in the destination network address which are compared. (hexadecimal format)
Src Socket	16-bit value which is the source socket. Range is 0-65535.
Src Socket Comp	Type of comparison that is performed: = - means socket equal to Not = - means socket not equal to > - means socket greater than < - means socket less than None - no comparison is done on source socket
Dest Socket	16-bit value which is the destination socket. Range is 0-65535.

Dest Socket Comp Type of comparison that is performed:
= - means socket equal to
Not = - means socket not equal to
> - means socket greater than
< - means socket less than
None - no comparison is done on destination socket

Type 8-bit value which is the IPX type

Type Comp Type of comparison that is performed:
= - means type equal to
Not = - means type not equal to
> - means type greater than
< - means type less than
None - no comparison is done on IPX type

Configuration/Connection List

The Express XL/XLT uses the Connection List to specify the profile each user or group of users are to have when connected. Each profile or item in the Connection List has many configurable parameters giving high flexibility on a per user basis.

Up to 15 profiles can be defined in the Connection List. Calls cannot be originated or answered unless a Connection List profile is defined. The Express XL/XLT factory defaults with one profile called **DEFAULT**. This profile is used for any incoming calls when **Configuration/Security/Authentication = None** or when the username of the connecting PPP peer is not found in the Connection List.



To insert a new profile, press the **I** key when over the **Num** column. A new inserted profile will always be set up with the default parameters. To copy parameters from an old profile to this newly inserted profile, use the copy (**C**) and paste (**P**) keys. Entire configuration trees can be copied with this method.

Figure 3-8 shows the Connection List menu.

Num	Description	Active	Authentication	IP	IPX	Bridge	P
1	DEFAULT	Yes	[+]	[+]	[+]	[+]	

MODE: IP IPX Bridge LOOP: Link down B1: Idle B2: Idle Z=help 9:26

Figure 3-8
Configuration/Connection List Screen

Connection List/Description

Write security: 3; Read security: 4

The description is a text string that identifies the profile.

Connection List/Active

Write security: 3; Read security: 4

When set to **Yes** (def), this profile is used for authentication and user association of incoming calls. Setting to **No** is the same as deleting the item but allows the information of the profile to be saved.



*To delete an unused profile, use the **D** key when the cursor is over the number in the **Num** column. Once deleted, the profile is gone permanently as soon as the Connection List is saved. Items may be deleted when **DEL** appears below the status bar.*

Connection List/Authentication

The authentication menu contains the required parameters for the authentication of the PPP peer and for being authenticated by the PPP peer.

Authentication is applied between the Express XL/XLT and the PPP peer as follows:

1. The Express XL/XLT as the authenticator:
 - When answering an incoming call:
 - Express XL/XLT uses PPP method configured in **Configuration/Security/PPP**.
 - Authenticatee's username is looked up in all active Connection List profiles (**Rx Username**).
 - If found, the **Rx Password** is used for authenticating.
 - If not found, **DEFAULT** entry's **Rx Password** is used if **Rx Username** is blank.



*When answering a call, the Express XL/XLT does not know who the PPP peer is until the authentication phase is completed. Two PPP protocols (EAP and CHAP) require the authenticator to transmit a username which the authenticatee uses to cross reference the password to use. Since the PPP peer is unknown before the authentication phase is over, the Express XL/XLT uses the **Tx Username** in the **DEFAULT** profile to identify itself. If **Tx Username** is blank, **Configuration/System Info/System Name** is used. If that is blank, then the word "ADTRAN" is used.*

- When originating an outgoing call:
 - Express XL/XLT uses PPP method configured in **Configuration/Security/PPP**.
 - Authenticatee's username is compared to profile used to dial.
 - Authenticating with RADIUS:
 - When **Configuration/Security/Authentication** is set to **Radius**, authentication is performed by the RADIUS server.
 - The Express XL/XLT uses the **DEFAULT** Connection List profile for all other parameters not supported by RADIUS attributes.
 - RADIUS attributes currently supported are: framed ip, framed net-mask, framed ipx network, framed routing, framed compression, and idle timeout.
2. The Express XL/XLT as the authenticatee:
- When answering an incoming call:
 - If the **Configuration/Security/Authentication** parameter is set to **None**, the **DEFAULT** profile's **Tx Username** and **Tx Password** are used by the Express XL/XLT for authenticating itself.
 - If the **Configuration/Security/Authentication** parameter is set to **Connection List** or **RADIUS**, the Express XL/XLT will wait until the PPP peer is authenticated before authenticating itself (except when CHAP or EAP is used). If CHAP or EAP is used, the username transmitted by the PPP peer's authentication challenge packet is looked up in the Connection List. If found, the Express XL/XLT responds with the profile's **Tx Username** and **Tx Password** parameters. If not found, the **DEFAULT** profile's **Tx Username** and **Tx Password** parameters are used.
 - When originating an outgoing call:
 - The dial-out profile **Tx Username** and **Tx Password** are used regardless of the PPP peer's username received if CHAP or EAP is used.

Authentication/Tx Method

Write security: 2; Read security: 3

This parameter specifies how the Express XL/XLT is to be authenticated by the PPP peer. There are four possible selections. See *Security/PPP* on page 58 for an explanation of the three PPP standard authentication types.

None (def) - The connection will not allow the PPP peer to authenticate it.

PAP, CHAP or EAP - The connection can be authenticated using PAP, CHAP or EAP.

CHAP or EAP - The connection can be authenticated using CHAP or EAP only.

EAP - The connection will only allow authentication by the peer using EAP.

Authentication/Tx Username

Write security: 1; Read security: 3

This is the username that is used when being authenticated by the PPP peer.

Authentication/Tx Password

Write security: 0; Read security: 1

This is the password or secret that is used when being authenticated by the PPP peer.

Authentication/Rx Username

Write security: 1; Read security: 3

This is the username that is used to match the user to the Connection List profile. During an incoming call, the Express XL/XLT will scan all active connection profiles and match the received PPP peer's username. If the name is not found, then the **DEFAULT** profile is used, if and only if the **DEFAULT** profile has nothing in the **Rx Username** parameter. During an outgoing call, this username does not have to match the username reported by the PPP peer.

Authentication/Rx Password

Write security: 0; Read security: 1

This is the password or secret that is used to authenticate the PPP peer. This is only necessary when **Configuration/Security/Authentication = Connection List**.

Authentication/Caller ID

Write security: 1; Read security: 3

Incoming calls can be verified using the ISDN supplied caller identifier when this is set to **Yes**. When set to **No** (def), the caller identifier is not checked.

Authentication/Call ID 1

Write security: 1; Read security: 3

The caller identification from the ISDN incoming call is compared to this number, starting from the right digits.

Authentication/Call ID 2

Write security: 1; Read security: 3

The caller identification from the ISDN incoming call is compared to this number, starting from the right digits.

Connection List/IP

The IP menu contains the parameters for exchanging IP data with the PPP peer. Static routes can also be created from here for IP dial-on-demand applications.

IP/Mode

Write security: 3; Read security: 5

Setting to **On** (def) will permit this connection profile to negotiate PPP IPCP with the PPP peer for exchanging of IP packets.

IP/NAT

Write security: 3; Read security: 5

The Express XL/XLT can perform Network Address Translation. This feature is most widely used when connecting to the Internet. The Ethernet network can consist of private network numbers. When this profile is connected, all IP addresses on the Ethernet side are translated into the one real IP address negotiated with the PPP peer (ISP). Multiple stations on the Ethernet side can access the Internet simultaneously. See the section *IP/NAT* on page 43 for more global options. Setting this option to **On** will cause the Express XL/XLT to perform NAT. In the **Off** (def) position, the unit will route across the connection normally.

IP/Route

The IP parameters are configured in this menu. Adjusting these parameters is only necessary for certain dial-on-demand applications. Usually the Express XL/XLT will automatically discover the PPP peer's networks using PPP IPCP and/or RIP.

Route/IP/Net

Write security: 3; Read security: 5

The PPP peer's IP address or network can be set here, if known. Leaving this at 0.0.0.0 means that the Express XL/XLT will determine the PPP peer's IP and network using the PPP IPCP.

Route/Netmask

Write security: 3; Read security: 5

This network mask is applied to the **IP/NET** address for determining the PPP peer's network. If left as 0.0.0.0, a standard network mask is used.

Route/Static Route

Write security: 3; Read security: 5

When set to **Yes** (def), the Express XL/XLT will add the network defined above as an idle route in the IP routing table. When an IP packet is routed to this idle route, the Express XL/XLT will dial using this profile. When set to **No**, an idle route is not placed in the table. This is necessary for dial-on-demand applications and if the probe feature is not used.

Route/Private

Write security: 3; Read security: 5

When set to **Yes**, the Express XL/XLT will not advertise this static route entry. A setting of **No** (def) means any static route added for this profile is advertised using RIP.

Route/Hops

Write security: 3; Read security: 5

This value is the metric or number of hops that RIP will use in advertising the static route. The range is 1 to 16 where 1 is the default. The value 16 is considered an infinite distance in RIP and is, in effect, poisoning the route.

Route/Force IP

Write security: 3; Read security: 5

When set to **Yes**, the Express XL/XLT will force the PPP peer to use the IP address in the **IP/Net** for this profile as its WAN IP address. Normally this is set in the **No** (def) position.

IP/RIP

The RIP parameters can be adjusted from their defaults under this menu. The RIP parameters for all WAN connections are set on a per-session basis.

RIP/Mode

Write security: 3; Read security: 5

The Express XL/XLT will perform RIP over the WAN connection when this is set to **On** (def).

RIP/Protocol

Write security: 3; Read security: 5

The Express XL/XLT can perform version 1, **V1** (def), or version 2, **V2**, of RIP on this WAN connection.

RIP/Method

Write security: 3; Read security: 5

Split Horizon - Only routes not learned on the WAN connection are advertised.

Poison Reverse (def) - All routes are advertised, including routes learned from the WAN connection. These routes are poisoned.

None - All routes are advertised, including routes learned from the WAN connection. No attempt is made to poison these routes.

RIP/Direction

Write security: 3; Read security: 5

Tx and Rx (def)- RIP advertisements are transmitted and listened to on the WAN connection.

Tx only - RIP advertisements are transmitted and not listened to.

Rx only - RIP advertisements are listened to but not transmitted.

RIP/Triggered

Write security: 3; Read security: 5

When set to **Yes**, only IP RIP updates are sent when the routing table has changed and learned routes are not "aged." When set to **No** (def), updates are sent periodically.

RIP/Retain

Write security: 3; Read security: 5

When this Connection List entry is disconnected and this parameter is set to **Yes**, all routes learned from this WAN connection are retained and their routing interface is set to idle. This permits dial-on-demand to occur using this profile for any IP network that might have been advertised by the particular PPP peer. The idle routes can be flushed or “zombied” from the routing table if a manual hangup is performed when this WAN connection is not active. See *Dial/Hang Up* on page 89. When this Connection List entry is disconnected and this parameter is set to **No** (def), routes learned from this session are “zombied” and are not retained.

Connection List/IPX

The IPX menu contains the parameters for exchanging IPX data with the PPP peer.

IPX/Mode

Write security: 3; Read security: 5

Setting to **On** (def) will permit this connection profile to negotiate PPP IPXCP with the PPP peer for exchanging of IPX packets.

IPX/Remote Network

Write security: 3; Read security: 5

A non-zero value in this remote network number will allow the Express XL/XLT to add a route to the PPP peer’s network to the routing table.

The Express XL/XLT normally will treat the WAN network as an unnumbered link. This is usually referred to as being a “half-router.” However, a PPP peer which wants to assign a network address to the WAN link can do so, in which case the Express XL/XLT will go into “full-router” mode.

IPX/Triggered

Write security: 3; Read security: 5

When set to **Yes**, only IPX RIP and SAP updates are sent when the routing or service table has changed and learned routes are not “aged.” When set to **No** (def), updates are sent periodically based on the RIP and SAP timers set in **Configuration/IPX/RIP Timer** and **Configuration/IPX/SAP Timer**.

IPX/Retain

Write security: 3; Read security: 5

When this Connection List entry is disconnected and this parameter is set to **Yes**, all routes learned from this WAN connection are retained and their routing interface is set to idle. This permits dial-on-demand to occur using this profile for any IPX network or service that might have been advertised by the particular PPP peer. The idle routes can be flushed or “zombied” from the routing table if a manual hangup is performed when this WAN connection is not active. See **Dial/Hang up**. When this Connection List entry is disconnected and this parameter is set to **No** (def), IPX routes and services learned from this session are “zombied” and are not retained.

IPX/Type 20 Packets

Write security: 3; Read security: 5

In order for certain protocol implementations, like NetBIOS, to function in the NetWare environment, routes must allow a broadcast packet to be propagated throughout the IPX networks. The Type 20 IPX packet is used specifically for this purpose. This causes special handling of this packet by the Express XL/XLT. When a router receives this type of packet, it rebroadcasts it across all interfaces except the one it is received on and includes the network number of that interface in the data portion of the packet. The IPX Router Specification from Novell notes that Type 20 packets should not be propagated across slower links with bandwidths of less than 1Mbps (like ISDN). However, when set to **Pass** (def), the Express XL/XLT will allow these packets to propagate over the WAN connection. This facilitates dial-on-demand applications. When set to **Block**, all Type 20 packets are not propagated across the WAN connection.

Connection List/Bridge

The Bridge menu contains the parameters needed for exchanging bridged packets with the PPP peer.

Bridge/Mode

Write security: 3; Read security: 5

When set to **On** (def), the Express XL/XLT will attempt to negotiate PPP BCP with the PPP peer. Bridging can be used even in route mode only if the PPP peer cannot support certain PPP protocols for that particular routing protocol. See *Bridge/WAN IP Bridge* on page 50 and *Bridge/WAN IPX Bridge* on page 51 for further details.

Connection List/Probe

The Probe feature on the Express XL/XLT is mainly used for allowing a network to have multiple virtual network connections to many destinations using the single ISDN link. The Express XL/XLT can periodically obtain routing information from various locations and retain this in the routing tables, thereby permitting the LAN connection to be aware of the networks at this location. Probe helps keep route tables updated. When a service or network connection is required, the Express XL/XLT can demand dial that location. This can be beneficial for remote IPX workstations that cannot boot up properly without knowing the IPX services that would be in the Express XL/XLT's SAP table.

Probe/Active

Write security: 3; Read security: 5

When set to **Yes**, the Express XL/XLT will periodically dial this profiles dial-out number to get routing and service table updates. The default is **No**.

Probe/Interval

Write security: 3; Read security: 5

This is the time the Express XL/XLT waits between probes. The value is in minutes and ranges from 1 to 240. The default is 15 minutes.

Probe/Update Window

Write security: 3; Read security: 5

This is the time the Express XL/XLT stays connected during a probe. Normally route and service tables are exchanged immediately after connection. However, some routers could wait until their regular RIP or SAP time period has been reached before they advertise their routes or services to the Express XL/XLT. The value is in seconds and ranges from 5 to 180. The default is 5 seconds and assumes that a routing update is received upon connection.

Connection List/PPP

The Express XL/XLT supports the IETF standards for the Point-to-Point Protocol. The PPP state machine running in the Express XL/XLT can be fine-tuned to support many applications that can be employed. The configurable items under this menu can be changed from their default values for special cases.

PPP/Multilink

Multilink PPP allows the two B-channels to be used together for increased bandwidth.

Multilink/Mode

Write security: 3; Read security: 5

When this item is set to **On** (def), Multilink PPP is negotiated with the PPP peer. When **Off**, the Express XL/XLT will only allow one B-channel for this connection.

Multilink/Fragment

Write security: 3; Read security: 5

When this item is set to **Yes** (def), the Express XL/XLT will split outgoing packets greater than 128 bytes into two Multilink fragments and simultaneously transmit them one per B-channel. The receiving PPP peer will then re-assemble them. This decreases the transport delay. However, some legacy equipment might have trouble handling fragmented packets, in which case this option should be set to **No**.

Multilink/BACP

Write security: 3; Read security: 5

The Bandwidth Allocation Control Protocol (BACP) and Bandwidth Allocation Protocol (BAP) are used to enhance Multilink PPP. Together, they allow

phone numbers to be exchanged when more bandwidth is needed and member links to be dropped when bandwidth is to be decreased. When this item is set to **On**, BACP is negotiated with the PPP peer. When **Off**, the Express XL/XLT will not run BACP/BAP but dynamic bandwidth can still be operated.

Certain rules for bandwidth-on-demand apply, depending on whether BACP is negotiated. If BACP is not negotiated, the originator of the call will perform the dynamic bandwidth adjustments on its own. If BACP is negotiated, the decisions are made on either side but the call is always from the originator.

PPP/Compression

Write security: 3; Read security: 5

The Express XL/XLT uses LZS® technology from hi/fn™ (formerly known as STAC) for data compression. The Ascend Communications version of this compression is also supported. The Express XL/XLT will automatically select the type of compression. Compression is negotiated when this item is set to **STAC** (def). No compression will be attempted when set to **None**.

PPP/VJ Compression

Write security: 3; Read security: 5

When this item is set to **On**, the Express XL/XLT will perform TCP/IP header compression known as Van Jacobson compression to the PPP peer. Normally, this is not necessary over ISDN connections and can be set to **Off** (def) to disable it.

PPP/Max Config

Write security: 3; Read security: 5

This value is the number of unanswered configuration-requests that should be transmitted before giving up on a call. The possible values are 5, 10 (def), 15 and 20.

PPP/Max Timer

Write security: 3; Read security: 5

This value is the number of seconds to wait between unanswered configuration-requests. The possible values are 1 sec, 2 secs (def), 3 secs, 5 secs and 10 secs.

PPP/Max Failure

Write security: 3; Read security: 5

Due to the nature of PPP, configuration options may not be agreed upon between two PPP peers. This value is the number of configuration-naks that should occur before an option is configuration-rejected. This allows a connection to succeed that might otherwise fail. The possible values are 5 (def), 10, 15 and 20.

Connection List/Dial Out

The dialing parameters for establishing this connection are defined under this menu.

Dial Out/Number 1

Write security: 3; Read security: 5

This is the first number used for dialing up this connection.

Dial Out/Number 2

Write security: 3; Read security: 5

This is the second number used for dialing a second B-channel when adding bandwidth. If BACP/BAP is negotiated, this number is not necessary. If this number is not specified and BACP/BAP is not used, the **Number 1** number is re-dialed when adding bandwidth.

Dial Out/Call Type

Write security: 3; Read security: 5

The call type can be configured in four different ways:

Speech - Speech directs the call control software to request a Mu-law encoded speech circuit as the bearer capability for the outgoing calls. The speech option is used with an ISDN line configured for voice service. In some areas, voice service costs less than data services. A speech call type does not always guarantee an end-to-end digital connection with some local and long distance carriers.

Audio - Audio directs the call control software to request a 3.1 kHz audio circuit as the bearer capability for the outgoing

calls. The audio option is used with an ISDN line configured for voice service. In some areas, audio service costs less than data services. An audio call type does guarantee a digital end-to-end digital connection.

56K - 56K directs the call control software to request a 64 kbps data circuit that is rate-adapted to 56 kbps. Data 56 kbps is intended for use in circumstances where interoperability with Switched 56 service is desired.

64K (def) - The default call type for ISDN service is Data 64 kbps. This directs the call control software to request an unrestricted 64 kbps circuit.

Dial Out/Redial at 56K

Write security: 3; Read security: 5

Selecting **Yes** (def) causes the Express XL/XLT to re-dial a call at the 56K call type if a 64K call type was unsuccessful. This will not occur if set to **No** or if the original call type was other than 64K.

Dial Out/Delay

Write security: 3; Read security: 5

This is the number of seconds between unsuccessful call attempts made during dial-on-demand or during dynamic bandwidth. The range is between 0 and 255, with a default of 15 seconds.

Dial Out/Connection Timeout

Write security: 3; Read security: 5

This is the amount of time the Express XL/XLT waits for a call to be answered before giving up the attempt. Possible values are 15 secs (def), 30 secs, 1 min, 2 mins and 4 mins.

Dial Out/Attempts

Write security: 3; Read security: 5

This value is the number of attempts the Express XL/XLT will make before giving up on the connection. This is effective for manual dialing or dynamic bandwidth calls only. The range is from 1 (def) to 255.

Dial Out/Initial Channels

Write security: 3; Read security: 5

This is the number of B-channels to dial-up on the initial connection. Possible choices are 1 (def) and 2.

Connection List/Bandwidth

The bandwidth parameters that govern this connection are set here.

Bandwidth/On Demand

The parameters under this menu control the data rates required to change bandwidth.

Bandwidth/Mode

Write security: 3; Read security: 5

When this option is set to **On**, the Express XL/XLT will apply its bandwidth-on-demand features for this Connection List profile. If set to **Off**, none are performed.

Bandwidth/Idle Timeout

Write security: 3; Read security: 5

This is the number of seconds the ISDN line must be idle before hanging up this connection. A value of 0 (def) means the Express XL/XLT will never drop the link based on the idle timer. The range is 0 to 255.

Bandwidth/Preempt Time

Write security: 3; Read security: 5

Occasionally an application will require to connect to a different location before the current connection's idle timer has timed out. This causes the application to have to wait for idle timer before it can use the B-channel. This preempt time allows the Connection List that is active to be dropped sooner than the normal idle time. The value ranges from 0 to 255 and is in seconds. When bandwidth is needed for another application, the idle timer is compared to this preempt time. If the idle timer is greater, the connection is preempted. If set to 255 (def), the connection is never preempted. If set to 0, the connection is disconnected immediately when another application is requested.

Bandwidth/Upper Threshold

Write security: 3; Read security: 5

This is the percentage of bandwidth that must be at least present on one B-channel before a second B-channel is added. The range is 0 to 100 and is in percentages. The default is 80%, which is equivalent to 51.2 kbps. See the section *Bandwidth/Samples* (below) for more information on how the bandwidth rate is calculated.

Bandwidth/Lower Threshold

Write security: 3; Read security: 5

This is the percentage of maximum bandwidth the bit rate must go below on two B-channels before one is dropped. The range is 0 to 100 and is in percentages. The default is 30%, which is equivalent to 38.4 kbps. See the section *Bandwidth/Samples* (below) for more information on how the bandwidth rate is calculated.

Bandwidth/Min Channels

Write security: 3; Read security: 5

This represents the minimum number of B-channels that must be up for this Connection List profile. This value ranges from 0 to 2. The default is 0.

Bandwidth/Max Channels

Write security: 3; Read security: 5

This represents the maximum number of B-channels this Connection List profile can have. The allowed values are 1 and 2. The default is 2. A value of 1 means that no extra bandwidth can be obtained for this connection.

Bandwidth/Samples

The parameters under this menu control the rate at which the Express XL/XLT samples the bandwidth on the B-channel(s).

Samples/Sample Rate

Write security: 3; Read security: 5

This is the time between samples used for calculating data rates on the ISDN call. The value is in seconds and ranges from 1 to 255. The default is 5 seconds.

Samples/Samples

Write security: 3; Read security: 5

This is the number of WAN data rate samples taken before a decision to change bandwidth is performed. The range is 1 (def) to 255 samples.

Samples/Time Between Changes

Write security: 3; Read security: 5

This value is the minimum time between bandwidth changes for this Connection List profile. The range is 0 to 255 seconds. The default is 60 seconds.

Connection List/Filters

The Express XL/XLT can block packets in and out of a WAN port by use of the filters. These filters are set up on a per-Connection List profile basis. They are set up in two steps: 1) define the types of packets that would be of interest in the **Configuration/Security/Filter Defines** menu, and 2) set up the filter type and combination of defines that will cause a packet block.

Typical example of a filter setup:

Filters/WAN-to-LAN (In)

Write security: 2; Read security: 5

The packets which come into the Express XL/XLT can be filtered in three ways:

Disabled (def) - Turns off packet input filtering. No incoming packets are blocked.

Block All - All incoming packets from the WAN are blocked except as defined in the **Filters/In Exceptions** list.

Forward All - All incoming packets from the WAN are not blocked except as defined in the **Filters/In Exceptions** list.

Filters/In Exceptions

Write security: 2; Read security: 5

This is a list of up to 32 filter entries which can be combined using the operations field. The operations are performed in the order they appear on the list.

Active - Turns this entry active when set to **On**.

Type - Selects the filter define list to reference:

- MAC** - from the **Configuration/Security/Filter Defines/MAC Filter Defines** list.
- Pattern** - from the **Configuration/Security/Filter Defines/Pattern Filter Defines** list.
- IP** - from the **Configuration/Security/Filter Defines/IP Filter Defines** list.
- IPX** - from the **Configuration/Security/Filter Defines/IPX Filter Defines** list.

Filter List Name - Selects between filters defined in the list.

Next Oper - The next operation to use to combine with the next filter in the list:

- END** - the last filter to combination.
- AND** - logically AND this filter with the next filter in the list.
- OR** - logically OR this filter with the next filter in the list.

Filters/LAN-to-WAN (Out)

Write security: 2; Read security: 5

The packets which come out toward the WAN from the Express XL/XLT can be filtered in three ways:

Disabled (def) - Turns off packet output filtering. No outgoing packets are blocked.

Block All - All outgoing packets to the WAN are blocked except as defined in the **Filters/Out Exceptions** list.

Forward All - All outgoing packets to the WAN are not blocked except as defined in the **Filters/Out Exceptions** list.

Filters/Out Exceptions

Write security: 2; Read security: 5

This is a list of up to 32 filter entries. The setup is exactly the same as the **Filter/In Exceptions** list.

Filters/Demand Dial

Write security: 2; Read security: 5

The demand dial filters have two purposes: 1) cause the Express XL/XLT in Bridge mode to dial this Connection List profile, and 2) determine which traffic will cause the idle timer to be reset, keeping the connection active. The latter is used in Bridge or IP/IPX Router mode. The idle timer is a timer in the Express XL/XLT which continually increments until it reaches the idle timeout parameters value set in the Connection List, at which point the connection is hung-up.

When this filter is enabled, direct control can be placed over which packets are considered as demand and which are ignored. Packets that are ignored cause a connection not to be dialed and do not reset the idle timer of an active connection. This is especially helpful for bridged connections since bridges cannot easily distinguish true demand traffic from overhead traffic like certain broadcast and multicast packets. There are three possible selections for this parameter:

Disabled (def) - Turns off demand dial filtering. No packets cause demand dialing for this profile and all outgoing and incoming packets reset the idle timer.

Ignore All - When connected in any mode (Bridge, IP Router, or IPX router), the idle timer is reset only when there is a match in the **Filters/Dem Dial Exceptions** list. When not connected in Bridge mode only, causes the Express XL/XLT to dial using this Connection List profile if there is a match in the **Filters/Dem Dial Exceptions**.

Demand All - When connected in any mode (Bridge, IP Router, or IPX router), the idle timer is always reset except when there is a match in the **Filters/Dem Dial Exceptions** list. When not connected in Bridge mode only, causes the Express XL/XLT to dial using this Connection List profile if there is NOT a match in the **Filters/Dem Dial Exceptions** list.

Filters/Dem Dial Exceptions

Write security: 2; Read security: 5

This is a list of up to 32 filter entries. The setup is exactly the same as the **Filter/In Exceptions** list.

Configuration/Management

The Express XL/XLT can be managed using Telnet, Simple Network Management Protocol (SNMP), or the maintenance port. SNMP support is limited to MIB definitions. See *Appendix C* on page 139 for a description of the MIBs supported by the Express XL/XLT. Each of the three methods can be protected using authentication. Figure 3-9 shows the Configuration/Management menu.

```

Express XL/Configuration/Management
System Info      Telnet      [+]
WAN              SNMP        [+]
IP               Maint Port  [+]
IPX
Bridge
Security
Connection List
Management
MODE: IP IPX Bridge LOOP: Link down B1: Idle B2: Idle
Z=help 9:27_

```

Figure 3-9
Configuration/Management Screen

Management/Telnet

Any telnet client application can bring up a session to the Express XL/XLT's Telnet server using the standard telnet TCP port. Only one session is supported at a time. All sessions require a user name and password.

Telnet/Server Access

Write security: 2; Read security: 5

This option must be set to **On** (def) to access the Express XL/XLT via Telnet. Turning it **Off** means that access is denied.

Telnet/User List

Up to four users can be configured for access to the Express XL/XLT. Each user can be assigned a privilege and time out.

User List/Name

Write security: 1; Read security: 3

A text string of the user name for this session.

User List/Authen Method

Write security: 1; Read security: 3

The user can be authenticated in two ways:

Password - The Password field is used to authenticate the user.

Radius - The Radius client is used for authenticating the user.

User List/Password

Write security: 0; Read security: 3

When the authenticating method is password, this text string is used for the password.

User List/Idle Time

Write security: 1; Read security: 3

When set to non-zero, the session is automatically logged out when no activity occurs for this amount of time. The range is 0 to 255 and is in minutes. The default is 10 minutes, and a setting of 0 will never time out the session. When a timeout occurs during an edit session, all changes are saved.

User List/Level

Write security: 0; Read security: 1

This is the security level privilege that is assigned for this user. See *Security Levels* on page 33 for an explanation of what those levels imply. Level 0 is the default.

Management/SNMP

The Express XL/XLT is an SNMP agent. It can respond to Get-Requests and generate traps. These two lists set up the manager, communities, and levels. See *Appendix C* on page 139 for more information on SNMP.

SNMP Access

Write security: 3; Read security: 5

When set to **No**, SNMP access is denied. When set to **On** (def), the Express XL/XLT will respond to SNMP managers based on the following lists.

SNMP/Communities

This list is used to set up to eight SNMP communities names that the Express XL/XLT will allow. Factory default sets the community "public" with "Get" privileges.

Communities/Name

Write security: 1; Read security: 3

This is a text string for the community name.

Communities/Privilege

Write security: 1; Read security: 3

The access for this manager can be assigned three levels.

None - No access is allowed for this community or manager.

Get - Manager can only read items.

Get/Set - Manager can read and set items.

Communities/Manager IP

Write security: 1; Read security: 3

This is the IP address of SNMP manager. If set to 0.0.0.0, any SNMP manager can access the Express XL/XLT for this community.

SNMP/Traps

The Express XL/XLT can generate SNMP traps. See *Appendix C* on page 139 for trap types supported. This list allows up to four managers to be listed to receive traps.

Traps/Manager Name

Write security: 2; Read security: 4

This is the text string describing the name of the entry. It is intended for easy reference and has no bearing on the SNMP trap function.

Traps/Manager IP

Write security: 2; Read security: 4

This is the IP address of the manager that is to receive the traps.

Management/Maint Port

The Express XL/XLT has an EIA-232 connector on the back of the unit. The setup for that port is under this menu.

Maint Port/Password Protect

Write security: 0; Read security: 1

When set to **No**, the maintenance port is not password protected. When **On** (def), the Express XL/XLT will prompt for a password upon startup.

Maint Port/Password

Write security: 0; Read security: 1

This is the text string that is used for comparison when password protecting the maintenance port. By default, no password is entered.



NOTE

The security level for the maintenance port is always set to 0. This gives full access to all menus.

Maint Port/Baud Rate

Write security: 5; Read security: 5

This is the asynchronous rate that the maintenance port will run. The possible values are 300, 1200, 2400, 4800, 9600 (def), 19200, 38400, 57600, 115200.

Maint Port/Data Bits

Write security: 5; Read security: 5

This is the asynchronous bit rate that the maintenance port will run. The possible values are 7 or 8 (def) bits.

Maint Port/Parity

Write security: 5; Read security: 5

This is the asynchronous parity that the maintenance port will run. The possible values are **None** (def), **Odd**, or **Even**.

Maint Port/Stop Bits

Write security:5; Read security:5

This is the stop bit used for the maintenance port. The possible values are 1 (def), 1.5 or 2.

Configuration/Terminal Mode

This is an activator which places the Express XL/XLT terminal session into a command prompt mode. All menu options are accessible during this mode. See *Appendix E* on page 145 for the command structure and command list. Type **exit** to leave the terminal mode and return to the menus.

DIAL MENU

The Dial menu is used for dialing the Connection List profile setup under **Configuration/Connection List** and for checking the status of each Connection List. This list is in the same order as the Connection List entries. Figure 3-10 shows the Dial menu.

Num	Description	Dial	Hang Up	Status	Channels
1	DEFAULT	<+>	<+>	no call	0

MODE: IP IPX Bridge LOOP: Link down B1: Idle B2: Idle
Z=help 9:30

Figure 3-10
Dial Screen

Dial/Description

Read security: 5

This read-only field is the name entered for the profile under **Configuration/Connection List/Description**.

Dial/Dial

Write security: 4; Read security: 5

This is an activator used for dialing the phone numbers in the profile. Place the cursor over the field and press **Enter** to activate the dialing function.

Dial/Hang Up

Write security: 4; Read security: 5

This is an activator used for hanging up a Connection List entry. It also removes retained routes from the IP and IPX routing tables when the call is not connected. Place the cursor over the field and press **Enter** to activate the hang up function.

Dial/Status

Read security: 5

This reflects the current status of the call:

No call - No call is active for this Connection List profile.

Connecting - Outgoing call is being placed for this profile.

Ringing - Incoming call is being answered with this profile.

PPP negotiating - Call is connected and is bringing up PPP.

Active - A session with this profile is active.

Dial/Channels

Read security: 5

This is the number of B-channels being used for this call.

Dial/Number 1

Read security: 5

This read-only field is the number entered for the profile under **Configuration/Connection List/Dial Out/Number 1**.

Dial/Number 2

Read security: 5

This read-only field is the number entered for the profile under **Configuration/Connection List/Dial Out/Number 2**.

STATUS MENU

The Express XL/XLT's Status menu contains comprehensive status and diagnostic information used in verifying configuration and identifying problems. The menus are divided into protocol types and sessions. Figure 3-11 shows the Status menu.

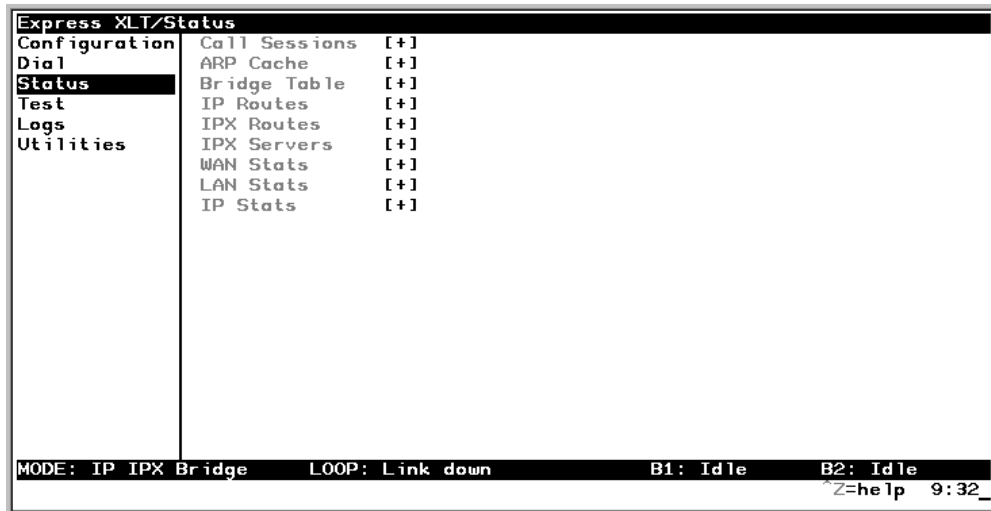

Figure 3-11
Status Screen

Status/Call Sessions

This menu contains the current status of all dial-in sessions and spanning tree ports.

Call Sessions/Session1 and Call Sessions/Session2

Read security: 5

The Express XL/XLT can support up to two active connections at one time. These two menus reflect the results of PPP negotiations, user name, time connected, idle timer, and data rates for the session.

PPP Links - Reflects LCP layers active

BCP - Shows UP if PPP Bridge Control Protocol has negotiated successfully

IPCP - Shows UP if PPP IP Control Protocol has negotiated successfully

IPXCP - Shows UP if PPP IPX Control Protocol has negotiated successfully

CCP - Shows UP if PPP Compression Control Protocol has negotiated successfully

BACP - Shows UP if PPP Bandwidth Allocation Control Protocol has negotiated successfully

User - Displays the user name of the PPP peer

Number(s) - Shows the phone number dialed if outgoing call or caller ID if incoming call.

Connect Time - Shows the date and time when the call last connected.

Up Time - Displays how long the call has been connected.

Idle Timer - Current value of the idle timer (number of seconds since filtered packet was passed through).

Tx Pkts - Number of packets transmitted

Rx Pkts - Number of packets received

Tx Bytes - Number of bytes transmitted

Rx Bytes - Number of bytes received

Tx Rate - Current application data transmission rate

Rx Rate - Current application data reception rate

Tx Link Rate - Current actual data transmission rate

Rx Link Rate - Current actual data reception rate

Tx Comp Ratio - Current transmission compression ratio

Rx Comp Ratio - Current reception compression ratio

Call Sessions/Spanning Tree

Read security: 5

When Bridge mode and Spanning Tree mode are active, this reflects the current state of the LAN and WAN ports. The following can appear:

Off - Appears when spanning tree mode is disabled

Disabled - Port is not connected (for WAN) or disabled in configuration

Listening - Port is in the listening state

Learning - Port is in the learning state

Forwarding - Port is in the forwarding state with the following possible properties:

root - is the root port

designated - is designated port

Blocking - Port is in the blocked

Status/ARP Cache

Read security: 5

This lists the contents of the Express XL/XLT's ARP table. All resolved cache entries time out after 20 minutes. Unresolved entries time out in 3 minutes.

ARP Cache/IP Address - IP address used for resolving MAC address

ARP Cache/MAC Address - Ethernet address resolved
(0=no resolution)

ARP Cache/Time - Minutes since entry was first entered

Status/Bridge Table

Read security: 5

This lists the contents of the Express XL/XLT's bridge table.

Bridge Cache/MAC Address - Ethernet address for device learned

Bridge Cache/Port - Port device learned from: LAN, WAN0, or WAN1

Bridge Cache/TTL - Seconds until address is removed from table

Status/IP Routes

Read security: 5

This lists the contents of the Express XL/XLT's IP router table.

IP Routes /IP Address - Network or host destination address

IP Routes /Netmask - Network mask applied to the destination address

IP Routes /Gateway - Host or router to receive this packet

IP Routes /Port - Port gateway is located on:

local - sent directly to the Express XL/XLT router

eth0 - Express XL/XLT's ethernet port

wan0 - Express XL/XLT's first PPP bundle

wan1 - Express XL/XLT's second PPP bundle

idle - non-connected or "spoofed" route used for dial-on-demand

IP Routes /Use - Number of times the Express XL/XLT has referenced the route

IP Routes/Flags - Important tags associated with this route entry

H - route is a host route

G - route is a gateway route

D - route learned dynamically from RIP

I - route learned from an ICMP redirect

P - route is private and is not advertised with RIP

T - route is to a triggered port (updates only when table changes)

IP Routes/Hops - Number of routers that must go through to get to destination. Ranges from 0-15 or 16 for infinite (can't get there from here).

IP Routes/TTL - Seconds until address is removed from table or "zombied." Value of 999 means route is static.

Status/IPX Routes

Read security: 5

This lists the contents of the Express XL/XLT's IPX router table.

IPX Routes /Network - Network destination address

IPX Routes /Gateway - Node or Ethernet address of gateway to receive this packet

IPX Routes /Port - Port gateway is located on:

local - sent directly to the Express XL/XLT router

eth0 - Express XL/XLT's ethernet port

wan0 - Express XL/XLT's first PPP bundle

wan1 - Express XL/XLT's second PPP bundle

idle - non-connected or "spoofed" route used for dial-on-demand

IPX Routes /Use - Number of times the Express XL/XLT has referenced the route

IPX Routes/Hops - Number of routers that must go through to get to destination. Ranges from 0-15 or 16 for infinite (can't get there from here).

IPX Routes/Ticks - Router determined value for representing time packets take to reach the network destination. One tick is equivalent to one-eighteenth of a second.

IPX Routes/TTL - Seconds until address is removed from table. Value of 999 means route is static.

Status/IPX Servers

Read security: 5

This lists the contents of the Express XL/XLT's IPX server table.

IPX Servers/Type - The server type

IPX Servers/Name - The server name

IPX Servers/Network - The server network address

IPX Servers /Address - The servers node address

IPX Servers/Socket - The servers socket address

IPX Servers/Hops - Number of routers that must go through to get to server. Ranges from 0-15 or 16 for infinite.

IPX Servers/TTL - Seconds until address is removed from table. Value of 999 means server is static.

Status/WAN Stats

Read security: 5

This menu contains generic WAN statistics on both B-channel HDLC hardware ports.

HDLC Port 1

Tx Bytes - total number of raw bytes sent out HDLC port 1

Rx Bytes - total number of raw bytes received in HDLC port 1

Rx CRCs - total number of CRC errors detected on HDLC port 1

HDLC Port 2

Tx Bytes - total number of raw bytes sent out HDLC port 2

Rx Bytes - total number of raw bytes received in HDLC port 2

Rx CRCs - total number of CRC errors detected on HDLC port 2

Clear Counts - When activated, clears all WAN stat counts

Status/LAN Stats

Read security: 5

This menu contains statistics for the Ethernet port.

Tx Packets - Packets transmitted out the Ethernet port

Rx Packets - Packets received from the Ethernet port

Tx Errors - Total transmit errors encountered on Ethernet port

Single Collisions - total single collisions before successful transmission

Multiple Collisions - total multiple collisions before successful transmission

Excessive Collisions - total collisions that resulted in packet being dropped

Deferred Transmissions - total packets deferred due to collisions

Carrier Sense Errors - total carrier sense errors encountered (no link integrity)

Rx Errors - Total packets received in error and dropped

CRCs - total packets detected with CRC errors

Giants - total packets received that were greater than 1518 bytes

Runts - total packets received that were less than 64 bytes

Rx Collisions - total collision occurred during reception

Clear Counts - When activated, clears all LAN Stat counts.

Status/IP Stats

Read security: 5

This menu contains IP statistics that can be useful when diagnosing problems.

All are taken from the SNMP MIB-2 variables.

TCP failed attempts

TCP passive connections

TCP current connections

TCP segments sent

TCP segments received

Total TCP resets

Active TCP connections

Total TCP retransmits

UDP datagrams sent

No application at dest. port

UDP datagrams received

UDP bad packets

ICMP redirected messages
ICMP packet errors
ICMP timeouts received
ICMP messages sent
ICMP messages received
ICMP specif if errors
IP datagrams reassembled
IP datagrams sent
IP datagrams received
Total forwarded datagrams
IP reassembly timeout
Discarded routing entries
Total IP fragments
Failed fragments
IP reassembly failures
Disassembled fragments
Errorfree discards
Routeless discards
Default TTL
Bad IP addresses
Successful fragments
Bad header packets
Sent datagrams to upper layers
Datagrams discarded
Bad protocol discards

Clear Counts - clears all IP stats

TEST MENU

The Express XL/XLT's Test menu contains built in tests that can be used to diagnose problems. Figure 3-12 shows the Test menu screen.



Figure 3-12
Test Screen

The following tests can be run:

Test Menu/Echo Request

Write security: 4, Read security: 5

When activated, the echo request test will begin sending continuous PPP echo request packets to any open LCP ports. Results are displayed on the screen. At least one PPP session must be up.

Test Menu/Dial Self

Write security: 4, Read security: 5

The dial self-test can be activated to check the ISDN parameters set under the **Configuration/WAN/ISDN** menu. This test starts the Express XL/XLT dialing itself using the configured LDN numbers. Once a connection is established, it will send PPP echo request until the test is terminated. Any error or success messages will appear on the screen.

LOGS MENU

The Logs menu contain logs displaying important information about the running condition of the Express XL/XLT. The logs can be set to capture diagnostics of error conditions only by way of a log level. The levels are divided up as follows:

- level 0 - Fatal event (causes reset)
- level 1 - Critical event
- level 2 - Error event
- level 3 - Warning event
- level 4 - Notify event
- level 5 - Informational event
- level 6 - Debugging event

Figure 3-13 shows the Logs menu. The three logs available are listed after the figure.



Figure 3-13
Logs Screen

Logs/Sys log Host

Set this to the IP address or domain name (if DNS configured) of the sys log host device. All log events are sent to this device.

Logs/PPP Log

Information pertaining to the PPP negotiation and authentication will be logged here.

PPP Log/Active

When set to **Yes** (def), PPP events below or equal the log level are logged into the log.

PPP Log/Wrap

When set to **Yes** (def), new PPP events will overwrite old PPP events when the log is full. All logging will stop when the log is full and set to **No**.

PPP Log/Level

In order to log events, they must be at or below this level. Range is 0 to 6. The default is 3.

PPP Log/View

This menu displays the log list. The fields are as follows:

Date/Time - Date and time event occurred.

Level - Level associated with this event (0-6).

Message - Text message for this event. If message is too long to fit on the line, another event appears below it continuing the message.

PPP Log/Clear

This clears the log when activated.

Logs/Call Log

Information pertaining to the call placement and answering over the ISDN link.

Call Log/Active

When set to **Yes** (def), call events below or equal the log level are logged into the log.

Call Log/Wrap

When set to **Yes** (def), new Call events will overwrite old Call events when the log is full. All logging will stop when the log is full and set to **No**.

Call Log/Level

In order to log events, they must be at or below this level. Range is 0 to 6. The default is 3.

Call Log/View

This menu displays the log list. The fields are as follows:

Date/Time - Date and time event occurred.

Level - Level associated with this event (0-6).

Message - Text message for this event. If message is too long to fit on the line, another event appears below it continuing the message.

Call Log/Clear

This clears the log when activated.

Logs/Network Log

Information pertaining to the routing protocols is placed in this log.

Network Log/Active

When set to **Yes** (def), call events below or equal the log level are logged into the log.

Network Log/Wrap

When set to **Yes** (def), new Network events will overwrite old Network events when the log is full. All logging will stop when the log is full and set to **No**.

Network Log/Level

In order to log events, they must be at or below this level. Range is 0 to 6. The default is 3.

Network Log/View

This menu displays the log list. The fields are as follows:

Date/Time - Date and time event occurred.

Level - Level associated with this event (0-6).

Message - Text message for this event. If message is too long to fit on the line, another event appears below it continuing the message.

Network Log/Clear

This clears the log when activated.

UTILITIES MENU

The Express XL/XLT has utilities embedded in it to help in managing and testing the network and to facilitate software upgrades. Figure 3-14 shows the Utilities menu.

```

Express XL/Utilities
Configuration Ping      [+]
Dial          Telnet Client  [+]
Status       Upgrade Menu  [+]
Test         Exit        <+>
Logs
Utilities

MODE: IP IPX Bridge   LOOP: Link down   B1: Idle   B2: Idle
                    *Z=help  9:35_

```

Figure 3-14
Utilities Screen

Utilities/Ping

Write security: 4; Read security: 5

The ping menu is used to send ICMP ping messages to hosts. The following items are under the this menu:

Start/Stop - Activator to start and cancel a ping test.

Host Address - IP address or domain name (if DNS is configured) of device to receive the ping

Size - Total size of ping to send. Range is 40 (def) to 1500 bytes.

of Packets - Total packets to send every two seconds

of Transmits - Total packets sent (read only)

of Receives - Total packets received (read only)

% Loss - Percentage loss based on ping returned form host (read only)

Utilities/Telnet Client

Write security: 4; Read security: 5

The Telnet menu can be used to activate the telnet client function in the Express XL/XLT.

Host - IP address or domain name (if DNS is configured) of telnet server.

Activate - Starts telnet client function. The key combination **Control]** cancels the session.

Utilities/Upgrade Menu

Write security: 2; Read security: 3

The Express XL/XLT's firmware can be upgraded using this menu.

Upgrade/Transfer Method

The two methods for upgrading are **TFTP** and **XMODEM**. **TFTP** requires a TFTP server running somewhere on the network. The Express XL/XLT starts a TFTP client function which gets the upgrade code from the TFTP server. Selecting **XMODEM** will load the upgrade code through the maintenance port using any PC terminal emulator with xmodem capability.

Upgrade/TFTP Host

This is required when the transfer method is TFTP. It is the IP address or domain name (if DNS is configured) of the TFTP server.

Upgrade/Filename

This is required when the transfer method is TFTP. It is the case-sensitive file name which is the upgrade code.

Upgrade/Status

This appears when TFTP is used. It displays the status of the transfer as it happens. Any error or success message will be displayed here.

Upgrade/Start Transfer

This activator is used when the configurable items in this menu are complete.

*Once started, the Express XL/XLT will prompt for erasing the flash. When the flash is erased and the upgrade transfer fails, do not turn off the unit. Retry the transfer until successful. Otherwise, if power is removed before upgrade has finished, the upgrade will have to occur from the maintenance port using XMODEM. If this happens, set a PC terminal emulation program to 9600 baud and attach to the Express XL/XLT's maintenance port. Press **Return** to display a simple terminal menu for upgrading. This menu appears when the flash code has been erased or is corrupt. The menu will also appear if you power up and hold down the **SELECT** key for at least five seconds.*



NOTE

Upgrade/Abort Transfer

Use this activator to cancel any TFTP transfer in progress.

Upgrade/TFTP Server

Setting this to **Yes** allows another Express XL/XLT to upgrade its code using TFTP client. This, in effect, turns on the Express XL/XLT TFTP server function and allows its code to be “cloned.” Setting to **No** (def) will deny any request from TFTP clients.

Utilities/Exit

Write security: 5; Read security: 5

Activating this feature will exit the terminal session from the maintenance port or telnet. It is equivalent to the key combination **Control L**.

Chapter 4

Troubleshooting

When the Express XL/XLT powers up, it performs an internal self-test. This takes about 10 seconds. At the end of the test, the PWR LED should remain on.

IF SELF-TEST FAILS

If the PWR LED is not on or continuously flashes, the following steps will verify whether or not the problem can be fixed locally.

1. Ensure the Express XL/XLT is receiving power.
2. Power off the Express XL/XLT while holding down **SELECT** and **TEST**; then power back up. This will reset all internal settings to their factory default.
3. Continue holding the **SELECT** and **TEST** buttons until the Loop LED flashes once.
4. If the Express XL/XLT still does not pass self-test, call ADTRAN Technical Support for assistance. See the inside back cover of this manual for information on contacting ADTRAN.

IF THE EXPRESS XL/XLT DOES NOT READ READY

When the Express XL/XLT has been set up and connected to a line, but the Loop LED does not remain on after a few minutes, proceed with the following steps:

1. Cycle power on the Express XL/XLT, leaving it off for a minimum of two seconds; then turn the power on for one minute to ensure the Loop LED still doesn't turn on.

2. Disconnect the Express XL/XLT. From a functioning voice phone, call the local directory number(s) provided with your line. Calling a good ISDN line with nothing connected usually results in a ring or fast busy tone. If someone answers, or you get a not-in-service intercept, there is probably something wrong with the translation of the line. The phone service provider should be able to help.
3. If the Loop LED still remains off, then there is a physical problem with the phone line (more than likely, a problem with the Layer 1 setup). The problem is in one or more of the places listed below:
 - The Express XL/XLT software setup
 - The Express XL/XLT hardware
 - The wiring on your premises
 - The telephone service provider's wiring
 - The telephone service provider's hardware
 - The telephone service provider's software setup

To isolate the problem, perform the following procedure:

- A. Ensure the line is plugged into the Express XL/XLT connector marked **ISDN BRI U** on the back of the Express XL/XLT.
- B. Make sure the Express XL/XLT is configured for Dial line service.
- C. If possible, try another piece of functioning ISDN equipment with a U-interface on the line.
- D. Talk to your service provider and ensure you have an ISDN Basic Rate U-Interface with 2B1Q line coding. (Wrong options are an S or T interface or AMI line coding).
- E. Ensure that your phone line is connected to the actual telephone line (U-interface) provided by your telephone company. Make sure your line is not connected through another piece of equipment such as an NT1 in a wiring closet.
- F. Make sure nothing else is bridged across the line pair.

- G. With a minimum of extra wiring, try connecting to the line pair at the point where the service provider's wiring ends.
 - H. With the Express XL/XLT connected to the line and powered up, talk to your service provider's repair group and inform them that your ISDN basic rate line has a physical Layer 1 problem. Ask them to check the line. Tell them that you have an NT1-like device at the end of the line.
4. If the *Loop Status* in the Express XL/XLT Status menu continuously reads **Getting TEI #1**, then the Express XL/XLT is physically connected to your local telephone service provider but is unable to establish logical layer 2. The problem is in one or more of the places listed below:
- The Express XL/XLT software setup
 - The telephone service provider's software setup
 - Hardware configuration, if the line is extended from the switch

To isolate the problem, perform the following procedure:

- A. Ensure the Express XL/XLT is setup for the correct switch type.
- B. Ensure the quality of your line is satisfactory by checking for near and far end block errors (NEBEs and FEBEs). If the counts are non-zero, there may be a physical link problem as described in step 3.
- C. If possible, try another piece of functioning ISDN equipment with a U-interface on the line.
- D. With the Express XL/XLT connected to the line and powered up, talk to your service provider's repair group and tell them you have an ISDN basic rate line that appears physically okay but has no terminal endpoint identifier (TEI). Ask them to check the line translation and ensure that the line supports dynamic TEI allocation. Tell them that you have an NT1 and terminal adapter device connected to the line.

5. If the *Loop Status* in the Express XL/XLT Status menu continuously reads **Register SPID #1**, then the Express XL/XLT is physically connected to your local telephone service provider and has established logical layer 2. The Express XL/XLT is unable to establish layer 3. The problem is in one or both of the following places:
- The Express XL/XLT software setup
 - The telephone service provider's software setup

To isolate the problem, perform the following procedure:

- A. Ensure the Express XL/XLT is set up for the correct switch type.
- B. Make sure the line is multipoint.
- C. Make sure the Express XL/XLT is set up with the correct SPID and LDN. For example:

```
SPID1 = 20572270460101
SPID2 = 20572270470101
LDN 1 = 7227046
LDN 2 = 7227047
```

- D. If possible, try another piece of functioning ISDN equipment with a U-interface on the line.
- E. With the Express XL/XLT connected to the line and powered up, talk to your service provider's repair group and tell them you have an ISDN basic rate line that appears physically okay but is unable to register its SPID(s). Ask them to check the line translation, ensure the line supports dynamic TEI allocation, and verify the SPIDs. Tell them that you have an NT1 and terminal adapter device connected to the line.

6. If the *Loop Status* in the Express XL/XLT Status menu continuously reads **Getting TEI #2**, the Express XL/XLT has completely initialized the first phone number but is unable to establish logical layer 2 for the second phone number. The problem is in one or both of the following places:
 - The Express XL/XLT software setup
 - The telephone service provider's software setup

To isolate the problem, perform the following procedure:

- A. Ensure the line is multipoint with two phone numbers.
- B. Ensure that the Express XL/XLT is set up with the correct SPID and LDN. For example:

```
SPID1 = 20572270460101
SPID2 = 20572270470101
LDN 1 = 7227046
LDN 2 = 7227047
```

- C. Try swapping SPID1 with SPID2 and LDN1 with LDN2. Determine if the problem is the second phone number or the quantity of phone numbers.
 - D. If possible, try another piece of functioning ISDN equipment with a U-interface on the line.
 - E. With the Express XL/XLT connected to the line and powered up, talk to your service provider's repair group and tell them you have an ISDN basic rate line that appears physically okay but is unable to register its SPID(s). Ask them to check the line translation, ensure the line supports dynamic TEI allocation, and verify the SPIDs. Tell them that you have an NT1 and terminal adapter device connected to the line.
7. If the *Loop Status* in the Express XL/XLT Status Menu continuously reads **Register SPID #2**, the Express XL/XLT has completely initialized the first phone number but is unable to establish logical layer 3 for the second phone number. The problem is in one or both of the following places:
 - The Express XL/XLT software setup
 - The telephone service provider's software setup

To isolate the problem, perform the following procedure:

- A. Ensure the line is multipoint with two phone numbers.
- B. Ensure that the Express XL/XLT is set up with the correct SPID and LDN. For example:

```
SPID1 = 20572270460101
SPID2 = 20572270470101
LDN 1 = 7227046
LDN 2 = 7227047
```

- C. Try swapping SPID1 with SPID2 and LDN1 with LDN2. Determine if the problem is with the second phone number or the quantity of phone numbers.
- D. If possible, try another piece of functioning ISDN equipment with a U-interface on the line.
- E. With the Express XL/XLT connected to the line and powered up, talk to your service provider's repair group and tell them you have an ISDN basic rate line that appears physically okay but is unable to register its SPIDs. Ask them to check the line translation, ensure the line supports dynamic TEI allocation, and verify the SPIDs. Tell them that you have an NT1 and terminal adapter device connected to the line.

IF YOU ARE UNABLE TO CONNECT CALLS

See Table 4-A for corrective actions if you cannot connect calls.

Table 4-A
Troubleshooting Calls

Condition	Corrective Action
The Loop LED remains on, but calls cannot be placed.	Most likely a problem exists in the software setup (translation) at the CO switch, or the network setup in the Express XL.
Local voice calls can be transmitted, but data calls to the same exchange cannot.	The line is probably not set up to support data calls.
Local data calls go through, but long distance data calls do not.	Ensure the far end is working. If not already doing so, place the call explicitly specifying the prefix of the long distance service (for example, 10288 for AT&T). If this does not work, then most likely the problem is that the long distance service provider is not providing long distance access.
Single B-channel calls can be made, but two B-channel calls cannot.	<p>There is most likely a problem in the software setup (translation) at the CO switch, or the network setup in the Express XL.</p> <p>If the line has two phone numbers, make sure the second SPID and LDN are entered correctly in SPID2 and LDN2 in the Express XL.</p> <p>Check with the local service provider to ensure that the line supports two data calls. The Express XL status log buffer shows what sequence of events occurred. What you need to know is which piece of equipment first caused the Multilink PPP process to terminate. The status logs from both ends may be necessary to determine this.</p>

Chapter 5

Specifications

SPECIFICATIONS AND FEATURES

This section describes the standard specifications and features incorporated in the Express XL/XLT.

Network Interface

RJ-45 for ISDN Basic Rate U-Interface or RJ-45 for leased 2B1Q service.

Ethernet Interface (LAN)

Ethernet/IEEE 802.3 10BaseT.

Switch Compatibility

- AT&T 5ESS
- NTI DMS-100
- National ISDN-1

POTS Interface

- Maximum REN = 4
- Caller ID
- Ringing Signal Amplitude = 185 Vp-p (+/- 5V)
- Ringing Signal Frequency = 20 Hz (+/- 3 Hz)
- Supports 3 phones
(18 mA loop current each) at 1,000 ft, 24 AWG
- Supports 2 phones
(26 mA loop current each) at 1,000 ft, 24 AWG
- Supports 1 phone
(49 mA loop current each) at 1,000 ft, 24 AWG
- Supports 4 phones
(14 mA loop current each) at 600 ft, 24 AWG
- Supports 3 phones
(18 mA loop current each) at 600 ft, 24 AWG

- Supports 2 phones
(27 mA loop current each) at 600 ft, 24 AWG
- Supports 5 phones
(12 mA loop current each) at 300 ft, 24 AWG
- Supports 4 phones
(15 mA loop current each) at 300 ft, 24 AWG
- Supports 3 phones
(19 mA loop current each) at 300 ft, 24 AWG
- Supports 2 phones
(28 mA loop current each) at 300 ft, 24 AWG
- Supports 1 phone
(53 mA loop current each) at 300 ft, 24 AWG
- Supports 5 phones
(12 mA loop current each) at 100 ft, 24 AWG
- Supports 4 phones
(15 mA loop current each) at 100 ft, 24 AWG
- Supports 3 phones
(20 mA loop current each) at 100 ft, 24 AWG
- Supports 5 phones (13 mA loop current each) at 8 ft, 24 AWG
- Supports 4 phones (16 mA loop current each) at 8 ft, 24 AWG
- Supports 3 phones (21 mA loop current each) at 8 ft, 24 AWG

Display

Available through terminal interface or Telnet session

Environmental

- Operating Temperature: 0 - 50 °C
- Storage Temperature: 20 - 70 °C
- Relative Humidity: Up to 95% non-condensing

Physical

- Dimensions: 1-9/16" H x 6-1/2" W x 8-1/4" D
- Weight: 2.5 lbs

Power

- 120 VAC, 60 Hz, 7.5 W typical dissipation with POTS

Appendix A

Loop Status Messages

The Express XL/XLT displays current loop status of the ISDN on the bottom center line of the terminal screen. The following messages are defined:

AT&T-5ESS Ready

The ISDN link layers 1 through 3 are up against an AT&T 5E switch and is ready for calls.

AutoSpid Download

The Express XL/XLT is performing the Lucent SPID download feature.

AutoSpid X

A SPID is being attempted by ExpertISDN. X starts at 0 and counts up for each SPID format.

CALL <number>

The Express XL/XLT is dialing the number.

Call Connect B1

Bearer channel B1 is active with a call.

Call Connect B2

Bearer channel B2 is active with a call.

Call Connect B1/B2

Bearer channels B1 and B2 are active with a call.

Connected 64K/2X64K/128K/144K

When the Express XL/XLT is in leased mode, this will appear when the link's layer 1 is up. The rate is determined by what it is configured for under Configuration/WAN/ISDN/Leased/Rate.

DISCONNECTING

A call is in the process of being disconnected.

DMS-100 Ready

The ISDN link layers 1 through 3 are up against a Nortel DMS-100 switch and is ready for calls.

Echo: Tx: X Rx: Y

The current transmit and receive count for the PPP echo request test.

Getting TEI #1

The Express XL/XLT's ISDN layer 1 is up and is now getting the first TEI from the ISDN network.

Getting TEI #2

The Express XL/XLT's ISDN layer 1 is up and one TEI is obtained. It is now getting the second TEI from the ISDN network.

ISDN-1 Ready

The ISDN link layers 1 through 3 are up against a switch running the ISDN-1 protocol and is ready for calls.

Layer 1 up

The Express XL/XLT's ISDN layer 1 is up.

Link down

The ISDN link is not synchronized.

Link In Sync

The ISDN link is synchronized but layer 1 is not up.

NET EOC LOOPBACK

Express XL/XLT has received an ISDN EOC loopback command from the switch.

Register SPID #1

The Express XL/XLT's ISDN layer 1 and 2 is up and is now registering SPID 1 with the ISDN network.

Register SPID #1

The Express XL/XLT's ISDN layer 1 and 2 is up and is now registering SPID 2 with the ISDN network.

RINGING

An incoming call is ringing.

B1 and B2 Bearer Channel Status Messages

56K

Connected at 56K call type.

64K

Connected at 64K call type.

Audio

Connected at audio call type.

Dialing

Dialing out.

Holding

Connection is on hold.

Idle

No call up.

Speech

Connected at speech call type.

Release

Call being hung up.

Retriv

Held call being retrieved.

Ringin

Incoming call.

Routing

Incoming call state in transition .

Waiting

Call is between states or waiting for switch.

Appendix B

Log Messages

The Express XL/XLT Logs menu contains messages of events that occur. The definitions for some of those log messages are as follows:

PPP Log Messages

B-Channels bundled

level 5

Both B-channels are bundled under multilink PPP going to a single PPP peer.

BACP <X> down

level 5

Bandwidth Allocation Control Protocol port <X> has been dropped between Express XL/XLT and PPP peer.

BACP <X> up

level 5

Bandwidth Allocation Control Protocol port <X> has been successfully negotiated between Express XL/XLT and PPP peer.

BCP <X> down

level 5

Bridge Control Protocol port <X> has been dropped between Express XL/XLT and PPP peer.

BCP <X> up

level 5

Bridge Control Protocol port <X> has been successfully negotiated between Express XL/XLT and PPP peer.

Can't find user profile

level 2

The Express XL/XLT could not find an appropriate user profile for an incoming call. Make sure that a profile has been entered under Configuration/Connection List or that a default profile exists. A default profile is one which has the name **DEFAULT** in the description field.

CCP <X> down

level 5

Compression Control Protocol port <X> has been dropped between Express XL/XLT and PPP peer.

CCP <X> up

level 5

Compression Control Protocol port <X> has been successfully negotiated between Express XL/XLT and PPP peer.

CHAP authen failed

level 3

The PPP peer has rejected the Express XL/XLT's username and/or password used for authenticating. Check to make sure the **Configuration/Connection List/Authentication** parameters **Tx Method**, **Tx Username**, and **Tx Password** are correct.

EAP authen failed

level 3

The PPP peer has rejected the Express XL/XLT's username and/or password used for authenticating. Check to make sure the **Configuration/Connection List/Authentication** parameters **Tx Method**, **Tx Username**, and **Tx Password** are correct.

IPCP <X> down

level 5

IP Control Protocol port <X> has been dropped between Express XL/XLT and PPP peer.

IPCP <X> up

level 5

IP Control Protocol port <X> has been successfully negotiated between Express XL/XLT and PPP peer.

IPXCP <X> down

level 5

IPX Control Protocol port <X> has been dropped between Express XL/XLT and PPP peer.

IPXCP <X> up

level 5

IPX Control Protocol port <X> has been successfully negotiated between Express XL/XLT and PPP peer.

LCP <X> down

level 5

Link Control Protocol port <X> has been dropped between Express XL/XLT and PPP peer.

LCP <X> up

level 5

Link Control Protocol port <X> has been successfully negotiated between Express XL/XLT and PPP peer.

Link is looped back

level 3

The Express XL/XLT has dialed a location which is looping back all data. Essentially, it has negotiated PPP with itself.

MP options not the same

level 2

It is required that when LCP links are bundled that specific PPP options (MR-RU and short sequence header format) be negotiated the same for all LCP links. This message occurs when those options mismatch. Probably due to misconfiguration of the PPP peer

Negot not converging

level 2

Negotiation of the LCP layer is unattainable due to misconfiguration or the Express XL/XLT or PPP peer is requiring authentication and the other is refusing.

No IP addr for peer

level 2

The Express XL/XLT cannot continue the connection because there was no IP address received from the PPP peer or it was not set in **Configuration/Connection List/IP/Route/IP/Net** parameter.

No more bundles avail

level 3

The Express XL/XLT cannot bundle more than two Multilink sessions at one time.

No Response from peer

level 2

The Express XL/XLT has dialed or answered a call and no PPP negotiation packets were seen.

PAP authen failed

level 3

The PPP peer has rejected the Express XL/XLT's username and/or password used for authenticating. Check to make sure the **Configuration/Connection List/Authentication** parameters **Tx Method**, **Tx Username**, and **Tx Password** are correct.

Peer failed CHAP authen

level 3

The PPP peer's reported CHAP username and/or password does not match the Express XL/XLT's parameters. This is most likely caused by PPP peer sending an incorrect username and/or password. Make sure the **Configuration/Connection List/Authentication** parameters **Rx Username** and **Rx Password** are correctly entered. Also, if using RADIUS, check that the server is configured and running properly.

Peer failed EAP authen

level 3

The PPP peer's reported EAP username and/or password does not match the Express XL/XLT's parameters. This is most likely caused by PPP peer sending incorrect username and/or password. Make sure the **Configuration/Connection List/Authentication** parameters **Rx Username** and **Rx Password** are correctly entered. Also, if using RADIUS, check that the server is configured and running properly.

Peer failed PAP authn

level 3

The PPP peer's reported PAP username and/or password does not match the Express XL/XLT's parameters. This is most likely caused by PPP peer sending incorrect username and/or password. Make sure the **Configuration/Connection List/Authentication** parameters **Rx Username** and **Rx Password** are correctly entered. Also, if using RADIUS, check that the server is configured and running properly.

Peer refused authn

level 3

The PPP peer would not allow the Express XL/XLT to authenticate it using the method set in Configuration/Security/PPP.

Peer refused SpanTree

level 4

The PPP peer would not participate in the Spanning Tree protocol. This is a warning message only. Bridging will still occur across the WAN port so care must be taken that no loop topologies exist across the connection.

PPPt[x] ...

level 6

Advance debugging decode of transmitted PPP configuration packets.

PPPrx[x] ...

level 6

Advanced debugging decode of received PPP configuration packets.

Call Log Messages**Answer <number>**

level 5

An incoming call from <number> was answered. If no caller ID is available for the ISDN line then <number> will be blank.

AutoSpid Download Not Available

level 4

Lucent AutoSpid download is not available from this ISDN switch.

AutoSpid Download Pass

level 4

Lucent AutoSpid download feature has successfully installed the SPIDs.

AutoSpid Download Started

level 4

Lucent AutoSpid download feature has started.

AutoSpid Failed

level 2

ExpertISDN has failed trying to determine the ISDN line's SPID format. This can occur if the telephone company is not using standard SPID formats.

AutoSpid Passed

level 4

ExpertISDN has finished and has determined the ISDN line's SPID format.

AutoSpid Retry

level 4

ExpertISDN is attempting another SPID format.

AutoSwitch AT&T

level 4

ExpertISDN has determined that the switch protocol is AT&T 5E custom.

AutoSwitch DMS

level 4

ExpertISDN has determined that the switch protocol is Nortel DMS-100.

AutoSwitch NI-1

level 4

ExpertISDN has determined that the switch protocol is National ISDN 1.

Bad call type

level 1

Internal error as a result of outgoing call attempt.

Bad Host_Call_ID

level 1

Internal error as a result of call control.

Bad phone number

level 2

An outgoing call was attempted with a badly formatted or empty phone number.

Bandwidth drop

level 4

The Express XL/XLT is dropping a B-channel call in order to reduce bandwidth.

Bandwidth request

level 4

The Express XL/XLT is dialing another B-channel in order to increase bandwidth.

Bandwidth Restore

level 4

The Express XL/XLT is re-dialing destination to restore original bandwidth after POTS call bump or unexpected call drop.

Bearer Info Cap Incorrect

level 2

The bearer capability received in an information element from the switch was invalid.

Bearer Mode Incorrect

level 2

The bearer mode received in an information element from the switch was invalid.

BUSY

level 2

Called location was busy.

Call lost <number>

level 5

The Express XLT attempted retrieve a previously held call but the call was lost for unknown reasons. If no caller ID is available for the ISDN line, then <number> will be blank for incoming calls.

Caller ID mismatch

level 3

The caller ID number did not match the numbers placed in **Configuration/Connection List/Authentication** parameters **Call ID 1** or **Call ID 2**.

CallID 1 in use

level 2

An outgoing call on LDN 1 was dumped because it was already busy with a call.

CallID 2 in use

level 2

A outgoing call on LDN 2 was dumped because it was already busy with a call.

Can't answer, Call not ringing

level 1

Internal error as a result of trying to answer a non-existent incoming call.

Cause: '<cause>' diag=<num>

level 3

The ISDN switch has sent a Cause information element describing the reason reported from the ISDN switch as <cause> for a call failure. The value <num> is the diagnostic which can be helpful for diagnosing by the telephone company or ADTRAN technical support. The following will be reported for the <cause> value:

BAD_INFO_ELEM
BEAR_CAP_NOT_AVAIL
BEARER_CAP_NOT_AUTH
CALL_REJECTED
CAP_NOT_IMPLEMENTED
CHAN_DOES_NOT_EXIST
CHAN_NOT_IMPLEMENTED
CHANNEL_UNACCEPTABLE
DEST_OUT_OF_ORDER
FACILITY_NOT_IMPLEMENT
FACILITY_NOT_SUBSCRIBED
FACILITY_REJECTED
INCOMING_CALL_BARRED
INCOMPATIBLE_DEST
INVALID_CALL_REF
INVALID_ELEM_CONTENTS
INVALID_MSG_UNSPEC
INVALID_NUMBER_FORMAT
MANDATORY_IE_LEN_ERR
MANDATORY_IE_MISSING

NETWORK_CONGESTION
NETWORK_OUT_OF_ORDER
NO_CIRCUIT_AVAILABLE
NO_ROUTE
NO_ROUTE_TO_DEST
NO_USER_RESPONDING
NON_SEL_USER_CLEAR
NONEXISTENT_MSG
NORMAL_CLEARING
NUMBER_CHANGED
OUTGOING_CALL_BARRED
PRE_EMPTED
PROTOCOL_ERROR
REQ_CHANNEL_NOT_AVAIL
RESOURCE_UNAVAIL
SERVICE_NOT_AVAIL
SERVICE_OPER_VIOLATED
TEMPORARY_FAILURE
TIMER_EXPIRY
UNASSIGNED_NUMBER
USER_ALERT_NO_ANS
USER_BUSY
WRONG_MESSAGE
WRONG_MSG_FOR_STATE

Conference <number>

level 5

The Express XLT has conferenced the held call with the active call. If no caller ID is available for the ISDN line then <number> will be blank for incoming calls.

Conference Rej <number>

level 5

The Express XLT attempted to conference but was reject by the ISDN switch. If no caller ID is available for the ISDN line, then <number> will be blank for incoming calls.

Connect Timeout

level 3

An outgoing call attempt has failed because the call was not answered or it was not routed through the ISDN network.

Connected <number>

level 5

A call from or to <number> was connected. If no caller ID is available for the ISDN line then <number> will be blank for incoming calls.

Demand calling '<user>'

level 4

A new call is being placed due to incoming packet routed to "idle" interface or bridge packet passing through demand filter. The Connection List profile used is the one with <user> in the description field.

DEST NOT ISDN

level 4

The number dialed is not ISDN. This is a warning and is most often seen for POTS calls.

Dial <number>

level 5

The Express XL/XLT is dialing <number>.

Dialing ...

level 5

A phone on the Express XLT POTS port is dialing.

Disconnect <number>

level 5

A call from or to <number> was disconnected. If no caller ID is available for the ISDN line, then <number> will be blank for incoming calls.

Dump <number>

level 5

A call or call attempt to or from <number> has been refused. If no caller ID is available for the ISDN line, then <number> will be blank for incoming calls.

Dump call

level 3

The Express XL/XLT has dropped an incoming call because it was busy with calls.

Fallback to 56K

level 4

The Express XL/XLT is re-dialing the same destination at 56K call type because the 64K call type failed.

FarDN=<number>

level 5

This is far-end directory number for an incoming call.

Hangup <number>

level 5

A call from or to <number> was hung up. If no caller ID is available for the ISDN line, then <number> will be blank for incoming calls.

Hold <number>

level 5

The Express XLT has placed a call on hold. If no caller ID is available for the ISDN line, then <number> will be blank for incoming calls.

Hold Reject <number>

level 5

The Express XLT attempted to put a call on hold and it was rejected by the ISDN switch. If no caller ID is available for the ISDN line, then <number> will be blank for incoming calls.

Idle timeout

level 4

The Express XL/XLT's idle timer has expired and the current session has dropped.

L1 not up

level 2

A call attempt was stopped because ISDN layer 1 is down.

L2 not up

level 2

A call attempt was stopped because ISDN layer 2 is down trying to get first TEI.

L2 #2 not up

level 2

A call attempt was stopped because ISDN layer 2 is down trying to get second TEI.

L3 not up

level 2

A call attempt was stopped because ISDN layer 3 is down trying to register first SPID.

L3 #2 not up

level 2

A call attempt was stopped because ISDN layer 3 is down trying to register second SPID.

LDN TOO LONG

level 1

The number in either LDN 1 or LDN 2 is longer than 20 characters.

NETWORK BUSY

level 2

Called location was busy or network could not route call.

Network down

level 4

The ISDN network is unavailable due to layers 1,2 or 3 dropping.

Network up

level 4

The ISDN network layer 3 is up and is ready for calls.

No calling ID

level 2

An incoming call did not provide the caller ID number required for authentication.

No previous number

level 1

An internal error occurred with dial-on-demand function.

NOT end2end ISDN

level 4

The path that the call was routed over is not ISDN from end-to-end. This is a warning and is most often seen for POTS calls.

Power Up - last down cause: <reason>

level 0 (displayed as level 1 after the unit is reset)

This is the <reason> for the last reset. Most are caused by internal errors. Possible reasons are:

Bus Error - Bad address occurred on the internal bus

Kernel error - General operating system error

No SBCs - Mail resources used up or lost

Router stack error - Fatal error in protocol stack

general panic - general error

no rip - rip tasks could not start

out of memory - out of available memory

out of TCP ports - all TCP ports are used up

unknown error - unknown fatal error has occurred

Set timer error - Cannot set real time clock

Software Watch Dog Reset - Software watchdog was not updated

Probe: all ports busy

level 3

All ports were busy when it was time to probe. An attempt will be made on the next probe interval.

Probe failed

level 2

An attempt to connect to a probe site failed.

Probing <name>

level 4

The Express XL/XLT is making an outgoing call to the destination specified by the description in the Connection List in order to get an update on routes.

POTS call bump

level 4

The Express XLT has dropped bandwidth on an existing data call so that a POTS call can be connected.

Retrieved <number>

level 5

The Express XLT has retrieved a previously held call. If no caller ID is available for the ISDN line, then <number> will be blank for incoming calls.

Ring <number>

level 5

An incoming call from <number> was ringing. If no caller ID is available for the ISDN line then <number> will be blank.

SOURCE NOT ISDN

level 4

The incoming calling party is not ISDN. This is a warning and is most often seen for POTS calls.

Signal 0xNN

level 4

A signal information element was received from the ISDN switch with the value NN in hexadecimal.

Transfer <number>

level 5

The Express XLT has transferred the held call with the active call. If no caller ID is available for the ISDN line, then <number> will be blank for incoming calls.

Transfer Rej <number>

level 5

The Express XLT attempted to transfer but was reject by the ISDN switch. If no caller ID is available for the ISDN line then <number> will be blank for incoming calls.

Network Log Messages

Attempting to add bad IP iface route: ifnum=<inter> dest=<ip>

level 4

An IP address <ip> could not be used for the interface number <inter>.

DHCP couldn't alloc mem

level 1

A DHCP response could not be generated due to memory allocation problems.

DHCP response sent

level 4

A DHCP response was successfully sent to requesting device.

DHCP socket failed

level 1

Internal error occurred when attempting to start DHCP server.

DHCP: Host not added to ARP table

level 2

The DHCP server could not add requesting host to ARP table.

**Installing bad default route: ifnum=<inter> metric=<hops>
gw=<ip>**

level 6

The Express XL/XLT did not install a default route because the <inter> or <hops> was zero.

**Rejecting packet with Source Routing option - src=<srcip>
dest=<destip>**

level 4

The Express XL/XLT has dropped a source routed IP packet due to invalid parameters.

setmask: local IP iface(0), not done

level 6

Debug error used in determining router stack problems.

syslog: bad host

level 2

Syslog function cannot use host name or IP set in Configuration/Logs/Syslog Host.

syslog: no port

level 2

Syslog function cannot open port to send Log entries.

TEL: Telnet Session Closed

level 4

Telnet server session has been closed.

telclient bad host

level 2

Telnet client could not use host name or IP address set in Configuration/Utilities/Telnet Client/Host.

telclient bad init

level 2

Telnet client could not initialize a session.

Telnet Client: Clr TCBF_BUFFER flag failed

level 6

Debugging message related to Telnet client function.

Telnet Client: Set TCBF_DONTBLOCK flag failed

level 6

Debugging message related to Telnet client function.

Telnet Client socket failed

level 2

Telnet client function could not open TCP socket.

Telnet server connect to <ip>

level 4

Telnet server has connected to Telnet client with IP address <ip>.

Telnet Session Closed

level 4

Telnet server has closed connection.

Telnet Session failed, error <errnum>

level 2

Telnet server could not connect to Telnet client due to error.

TELNETD: accept failed

level 2

Telnet server could not open TCP socket to incoming Telnet client.

TELNETD: Set TCPC_LISTENQ failed

level 6

Debugging message related to Telnet server function.

TELNETD: Clr TCBF_BUFFER flag failed

level 6

Debugging message related to Telnet client function.

TELNETD: could not obtain peer ip

level 2

Telnet server function could not get IP address of Telnet client.

TELNETD: Session failed, error

level 2

A Telnet server session has failed because of an error.

TELNETD: Set TCBF_DONTBLOCK flag failed

level 6

Debugging message related to Telnet client function.

TELNETD: SOCKET creation error

level 2

Telnet server could not be started due to TCP socket error.

TFTP: can't get to host

level 2

TFTP client could not get to host.

TFTP client: unable to open port

level 2

TFTP client function could not open a UDP port.

TFTP: error rcvd - <message>"

level 2

Received error with <message> from TFTP server.

TFTP: lost communication

level 2

Lost communication to TFTP client or server during transfer.

TFTP server: unable to open port

level 2

TFTP server function could not open a UDP port.

Appendix C

SNMP

Understanding SNMP

As Local Area Network (LAN) environments became standardized over the past ten years, multi-vendor equipment grew with competition. It became necessary to manage the various vendor equipment from a single control console. Thus, the Simple Network Management Protocol (SNMP) emerged as the *de facto* standard for managing commercial Transmission Control Protocol/Internet Protocol (TCP/IP) networks.

The term *SNMP* broadly refers to the message protocols used to exchange information between the network and the managed devices, as well as to the structure of network management databases. SNMP has three basic components:

- **Network Manager:** This is a control program that collects, controls, and presents data pertinent to the operation of the network devices. It resides on a network management station.
- **Agent:** This is a control program that responds to queries and commands from the network manager and returns requested information or invokes configuration changes initiated by the manager. It resides in each network device connected.
- **MIB:** This is an index to the organized data within a network device. It defines the operating parameters that can be controlled or monitored.

When requesting the network manager to retrieve or modify a particular piece of information about a network device, the network manager transmits the request to that network device. The agent in that device interprets the incoming request, performs the requested task, and sends its response to the network manager. The network manager collects all the data from the various network devices and presents it in a consistent form.

Using SNMP Version 1, the network manager can issue three types of commands:

- **GetRequest:** This command retrieves a single item or the first in a series from a network device.
- **GetNextRequest:** This command retrieves the next item in a series from a network device.
- **SetRequest:** This command writes information to a network device.

The network device issues two types of messages:

- **GetResponse:** This message is the response to a network manager **GetRequest** or **GetNextRequest** command.
- **Trap:** This is an unsolicited message issued by a network device to report an operational anomaly or an alarm condition to the network manager.

These messages are typically encased within informational packets and transported over the LAN or WAN.

SNMP Embedded Agent

The Express XL/XLT supports the following groups from MIB-II: (RFC 1213)

- System Group
- UDP Group
- Interfaces Group
- ICMP Group
- Address Translation Group
- IP Group
- TCP Group

Also, the Ethernet transmission MIB is supported (RFC 1643).

The following manager requests are supported:

- Get object
- Get next object
- Set object

Communities

The Express XL/XLT permits up to eight communities to be defined. The privilege level of each community can be set. The default community is public with read-only privileges. When the IP address is all zeros, any manager of the community can access the Express XL/XLT.

Traps

Up to four hosts can be set to receive traps. Each host entry requires an IP address of the manager.

Appendix D

Connector Pinouts

Table D-A
IBM/AT Style EIA-232 Interface

 MAINTENANCE	Pin	Name	I/O	Description
	1	CD	N/C	Carrier Detect
	2	RD	O	Receive Data
	3	TD	I	Transmit Data
	4	DTR	N/C	Data Terminal Ready
	5	GND	N/A	Signal Ground
	6	DSR	N/C	Data Set Ready
	7	RTS	I	Request to Send
	8	CTS	O	Clear to Send
	9	RI	N/C	Ring Indicator

I = Input O = Output N/A = Not Applicable N/C = Not Connected

Table D-B
RJ-45 ISDN BRI U

 ISDN BRI U	Pin 4	Ring
	Pin 5	Tip

Table D-C
RJ-11 POTS



	Pin 3	Ring
	Pin 4	Tip

Table D-D
10BaseT Ethernet

		Switch Position	
		TO NIC	TO HUB
	Pin 1	TX1	RX1
	Pin 2	TX2	RX2
	Pin 3	RX1	TX1
	Pin 6	RX2	TX2



*The switch position can be set for either **TO NIC** or **TO HUB** on the back panel of the Express XL/XLT. The rear panel is illustrated in Figure 1-7 on page 18.*

Appendix E

Terminal Mode Commands

The Express XL/XLT supports a command line interface. All menu options are configurable and readable from the terminal mode. Additional commands are also available.

Menu Commands

Every menu item in the menu structure can be accessed through the terminal mode interface. Terminal commands are as follows:

```
top_menu sub_menu1 sub_menu2 ... config_item
```

Each config_item is entered as shown below.

TYPE:	ENTERED AS:
string	printable characters within double quotes
password	printable characters within double quotes
IP address	xx.xx.xx.xx (0..9) separated by '.'
Hex	xx:xx:xx:xx (0..9,a..f) separated by ':'
enum	sub-string or [#index]
unsigned	digits (0..9)
date	mm-dd-yyyy
time	hh:mm:ss
date/time	mm-dd-yyyy hh:mm:ss
activator	read only
list	followed by index with first record being 1
array	followed by index with first record being 1

One of the following key words must be used first:

info	Goes directly to Configuration/System Info menu.
isdn	Goes directly to Configuration/WAN/ISDN menu.
pots	Goes directly to Configuration/WAN/POTS menu.
ip	Goes directly to Configuration/IP menu.
ipx	Goes directly to Configuration/IPX menu.
bridge	Goes directly to Configuration/Bridge menu.
security	Goes directly to Configuration/Security menu.
connect	Goes directly to Configuration/Connection List menu.
telnet	Goes directly to Configuration/Management/Telnet menu.
snmp	Goes directly to Configuration/Management/SNMP menu.
maint	Goes directly to Configuration/Management/Maint menu.
dial	Goes directly to Configuration/Dial menu.
status	Goes directly to Configuration/Status menu.
test	Goes directly to Configuration/Test menu.
logs	Goes directly to Configuration/Logs menu.
util	Goes directly to Configuration/Utilities menu.

Some examples are listed below:

isdn spid_1 20555512340101	sets spid 1
telnet user 1 name "guest"	sets user name for telnet user list entry 1 to "guest"
dial 3 dial	dials the numbers for connection list profile number 3
status ip 1 gateway	returns the gateway address for IP route table entry 1

Additional Commands

Other commands available from the terminal mode are given below:

save	Saves the configuration to non-volatile RAM (flash).
mac	Returns the MAC address for the Express XL/XLT.
version	Returns the firmware version and routing stack version.
reset	Resets the unit.
exit	Leaves terminal mode and returns to menus.
download	Downloads complete configuration to the terminal screen for capture.

Download/Uploading Configuration

The Express XL/XLT's configuration can be captured to a text file using the download command. The text file can be edited if required. Upload of the configuration can be accomplished by sending the text file to the Express XL/XLT in terminal mode. A baud rate of 9600 is strongly recommended when uploading. As soon as the upload has been completed, type "save" to save the new configuration to flash. A "reset" command or power cycle 10 seconds after the save command is recommended to ensure that the new configuration is complete.

Glossary

10Base2

IEEE 802.3 specification, similar to Ethernet, using thin coaxial cable that runs at 10 Mbps, with a maximum distance of 185 meters per segment. Also known as Thin Ethernet or Thinwire Ethernet.

10BaseT

IEEE 802.3 specification, using unshielded twisted-pair cabling and running at 10 Mbps.

AEP

AppleTalk Echo Protocol. Allows a node on an AppleTalk network to send a packet to another node and in return, receive an echoed copy of the packet.

B-Channel

64 kbps bearer channel used for voice, circuit, or packet switched data.

bearer service

As defined by CCITT standards, a type of telecommunication service that provides the capability for the transmission of information between user-to-network interfaces. Bearer services defined for ISDN are circuit mode and packet mode.

BOOTP

The Bootstrap Protocol allows a network node to determine certain startup information such as its IP address.

Bridge

A data communications device that connects two or more networks. A bridge stores and forwards complete packets between the networks. Bridges operate at the data-link layer of the OSI model.

CCITT

Consultative Committee on International Telephony and Telegraphy. A body of the International Telegraph Union (ITU) which prepares recommendations, commonly referred to as international standards, to resolve technical telegraph and telephone problems.

central office (CO)

In telephony, the phone company switching facility or center, usually a Class 5 end office, at which subscribers local loops terminate. Handles a specific geographic area, identified by the first three digits of the local telephone number. Usually the facilities of the local BOC.

CSMA/CD

Carrier Sense Multiple Access Collision Detect. A channel access mechanism where devices check the channel for a carrier before transmitting. If no carrier is sensed for the specified period of time, the device can transmit. If two devices transmit at once, a collision occurs and is detected by all colliding devices. This collision subsequently delays their retransmissions for a random length of time. CSMA/CD is used by Ethernet and IEEE 802.3.

D-channel

The ISDN channel that carries signalling information to control the call setup, teardown, or invocation of supplementary services. The D-Channel may also be used to provide packet mode data service.

DDS

Dataphone Digital Service. AT&T private line service for transmitting data over a digital system. The digital transmission system transmits electrical signals directly, instead of translating the signals into tones of varied frequencies as with traditional analog transmission systems. Digital techniques provide more efficient use of transmission facilities, resulting in lower error rates and costs than analog systems.

digital hub

Designated office where DDS channels are interconnected and where synchronous network timing, testing access, and additional service features are provided.

Ethernet

A local area network used for connecting computers, printers, workstations, a terminals, servers, etc., within the same building or campus. Ethernet operates over twisted wire and coaxial cable at speeds up to 10 Mbps. Ethernet specifies a CSMA/CD.

four-wire circuits

Telephone lines using two wires for transmitting and two wires for receiving, offering much higher quality than a 2-wire circuit. All long distance circuits are 4-wire. Almost all local phone lines and analog phones are 2-wire.

group 4

A high-speed (56 kbps) facsimile protocol specific to ISDN.

hop count

A routing metric used to measure the distance between a source and a destination. Particularly used by RIP.

hub

(1) Communications center, (2) Major routing station for connecting channels, (3) DDS connecting center.

IEEE

Institute of Electrical and Electronic Engineers. Professional organization that defines network standards. IEEE LAN standards are the predominant LAN standards today and include protocols similar or virtually equivalent to Ethernet and Token Ring.

IEEE 802.1d

An algorithm used to prevent bridging loops by creating a spanning tree.

IEEE 802.2

An IEEE LAN protocol that specifies an implementation of the LLC sublayer of the data link layer. It handles errors, framing, flow control, network layer (Layer 3) service interface, and is used in LANs.

IEEE 802.3

A physical layer standard specifying a linear bus network LAN with a CSMA/CD access method on a bus topology. Ethernet follows the 802.3 standard, transmitting at 10 megabits per second. This is the most common local area network specification. Physical variations of IEEE 802.3 include 10Base2 and 10BaseT.

in-band signalling

Signalling made up of tones which pass within the voice frequency band and are carried along the same circuit as the talk path being established by the signals. Virtually all signalling (request for service, dialing, disconnect, etc.) in the U.S. is in-band signalling. Most of that signalling is MF (Multi-Frequency) dialing. The more modern form of signalling is out-of-band.

interexchange carrier

Since divestiture, any carrier registered with the FCC authorized to carry customer transmissions between LATAs interstate, or if approved by a state public utility commission, intrastate. Includes carriers such as AT&T Communications, Satellite Business Systems, GTE Telenet, GTE Sprint, and MCI.

information element

The name for the data fields within an ISDN Layer 3 message.

interworking

Communication between two types of networks or end equipment. This may or may not involve a difference in signalling or protocol elements supported.

Internet Protocol

A TCP/IP protocol describing software that tracks the Internet address of nodes, routes outgoing message, and recognizes incoming messages. Used in gateways to connect networks at OSI network Level 3 and above.

IPX

Internetwork Packet Exchange. A Novell NetWare protocol used to move information across networks.

ISDN

Integrated Services Digital Network. A network architecture that enables end-to-end digital connections. The network supports diverse services through integrated access arrangements and defines a limited set of standard, multipurpose interfaces for equipment vendors, network providers, and customers. Interworking with a public switched telephone network is retained.

jabber

An error condition in which a network device continually transmits garbage onto the network. In IEEE 802.3, a data packet whose length exceeds that prescribed in the standard.

jitter

The slight movement of a transmission signal in time or phase that can introduce errors and loss of synchronization for high-speed synchronous communications. See phase jitter.

LATA

Local Access and Transport Area. One of 161 local telephone serving areas in the United States, generally encompassing the largest standard statistical metropolitan areas. Subdivisions established as a result of the AT&T divestiture that now distinguish local from long distance service. Circuits with both endpoints within the LATA (intraLATA) are generally the sole responsibility of the local telephone company, while circuits that cross outside the LATA (interLATA) are passed on to an interexchange carrier.

loopback

A diagnostic procedure where data is sent to the device being tested, and the output of the device is fed directly back to its input, looped around, and the returning data is checked against that which was sent.

Media Access Control (MAC)

As defined by the IEEE, the lower of the two sublayers of the OSI reference model data link layer. The MAC sublayer is concerned with media access issues, such as whether token passing or contention is used.

message

The Layer 3 information that is passed between the CPE and SPCS for signaling.

multipoint line

A communications line having multiple cable access points.

Name Binding Protocol (NBP)

The AppleTalk transport-level protocol that translates a character string name into the internet address of the corresponding socket client; NBP enables AppleTalk protocols to understand user-defined zones and device names by providing and maintaining translation tables that map these names to corresponding socket addresses.

NAT

Network Address Translation occurs at the borders of stub domains. Its purpose is to translate the IP address of passing packets by changing all references of one IP address to another. Translation is performed as per RFC 1631.

netmask

A 32-bit bit mask which shows how an Internet address is to be divided into network, subnet, and host parts. The netmask has ones in the bit positions in the 32-bit address which are to be used for the network and subnet parts, and zeros for the host part. The mask should contain at least the standard network portion (as determined by the address's class), and the subnet field should be contiguous with the network portion.

non-ISDN line

Any connection from a CPE to a SPCS that is not served by D-Channel signaling.

non-ISDN trunk

Any trunk not served by either SS7 or D-Channel signalling.

NT1

Network Termination 1. A unit that provides physical and electromagnetic termination of the U-interface 2-wire transmission line, converts between Layer 1 formats used at the U- and T- reference points, and performs some maintenance functions.

phase jitter

In telephony, the measurement in degrees out-of-phase that an analog signal deviates from the reference phase of the main data-carrying signal. Often caused by alternating current components in a telecommunications network.

point-to-point protocol (PPP)

An implementation of TCP/IP which is intended for transmission using telephone lines. PPP provides router-to-router and host-to-network connections over both synchronous and asynchronous circuits.

poison routes

Routes which have an infinite metric which to other routers means the network for the route is inaccessible.

PRA

Primary Rate Access. Connects high-capacity CPE, such as PBXs, to the network. In the US, this is composed of twenty-three 64 kbps channels and one 64 kbps D-channel. Also known as Primary Rate Interface (PRI).

RIP

Routing Information Protocol. A protocol used to exchange routing information among a set of computers connected by a LAN. RIP uses hop counts as a routing metric.

router

An interface which finds the best route between two networks. Routers forward packets from one network to another, based on network layer information.

routing metric

The method by which a routing algorithm determines one route is better than another. This information is stored in routing tables. Such tables include reliability, delay bandwidth, load, MTUs, communication costs, and hop count.

RS-232-C

An EIA-specified physical interface with associated electrical signalling between DCE and DTE. The most commonly employed interface between computer devices and modems.

RTMP

Routing Table Maintenance Protocol. The AppleTalk protocol used to establish and maintain the routing information that is required by internet routers in order to route datagrams from any source socket to any destination socket in the internet. Using RTMP, internet routers dynamically maintain routing tables to reflect changes in internet topology.

service advertising protocol (SAP)

An IPX protocol through which network resources such as servers become known to clients.

servicing area

Region surrounding a broadcasting station where signal strength is at or above a stated minimum. The geographic area handled by a telephone central office facility. Generally equivalent to a LATA.

SNMP

Simple Network Management Protocol. SNMP provides a means to monitor and set network configuration and runtime parameters.

spanning tree

A loop-free subset of the topology of a network.

SPCS

Stored Program Controlled Switch. A digital switch that supports call control, routing, and supplementary services provision under software control. All ISDN switches are SPCSs.

spoofing

Spoofing reduces the required bandwidth by having devices, such as bridges or routers, answer for the remote devices. This causes the remote LAN to appear as if it is still connected to the LAN device even though it is not. The spoofing saves the WAN bandwidth, because no packet is ever sent out on the WAN.

synchronous

(1) The condition occurring when two events happen in a specific time relationship with each other, both under control of a master clock; (2) A method of data transmission requiring the transmission of timing pulses to keep the sender and receiver synchronized in their communication used to send blocks of information. Synchronous data transmission is used in high speed data circuits because there is less overhead than asynchronous transmission of characters which contain two extra bits per character to effect timing.

T1

Also T-1. A digital transmission link with a capacity of 1.544 Mbps. T1 uses two pairs of normal twisted wires. T1 normally can handle 24 voice conversations with each conversation being digitized at 64 kbps. With more advanced digital voice encoding techniques, it can handle more voice channels. T1 is a standard for digital transmission in North America.

TA

Terminal Adaptor. A DCE that connects to the ISDN S-Interface and enables non-ISDN terminal equipment to communicate over the ISDN.

TE1

Terminal Equipment Type 1. ISDN-compatible terminals.

Telnet

The TCP/IP standard protocol for remote terminal connection service. Telnet allows a user at one site to interact with a remote timesharing system at another site as if the user's terminal were connected directly to the remote machine.

TCP/IP

Transmission Control Protocol/Internet Protocol. A set of protocols developed by the Department of Defense to link dissimilar computers across many kinds of networks.

twisted pair

Two wires twisted around each other to reduce induction (interference) from one wire to the other. Several sets of twisted pair wires may be enclosed in a single cable. Twisted pair is the normal cabling from a central office to your home or office, or from your PBX to your office phone. Twisted pair wiring comes in various thicknesses. As a general rule, the thicker the cable is, the better the quality of the conversation and the longer cable can be and still get acceptable conversation quality. However, the thicker it is, the more it costs.

2B+D

The Basic Rate Interface (BRI) in ISDN. A single ISDN circuit divided into two 64 kbps digital channels for voice or data and one 16 kbps channel for low speed data (up to 9,600 baud) and signalling. 2B+D is carried on one or two pairs of wires depending on the interface, the same wire pairs that today bring a single voice circuit into your home or office. See ISDN.

23B+D

In ISDN, also known as the Primary Rate Interface. A circuit with a wide range of frequencies that is divided in twenty-three 64 kbps paths for carrying voice, data, video, or other information simultaneously. It bears a remarkable similarity to today's T1 link, except that T1 carries 24 voice channels. In ISDN, 23B+D gives twenty-three channels and one D channel for out-of-band signalling. However, in T1, signalling is handled in-band. See ISDN.

two-wire circuit

A transmission circuit composed of two wires, signal and ground, used to both send and receive information. In contrast, a 4-wire circuit consists of two pairs. One pair is used to send and one pair is used to receive. All trunk circuits (long distance) are 4-wire. A 4-wire circuit delivers better reception, but also costs more. All local loop circuits (those coming from a Class 5 central office to the subscriber's phone system) are 2-wire, unless a 4-wire circuit is requested.

U-interface

A twisted pair subscriber loop that connects the NT1 reference point to the ISDN network, as defined in the I.411 Recommendation. This interface provides Basic Rate Access with an operating frequency of 160 kbps and an information rate of 144 kbps. Under U.S. regulations, this also marks the line of demarcation between customer-owned equipment and the public network.

ZIP

Zone Information Protocol. The AppleTalk session-layer protocol used to maintain and discover the internet-wide mapping of network number ranges to zone names.

Zombie Routes

Routes that have been identified by the router to be deleted. They remain in the router's route table for a specified amount of time with an infinite metric so that all other routers will learn of this router's intention to delete them.

Acronyms

AEP	AppleTalk Echo Protocol
AMI	Alternate Mark Inversion
ARP	Address Resolution Protocol
B (Channel)	A 64 kbps digital information channel
BCP	Bridge Control Protocol
BONDING	Bandwidth On Demand Interoperability Group
BOOTP	Bootstrap Protocol
BPDU	Bridging Protocol Data Unit
bps	Bits per second
Bps	Bytes per second
BRI	Basic Rate Interface
CA	Call Appearance
CCP	Compression Control Protocol
CCITT	Consultative Committee for International Telegraphy and Telephony
CD	Carrier Detect
CPE	Customer Premises Equipment
CRC	Cyclic Redundancy Check
CSMA/CD	Carrier Sense Multiple Access Collision Detect
DHCP	Dynamic Host Configuration Protocol
DMS	Digital Multiplex Switching
DTE	Data Terminal Equipment
DTMF	Dual Tone Multi-Frequency
EKTS	Electronic Key Telephone Service
ESS	Electronic Switching System
FAX	Facsimile
FEBE	Far End Block Errors
FTP	File Transfer Protocol
ICMP	Internet Control Message Protocol
ID	Identification
IETF	Internet Engineering Task Force
I/O	Input/Output
IP	Internet Protocol
IPCP	Internet Protocol Control Protocol
IPX	Internetwork Packet Exchange
I²L	Integrated Injected Logic
IEC	Inter-Exchange Carrier

ISDN.....	Integrated Services Digital Network
ISO.....	International Standardization Organization
ISP.....	Internet Service Provider
kbps.....	Kilobits per second
kHz.....	Kilohertz
LAN.....	Local Area Network
LCP.....	Link Control Protocol
LDN.....	Local Directory Number
MAC.....	Media Access Control
MIB.....	Management Information Base
MP.....	Multilink Protocol
MRU.....	Maximum Receivable Unit
MRRU.....	Maximum Receivable Reconstructable Unit
NBP.....	Name Binding Protocol
NEBE.....	Near End Block Errors
NIC.....	Network Interface Card
NI-1.....	National ISDN-1
NT.....	Network Termination
PBX.....	Private Branch Exchange
PC.....	Personal Computer
PING.....	Packet InterNet Groper
POTS.....	Plain Old Telephone Service
PPP.....	Point-to-Point Protocol
PRI.....	Primary Rate Interface
RFC.....	Request For Comments
RIP.....	Routing Information Packet, Routing Information Protocol
RTMF.....	Routing Table Maintenance Protocol
SAP.....	Service Advertising Protocol
SNMP.....	Simple Network Monitoring Protocol
SPCS.....	Stored Program Controlled Switching System
SPID.....	Service Profile Identifier
TCP.....	Transmission Control Protocol
TEL.....	Terminal Endpoint Identifier
TFTP.....	Trivial File Transfer Protocol
UDP.....	User Datagram Protocol
WAN.....	Wide Area Network
ZIP.....	Zone Information Protocol

Numerics

10-base-T interface 144
56K 76
64K 76

A

address table 55
address table/aging 55
address table/forward policy 55
agent 139, 140
applications

- multiple users to ISP using NAT 10
- single user to corporate LAN 8
- single user to ISP using NAT 9
- SOHO to corporate LAN 11

area code 37
ARP cache 92
AT&T 5ESS 37
audio 75
authentication 56, 64

- with Express XL/XLT as authenticatee 65
- with Express XL/XLT as authenticator 64

authentication/call ID 1 67
authentication/call ID 2 67
authentication/caller ID 66
authentication/Rx password 66
authentication/Rx username 66

authentication/Tx method 65
authentication/Tx password 66
authentication/Tx username 66
autospid 36

B

B1 and B2 bearer channel status messages 119
BACP 73
bandwidth 77
bandwidth on demand 13
bandwidth/idle timeout 77
bandwidth/lower threshold 78
bandwidth/max channels 78
bandwidth/min channels 78
bandwidth/mode 77
bandwidth/on demand 77
bandwidth/preempt time 77
bandwidth/samples 78
bandwidth/upper threshold 78
BAP 19, 73
basic telephone service 22
baud rate 86
bridge 72
bridge menu 15, 50
bridge table 93
bridge/address table 55
bridge/mode 50, 72
bridge/spanning tree 52

bridge/WAN IP bridge 50
bridge/WAN IPX bridge 51
bridging 13
 concurrent routing and bridging 15
 demand 12

C

call log 100
call log messages 125
call log/active 100
call log/clear 101
call log/level 101
call log/view 101
call log/wrap 101
call sessions 90
call sessions/session1 and session2 91
call sessions/spanning tree 92
call type 75
call waiting 23
caller ID 66
channel rate 38
CHAP 58, 66
clock mode 38
command line interface 145
command prompt mode 87
commands 147
communities 141
communities/manager IP 85
communities/name 85
communities/privilege 85
compression 74
concurrent routing and bridging 15
conferencing calls 23
configuration 20
 downloading/uploading 147
configuration menu 27, 34
configuration/bridge 50
configuration/connection list 63
configuration/IP 40

configuration/IPX 47
configuration/management 83
configuration/management menu 83
configuration/security 56
configuration/system info 34
configuration/terminal mode 87
configuration/WAN 36
connecting to the Internet 19
connection
 ISDN 18
 LAN 21
 telephone 22
connection list 13, 15, 56, 63
connection list profile 13
 deleting 64
 inserting 63
connection list/active 64
connection list/authentication 64
connection list/bandwidth 77
connection list/bridge 72
connection list/description 64
connection list/dial out 75
connection list/filters 79
connection list/IP 67
connection list/IPX 70
connection list/PPP 73
connection list/probe 72
connector pinouts 143
corporate LAN 3, 8, 11
customer premises wiring 23

D

data bits 86
date/time 35
default gateway 41
demand bridging 12
demand dial filters 81
demand routing 12
DHCP mode 43

dial 15, 37
dial line 36
dial line/area code 37
dial line/ExpertISDN 36
dial line/LDN 1 or 2 38
dial line/SPID 1 37
dial line/switch protocol 37
dial menu 27, 88
dial out 75
dial out/attempts 76
dial out/call type 75
dial out/connection timeout 76
dial out/delay 76
dial out/initial channels 77
dial out/number 1 75
dial out/number 2 75
dial out/redial at 56K 76
dial self 98
dial self-test 17
dial/channels 89
dial/description 88
dial/dial 88
dial/hang up 89
dial/number 1 89
dial/number 2 89
dial/status 89
display 116
DMS-100 37
DNS 44
DNS server 44
DNS/domain name 44
DNS/server 1 44
DNS/server 2 44
domain name 44
download/uploading configuration 147
DTMF keypad 22

E

EAP 58, 66
echo request 98
echo request test 17
EIA-232 interface 143
embedded agent 140
environmental specifications 116
Ethernet interface 144
Ethernet interface (LAN) 115
ExpertISDN 1, 22, 36
express XL/XLT
 overview 7

F

factory default 12
features 115
FEBE 39
filter defines 59
filter defines /IP filter defines 60
filter defines /IPX filter defines 61
filter defines /MAC filter defines 59
filter defines /pattern filter defines 60
filters
 setting up 59, 79
filters/dem dial exceptions 82
filters/demand dial 81
filters/in exceptions 80
filters/LAN-to-WAN (out) 80
filters/out exceptions 81
filters/WAN-to-LAN (in) 79
firmware revision 35
flash-hook 23
forward delay 53
frame type 48
front panel 16

G

GetNextRequest 140

H

hang up 14
hang-up 13
hello time 53

I

idle timeout 13
IETF 19
if the Express XL/XLT does not read
 ready 107
if you are unable to connect calls 113
indicators
 LAN 16
 test 17
 WAN 17
installation 21
interface
 Ethernet 115
 network 115
 POTS 115
internet
 connecting to 19
internet access
 using NAT 2
internet service provider
 connecting 2
interoperability 19
IP filter defines 60
IP menu 40
IP router 12, 42
IP router/mode 42
IP routes 93
IP routing 14
IP stats 96
IP/default gateway 41
IP/DNS 44

IP/IP address 40
IP/IP router 42
IP/mode 67
IP/NAT 43, 67
IP/proxy ARP 46
IP/RIP 42, 69
IP/route 67
IP/static routes 41
IP/subnet mask 40
IP/UDP relay 45
IPX filter defines 61
IPX menu 47
IPX protocol 5
IPX router 12
IPX routes 94
IPX routing 15
IPX servers 95
IPX/frame type 48
IPX/mode 47, 70
IPX/network 47
IPX/remote network 70
IPX/retain 71
IPX/RIP timer 48
IPX/SAP timer 49
IPX/seed status 48
IPX/triggered 70
IPX/type 20 packets 71
ISDN
 connection 18
 network connection 21
 ordering 19
 overview 7
 setting up the line 1
ISDN line
 selecting mode 36
ISDN/dial line 36
ISDN/FEBEs 39
ISDN/leased line 38
ISDN/NEBEs 38
ISP 19

L

- LAN bridge 11
- LAN connection 21
- LAN indicators 16
- LAN port 53
- LAN port/active 53
- LAN port/path cost 54
- LAN port/priority 54
- LAN stats 96
- LDN 38
- leased line 38
- leased line/channel rate 38
- leased line/clock mode 38
- LEDs 17
- log messages 121
- logs menu 29, 99
- logs/call log 100
- logs/network log 101
- logs/PPP log 99
- logs/sys log host 99
- loop status messages 117

M

- MAC addresses 11
- MAC bridging 12
- MAC filter defines 59
- maint port/ baud rate 86
- maint port/data bits 86
- maint port/parity 87
- maint port/password 86
- maint port/password protect 86
- maint port/stop bits 87
- maintenance port 86
- management 83
- management/maint port 86
- management/SNMP 85
- management/Telnet 83
- master mode 38

- maximum age 53
- menu commands 145
- menu structure 27
- MIB 83, 139
- mode 14
- multilink 73
- multilink call 13
- multilink/BACP 73
- multilink/fragment 73
- multilink/mode 73
- multiprotocol routing 3

N

- NAT 9, 10, 12, 43, 44
- NAT mode 16
- NAT/DHCP mode 43
- NAT/DHCP renewal time 44
- NAT/web server 44
- National ISDN1 37
- NEBE 38
- NEC 37
- network address translation (NAT)
 - internet access using 2
- network connection
 - ISDN 21
- network device
 - GetResponse 140
- network interface 115
- network log 101
- network log messages 134
- network log/active 101
- network log/clear 102
- network log/level 102
- network log/view 102
- network log/wrap 101
- network manager 139
 - GetRequest 140
- none 43
- Novell 15
 - IPX protocol 5

O

ordering ISDN 19

P

packets

 filtering 59

PAP 58, 66

parity 87

password 84, 86

pattern filter defines 60

physical specifications 116

ping 103

ping test 17

poison reverse 43, 69

POTS 12, 39

POTS interface 115

POTS/NI-1 conference FI 39

POTS/NI-1 transfer FI 39

POTS/POTS assignment 39

POTS/speech calltype routing 39

power requirements 116

PPP 19, 58, 73

PPP log 99

PPP log messages 121

PPP log/active 100

PPP log/clear 100

PPP log/level 100

PPP log/view 100

PPP log/wrap 100

PPP peer 44

PPP/compression 74

PPP/max config 74

PPP/max failure 75

PPP/max timer 74

PPP/multilink 73

PPP/VJ compression 74

private 14

probe 72

probe/ update window 73

probe/active 72

probe/interval 72

proxy ARP 46

pushbutton tests 17

Q

quick startup guide 1

R

Radius 56, 84

Radius server 57

radius server/primary server 57

radius server/retry count 58

radius server/secondary server 57

radius server/secret 57

radius server/UDP port 57

rear panel 18

redial at 56K 76

remote/home office

 accessing corporate LAN 3

retain 14

RIP 12, 15, 42, 69

RIP timer 48

RIP/direction 43, 69

RIP/method 43, 69

RIP/mode 42, 69

RIP/protocol 42, 69

RIP/retain 70

RIP/triggered 69

RIP/V2 secret 43

RJ-11 interface 144

RJ-45 interface 143

route/force IP 68

route/hops 68

route/IP/net 68

- route/netmask 68
- route/private 68
- route/static route 68
- routing
 - concurrent routing and bridging 15
 - demand 12
 - IP 14
 - IPX 15
 - multiprotocol 3
 - over PPP bridging 15
- Rx only 43
- S**
- samples/sample rate 78
- samples/samples 78
- samples/time between changes 79
- SAP 12, 15
- SAP timer 49
- security 20
- security levels 33
- security menu 56
- security/authentication 56
- security/filter defines 59
- security/PPP 58
- security/radius server 57
- security/when 57
- seed status 48
- self-test
 - if self-test fails 107
- self-test 17
- SetRequest 140
- slave mode 38
- SNMP 85, 139
- SNMP access 85
- SNMP/communities 85
- SNMP/traps 85
- SOHO (small office - home office) 11
- spanning tree 52, 92
 - spanning tree algorithm 11, 52
 - spanning tree/forward delay 53
 - spanning tree/hello time 53
 - spanning tree/LAN port 53
 - spanning tree/maximum age 53
 - spanning tree/mode 52
 - spanning tree/priority 53
 - spanning tree/WAN port 0 54
 - spanning tree/WAN port 1 54
 - specifications 115
 - environmental 116
 - physical 116
 - speech 75
 - speech calltype routing 39
- SPID 37
- split horizon 43, 69
- static route 14
- static routes/active 41
- static routes/gateway 41
- static routes/hops 41
- static routes/IP address 41
- static routes/private 42
- static routes/subnet mask 41
- status menu 29, 90
- status/ARP cache 92
- status/bridge table 93
- status/call sessions 90
- status/IP routes 93
- status/IP stats 96
- status/IPX routes 94
- status/IPX servers 95
- status/LAN stats 96
- status/WAN stats 95
- stop bits 87
- subnet mask 40
- supplementary services 22
- switch compatibility 115
- switch position 144

switch protocol 37
system contact 35
system info menu 34
system location 34
system name 34
system uptime 35

T

telephone connection 22
Telnet 20, 83
Telnet client 104
Telnet/server access 83
Telnet/user list 84
terminal menu
 navigating 30
 structure 27
 top level 28
terminal mode 87
terminal mode commands 145
test indicators 17
test menu 29, 98
test menu/dial self 98
test menu/echo request 98
tests
 echo request 17
 ping 17
 pushbutton 17
TFTP 104
TFTP host 104
transfer methods 104
Trap 140
traps 141
traps/manager IP 86
traps/manager name 86
troubleshooting 107
 calls 113
 if self test fails 107
 if the Express XL/XLT does not read
 ready 107
 if you are unable to connect calls 113

Tx and Rx 43
Tx methods 65
Tx only 43
type 20 packets 71

U

UDP port type 45
UDP relay 45
UDP relay list 45
UDP relay list/relay address 45
UDP relay list/UDP port type 45
UDP relay list/UDP ports 1, 2, 3 45
UDP relay/mode 45
UDP relay/UDP relay list 45
upgrade menu 104
upgrade/abort transfer 105
upgrade/filename 104
upgrade/start transfer 105
upgrade/status 104
upgrade/TFTP host 104
upgrade/TFTP server 105
upgrade/transfer method 104
user list 84
user list/authen method 84
user list/idle time 84
user list/level 84
user list/name 84
user list/password 84
using keyboard to navigate menu 31
utilities menu 29, 103
utilities/exit 105
utilities/ping 103
utilities/Telnet client 104
utilities/upgrade menu 104

V

VJ compression 74

W

WAN indicators 17
WAN IP bridge 50
WAN IP bridge proxy ARP 51
WAN IP bridge/netmask 51
WAN IP bridge/network 51
WAN IP bridge/triggered 51
WAN IPX bridge 51
WAN IPX bridge/frame type 52
WAN IPX bridge/network 52
WAN IPX bridge/seed status 52
WAN IPX bridge/triggered 52
WAN menu 36
WAN port 54
WAN port 0/active 54
WAN port 0/path cost 54
WAN port 0/priority 54
WAN port 1/active 55
WAN port 1/path cost 55
WAN port 1/priority 55
WAN stats 95
WAN/ISDN 36
WAN/POTS 39
wiring 23, 24, 25

X

xmodem 104

Product Support Information

Presales Inquiries and Applications Support

Please contact your local distributor, ADTRAN Applications Engineering, or ADTRAN Sales:

Applications Engineering (800) 615-1176

Sales (800) 827-0807

Post-Sale Support

Please contact your local distributor first. If your local distributor cannot help, please contact ADTRAN Technical Support and have the unit serial number available.

Technical Support (888) 4ADTRAN

Repair and Return

If ADTRAN Technical Support determines that a repair is needed, Technical Support will coordinate with the Return Material Authorization (RMA) department to issue an RMA number. For information regarding equipment currently in house or possible fees associated with repair, contact RMA directly at the following number:

RMA Department (205) 963-8722

Identify the RMA number clearly on the package (below address), and return to the following address:

ADTRAN, Inc.
RMA Department
901 Explorer Boulevard
Huntsville, Alabama 35806

RMA # _____

Free Manuals Download Website

<http://myh66.com>

<http://usermanuals.us>

<http://www.somanuals.com>

<http://www.4manuals.cc>

<http://www.manual-lib.com>

<http://www.404manual.com>

<http://www.luxmanual.com>

<http://aubethermostatmanual.com>

Golf course search by state

<http://golfingnear.com>

Email search by domain

<http://emailbydomain.com>

Auto manuals search

<http://auto.somanuals.com>

TV manuals search

<http://tv.somanuals.com>