



ATLAS 550 System Manual

- 1200305L1 ATLAS 550 Chassis - AC Power (Domestic Version)**
- 1200306L1 ATLAS 550 Chassis - AC Power (International Version)**
- 1200550L1 ATLAS 550 Chassis - DC Power (Domestic Version)**

61200305L1-1F
October 2002

Trademarks

Any brand names and product names included in this manual are trademarks, registered trademarks, or trade names of their respective holders.

To the Holder of the Manual

The contents of this manual are current as of the date of publication. ADTRAN reserves the right to change the contents without prior notice.

In no event will ADTRAN be liable for any special, incidental, or consequential damages or for commercial losses even if ADTRAN has been advised thereof as a result of issue of this publication.



901 Explorer Boulevard
P.O. Box 140000
Huntsville, AL 35814-4000
Phone: (256) 963-8000

©2002 ADTRAN, Inc.
All Rights Reserved.
Printed in U.S.A.

About this Manual

This manual provides a complete description of the ATLAS 550 system and system software. The purpose of this manual is to provide the technician, system administrator, and manager with general and specific information related to the planning, installation, operation, and maintenance of the ATLAS 550. This manual is arranged so that needed information can be quickly and easily found. The following is an overview of the contents.

Section 1	System Description	15
	Provides managers with an overview of the ATLAS 550 system.	
Section 2	Engineering Guidelines	23
	Provides equipment dimensions, power requirements, front panel design, rear panel design, LEDs, and at-a-glance specifications.	
Section 3	Network Turnup Procedure	51
	Provides shipment contents list, grounding instructions, mounting options, and specifics of supplying power to the unit.	
Section 4	User Interface Guide	61
	Provides detailed descriptions of all menu options and configuration parameters available for the ATLAS 550.	
Section 5	Detail Level Procedures	315
	Provides instructions on how to perform basic unit functions such as: Connection Log-in Adding/removing telnet users and changing passwords Setting IP parameters and verifying LAN communication Telnet Firmware Upgrade Saving and loading configuration files	
Section 6	Configuration Guides	363
	Provides detailed instructions for configuring the ATLAS 550 for the most common applications.	
Section 7	System Event Logging	377
	Explains the System Event Logging messages for the ATLAS 550 and provides instructions for configuring the Event Log.	
Section 8	ADTRAN Utilities	391
	Provides instructions for configuring and using the ADTRAN Utilities software programs including Telnet, VT100, Syslog, and TFTP.	

Section 9 MIB 401

Provides instructions for configuring and using the ADTRAN Utilities software programs including Telnet, VT100, Syslog, and TFTP.

Revision History

This is the 5th issue of this manual. Revisions made include the following:

- Addition of the Octal Basic Rate ISDN (S/T Interface) Option Module and associated menus in the Dial Plan
- Addition of the DC-powered ATLAS 550 chassis
- Corrected menus for the Octal BRI (U-Interface) Option Module in the Dial Plan
- Changed the name of the NxT1 HSSI Option Module to the NxT1 HSSI/V.35 Option Module
- Addition of the Ethernet Switch Option Module and associated menus



Notes provide additional useful information.



Cautions signify information that could prevent service interruption.



Warnings provide information that could prevent damage to the equipment or endangerment to human life.

Safety Instructions

When using your telephone equipment, please follow these basic safety precautions to reduce the risk of fire, electrical shock, or personal injury:

1. Do not use this product near water, such as a bathtub, wash bowl, kitchen sink, laundry tub, in a wet basement, or near a swimming pool.
2. Avoid using a telephone (other than a cordless-type) during an electrical storm. There is a remote risk of shock from lightning.
3. Do not use the telephone to report a gas leak in the vicinity of the leak.
4. Use only the power cord, power supply, and/or batteries indicated in the manual. Do not dispose of batteries in a fire. They may explode. Check with local codes for special disposal instructions.

Save These Important Safety Instructions

Affidavit Requirements for Connection to Digital Services

- An affidavit is required to be given to the telephone company whenever digital terminal equipment without encoded analog content and billing protection is used to transmit digital signals containing encoded analog content which are intended for eventual conversion into voiceband analog signals and transmitted on the network.
- The affidavit shall affirm that either no encoded analog content or billing information is being transmitted or that the output of the device meets Part 68 encoded analog content or billing protection specifications.
- End user/customer will be responsible for filing an affidavit with the local exchange carrier when connecting unprotected customer premise equipment (CPE) to 1.544 Mbps or subrate digital services.

Until such time as subrate digital terminal equipment is registered for voice applications, the affidavit requirement for subrate services is waived.

**Affidavit for Connection of Customer Premises Equipment
to 1.544 Mbps and/or Subrate Digital Services**

For the work to be performed in the certified territory of _____ (telco name)

State of _____

County of _____

I, _____ (name), _____ (business address),
_____ (telephone number) being duly sworn, state:

I have responsibility for the operation and maintenance of the terminal equipment to be connected to 1.544 Mbps and/or _____ subrate digital services. The terminal equipment to be connected complies with Part 68 of the FCC rules except for the encoded analog content and billing protection specifications. With respect to encoded analog content and billing protection:

- I attest that all operations associated with the establishment, maintenance, and adjustment of the digital CPE with respect to analog content and encoded billing protection information continuously complies with Part 68 of the FCC Rules and Regulations.
- The digital CPE does not transmit digital signals containing encoded analog content or billing information which is intended to be decoded within the telecommunications network.
- The encoded analog content and billing protection is factory set and is not under the control of the customer.

I attest that the operator(s)/maintainer(s) of the digital CPE responsible for the establishment, maintenance, and adjustment of the encoded analog content and billing information has (have) been trained to perform these functions by successfully having completed one of the following (check appropriate blocks):

- A. A training course provided by the manufacturer/grantee of the equipment used to encode analog signals; or
- B. A training course provided by the customer or authorized representative, using training materials and instructions provided by the manufacturer/grantee of the equipment used to encode analog signals; or
- C. An independent training course (e.g., trade school or technical institution) recognized by the manufacturer/grantee of the equipment used to encode analog signals; or
- D. In lieu of the preceding training requirements, the operator(s)/maintainer(s) is (are) under the control of a supervisor trained in accordance with _____ (circle one) above.

I agree to provide _____ (telco's name) with proper documentation to demonstrate compliance with the information as provided in the preceding paragraph, if so requested.

Signature

Title

Date

Transcribed and sworn to before me

This _____ day of _____, _____

Notary Public

My commission expires:

FCC regulations require that the following information be provided in this manual:

1. This equipment complies with Part 68 of FCC rules. On the back of the equipment housing is a label showing the FCC registration number and ringer equivalence number (REN). If requested, provide this information to the telephone company.
2. If this equipment causes harm to the telephone network, the telephone company may temporarily discontinue service. If possible, advance notification is given; otherwise, notification is given as soon as possible. The telephone company will advise the customer of the right to file a complaint with the FCC.
3. The telephone company may make changes in its facilities, equipment, operations, or procedures that could affect the proper operation of this equipment. Advance notification and the opportunity to maintain uninterrupted service are given.
4. If experiencing difficulty with this equipment, please contact ADTRAN for repair and warranty information. The telephone company may require this equipment to be disconnected from the network until the problem is corrected or it is certain the equipment is not malfunctioning.
5. This unit contains no user-serviceable parts.
6. An FCC compliant telephone cord with a modular plug is provided with this equipment. This equipment is designed to be connected to the telephone network or premises wiring using an FCC compatible modular jack, which is Part 68 compliant.
7. The following information may be required when applying to the local telephone company for a dial-up line for the V.34 modem:

Service Type	REN	FIC	USOC
Loop Start	1.6B/0.8A	02LS2	RJ-11C

8. The REN is useful in determining the quantity of devices you may connect to your telephone line and still have all of those devices ring when your number is called. In most areas, the sum of the RENs of all devices should not exceed five. To be certain of the number of devices you may connect to your line as determined by the REN, call your telephone company to determine the maximum REN for your calling area.
9. This equipment may not be used on coin service provided by the telephone company. Connection to party lines is subject to state tariffs. Contact your state public utility commission or corporation commission for information.

Federal Communications Commission Radio Frequency Interference Statement

This equipment has been tested and found to comply with the limits for a Class A digital device, pursuant to Part 15 of the FCC Rules. These limits are designed to provide reasonable protection against harmful interference when the equipment is operated in a commercial environment. This equipment generates, uses, and can radiate radio frequency energy and, if not installed and used in accordance with the instruction manual, may cause harmful interference to radio frequencies. Operation of this equipment in a residential area is likely to cause harmful interference in which case the user will be required to correct the interference at his own expense.



NOTE

Shielded cables must be used with this unit to ensure compliance with Class A FCC limits.

WARNING

Changes or modifications to this unit not expressly approved by the party responsible for compliance could void the user's authority to operate the equipment.

Industry Canada Compliance Information

Notice: The Industry Canada label applied to the product (identified by the Industry Canada logo or the "IC:" in front of the certification/registration number) signifies that the Industry Canada technical specifications were met.

Notice: The Ringer Equivalence Number (REN) for this terminal equipment is supplied in the documentation or on the product labeling/markings. The REN assigned to each terminal device indicates the maximum number of terminals that can be connected to a telephone interface. The termination on an interface may consist of any combination of devices subject only to the requirement that the sum of the RENs of all the devices should not exceed five (5).

Canadian Emissions Requirements

This digital apparatus does not exceed the Class A limits for radio noise emissions from digital apparatus as set out in the interference-causing equipment standard entitled "Digital Apparatus," ICES-003 of the Department of Communications.

Cet appareil numérique respecte les limites de bruits radioélectriques applicables aux appareils numériques de Class A prescrites dans la norme sur le matériel brouilleur: "Appareils Numériques," NMB-003 édictée par le ministre des Communications.

Warranty and Customer Service

ADTRAN will repair and return this product within 5 years from the date of shipment if it does not meet its published specifications or fails while in service. For detailed warranty, repair, and return information refer to the ADTRAN Equipment Warranty and Repair and Return Policy Procedure.

Return Material Authorization (RMA) is required prior to returning equipment to ADTRAN.

For service, RMA requests, or further information, contact one of the numbers listed at the end of this section.

LIMITED PRODUCT WARRANTY

ADTRAN warrants that for 5 years from the date of shipment to Customer, all products manufactured by ADTRAN will be free from defects in materials and workmanship. ADTRAN also warrants that products will conform to the applicable specifications and drawings for such products, as contained in the Product Manual or in ADTRAN's internal specifications and drawings for such products (which may or may not be reflected in the Product Manual). This warranty only applies if Customer gives ADTRAN written notice of defects during the warranty period. Upon such notice, ADTRAN will, at its option, either repair or replace the defective item. If ADTRAN is unable, in a reasonable time, to repair or replace any equipment to a condition as warranted, Customer is entitled to a full refund of the purchase price upon return of the equipment to ADTRAN. This warranty applies only to the original purchaser and is not transferable without ADTRAN's express written permission. This warranty becomes null and void if Customer modifies or alters the equipment in any way, other than as specifically authorized by ADTRAN.

EXCEPT FOR THE LIMITED WARRANTY DESCRIBED ABOVE, THE FOREGOING CONSTITUTES THE SOLE AND EXCLUSIVE REMEDY OF THE CUSTOMER AND THE EXCLUSIVE LIABILITY OF ADTRAN AND IS IN LIEU OF ANY AND ALL OTHER WARRANTIES (EXPRESSED OR IMPLIED). ADTRAN SPECIFICALLY DISCLAIMS ALL OTHER WARRANTIES, INCLUDING (WITHOUT LIMITATION), ALL WARRANTIES OF MERCHANTABILITY AND FITNESS FOR A PARTICULAR PURPOSE. SOME STATES DO NOT ALLOW THE EXCLUSION OF IMPLIED WARRANTIES, SO THIS EXCLUSION MAY NOT APPLY TO CUSTOMER.

In no event will ADTRAN or its suppliers be liable to the Customer for any incidental, special, punitive, exemplary or consequential damages experienced by either the Customer or a third party (including, but not limited to, loss of data or information, loss of profits, or loss of use). ADTRAN is not liable for damages for any cause whatsoever (whether based in contract, tort, or otherwise) in excess of the amount paid for the item. Some states do not allow the limitation or exclusion of liability for incidental or consequential damages, so the above limitation or exclusion may not apply to the Customer.

Customer Service, Product Support Information, and Training

ADTRAN will repair and return this product if within 5 years from the date of shipment the product does not meet its published specification or the product fails while in service.

A return material authorization (RMA) is required prior to returning equipment to ADTRAN. For service, RMA requests, training, or more information, use the contact information given below.

Repair and Return

If you determine that a repair is needed, please contact our Customer and Product Service (CAPS) department to have an RMA number issued. CAPS should also be contacted to obtain information regarding equipment currently in house or possible fees associated with repair.

CAPS Department (256) 963-8722

Identify the RMA number clearly on the package (below address), and return to the following address:

ADTRAN Customer and Product Service
901 Explorer Blvd. (East Tower)
Huntsville, Alabama 35806

RMA # _____

Pre-Sales Inquiries and Applications Support

Your reseller should serve as the first point of contact for support. If additional pre-sales support is needed, the ADTRAN Support web site provides a variety of support services such as a searchable knowledge base, latest product documentation, application briefs, case studies, and a link to submit a question to an Applications Engineer. All of this, and more, is available at:

<http://support.adtran.com>

When needed, further pre-sales assistance is available by calling our Applications Engineering Department.

Applications Engineering (800) 615-1176

Post-Sale Support

Your reseller should serve as the first point of contact for support. If additional support is needed, the ADTRAN Support web site provides a variety of support services such as a searchable knowledge base, updated firmware releases, latest product documentation, service request ticket generation and trouble-shooting tools. All of this, and more, is available at:

<http://support.adtran.com>

When needed, further post-sales assistance is available by calling our Technical Support Center. Please have your unit serial number available when you call.

Technical Support (888) 4ADTRAN

Installation and Maintenance Support

The ADTRAN Custom Extended Services (ACES) program offers multiple types and levels of installation and maintenance services which allow you to choose the kind of assistance you need. This support is available at:

<http://www.adtran.com/aces>

For questions, call the ACES Help Desk.

ACES Help Desk (888) 874-ACES (2237)

Training

The Enterprise Network (EN) Technical Training Department offers training on our most popular products. These courses include overviews on product features and functions while covering applications of ADTRAN's product lines. ADTRAN provides a variety of training options, including customized training and courses taught at our facilities or at your site. For more information about training, please contact your Territory Manager or the Enterprise Training Coordinator.

Training Phone (800) 615-1176, ext. 7500
Training Fax (256) 963-6700
Training Email training@adtran.com

SYSTEM DESCRIPTION

This section of ADTRAN's ATLAS 550 *System Manual* is designed for use by network engineers, planners, and designers for overview information about the ATLAS 550.

It contains general information and describes physical and operational concepts, card functions, network relationships, provisioning, testing, alarm status, and system monitoring. This section should be used in conjunction with Section 2, *Engineering Guidelines*, of the system manual.

CONTENTS

System Overview	16
Features and Benefits	16
Configuration and Management	16
Software Upgradeable	16
Signaling Support	16
ISDN Switch Types	17
Dedicated Connection Maps	17
Switched Connection Maps	17
Testing	17
Performance Monitoring	17
Frame Relay	17
PPP Switching	17
Option Modules	18
T1/PRI Network Interface Module (P/N 1200307L1)	18
E1/PRA Network Interface Module (P/N 1200308L1)	19
Modem Management Network Module (P/N 1200341L1)	19
BRI DBU Network Interface Module (P/N 1200327L1)	19
Dual Nx 56/64 Option Module (P/N 1200311L1)	19
Dual USSI Option Module (P/N 1200754L1)	19
Dual/Quad T1/PRI Option Module (P/N 1200314L1/1200755L1)	19
Quad Basic Rate ISDN (U-Interface) Option Module (P/N1200315L1)	19
Quad Basic Rate ISDN (S/T-Interface) Option Module (P/N 1200764L1)	19
Octal/Quad FXS Option Module (P/N 1200309L1/1200328L1)	20
Octal/Quad FXO Option Module (P/N 1200310L1/1200329L1)	20
Local E&M Option Module (P/N 1200313L1)	20
Legacy Data Option Module (P/N 1200342L1)	20
NxT1 HSSI/V.35 Option Module (P/N 1200346L2)	20
Octal Ethernet Switch Option Module (P/N 1200766L1)	20
Resource Host Module (P/N 1200324L1)	20
4,8,16,24 Channel Voice Compression Resource Modules (P/N 1200312Lx)	21
32 Channel ADPCM Resource Module (P/N 1200752L1)	21
Nx 56/64 BONDing Resource Module (P/N 1200326L1)	21

1. SYSTEM OVERVIEW

The ATLAS 550 is a modular, highly scalable platform that provides robust solutions for the wide-area communication needs of small-to-medium corporations and network access providers. The ATLAS 550 is an Integrated Access System with extensive support of dedicated bandwidth management and access switching. It contains a high-performance CPU and powerful communications drivers which support applications such as frame relay, dial-backup, and PPP (point-to-point protocol).

The ATLAS 550 architecture also includes a packet and circuit switching bussing scheme. The result is a system capable of supporting bandwidth requirements of up to 9 T1 circuits or 5 Primary Rate ISDN (PRI) circuits. Designed for standalone, rackmount, or wallmount installations, the ATLAS 550 base unit provides two hot-swappable network interfaces and four expansion slots that accommodate hot-swappable option modules for a variety of applications. A 10/100BaseT Ethernet connection for IP routing and network management is standard with the ATLAS 550 base unit.

With the ATLAS 550, you can consolidate your voice, data, and video applications into a single platform while optimizing wide area bandwidth and reducing equipment costs. The ATLAS 550 architecture and the four expansion slots allow for a variety of modules, making it one of the most versatile access systems on the market.

2. FEATURES AND BENEFITS

The following is a brief list of ATLAS 550 features and benefits:

Configuration and Management

- VT100 Emulation
- SNMP, per MIB II (RFC1213), DS1/E1 MIB (RFC1406), Frame Relay MIB (RFC1315), and ADTRAN private MIBs
- Telnet
- Dial up remote management via optional Modem Management Network Module (P/N 1200341L1)
- Six levels of password protection and privileges

Software Upgradeable

- Flash memory
- TFTP download
- XMODEM via control port

Signaling Support

- ISDN D Channel
- Robbed bit, E&M, Ground Start, Loop Start
- Convert between Robbed Bit Signaling and ISDN D Channel
- Direct Inward Dialing

ISDN Switch Types

- 5ESS™, DMS-100™, National ISDN, 4ESS™, EuroISDN

Dedicated Connection Maps

- Up to five connection maps
- Time of day/day of week configurable
- Preserves signaling through cross-connect
- No effect on non-configured channels

Switched Connection Maps

- Inbound and outbound call filtering and blocking

Testing

- Local and remote: payload/line, V.54 (depending on installed modules)
- Patterns: 511, QRSS, all ones, all zeros (depending on installed modules)

Performance Monitoring

- Reports: Information stored for last 24 hours in 15 minute increments
- Performance statistics per TR54016, T1.403, RFC1406
- Alarm reporting per TR54016, T1.403

Frame Relay

- Routes Internet Protocol (IP) traffic between a public frame relay network, a private frame relay network, or a point-to-point (PPP) network and the Ethernet port.
- Concentrates IP traffic from a public or private frame relay network to one or more serial ports (V.35). The protocol passed over the serial port is frame relay (RFC 1490 encapsulation).
- Passes Systems Network Architecture (SNA), Bisync, and other legacy protocols between a public or private frame relay network and an external DTE running frame relay to ATLAS.
- Performs voice compression/decompression (G.723.1) and interfaces to either a Private Branch Exchange (PBX) or the Public Switched Telephone Network (PSTN). (This feature requires an additional option module, the VCOM Module—P/N 1200312Lx.)
- Performs voice packetization (G.711 or Transparent) or voice compression/decompression (G.726) and interfaces to either a Private Branch Exchange (PBX) or the PSTN. (This feature requires an additional option module, the 32 Channel ADPCM Resource Module - P/N 1200752L1.)
- Supports LMI, Annex D, or Annex A signaling on frame relay connections.

PPP Switching

- Supports up to 100 simultaneous PPP connections.
- Performs PAP, CHAP, or EAP authentication methods on a per connection basis.
- Includes keepalive functionality for PPP connections.
- Provides capability for numbered or unnumbered PPP interfaces.

3. OPTION MODULES

The ATLAS 550 has 25 option modules:

- T1/PRI Network Interface Module (P/N 1200307L1)
- E1/PRA Network Interface Module (P/N 1200308L1)
- Modem Management Network Module (P/N 1200341L1)
- BRI DBU Network Interface Module (P/N 1200327L1)
- Dual Nx 56/64 Option Module (P/N 1200311L1)
- Dual USSI Option Module (P/N 1200754L1)
- Dual/Quad T1/PRI Option Module (P/N 1200314L1/1200755L1))
- Quad Basic Rate ISDN (U-Interface) Option Module (P/N1200315L1)
- Quad Basic Rate ISDN (S/T-Interface) Option Module (P/N1200764L1)
- Octal/Quad FXS Option Module (P/N 1200309L1/1200328L1)
- Octal/Quad FXO Option Module (P/N 1200310L1/1200329L1)
- Octal E&M Option Module (P/N 1200313L1)
- Octal Ethernet Switch Option Module (P/N 1200766L1)
- Resource Host Module (P/N 1200324L1)
- 4,8,16,24 Channel Voice Compression Resource Modules (P/N 1200312Lx)
- 32 Channel ADPCM Resource Module (P/N 1200752L1)
- Nx 56/64 BONDing Resource Module (P/N 1200326L1)
- Legacy Data Option Module (P/N 1200342L1)
- NxT1 HSSI/V.35 Option Module (P/N 1200346L2)

Each option module is hot-swappable with configuration restored upon replacement.



Replacing an option module with a different module type will result in configuration loss.

Each option module has a variety of performance and alarm status information. Several features of each module are user-configurable, although default values reflect the most common configurations. All option modules contain an extensive self-test as well as tests designed for the technology they incorporate.

T1/PRI Network Interface Module (P/N 1200307L1)

The T1/PRI Network Interface Module provides one channelized T1 or PRI interface. This interface operates in DS-1 or DSX-1 mode and can deliver timing for the system. The ATLAS 550 domestic system (P/N 1200305L1) ships with one installed T1/PRI Network Interface Module.

E1/PRA Network Interface Module (P/N 1200308L1)

The E1/PRA Network Interface Module provides one channelized E1 or PRA interface using either a standard DB-15 or BNC connector. This interface operates in CCS or CAS signaling mode and can deliver timing for the system. The ATLAS 550 international system (P/N 1200306L1) ships with one installed E1/PRA Network Interface Module.

Modem Management Network Module (P/N 1200341L1)

The Modem Management Network Module provides a single analog interface (RJ-11) for dial-up remote management of the ATLAS 550 System. The internal modem supports connection rates from 2400 to 33.6 K and performs standard data modulation, error correction, and data compression.

BRI DBU Network Interface Module (P/N 1200327L1)

The BRI DBU Network Interface Module provides a single Basic Rate ISDN (BRI) U interface, capable of operating in either NT or LT mode and can deliver timing for the system. The BRI DBU Network Interface Module supports two independent calls or one BONDED call. All BONDing functionality is provided on the module so a BONDing resource module (1200326L1) is not required.

Dual Nx 56/64 Option Module (P/N 1200311L1)

The Dual Nx 56/64 Module provides two synchronous V.35 DTE ports that can operate from 56 K to 2.048 Mbps in steps of 56 or 64 kbps. Either port can deliver timing for the system.

Dual USSI Option Module (P/N 1200754L1)

The Dual USSI Option Module provides two synchronous DTE ports that can operate from 56 K to 2.048 Mbps in steps of 56 or 64 kbps. Either port can deliver timing for the system. The Dual USSI Option Module can provide the following interfaces using the appropriate adapter cables: EIA-530, EIA-530A, RS-449, RS-232, and CCITT X.21.

Dual/Quad T1/PRI Option Module (P/N 1200314L1/1200755L1)

The Dual/Quad T1/PRI Module provides two or four channelized T1 or PRI interfaces. Each interface can operate independently in DS-1 or DSX-1 mode, and any port can deliver timing for the system.

Quad Basic Rate ISDN (U-Interface) Option Module (P/N1200315L1)

The Quad Basic Rate ISDN (U) Module provides four Basic Rate ISDN (BRI) U interfaces, each capable of operating in either NT or LT mode. Any port (operating in NT mode) can deliver timing for the system.

Quad Basic Rate ISDN (S/T-Interface) Option Module (P/N 1200764L1)

The Quad Basic Rate ISDN (S/T) Module provides four Basic Rate ISDN (BRI) S/T interfaces, each capable of operating in either NT (future) or LT mode. Any port (operating in NT (future) mode) can deliver timing for the system.

Octal/Quad FXS Option Module (P/N 1200309L1/1200328L1)

The Octal/Quad FXS Option Modules provide eight or four analog voice-grade interfaces. Each interface provides talk battery, off-hook supervision, E&M signaling conversion, and ringing in loop-start or ground-start operation. Call progress tones, where necessary, are provided to the modules by the ATLAS 550 base unit.

Octal/Quad FXO Option Module (P/N 1200310L1/1200329L1)

The Octal/Quad FXO Option Modules provide eight or four analog voice-grade interfaces. Each interface supports loop-start and ground-start operation. Applications include termination of analog PSTN trunks and connections to PBX station-side interfaces (OPX).

Octal E&M Option Module (P/N 1200313L1)

The Octal E&M Option Module provides eight analog voice-grade interfaces, either 2-wire or 4-wire, for use as tie-trunks, using E&M signaling or as dedicated transmission only (TO) interfaces for additional data services. E&M signaling types 1-5 are supported.

Legacy Data Option Module (P/N 1200342L1)

The Legacy Data Option Module provides four EIA-232 or V.35 interfaces (or any combination up to four) for sync or async packet data applications. Protocols supported include SNA/SDLC, frame relay, PPP, transparent bit-oriented (TBOP), and transparent async. The Legacy Data Option Module includes an adapter cable to provide four EIA-232 (DB-25) interfaces. An optional V.35 adapter cable (P/N 1200348L1) is also available.

NxT1 HSSI/V.35 Option Module (P/N 1200346L2)

The NxT1 HSSI/V.35 Option Module aggregates bandwidth of up to eight T1s into a single logical channel on the HSSI or V.35 (using an optional adapter cable) interface. The NxT1 HSSI/V.35 Option Module supports point-to-point T1 applications only. Any of the four built-in T1 ports of the NxT1 HSSI/V.35 Option Module can provide timing for the ATLAS 550 system.

Octal Ethernet Switch Option Module (P/N 1200766L1)

The Octal Ethernet Switch Option Module provides eight interfaces that can operate as 10BaseT or 100BaseTX. Each interface uses auto-negotiation to support Ethernet traffic at 10 Mbps or 100 Mbps, half-duplex or full-duplex. Automatic MDI/MDIX crossover is provided to simplify LAN connections.

Resource Host Module (P/N 1200324L1)

The Resource Host Module provides an inexpensive way to use a desired plug-on resource module, such as the Voice Compression Module, when a plug-in module is not necessary. This module has no other functionality except to act as the base for the plug-on resource modules.

4,8,16,24 Channel Voice Compression Resource Modules (P/N 1200312Lx)

The Voice Compression Module (VCOM Module) combines with other ATLAS 550 components to implement voice over frame relay (VoFR) capability. The Voice Compression Resource Modules support 4, 8, 16, or 24 simultaneous compressed calls using G.723.1 or Netcoder compression algorithms.

32 Channel ADPCM Resource Module (P/N 1200752L1)

The 32 Channel ADPCM Resource Module (ADPCM-32) combines with other ATLAS 550 components to implement packet voice capability over frame relay. The 32 Channel ADPCM Resource Module supports up to 32 simultaneously compressed or packetized calls using G.726, G.711, or Transparent algorithms.

Nx 56/64 BONDing Resource Module (P/N 1200326L1)

The Nx 56/64 BONDing Resource Option Module supports multiple, independent BONDing sessions with each session capable of using from 2 to 32 channels of 56 K or 64 K data. The Nx 56/64 BONDing Resource Module combines with other ATLAS 550 components to provide a flexible disaster recovery system.

ENGINEERING GUIDELINES

CONTENTS

Equipment Dimensions	25
Power Requirements	25
Reviewing the Front Panel Design	25
ACO Switch	25
CRAFT Port	26
Front Panel LEDs	26
Reviewing the Rear Panel Design	29
AC System	29
DC System	29
CONTROL IN Port	30
CONTROL OUT Port	30
Ethernet Connection	31
Alarm Relay Connection	31
External Alarm Relay Monitor Connection	32
Network Interface Modules	32
T1/PRI Network Interface Module (P/N 1200307L1)	32
E1/PRA Network Interface Module (P/N 1200308L1)	33
Modem Management Network Module (P/N 1200341L1)	34
BRI DBU Network Module (P/N 1200327L1)	35
Option Module Interfaces	35
Octal/Quad FXS Option Module (P/N 1200309L1/1200328L1)	35
Octal/Quad FXO Option Module (P/N 1200310L1/1200329L1)	36
Dual Nx 56/64 Option Module (P/N 1200311L1)	36
Dual USSI Option Module (P/N 1200754L1)	37
Octal E&M Option Module (P/N 1200313L1)	41
Dual/Quad T1/PRI Option Module (P/N 1200314L1/1200755L1)	42
Quad BRI (U-Interface) Option Module (P/N 1200315L1)	42
Quad BRI ISDN (S/T Interface) Option Module (P/N 1200764L1)	43
NxT1 HSSI Option Module (P/N 1200346L1)	43
NxT1 HSSI/V.35 Option Module (P/N 1200346L2)	44
Legacy Data Option Module (P/N 1200342L1)	45
Octal Ethernet Switch Option Module (P/N 1200766L1)	46
At-A-Glance Specifications	47

FIGURES

Figure 1. ATLAS 550 Front Panel Layout	25
Figure 2. ATLAS 550 (AC System) Rear Panel	29
Figure 3. ATLAS 550 (DC System) Rear Panel	29

TABLES

Table 1.	CRAFT Port Pinout	26
Table 2.	ATLAS 550 Front Panel Description	26
Table 3.	ATLAS 550 LEDs	27
Table 4.	CONTROL IN Pinout	30
Table 5.	CONTROL OUT Pinout	30
Table 6.	Ethernet Pinout	31
Table 7.	Alarm Relay Connector Pinout	31
Table 8.	External Relay Monitor Connector Pinout	32
Table 9.	T1/PRI Network Interface Module RJ-48C Pinout	32
Table 10.	T1/PRI Network Interface 15-pin Male D-connector Pinout	33
Table 11.	E1/PRA Network Interface 15-pin Female D-connector Pinout	34
Table 12.	Modem Management Network Module 6-pin Modular Jack Pinout	34
Table 13.	BRI Pinout	35
Table 14.	FXS Pinout	35
Table 15.	FXO Pinout	36
Table 16.	V.35 Winchester Pinout	36
Table 17.	DB-78 Connector Pinout	37
Table 18.	EIA-530 Connector Pinout	38
Table 19.	EIA-530A Connector Pinout	39
Table 20.	RS-449/V.36 Connector Pinout	39
Table 21.	RS-232 Connector Pinout	40
Table 22.	CCITT X.21/V.11 Connector Pinout	41
Table 23.	E&M Pinout	41
Table 24.	Trunk Circuit Connections for Various E&M Signaling Types	42
Table 25.	T1/PRI Pinout	42
Table 26.	BRI Pinout (U-Interface)	42
Table 27.	BRI Pinout (S/T Interface)	43
Table 28.	HSSI (SCSI-50) Connection Pinout	43
Table 29.	HSSI/V.35 Connection Pinout	44
Table 31.	EIA-232 and V.35 Connection Pinouts	45
Table 30.	T1 Network Connection Pinout	45
Table 32.	Ethernet Pinout	46
Table 33.	Specifications	47

1. EQUIPMENT DIMENSIONS

The ATLAS 550 base unit is 17.08" W, 11.67" D, and 3.47" H. All other equipment (option modules) fit inside the base unit.

2. POWER REQUIREMENTS

The ATLAS 550 has a maximum power consumption of 60 W and a maximum current draw of 2 A (AC System) or 5 A (DC System) regardless of the configuration of option modules installed in the base unit.

3. REVIEWING THE FRONT PANEL DESIGN

The front panel contains the Alarm Cut-off (**ACO**) switch, the **CRAFT** port, and the controller and module status LEDs. The LEDs provide visual information about the ATLAS 550 base unit and any option module that may be installed. Figure 1 identifies the **ACO** switch, the **CRAFT** port, and the LEDs.

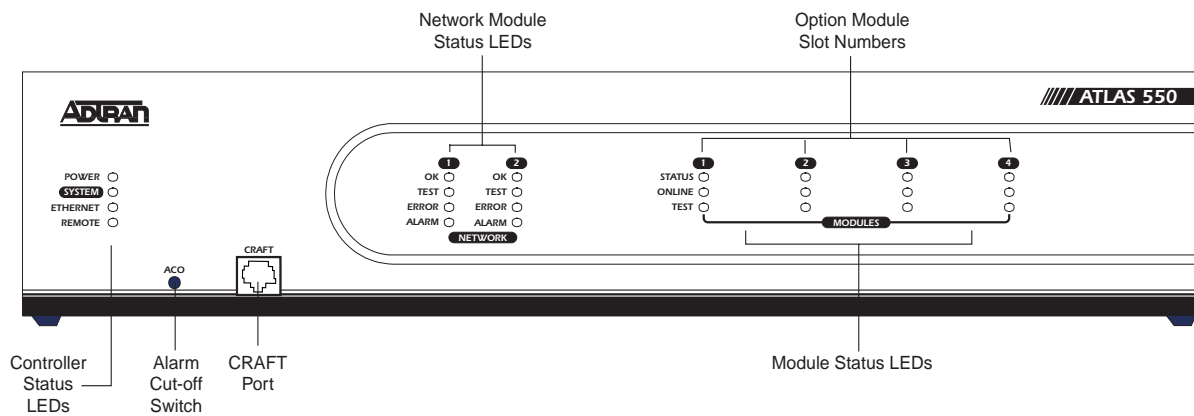

Figure 1. ATLAS 550 Front Panel Layout

ACO Switch

The **ACO** switch deactivates (clears) the Alarm Relay, located on the rear panel of the ATLAS 550, after an alarm condition has occurred. If an alarm condition is corrected and then reoccurs, the Alarm Relay will re-energize.

CRAFT Port

Use the **CRAFT** port to configure the system via an EIA-232 connection. The **CRAFT** port provides the same functions and operations as the **CONTROL IN** port located on the rear panel of the ATLAS 550. The connector type is shown below, and Table 1 gives the **CRAFT** port pinout.

Connector type RJ-48C

Table 1. CRAFT Port Pinout

PIN	NAME	DESCRIPTION
1	GND	Ground - connected to unit chassis
2	RTS	Request to send - flow control
3	RXDATA	Data received by the ATLAS 550
4	DTR	Data terminal ready
5	TXDATA	Data transmitted by the ATLAS 550
6	CD	Carrier detect
7	UNUSED	—
8	CTS	Clear to send - flow control

Front Panel LEDs

With the ATLAS 550 powered-up, the front panel LEDs provide visual information about the status of the ATLAS 550 and any option modules that may be installed. Table 2 provides a brief description of the front panel features, and Table 3 on page 27 provides detailed information about the LEDs.

Table 2. ATLAS 550 Front Panel Description

Feature	Description
Controller Status LEDs	Displays the general status of the entire ATLAS 550. (See Table 3 on page 27.)
Power	Indicates the unit is on or off.
System	Indicates the status of the system.
Ethernet	Indicates the status of the Ethernet port.
Remote	Indicates whether a user is logged into the unit.
Network Module LEDs	Displays the status of the network interface. (See Table 3 on page 27.) All LEDs are off if no network module is installed.
OK	Indicates that the network interface is operating correctly.
Test	Indicates that the network interface is in test mode.
Error	Blinks to indicate the occurrence of error events.
Alarm	Indicates an alarm condition on the network interface.

Table 2. ATLAS 550 Front Panel Description (Continued)

Feature	Description
Option Module LEDs	Displays (by row) the operational condition of each module installed in the option slots. (See Table 3 on page 27.) All LEDs will be off if no option module is installed.
Status	Indicates the operational condition of modules installed in the option slots.
Online	Indicates whether the module is available for use or is currently in use. If the module is manually taken offline, this LED is turned off.
Test	Indicates that one or more ports within a module are in test.
ACO Switch	Clears the Alarm Relay connection located on the rear panel of the ATLAS 550.
CRAFT Port	Allows the ATLAS 550 to connect to a computer or modem using the CRAFT port (an RJ-45 port).

Table 3. ATLAS 550 LEDs

For these LEDs...	This color light...	Indicates that...
Power	Green	the unit is on.
	Off	the unit is off.
Ethernet	Green (solid)	the physical link is up.
	Green (flashing)	there is activity on the LAN.
	Off	the physical link is down - no Ethernet connection.
Remote	Yellow	a user is logged in the system via CONTROL/CRAFT port or via Ethernet.
	Off	there are no users logged into the system.
System	Green (solid)	no diagnosed system faults were found.
	Green (fast blink)	a flash download is in progress.
	Yellow (solid)	a fault was diagnosed, but the condition no longer exists. The condition will be recorded in the system log.
	Red (solid)	an error condition with either the power supply or the system temperature is present.
	Red (fast blink)	a fatal error occurred during flash download.
	Off	power is not currently supplied to the system.

Table 3. ATLAS 550 LEDs (Continued)

For these LEDs...	This color light...	Indicates that...
Network Module Status	Green (solid)	the network interface is operating normally with error-free operation. If the interface experiences alarms, the OK LED remains off.
	Yellow (solid)	the interface is operating in a test mode. This includes a self-test, a test pattern, or a test loopback. When illuminated, this LED also indicates that normal data flow is not occurring in the module ports.
	Red (blink)	an error such as BPV (bipolar violation), OOF (out of frame), or CRC (cyclic redundancy check) has occurred.
	Red (solid)	an alarm condition has been detected. When the alarm condition is no longer valid, the OK LED illuminates. To view an alarm condition, select the active alarm menu item. If the alarm conditions have been corrected, you can view the alarm which caused the activation of the ALARM LED in the system log.
Module Status	Green (solid)	one or both modules (in the case of a Resource Module) are OK.
	Green (fast blink)	one or both modules (in the case of a Resource Module) have been set offline by the user. OR one or both modules (in the case of a Resource Module) have invalid flash memory.
	Red (solid)	a port on the installed module is currently in alarm.
	Red (fast blink)	one module has no response, has been removed, or is not supported.
	Red (slow blink)	one module is not ready.
	Off	no module occupies the slot.
Module Online	Green (solid)	one or both modules (in the case of a Resource Module) have an active connection.
	Green (fast blink)	one module has invalid flash memory or is downloading firmware.
	Green (slow blink)	one module has an active connection.
Module Test	Yellow (solid)	one module is in a test mode.

4. REVIEWING THE REAR PANEL DESIGN

AC System

The ATLAS 550 (AC System) rear panel contains four slots for housing option modules which provide a variety of additional resources and data ports. All slots are functionally identical. The ATLAS 550 also contains two slots for housing network modules (see Figure 2).

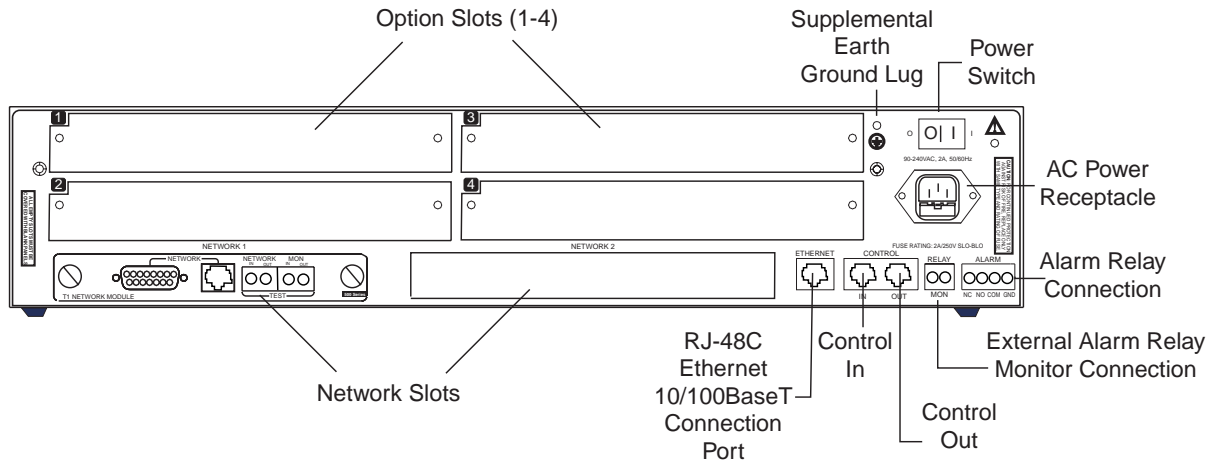

Figure 2. ATLAS 550 (AC System) Rear Panel

DC System

The ATLAS 550 (DC System) rear panel contains four slots for housing option modules which provide a variety of additional resources and data ports. All slots are functionally identical. The ATLAS 550 also contains two slots for housing network modules (see Figure 3).

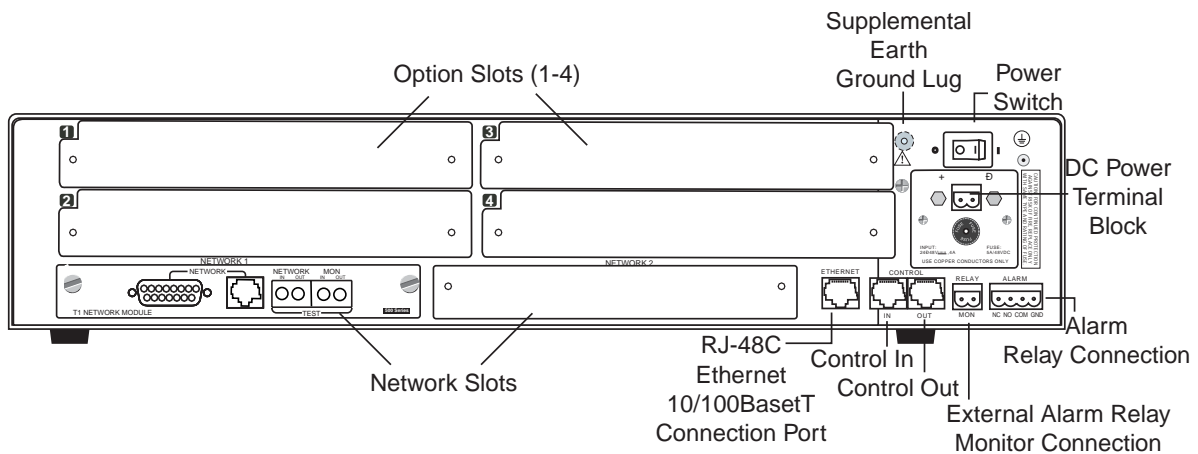

Figure 3. ATLAS 550 (DC System) Rear Panel

CONTROL IN Port

The **CONTROL IN** port (RJ-45) connects to a computer or modem or to another ATLAS 550 unit. The **CONTROL** port input provides the following functions:

- Accepts EIA-232 input from a PC or a modem (for controlling the ATLAS 550)
- Operates at 2400, 9600, 19200, or 38400 bps
- Acts as input for either VT100 terminal or PC (with terminal emulation software) control
- Acts as an interface for flash memory software downloads and configuration transfers using XMODEM

The **CONTROL IN** connection follows, and Table 4 shows the pinout.

Connector type RJ-48C

Table 4. CONTROL IN Pinout

PIN	NAME	DESCRIPTION
1	GND	Ground - connected to unit chassis
2	RTS	Request to send - flow control
3	RXDATA	Data received by the ATLAS 550
4	DTR	Data terminal ready
5	TXDATA	Data transmitted by the ATLAS 550
6	CD	Carrier detect
7	UNUSED	—
8	CTS	Clear to send - flow control

CONTROL OUT Port

The **CONTROL OUT** port (RJ-48C) connects to other ADTRAN products' **CHAIN IN** connectors. The **CONTROL** port output provides the following:

- EIA-232 output to chain control to other ADTRAN equipment, such as a TSU 120 or another ATLAS
- 2400, 9600, 19200, or 38400 bps operation
- Automatic setup; no user input required

The **CONTROL OUT** connection follows, and Table 5 shows the pinout.

Connector type RJ-48C

Table 5. CONTROL OUT Pinout

PIN	NAME	DESCRIPTION
1	GND	Ground - connected to unit chassis. Connects to GND of next unit.
2	UNUSED	—

Table 5. CONTROL OUT Pinout (Continued)

PIN	NAME	DESCRIPTION
3	TX DATA	Data transmitted to chained units by the ATLAS 550. Connects to RX DATA of the next unit.
4	UNUSED	—
5	RX DATA	Data received from chained units by the ATLAS 550. Connects to TX DATA of the next unit.
6,7,8	UNUSED	—

Ethernet Connection

The Ethernet port (RJ-48C) provides a 10/100BaseT Ethernet LAN connection, which is used for IP routing, TFTP, SNMP, and telnet connections. The network connection follows, and Table 6 shows the pinout.

Connector type (USOC) RJ-48C

Table 6. Ethernet Pinout

PIN	NAME	DESCRIPTION
1	TX1	Transmit Positive
2	TX2	Transmit Negative
3	RX1	Receive Positive
4, 5	UNUSED	—
6	RX2	Receive Negative
7, 8	UNUSED	—

Alarm Relay Connection

This connection alerts the user when a selected alarm condition exists. The 4-pin, removable terminal block connects with external wiring. Refer to DLP-014, *Connecting the Alarm Contacts* for detailed instructions. Clear the alarm condition by pressing the Alarm Cut-Off (**ACO**) switch located on the front panel of the ATLAS 550.

Table 7 shows the pinout for the Alarm Relay connector.

Table 7. Alarm Relay Connector Pinout

Pin	Name	Description
1	Normally Closed (NC)	Opens when a selected alarm condition is present.
2	Normally Open (NO)	Closes when a selected alarm condition is present.
3	Common (COM)	Common connection between external circuitry and NC or NO terminal.
4	Chassis Ground (GND)	

External Alarm Relay Monitor Connection

This connection alerts the user when a selected external alarm condition exists. This connection could be used to monitor a UPS with dry contacts or another ATLAS 550. The 2-pin, removable terminal block connects with external wiring. Refer to DLP-014, *Connecting the Alarm Contacts* for detailed instructions. Clear the alarm condition by pressing the **ACO** switch located on the front panel of the ATLAS 550.

Table 8 shows the pinout for the External Alarm Relay connector.

Table 8. External Relay Monitor Connector Pinout

Pin	Name	Description
1	Alarm Out	Outputs EIA-232 level signal for connection to external alarm contacts.
2	Alarm In	Monitors signal coming from external alarm contacts.

5. NETWORK INTERFACE MODULES

The ATLAS 550 provides two Network Interface Slots that allow different types of interfaces to be used. The following is a discussion of the available Network Interface Modules.

T1/PRI Network Interface Module (P/N 1200307L1)

The T1/PRI Network Interface (NI) Module provides a single T1/PRI port and complies with the applicable ANSI and AT&T® standards. The T1/PRI Network Interface Module provides the following functions:

- AMI or B8ZS coding
- Manual line build-out
- D4 or ESF framing
- Network performance monitoring and reporting
- Test loopbacks with QRSS generation and checking
- Extensive self-testing

The network connections follow, with the pinouts shown in Table 9 below and Table 10 on page 33.

Connector type (USOC) RJ-48C

Table 9. T1/PRI Network Interface Module RJ-48C Pinout

PIN	NAME		DESCRIPTION
1	R1	RXDATA-RING	Receive data from the network
2	T1	RXDATA-TIP	Receive data from the network
3	—	UNUSED	—
4	R	TXDATA-RING	Transmit data toward the network
5	T	TXDATA-TIP	Transmit data toward the network
6, 7, 8	—	UNUSED	—

Connector type 15-pin Male D-connector

Table 10. T1/PRI Network Interface 15-pin Male D-connector Pinout

PIN	NAME		DESCRIPTION
1	T	TXDATA-TIP	Transmit data toward the network
2	—	UNUSED	—
3	T1	RXDATA-TIP	Receive data from the network
4, 5, 6, 7	—	UNUSED	—
8	FG	FRAME GROUND	Grounded to chassis
9	R	TXDATA-RING	Transmit data toward the network
10	—	UNUSED	—
11	R1	RXDATA-RING	Receive data from the network
12, 13, 14	—	UNUSED	—
15	FG	FRAME GROUND	Grounded to chassis

Test Interface

The **NETWORK IN** and **OUT** Bantam test jacks provide intrusive test capability for the incoming T1. By connecting test equipment to these jacks, the T1 connection breaks and the test equipment terminates the incoming T1. The **MON IN** and **OUT** Bantam test jacks provide a bridged access jack for nonintrusive monitoring of the incoming T1. When connected to this jack, configure the test equipment for bridged termination.

E1/PRA Network Interface Module (P/N 1200308L1)

The E1/PRA Network Interface (NI) Module provides a single E1/PRA port the following functions:

- AMI or HDB3 coding
- Manual line build-out
- NFAS, FAS, TS16 MF and CRC-4 framing
- Supports CCS or CAS signaling
- Network performance monitoring and reporting
- Test loopbacks with QRSS generation and checking
- Extensive self-testing

The network connection follows, with the pinout shown in Table 11 on page 34.

Connector type 15-pin Female D-connector

Table 11. E1/PRA Network Interface 15-pin Female D-connector Pinout

PIN	NAME		DESCRIPTION
1	R	TXDATA-RING	Transmit data toward the network
2,4,5,7	FG	FRAME GROUND	Grounded to chassis
3	R1	RXDATA-RING	Receive data from the network
6,8,10,12 13,14,15	—	UNUSED	—
9	T	TXDATA-TIP	Transmit data toward the network
11	T1	RXDATA-TIP	Receive data from the network

Test Interface

The **NETWORK IN** and **OUT** Bantam test jacks provide intrusive test capability for the incoming E1. By connecting test equipment to these jacks, the E1 connection breaks and the test equipment terminates the incoming E1. The **MON IN** and **OUT** Bantam test jacks provide a bridged access jack for nonintrusive monitoring of the incoming E1. When connected to this jack, configure the test equipment for bridged termination.

Modem Management Network Module (P/N 1200341L1)

The Modem Management Network Module provides a single 6-pin modular jack. The Modem Management Network Module provides the following functions:

- V.34, V.32bis, V.32, V.22, V.23, and V.21 data modulation schemes
- Connection rates from 2400 to 33.6K baud
- V.42 LAPM, MNP 2-4, and MNP 10 error correction methods
- V.42bis and MNP 5 data compression algorithms

The network connection follows, with the pinout shown in Table 12 below.

Connector Type (USOC) RJ-11C

Table 12. Modem Management Network Module 6-pin Modular Jack Pinout

PIN	NAME	DESCRIPTION
1, 2, 3, 6	Unused	—
4	Ring	Ring to and from the analog interface
5	Tip	Tip to and from the analog interface

BRI DBU Network Module (P/N 1200327L1)

The BRI DBU Network Module provides a single 8-pin jack to connect to a standard BRI U-interface circuit. All BONDing functionality for 2B+D operation is provided on the module. Table 13 shows the pinout for this connection.

Connector Type (USOC) RJ-49C

Table 13. BRI Pinout

PIN	NAME	DESCRIPTION
1, 2, 3, 6, 7, 8	Unused	—
4	Ring	Ring to and from the Network Interface
5	Tip	Tip to and from the Network Interface

6. OPTION MODULE INTERFACES

Octal/Quad FXS Option Module (P/N 1200309L1/1200328L1)

Each port of the Octal/Quad FXS Option Module has a single 8-pin modular jack. Connector pinout is compatible with (USOC) RJ-11C and is shown in Table 14.

Connector Type (USOC) RJ-11C

Table 14. FXS Pinout

PIN	NAME	DESCRIPTION
1, 2, 3, 6, 7, 8	Unused	—
4	Ring	Ring to and from the analog phone interface
5	Tip	Tip to and from the analog phone interface

Octal/Quad FXO Option Module (P/N 1200310L1/1200329L1)

Each port of the Octal/Quad FXO Option Module has a single 8-pin modular jack. Connector pinout is compatible with (USOC) RJ-11C and is shown in Table 15.

Connector Type (USOC) RJ-11C

Table 15. FXO Pinout

PIN	NAME	DESCRIPTION
1, 2, 3, 6, 7, 8	Unused	—
4	Ring	Ring to and from the analog phone interface
5	Tip	Tip to and from the analog phone interface

Dual Nx 56/64 Option Module (P/N 1200311L1)

Each port of the Dual Nx 56/64 Option Module has a V.35 Winchester-style connection as defined in Table 16.

Table 16. V.35 Winchester Pinout

Pin	CCITT	DESCRIPTION
A	101	Protective ground (PG)
B	102	Signal ground (SG)
C	105	Request to send (RTS) from DTE
D	106	Clear to send (CTS) to DTE
E	107	Data set ready (DSR) to DTE
F	109	Received line signal detector (DCD) to DTE
H	—	Data terminal ready (DTR) from DTE
J	—	Ring indicator (RI)
R	104	Received data (RD-A) to DTE
T	104	Received data (RD-B) to DTE
V	115	RX clock (RC-A) to DTE
X	115	RX clock (RC-B) to DTE
P	103	Transmitted data (TD-A) from DTE
S	103	Transmitted data (TD-B) from DTE
Y	114	TX clock (TC-A) to DTE
AA	114	TX clock (TC-B) to DTE

Table 16. V.35 Winchester Pinout (Continued)

Pin	CCITT	DESCRIPTION
U	113	External TX clock (ETC-A) from DTE
W	113	External TX clock (ETC-B) from DTE
NN	—	Test mode (TM) to DTE

Dual USSI Option Module (P/N 1200754L1)

Tables 17 through 22 show pinouts for the available interfaces of the Dual USSI Option Module and the system part numbers required for ordering.

Table 17. DB-78 Connector Pinout

PIN	SIGNAL DESCRIPTION	PIN	SIGNAL DESCRIPTION
1	RXD-A 2	41	RTS-B 2
2	RXD-B 2	42	GND
3	RXC-A 2	43—48	NOT USED
4	RXC-B 2	49	MOD2
5	TXD-A 2	50	MOD0
6	TXD-B 2	51	EXT-TXC-A 1
7	TXC-A 2	52	DTR-B 1
8	TXC-B 2	53	DTR-A 1
9	EXT-TXC-A 2	54	DCD-B 1
10	EXT-TXC-B 2	55	DCD-A 1
11—17	NOT USED	56	DSR-B/RI 1
18	GND	57	DSR-A 1
19	GND	58	CTS-B 1
20	CHASIS GND	59	CTS-A 1
21	CTS-A 2	60	CHASIS GND
22	CST-B 2	61	GND
23	DSR-A 2	62—68	NOT USED
24	DSR-B/RI 2	69	MOD1
25	DCD-A 2	70	EXT-TXC-B 1
26	DCD-B 2	71	TXC-B 1
27	DTR-A 2	72	TXC-A 1
28	DTR-B 2	73	TXD-B 1
29—37	NOT USED	74	TXD-A 1
38	RTS-A 1	75	RXC-B 1

Note: 1 or 2 indicates the port on the USSI Module

Table 17. DB-78 Connector Pinout (Continued)

PIN	SIGNAL DESCRIPTION	PIN	SIGNAL DESCRIPTION
39	RTS-B 1	76	RXC-A 1
40	RTS-A 2	77	RXD-B 1
		78	RXD-A 1

Note: 1 or 2 indicates the port on the USSI Module

Connector type EIA-530
System part number 4200754L2

Table 18. EIA-530 Connector Pinout

PIN	SIGNAL DESCRIPTION	PIN	SIGNAL DESCRIPTION
1	Shield (Ground)	13	Clear to Send (B)
2	Transmit Data (A)	14	Transmit Data (B)
3	Received Data (A)	15	Transmit Clock (A)
4	Request to Send (A)	16	Received Data (B)
5	Clear to Send (A)	17	Receive Clock (A)
6	DCE Ready (A)	18	Local Loopback *
7	Signal Ground	19	Request to Send (B)
8	Carrier Detect (A)	20	DTE Ready (A)
9	Received Clock (B)	21	Remote Loopback *
10	Carrier Detect (B)	22	DCE Ready (B)
11	Ext. Transmit Clock (B)	23	DTE Ready (B)
12	Transmit Clock (B)	24	Ext. Transmit Clock (A)
		25	Test Mode *

* Ignored by Dual USSI Module

Connector type EIA-530A
System part number 4200754L2

Table 19. EIA-530A Connector Pinout

PIN	SIGNAL DESCRIPTION	PIN	SIGNAL DESCRIPTION
1	Shield (Ground)	13	Clear to Send (B)
2	Transmit Data (A)	14	Transmit Data (B)
3	Received Data (A)	15	Transmit Clock (A)
4	Request to Send (A)	16	Received Data (B)
5	Clear to Send (A)	17	Receive Clock (A)
6	DCE Ready (A)	18	Local Loopback *
7	Signal Ground	19	Request to Send (B)
8	Carrier Detect (A)	20	DTE Ready (A)
9	Received Clock (B)	21	Remote Loopback *
10	Carrier Detect (B)	22	Ring Indicator
11	Ext. Transmit Clock (B)	23	Signal Ground
12	Transmit Clock (B)	24	Ext. Transmit Clock (A)
		25	Test Mode *

* Ignored by Dual USSI Module

Connector type RS-449/V.36
System part number 4200754L1

Table 20. RS-449/V.36 Connector Pinout

PIN	SIGNAL DESCRIPTION	PIN	SIGNAL DESCRIPTION
1	Shield (Ground)	19	Signal Ground
2	Signaling Rate Indicator *	20	Receive Common *
3	Not Used	21	Not Used
4	Transmit Data (A)	22	Transmit Data (B)
5	Transmit Clock (A)	23	Transmit Clock (B)
6	Received Data (A)	24	Receive Data (B)
7	Request to Send (A)	25	Request to Send (B)
8	Receive Clock (A)	26	Receive Clock (B)
9	Clear to Send (A)	27	Clear to Send (B)
10	Local Loopback *	28	Terminal in Service *
11	DCE Ready (A)	29	DCE Ready (B)

* Ignored by Dual USSI Module

Table 20. RS-449/V.36 Connector Pinout (Continued)

PIN	SIGNAL DESCRIPTION	PIN	SIGNAL DESCRIPTION
12	DTE Ready (A)	30	DTE Ready (B)
13	Carrier Detect (A)	31	Carrier Detect (B)
14	Remote Loopback *	32	Select Standby *
15	Ring Indicator	33	Signal Quality *
16	Select Frequency *	34	New Signal *
17	Ext. Transmit Clock (A)	35	Ext. Transmit Clock (B)
18	Test Mode *	36	Standby/Indicator *
		37	Send Common *

* Ignored by Dual USSI Module

Connector type RS-232
System part number 4200754L4

Table 21. RS-232 Connector Pinout

PIN	SIGNAL DESCRIPTION	PIN	SIGNAL DESCRIPTION
1	Shield (Ground)	14	Sec. Transmit Data
2	Transmit Data	15	DCE Transmit Clock
3	Received Data	16	Sec. Received Data
4	Request to Send	17	Receive Signal Element Timing
5	Clear to Send	18	Not used
6	Data Set Ready	19	Sec. Request to Send
7	Signal Ground	20	Data Terminal Ready
8	Received Line Signal Detector	21	Signal Quality Detector *
9	+ Voltage *	22	Ring Indicator
10	- Voltage *	23	Data Signal Rate Selector *
11	Not used	24	DTE Transmit Clock
12	Sec. Received Line Signal Indicator	25	Not used
13	Sec. Clear to Send		

* Ignored by Dual USSI Module

Connector type CCITT X.21/V.11
System part number 4200754L3

Table 22. CCITT X.21/V.11 Connector Pinout

PIN	SIGNAL DESCRIPTION	PIN	SIGNAL DESCRIPTION
1	Shield (Ground)	8	Signal Ground
2	Transmit Data (A)	9	Transmit Data (B)
3	Request to Send (A)	10	Request to Send (B)
4	Received Data (A)	11	Received Data (B)
5	Carrier Detect (A)	12	Carrier Detect (B)
6	Transmit/Receive Clock (A)	13	Transmit/Received Clock (B)
7	Ext. Transmit Clock (A)	14	Ext. Transmit Clock (B)
15	Not Used		

Octal E&M Option Module (P/N 1200313L1)

Each port of the Octal E&M Option Module has a single 8-pin modular jack. A suitable mating connector is AMP # 2-383021-5. The Octal E&M module is an E-lead originate signaling circuit suitable for connection to an M-lead originate trunk circuit. The pinout is shown in Table 23, and the E&M signaling types are shown in Table 24.

Table 23. E&M Pinout

PIN	Signal	DESCRIPTION
1	Ring	VF input (4W mode, 600Ω nominal)
2	Tip	
3	E	Customer Originate
4	SG	Signal Ground
5	SB	Signal Battery
6	M	Network Originate
7	Tip 1	VF output (4W mode, 600Ω nominal)
8	Ring 1	

Table 24. Trunk Circuit Connections for Various E&M Signaling Types

Signaling Type	Trunk Circuit Connections			
	E	M	SB	SG
Type I	Pin 3	Pin 6	NC	NC
Type II	Pin 3	Pin 6	Pin 4	Pin 5
Type III	Pin 3	Pin 6	Pin 4	Pin 5
Type IV	Pin 3	Pin 6	Pin 4	Use Frame Ground
Type V	Pin 3	Pin 6	NC	NC

Dual/Quad T1/PRI Option Module (P/N 1200314L1/1200755L1)

Each port of the Dual/Quad T1/PRI Option Module uses a single, 8-position modular jack to connect to the T1 or PRI circuit. Table 25 gives the pinout for this jack.

Connector Type (USOC) RJ-48C

Table 25. T1/PRI Pinout

PIN		NAME	DESCRIPTION
1	R1	RXDATA-RING	Receive data from the network
2	T1	RXDATA-TIP	Receive data from the network
3	—	UNUSED	—
4	R	TXDATA-RING	Send data towards the network
5	T	TXDATA-TIP	Send data towards the network
6,7,8	—	UNUSED	—

Quad BRI (U-Interface) Option Module (P/N 1200315L1)

Each port of the Quad BRI (U-Interface) Option Module uses a single RJ-48C jack to connect to a standard BRI U-interface circuit. Table 26 shows the network pinout connection.

Connector Type (USOC) RJ-48C

Table 26. BRI Pinout (U-Interface)

PIN	NAME	DESCRIPTION
1, 2, 3, 6, 7, 8	Unused	—
4	Ring	Ring to and from the Network Interface
5	Tip	Tip to and from the Network Interface

Quad BRI ISDN (S/T Interface) Option Module (P/N 1200764L1)

Each port of the Quad BRI ISDN (S/T Interface) Option Module uses a single RJ-45 jack to connect to a standard BRI S/T interface circuit. The Quad BRI ISDN (S/T Interface) Option Module is only available for use in NT mode (User Term) applications. Table 27 shows the network pinout connection. The required wiring connection follows:

Connector Type (USOC) RJ-45

Table 27. BRI Pinout (S/T Interface)

PIN	NAME	DESCRIPTION
1, 2, 7, 8	Unused	—
3, 6	Receive	Receive for User Term (NT Mode)
4, 5	Transmit	Transmit for User Term (NT Mode)

NxT1 HSSI Option Module (P/N 1200346L1)

The NxT1 HSSI Option Module uses a single 50-pin SCSI-II interface to combine up to 8 T1s of data (4 from the NxT1 HSSI Module T1 ports and 4 from other T1 ports installed in the system). Table 28 (below) and Table 30 on page 45 give the pinouts for the SCSI-II and RJ-48C (T1) connectors, respectively.

Table 28. HSSI (SCSI-50) Connection Pinout

PIN# (+ side)	PIN# (- side)	DESCRIPTION
1	26	SG - Signal Ground
2	27	RT - Receive Timing
3	28	CA - DCE Available
4	29	RD - Receive Data
5	30	LC - Loopback Circuit C
6	31	ST - Send Timing
7	32	SG - Signal Ground
8	33	TA - DTE Available
9	34	TT - Terminal Timing
10	35	LA - Loopback Circuit A
11	36	SD - Send Data
12	37	LB - Loopback Circuit B
13	38	SG - Signal Ground
14-18	39-43	Ancillary to DCE (Reserved)

Table 28. HSSI (SCSI-50) Connection Pinout (Continued)

19	44	SG - Signal Ground
20-23	45-48	Ancillary to DTE (Reserved)
24	49	TM - Test Mode
25	50	SG - Signal Ground

NxT1 HSSI/V.35 Option Module (P/N 1200346L2)

V.35 is possible with the NxT1 HSSI Option Module with an appropriate adapter cable (ADTRAN P/N 3125I081@A); however, some HSSI menu options will be unavailable in this mode (see User Interface Guide section for details). Table 29 (below) and Table 30 on page 45 give the pinouts for the V.35 and RJ-48C (T1) connectors, respectively.

Table 29. HSSI/V.35 Connection Pinout

PIN# (+ side)	PIN# (- side)	DIRECTION	DESCRIPTION
1	26	—	HSSI SG - Signal Ground
2	27	O	HSSI RT - Receive Timing
3	28	O	HSSI CA - DCE Available
4	29	O	HSSI RD - Receive Data
5	30	O	HSSI LC - Loopback Circuit C
6	31	O	HSSI ST - Send Timing
7	32	—	HSSI SG - Signal Ground
8	33	I	HSSI TA - DTE Available
9	34	I	HSSI TT - Terminal Timing
10	35	I	HSSI LA - Loopback Circuit A
11	36	I	HSSI SD - Send Data
12	37	I	HSSI LB - Loopback Circuit B
13	38	—	HSSI SG - Signal Ground
—	39	—	Ancillary to DCE (Reserved)
14	—	I	V.35 RTS - Request to Send
15	40	I	V.35 TT Terminal Timing
16	41	I	V.35 SD Send Data
—	42	O	V.35 DCD - Data Carrier Detect
17-18	43	—	Ancillary to DCE (Reserved)
19	44	—	HSSI SG - Signal Ground
20	45	O	V.35 ST - Send Timing
21	46	O	V.35 - Receive Timing

Table 29. HSSI/V.35 Connection Pinout (Continued)

22	47	O	V.35 RD - Receive Data
23	—	O	V.35 CTS - Clear to Send
—	48	I	V.35 Ground/Present
24	49	O	TM - Test Mode
25	50		SG - Signal Ground

Table 30. T1 Network Connection Pinout

PIN		NAME	DESCRIPTION
1	R1	RXDATA-RING	Receive data from the network
2	T1	RXDATA-TIP	Receive data from the network
3	—	UNUSED	—
4	R	TXDATA-RING	Send data towards the network
5	T	TXDATA-TIP	Send data towards the network
6,7,8	—	UNUSED	—

Legacy Data Option Module (P/N 1200342L1)

The Legacy Data Option Module provides four EIA-232 or V.35 interfaces (or any combination up to four) for sync or async packet data applications. Table 31 gives the pinouts for both the EIA-232 and V.35 connections.

Connector Types EIA-232 and V.35

Table 31. EIA-232 and V.35 Connection Pinouts

EIA-232 PIN	V.35 PIN	CCITT/V.24 PIN	DESCRIPTION
-	A	101	Protective ground (PG)
7	B	102	Signal ground (SG)
4	C	105	Request to send (RTS) from DTE
5	D	106	Clear to send (CTS) to DTE
6	E	107	Data set ready (DSR) to DTE
8	F	109	Received line signal detector (DCD) to DTE
20	H	108/2	Data terminal ready (DTR) from DTE

Table 31. EIA-232 and V.35 Connection Pinouts (Continued)

22	J	125	Ring indicator (RI) to DTE
3	R	104	Received data (RD-A) to DTE
3	T	104	Received data (RD-B) to DTE
17	V	115	RX clock (RC-A) to DTE
17	X	115	RX clock (RC-B) to DTE
2	P	103	Transmitted data (TD-A) from DTE
2	S	103	Transmitted data (TD-B) from DTE
15	Y	114	TX clock (TC-A) to DTE
15	AA	114	TX clock (TC-B) to DTE
24	U	113	External TX clock (ETC-A) from DTE
24	W	113	External TX clock (ETC-B) from DTE
-	NN	142	Test mode (TM) to DTE

Octal Ethernet Switch Option Module (P/N 1200766L1)

The Octal Ethernet Switch Option Module provides eight (RJ-48C) interfaces that can operate as 10BaseT or 100BaseTX. Table 32 gives the pinout for the Ethernet connection.

Table 32. Ethernet Pinout

PIN	NAME	DESCRIPTION
1	TX1	Transmit Positive
2	TX2	Transmit Negative
3	RX1	Receive Positive
4, 5	UNUSED	—
6	RX2	Receive Negative
7, 8	UNUSED	—

7. AT-A-GLANCE SPECIFICATIONS

Table 33 lists the specifications for the ATLAS 550 system.

Table 33. Specifications

Application	Feature	Specification
TDM Applications		
	TDM bandwidth	14 Mbps Full duplex
	Dedicated map connections	160 Dedicated map connections in each of the 5 maps
Switching Applications		
	ISDN signaling types	National ISDN Lucent 5E AT&T 4ESS (PRI Only) Northern DMS-100 (Nortel Custom) EuroISDN
	T1 signaling types	Loop-Start Ground-Start E&M Wink E&M Immediate Feature Group D
	DSP Features	DTMF tones support FSK Caller ID support Progress tone generation 32 available DSP channels
	BRI Connections	17 BRI connections
	PRI Connections	10 PRI connections
	RBS T1 Connections	10 RBS T1 connections
Frame Relay		
	Packet throughput	4000 pkts/sec (minimum)
	Management signaling interfaces	UNI (user and network) NNI

Table 33. Specifications (Continued)

Application	Feature	Specification
	Management signaling types	ANSI T1.617-D (Annex D) ITU-T Q.933-A (Annex A) LMI (Group of four) Auto
	Encapsulation	RFC 1490
	PVC support	300 PVCs
	Congestion control	FECN / BECN Discard eligible (DE)
	Quality of service (QOS)	Prioritization on a per-PVC basis
	Testing (ADTRAN proprietary)	PVC loopback Round trip delay measurement
	SNMP support	RFC 1315
PPP		
	Connection support	100 connections
	Authentication support	PAP CHAP EAP
	Keepalive support	On/Off
	Interface support	Numbered interfaces Un-numbered interfaces
IP Routing		
	Route discovery	RIP V1 RIP V2 ICMP ARP IARP UDP Relay
	SNMP support	RFCs 1155-SMI, 1158-MIB, 1212, 1213, 1215, 1315, 1406 Adtran Enterprise MIBs

Table 33. Specifications (Continued)

Application	Feature	Specification														
Voice Compression																
	Algorithm	Voice Compression Module G.723.1 or Netcoder (proprietary) ADPCM-32 Module G.711, G.726 (16K/32K), Transparent (proprietary)														
	Number of channels supported	Up to 32 compression channels														
	PCM coding	μ-Law, A-Law (future)														
	Fax support	9600 bps														
	Modem Support (ADPCM-32 Module only) The rates shown at the right are maximum rates. Under certain conditions, these rates may not be realized.	<table border="0"> <tr> <td><u>G.711, Transparent</u></td> <td><u>ADPCM 32</u></td> </tr> <tr> <td>V.34 @ 28.8 bps</td> <td>V.32 @ 14.4 bps</td> </tr> <tr> <td>FAX @ 14.4 bps</td> <td>FAX @ 14.4 bps</td> </tr> <tr> <td><u>ADPCM 16</u></td> <td></td> </tr> <tr> <td>V.21 @ 300 bps</td> <td></td> </tr> <tr> <td>V.22 @ 1200 bps</td> <td></td> </tr> <tr> <td>FAX NOT RECOMMENDED</td> <td></td> </tr> </table>	<u>G.711, Transparent</u>	<u>ADPCM 32</u>	V.34 @ 28.8 bps	V.32 @ 14.4 bps	FAX @ 14.4 bps	FAX @ 14.4 bps	<u>ADPCM 16</u>		V.21 @ 300 bps		V.22 @ 1200 bps		FAX NOT RECOMMENDED	
<u>G.711, Transparent</u>	<u>ADPCM 32</u>															
V.34 @ 28.8 bps	V.32 @ 14.4 bps															
FAX @ 14.4 bps	FAX @ 14.4 bps															
<u>ADPCM 16</u>																
V.21 @ 300 bps																
V.22 @ 1200 bps																
FAX NOT RECOMMENDED																
	DTMF generation and detection	TIA 464A														

NETWORK TURNUP PROCEDURE

CONTENTS

Introduction	52
Tools Required	52
Unpack and Inspect the System	52
Contents of ADTRAN Shipments	52
Grounding Instructions	53
Supplying Power to the Unit	53
AC Powered Systems	53
DC Powered Systems	54
Mounting Options	54
Installing Network and Option Modules	54
Instructions for Installing the ATLAS 550 Network and Option Modules	55
Module Shipping Contents	55
T1/PRI Network Interface Module (P/N 1200307L1)	55
E1/PRA Network Interface Module (P/N 1200308L1)	55
Modem Management Network Module (P/N 1200341L1)	56
BRI DBU Network Module (P/N 1200327L1)	56
Dual/Quad T1/PRI Option Module (P/N 1200314L1/1200755L1)	56
Dual Nx 56/64 Option Module (P/N 1200311L1)	56
Dual USSI Option Module System (P/N 4200754Lx)	57
Quad Basic Rate ISDN (U-Interface) Option Module (P/N 1200315L1)	57
Quad Basic Rate ISDN (S/T Interface) Option Module (P/N 1200764L1)	57
Octal/Quad FXS Option Module (P/N 1200309L1/1200328L1)	57
Octal/Quad FXO Option Module (P/N 1200310L1/1200329L1)	58
Octal E&M Option Module (P/N 1200313L1)	58
Legacy Data Option Module (P/N 1200342L1)	58
NxT1 HSSI Option Module (P/N 1200346L1) with V.35 Support (P/N 1200346L2)	58
Ethernet Switch Option Module (P/N 1200766L1)	59
Resource Host Module (P/N 1200324L1)	59
4,8,16,24 Channel Voice Compression Resource Modules (P/N 1200312Lx)	59
32 Channel ADPCM Resource Module (P/N 1200752L1)	59
Nx 56/64 BONDing Resource Module (P/N 1200326L1)	59

FIGURES

Figure 1. ATLAS 550 Slot Designation (Rear Panel)	54
---	----

1. INTRODUCTION

This section discusses the installation process for the ATLAS 550 system.

2. TOOLS REQUIRED

The tools required for installation of the ATLAS 550 unit are:

- #2 Phillips-head screwdriver
- Flat-head screwdriver (for installing modules)

WARNING

To prevent electrical shock, do not install equipment in a wet location or during a lightning storm.



Electronic modules can be damaged by static electrical discharge. Before handling modules, wear an antistatic discharge wrist strap to prevent damage to electronic components. Place modules in antistatic packing material when transporting or storing. When working on modules, always place them on an approved antistatic mat that is electrically grounded.

3. UNPACK AND INSPECT THE SYSTEM

The ATLAS 550 is shipped in its own cardboard shipping carton. Open the carton carefully and avoid deep penetration into the carton with sharp objects.

After unpacking the unit, inspect it for possible shipping damage. If the equipment has been damaged in transit, immediately file a claim with the carrier, then contact ADTRAN Customer Service (see the contact information in the front of this manual).

Contents of ADTRAN Shipments

Your ADTRAN shipment includes the following items:

- The ATLAS 550 unit
- The ATLAS 550 *System CD*
- AC power cord - ADTRAN P/N 3127031 (with AC systems)
- 19" rackmount brackets and screws
- RJ-45 to DB-9 adapter - ADTRAN P/N 3196ADPT001
- RJ-45 to DB-25 adapter - ADTRAN P/N 3196ADPT006



Customers must supply the Ethernet cable.

4. GROUNDING INSTRUCTIONS

The following provides grounding instruction information from the Underwriters' Laboratory UL60950 Standard for Safety of Information Technology Equipment Including Electrical Business Equipment, Third Edition, of December 1, 2000.

An equipment grounding conductor that is not smaller in size than the ungrounded branch-circuit supply conductors is to be installed as part of the circuit that supplies the product or system. Bare, covered, or insulated grounding conductors are acceptable. Individually covered or insulated equipment grounding conductors shall have a continuous outer finish that is either green, or green with one or more yellow stripes. The equipment grounding conductor is to be connected to ground at the service equipment.

The attachment-plug receptacles in the vicinity of the product or system are all to be of a grounding type, and the equipment grounding conductors serving these receptacles are to be connected to earth ground at the service equipment.

A supplementary equipment grounding conductor shall be installed between the product or system and ground that is in addition to the equipment grounding conductor in the power supply cord.

The supplementary equipment grounding conductor shall not be smaller in size than the ungrounded branch-circuit supply conductors. The supplementary equipment grounding conductor shall be connected to the product at the terminal provided, and shall be connected to ground in a manner that will retain the ground connection when the product is unplugged from the receptacle. The connection to ground of the supplementary equipment grounding conductor shall be in compliance with the rules for terminating bonding jumpers at Part K or Article 250 of the National Electrical Code, ANSI/NFPA 70. Termination of the supplementary equipment grounding conductor is permitted to be made to building steel, to a metal electrical raceway system, or to any grounded item that is permanently and reliably connected to the electrical service equipment ground.

The supplemental grounding conductor shall be connected to the equipment using a number 8 ring terminal and should be fastened to the grounding lug provided on the rear panel of the equipment. The ring terminal should be installed using the appropriate crimping tool (AMP P/N 59250 T-EAD Crimping Tool or equivalent).

5. SUPPLYING POWER TO THE UNIT

AC Powered Systems

The AC powered ATLAS 550 comes equipped with a detachable 6-foot power cord with a 3-prong plug for connecting to a grounded power receptacle. As shipped, the ATLAS 550 is set to factory default conditions. After installing the unit and any option modules, the ATLAS 550 is ready for power-up. To power-up the unit, ensure that the unit is properly connected to an appropriate power source and turn on the unit using the on/off switch on the rear panel.



- *Power to the ATLAS 550 AC system must be from a grounded 90-130/190-240 VAC, 50/60 Hz source.*
- *The power receptacle uses double-pole, neutral fusing.*
- *Maximum recommended ambient operating temperature is 45 °C.*

DC Powered Systems

The DC powered ATLAS 550 comes equipped with a DC power supply to furnish the voltages necessary for proper backplane operation. As shipped, the ATLAS 550 is set to factory default conditions. After installing the unit and any option modules, the ATLAS 550 is ready for power-up.



- Power to the ATLAS 550 DC system must be from a reliably grounded -48 VDC or +24 VDC source which is electrically isolated from the AC source.
- This unit shall be installed in accordance with Article 400 and 364.8 of the NEC NFPA 70.
- The branch circuit overcurrent protection shall be a fuse or circuit breaker rated minimum 60 VDC, maximum 10A.
- A readily accessible disconnect device that is suitably approved and rated shall be incorporated in the field wiring.
- Maximum recommended ambient operating temperature is 45 °C.

6. MOUNTING OPTIONS

The ATLAS 550 unit may be installed for tabletop, 19-inch or 23-inch rackmount, or wallmount configuration. ADTRAN includes 19-inch rackmount ears with the ATLAS 550 shipment (23-inch rackmount ears are sold separately). For a rackmount installation, the ATLAS 550 allows flush-face mount, face-forward mount, center mount, and rear mount. The rackmount ears may also be turned face down for wall mounting. When wall mounted, the ATLAS 550 unit may be installed with either side up and the front and rear panels facing sideways. For more details on wall mounting the ATLAS 550, please refer to the ATLAS 550 Installation Guide (61200305L1-19A) provided on the documentation CD.



Be careful not to upset the stability of the equipment mounting rack when installing this product.

7. INSTALLING NETWORK AND OPTION MODULES

Figure 1 shows the option slot numbering designation as viewed from the rear of the ATLAS 550.

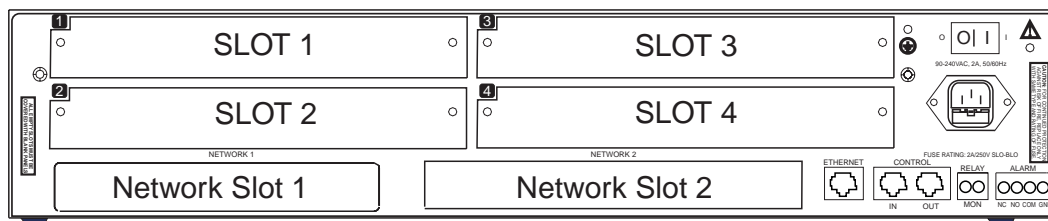

Figure 1. ATLAS 550 Slot Designation (Rear Panel)

WARNING*Option modules are intended to be serviced by qualified service personnel only.***Instructions for Installing the ATLAS 550 Network and Option Modules**

Instructions for Installing the ATLAS 550 Option Modules	
Step	Action
1	Remove the cover plate from the appropriate option slot of the ATLAS 550 rear panel.
2	Slide the Option Module into the option slot until the module is firmly seated against the front of the chassis.
3	Secure the thumbscrews at both edges of the module. Tighten with a screwdriver.
4	Connect the cables to the associated device(s).
5	Complete installation of remaining modules and unit as specified in the appropriate sections of this Network Turnup Procedure.

8. MODULE SHIPPING CONTENTS

This section provides shipping content information for all available ATLAS 550 option, network, and resource modules.

T1/PRI Network Interface Module (P/N 1200307L1)***Shipping Contents***

The ADTRAN shipment of the T1/PRI Network Interface Module includes the following items:

- T1/PRI Network Interface Module
- T1/PRI Network Interface Module Quick Start Guide
- One T1 cable (RJ-48C to RJ-48C), ADTRAN P/N 3125M008
- One T1 crossover cable (RJ-48C to RJ-48C), ADTRAN P/N 3125M010

E1/PRA Network Interface Module (P/N 1200308L1)***Shipping Contents***

The ADTRAN shipment of the E1/PRA Network Interface Module includes the following items:

- E1/PRA Network Interface Module
- E1/PRA Network Interface Module Quick Start Guide
- RJ-45 to DB-15 adapter, ADTRAN P/N 3196028

Modem Management Network Module (P/N 1200341L1)***Shipping Contents***

The ADTRAN shipment of the Modem Management Network Module includes the following items:

- Modem Management Network Module
- Modem Management Network Module Quick Start Guide
- One 7-foot cable (RJ-11 to RJ-11), ADTRAN P/N 3127014

BRI DBU Network Module (P/N 1200327L1)***Shipping Contents***

The ADTRAN shipment of the BRI DBU Network Module includes the following items:

- BRI DBU Network Module
- BRI DBU Network Module Quick Start Guide
- One 7-foot cable (RJ-45 to RJ-11), ADTRAN P/N 3125M007

Dual/Quad T1/PRI Option Module (P/N 1200314L1/1200755L1)***Shipping Contents***

The ADTRAN shipment of the Dual/Quad T1/PRI Option Module includes the following items:

- Dual/Quad T1/PRI Option Module
- Dual/Quad T1/PRI Option Module Quick Start Guide
- Two/Four T1 cables (RJ-48C to RJ-48C), ADTRAN P/N 3125M008
- Two T1 crossover cables (RJ-48C to RJ-48C), ADTRAN P/N 3125M010

Dual Nx 56/64 Option Module (P/N 1200311L1)***Shipping Contents***

The ADTRAN shipment of the Dual Nx 56/64 Option Module includes the following items:

- Dual Nx 56/64 Option Module
- Dual Nx 56/64 Option Module Quick Start Guide

Customer Provides

- DTE cables

Dual USSI Option Module System (P/N 4200754Lx)

Shipping Contents

The ADTRAN shipment of the Dual USSI Option Module System includes the following items:

- Dual USSI Option Module System
- Dual USSI Option Module System Quick Start Guide

And one of the following:

- RS-449/V.36 (System P/N 4200754L1)
- EIA-530/530A to DB-78 Cable (System P/N 4200754L2)
- CCITT X.21/V.11 (System P/N 4200754L3)
- RS-232 (System P/N 4200754L4)

Quad Basic Rate ISDN (U-Interface) Option Module (P/N 1200315L1)

Shipping Contents

The ADTRAN shipment of the Quad Basic Rate ISDN (U-Interface) Option Module includes the following items:

- Quad Basic Rate ISDN (U-Interface) Option Module
- Quad Basic Rate ISDN (U-Interface) Option Module Quick Start Guide
- Four RJ-45-to-RJ-11 cables, ADTRAN P/N 3125M007

Quad Basic Rate ISDN (S/T Interface) Option Module (P/N 1200764L1)

Shipping Contents

The ADTRAN shipment of the Quad Basic Rate ISDN (S/T Interface) Option Module includes the following items:

- Quad Basic Rate ISDN (S/T Interface) Option Module
- Quad Basic Rate ISDN (S/T Interface) Option Module Quick Start Guide
- Four RJ-45-to-RJ-11 cables, ADTRAN P/N 3125M007

Octal/Quad FXS Option Module (P/N 1200309L1/1200328L1)

Shipping Contents

The ADTRAN shipment of the Octal/Quad FXS Option Module includes the following items:

- Octal/Quad FXS Option Module
- Octal/Quad FXS Option Module Quick Start Guide

Octal/Quad FXO Option Module (P/N 1200310L1/1200329L1)***Shipping Contents***

The ADTRAN shipment of the Octal/Quad FXO Option Module includes the following items:

- Octal/Quad FXO Option Module
- Octal/Quad FXO Option Module Quick Start Guide

Octal E&M Option Module (P/N 1200313L1)***Shipping Contents***

The ADTRAN shipment of the Octal E&M Option Module includes the following items:

- Octal E&M Option Module
- Octal E&M Option Module Quick Start Guide

Legacy Data Option Module (P/N 1200342L1)***Shipping Contents***

The ADTRAN shipment of the Legacy Data Option Module includes the following items:

- Legacy Data Option Module
- Legacy Data Option Module Quick Start Guide
- One DB-78 to DB-25 (four interfaces) cable, ADTRAN P/N 3125I051

Optional Accessories include the following:

- DB-78 to V.35 (four interfaces) cable, ADTRAN P/N 1200348L1

NxT1 HSSI Option Module (P/N 1200346L1) with V.35 Support (P/N 1200346L2)***Shipping Contents***

The ADTRAN shipment of the NxT1 HSSI Option Module includes the following items:

- NxT1 HSSI Option Module
- NxT1 HSSI Option Module Quick Start Guide
- Four T1 cables (RJ-45 to RJ-45), ADTRAN P/N 3125M008

Optional accessories include the following:

- SCSI-II (50 pin) to V.35 cable, ADTRAN P/N 1200763L1

Ethernet Switch Option Module (P/N 1200766L1)***Shipping Contents***

The ADTRAN shipment of the Ethernet Switch Option Module includes the following items:

- Ethernet Switch Option Module
- Ethernet Switch Option Module Quick Start Guide
- One RJ-45 to RJ-45 (8 pin) Ethernet cable, ADTRAN P/N 3127017

Resource Host Module (P/N 1200324L1)***Shipping Contents***

The ADTRAN shipment of the Resource Host Module includes the following items:

- Resource Host Module
- Resource Host Module Quick Start Guide

4,8,16,24 Channel Voice Compression Resource Modules (P/N 1200312Lx)***Shipping Contents***

The ADTRAN shipment of the 4,8,16,24 Channel Voice Compression Resource Modules includes the following items:

- 4,8,16,24 Channel Voice Compression Resource Modules
- 4,8,16,24 Channel Voice Compression Resource Modules Quick Start Guide

32 Channel ADPCM Resource Module (P/N 1200752L1)***Shipping Contents***

The ADTRAN shipment of the 32 Channel ADPCM Resource Module includes the following items:

- 32 Channel ADPCM Resource Module
- 32 Channel ADPCM Resource Module Quick Start Guide

Nx 56/64 BONDing Resource Module (P/N 1200326L1)***Shipping Contents***

The ADTRAN shipment of the Nx 56/64 BONDing Resource Module includes the following items:

- Nx 56/64 BONDing Resource Module
- Nx 56/64 BONDing Resource Module Quick Start Guide

USER INTERFACE GUIDE

This section of ADTRAN's ATLAS 550 System Manual is designed for use by network administrators and others who will configure and provision the system. It contains information about navigating the VT100 user interface, configuration information, and menu descriptions.

CONTENTS

Navigating the Terminal Menu	64
Terminal Menu Window	64
Navigating using the Keyboard Keys	66
Terminal Menu and System Control	68
Selecting the Appropriate Menu	68
Security Levels	69
Menu Descriptions	69
System Info	70
System Status	72
System Config	79
System Utility	92
Modules	102
Modules Menu (T1/PRI Network Interface Module)	104
Modules Menu (E1/PRA Network Interface Module)	111
Modules Menu (Modem Management Network Module)	116
Modules Menu (BRI DBU Network Interface Module)	118
Modules Menu (Dual/Quad T1/PRI Option Modules)	123
Modules Menu (Dual Nx56/64 Option Module)	130
Modules Menu (Dual USSI Option Module)	137
Modules Menu (Quad Basic Rate ISDN (U Interface) Option Module)	144
Modules Menu (Quad Basic Rate ISDN (S/T Interface) Option Module)	147
Modules Menu (Quad/Octal FXS Option Module)	150
Modules Menu (Quad/Octal FXO Option Module)	154
Modules Menu (Octal E&M Option Module)	158
Modules Menu (Legacy Data Option Module)	162
Modules Menu (NxT1 HSSI and NxT1 HSSI/V.35 Option Modules)	165
Modules Menu (Ethernet Switch Module)	175
Modules Menu (Resource Host Module)	176
Modules Menu (VCOM Option Module)	176
Modules Menu (32 Channel ADPCM Resource Module)	182
Modules Menu (Nx 56/64 BONDing Resource Module)	187
Packet Manager	190
Router	218
Dedicated Maps	233
Dedicated Maps (T1/PRI Network or Dual/Quad T1/PRI Modules)	236
Dedicated Maps (E1/PRA Network Interface)	237
Dedicated Maps (Quad/Octal FXS Module)	239
Dedicated Maps (Quad/Octal FXO Module)	242
Dedicated Maps (Dual Nx 56/64 Module)	243
Dedicated Maps (Dual USSI Module)	244
Dedicated Maps (Octal E&M Module)	244

Dedicated Maps (NxT1 HSSI and NxT1 HSSI/V.35 Modules)	245
Dedicated Maps (Legacy Data Module)	246
Dedicated Maps (Pkt Endpt - Packet Endpoint)	247
Dedicated Maps (Pkt Voice - Packet Voice Endpoint)	248
Circuit Status.	250
Dial Plan	253
Dial Plan (T1 Network and Dual/Quad T1/PRI Modules)	265
Dial Plan (E1/PRA Network Module).	280
Dial Plan (BRI DBU Network Interface and Quad BRI/U Modules).	285
Dial Plan (Quad/Octal FXS Module)	288
Dial Plan (Quad/Octal FXO Module).	292
Dial Plan (Octal E&M Module)	297
Dial Plan (Dual Nx56/64 Module)	300
Dial Plan (Dual USSI Module).	301
Dial Plan (Quad BRI S/T Module)	303
Dial Plan (Pkt Endpt - Packet Endpoints)	304
Dial Plan (Ckt Backup - Circuit Backup Endpoints).	307
Dial Plan (Pkt Voice - Packet Voice Endpoint)	310

FIGURES

Figure 1. Top-Level Terminal Menu Window	64
Figure 2. Alternate Menu View	65
Figure 3. System Info Menu	70
Figure 4. System Status Menu	72
Figure 5. System Config Menu	79
Figure 6. System Utility Menu	92
Figure 7. View Selftest Log	97
Figure 8. Modules Menu	102
Figure 9. T1/PRI Loopback Test Diagram	109
Figure 10. E1/PRA Network Loopback Test Diagram	116
Figure 11. T1/PRI Loopback Test Diagram	128
Figure 12. T1/PRI Loopback Test Diagram	169
Figure 13. HSSI Interface Loopback Test Diagram.	171
Figure 14. Packet Manager Menu	190
Figure 15. Router Menu (IP Selected).	218
Figure 16. Dedicated Maps Menu	233
Figure 17. Circuit Status Menu	250
Figure 18. Dial Plan Menu.	253

TABLES

Table 1. Password Security Levels	69
Table 2. ATLAS 550 System Controller Self-Test Log	97
Table 3. FXS 2W State Table	152
Table 4. FXO 2W State Table	156
Table 5. E&M 2W State Table	160
Table 6. IP Statistics	227

Table 7.	ICMP Statistics	229
Table 8.	TCP Statistics	230
Table 9.	UDP Statistics	231
Table 10.	IP Fast Cache Statistics	231

1. NAVIGATING THE TERMINAL MENU

Log in to the ATLAS 550 by connecting one end of the supplied silver cable to the RJ-45 interface labeled **CONTROL IN** (located on the rear panel of the unit) or **CRAFT** (located on the front of the unit) and the other to the supplied RJ-45 to DB-9 adapter. Connect the DB-9 (female) to a VT100 terminal or PC with VT100 emulator software. Configure the terminal settings for 9600 data rate, no parity, 8 data bits, 1 stop bit, and no flow control.

After connecting to the unit and beginning a terminal session, a login screen appears. The default password for the ATLAS 550 is (all lowercase) **password**. (Refer to DLP-002, *Logging in to the System* for detailed instructions.)

Terminal Menu Window

After logging in, all menu items and data fields are displayed in the terminal menu window (see Figure 1), through which you have complete control of the ATLAS 550.

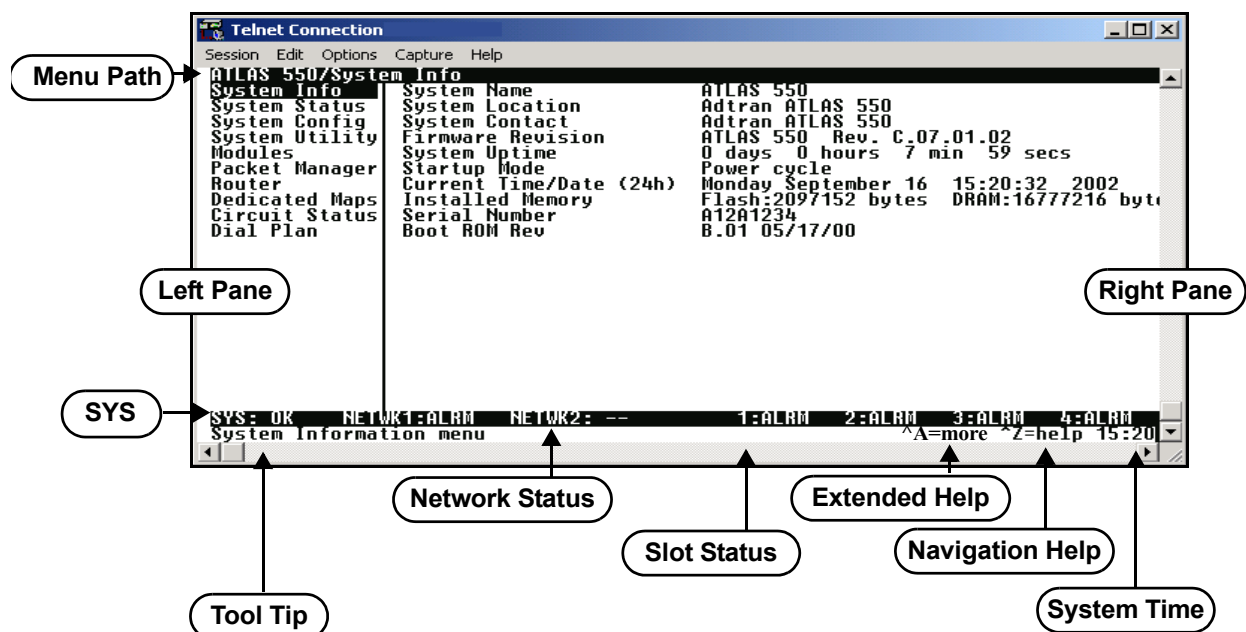

Figure 1. Top-Level Terminal Menu Window

Menu Path

The first line of the terminal menu window (the menu path) shows the session's current position (path) in the menu structure. For example, Figure 1 shows the top-level menu with the cursor on the **SYSTEM INFO** submenu; therefore, the menu path reads **ATLAS 550/SYSTEM INFO**.

Window Panes

When you first start a terminal menu session, the terminal menu window is divided into left and right panes. The left pane shows the list of available submenus, while the right pane shows the contents of the currently selected submenu.

You can view the terminal windows in two ways: with fields and submenus displaying horizontally across the right pane, or with fields and submenus displaying vertically down the right pane. Viewing submenus vertically rather than horizontally allows you to see information at a glance rather than scrolling horizontally across the window. To change the view, move your cursor to an index number and press <Enter>. Figure 2 shows this alternate view. Fields and submenu names may vary slightly in this view.

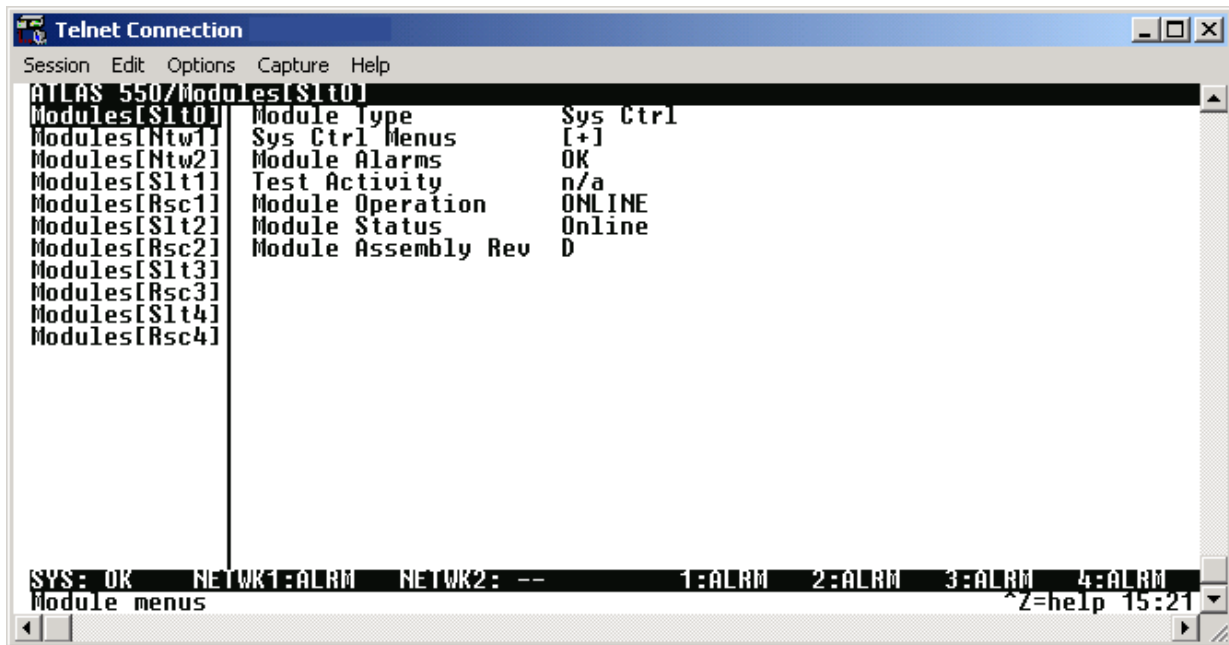

Figure 2. Alternate Menu View

Window Pane Navigation

Use the following chart to assist you in moving between and within the two window panes.

To do this...	Press this key...
Move from left pane to right pane	Tab Enter Right arrow
Move from right pane to left pane	Tab Escape Left arrow Backspace
Move within each pane	Up arrow Down arrow Left arrow Right arrow

Right Window Pane Notation

The right window pane shows the contents of the currently selected menu. These contents include both submenu items and data fields. Some submenus contain additional submenus and some data fields contain additional data fields. The following chart explains the notation used to identify these additional items.

This notation...	Means that...
[+]	More items are available when selected
[DATA]	More items are available when selected
<+ >	An action is to be taken, such as activating a test
Highlighted menu item	You can enter data in this field
Underlined field	The field contains read-only information

Additional Terminal Menu Window Features

- SYS - displays status information about the system controller
- Tool Tip - provides a brief description of the currently selected (highlighted) command
- Network Status - displays status information, such as OK, WARN, or ALRM about network slots 1-2
- Slot Status - displays status information, such as OK, WARN, or ALRM about option slots 1-4
- Extended Help - displays information (when available) about selected commands (CTRL+A)
- Navigation Help - lists characters used for navigating the terminal menu and session management (CTRL+Z)
- System Time - displays current time

Navigating using the Keyboard Keys

You can use various keystrokes to move through the terminal menu, to manage a terminal menu session, and to configure the system. Press <CTRL+Z > to activate a pop-up screen listing the navigation keystrokes.

Moving through the Menus

To do this...	Press this key...
Return to the home screen	H
Jump between two menu items Press < J > while the cursor is located on a menu item, and you jump back to the main screen. Go to another menu item, press < J >, and you jump back to the screen that was displayed the first time you pressed < J >. Press < J > anytime you want to jump between these items.	J
Select items	Arrows
Edit a selected menu item	Enter

To do this...	Press this key...
Cancel an edit	Escape
Close pop-up help screen	Escape
Move between the left and right panes	Tab Arrows
Move to the top of a screen	A
Move to the bottom of a screen	Z
Ascend one menu level	Backspace

Session Management Keystrokes

To do this...	Press this key...
Log out of a session	CTRL+L
Invalidate the password entry and return to the login screen	CTRL+S
Refresh the screen To save time, only the portion of the screen that has changed is refreshed. This option should only be necessary if the display picks up incorrect characters caused by disconnecting and reconnecting the terminal session.	CTRL+R
View Extended Data Display data fields too large for display window.	CTRL+V

Configuration Keystrokes

To do this...	Press this key...
Restore factory default settings. This setting restores the factory defaults based on the location of the cursor. If the cursor is on a module line (in the MODULES menu), then only the selected module is updated to factory defaults.	F
Copy selected items to the clipboard. The amount of information you can copy depends on the cursor location when you press <C>: If the cursor is over an editable field, only that item is copied. If the cursor is over the index number of a list, then all of the items in the row of the list are copied. For example, if the cursor is over the SLOT # field in the MODULES screen, all of the information associated with the slot is copied.	C
Paste the item stored in the clipboard, if the information is compatible. You must confirm all pastes - except those to a single editable field.	P

To do this...	Press this key...
Increment the value of certain types of fields by one when you paste information into those fields.	>
Decrement the value of certain types of fields by one when you paste information into those fields.	<
Insert a new list item. For example, add a new item to the DEDICATED MAP connection list by pressing <I> while the cursor is over the index number.	I
Delete a list item. For example, delete an item from the DEDICATED MAP connection list by pressing <D> while the index number is active.	D

Getting Help

The bottom line of the terminal menu window contains context-sensitive help information. When the cursor is positioned over a set of configuration items, a help message displays (when available) providing a description of the item. When more detailed help is available for a particular item, ^A displays at the bottom of the window. At this point, pressing <CTRL+A> displays a pop-up help screen with information about the item.

Press <CTRL+Z> to activate a help screen that displays the available keystrokes you can use to navigate the terminal menu.

2. TERMINAL MENU AND SYSTEM CONTROL

Selecting the Appropriate Menu

The terminal menu is the access point to all other operations. Each terminal menu item has several functions and submenus that identify and provide access to specific operations and parameters. Use the chart below to help select the appropriate terminal menu.

To do this...	Go to this menu...
Review and monitor general system information for the ATLAS 550	SYSTEM INFO
Review and monitor system status for the ATLAS 550	SYSTEM STATUS
Set up the operational configuration for the ATLAS 550	SYSTEM CONFIG
Update settings, transfer files, perform system diagnostics, and reboot the ATLAS 550	SYSTEM UTILITY
Review and configure settings for each installed module, including the ATLAS 550 built-in network ports	MODULES

To do this...	Go to this menu...
Define and configure all layer 2 connections including Frame Relay and PPP endpoints	PACKET MANAGER
Define, configure and monitor all ATLAS 550 Router functions	ROUTER
Assign dedicated connections between any two ports in the ATLAS 550	DEDICATED MAPS
Access Dial Backup functions including monitoring the status of backup links, manually forcing a backup switch, and restoring a primary connection	CIRCUIT STATUS
Set global ATLAS 550 switch parameters or set individual parameters for each port in the ATLAS 550 that handles a switched call	DIAL PLAN

Security Levels

To edit terminal menu items, you must have a password and the appropriate security level. Table 1 describes the six security levels.

Table 1. Password Security Levels

Security Level	Description
5	Read-only permission for all menu items - minimum rights
4	Read permission for all menu items and permission to use test commands
3	Access to all commands except passwords, flash download, authentication methods, and interface configurations
2	Access to all commands except passwords, flash download, and authentication methods
1	Access to all commands except passwords
0	Permission to edit every menu item, including creating and editing passwords - maximum rights

3. MENU DESCRIPTIONS

The remainder of this section describes ATLAS 550 menu and submenu options



To help you follow the terminal menu hierarchy, the following notations are used:

MENUS > SUBMENUS > SUB-SUBMENUS

SYSTEM INFO

The **SYSTEM INFO** menu provides basic information about the unit as well as data fields for editing information. Figure 3 displays the submenus and data fields that are available when you select this menu item.

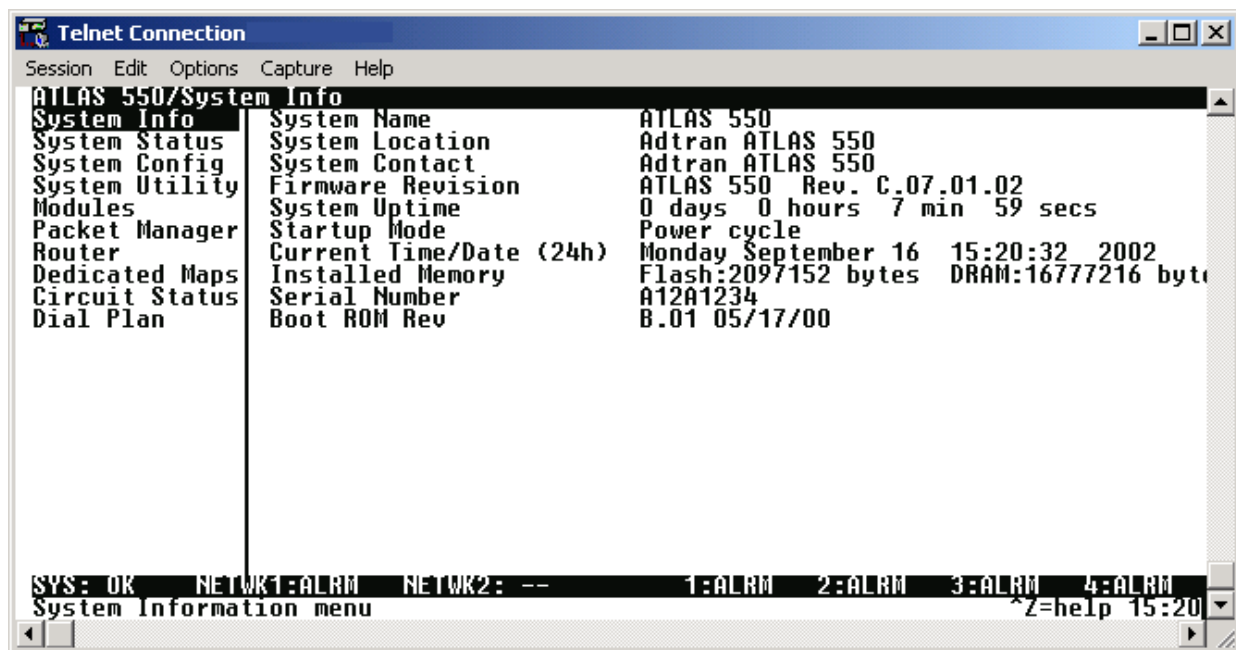

Figure 3. System Info Menu

SYSTEM INFO > SYSTEM NAME

Write security: 3; Read security: 5

Provides a user-configurable text string for the name of the ATLAS 550. This name can help you distinguish between different installations. You can enter up to 40 alphanumeric characters in this field, including spaces and special characters (such as an underbar).

SYSTEM INFO > SYSTEM LOCATION

Write security: 3; Read security: 5

Provides a user-configurable text string for the location of the ATLAS 550. This field is to help you keep track of the physical location of the unit. You can enter up to 40 alphanumeric characters in this field, including spaces and special characters (such as an underbar).

SYSTEM INFO > SYSTEM CONTACT

Write security: 3; Read security: 5

Provides a user-configurable text string for a contact name. You can use this field to enter the name, phone number, or e-mail address of a person responsible for the ATLAS 550 system. You can enter up to 40 alphanumeric characters in this field, including spaces and special characters (such as an underbar).

SYSTEM INFO > FIRMWARE REVISION**Read security: 5**

Displays the current firmware revision level of the controller.

SYSTEM INFO > SYSTEM UPTIME**Read security: 5**

Displays the length of time the ATLAS 550 system has been running. Each time you reset the system, this value resets to 0 days, 0 hours, 0 min and 0 secs.

SYSTEM INFO > STARTUP MODE**Read security: 5**

Displays details about the last system startup. For example, rebooting the ATLAS 550 from the **SYSTEM UTILITY** menu will cause this field to read **WARM REBOOT**.

SYSTEM INFO > CURRENT TIME/DATE (24HR)**Write security: 3; Read security: 5**

Displays the current date and time, including seconds. To edit this field, place the cursor on the field and press <Enter>. Then, enter the time in a 24-hour format (such as 23:00:00 for 11:00 pm), and the date in mm-dd-yyyy format (for example, 10-30-1998). Press <Enter> when you are finished to accept the change.

SYSTEM INFO > INSTALLED MEMORY**Read security: 5**

Displays the type and amount of memory in use (including Flash memory and DRAM).

SYSTEM INFO > SERIAL NUMBER**Read security: 5**

Displays the serial number for the unit. The serial number of the ATLAS 550 will automatically display in this field.

SYSTEM INFO > BOOT ROM REV**Read security: 5**

Displays the boot ROM revision.

SYSTEM STATUS

The **SYSTEM STATUS** menu provides the user with status information about the ATLAS 550 operational parameters including logged system events and timing. Figure 4 displays the submenus and data fields that are available when you select this menu item.

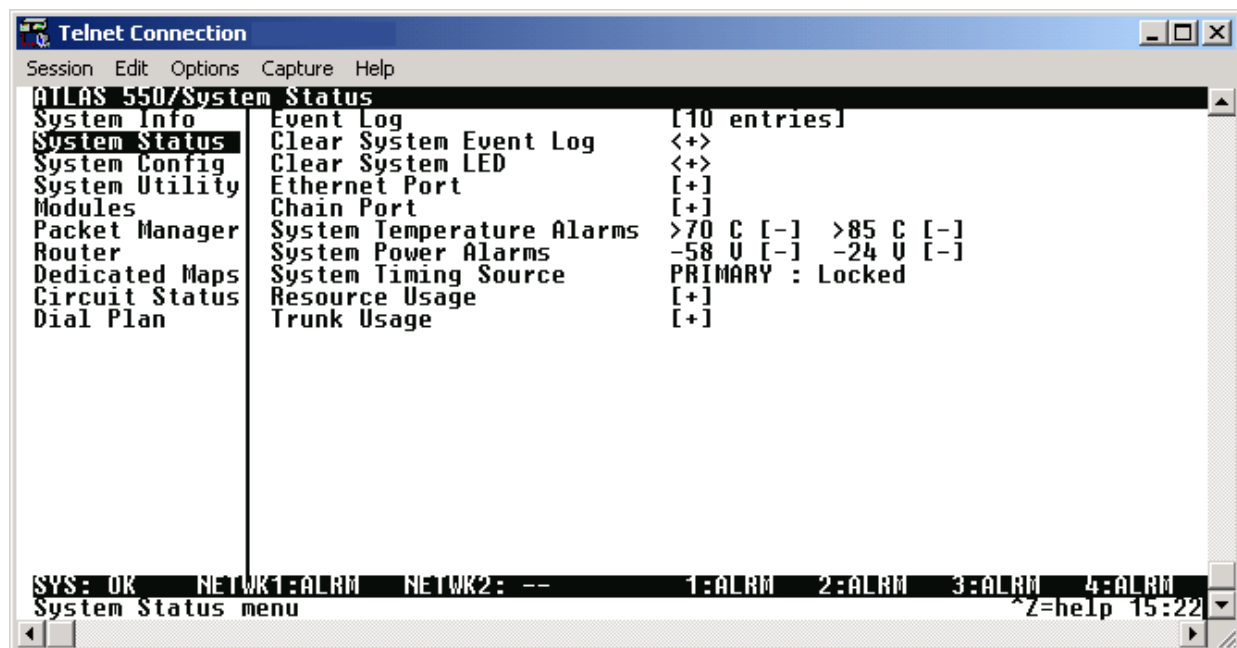

Figure 4. System Status Menu

SYSTEM STATUS > EVENT LOG

Read security: 5

Displays the last 349 warning or failure messages sent, including the day, date, and priority of the message. The most recent messages display at the top of the list. The following read-only fields are available to review:

SYSTEM STATUS > EVENT LOG > TIME

Read security: 5

Displays the date (mm/dd) and the time (hh:mm:ss) that the event occurred.

SYSTEM STATUS > EVENT LOG > CAT

Read security: 5

Displays the severity of the event. The possible categories are **CRITICAL**, **MAJOR**, **MINOR**, **WARNING**, **NORMAL**, and **INFO**. You can specify which types of errors you want the system to log with the System Event Logging option. See *Section 7, System Event Logging*, for details.

SYSTEM STATUS > EVENT LOG > SRC**Read security: 5**

Displays the source of the event.

SYSTEM STATUS > EVENT LOG > SLOT**Read security: 5**Displays the slot number in which the event occurred. If this field displays **(0)**, the event that occurred was on one of the two built-in network ports.**SYSTEM STATUS > EVENT LOG > PORT****Read security: 5**

Displays the port in which the event occurred.

SYSTEM STATUS > EVENT LOG > EVENT DESCRIPTION**Read security: 5**

Displays a description of the event.

SYSTEM STATUS > CLEAR SYSTEM EVENT LOG**Write security: 3; Read security: 3**

Clears the event log. When you select this command, the following prompt displays:

```
— Confirm (y/n) —  
This will clear the entire event log.
```

Select **Y** to clear the log or **N** to exit the command.*If you clear the event log, you cannot retrieve the data.***SYSTEM STATUS > CLEAR SYSTEM LED****Write security: 3; Read security: 3**Changes the color of the **SYSTEM** LED on the front panel from yellow (indicating a previous error) to green (OK). The **SYSTEM** LED turns red if the ATLAS 550 detects a major system failure. If the failure condition clears, the LED turns yellow to warn of the past failure.**SYSTEM STATUS > ETHERNET PORT****Read security: 5**Displays status information about the **ETHERNET** port. An asterisk (*) indicates activity for the item. The following read-only fields are available to review:

SYSTEM STATUS > ETHERNET PORT > I/F STATUS**Read security: 5**Indicates the current status of the **ETHERNET** port.**SYSTEM STATUS > ETHERNET PORT > TX FRAMES****Read security: 5**Indicates the number of frames transmitted from the **ETHERNET** port since system startup.**SYSTEM STATUS > ETHERNET PORT > RX FRAMES****Read security: 5**Indicates the number of frames received on the **ETHERNET** port since system startup.**SYSTEM STATUS > ETHERNET PORT > ETHERNET RATE****Read security: 5**

Indicates whether the Ethernet network is 10 or 100BaseT.

SYSTEM STATUS > CHAIN PORT**Write security: 2; Read security: 5**Displays the status of the RJ-45 (female) **CONTROL IN** (Chain) port.**SYSTEM STATUS > CHAIN PORT > SIGNAL LEADS****Read security: 5**Displays the state of the **CONTROL IN** (Chain) port signals (**RTS**, **CTS**, **DTR**, and **DCD**).**SYSTEM STATUS > CHAIN PORT > TX BYTES****Read security: 5**Displays the number of bytes transmitted from the **CONTROL IN** (Chain) port.**SYSTEM STATUS > CHAIN PORT > RX BYTES****Read security: 5**Displays the number of bytes received by the **CONTROL IN** (Chain) port.**SYSTEM STATUS > CHAIN PORT > OVERRUN ERRS****Read security: 5**Displays the number of overrun errors received by the **CONTROL IN** (Chain) port.**SYSTEM STATUS > CHAIN PORT > FRAMING ERRS****Read security: 5**Displays the number of framing errors received by the **CONTROL IN** (Chain) port.

SYSTEM STATUS > CHAIN PORT > CLEAR COUNTERS**Write security: 5; Read security: 5**

Clears the **CONTROL IN** (Chain) port statistics. Press **Y** to activate this command.

SYSTEM STATUS > SYSTEM TEMPERATURE ALARMS**Read security: 5**

Indicates that the internal temperature of the unit has exceeded normal operating limits. The two thresholds indicate that the internal temperature is greater than 70°C and greater than 85°C. If one of these thresholds is exceeded, a warning will be placed in the **EVENT LOG** (see *Section 7, System Event Logging* for more details) but no other action will be taken. The following status symbols are used:

[–]	Normal condition
[*]	Failure condition
[!]	No Information Available

SYSTEM STATUS > SYSTEM POWER ALARMS**Read security: 5**

Indicates that the -58V and/or -24V power supplies are not functional. These power supplies are continuously monitored to determine failures. If one of these supplies fails, a message will be placed in the **EVENT LOG** (see *Section 7, System Event Logging* for more details). The following status symbols are used:

[–]	Normal condition
[*]	Failure condition
[!]	No Information Available

SYSTEM STATUS > SYSTEM TIMING SOURCE**Read security: 5**

Indicates which timing source (primary or backup) is currently being used by ATLAS 550 and whether the system is locked onto this source. If the display does not indicate locked, the ATLAS 550 does not have a valid source of timing and cannot reliably transfer data. Review the current setting for system timing source in the **SYSTEM CONFIG** menu. See *System Config > Primary Timing Source* on page 79 and *System Config > Backup Timing Source* on page 79 for details.

SYSTEM STATUS > RESOURCE USAGE**Write security: 5; Read security: 5**

Provides resource usage tracking for dynamic resources throughout the system. This includes current, average, and minimum availability for both analog and digital resources.

SYSTEM STATUS > RESOURCE USAGE > DATA TABLES**Read security: 5**

Displays resource usage for dynamic resources throughout the system in a table format.

SYSTEM STATUS > RESOURCE USAGE > DATA TABLES > RESOURCE TYPE**Read security: 5**

Displays types of dynamically allocated resources being tracked throughout the system. Examples are **ANALOG** (analog modem resource), **DIGITAL** (digital call resource), and **PKT VOICE** (packet voice compression resource).

SYSTEM STATUS > RESOURCE USAGE > DATA TABLES > CURRENT**Read security: 5**

Shows the number of resources available (not in use) and the total number of resources. If a resource is taken offline, it is not included in the total.

SYSTEM STATUS > RESOURCE USAGE > DATA TABLES > AVERAGE**Read security: 5**

Shows the average number of resources available since the statistics were last reset.

SYSTEM STATUS > RESOURCE USAGE > DATA TABLES > MIN**Read security: 5**

Shows the fewest number of resources available since the last reset.

SYSTEM STATUS > RESOURCE USAGE > DATA TABLES > 0 (ZERO) AVAIL**Read security: 5**

Provides a count of the number of times the quantity of available resources reached 0.

SYSTEM STATUS > RESOURCE USAGE > DATA TABLES > HR DATA**Read security: 5**

Displays the **AVERAGE**, **MINIMUM**, and **0 AVAILABLE** data broken down in hour increments for a 24-hour period.

SYSTEM STATUS > RESOURCE USAGE > DATA TABLES > RESET**Write security: 4; Read security: 5**

Activates the reset of all accumulated availability statistics for the selected resource.

SYSTEM STATUS > RESOURCE USAGE > CONFIG**Write security: 3; Read security: 5**

Configures the statistics displayed under data tables.

SYSTEM STATUS > RESOURCE USAGE > CONFIG > DISPLAY FORMAT

Write security: 3; Read security: 5

Sets the display format for all **RESOURCE USAGE** statistics to either **RAW DATA** or **PERCENTAGES**.

SYSTEM STATUS > RESOURCE USAGE > CONFIG > RESET MODE

Write security: 3; Read security: 5

Sets the reset mode for the **RESOURCE USAGE** statistics to one of the following:

DAILY	performs reset daily at 12:00 AM
WEEKLY	performs reset on Saturday night, 12:00 AM
MANUAL	disables automatic reset of the resource usage statistics

SYSTEM STATUS > TRUNK USAGE

Write security: 5; Read security: 5

Indicates trunk use as **NET TERM PRI** (Primary Rate ISDN circuits configured as **NETWORK TERM**), **NET TERM RBS** (T1/RBS trunks configured as **NETWORK TERM**); **USER TERM PRI** (Primary Rate ISDN circuits configured as **USER TERM**), **USER TERM RBS** (T1/RBS trunks configured as **USER TERM**).

SYSTEM STATUS > TRUNK USAGE > DATA TABLES

Read security: 5

Display for collected resource usage data.

SYSTEM STATUS > TRUNK USAGE > DATA TABLES > TRUNK TYPE

Read security: 5

Displays types of trunks in the system. Examples include: **NETRBS** (T1/RBS trunks configured as **NETWORK TERM**), **NETPRI** (Primary Rate ISDN circuits configured as **NETWORK TERM**), **USERRBS** (T1/RBS trunks configured as **USER TERM**), and **USERPRI** (Primary Rate ISDN circuits configured as **USER TERM**).

SYSTEM STATUS > TRUNK USAGE > DATA TABLES > CURRENT

Read security: 5

Shows the number of resources available (not in use) and the total number of resources. If a resource is taken offline, it is not included in the total.

SYSTEM STATUS > TRUNK USAGE > DATA TABLES > AVERAGE

Read security: 5

Shows the average number of resources available since the statistics were last reset.

SYSTEM STATUS > TRUNK USAGE > DATA TABLES > MIN

Read security: 5

Shows the fewest number of resources available since the last reset.

SYSTEM STATUS > TRUNK USAGE > DATA TABLES > 0 (ZERO) AVAIL**Read security: 5**

Provides a count of the number of times the quantity of available resources reached 0.

SYSTEM STATUS > TRUNK USAGE > DATA TABLES > SLT/PRT**Read security: 5**

Displays the usage data broken down by slots and ports.

SYSTEM STATUS > TRUNK USAGE > DATA TABLES > RESET**Write security: 4; Read security: 5**

Activates the reset of all accumulated availability statistics.

SYSTEM STATUS > TRUNK USAGE > CONFIG**Write security: 5; Read security: 5**

Configures the statistics displayed under data tables.

SYSTEM STATUS > TRUNK USAGE > CONFIG > DISPLAY FORMAT**Write security: 5; Read security: 5**

Sets the display format for all **TRUNK USAGE** statistics to either **RAW DATA** or **PERCENTAGES**.

SYSTEM STATUS > TRUNK USAGE > CONFIG > RESET MODE**Write security: 3; Read security: 5**

Sets the reset mode for the **TRUNK USAGE** statistics to one of the following:

DAILY	performs reset daily at 12:00 AM
WEEKLY	performs reset on Saturday night, 12:00 AM
MANUAL	disables automatic reset of the trunk usage statistics

SYSTEM CONFIG

The **SYSTEM CONFIG** menu allows you to set up the ATLAS 550 operational configuration. Figure 5 shows the items included in this menu.

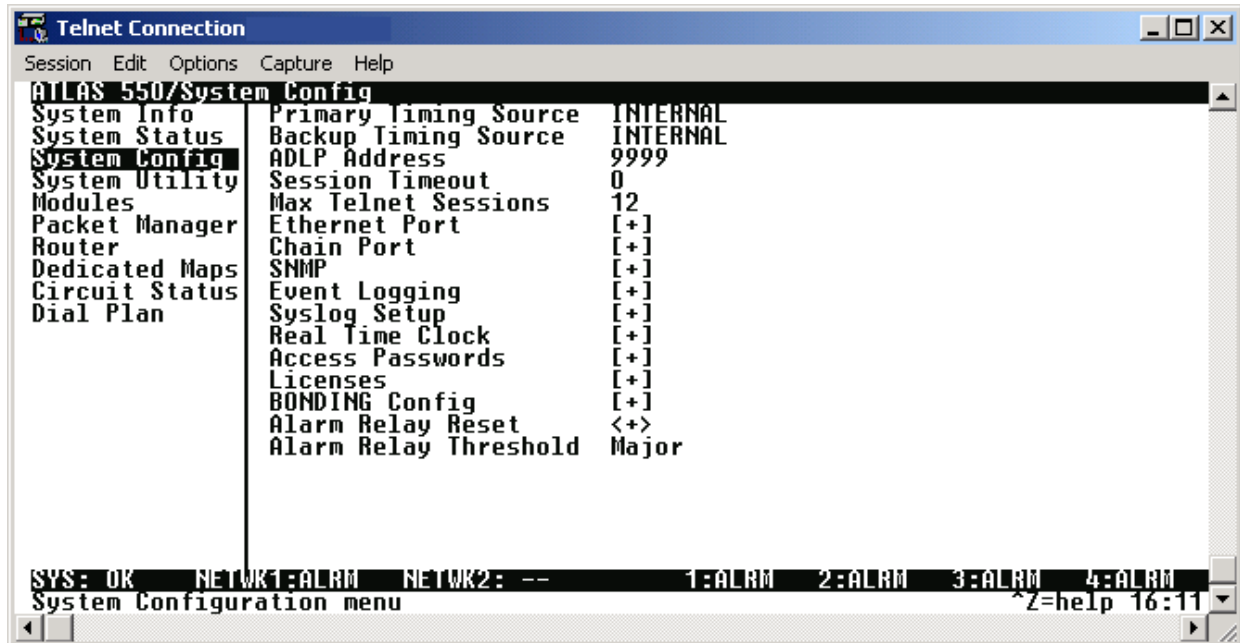

Figure 5. System Config Menu

SYSTEM CONFIG > PRIMARY TIMING SOURCE

Write security: 1; Read security: 5

Selects the primary timing source. You can select either **INTERNAL** or any port available on the system that is capable of providing timing. Please refer to the specific module information to determine if a port can provide timing for the system.

SYSTEM CONFIG > BACKUP TIMING SOURCE

Write security: 1; Read security: 5

Selects the secondary timing source. You can select either **INTERNAL** or any port available on the system that is capable of providing timing. Please refer to the specific module information to determine if a port can provide timing for the system. The ATLAS 550 uses the backup timing source if the primary timing source goes into alarm. The **BACKUP TIMING SOURCE** should be different from the **PRIMARY TIMING SOURCE** for the most reliable operation.

SYSTEM CONFIG > ADLP ADDRESS

Write security: 2; Read security: 5

Shows the system ADTRAN Data Link Layer Protocol (ADLP) address for connecting remote devices to ADTRAN management software. The allowable range is between 2 and 65520. Enter a value not used by any other ADTRAN units controlled by the management software.

SYSTEM CONFIG > SESSION TIMEOUT**Write security: 3; Read security: 5**

Defines the number of seconds the terminal session must remain idle before the session times out (valid range 0 to 65535). You can enter zero to deactivate this option (the session will never time out).

SYSTEM CONFIG > MAX TELNET SESSIONS**Write security: 3; Read security: 5**

Defines the maximum number of Telnet sessions that can be active at the same time. Enter a number between 0 and 12 in this field.



If you enter zero in this field, you will not be able to use Telnet. Only enter zero if you want to completely lock out Telnet access.

SYSTEM CONFIG > ETHERNET PORT**Write security: 2; Read security: 5**

Provides a way to configure various settings for the **ETHERNET** port. The following options are available for review and editing:

SYSTEM CONFIG > ETHERNET PORT > PORT NAME**Write security: 2; Read security: 5**

Defines the name of the **ETHERNET** port. Enter up to 16 alphanumeric characters in this field, including spaces and special characters (such as underbar). This field may be left blank.

SYSTEM CONFIG > ETHERNET PORT > IP ADDRESS**Write security: 2; Read security: 5**

Lists the address assigned to the base **ETHERNET** port. This address is in dotted decimal notation (four decimal numbers, each in the range of 0 to 255, separated by periods). This value is set to 10.0.0.1 by default. The IP address is used for the 10/100BaseT **ETHERNET** interface. Obtain the correct IP address from your LAN administrator.

SYSTEM CONFIG > ETHERNET PORT > DEFAULT GATEWAY**Write security: 2; Read security: 5**

Defines or changes the default gateway. Enter the default gateway address by entering a decimal number into the appropriate field and then pressing <Enter> to move to the next field. You will need a default gateway if the LAN contains multiple segments. This address is in dotted decimal notation (four decimal numbers, each in the range of 0 to 255, separated by periods). This value is set to 0.0.0.0 by default. Contact your LAN administrator for the appropriate address.

SYSTEM CONFIG > ETHERNET PORT > SUBNET MASK**Write security: 2; Read security: 5**

Defines which part of a destination IP address contains the network number. This address is in dotted decimal notation (four decimal numbers, each in the range of 0 to 255, separated by periods). This value is

set to 255.255.255.0 by default. This part of the destination IP address is used along with the ATLAS 550 IP address to determine which nodes must be reached through the default IP gateway.

SYSTEM CONFIG > ETHERNET PORT > MAC ADDRESS

Read security: 5

Displays the system Ethernet Media Access Control (MAC) address. This field is read-only.

SYSTEM CONFIG > ETHERNET PORT > ETHERNET SPEED

Write security: 2; Read security: 5

Defines the rate at which the **ETHERNET** port operates. Choose from **10 MBPS** or **AUTO 10/100**. When the unit is set for **AUTO 10/100**, the ATLAS 550 auto-detects the data rate of the LAN and sets itself to that rate, either 10 or 100 Mbps.

SYSTEM CONFIG > ETHERNET PORT > DHCP STATUS

Read security: 5

Displays the current status of the DHCP client in the ATLAS 550. The following states are possible (per RFC 2131): **INIT**, **SELECTING**, **REQUESTING**, **BOUND**, **RENEWING**, **REBINDING**, **INIT-REBOOT**, **REBOOTING**, and **NON-INIT**.

SYSTEM CONFIG > ETHERNET PORT > LEASE EXPIRES

Read security: 5

Displays the date and time the current IP address lease will expire and a new one will be necessary.

SYSTEM CONFIG > ETHERNET PORT > RELEASE

Write security: 2; Read security: 5

Forces the ATLAS 550 to release the currently assigned IP address.



Once the IP address is manually released, the ATLAS 550 will not be available for Telnet access until a manual renew is performed.

SYSTEM CONFIG > ETHERNET PORT > RENEW

Write security: 2; Read security: 5

Forces the ATLAS 550 to send a message to the DHCP server requesting a new IP address lease.

SYSTEM CONFIG > CHAIN PORT

Write security: 2; Read security: 5

Accepts input for configuring the **CONTROL IN** (Chain) port located on the rear of the unit.

SYSTEM CONFIG > CHAIN PORT > PORT NAME**Write security: 2; Read security: 5**

Defines the name of the **CONTROL IN** (Chain) port. You can leave this field blank.

SYSTEM CONFIG > CHAIN PORT > PORT TYPE**Write security: 2; Read security: 5**

Specifies whether you use **DIRECT** or **DIAL** mode. **DIRECT** mode is used when connecting to a VT100 terminal, and **DIAL** mode is used for modem access.

SYSTEM CONFIG > CHAIN PORT > PORT SPEED**Write security: 2; Read security: 5**

Specifies the baud rate of the port. Select either **2400**, **9600**, **19200**, or **38400**. If you are using **DIAL** for **PORT TYPE**, ensure that the **PORT SPEED** setting matches the modem baud rate.

SYSTEM CONFIG > CHAIN PORT > MODEM INITIALIZATION STRING**Write security: 2; Read security: 5**

Specifies the initialization string for the modem. Refer to your modem documentation for acceptable initialization strings. The default value will configure most modems to the appropriate configuration for the ATLAS 550.

SYSTEM CONFIG > CHAIN PORT > INITIALIZE MODEM**Write security: 4; Read security: 5**

Sends the modem initialization string to the modem. When you select this command, the following message displays: **PLEASE VERIFY A MODEM IS CONNECTED TO THE CHAIN PORT BEFORE CONTINUING. CONFIRM (Y/N)**. Ensure that a modem is connected before selecting **Y**.

SYSTEM CONFIG > ADMIN PORT > FLOW CONTROL**Write security: 2; Read security: 5**

This option sets the flow control for the **CONTROL IN** (Chain) port. You may configure the **CONTROL IN** (Chain) port flow control for **NONE** or **HARDWARE**.

SYSTEM CONFIG > SNMP**Write security: 3; Read security: 5**

Provides a way to configure SNMP access for the ATLAS 550. The following options are available for review and editing:

SYSTEM CONFIG > SNMP > SNMP ACCESS**Write security: 3; Read security: 5**

Defines whether SNMP access to the ATLAS 550 is **ENABLED** or **DISABLED**. Select the appropriate option for your application.

SYSTEM CONFIG > SNMP > SNMP COMMUNITIES**Write security: 3; Read security: 5**

Defines SNMP manager(s) characteristics as follows:

SYSTEM CONFIG > SNMP > SNMP COMMUNITIES > IP ADDRESS**Write security: 3; Read security: 5**

Specifies the IP address of the network manager.

SYSTEM CONFIG > SNMP > SNMP COMMUNITIES > PRIVILEGES**Write security: 3; Read security: 5**Defines the **GET** (read-only) and **GET/SET** (read and write) privileges.**SYSTEM CONFIG > SNMP > SNMP COMMUNITIES > GET NAME****Write security: 3; Read security: 5**Defines the community name for **GET** access. This value must match the **GET** name defined on the network management station (NMS). **PUBLIC** is the default name.**SYSTEM CONFIG > SNMP > SNMP COMMUNITIES > SET NAME****Write security: 3; Read security: 5**Defines the community name for **SET** access. This value must match either the **GET** or **SET** name defined on the network management station (NMS). **PUBLIC** is the default name.**SYSTEM CONFIG > SNMP > TRAP TRANSMISSION****Write security: 3; Read security: 5**

Enables and disables SNMP trap transmission.

SYSTEM CONFIG > SNMP > AUTHEN TRAP TRANSMISSION**Write security: 3; Read security: 5**Enables and disables the authentication failure trap. The authentication failure trap is sent (when **ENABLED**) each time authenticated access to the ATLAS 550 fails.**SYSTEM CONFIG > SNMP > TRAPS DESTINATION****Write security: 3; Read security: 5**

Defines the destination for SNMP traps as follows:

SYSTEM CONFIG > SNMP > TRAPS DESTINATION > IP ADDRESS**Write security: 3; Read security: 5**

Identifies the IP address for the network management station (NMS) to send traps to.

SYSTEM CONFIG > SNMP > TRAPS DESTINATION > COMMUNITY**Write security: 3; Read security: 5**

Defines the community name for trap destinations. This name must match the community name defined on the network management station (NMS).

SYSTEM CONFIG > SNMP > TRAPS DESTINATION > TRAP FILTERING**Write security: 3; Read security: 5**

Sets the minimum severity level required for a system event to generate an SNMP trap. If a trap event occurs with a severity level equal to or more severe than the trap type's current threshold setting, the event is sent as an SNMP trap. (Refer to the ADTRAN Technical Support web page (www.adtran.com) for a listing of all MIBs containing traps and their severity levels.) The available selections for the threshold levels are: **DISABLED, CRITICAL, MAJOR, MINOR, WARNING, NORMAL, and INFO.**

SYSTEM CONFIG > SNMP > TRAPS DESTINATION > STATION TYPE**Write security: 3; Read security: 5**

To deliver the SNMP trap packet with the **COMMUNITY NAME** unchanged, define the **STATION TYPE** as **NORMAL**. If you are using T-Watch PRO, define the **STATION TYPE** as **T-WATCH MGMT** and append the **COMMUNITY NAME** with ".ADLP ADDRESS." Within the SNMP trap packet, this field is automatically updated before it is sent to the management station.

SYSTEM CONFIG > SNMP > DS1 CURRENT PERF THRESHOLDS**Write security: 3; Read security: 5**

Defines performance threshold values for DS1 Line and Path statistics recorded in a 15-minute interval. Refer to the ADTRAN Enterprise MIB and the DS1 Extension MIB (available on the documentation CD or the ADTRAN website at www.adtran.com) for more MIB-specific information. If a statistic value exceeds its threshold value, then the corresponding Alert Trap will be sent if the Alert Event is armed and Alert Traps are enabled. These thresholds apply to all DS1 interfaces in the system.

SYSTEM CONFIG > SNMP > DS1 CURRENT PERF THRESHOLDS > CURRENT ES THRS**Write security: 3; Read security: 5**

The DS1 performance monitor Threshold Value for the Current 15 minute Errored Seconds (ES) parameter. The default value is 65 for an approximate BER level of 10E-5.

SYSTEM CONFIG > SNMP > DS1 CURRENT PERF THRESHOLDS > CURRENT SES THRS**Write security: 3; Read security: 5**

The DS1 performance monitor Threshold Value for the Current 15 minute Severely Errored Seconds (SES) parameter. The default value is 10 for an approximate BER level of 10E-5.

SYSTEM CONFIG > SNMP > DS1 CURRENT PERF THRESHOLDS > CURRENT SEFS THRS**Write security: 3; Read security: 5**

The DS1 performance monitor Threshold Value for the Current 15 minute Severely Errored Framing Seconds (SEFS) parameter. The default value is 2 for an approximate BER level of 10E-5.

SYSTEM CONFIG > SNMP > DS1 CURRENT PERF THRESHOLDS > CURRENT UAS THRSH**Write security: 3; Read security: 5**

The DS1 performance monitor Threshold Value for the Current 15 minute Unavailable Seconds (UAS) parameter. The default value is 10 for an approximate BER level of 10E-5.

SYSTEM CONFIG > SNMP > DS1 CURRENT PERF THRESHOLDS > CURRENT CSS THRSH**Write security: 3; Read security: 5**

The DS1 performance monitor Threshold Value for the Current 15 minute Controlled Slip Seconds (CSS) parameter. The default value is 1 for an approximate BER level of 10E-5.

SYSTEM CONFIG > SNMP > DS1 CURRENT PERF THRESHOLDS > CURRENT PCV THRSH (D4)**Write security: 3; Read security: 5**

The DS1 performance monitor Threshold Value for the Current 15 minute Path Code Violations (PCV) parameter, when the Line Type is Super Frame (AT&T D4 format) DS1. The default value is 72 framing errors for an approximate BER level of 10E-5.

SYSTEM CONFIG > SNMP > DS1 CURRENT PERF THRESHOLDS > CURRENT PCV THRSH (ESF)**Write security: 3; Read security: 5**

The DS1 performance monitor Threshold Value for the Current 15 minute Path Code Violations (PCV) parameter, when the Line Type is Extended Super Frame DS1. The default value is 13,296 CRC errors for an approximate BER level of 10E-5.

SYSTEM CONFIG > SNMP > DS1 CURRENT PERF THRESHOLDS > CURRENT LES THRSH**Write security: 3; Read security: 5**

The DS1 performance monitor Threshold Value for the Current 15 minute Line Errored Seconds (LES) parameter. The default value is 65 for an approximate BER level of 10E-5.

SYSTEM CONFIG > SNMP > DS1 CURRENT PERF THRESHOLDS > CURRENT LCV THRSH**Write security: 3; Read security: 5**

The DS1 performance monitor Threshold Value for the Current 15 minute Line Code Violations (LCV) parameter. The default value is 13,340 for an approximate BER level of 10E-5.

SYSTEM CONFIG > SNMP > DS1 TOTAL PERF THRESHOLDS**Write security: 3; Read security: 5**

Defines performance threshold values for DS1 Line and Path statistics. Refer to the ADTRAN Enterprise MIB and DS1 Extension MIB (available on the ADTRAN website at www.adtran.com) for more MIB specific information. If a statistic value exceeds its threshold value, then the corresponding Alert Trap will be sent if the Alert Event is armed and Alert Traps are enabled. These thresholds apply to all DS1 interfaces in the system.

SYSTEM CONFIG > SNMP > DS1 TOTAL PERF THRESHOLDS > TOTAL ES THRS**Write security: 3; Read security: 5**

The DS1 performance monitor Threshold Value for the Total Errored Seconds (ES) parameter. The default value is 648 for an approximate BER level of 10E-5.

SYSTEM CONFIG > SNMP > DS1 TOTAL PERF THRESHOLDS > TOTAL SES THRS**Write security: 3; Read security: 5**

The DS1 performance monitor Threshold Value for the Total Severely Errored Seconds (SES) parameter. The default value is 100 for an approximate BER level of 10E-5.

SYSTEM CONFIG > SNMP > DS1 TOTAL PERF THRESHOLDS > TOTAL SEFS THRS**Write security: 3; Read security: 5**

The DS1 performance monitor Threshold Value for the Total Severely Errored Framing Seconds (SEFS) parameter. The default value is 17 for an approximate BER level of 10E-5.

SYSTEM CONFIG > SNMP > DS1 TOTAL PERF THRESHOLDS > TOTAL UAS THRS**Write security: 3; Read security: 5**

The DS1 performance monitor Threshold Value for the Total Unavailable Seconds (UAS) parameter. The default value is 10 for an approximate BER level of 10E-5.

SYSTEM CONFIG > SNMP > DS1 TOTAL PERF THRESHOLDS > TOTAL CSS THRS**Write security: 3; Read security: 5**

The DS1 performance monitor Threshold Value for the Total Controlled Slip Seconds (CSS) parameter. The default value is 4 for an approximate BER level of 10E-5.

SYSTEM CONFIG > SNMP > DS1 TOTAL PERF THRESHOLDS > TOTAL PCV THRS (D4)**Write security: 3; Read security: 5**

The DS1 performance monitor Threshold Value for the Total Path Code Violations (PCV) parameter, when the Line Type is Super Frame (AT&T D4 format) DS1. The default value is 691 framing errors for an approximate BER level of 10E-5.

SYSTEM CONFIG > SNMP > DS1 TOTAL PERF THRESHOLDS > TOTAL PCV THRS (ESF)**Write security: 3; Read security: 5**

The DS1 performance monitor Threshold Value for the Total Path Code Violations (PCV) parameter, when the Line Type is Extended Super Frame DS1. The default value is 132,960 CRC errors for an approximate BER level of 10E-5.

SYSTEM CONFIG > SNMP > DS1 TOTAL PERF THRESHOLDS > TOTAL LES THRS**Write security: 3; Read security: 5**

The DS1 performance monitor Threshold Value for the Total Line Errored Seconds (LES) parameter. The default value is 648 for an approximate BER level of 10E-5.

SYSTEM CONFIG > SNMP > DS1 TOTAL PERF THRESHOLDS > TOTAL LCV THRSH

Write security: 3; Read security: 5

The DS1 performance monitor Threshold Value for the Total Line Code Violations (LCV) parameter. The default value is 133,400 for an approximate BER level of 10E-5.

SYSTEM CONFIG > SNMP > ASP ENDPOINT COMMUNITIES

Write security: 0; Read security: 0

Configures the ADLP list used when accepting incoming traps from remote ADTRAN TSU 100 Series or ISU 512 units. For a trap to be recognized and sent to the network management station (NMS) listed in the **TRAPS DESTINATION** field, the remote unit must be listed in the **ASP ENDPOINT COMMUNITIES** list. The **ADLP ADDRESS** and **ADLP PASSWORD** parameters must be configured.

SYSTEM CONFIG > SNMP > ASP ENDPOINT COMMUNITIES > ADLP ADDRESS

Write security: 0; Read security: 0

Enter the ADLP address (Unit ID) of the remote unit. Only traps containing an ADLP address listed here will be accepted.

SYSTEM CONFIG > SNMP > ASP ENDPOINT COMMUNITIES > ADLP PASSWORD

Write security: 0; Read security: 0

Enter the ADLP password (Unit Password) of the remote unit. The password will be verified before traps will be accepted from the remote unit.

SYSTEM CONFIG > SNMP > SNMP/ASP PROXY

Write security: 0; Read security: 0

Enables or disables Get_Request capabilities for remote units. When enabled, this feature allows SNMP requests to be sent from the network management station (NMS) through the ATLAS 550 to the selected remote unit. Remote units must be ADTRAN TSU 100 Series or ISU 512 products. All remote units must be listed in the **ASP ENDPOINT COMMUNITIES** list.

SYSTEM CONFIG > SNMP > SNMP/ASP POLLING

Write security: 0; Read security: 0

Enables or disables trap polling through the ATLAS 550 to remote ADTRAN TSU 100 Series or ISU 512 units. When enabled, this feature allows the ATLAS 550 to forward any traps received from remote units to the network management station (NMS) listed in the **TRAPS DESTINATION** field. The remote unit must be listed in the **ASP ENDPOINT COMMUNITIES** for the traps to be forwarded.

SYSTEM CONFIG > EVENT LOGGING

Write security: 3; Read security: 5

Sets the system event severity level threshold for each of the ATLAS 550 system event types. When a system event occurs, the event is logged if the event's severity level is equal to or more severe than the event type's current threshold setting. See *Section 7, System Event Logging*, for detailed information on the system events.

SYSTEM CONFIG > SYSLOG SETUP**Write security: 3; Read security: 3**

Configures the ATLAS 550 Syslog client for use with a Syslog server (supplied with ADTRAN Utilities or available on most UNIX platforms).

SYSTEM CONFIG > SYSLOG SETUP > TRANSMISSION**Write security: 3; Read security: 3**

Enables or disables the transmission of log events to the external Syslog server.

SYSTEM CONFIG > SYSLOG SETUP > HOST IP ADDRESS**Write security: 3; Read security: 3**

Lists the IP address of the external server that is running the Syslog host daemon.

SYSTEM CONFIG > SYSLOG SETUP > HOST FACILITY**Write security: 3; Read security: 3**

Specifies the facility destination of log events. Facilities are located on the host and are managed by the Syslog host daemon running on either a UNIX machine or a PC. For details on the ADTRAN syslog server host facilities, please refer to *Section 8, ADTRAN Utilities*.

SYSTEM CONFIG > REAL TIME CLOCK**Write security: 3; Read security: 5**

Provides access to the two options listed below. You can review and edit these options.

SYSTEM CONFIG > REAL TIME CLOCK > CURRENT TIME/DATE**Write security: 3; Read security: 5**

Displays the current date and time, including seconds. To edit this field, enter the time in 24-hour format (such as 23:00:00 for 11:00 pm), and enter the date in mm-dd-yyyy format (for example, 09-23-1998).

SYSTEM CONFIG > REAL TIME CLOCK > AUTO DAYLIGHT SAVINGS**Write security: 3; Read security: 5**

When enabled, automatically updates the time and date when Daylight Savings Time starts and when Standard Time ends.

SYSTEM CONFIG > ACCESS PASSWORDS**Write security: 0; Read security: 0**

Provides a way to edit passwords and to add new users and passwords. All menu items are protected by passwords of varying security levels. By assigning different passwords to different security levels, the ATLAS 550 system administrator can control which users can change various menu items. You can assign multiple passwords at the same access level. This way, different users with the same access privileges can have different passwords. The six password security levels are described in Table 1 on page 69.

SYSTEM CONFIG > ACCESS PASSWORDS > LABEL**Write security: 0; Read security: 0**

Defines a username. The defined username is for labeling purposes only; it is not used for access into the system.

SYSTEM CONFIG > ACCESS PASSWORDS > PASSWORD**Write security: 0; Read security: 0**

Allows you to change the password (the default password is “password”). The current password displays as a series of asterisks (*****). The password can contain up to a combination of 12 case-sensitive alphanumeric characters, spaces, or special characters.

SYSTEM CONFIG > ACCESS PASSWORDS > ACCESS RIGHTS**Write security: 0; Read security: 0**

Defines the password level for the corresponding label. You can select from six different password levels (see Table 1 on page 69).

SYSTEM CONFIG > ACCESS PASSWORDS > ACTIVE**Read security: 0**

Displays the number of users currently logged into the system (listed for each configured **LABEL**).

SYSTEM CONFIG > LICENSES**Write security: 0; Read security: 0**

(Not currently used.) Provides menus to enable the optional ATLAS 550 feature upgrades.

FEATURE	Names the ATLAS 550 feature upgrade.
LICENSE KEY	Displays the license key of the feature upgrade.
SERIAL NUMBER	Displays the serial number of the feature upgrade.
LIC CNT	Displays the number of instances of the feature that the license provides. This field may not be applicable for a given feature -- if it is not, this field is blank.
STATUS	Reflects the status, PERMANENT or TEMPORARY , of the feature upgrade license key.

SYSTEM CONFIG > BONDING CONFIG**Write security: 3; Read security: 5**

Displays the configuration submenus available for the BONDing Module. This configuration is shared among all BONDing Modules.

SYSTEM CONFIG > BONDING CONFIG > TXINIT TIMER**Write security: 3; Read security: 5**

Specifies the length of time the originating endpoint attempts to detect the BONDING negotiation pattern from the answering endpoint before deciding the BONDING call has failed.

SYSTEM CONFIG > BONDING CONFIG > TXFA TIMER**Write security: 3; Read security: 5**

Specifies the length of time both endpoints attempt to detect the BONDING frame pattern when a call is connected before deciding the BONDING call has failed. When interoperating with other manufacturers' BONDING equipment, it may be necessary to change this time so that it matches **TXADD01**.

SYSTEM CONFIG > BONDING CONFIG > TXADD01 TIMER**Write security: 3; Read security: 5**

Specifies the length of time both endpoints wait for additional calls to be connected at the end of negotiation before deciding that the BONDING call has failed. The factory default setting is sufficient for most calls to connect, although when dialing overseas it may be necessary to lengthen this timer to allow for slower call routing.

SYSTEM CONFIG > BONDING CONFIG > TXDEQ TIMER**Write security: 3; Read security: 5**

Specifies the length of time both endpoints attempt to equalize the network delay between the bearer channels (B channels) before deciding the BONDING call has failed.

SYSTEM CONFIG > BONDING CONFIG > TANULL TIMER**Write security: 3; Read security: 5**

Specifies the length of time the answering endpoint attempts to detect the BONDING negotiation pattern from the originating endpoint before deciding the BONDING call has failed. It may be necessary to shorten this timer if the DTE equipment using the BONDING module also has timer constraints for completing non-BONDING parameter negotiation.

SYSTEM CONFIG > BONDING CONFIG > TCID TIMER**Write security: 3; Read security: 5**

Specifies the length of time both endpoints attempt to negotiate an agreeable value for bearer channels (B channels) and channel capacities before deciding the BONDING call has failed.

SYSTEM CONFIG > BONDING CONFIG > CALL STAGGER**Write security: 3; Read security: 5**

Specifies the amount of delay between placing calls for outgoing BONDING sessions. The following call stagger values are available: **NO STAGGER**, **500 MS**, **1 SEC**, and **2 SEC**

SYSTEM CONFIG > ALARM RELAY RESET**Write security: 3; Read security: 5**

Clears the Alarm Relay located on the rear panel of the ATLAS 550. Activating the software Alarm Relay Reset functions the same as manually pressing the **ACO** switch located on the ATLAS 550 front panel.

SYSTEM CONFIG > ALARM RELAY THRESHOLD**Write security: 3; Read security: 5**

Defines which threshold sets the Alarm Relay. These thresholds include **CRITICAL**, **MAJOR**, **MINOR**, **WARNING**, and **NORMAL**. If an alarm occurs that is greater than or equal to the threshold selected, the Alarm Relay will set. For example, if the threshold is set for **MAJOR**, then ALL **MAJOR** alarms and ALL **CRITICAL** alarms will set the Alarm Relay. There is one exception – setting the threshold to **NORMAL** will not set the Alarm Relay for **NORMAL** events. No **NORMAL** events set the Alarm Relay.

SYSTEM UTILITY

Use the **SYSTEM UTILITY** menu to view and set the system parameters shown in Figure 6.

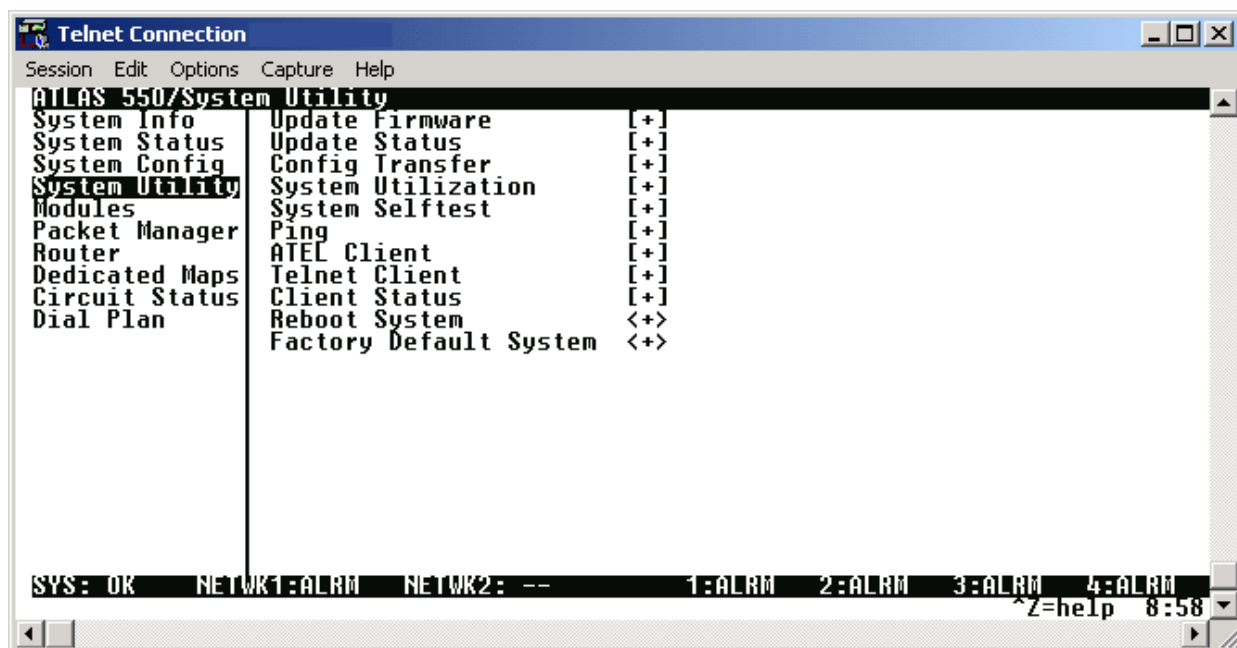

Figure 6. System Utility Menu

SYSTEM UTILITY > UPDATE FIRMWARE

Write security: 1; Read security: 5

Updates firmware when ATLAS 550 enhancements are released. Two transfer methods are available for use in updating any modules that contain Flash memory—including the ATLAS 550 system controller. The first transfer method uses the ATLAS 550 serial **CRAFT** or **CONTROL IN** (Chain) port of the system controller and XMODEM protocol. The second transfer method uses the ATLAS 550 built-in **ETHERNET** port of the system controller and Trivial File Transfer Protocol (TFTP). For more details on updating firmware, please refer to DLP-006 and DLP-007.

SYSTEM UTILITY > UPDATE FIRMWARE > MODULE SLOT

Write security: 1; Read security: 5

Displays the slot you selected for firmware updating. When this option first appears, **NONE SELECTED** displays. When you move the cursor to this field and press <Enter>, a dialog box opens, allowing you to select **SLOT 0** (ATLAS 550 system controller), **NTWK 1** or **2** (if an upgradeable network module is installed), **SLOT 1** through **SLOT 4** (if an upgradeable module is installed), **RSRC 1** through **4** (if an upgradeable resource module is installed), or **ALL MODULES OF A TYPE**.

SYSTEM UTILITY > UPDATE FIRMWARE > MODULE TYPE

Write security: 1; Read security: 5

Reflects the module type selected in **MODULE SLOT**. The selections only include upgradeable modules.

SYSTEM UTILITY > UPDATE FIRMWARE > TRANSFER METHOD**Write security: 1; Read security: 5**

Lists the two transfer methods for updating firmware after selecting a module slot: **XMODEM** and **TFTP**. **XMODEM** transfers files by connecting to a communications program that supports XMODEM uploads to the terminal interface. **TFTP** transfers files by specifying an appropriate server address and filename.

SYSTEM UTILITY > UPDATE FIRMWARE > TFTP SERVER IP ADDRESS**Write security: 1; Read security: 5**

(Available for TFTP transfers only.) Configures the IP address of the TFTP Server on which the update file resides. The ATLAS 550 uses this field to locate the network server on which the update file resides.

SYSTEM UTILITY > UPDATE FIRMWARE > TFTP SERVER FILENAME**Write security: 1; Read security: 5**

(Available for TFTP transfers only.) Identifies the name of the update file to retrieve from the TFTP Server. Enter the full path name and filename for the file.

SYSTEM UTILITY > UPDATE FIRMWARE > RESTART SCHEDULE**Write security: 1; Read security: 5**

Indicates when to restart the updated module to invoke the new software, after selecting a module slot. The two options include **RESTART IMMEDIATELY AFTER UPDATE** and **RESTART AT SPECIFIED DATE AND TIME**.

SYSTEM UTILITY > UPDATE FIRMWARE > RESTART SCHEDULE > RESTART IMMEDIATELY AFTER UPDATE**Write security: 1; Read security: 5**

Automatically restarts the module or unit (when **SLOT 0** is selected) immediately after the update is complete.

SYSTEM UTILITY > UPDATE FIRMWARE > RESTART SCHEDULE > RESTART AT SPECIFIED DATE AND TIME**Write security: 1; Read security: 5**

Lets you specify a date and time to automatically restart the updated module or unit (when **SLOT 0** is selected). When you select this option, a new field called **RESTART DATE AND TIME** displays below the current field.

RESTART DATE AND TIME**Write security: 1; Read security: 5**

(Available only when configured for RESTART AT SPECIFIED DATE AND TIME.) Defines the date and time to restart the system after updating. Enter the time using a 24-hour format (e.g., 23:25:30 for 11PM, 25 minutes, 30 seconds). Enter the date in mm-dd-yyyy format (e.g., 11-08-2000).

SYSTEM UTILITY > UPDATE FIRMWARE > CURRENT UPDATE STATUS**Read security: 5**

(Available for TFTP updates only.) Indicates progress or problems encountered during the current update process. The field displays **IDLE** if no update is in progress or when the update is successfully completed. At the end of a successful update, the contents of this field are copied into **PREVIOUS UPDATE STATUS**. For a detailed listing of these messages, please refer to DLP-006, *Updating the Firmware Using TFTP*.

If you are updating several modules at the same time (if **MODULE SLOT** is set to **ALL MODULES OF A TYPE**), this option displays [+], indicating that this field contains submenu items. The following submenus display:

SLT	Indicates the slot number.
TYPE	Defines the type of module for each slot.
CURRENT STATUS	Indicates the status of the current update.
PREVIOUS STATUS	Indicates the status of the previous update.
PREVIOUS TIME	Indicates the time of the previous update.

SYSTEM UTILITY > UPDATE FIRMWARE > PREVIOUS UPDATE STATUS**Read security: 5**

Displays the status of the previous update, after selecting a module slot. If a firmware update has not been attempted for a particular slot, this field reads **HAS NOT BEEN ATTEMPTED**. Following a successful update, the field reads **MODULE UPDATE COMPLETE**. If an update was unsuccessful, the appropriate error message displays.

SYSTEM UTILITY > UPDATE FIRMWARE > BEGIN FIRMWARE UPDATE**Write security: 1; Read security: 5**

Begins updating the firmware for the selected modules. To start this action, enter **Y** to begin or enter **N** to cancel. You can also cancel the operation after the update has begun. For **XMODEM** updates, cancel the process via the terminal emulation software (consult your documentation for the information on how to do this). For **TFTP** updates, you can cancel the process by selecting **CANCEL UPDATE** from this field.

SYSTEM UTILITY > UPDATE STATUS**Read security: 5**

Displays the status of the current firmware update. These fields are identical to those defined above in **CURRENT UPDATE STATUS**.

SYSTEM UTILITY > CONFIG TRANSFER**Write security: 3; Read security: 5**

Allows configuration files to be saved and shared among ATLAS 550 units. Two transfer methods are available for use when transferring configuration files to or from the unit. The first transfer method uses the ATLAS 550 serial **CRAFT** or **CONTROL IN** (Chain) port of the base unit and XMODEM protocol. The second transfer method uses the ATLAS 550 built-in 10/100BaseT **ETHERNET** port and Trivial File Transfer Protocol (TFTP).

To support these TFTP transfers, ADTRAN delivers a TFTP Server (as part of ADTRAN Utilities) on the ATLAS 550 documentation CD. You can install the ADTRAN Utilities software on any PC running Microsoft Windows, and use the TFTP server for TFTP transfers to/from the ATLAS 550.

Only one configuration transfer session (upload or download) can be active at a time. The TCP/IP parameters are not saved or overwritten as part of an ATLAS 550 unit's transferred configuration; therefore, identical configurations can be sent to multiple units. For complete details on configuration transfers to/from the ATLAS 550, please refer to DLP-008, DLP-009, DLP-010, and DLP-011.

SYSTEM UTILITY > CONFIG TRANSFER > TRANSFER METHOD

Write security: 3; Read security: 5

Displays the method used to transfer the configuration file to or from a server. Select **TFTP** to transfer files using the 10/100BaseT **ETHERNET** port, or select **XMODEM** to use the **CRAFT** or **CONTROL IN** (Chain) interfaces and a program such as Windows HyperTerminal.

SYSTEM UTILITY > CONFIG TRANSFER > TFTP SERVER IP ADDRESS

Write security: 3; Read security: 5

Specifies the IP address of the TFTP server. Get this address information from your System Administrator.

SYSTEM UTILITY > CONFIG TRANSFER > TFTP SERVER FILENAME

Write security: 3; Read security: 5

Defines the name of the configuration file that you transfer to or retrieve from the TFTP server. The default name is **at550.cfg**, but it is editable.

SYSTEM UTILITY > CONFIG TRANSFER > CURRENT TRANSFER STATUS

Read security: 5

Indicates the current status of the transfer.

SYSTEM UTILITY > CONFIG TRANSFER > PREVIOUS TRANSFER STATUS

Read security: 5

Indicates the status of the previous transfer.

SYSTEM UTILITY > CONFIG TRANSFER > LOAD AND USE CONFIG

Write security: 3; Read security: 5

Retrieves the configuration file specified in the **TFTP SERVER FILENAME** field from the server. To start this command, enter **Y**. To cancel this command, enter **N**.



If you execute this command, the ATLAS 550 retrieves the configuration file, reboots, then restarts using the new configuration.

SYSTEM UTILITY > CONFIG TRANSFER > SAVE CONFIG REMOTELY**Write security: 3; Read security: 5**

Saves the configuration file specified in **TFTP SERVER FILENAME** to the server identified in **TFTP SERVER IP ADDRESS**. To start this command, enter **Y**. To cancel this command, enter **N**.

SYSTEM UTILITY > SYSTEM UTILIZATION**Write security: 0; Read security: 0**

Displays statistics related to the ATLAS 550 internal operating system. Please check with ADTRAN Technical Support before attempting to use this menu.

SYSTEM UTILITY > SYSTEM SELFTEST**Write security: 3; Read security: 5**

Initiates a system self-test. The self-test consists of memory tests and data integrity tests for each installed module.



Self-tests disrupt data flow.

SYSTEM UTILITY > SYSTEM SELFTEST > SELFTEST**Write security: 3; Read security: 5**

Activates the self-test. To confirm self-test activation, press **Y**; to cancel the self-test press **N**.

SYSTEM UTILITY > SYSTEM SELFTEST > SELECTED TESTS**Write security: 3; Read security: 5**

Allows the user to select a system-wide test or an individual card test. Choose from **ALL TESTS**, **SLOT: 0** **SYS CTRL**, or any other installed option/network/resource module.

SYSTEM UTILITY > SYSTEM SELFTEST > CURRENT TEST STATUS**Write security: 3; Read security: 5**

Displays which part of self-test is currently active. See *System Utility > System Selftest > View Selftest Log* for details on individual tests.

SYSTEM UTILITY > SYSTEM SELFTEST > CURRENT SLOT/PORT**Write security: 3; Read security: 5**

Displays which slot and port is currently being tested.

SYSTEM UTILITY > SYSTEM SELFTEST > VIEW SELFTEST LOG**Read security: 5**

Displays time-stamped log of the tests conducted and the Pass/Fail results. Self-tests verify data integrity and processor control to each port. Each port is looped back and a data pattern is sent and tested.

The result of the self-test on each installed port is listed with Pass/Fail results. Figure 7 depicts a typical test log. The fields included in the log are described below the figure.

ATLAS 550/System Utility/System Selftest/View Selftest Log						
Idx	Time	Sl	Pt	Event	Result	
1	20:45:10 11/16	S0	0	Test End	Passed	
2	20:45:10 11/16	S0	0	Card Tst	Passed	
3	20:45:10 11/16	S0	4	HDLC	Passed	
4	20:45:07 11/16	S0	0	DRAM Tst	Passed	
5	20:44:56 11/16	S0	0	TDM RAM Tst	Passed	
6	20:44:56 11/16	S0	0	NV Batt Tst	Passed	
7	20:44:56 11/16	S0	0	RTC RAM Tst	Passed	
8	20:44:56 11/16	S0	0	DSP RAM Tst	Passed	
9	20:44:56 11/16	S0	0	Bootrom Tst	Passed	
10	20:44:55 11/16	S0	0	Flash Tst	Passed	
11	20:44:51 11/16	S0	0	Test Start		

SYS: OK NETWK1:ALRM NETWK2: -- 1:ALRM 2:ALRM 3: -- 4: --
 ^Z=help 20:45

Figure 7. View Selftest Log

The self-test log includes the following fields:

- IDX** Index number of the log.
- TIME** Time and date of the log entry.
- SL** ATLAS 550 slot number.
- PT** ATLAS 550 port number.
- EVENT** Event description.
- RESULT** Show **PASS/FAIL** results.

The tests associated with the system controller are shown in Table 2.

Table 2. ATLAS 550 System Controller Self-Test Log

THIS EVENT...	LOGS THIS RESULT...
Flash	Flash memory checksum verified
BootRom	Boot ROM checksum verified
DSP RAM	Memory associated with the Digital Signal Processor
RTC RAM	Memory associated with the real time clock
NV Batt	Tests the battery associated with non-volatile memory
TDM RAM	Memory associated with mapping TDM bandwidth
DRAM	Dynamic RAM used for program execution
HDLC	The High-Level Data Link Controllers
Card Tst	Tests the data path for each slot in the system with an installed module.

SYSTEM UTILITY > SYSTEM SELFTEST > CLEAR SELFTEST LOG

Write security: 3; Read security: 5

Clears the self-test log.



Self-test log messages are not available once the log is cleared.

SYSTEM UTILITY > PING

Write security: 5; Read security: 5

Allows you to send pings (ICMP echo requests) to devices accessible via the **ETHERNET** interface.



Only one ping session can be active at a time.

SYSTEM UTILITY > PING > IP ADDRESS

Write security: 5; Read security: 5

Specifies the IP address to ping.

SYSTEM UTILITY > PING > COUNT

Write security: 5; Read security: 5

Specifies the number of pings to send. The default value is 4, and the maximum value is 99.

SYSTEM UTILITY > PING > SIZE (BYTES)

Write security: 5; Read security: 5

Specifies the size in bytes of the data portion of the ping request. The default value is 64 bytes, and the maximum size is 1024 bytes.

SYSTEM UTILITY > PING > TIMEOUT (MS)

Write security: 5; Read security: 5

Specifies the time in milliseconds to wait for the ping reply before timing out. The default timeout is 3 seconds (3000), and the maximum timeout value is 10 seconds (10,000).

SYSTEM UTILITY > PING > ROUND TRIP MIN

Read security: 5

Displays the minimum round trip time of the ping request/reply of the current set of pings.

SYSTEM UTILITY > PING > ROUND TRIP AVG

Read security: 5

Displays the average round trip time of the ping request/reply of the current set of pings.

SYSTEM UTILITY > PING > ROUND TRIP MAX**Read security: 5**

Displays the maximum round trip time of the ping request/reply of the current set of pings.

SYSTEM UTILITY > PING > TX STATS**Read security: 5**

Displays the number of ping requests transmitted (*n* **TXED**), the number of ping replies received (*n* **RXED**), and the number of ping requests that were lost (*n* **LOST**).

SYSTEM UTILITY > PING > RESET STATS**Write security: 5; Read security: 5**

Resets all ping statistics to zero. If the ping client is active, this menu will stop it.

SYSTEM UTILITY > PING > START/STOP**Write security: 5; Read security: 5**

If the ping client is currently idle, this menu sends pings to the specified address. If the ping client is active, the menu either starts or stops sending pings.

SYSTEM UTILITY > ATEL CLIENT**Write security: 5; Read security: 5**

Allows a user to remotely configure ADTRAN TSUs using ADLP over the inband management channel on a V.35 port. This feature only allows for remote sessions through the ATLAS 550 to the TSUs – not vice versa.

SYSTEM UTILITY > ATEL CLIENT > ATEL ADDRESS**Write security: 5; Read security: 5**

Defines the ADLP address (Unit ID) assigned to the remote unit you are trying to connect to. The valid range is 2 to 65520.

SYSTEM UTILITY > ATEL CLIENT > CONNECT**Write security: 5; Read security: 5**

Activator used to start an ATEL client session to the remote unit configured in the **ATEL ADDRESS** field.

SYSTEM UTILITY > TELNET CLIENT**Write security: 5; Read security: 5**

Allows a user to open a Telnet session to any device listed in the ATLAS 550 route table.

SYSTEM UTILITY > TELNET CLIENT > ADDRESS**Write security: 5; Read security: 5**

Defines the IP address assigned to the remote unit you are trying to connect to.

SYSTEM UTILITY > TELNET CLIENT > ESCAPE CHAR**Write security: 5; Read security: 5**

Defines the Telnet client escape character. Typing the combination characters will close the active telnet session to the remote unit specified in the **ADDRESS** field.

Option	Keystroke
^]	<Ctrl> +]
^ \	<Ctrl> + \
^ [<Ctrl> + [
^ ^	<Ctrl> + <Shift> + 6
^ _	<Ctrl> + <Shift> + -

SYSTEM UTILITY > TELNET CLIENT > PORT**Write security: 5; Read security: 5**

Defines the IP port used in the remote login session. Default (for Telnet) is **23**.

SYSTEM UTILITY > TELNET CLIENT > CONNECT**Write security: 5; Read security: 5**

Activator used to start a Telnet session to the remote unit configured in the **ADDRESS** field.

SYSTEM UTILITY > CLIENT STATUS**Write security: 5; Read security: 5**

Displays status from current Telnet client sessions.

SYSTEM UTILITY > CLIENT STATUS > USER NAME

Displays the username (from access passwords list) that has an active Telnet client session.

SYSTEM UTILITY > CLIENT STATUS > SESSION ID

Displays the remote unit's IP address followed by the IP port of an active Telnet client session (in the format **IP.IP.IP.IP:PORT**).

SYSTEM UTILITY > REBOOT SYSTEM**Write security: 0; Read security: 0**

Reboots the ATLAS 550 system. When you select this command, the following message displays:

**** WARNING ** This will reboot the entire system and service will be interrupted!**

Press **Y** to reboot the system or **N** to cancel the command.

SYSTEM UTILITY > FACTORY DEFAULT SYSTEM**Write security: 0; Read security: 0**

Resets the entire system to the factory default settings. To reset the system, press **Y**. To cancel this command, press **N**. When you select this command, the following message displays:

WARNING

This will delete all configuration settings. ADTRAN recommends making a backup copy of the configuration before defaulting the system.

MODULES

Write security: 3; Read security: 5

The **MODULES** menu provides status information and menu options that allow you to configure and control the installed option modules as well as the network ports (see Figure 8).

The screenshot shows a Telnet connection window titled "Telnet Connection" with a menu on the left and a table of modules on the right. The table has columns for Slot, Type, Menu, Alarm, Test, State, Status, and Rev. The status bar at the bottom shows "SYS: OK" and "NETWK1:ALRM" through "NETWK4:ALRM".

	SlT	Type	Menu	Alarm	Test	State	Status	Rev
System Info	SlT0	Sys Ctrl	[+]	OK	OFF	ONLINE	Online	D
System Status	Ntw1	T1/PRI-1	[+]	[OK]	[OFF]	ONLINE	Online	-
System Config	Ntw2	EMPTY				ONLINE	empty	-
System Utility	SlT1	FXO-8	[+]	OK	[OFF]	ONLINE	Online	-
Modules	Rsc1	UCOM	[+]	[OK]	OFF	ONLINE	Online	-
Packet Manager	SlT2	U35Nx-2	[+]	[OK]	[OFF]	ONLINE	Online	-
Router	Rsc2	IMUX	[+]	OK	OFF	ONLINE	Online	-
Dedicated Maps	SlT3	FXS-8	[+]	OK	[OFF]	ONLINE	Online	-
Circuit Status	Rsc3	EMPTY				ONLINE	empty	-
Dial Plan	SlT4	U-BRI-4	[+]	[OK]	[OFF]	ONLINE	Online	-
	Rsc4	EMPTY				ONLINE	empty	-

Module menus

Figure 8. Modules Menu



If you install a module in a slot, then want to install a different type of module in the slot, you must set this field to **EMPTY** before selecting another module type.



If a module is installed, the module type automatically shows the name of the installed module, and it cannot be set to any other option.

MODULES > SLT

Read security: 5

Identifies the slot number. Slot 0 refers to the ATLAS 550 Base Unit.

The ATLAS 550 has three types of slots: network slots, option module slots, and resource module slots. The two network slots are designated **Ntw1** and **Ntw2**. The four option module slots are designated **SlT1** through **4**, and the four resource module slots are designated **Rsc1** through **4**. Resource modules are installed onto any option module, but not onto network modules.

MODULES > TYPE

Write security: 3; Read security: 5

Displays the type of module actually installed in the slot or the type of module you plan to install in the slot. The ATLAS 550 controller automatically detects the type of module installed in each slot, and the **TYPE** field automatically defaults to the installed module type. You can also use this field to preconfigure a unit before actually installing modules by specifying the module that you want to install in each slot.

To use this option, navigate to the field you want to edit and press <Enter>. For empty slots, a list of all the available module types displays. Select the one you want and it displays in the **TYPE** field. If this field is already configured with a module, you can only set this field to **EMPTY**. To change from one module type to another, you must first set the field to **EMPTY**.

MODULES > MENU

Read security: 5

Displays additional status and configuration menus for the ATLAS 550 controller or selected module. To access the submenus for this item, use the arrow keys to scroll to the **MENU** column for the module you want to edit, and press <Enter>. For detailed information on each submenu item for a particular module, refer to the modules menus discussion for the appropriate option or resource module.

MODULES > ALARM

Read security: 5

Displays whether there is an alarm condition on the ATLAS 550 controller or selected module. Press <Enter> to access the **ALARM** menu. For detailed information on each submenu item for a particular module, refer to the following sections for the appropriate option or resource module alarm menu discussions.

MODULES > TEST

Read security: 5

Displays whether the ATLAS 550 controller or selected module is executing a test. Press <Enter> to access the **TEST** menu. This option will allow you to set up and initiate tests. You may also access this menu through the **MENU** submenu on this screen. For detailed information on each submenu item for a particular module, refer to the **TEST** sections for the appropriate option or resource module test menu discussions.

MODULES > STATE

Read security: 5

Displays whether the ATLAS 550 controller or selected module is online or offline. Even though a module is physically installed, it must be marked **ONLINE** for it to be considered an available resource. This parameter allows an installed module to be marked **OFFLINE**, which may be useful in system troubleshooting. If you choose **OFFLINE**, the module will not be in alarm condition, but will display **OFFLINE**. While in **OFFLINE**, the **STATUS** LED will flash green. A module will automatically change to the **ONLINE** state when installed.

MODULES > STATUS**Read security: 5**

Displays status information on the installed modules as follows:

ONLINE	The module is enabled and is responding to the system controller's status polls. This is the normal response of the system.
NO RESPONSE	The module is enabled but is not responding to the system controller's status polls. This response indicates a problem in the system or that the module is not properly installed.
EMPTY	The system controller has not detected the presence of a module in the system, nor has a module been manually enabled for this option slot.
OFFLINE	The module is installed but has been taken offline by a user. The module is still responding to controller polls.
OFFLINE/NO RESPONSE	The module is installed but has been taken offline by a user. The module is not responding to controller polls.
NOT SUPPORTED	The module is not supported by the current system configuration.

MODULES > REV**Read security: 5**

Displays the hardware revision of the ATLAS 550 and other installed modules.

MODULES MENU (T1/PRI NETWORK INTERFACE MODULE)

This section provides detailed information on the **MODULES** menu and submenus for the T1/PRI Network Interface Module. The ATLAS 550 system controller automatically detects the presence of the T1/PRI Network Interface Module when it is installed in the system (listed as **T1/PRI-1**). To see the menus for the T1/PRI Network Interface Module via the terminal menu, use the arrow keys to scroll to the **MODULES** menu and press <Enter> to access the module choices. Refer to the *T1/PRI Network Interface Module Quick Start Guide* for a menu tree containing a complete listing of menus.

MODULES (T1/PRI-1) > INFO**Read security: 5**

Displays general information about the T1/PRI Network Interface Module as follows:

MODULES (T1/PRI-1) > INFO > PART NUMBER**Read security: 5**

Displays the part number of the T1/PRI Network Interface Module.

MODULES (T1/PRI-1) > INFO > SERIAL NUMBER**Read security: 5**

Displays the module's serial number.

MODULES (T1/PRI-1) > INFO > ASSEMBLY REVISION**Read security: 5**

Displays the assembly revision of the module.

MODULES (T1/PRI-1) > ALARM STATUS**Read security: 5**

Displays the current T1 alarm status.

MODULES (T1/PRI-1) > ALARM STATUS > PRT**Read security: 5**

Indicates the port number.

MODULES (T1/PRI-1) > ALARM STATUS > ALARMS**Read security: 5**

Displays an alarm condition on the ATLAS 550 unit. Press <Enter> to access this menu item.

LOS	Indicates a loss of signal detected on port interface.
RED	Indicates inability to frame data received on the port. Alternately referred to as Out of Frame (OOF).
YELLOW	Receiving remote alarm (RAI) on port.
BLUE	Receiving unframed all ones from the port Alarm Indicator Signal (AIS).
DS0 ALARM	Displays per-DS0 alarm status; that is, at least one DS0 channel is in alarm if an asterisk (*) appears. These alarms usually indicate the failure to receive the protocol that has been configured for the DS0.
RX LEVEL (RECEIVE LEVEL)	Indicates the strength of the signal (in dB) received on the port.

MODULES (T1/PRI-1) > DS0 STATUS**Read security: 5**

The DS0 status indicates usage on a DS0 basis. These options are read-only:

-	Unallocated
*	Inactive
+	Signaling mismatch
A	Active B Channel
D	Active D Channel
M	Maintenance
N	Dedicated (nailed)
O	Off hook - originate (RBS)
R	Ringing (RBS); Restart (ISDN)
W	Waiting dial tone

MODULES (T1/PRI-1) > DS0 ALARMS**Read security: 5**

Displays per-DS0 alarm status. These alarms usually indicate the failure to receive the protocol that has been configured for the DS0.

-	No Alarm DS0
D	D Channel Alarm (ISDN)
F	Frame Alarm (packet)
T	TBOP Alarm (packet)
P	PPP Alarm (packet)

MODULES (T1/PRI-1) > SIG STATUS**Read security: 5**

Read-only field that indicates signaling of all 24 DS0s. The A/B bits for Rx (receive) and Tx (transmit) DS0s are shown. Dashes display for those DS0s where robbed bit signaling (RBS) is not being transferred by the ATLAS 550.

MODULES (T1/PRI-1) > PERFORMANCE CURRENT**Write security:3; Read security: 5**

The performance fields (either **CURRENT**, **15-MINUTE** total, or **24-HOUR** total) provide status on key performance measures as specified in ANSI T1.403 and AT&T TR54016 for the T1/PRI port. Except for **CLR**, these fields are all read-only. The monitored parameters include the following:

PRT	Displays the port number
CLR	Clears performance information for the selected port
ES	Errored Second (ES) is a second with one or more error events OR one or more Out Of Frame events OR one or more Controlled Slips
BES	Bursty Errored Second (BES) is a second with more than one, but less than 320 error events
SES	Severely Errored Second (SES) is a second with 320 or more error events OR one or more Out Of Frame events
SEFS	Severely Errored Frame Second is a second that contains four consecutive errored framing patterns.
LOFC	Loss of Frame Count is a count of seconds in which a valid framing pattern could not be obtained.
CSS	Controlled Slip Second
UAS	Unavailable Second
LCV	Line Code Violation
PCV	Path Code Violation
LES	Line Errored Second

MODULES (T1/PRI-1) > PERFORMANCE 15MIN**Write security:3; Read security: 5**

Stores the performance data for the previous 15-minute window. Refer to *Modules (T1/PRI-1) > Performance Current* for a detailed description of these fields.

MODULES (T1/PRI-1) > PERFORMANCE 24HR**Write security:3; Read security: 5**

Stores the performance data for the previous 24-hour window. Refer to *Modules (T1/PRI-1) > Performance Current* for a detailed description of these fields.

MODULES (T1/PRI-1) > CONFIGURATION**Write security: 3; Read security: 5**

All of the following configurable parameters apply to whether the port is connected to a Primary Rate ISDN circuit or a channelized T1 circuit.

MODULES (T1/PRI-1) > CONFIGURATION > PRT**Read security: 5**

Displays the port number.

MODULES (T1/PRI-1) > CONFIGURATION > PORT NAME**Write security: 3; Read security: 5**

Accepts any alpha-numeric name up to 16 characters long, to uniquely identify each port on the ATLAS 550.

MODULES (T1/PRI-1) > CONFIGURATION > FRAME**Write security: 2; Read security: 5**

This field must be set to match the frame format of the circuit to which it is connected, available from the network supplier. Choose either **D4** or **ESF**.

MODULES (T1/PRI-1) > CONFIGURATION > CODE**Write security: 2; Read security: 5**

Set this field to match the line code of the circuit to which it is connected (this information is available from the network supplier). Choose either **AMI** (Alternate Mark Inversion) or **B8ZS** (Bipolar Eight Zero Substitution).

MODULES (T1/PRI-1) > CONFIGURATION > TX YEL**Write security: 3; Read security: 5**

Controls the transmission of yellow alarms. Choose either **ON** or **OFF**.

MODULES (T1/PRI-1) > CONFIGURATION > TX PRM**Write security: 3; Read security: 5**

Controls the sending of performance report messaging (PRM) data on the facility data link (FDL). The PRM data continues to be collected even if **XMIT PRM** is turned off (possible only with ESF format). Choose either **ON** or **OFF**.

MODULES (T1/PRI-1) > CONFIGURATION > LBO**Write security: 2; Read security: 5**

Selects the Line Build Out (LBO) for the network interface. When connecting an ATLAS 550 port to a DSX-1 interface, this parameter is typically set to match the distance (in feet) between the ATLAS 550 and the device with which it is connecting. When you select this item, a list of choices displays (**0 dB, -7.5 dB, -15 dB, -22 dB, 266 FT, 399 FT, 533 FT, 655 FT**). Select the appropriate option.

MODULES (T1/PRI-1) > CONFIGURATION > LB ACCEPT**Write security: 3; Read security: 5**

Sets unit to accept or reject the in-band loop up and loop down codes as defined in ANSI T1.403. This is a line loopback. Choose either **ACCEPT** or **IGNORE**.

MODULES (T1/PRI-1) > CONFIGURATION > PULSE DENSITY**Write security: 3; Read security: 5**

Choose either **ON** or **OFF**. When **ON**, Pulse Density Enforcer causes the ATLAS 550 to monitor for ones (1s) density violations and insert a one (1) when needed to maintain ones at 12.5%. This data insertion will cause data errors.

MODULES (T1/PRI-1) > CONFIGURATION > ADLP OVER FDL**Write security: ADTRAN Use Only; Read security: 5**

The ADTRAN Data Link Protocol (ADLP) provides a communications link between ADTRAN equipment over point-to-point or multidrop connections that can be used for configuring and monitoring remote ADTRAN devices. Choose **ENABLE** to activate the ADLP over the FDL for the DS1 interface.

MODULES (T1/PRI-1) > TEST**Write security: 5; Read security: 5**

These options initiate different types of tests and display test results.

MODULES (T1/PRI-1) > TEST > PRT**Read security: 5**

Displays the port number.

MODULES (T1/PRI-1) > TEST > LOC LB**Write security: 4; Read security: 5**

Initiates a loopback on near-end (local) port (see Figure 9). The following options are available:

LINE	Metallic loopback
PAYLD	Payload loopback - framing and clocking are regenerated

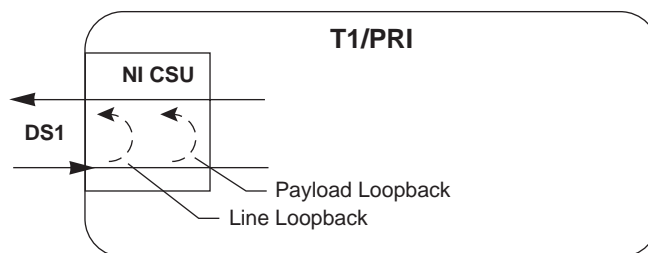

Figure 9. T1/PRI Loopback Test Diagram

MODULES (T1/PRI-1) > TEST > REMOTE LB**Write security: 4; Read security: 5**

Sends loopback code to remote CSU. The following options are available:

Selection	Framing	Description
AT&T INBAND LINE	ESF/D4	Full 1.544 Mbps loopback of the signal received from the network (metallic loopback).
ANSI FDL LINE	ESF	Full 1.544 Mbps loopback of the signal received from the network. Initiated through loopback activation transmission over the facility data link (FDL).
ANSI FDL PYLD	ESF	1.536 Mbps loopback of the payload data received from the network maintaining bit-sequence integrity for the information bits by synchronizing (regenerating) the timing. Initiated through loopback activation transmission over the facility datalink (FDL).
INBAND NIU	ESF/D4	Full 1.544 Mbps loopback of the signal received from the network after passing through the T1 framer of the remote unit.

MODULES (T1/PRI-1) > TEST > PATTERN**Write security: 4; Read security: 5**

Test pattern to be transmitted out the port. The following options are available:

ALL ONES	Framed ones
ALL ZEROS	Framed zeros
QRSS	Pseudo-random pattern with suppression of excess zeros

MODULES (T1/PRI-1) > TEST > QRSS/RLB RESULTS**Write security: 3; Read security: 5**

Displays current status of T1 tests including information regarding loopbacks and test patterns. When displaying test pattern status, the display string is composed of pattern sync status and errored seconds.

NONE	No sync.
LOS	Sync has been lost.
SYNC	Pattern is synchronized.
ES	Number of seconds with at least one bit error.

MODULES (T1/PRI-1) > TEST > CLR**Write security: 3; Read security: 3**

Clears error counters on test pattern results menu.

MODULES (T1/PRI-1) > TEST > INJ**Write security: 3; Read security: 3**

Injects errors into transmitted test pattern.

MODULES MENU (E1/PRA NETWORK INTERFACE MODULE)

This section provides detailed information on the **MODULES** menu and submenus for the E1/PRA Network Interface Module. The ATLAS 550 system controller automatically detects the presence of the E1/PRA Network Interface Module when it is installed in the system (listed as **E1/PRA-1**). To see the menus for the E1/PRA Network Interface Module via the terminal menu, use the arrow keys to scroll to the **MODULES** menu and press <Enter> to access the module choices. Refer to the *E1/PRA Network Interface Module Quick Start Guide* for a menu tree containing a complete listing of menus.

MODULES (E1/PRA-1) > INFO

Read security: 5

Displays general information about the E1/PRA Network Interface Module.

MODULES (E1/PRA-1) > INFO > PART NUMBER

Read security: 5

Displays the part number of the E1/PRA Network Interface Module.

MODULES (E1/PRA-1) > INFO > SERIAL NUMBER

Read security: 5

Displays the module's serial number.

MODULES (E1/PRA-1) > INFO > ASSEMBLY REVISION

Read security: 5

Displays the assembly revision of the module.

MODULES (E1/PRA-1) > INFO > E1 FRAMER REVISION

Read security: 5

Displays the E1 framer hardware revision.

MODULES (E1/PRA-1) > ALARM STATUS

Read security: 5

Displays the current E1 alarm status.

MODULES (E1/PRA-1) > PRT

Read security: 5

Indicates the port number. The E1/PRA Network Interface Module is a single-port device.

MODULES (E1/PRA-1) > ALARMS**Read security: 5**

Displays the alarm type, as listed below.

LOS	(Loss of Signal) No signal detected on port interface.
LOF	(Loss of Framing) The receiver is unable to synchronize to the FAS framing pattern of the received signal.
LOMF	(Loss of Multi-frame) The receiver is unable to synchronize to the TS15 multi-frame pattern of the received signal.
CRC4	(Loss of CRC-4 Framing) The receiver is unable to synchronize to the CRC-4 frame pattern of the received signal.
AIS	(Alarm Indication Signal) An upstream failure has been detected and all ones are being received.
REM	(Remote Frame Alarm) Loss of frame alarm being received from far end.
REMMF	(Remote Multi-Frame Alarm) Loss of multi-frame alarm being received from far end.

MODULES (E1/PRA-1) > TS0 ALARMS**Read security: 5**

Displays per-TS0 alarm status. These alarms usually indicate the failure to receive the protocol that has been configured for the TS0.

-	No Alarm TS0
D	D Channel Alarm (ISDN)
F	Frame Alarm (packet)
T	TBOP Alarm (packet)
P	PPP Alarm (packet)

MODULES (E1/PRA-1) > TS0 STATUS**Read security: 5**

The TS0 status indicates usage on a TS0 basis for each port. These options are read-only:

•	Idle	N	Dedicated (nailed) TS0
-	Inactive	O	Off hook detected
A	Active call on this TS0	R	Ringing detected
D	Active D Channel TS0	S	Signaling
M	Maintenance TS0		

MODULES (E1/PRA-1) > SIG STATUS**Read security: 5**

Displays the state of the A/B/C/D signaling bits for the E1/PRA Network Interface Module. Dashes indicate TS0s where signaling is not being transferred by the ATLAS 550.

MODULES (E1/PRA-1) > PERFORMANCE CURRENT**Write security:5; Read security: 5**

The performance fields (either current, 15-minute total, or 24-hour total) provide status on key performance measures as specified in G.821 and RFC 1406 for the E1/PRA port as follows:

PRT	Displays the port number
CLR	Clears performance information for the selected port
ES	Errored Second (ES) is a second with one or more error events OR one or more Out Of Frame events OR one or more Controlled Slips
BES	Bursty Errored Second (BES) is a second with more than one, but less than 320 error events
SES	Severely Errored Second (SES) is a second with 320 or more error events OR one or more Out Of Frame events
UAS	Unavailable Second
CSS	Controlled Slip Second
SEFS	Severely Errored Frame Second is a second that contains four consecutive errored framing patterns
DM	Degraded Minutes is the number of minutes with a bit error rate of 10^{-6} or greater
Lcv	Line Code Violation
Pcv	Path Code Violation
LES	Line Errored Second
LOFC	Loss of Frame Count is a count of seconds in which a valid framing pattern could not be obtained

MODULES ((E1/PRA-1) > PERFORMANCE 15MIN**Write security:5; Read security: 5**

Stores the performance data for the previous 15-minute window. Refer to *Modules (E1/PRA-1) > Performance Current* for a detailed description of these fields.

MODULES (E1/PRA-1) > PERFORMANCE 24HR**Write security:5; Read security: 5**

Stores the performance data for the previous 24-hour window. Refer to *Modules (E1/PRA-1) > Performance Current* for a detailed description of these fields.

MODULES (E1/PRA-1) > CONFIGURATION**Write security:5; Read security: 5**

All of the following configurable parameters apply whether the port is connected to a Primary Rate Access circuit or a channelized E1 circuit.

MODULES (E1/PRA-1) > CONFIGURATION > PRT**Write security:3; Read security: 5**

Displays the port number.

MODULES (E1/PRA-1) > CONFIGURATION > PORT NAME**Write security: 3; Read security: 5**

Accepts any alpha-numeric name up to 16 characters long, to uniquely identify the E1/PRA port.

MODULES (E1/PRA-1) > CONFIGURATION > NFAS**Write security: 3; Read security: 5**

If enabled, the network interface receiver requires the NFAS word (TS0 0 in odd frames) and the FAS word (TS0 0 in even frames) for frame sync. When disabled, only the FAS word is needed for frame sync.

MODULES (E1/PRA-1) > CONFIGURATION > TS16 MF**Write security: 3; Read security: 5**

If enabled, the receiver requires MFAS word in TS16 to achieve sync (CAS signaling). The transmitter outputs MFAS word in TS16 (CCS signaling).

MODULES (E1/PRA-1) > CONFIGURATION > CRC-4**Write security: 3; Read security: 5**

Transmits the CRC-4 checksum bits in the outgoing E1 data stream, when enabled. Also, checks the received signal for errors.

MODULES (E1/PRA-1) > CONFIGURATION > AUTO ALARM**Write security: 3; Read security: 5**

Transmits a remote alarm when framing is lost (when Red Alarm Generation is on), and transmits an AIS alarm when all ones are received (when RCM AIS Generation is on).

MODULES (E1/PRA-1) > CONFIGURATION > CODE**Write security: 3; Read security: 5**

Allows selection of line coding. **HDB3** is normally the only coding method used on public networks. **AMI** may be selected for testing purposes.

MODULES (E1/PRA-1) > CONFIGURATION > TS0 SPARE**Write security: 3; Read security: 5**

TS0 bits Sa4 through Sa8 in frames not containing the Frame Alignment Signal may be used in specific applications, but should be set to 1s when crossing an international border. Enter a decimal number whose 5 LSB (least significant bits) are to be used for all Sa4 and Sa8 bits. Refer to CCITT G.704 for more

information.

MODULES (E1/PRA-1) > CONFIGURATION > TS16 SPARE

Write security: 3; Read security: 5

TS16 in CAS frame 0 contains 3 spare bits: 0000XYXX where ‘X’ marks a spare bit and ‘Y’ marks an alarm indications to the remote end. Enter a decimal number whose masked 4 LSB (least significant bits) are inserted into TS0 in CAS frame 0. Refer to CCITT G.704 for more information.

MODULES (E1/PRA-1) > CONFIGURATION > INTL BIT

Write security: 3; Read security: 5

Bit 0 in all non-CRC4 frames is reserved for international use. They may be used nationally if the path does not cross an international border. If not specifically used, the bits should be set to ‘1’ on paths crossing a border. Enter the international bit value of 0 or 1. Refer to CCITT G.704 for more information.

MODULES (E1/PRA-1) > CONFIGURATION > LINE BUILD OUT

Write security: 3; Read security: 5

Sets the line build out for the E1 interface to either **75 Ω (BALANCED or UNBALANCED)** or **120 Ω (BALANCED or UNBALANCED)**.

MODULES (E1/PRA-1) > TEST

Write security: 5; Read security: 5

These options initiate different types of tests and display test results.

MODULES (E1/PRA-1) > TEST > PRT

Write security: 4; Read security: 5

Displays the port number.

MODULES (E1/PRA-1) > TEST > LOC LB

Write security: 4; Read security: 5

Causes loopback on near-end (local) port (see Figure 10). The following options are available:

NONE	No loopback active
LINE	Metallic loopback

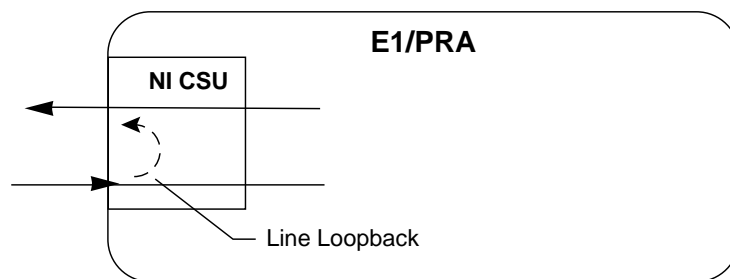

Figure 10. E1/PRA Network Loopback Test Diagram

MODULES (E1/PRA-1) > TEST > PATTERN

Write security: 4; Read security: 5

Test pattern to be transmitted out the port. The following options are available:

ALL ONES	Framed ones
ALL ZEROS	Framed zeros
QRSS	Pseudo-random pattern with suppression of excess zeros

MODULES (E1/PRA-1) > TEST > QRSS RESULTS

Write security: 4; Read security: 5

Test pattern results that indicate sync and errors of received data pattern.

MODULES (E1/PRA-1) > TEST > CLR

Write security: 4; Read security: 5

Clears test results on **QRSS RESULTS** field.

MODULES (E1/PRA-1) > TEST > INJ

Write security: 4; Read security: 5

Injects errors into transmitted test pattern. Return receipt of the errors is displayed in the **QRSS RESULTS** field.

MODULES MENU (MODEM MANAGEMENT NETWORK MODULE)

The ATLAS 550 system controller automatically detects the presence of the Modem Management Network Module when it is installed in the system (listed as **MODMMGMT**). To see the menus for the Modem Management Network Module via the terminal menu, use the arrow keys to scroll to the **MODULES** menu and press <Enter> to access the module choices. Refer to the *Modem Management Network Module Quick Start Guide* for a menu tree containing a complete listing of menus.

MODULES (MODMMGMT) > INFO**Read security: 5**

Provides information about the module part number, serial number, and assembly revision.

MODULES (MODMMGMT) > INFO > PART NUMBER**Read security: 5**

Displays the part number of the module.

MODULES (MODMMGMT) > INFO > SERIAL NUMBER**Read security: 5**

Displays the serial number of the module.

MODULES (MODMMGMT) > INFO > ASSEMBLY REVISION**Read security: 5**

Displays the assembly revision.

MODULES (MODMMGMT) > STATUS**Read security: 5**

Provides status information about the analog network interface.

MODULES (MODMMGMT) > STATUS > SIGNAL LEADS**Read security: 5**

Displays the state of the analog port signals including **RTS** (Request To Send), **CTS** (Clear To Send), **DCD** (Data Carrier Detect), and **DTR** (Data Transmit Ready).

MODULES (MODMMGMT) > STATUS > TX BYTES**Read security: 5**

Displays the number of bytes transmitted from the analog port to the network.

MODULES (MODMMGMT) > STATUS > RX BYTES**Read security: 5**

Displays the number of bytes received by the analog port from the network.

MODULES (MODMMGMT) > STATUS > OVERRUN ERRS**Read security: 5**

Displays the number of overrun errors received by the analog port.

MODULES (MODMMGMT) > STATUS > FRAMING ERRS**Read security: 5**

Displays the number of framing errors received by the analog port.

MODULES (MODMMGMT) > STATUS > CLEAR COUNTERS

Write security: 5; Read security: 5

Clears the analog port statistics. Press <Enter> to activate this command.

MODULES (MODMMGMT) > STATUS > HANGUP MODEM

Write security: 5; Read security: 5

Disconnects the active dialup modem session. Press <Enter> to activate this command.

MODULES (MODMMGMT) > STATUS > CONNECT RATE

Read security: 5

Displays the connection rate for the active dialup modem session.

MODULES (MODMMGMT) > CONFIGURATION

Write security: 3; Read security: 5

All of the following configurable parameters apply to the analog port located on the Modem Management Network Module.

MODULES (MODMMGMT) > CONFIGURATION > PORT NAME

Write security: 2; Read security: 5

Accepts any alpha-numeric name up to 16 characters long, to uniquely identify the analog port on the Modem Management Network Module.

MODULES (MODMMGMT) > CONFIGURATION > RINGS TO ANSWER

Write security: 2; Read security: 5

Configures the number of rings before the Auto Answer functionality is invoked.

MODULES (MODMMGMT) > TEST

Write security: 5; Read security: 5

Provides testing capabilities for the internal modem.

MODULES (MODMMGMT) > TEST > DETECT DIAL TONE

Write security: 5; Read security: 5

Causes the internal modem to go off-hook to detect dial tone on the analog line.

MODULES (MODMMGMT) > TEST > DIAL TONE DETECTED

Read security: 5

Displays the results of the last **DETECT DIAL TONE** test.

MODULES MENU (BRI DBU NETWORK INTERFACE MODULE)

The ATLAS 550 system controller automatically detects the presence of the Basic Rate ISDN (BRI) DBU

Network Interface Module when it is installed in the system (listed as **DBU**). To see the menus for the BRI DBU Network Interface Module via the terminal menu, use the arrow keys to scroll to the **MODULES** menu and press <Enter> to access the module choices. Refer to the *BRI DBU Network Interface Module Quick Start Guide* for a menu tree containing a complete listing of menus.

MODULES (DBU) > INFO

Read security: 5

Provides information about the module part number, serial number, and assembly revision.

MODULES (DBU) > INFO > PART NUMBER

Read security: 5

Displays the part number of the module.

MODULES (DBU) > INFO > SERIAL NUMBER

Read security: 5

Displays the serial number of the module.

MODULES (DBU) > INFO > ASSEMBLY REVISION

Read security: 5

Displays the assembly revision.

MODULES (DBU) > INFO > FIRMWARE REVISION

Read security: 5

Displays the current firmware revision of the BRI DBU Network Interface Module.

MODULES (DBU) > BONDING STATUS

Read security: 5

Indicates the current status of a particular BONDING session.

MODULES (DBU) > BONDING STATUS > STATUS

Read security: 5

Displays the current status of the BONDING session. The following states are available:

IDLE	Indicates the number of Idle BONDING resources for a particular BONDING engine.
RESERVED	BONDING resources reserved for a BONDING session that is in the process of coming up.
NEGOTIATING	A single channel is connected and negotiating the BONDING call for a particular BONDING session.

ADD CHANNELS	The initial BONDING negotiation was successful, and the ATLAS 550 is in the process of adding channels to the BONDING session.
BONDING	The remaining channels were brought up successfully, and the BONDING session is now ready to pass data.
TERMINATED	The BONDING session has been terminated for some reason and is in the process of freeing BONDING resources.

MODULES (DBU) > BONDING STATUS > NUMBCHANNELS

Read security: 5

Displays the number of bearer channels used in this BONDING session. When the number is displayed in the format X/Y, Y is the number of BONDING resources reserved for this session, and X is the number of calls belonging to this session that are up. If just a number is displayed, then all calls are up and the number displayed is the number of BONDING resources in use for this session.

MODULES (DBU) > BONDING STATUS > DATA RATE

Read security: 5

Displays the data rate for this BONDING session. The number in the parentheses is the data rate of the individual bearer channels.

MODULES (DBU) > BONDING STATUS > BONDED EP

Read security: 5

Displays the slot and port of the terminating endpoint that is using this BONDING session.

MODULES (DBU) > BONDING CONFIGURATION

Write security: 3; Read security: 5

All of the following configurable parameters apply to the BRI DBU Network Interface Module. In most applications the default values will be correct.

MODULES (DBU) > BONDING CONFIGURATION > TXINIT TIMER

Write security: 3; Read security: 5

Specifies the length of time the originating endpoint attempts to detect the BONDING negotiation pattern from the answering endpoint before deciding the BONDING call has failed.

MODULES (DBU) > BONDING CONFIGURATION > TXFA TIMER

Write security: 3; Read security: 5

Specifies the length of time both endpoints attempt to detect the BONDING frame pattern when a call is connected before deciding the BONDING call has failed. When interoperating with other manufacturers' BONDING equipment, it may be necessary to change this time so that it matches TXADD01.

MODULES (DBU) > BONDING CONFIGURATION > TXADD01 TIMER**Write security: 3; Read security: 5**

Specifies the length of time both endpoints wait for additional calls to be connected at the end of negotiation before deciding that the BONDING call has failed. The factory default setting is sufficient for most calls to connect, although when dialing overseas it may be necessary to lengthen this timer to allow for slower call routing.

MODULES (DBU) > BONDING CONFIGURATION > TXDEQ TIMER**Write security: 3; Read security: 5**

Specifies the length of time both endpoints attempt to equalize the network delay between the bearer channels before deciding the BONDING call has failed.

MODULES (DBU) > BONDING CONFIGURATION > TANULL TIMER**Write security: 3; Read security: 5**

Specifies the length of time the answering endpoint attempts to detect the BONDING negotiation pattern from the originating endpoint before deciding the BONDING call has failed. It may be necessary to shorten this timer if the DTE equipment using the BONDING module also has timer constraints for completing non-BONDING parameter negotiation.

MODULES (DBU) > BONDING CONFIGURATION > TCID TIMER**Write security: 3; Read security: 5**

Specifies the length of time both endpoints attempt to negotiate an agreeable value for bearer channels and channel capacities before deciding the BONDING call has failed.

MODULES (DBU) > BONDING CONFIGURATION > CALL STAGGER**Write security: 3; Read security: 5**

Specifies the amount of delay between placing calls for outgoing BONDING sessions. The following call stagger values are available: **NO STAGGER**, **500 MS**, **1 SEC**, and **2 SEC**.

MODULES (DBU) > BRI ALARM**Read security: 5**

Displays the alarm status for the selected BRI DBU Network Interface Module.

MODULES (DBU) > BRI ALARM > PHYSICAL ALARM**Read security: 5**

Displays the current alarm status of the Basic Rate ISDN (BRI) interface.

LAYER 1 A layer one alarm is indicated by an asterisk (*) when the BRI physical layer is not active. An L1 alarm is present when problems are detected with the endpoint or with cabling.

MODULES (DBU) > BRI CHANNEL STATUS**Read security: 5**

Displays the status of the individual bearer (B) channels on the Basic Rate ISDN (BRI) interface.

MODULES (DBU) > BRI CHANNEL STATUS > PRT**Read security: 5**

Indicates the port number.

MODULES (DBU) > BRI CHANNEL STATUS > CHA**Read security: 5**

(Channel) Displays the status of individual channels. The following symbols may display:

- Unallocated channel
- . Inactive channel
- B** Active B channel
- D** Active D channel

MODULES (DBU) > PERFORMANCE CURRENT**Write security: 3; Read security: 5**

The performance field provides status on key performance measures for the Basic Rate ISDN (BRI) interface. All fields (except **RESET**) are read-only. The monitored parameters include the following:

PRT	Displays the port number
RESET	Resets the NEBE and FEBE statistics
NEBE CURRENT	Near-end block errors
FEBE CURRENT	Far-end block errors

MODULES (DBU) > BRI CONFIGURATION**Write security: 3; Read security: 5**

All of the following configurable parameters apply to the Basic Rate ISDN (BRI) interface on the BRI DBU Network Interface Module.

MODULES (DBU) > BRI CONFIGURATION > PRT**Read security: 5**

Displays the port number.

MODULES (DBU) > BRI CONFIGURATION > PORT NAME**Write security: 3; Read security: 5**

Accepts any alpha-numeric name up to 16 characters long, to uniquely identify the Basic Rate ISDN (BRI) interface on the BRI DBU Network Interface Module.

MODULES (DBU) > BRI TEST**Write security: 4; Read security: 5**

The following options initiate tests and display test results.

MODULES (DBU) > BRI TEST > LOCAL LOOPBACK**Write security: 3; Read security: 5**

Activates a local loopback of the Basic Rate ISDN (BRI) U interface toward the network. The following options are available:

NONE	No active loopback
LOOPBACK B1	Loops the first B channel of the interface
LOOPBACK B2	Loops the second B channel of the interface
LOOPBACK B1 & B2	Loops both B channels of the interface
LOOPBACK ALL	Loops the entire physical interface (2B + D)

MODULES MENU (DUAL/QUAD T1/PRI OPTION MODULES)

This section provides detailed information on the **MODULES** menu and submenus for the Dual/Quad T1/PRI Option Modules. The ATLAS 550 system controller automatically detects the presence of the Dual/Quad T1/PRI Option Modules when they are installed in the system (Dual is listed as **T1/PRI-2** and the Quad is listed as **T1/PRI-4**). All menus detailed in this section that apply to both modules are listed as **T1/PRI-2/4**. To see the menus for the Dual/Quad T1/PRI Option Modules via the terminal menu, use the arrow keys to scroll to the **MODULES** menu and press <Enter> to access the module choices. Refer to the *Dual/Quad T1/PRI Option Modules Quick Start Guide* for a menu tree containing a complete listing of menus.

MODULES (T1/PRI-2/4) > INFO**Read security: 5**

Displays general information about the T1/PRI Network Interface Module as follows:

MODULES (T1/PRI-2/4) > INFO > PART NUMBER**Read security: 5**

Displays the part number of the T1/PRI Network Interface Module.

MODULES (T1/PRI-2/4) > INFO > SERIAL NUMBER**Read security: 5**

Displays the module's serial number.

MODULES (T1/PRI-2/4) > INFO > ASSEMBLY REVISION**Read security: 5**

Displays the assembly revision of the module.

MODULES (T1/PRI-2/4) > INFO > PLL STATUS**Read security: 5**

Indicates whether the module phase lock loop is locked to its specific source.

MODULES (T1/PRI-2/4) > ALARM STATUS**Read security: 5**

Displays the current T1 alarm status.

MODULES (T1/PRI-2/4) > ALARM STATUS > PRT**Read security: 5**

Indicates the port number.

MODULES (T1/PRI-2/4) > ALARM STATUS > ALARMS**Read security: 5**

Displays an alarm condition on the ATLAS 550 unit. Press <Enter> to access this menu item.

LOS	Indicates a loss of signal detected on port interface.
RED	Indicates inability to frame data received on the port. Alternately referred to as Out of Frame (OOF).
YELLOW	Receiving remote alarm (RAI) on port.
BLUE	Receiving unframed all ones from the port Alarm Indicator Signal (AIS).
DS0 ALARM	Displays per-DS0 alarm status; that is, at least one DS0 channel is in alarm if an asterisk (*) appears. These alarms usually indicate the failure to receive the protocol that has been configured for the DS0.
RX LEVEL (RECEIVE LEVEL)	Indicates the strength of the signal (in dB) received on the port.

MODULES (T1/PRI-2/4) > DS0 STATUS**Read security: 5**

The DS0 status indicates usage on a DS0 basis. These options are read-only:

-	Unallocated	M	Maintenance
*	Inactive	N	Dedicated (nailed)
+	Signaling mismatch	O	Off hook - originate (RBS)
A	Active B Channel	R	Ringling (RBS); Restart (ISDN)
D	Active D Channel	W	Waiting dial tone

MODULES (T1/PRI-2/4) > DS0 ALARMS**Read security: 5**

Displays per-DS0 alarm status. These alarms usually indicate the failure to receive the protocol that has been configured for the DS0.

- No Alarm DS0
- D** D Channel Alarm (ISDN)
- F** Frame Alarm (packet)
- T** TBOP Alarm (packet)
- P** PPP Alarm (packet)

MODULES (T1/PRI-2/4) > SIG STATUS**Read security: 5**

Read-only field that indicates signaling of all 24 DS0s. The A/B bits for Rx (receive) and Tx (transmit) DS0s are shown. Dashes display for those DS0s where robbed bit signaling (RBS) is not being transferred by the ATLAS 550.

MODULES (T1/PRI-2/4) > PERFORMANCE CURRENT**Write security:3; Read security: 5**

The performance fields (either current, 15-minute total, or 24-hour total) provide status on key performance measures as specified in ANSI T1.403 and AT&T TR54016 for the T1/PRI port. Except for **CLR**, these fields are all read-only. The monitored parameters include the following:

PRT	Displays the port number
CLR	Clears performance information for the selected port
ES	Errored Second (ES) is a second with one or more error events OR one or more Out Of Frame events OR one or more Controlled Slips
BES	Bursty Errored Second (BES) is a second with more than one, but less than 320 error events
SES	Severely Errored Second (SES) is a second with 320 or more error events OR one or more Out Of Frame events
SEFS	Severely Errored Frame Second is a second that contains four consecutive errored framing patterns.
LOFC	Loss of Frame Count is a count of seconds in which a valid framing pattern could not be obtained.
CSS	Controlled Slip Second
UAS	Unavailable Second
LCV	Line Code Violation
PCV	Path Code Violation
LES	Line Errored Second

MODULES (T1/PRI-2/4) > PERFORMANCE 15MIN**Write security:3; Read security: 5**

Stores the performance data for the previous 15-minute window. Refer to *Modules (T1/PRI-2/4) > Performance Current* for a detailed description of these fields.

MODULES (T1/PRI-2/4) > PERFORMANCE 24HR**Write security:3; Read security: 5**

Stores the performance data for the previous 24-hour window. Refer to *Modules (T1/PRI-2/4) > Performance Current* for a detailed description of these fields.

MODULES (T1/PRI-2/4) > CONFIGURATION

Write security: 3; Read security: 5

All of the following configurable parameters apply to whether the port is connected to a Primary Rate ISDN (PRI) circuit or a channelized T1 circuit.

MODULES (T1/PRI-2/4) > CONFIGURATION > PRT

Read security: 5

Displays the port number.

MODULES (T1/PRI-2/4) > CONFIGURATION > PORT NAME

Write security: 3; Read security: 5

Accepts any alpha-numeric name up to 16 characters long, to uniquely identify each port on the ATLAS 550.

MODULES (T1/PRI-2/4) > CONFIGURATION > FRAME

Write security: 2; Read security: 5

This field must be set to match the frame format of the circuit to which it is connected, available from the network supplier. Choose either **D4** or **ESF**.

MODULES (T1/PRI-2/4) > CONFIGURATION > CODE

Write security: 2; Read security: 5

Set this field to match the line code of the circuit to which it is connected (this information is available from the network supplier). Choose either **AMI** (Alternate Mark Inversion) or **B8ZS** (Bipolar Eight Zero Substitution).

MODULES (T1/PRI-2/4) > CONFIGURATION > TX YEL

Write security: 3; Read security: 5

Controls the transmission of yellow alarms. Choose either **ON** or **OFF**.

MODULES (T1/PRI-2/4) > CONFIGURATION > TX PRM

Write security: 3; Read security: 5

Controls the sending of performance report messaging (PRM) data on the facility data link (FDL). The PRM data continues to be collected even if **XMIT PRM** is turned off (possible only with ESF format). Choose either **ON** or **OFF**.

MODULES (T1/PRI-2/4) > CONFIGURATION > LBO

Write security: 2; Read security: 5

Selects the Line Build Out (LBO) for the network interface. When connecting an ATLAS 550 port to a DSX-1 interface, this parameter is typically set to match the distance (in feet) between the ATLAS 550 and the device with which it is connecting. When you select this item, a list of choices displays (**0 dB, -7.5 dB, -15 dB, -22 dB, 266 FT, 399 FT, 533 FT, 655 FT**). Select the appropriate option.

MODULES (T1/PRI-2/4) > CONFIGURATION > LB ACCEPT**Write security: 3; Read security: 5**

Sets unit to accept or reject the in-band loop up and loop down codes as defined in ANSI T1.403. This is a line loopback. Choose either **ACCEPT** or **IGNORE**.

MODULES (T1/PRI-2/4) > CONFIGURATION > PULSE DENSITY**Write security: 3; Read security: 5**

Choose either **ON** or **OFF**. When **ON**, Pulse Density Enforcer causes the ATLAS 550 to monitor for ones (1s) density violations and insert a one (1) when needed to maintain ones at 12.5%. This data insertion will cause data errors.

MODULES (T1/PRI-2/4) > CONFIGURATION > ADLP OVER FDL**Write security: ADTRAN Use Only; Read security: 5**

The ADTRAN Data Link Protocol (ADLP) provides a communications link between ADTRAN equipment over point-to-point or multidrop connections that can be used for configuring and monitoring remote ADTRAN devices. Choose **ENABLE** to activate the ADLP over the FDL for the DS1 interface.

MODULES (T1/PRI-2/4) > TEST**Write security: 5; Read security: 5**

These options initiate different types of tests and display test results.

MODULES (T1/PRI-2/4) > TEST > PRT**Read security: 5**

Displays the port number.

MODULES (T1/PRI-2/4) > TEST > LOC LB**Write security: 4; Read security: 5**

Initiates a loopback on near-end (local) port (see Figure 9). The following options are available:

LINE	Metallic loopback
PAYLD	Payload loopback - framing and clocking are regenerated

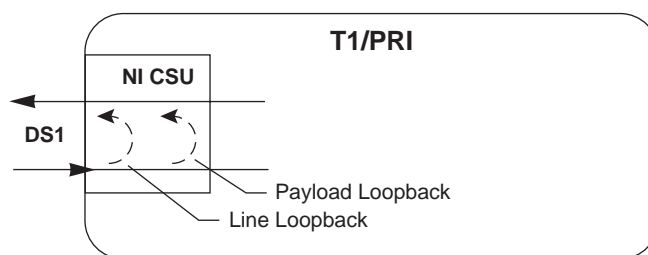
**Figure 11. T1/PRI Loopback Test Diagram**

MODULES (T1/PRI-2/4) > TEST > REMOTE LB**Write security: 4; Read security: 5**

Sends loopback code to remote CSU. The following options are available:

Selection	Framing	Description
AT&T INBAND LINE	ESF/D4	Full 1.544 Mbps loopback of the signal received from the network (metallic loopback).
ANSI FDL LINE	ESF	Full 1.544 Mbps loopback of the signal received from the network. Initiated through loopback activation transmission over the facility data link (FDL).
ANSI FDL PYLD	ESF	1.536 Mbps loopback of the payload data received from the network maintaining bit-sequence integrity for the information bits by synchronizing (regenerating) the timing. Initiated through loopback activation transmission over the facility datalink (FDL).
INBAND NIU	ESF/D4	Full 1.544 Mbps loopback of the signal received from the network after passing through the T1 framer of the remote unit.

MODULES (T1/PRI-2/4) > TEST > PATTERN**Write security: 4; Read security: 5**

Test pattern to be transmitted out the port. The following options are available:

ALL ONES	Framed ones
ALL ZEROS	Framed zeros
QRSS	Pseudo-random pattern with suppression of excess zeros

MODULES (T1/PRI-2/4) > TEST > QRSS/RLB RESULTS**Write security: 3; Read security: 5**

Displays current status of T1 tests including information regarding loopbacks and test patterns. When displaying test pattern status, the display string is composed of pattern sync status and errored seconds.

NONE	No sync.
LOS	Sync has been lost.
SYNC	Pattern is synchronized.
ES	Number of seconds with at least one bit error.

MODULES (T1/PRI-2/4) > TEST > CLR**Write security: 3; Read security: 3**

Clears error counters on test pattern results menu.

MODULES (T1/PRI-2/4) > TEST > INJ**Write security: 3; Read security: 3**

Injects errors into transmitted test pattern.

MODULES MENU (DUAL Nx56/64 OPTION MODULE)

The ATLAS 550 system controller automatically detects the presence of the Dual Nx 56/64 Option Module when it is installed in the system (listed as **V35Nx-2**). To see the menus for the Dual Nx 56/64 Option Module via the terminal menu, use the arrow keys to scroll to the **MODULES** menu and press <Enter> to access the module choices. Refer to the *Dual Nx 56/64 Option Module Quick Start Guide* for a menu tree containing a complete listing of menus.

MODULES (V35Nx-2) > INFO

Read security: 5

Provides information about the module part number, serial number, and assembly revision.

MODULES (V35Nx-2) > INFO > PART NUMBER

Read security: 5

Displays the part number of the module.

MODULES (V35Nx-2) > INFO > SERIAL NUMBER

Read security: 5

Displays the serial number of the module.

MODULES (V35Nx-2) > INFO > ASSEMBLY REVISION

Read security: 5

Displays the assembly revision of the installed module.

MODULES (V35Nx-2) > ALARM STATUS

Read security: 5

Displays the current alarm status.

MODULES (V35Nx-2) > ALARM STATUS > PRT

Read security: 5

Indicates the port number.

MODULES (V35Nx-2) > ALARM STATUS > ALARMS

Read security: 5

Displays an alarm condition on the ATLAS 550 unit.

SLIP	A rate mismatch exists between the DTE clock and the network-side clock (as set by DS0 assignment).
PLL	The Nx port is not able to lock onto the clock provided by the network interface.
ZERO	The DTE is sending an excessive number of consecutive zeroes to the network interface.
NO EXT CLK	The DTE is not providing an external transmit clock. This alarm displays only if the Nx port is configured to get its transmit clock from the DTE.
PKT EP ALM	A packet endpoint has detected missing or incorrect framing.

MODULES (V35Nx-2) > DTE STATUS**Read security: 5**

Shows the status of key DTE interface signals. An asterisk (*) indicates the presence of a signal and a hyphen (-) indicates no signal present.

MODULES (V35Nx-2) > DTE STATUS > PRT**Read security: 5**

Operating port number. There are 2 available interfaces on the Dual Nx56/64 Option Module.

MODULES (V35Nx-2) > DTE STATUS > DTE STATUS**Read security: 5**

The following signals are monitored (these options are read-only).

RTS	Request to send from DTE.
CTS	Clear to send to DTE.
DTR	Data terminal ready from DTE.
DSR	Data set ready to DTE.
DCD	Data carrier detect to DTE.
RI	Ring indicate to DTE.
TD	Transmit data from the DTE.
RD	Receive data toward the DTE.
EC	External clock present.

MODULES (V35Nx-2) > DATA RATE**Read security: 5**

Displays the data rate at which each Nx port is currently operating. A port's data rate is determined by the number of DS0s assigned to it and the rate per DS0 associated with the active maps.

MODULES (V35Nx-2) > DATA RATE > PORT**Read security: 5**

Operating port number. There are 2 available interfaces on the Dual Nx56/64 Option Module.

MODULES (V35Nx-2) > DATA RATE > RATE**Read security: 5**

This read-only field displays the data rate for the selected port.

MODULES (V35Nx-2) > INBAND STATS**Read security: 5**

Provides information on the following inband channel statistics.

MODULES (V35Nx-2) > INBAND STATS > PORT**Read security: 5**

Operating port number. There are 2 available interfaces on the Dual Nx56/64 Option Module.

MODULES (V35Nx-2) > INBAND STATS > RX FRAMES**Read security: 5**

The number of frames received on the operating port since system startup.

MODULES (V35Nx-2) > INBAND STATS > TX FRAMES**Read security: 5**

The number of frames transmitted from the operating port since system startup.

MODULES (V35Nx-2) > INBAND STATS > RX BYTES**Read security: 5**

The number of bytes received on the operating port since system startup.

MODULES (V35Nx-2) > INBAND STATS > TX BYTES**Read security: 5**

The number of bytes transmitted from the operating port since system startup.

MODULES (V35Nx-2) > INBAND STATS > RESET STATS**Write security: 5; Read security: 5**

Clears inband statistic results.

MODULES (V35Nx-2) > PLL/FIFO**Read security: 5**

Displays the Phase Lock Loop (PLL) and FIFO status.

MODULES (V35Nx-2) > PLL/FIFO > PORT**Read security: 5**

Indicates the operating port. There are 2 available interfaces on the Dual Nx56/64 Option Module.

MODULES (V35Nx-2) > PLL/FIFO > PLL/FIFO**Read security: 5**

Displays the state of the PLL and FIFO systems.

LOCK	PLL is locked (This is required to transfer data.)
RXE	Receive data FIFO empty.
RXF	Receive data FIFO full.
TXE	Transmit data FIFO empty.
TXF	Transmit data FIFO full.

MODULES (V35Nx-2) > CONFIGURATION**Write security: 3; Read security: 5**

All of the following configurable parameters apply to the individual V.35 ports.

MODULES (V35Nx-2) > CONFIGURATION > PRT**Read security: 5**

Displays the port number. There are 2 available interfaces on the Dual Nx56/64 Option Module.

MODULES (V35Nx-2) > CONFIGURATION > PORT NAME**Write security: 3; Read security: 5**

Accepts any alpha-numeric name up to 17 characters long, to uniquely identify each port on the Dual Nx56/64 Option Module.

MODULES (V35Nx-2) > CONFIGURATION > CLK +/-**Write security: 3; Read security: 5**Controls the clock used by the ATLAS 550 to accept the transmit (TX) data from the DTE. This is usually set to **NORMAL**. If the interface cable is long, causing a phase shift in the data, the clock can be set to **INVERTED**. This switches the phase of the clock, which compensates for a long cable.**MODULES (V35Nx-2) > CONFIGURATION > DATA****Write security: 3; Read security: 5**Controls the inverting of the DTE data. This inversion can be useful when operating with a high-level data link control (HDLC) protocol (often used as a means to ensure 1s density). Select either **NORMAL** or **INVERTED**. Data inversion configuration must match at both ends of the circuit.**MODULES (V35Nx-2) > CONFIGURATION > CTS****Write security: 3; Read security: 5**Determines the behavior of the Clear To Send (CTS) signal. If set to **NORMAL**, **CTS** will follow the value of Request To Send (RTS). If set to **FORCED ON**, **CTS** will always be asserted.

MODULES (V35Nx-2) > CONFIGURATION > DCD**Write security: 3; Read security: 5**

Determines the behavior of the Data Carrier Detect (**DCD**) signal, also called RLSD on V.35 interfaces. If set to **NORMAL**, **DCD** will generally be asserted when the interface is capable of passing data. If set to **FORCED ON**, **DCD** will always be asserted. If set to **REMOTE RTS**, the value of **DCD** will track the value of the remote unit's RTS signal. Note that this feature requires the Inband control channel to be **ENABLED**.

MODULES (V35Nx-2) > CONFIGURATION > DSR**Write security: 3; Read security: 5**

Determines the behavior of the Data Set Ready (**DSR**) signal. If set to **NORMAL**, **DSR** will generally be asserted when the interface is capable of passing data. If set to **FORCED ON**, **DSR** will always be asserted. If set to **REMOTE DTR**, the value of **DSR** will track the value of the remote unit's DTR signal. This remote feature requires the Inband control channel to be **ENABLED**.

MODULES (V35Nx-2) > CONFIGURATION > DTR**Write security: 3; Read security: 5**

Determines whether the ATLAS 550 treats a connection as permanent (**IGNORE**) or connects only when Data Terminal Ready (**DTR**) is active (**CONNECT ON DTR**). Select either **IGNORE** or **CONNECT ON DTR**.

MODULES (V35Nx-2) > CONFIGURATION > 0 INH**Write security: 3; Read security: 5**

When the port detects an uninterrupted string of 0s being transmitted for more than one second, setting this parameter to **ON** will cause the ATLAS 550 to send 1s toward the network.

MODULES (V35Nx-2) > CONFIGURATION > INBAND**Write security: 3; Read security: 5**

Creates an inband management channel by robbing 8 kbps bandwidth from the port's allocated bandwidth. This channel can be used for management for ADTRAN products that are not co-located with the ATLAS. Consult the manual for ADTRAN T1 equipment for details on using this feature.

MODULES (V35Nx-2) > CONFIGURATION > SEND LEADS**Write security: 3; Read security: 5**

Sends the state of the DTE leads to the remote unit whenever any of the leads change state. If any leads on the remote unit are set to track a remote signal, this option must be enabled. The DTE lead states are conveyed using the Inband control channel, which must be enabled.

SIGNAL	RTS	V.54 LOOPBACK	511 TEST ON	SELF TEST ACTIVE	NETWORK TEST ACTIVE	NO DS0 MAPPED	NETWORK ALARM
CTS	Follows	Off	Off	Off	Off	Off	Off
DCD	—	—	—	Off	Off	Off	Off

DSR	—	Off	Off	Off	Off	Off	—
— = Do not care							
Force On = On under all conditions							

MODULES (V35Nx-2) > DIAL**Write security: 3; Read security: 5**

Dials an Nx port that is configured to ignore DTR.

MODULES (V35Nx-2) > DIAL > PRT**Read security: 5**

Displays the port number. There are 2 available interfaces on the Dual Nx56/64 Option Module.

MODULES (V35Nx-2) > DIAL > MODE**Write security: 3; Read security: 5**

Configures the dialing mode. The following options are available:

- | | |
|-------------------|---|
| PERSISTENT | Redial whenever the call is cleared or if the call fails. |
| ONE TIME | Attempt the call only once. |

MODULES (V35Nx-2) > DIAL > DIAL**Write security: 0; Read security: 0**

Signals the Nx port to dial/clear the call.

MODULES (V35Nx-2) > DIAL > SRC ID**Write security: 3; Read security: 5**Indicates the **SOURCE ID** of the number to be dialed. Configure this field in the Nx **INTERFACE CONFIGURATION** section of the **DIAL PLAN**.**MODULES (V35Nx-2) > DIAL > NUMBER****Write security: 3; Read security: 5**Indicates the number to be dialed. Configure this field in the Nx **INTERFACE CONFIGURATION** section of the **DIAL PLAN**.**MODULES (V35Nx-2) > TEST****Write security: 4; Read security: 5**

These options initiate different types of tests and display test results.

MODULES (V35Nx-2) > TEST > PORT

Indicates operating port. There are 2 available interfaces on the Dual Nx56/64 Option Module.

MODULES (V35Nx-2) > TEST > LOOPBACK**Write security: 4; Read security: 5**

Test pattern to be transmitted out the port. The following options are available:

NO LOOPBACK	No active loopback.
LOCAL LOOPBACK	Activates both a local loopback (back toward the DTE) and a port loopback (toward the network).
REMOTE LOOPBACK	V.54 loopback code to be sent to the far end, and if the device at the far end supports V.54, the device activates a loopback on detection of the V.54 code.

MODULES (V35Nx-2) > TEST > LOOPBACK STATUS**Read security: 5**

This read-only option indicates a port's current loopback status by displaying any of the following status messages:

NO LOOPBACK ACTIVE	REMOTE LOOP-UP FAILED
LOOPING UP REMOTE UNIT	PORT LOOPED FROM REMOTE SOURCE
REMOTE UNIT LOOPED BACK	PORT LOOPBACK ACTIVE
LOOPING DOWN REMOTE UNIT	

MODULES (V35Nx-2) > TEST > 511**Write security: 4; Read security: 5**

Controls the activation of the 511 test pattern generator and detector.

MODULES (V35Nx-2) > TEST > 511 RESULT**Read security: 5**

Displays the results of the 511 test. This option is read-only. Clear these results by pressing <Enter> when **CLR** is selected.

NONE	Pattern is not synchronized.
LOS	At one point the pattern was synchronized, but is currently not synchronized.
SYNC	Pattern is synchronized.
ES	Number of seconds with at least one bit error.

MODULES (V35Nx-2) > TEST > INJECT**Write security: 4; Read security: 4**

Injects errors into transmitted test pattern.

MODULES (V35Nx-2) > TEST > CLR**Write security: 4; Read security: 4**

Clears error counters on test pattern results menu.

MODULES MENU (DUAL USSI OPTION MODULE)

The ATLAS 550 system controller automatically detects the presence of the Dual USSI Option Module when it is installed in the system (listed as **USSI-2**). To see the menus for the Dual USSI Option Module via the terminal menu, use the arrow keys to scroll to the **MODULES** menu and press <Enter> to access the module choices. Refer to the *Dual USSI Option Module Quick Start Guide* for a menu tree containing a complete listing of menus.

MODULES (USSI-2) > INFO**Read security: 5**

Provides information about the module part number, serial number, and assembly revision.

MODULES (USSI-2) > INFO > PART NUMBER**Read security: 5**

Displays the part number of the module.

MODULES (USSI-2) > INFO > SERIAL NUMBER**Read security: 5**

Displays the serial number of the module.

MODULES (USSI-2) > INFO > ASSEMBLY REVISION**Read security: 5**

Displays the assembly revision of the installed module.

MODULES (USSI-2) > ALARM STATUS**Read security: 5**

Displays the current alarm status.

MODULES (USSI-2) > ALARM STATUS > PRT**Read security: 5**

Indicates the port number. There are 2 available interfaces on the Dual USSI Option Module.

MODULES (USSI-2) > ALARM STATUS > ALARMS**Read security: 5**

Displays an alarm condition on the ATLAS 550 unit.

SLIP	A rate mismatch exists between the DTE clock and the network-side clock (as set by DS0 assignment).
PLL	The USSI port is not able to lock onto the clock provided by the network interface.
ZERO	The DTE is sending an excessive number of consecutive zeroes to the network interface.
NO EXT CLK	The DTE is not providing an external transmit clock. This alarm displays only if the USSI port is configured to get its transmit clock from the DTE.
PKT EP ALM	A packet endpoint has detected missing or incorrect framing.

MODULES (USSI-2) > DTE STATUS**Read security: 5**

Shows the status of key DTE interface signals. An asterisk (*) indicates the presence of a signal and a hyphen (-) indicates no signal present.

MODULES (USSI-2) > DTE STATUS > PRT**Read security: 5**

Operating port number. There are 2 available interfaces on the Dual USSI Option Module.

MODULES (USSI-2) > DTE STATUS > DTE STATUS

The following signals are monitored (these options are read-only):

RTS	Request to send from DTE.
CTS	Clear to send to DTE.
DTR	Data terminal ready from DTE.
DSR	Data set ready to DTE.
DCD	Data carrier detect to DTE.
RI	Ring indicate to DTE.
TD	Transmit data from the DTE.
RD	Receive data toward the DTE.
EC	External clock present.

MODULES (USSI-2) > DATA RATE**Read security: 5**

Displays the data rate at which each USSI port is currently operating. A port's data rate is determined by the number of DS0s assigned to it and the rate per DS0 associated with the active maps.

MODULES (USSI-2) > DATA RATE > PORT**Read security: 5**

Displays operating port. There are 2 available interfaces on the Dual USSI Option Module.

MODULES (USSI-2) > DATA RATE > RATE**Read security: 5**

Displays the data rate of the selected port.

MODULES (USSI-2) > INBAND STATS**Write security: 5; Read security: 5**

Provides information on the inband channel statistics.

MODULES (USSI-2) > INBAND STATS > PORT**Read security: 5**

Operating port number. There are 2 available interfaces on the Dual USSI Option Module.

MODULES (USSI-2) > INBAND STATS > RX FRAMES**Read security: 5**

The number of frames received on the operating port since system startup.

MODULES (USSI-2) > INBAND STATS > TX FRAMES**Read security: 5**

The number of frames transmitted from the operating port since system startup.

MODULES (USSI-2) > INBAND STATS > RX BYTES**Read security: 5**

The number of bytes received on the operating port since system startup.

MODULES (USSI-2) > INBAND STATS > TX BYTES**Read security: 5**

The number of bytes transmitted from the operating port since system startup.

MODULES (USSI-2) > INBAND STATS > RESET STATS**Write security: 5; Read security: 5**

Clears inband statistic results.

MODULES (USSI-2) > PLL/FIFO**Read security: 5**

Displays the Phase Lock Loop (PLL) and FIFO status.

MODULES (USSI-2) > PLL/FIFO > PORT**Read security: 5**

Indicates the operating port. There are 2 available interfaces on the Dual USSI Option Module.

MODULES (USSI-2) > PLL/FIFO > PLL/FIFO**Read security: 5**

Displays the state of the PLL and FIFO systems.

LOCK	PLL is locked (This is required to transfer data.)
RXE	Receive data FIFO empty.
RXF	Receive data FIFO full.
TXE	Transmit data FIFO empty.
TXF	Transmit data FIFO full.

MODULES (USSI-2) > CONFIGURATION**Write security: 3; Read security: 5**

All of the following configurable parameters apply to the individual USSI ports.

MODULES (USSI-2) > CONFIGURATION > PRT**Read security: 5**

Displays the port number. There are 2 available interfaces on the Dual USSI Option Module.

MODULES (USSI-2) > CONFIGURATION > PORT NAME**Write security: 3; Read security: 5**

Accepts any alpha-numeric name up to 16 characters long, to uniquely identify each port on the Dual USSI Option Module.

MODULES (USSI-2) > CONFIGURATION > CLK +/-**Write security: 3; Read security: 5**

Controls the clock used by the ATLAS 550 to accept the transmit (TX) data from the DTE. This is usually set to **NORMAL**. If the interface cable is long, causing a phase shift in the data, the clock can be set to **INVERTED**. This switches the phase of the clock, which compensates for a long cable.

MODULES (USSI-2) > CONFIGURATION > DATA**Write security: 3; Read security: 5**

Controls the inverting of the DTE data. This inversion can be useful when operating with a high-level data link control (HDLC) protocol (often used as a means to ensure 1s density). Select either **NORMAL** or **INVERTED**. Data inversion configuration must match at both ends of the circuit.

MODULES (USSI-2) > CONFIGURATION > CTS**Write security: 3; Read security: 5**

Determines the behavior of the Clear To Send (**CTS**) signal. If set to **NORMAL**, **CTS** will follow the value of Request To Send (**RTS**). If set to **FORCED ON**, **CTS** will always be asserted.

MODULES (USSI-2) > CONFIGURATION > DCD**Write security: 3; Read security: 5**

Determines the behavior of the Data Carrier Detect (**DCD**) signal, also called RLSD on some interfaces. If set to **NORMAL**, **DCD** will generally be asserted when the interface is capable of passing data (consult the ATLAS 550 User Manual for exact conditions.) If set to **FORCED ON**, **DCD** will always be asserted. If set to **REMOTE RTS**, the value of **DCD** will track the value of the remote unit's RTS signal. Note that this feature requires the Inband control channel to be **ENABLED**.

MODULES (USSI-2) > CONFIGURATION > DSR**Write security: 3; Read security: 5**

Determines the behavior of the Data Set Ready (**DSR**) signal. If set to **NORMAL**, **DSR** will generally be asserted when the interface is capable of passing data. If set to **FORCED ON**, **DSR** will always be asserted. If set to **REMOTE DTR**, the value of **DSR** will track the value of the remote unit's DTR signal. This remote feature requires the Inband control channel to be **ENABLED**.

MODULES (USSI-2) > CONFIGURATION > DTR**Write security: 3; Read security: 5**

Determines whether the ATLAS 550 treats a connection as permanent (**IGNORE**) or connects only when Data Terminal Ready (**DTR**) is active (**CONNECT ON DTR**). Select either **IGNORE** or **CONNECT ON DTR**.

MODULES (USSI-2) > CONFIGURATION > 0 INH**Write security: 3; Read security: 5**

When the port detects an uninterrupted string of 0s being transmitted for more than one second, setting this parameter to **ON** will cause the ATLAS 550 to send 1s toward the network.

MODULES (USSI-2) > CONFIGURATION > INBAND**Write security: 3; Read security: 5**

Creates an inband management channel by robbing 8 kbps bandwidth from the port's allocated bandwidth. This channel can be used for management for ADTRAN products that are not co-located with the ATLAS. Consult the manual for ADTRAN T1 equipment for details on using this feature.

MODULES (USSI-2) > CONFIGURATION > SEND LEADS**Write security: 3; Read security: 5**

Sends the state of the DTE leads to the remote unit whenever any of the leads change state. If any leads on the remote unit are set to track a remote signal, this option must be enabled. The DTE lead states are

conveyed using the Inband control channel, which must be enabled.

SIGNAL	RTS	V.54 LOOPBACK	511 TEST ON	SELF TEST ACTIVE	NETWORK TEST ACTIVE	NO DS0 MAPPED	NETWORK ALARM
CTS	Follows	Off	Off	Off	Off	Off	Off
DCD	—	—	—	Off	Off	Off	Off
DSR	—	Off	Off	Off	Off	Off	—
— = Do not care							
Force On = On under all conditions							

MODULES (USSSI-2) > DIAL

Write security: 3; Read security: 5

Dials a USSSI port that is configured to ignore DTR.

MODULES (USSSI-2) > DIAL > PRT

Read security: 5

Displays the port number. There are 2 available interfaces on the Dual USSSI Option Module.

MODULES (USSSI-2) > DIAL > MODE

Write security: 3; Read security: 5

Configures the dialing mode. The following options are available:

- | | |
|-------------------|---|
| PERSISTENT | Redial whenever the call is cleared or if the call fails. |
| ONE TIME | Attempt the call only once. |

MODULES (USSSI-2) > DIAL > DIAL

Write security: 0; Read security: 0

Signals the USSSI port to dial/clear the call.

MODULES (USSSI-2) > DIAL > SRC ID

Write security: 3; Read security: 5

Indicates the **SOURCE ID** of the number to be dialed. Configure this field in the **USSSI INTERFACE CONFIGURATION** section of the **DIAL PLAN**.

MODULES (USSSI-2) > DIAL > NUMBER

Write security: 3; Read security: 5

Indicates the number to be dialed. Configure this field in the **USSSI INTERFACE CONFIGURATION** section of the **DIAL PLAN**.

MODULES (USSSI-2) > TEST

Write security: 4; Read security: 5

These options initiate different types of tests and display test results.

MODULES (USS1-2) > TEST > PORT**Write security: 5; Read security: 5**

Displays the port number.

MODULES (USS1-2) > TEST > LOOPBACK**Write security: 4; Read security: 5**

Test pattern to be transmitted out the port. The following options are available:

NO LOOPBACK	No active loopback.
LOCAL LOOPBACK	Activates both a local loopback (back toward the DTE) and a port loopback (toward the network).
REMOTE LOOPBACK	V.54 loopback code to be sent to the far end, and if the device at the far end supports V.54, the device activates a loopback on detection of the V.54 code.

MODULES (USS1-2) > TEST > LOOPBACK STATUS**Read security: 5**

This read-only option indicates a port's current loopback status by displaying any of the following status messages:

NO LOOPBACK ACTIVE	REMOTE LOOP-UP FAILED
LOOPING UP REMOTE UNIT	PORT LOOPED FROM REMOTE SOURCE
REMOTE UNIT LOOPED BACK	PORT LOOPBACK ACTIVE
LOOPING DOWN REMOTE UNIT	

MODULES (USS1-2) > TEST > 511**Write security: 4; Read security: 5**

Controls the activation of the 511 test pattern generator and detector.

MODULES (USS1-2) > TEST > 511 RESULT**Read security: 5**Displays the results of the 511 test. This option is read-only. Clear these results by pressing <Enter> when **CLR** is selected.

NONE	Pattern is not synchronized.
LOS	At one point the pattern was synchronized, but is currently not synchronized.
SYNC	Pattern is synchronized.
ES	Number of seconds with at least one bit error.

MODULES (USS1-2) > TEST > INJECT**Write security: 4; Read security: 4**

Injects errors into transmitted test pattern.

MODULES (USSI-2) > TEST > CLR**Write security: 4; Read security: 4**

Clears error counters on test pattern results menu.

MODULES (USSI-2) > DTE INTERFACE**Write security: 5; Read security: 5**

Configures the Dual USSI Module for the appropriate interface type. Select the parameters matching the interface cable being used.

MODULES (USSI-2) > DTE INTERFACE > PRT**Read security: 5**

Displays the port number.

MODULES (USSI-2) > DTE INTERFACE > DTE INTERFACE MODE**Write security: 3; Read security: 5**

Configures the Dual USSI Module interface type. The following options are available:

AUTO	The ATLAS 550 will automatically detect the interface type. The cable must be connected before the interface can be determined.
EIA-530A	Configures the interface for EIA-530A use.
EIA-530\RS-449\V.36	Configures the interface for EIA-530, RS-449, or V.36 use.
X.21/V.11	Configures the interface for X.21 or V.11 use.
RS-232	Configures the interface for RS-232 use.

The following Dual USSI Option Module Systems are available (each includes the appropriate interface cable):



- *RS-449/V.36 System (P/N 4200754L1)*
- *EIA-530/530A System (P/N 4200754L2)*
- *X.21/V.11 System (P/N 4200754L3)*
- *RS-232 System (P/N 4200754L4)*

MODULES (USSI-2) > DTE INTERFACE > CURRENT DTE TYPE**Read security: 5**

Displays the current configuration of the Dual USSI Module DTE Interface.

MODULES MENU (QUAD BASIC RATE ISDN (U INTERFACE) OPTION MODULE)

The ATLAS 550 system controller automatically detects the presence of the Quad BRI (U Interface) Option Module when it is installed in the system (listed as **U-BRI-4**). To see the menus for the Quad BRI (U Interface) Option Module via the terminal menu, use the arrow keys to scroll to the **MODULES** menu and press <Enter> to access the module choices. Refer to the *Quad BRI (U Interface) Option Module Quick Start Guide* for a menu tree containing a complete listing of menus.

MODULES (U-BRI-4) > INFO**Read security: 5**

Provides information about the module part number, serial number, and assembly revision.

MODULES (U-BRI-4) > INFO > PART NUMBER**Read security: 5**

Displays the part number of the module.

MODULES (U-BRI-4) > INFO > SERIAL NUMBER**Read security: 5**

Displays the serial number of the module.

MODULES (U-BRI-4) > INFO > ASSEMBLY REVISION**Read security: 5**

Displays the assembly revision of the installed module.

MODULES (U-BRI-4) > ALARMS**Read security: 5**

Displays the alarm status for each U interface on the installed module.

MODULES (U-BRI-4) > ALARMS > PRT**Read security: 5**

Indicates the port number. There are 4 available interfaces on the Quad BRI-U Option Module.

MODULES (U-BRI-4) > ALARMS > ALARMS**Read security: 5**

Displays the current alarm status of each Basic Rate ISDN (BRI) U interface.

L1 DOWN

A layer one alarm is indicated by an asterisk (*) when the BRI U physical layer is not active. An L1 alarm is present when problems are detected with the endpoint or a cabling problem.

MODULES (U-BRI-4) > CHANNEL STATUS**Read security: 5**

Displays the status of each of the Basic Rate ISDN (BRI) U interfaces.

MODULES (U-BRI-4) > CHANNEL STATUS > PRT**Read security: 5**

Indicates the port number. There are 4 available interfaces on the Quad BRI-U Option Module.

MODULES (U-BRI-4) > CHANNEL STATUS > CHA**Read security: 5**

(Channel) Displays the status of individual channels. The following symbols may display:

-	Unallocated channel
.	Inactive channel
A	Active B channel
D	Active D channel

MODULES (U-BRI-4) > PERFORMANCE CURRENT**Write security: 3; Read security: 5**

The performance field provides status on key performance measures for each of the four Basic Rate ISDN (BRI) ports (U interfaces). These fields are all read-only.

PRT	Displays the port number.
NEBE	Near-end block errors
FEBE	Far-end block errors

MODULES (U-BRI-4) > CONFIGURATION**Write security: 3; Read security: 5**

All of the following configurable parameters apply to the individual Basic Rate ISDN (BRI) U interfaces.

MODULES (U-BRI-4) > CONFIGURATION > PRT**Read security: 5**

Displays the port number. There are 4 available interfaces on the Quad BRI-U Option Module.

MODULES (U-BRI-4) > CONFIGURATION > PORT NAME**Write security: 3; Read security: 5**

Accepts any alpha-numeric name up to 16 characters long, to uniquely identify each port on the installed module.

MODULES (U-BRI-4) > TEST**Write security: 5; Read security: 5**

These options initiate different types of tests and display test results.

MODULES (U-BRI-4) > TEST > PRT**Write security: 5; Read security: 5**

Displays the port number. There are 4 available interfaces on the Quad BRI-U Option Module.

MODULES (U-BRI-4) > TEST > LOCAL LOOPBACK**Write security: 4; Read security: 5**

Activates a local loopback of the U interface toward the network. The following options are available:

NONE	No active loopback.
LOOPBACK B1	Loops the first B channel of the interface.
LOOPBACK B2	Loops the second B channel of the interface.
LOOPBACK B1 & B2	Loops both B channels of the interface.
LOOPBACK 2B+D	Loops the entire physical interface.

MODULES MENU (QUAD BASIC RATE ISDN (S/T INTERFACE) OPTION MODULE)

The ATLAS 5500 system controller automatically detects the presence of the Quad BRI (S/T Interface) Option Module when it is installed in the system (listed as **ST-BRI-4**). To see the menus for the Quad BRI (S/T Interface) Option Module via the terminal menu, use the arrow keys to scroll to the **MODULES** menu and press <Enter> to access the module choices. Refer to the *Quad BRI (S/T Interface) Option Module Quick Start Guide* for a menu tree containing a complete listing of menus.

MODULES (ST-BRI-4) > INFO**Write security: 5; Read security: 5**

Provides information about the module part number, serial number, and assembly revision.

MODULES (ST-BRI-4) > INFO > PART NUMBER**Read security: 5**

Displays the part number of the module.

MODULES (ST-BRI-4) > INFO > SERIAL NUMBER**Read security: 5**

Displays the serial number of the module.

MODULES (ST-BRI-4) > INFO > ASSEMBLY REVISION**Read security: 5**

Displays the assembly revision of the installed module.

MODULES (ST-BRI-4) > ALARMS**Write security: 5; Read security: 5**

Displays the alarm status for each S/T interface on the installed module.

MODULES (ST-BRI-4) > ALARMS > PRT**Write security: 5; Read security: 5**

Indicates the port number. There are 4 available interfaces on the Quad BRI-S/T Option Module.

MODULES (ST-BRI-4) > ALARMS > ALARMS**Write security: 5; Read security: 5**

Displays the current alarm status of each Basic Rate ISDN (BRI) S/T interface.

L1 DOWN	A layer one alarm is indicated by an asterisk (*) when the BRI S/T physical layer is not active. An L1 alarm is present when problems are detected with the endpoint or a cabling problem.
----------------	--

MODULES (ST-BRI-4) > ALARMS > CHANNEL**Write security: 5; Read security: 5**Displays the alarm status of the bearer (B) channels and the datalink (D) channel. A hyphen (–) indicates no active channel alarm and **D** indicates an active D channel alarm.**MODULES (ST-BRI-4) > CHANNEL USAGE****Read security: 5**

Displays the channel status of the bearer (B) channels and the datalink (D) channel for each Basic Rate ISDN (BRI) S/T interface.

MODULES (ST-BRI-4) > CHANNEL USAGE > PRT**Write security: 5; Read security: 5**

Indicates the port number. There are 4 available interfaces on the Quad BRI-S/T Option Module.

MODULES (ST-BRI-4) > CHANNEL USAGE > CHA**Write security: 5; Read security: 5**

(Channel) Displays the status of individual channels. The following symbols may display:

-	Unallocated channel
.	Inactive channel
A	Active B channel
D	Active D channel

MODULES (ST-BRI-4) > CONFIGURATION**Write security: 5; Read security: 5**

Allows the user to personally identify each port with an appropriate name.

MODULES (ST-BRI-4) > CONFIGURATION > PRT**Write security: 5; Read security: 5**

Displays the port number. There are 4 available interfaces on the Quad BRI-S/T Option Module.

MODULES (ST-BRI-4) > CONFIGURATION > PORT NAME**Write security: 3; Read security: 5**

Accepts any alpha-numeric name up to 16 characters long, to uniquely identify each port on the Octal BRI

S/T Option Module.

MODULES (ST-BRI-4) > CONFIGURATION > LINE TERMINATION

Write security: 3; Read security: 5

Termination resistors in both the transmit and receive paths (100 Ω) are required (per CCITT I.430, ETSI ETS 300012, and ANSI T1.605) for all Basic Rate ISDN (BRI) S/T interfaces operating in NT mode (User Term) and TE mode (Network Term) in point-to-point applications. ANSI T1.605 provides examples of S/T interfaces configured in a multi-point NT1 star operation. The NT1 star mode allows a single NT device to support multiple T interfaces (TE devices). Custom cables are required for this type of application, and are not available for purchase (from ADTRAN) for the ATLAS 550.



This parameter should be left in the default state for most applications.

MODULES (ST-BRI-4) > CONFIGURATION > PS1 LINE POWER

Write security: 3; Read security: 5

The ATLAS 550 is capable of providing 1W (at 40 V) power on each Basic Rate ISDN (BRI) S/T interface to provide line power (phantom power) to TE equipment. Set this parameter to **ON** only if the TE equipment connected to the S/T interface requires line power.



*Do not enable line power on a BRI S/T interface configured for TE mode (Network Term). Setting this parameter to **ON** in a TE configuration (Network Term) may result in damage to the module.*

MODULES (ST-BRI-4) > TEST

Write security: 5; Read security: 5

These options initiate different types of tests and display test results.

MODULES (ST-BRI-4) > TEST > PRT

Write security: 5; Read security: 5

Identifies the port number. There are 4 available interfaces on the Quad BRI-S/T Option Module.

MODULES (ST-BRI-4) > TEST > LOCAL LOOPBACK**Write security: 4; Read security: 5**

Activates a local loopback toward the S/T interface. The following options are available:

- | | |
|-------------------------|--|
| NONE | • No active loopback. |
| LOOPBACK B1 | • Loops the first B channel of the interface. |
| LOOPBACK B2 | • Loops the second B channel of the interface. |
| LOOPBACK B1 + B2 | • Loops both B channels of the interface. |
| LOOPBACK 2B+D | • Loops the entire physical interface. |

MODULES MENU (QUAD/OCTAL FXS OPTION MODULE)

The ATLAS 550 system controller automatically detects the presence of the Quad/Octal FXS Option Modules when they are installed in the system (Quad is listed as **FXS-4** and the Octal is listed as **FXS-8**). All menus in this section that apply to both modules are listed as **FXS-4/8**. To see the menus for the Quad/Octal FXS Option Module via the terminal menu, use the arrow keys to scroll to the **MODULES** menu and press <Enter> to access the module choices. Refer to the *Quad/Octal FXS Option Module Quick Start Guide* for a menu tree containing a complete listing of menus.

MODULES (FXS-4/8) > INFO**Read security: 5**

Provides information about the module part number, serial number, and assembly revision.

MODULES (FXS-4/8) > INFO > PART NUMBER**Read security: 5**

Displays the part number of the module.

MODULES (FXS-4/8) > INFO > SERIAL NUMBER**Read security: 5**

Displays the serial number of the module.

MODULES (FXS-4/8) > INFO > ASSEMBLY REVISION**Read security: 5**

Displays the assembly revision of the module.

MODULES (FXS-4/8) > INFO > PROCESSOR ID**Read security: 5**

Displays the processor ID of the selected module.

MODULES (FXS-4/8) > STATUS**Read security: 5**

Displays the status of each of the FXS ports.

MODULES (FXS-4/8) > STATUS > PRT**Read security: 5**

Indicates the port number. There are 4 available interfaces on the Quad FXS Option Module and 8 on the Octal FXS Option Module.

MODULES (FXS-4/8) > STATUS > STATUS**Read security: 5**

Displays the call status of each voice port. This field may display the following:

IDLE	The FXS port is in an idle state for LS configurations, and tip is grounded in GS configurations.
RING GROUND	The FXS port has detected ring ground.
OFF HOOK	The FXS port has detected an off hook condition (loop current flowing).
REVERSE BATTERY	The FXS port has reversed T/R polarity.
RINGING	The FXS port is detecting ringing condition on the interface.
TIP-OPEN	The FXS port tip conductor is high impedance. This is an idle condition for GS trunks.
UNKNOWN	No information about the FXS port is available.
INACTIVE	The port is preconfigured, but the FXS module is not present.
AVAILABLE	The FXS port is present and available for use.
NOT AVAILABLE	The FXS port is present, but not available for use.
DISABLED	The FXS module is present, but the port is not mapped.
TEST	This generic FXS port test indicator is used when multiple tests are being run or the test is not a 2W test.
ACTIVE	Active test is currently running.
OFF HOOK	Active/Reverse Battery test is running, but an off hook condition is detected.
RINGING	Ringing test is currently running.
REV. BAT	Reverse Battery test is currently running.
TIP OPEN	Tip Open test is currently running.
RING GND	Tip Open test is currently running, but ring ground is detected.
DISABLED	An active test is running on an FXS port that is not currently mapped.
(-R) TRIP	Ringing test is currently running, but an off hook condition is detected.

MODULES (FXS-4/8) > STATUS > RX ABCD**Read security: 5**

Receive Signaling bits have local significance only, and represent signaling between the ATLAS 550

Controller and the voice port if the port is configured in the **DIAL PLAN**. The bit pattern is formatted **ESF RBS**.

MODULES (FXS-4/8) > STATUS > TX ABCD

Read security: 5

Transmit Signaling bits have local significance only, and represent signaling between the ATLAS 550 Controller and the voice port if the port is configured in the **DIAL PLAN**. The bit pattern is formatted **ESF RBS**.

MODULES (FXS-4/8) > TEST

Write security: 4; Read security: 5

These options initiate different types of tests and display test results.

MODULES (FXS-4/8) > TEST > PORT

Write security: 5; Read security: 5

Displays the operating port. There are 4 available interfaces on the Quad FXS Option Module and 8 on the Octal FXS Option Module.

MODULES (FXS-4/8) > TEST > TEST 2W

Write security: 4; Read security: 5

Activates 2W (FXS) tests on a per-port basis. Options include **OFF**, **ACTIVE**, **TIP OPEN**, **REV. BATTERY**, **DISABLED**, and **RINGING**. The 2W tests will disrupt the active call on the selected FXS port. Table 3 displays the state of the 2W conductors during each test.

Table 3. FXS 2W State Table

TEST	TIP OUTPUT	RING OUTPUT
Off	No test active	No test active
Active	Ground	Supervision voltage
Tip Open	High impedance	Supervision voltage
Rev. Battery	Supervision voltage	Ground
Disabled*	High impedance	High impedance
Ringling	Ringling voltage	Ringling voltage

* Disables the output of the FXS port; it does not disable the test.

MODULES (FXS-4/8) > TEST > TX ABCD**Write security: 4; Read security: 5**

Forces the Transmit Robbed Bit Signaling (Tx RBS) to a specified value. Values include **OFF**, **0000**, **0101**, **1010**, or **1111**.



*Calls may be affected when activating the Tx ABCD test. This test is not valid when the port is used in the **DIAL PLAN**.*

MODULES (FXS-4/8) > TEST > 1KHZ TONE**Write security: 3; Read security: 5**

Sends a 1kHz tone into the following locations, based on test selection: **NEAR** sends the tone out the FXS port, while **FAR** sends the tone into the digital PCM stream of the ATLAS 550 controller. These tests are useful for verifying a voice path.

MODULES (FXS-4/8) > TEST > LOOPBACK**Write security: 3; Read security: 5**

Activates loopback tests on a per-port basis.

OFF	Normal operation.
ANALOG	Loops the 2W test on itself.
DIGITAL	Loops digital data entering the FXS from the ATLAS controller on itself.
BOTH	Processes both analog and digital loopback tests.



Loopback tests disrupt the call in progress on the selected FXS port.

MODULES (FXS-4/8) > CONFIG**Write security: 3; Read security: 5**

All of the following configurable parameters apply to the individual FXS ports.

MODULES (FXS-4/8) > CONFIG > PRT**Read security: 5**

Displays the port number. There are 4 available interfaces on the Quad FXS Option Module and 8 on the Octal FXS Option Module.

MODULES (FXS-4/8) > CONFIG > PORT NAME**Write security: 3; Read security: 5**

Accepts any alpha-numeric name up to 16 characters long, to uniquely identify each port on the FXS Option Module.

MODULES (FXS-4/8) > CONFIG > RX GAIN

Write security: 3; Read security: 5

Adjusts the (+)Gain and (-)Attenuation of the relative signal received by the FXS. The range includes **0** (loudest), **-3**, and **-6dB** (softest).

MODULES (FXS-4/8) > CONFIG > TX GAIN

Write security: 3; Read security: 5

Adjusts the (+)Gain and (-)Attenuation of a digital signal transmitted by the FXS into the digital PCM stream. The range includes **+3** (loudest), **0**, **-3**, and **-6 dB** (softest).



When the digital signal is connected through the PSTN, a setting of -3 dB should be used.

MODULES (FXS-4/8) > CONFIG > 2W IMPEDANCE

Read security: 5

2-wire input impedance is set to **600 Ω +2.16 μF**. This is a read-only field.

MODULES (FXS-4/8) > CONFIG > CODING SCHEME

Read security: 5

Displays the current PCM coding scheme. Currently only **μ-LAW** is supported.

MODULES MENU (QUAD/OCTAL FXO OPTION MODULE)

The ATLAS 550 system controller automatically detects the presence of the Octal/Quad FXO Option Module when they are installed in the system (Quad is listed as **FXO-4** and the Octal is listed as **FXO-8**). All menus in this section that apply to both modules are listed as **FXS-4/8**. To see the menus for the Octal/Quad FXO Option Module via the terminal menu, use the arrow keys to scroll to the **MODULES** menu and press <Enter> to access the module choices. Refer to the *Quad/Octal FXO Option Module Quick Start Guide* for a menu tree containing a complete listing of menus.

MODULES (FXO-4/8) > INFO

Read security: 5

Provides information about the module part number, serial number, and assembly revision.

MODULES (FXO-4/8) > INFO > PART NUMBER

Read security: 5

Displays the part number of the module.

MODULES (FXO-4/8) > INFO > SERIAL NUMBER

Read security: 5

Displays the serial number of the module.

MODULES (FXO-4/8) > INFO > ASSEMBLY REVISION**Read security: 5**

Displays the assembly revision of the module.

MODULES (FXO-4/8) > INFO > FIRMWARE REVISION**Read security: 5**

Displays the current firmware revision of the selected module.

MODULES (FXO-4/8) > INFO > PROCESSOR ID**Read security: 5**

Displays the processor ID of the selected module.

MODULES (FXO-4/8) > STATUS**Read security: 5**

Displays the status of each of the FXO ports.

MODULES (FXO-4/8) > STATUS > PRT**Read security: 5**

Indicates the port number. There are 4 available interfaces on the Quad FXO Option Module and 8 on the Octal FXO Option Module.

MODULES (FXO-4/8) > STATUS > STATUS**Read security: 5**

Displays the call status of each voice port. This field may display the following:

IDLE	The FXO port is in an idle state for LS configurations, and tip is grounded in GS configurations.
RING GROUND	The FXO port has detected ring ground.
OFF HOOK	The FXO port has detected an off hook condition (loop current flowing).
REVERSE BATTERY	The FXO port has reversed T/R polarity.
RINGING	The FXO port is detecting ringing condition on the interface.
TIP-OPEN	The FXO port tip conductor is high impedance. This is an idle condition for GS trunks.
UNKNOWN	No information about the FXO port is available.
INACTIVE	The port is preconfigured, but the FXO module is not present.
AVAILABLE	The FXO port is present and available for use.
NOT AVAILABLE	The FXO port is present, but not available for use.
DISABLED	The FXO module is present, but the port is not mapped.
TEST	This generic FXO port test indicator is used when multiple tests are being run or the test is not a 2W test.

LO	Loop open test is currently running.
LC-T/R OK	Loop closed test is currently running and normal T/R polarity is detected.
LC-No BATTERY	Loop closed test is currently running and no loop batter is detected.
LC-T/R ROLLED	Loop closed test is currently running and reverse T/R polarity is detected.
RING GND	Tip Open test is currently running, but ring ground is detected.

MODULES (FXO-4/8) > STATUS > RX ABCD

Read security: 5

Receive Signaling bits have local significance only, and represent signaling between the ATLAS 550 Controller and the voice port if the port is configured in the **DIAL PLAN**. The bit pattern is formatted **ESF RBS**.

MODULES (FXO-4/8) > STATUS > Tx ABCD

Read security: 5

Transmit Signaling bits have local significance only, and represent signaling between the ATLAS 550 Controller and the voice port if the port is configured in the **DIAL PLAN**. The bit pattern is formatted **ESF RBS**.

MODULES (FXO-4/8) > TEST

Write security: 4; Read security: 5

The **TEST** options initiate different types of tests and display test results.

MODULES (FXO-4/8) > TEST > PORT

Write security: 5; Read security: 5

Displays the operating port. There are 4 available interfaces on the Quad FXO Option Module and 8 on the Octal FXO Option Module.

MODULES (FXO-4/8) > TEST > TEST 2W

Write security: 4; Read security: 5

Activates 2W (FXO) tests on a per-port basis. Options include **OFF**, **LOOP OPEN**, **LOOP CLOSED**, and **RING GROUND**. The 2W tests will disrupt the active call on the selected FXO port. Table 3 displays the state of the 2W conductors during each test.

Table 4. FXO 2W State Table

TEST	TIP OUTPUT	RING OUTPUT
Off	No test active	No test active
Loop Open	High impedance	High impedance
Loop Closed	Off-hook impedance	Off-hook impedance
Ring Ground	High impedance	R to ground

MODULES (FXO-4/8) > TEST > TX ABCD**Write security: 4; Read security: 5**

Forces the Transmit Robbed Bit Signaling (Tx RBS) to a specified value. Values include **OFF**, **0000**, **0101**, **1010**, or **1111**.



*Calls may be affected when activating the Tx ABCD test. This test is not valid when the port is used in the **DIAL PLAN**.*

MODULES (FXO-4/8) > TEST > 1KHZ TONE**Write security: 3; Read security: 5**

Sends a 1kHz tone into the following locations, based on test selection: **NEAR** sends the tone out the 2W FXO port, while **FAR** sends the tone into the digital PCM stream of the ATLAS 550 controller. These tests are useful for verifying a voice path.

MODULES (FXO-4/8) > TEST > LOOPBACK**Write security: 3; Read security: 5**

Activates loopback tests on a per-port basis.

OFF	Normal operation.
ANALOG	Loops the 2W test on itself.
DIGITAL	Loops digital data entering the FXO from the ATLAS controller on itself.
BOTH	Processes both analog and digital loopback tests.



Loopback tests disrupt the call in progress on the selected FXO port.

MODULES (FXO-4/8) > CONFIG**Write security: 3; Read security: 5**

All of the following configurable parameters apply to the individual FXO ports.

MODULES (FXO-4/8) > CONFIG > PRT**Read security: 5**

Displays the port number. There are 4 available interfaces on the Quad FXO Option Module and 8 on the Octal FXO Option Module.

MODULES (FXO-4/8) > CONFIG > PORT NAME**Write security: 3; Read security: 5**

Accepts any alpha-numeric name up to 16 characters long, to uniquely identify each port on the FXO

Option Module.

MODULES (FXO-4/8) > CONFIG > RX GAIN

Write security: 3; Read security: 5

Adjusts the (+)Gain and (-)Attenuation of the relative signal received by the FXO port (Digital-to-Analog). The range includes **0** (loudest), **-3**, and **-6dB** (softest).

MODULES (FXO-4/8) > CONFIG > TX GAIN

Write security: 3; Read security: 5

Adjusts the (+)Gain and (-)Attenuation of a digital signal transmitted by the FXO into the digital PCM stream. The range includes **+3** (loudest), **0**, **-3**, and **-6 dB** (softest).

NOTE

*When the digital signal is connected through the PSTN, a setting of **-3 dB** should be used.*

MODULES (FXO-4/8) > CONFIG > 2W IMPEDANCE

Read security: 5

2-wire input impedance is set to **600 Ω +2.16 μF**. This is a read-only field.

MODULES (FXO-4/8) > CONFIG > CODING SCHEME

Read security: 5

Displays the current PCM coding scheme. Currently only **μ-LAW** is supported.

MODULES MENU (OCTAL E&M OPTION MODULE)

The ATLAS 550 system controller automatically detects the presence of the Octal E&M Option Module when it is installed in the system (listed as **E&M-8**). To see the menus for the Octal E&M Option Module via the terminal menu, use the arrow keys to scroll to the **MODULES** menu and press <Enter> to access the module choices. Refer to the *Octal E&M Option Module Quick Start Guide* for a menu tree containing a complete listing of menus.

MODULES (E&M-8) > INFO > PART NUMBER

Read security: 5

Displays the part number of the module.

MODULES (E&M-8) > INFO > SERIAL NUMBER

Read security: 5

Displays the serial number of the module.

MODULES (E&M-8) > INFO > ASSEMBLY REVISION**Read security: 5**

Displays the assembly revision of the module.

MODULES (E&M-8) > INFO > FIRMWARE REVISION**Read security: 5**

Displays the current firmware revision of the selected module.

MODULES (E&M-8) > INFO > PROCESSOR ID**Read security: 5**

Displays the processor ID of the selected module.

MODULES (E&M-8) > STATUS**Read security: 5**

Displays the status of each of the eight E&M ports.

MODULES (E&M-8) > STATUS > PRT**Read security: 5**

Displays the operating port number. There are eight available ports on the Octal E&M Option Module

MODULES (E&M-8) > STATUS > STATUS**Read security: 5**

Displays the call status of each voice port. This field displays one of the following messages:

INACTIVE	The port is pre-configured, but the E&M module is not present.
DISABLED	The E&M module is present, but the port is not mapped.
UNKNOWN	Information about the port is not available.
IDLE	The selected trunk is configured but currently not in use.
E-LEAD ASSERTED	The E-Lead is asserted, indicating a far-end seizure.
M-LEAD ASSERTED	An M-Lead current has been detected, indicating a near-end seizure.
TO	The port is configured for Transmission Only mode.
CALL IN PROGRESS	Indicates there is a current, active call on the selected E&M port.
TEST E-LEAD OPEN	Forces an on-hook situation for testing purposes.
TEST E-LEAD CLOSED	Forces an off-hook situation for testing purposes.
TEST	Generic test indicator.
TEST-UNKNOWN	The port is in test mode, but additional information about the active test is not available.

MODULES (E&M-8) > STATUS > Rx ABCD**Read security: 5**

Receive Signaling bits have local significance only, and represent signaling between the ATLAS 550 Controller and the voice port if the port is configured in the **DIAL PLAN**. The bit pattern is formatted **ESF RBS**.

MODULES (E&M-8) > STATUS > Tx ABCD**Read security: 5**

Transmit Signaling bits have local significance only, and represent signaling between the ATLAS 550 Controller and the voice port if the port is configured in the **DIAL PLAN**. The bit pattern is formatted **ESF RBS**.

MODULES (E&M-8) > TEST**Write security: 4; Read security: 5**

These options initiate different types of tests and display test results.

MODULES (E&M-8) > TEST > PORT**Write security: 5; Read security: 5**

Displays the operating port.

MODULES (E&M-8) > TEST > TEST 2W**Write security: 4; Read security: 5**

Activates 2W (E&M) tests on a per-port basis. Options include **OFF** (no tests are active), **E-LEAD OPEN**, and **E-LEAD CLOSED**. The 2W tests will disrupt the active call on the selected E&M port. Table 5 displays the state of the 2W conductors during each test.

Table 5. E&M 2W State Table

TEST	MODULE OUTPUT
Off	E-lead follows the Rx (received) signaling bits
E-Lead Open	Forces an on-hook situation on the port
E-Lead Closed	Forces an off-hook situation on the port

MODULES (E&M-8) > TEST > TX ABCD**Write security: 4; Read security: 5**

Forces the Transmit Robbed Bit Signaling (Tx RBS) to a specified value. Values include **OFF**, **0000**, **0101**, **1010**, or **1111**.



*Calls may be affected when activating the Tx ABCD test. This test is not valid when the port is used in the **DIAL PLAN**.*

MODULES (E&M-8) > TEST > 1KHZ TONE**Write security: 3; Read security: 5**

Sends a 1kHz tone into the following locations, based on test selection: **NEAR** sends the tone out the E&M VF port, while **FAR** sends the tone into the digital PCM stream of the ATLAS 550 controller. These tests are useful for verifying a voice path.

MODULES (E&M-8) > TEST > LOOPBACK**Write security: 3; Read security: 5**

Activates loopback tests on a per-port basis.

OFF	Normal operation.
ANALOG	Loops the 2W test on itself.
DIGITAL	Loops digital data entering the E&M from the ATLAS controller on itself.

WARNING

Loopback tests disrupt the call in progress on the selected E&M port.

MODULES (E&M-8) > CONFIG**Write security: 3; Read security: 5**

All of the following configurable parameters apply to the individual E&M ports.

MODULES (E&M-8) > CONFIG > PORT**Read security: 5**

Displays the port number.

MODULES (E&M-8) > CONFIG > PORT NAME**Write security: 3; Read security: 5**

Accepts any alpha-numeric name up to 16 characters long, to uniquely identify each port on the Octal E&M Option Module.

MODULES (E&M-8) > CONFIG > SIG IFCE**Write security: 3; Read security: 5**

Selects signaling interface operation. The module supports all E&M types (**TYPE I** through **TYPE V**), as well as Transmission Only (**TO**) mode. Press-to-talk (**PTT**) mode is functionally identical to the E&M **TYPE V** mode.

MODULES (E&M-8) > CONFIG > VF IFCE**Write security: 3; Read security: 5**

Selects either 4-wire or 2-wire output at the VF interface. The range includes **+6 dB** (loudest) to **-12 dB** (softest).

MODULES (E&M-8) > CONFIG > RX GAIN**Write security: 3; Read security: 5**

Adjusts the level of the signal output at the VF interface. The range includes **+6 dB** (loudest) to **-12 dB** (softest).

MODULES (E&M-8) > CONFIG > TX GAIN**Write security: 3; Read security: 5**

Adjusts the encoded level of the signal transmitted by the module into the digital PCM stream toward the network. The range includes **+6 dB** (loudest) to **-12 dB** (softest).



*When the digital signal is connected through the PSTN, a setting of **-3 dB** should be used.*

MODULES (E&M-8) > CONFIG > CODING SCHEME**Read security: 5**

Displays the current PCM coding scheme. Currently only **μ-LAW** is supported.

MODULES MENU (LEGACY DATA OPTION MODULE)

The ATLAS 550 system controller automatically detects the presence of the Legacy Data Option Module when they are installed in the system (listed as **LEGACY-4**). To see the menus for the Legacy Data Option Module via the terminal menu, use the arrow keys to scroll to the **MODULES** menu and press <Enter> to access the module choices. Refer to the *Legacy Data Option Module Quick Start Guide* for a menu tree containing a complete listing of menus.

MODULES (LEGACY-4) > INFO > PART NUMBER**Read security: 5**

Displays the part number of the module.

MODULES (LEGACY-4) > INFO > SERIAL NUMBER**Read security: 5**

Displays the serial number of the module.

MODULES (LEGACY-4) > INFO > ASSEMBLY REVISION**Read security: 5**

Displays the assembly revision of the module.

MODULES (LEGACY-4) > INFO > FIRMWARE REVISION**Read security: 5**

Displays the current firmware revision of the selected module.

MODULES (LEGACY-4) > INFO > PROCESSOR ID**Read security: 5**

Displays the processor ID of the selected module.

MODULES (LEGACY-4) > SIGNAL STATUS**Read security: 5**

Shows the status of key DTE interface signals. An asterisk (*) indicates the presence of a signal and a hyphen (-) indicates no signal present.

MODULES (LEGACY-4) > SIGNAL STATUS > PORT**Read security: 5**

Displays the operating port number. There are four available ports on the Legacy Data Option Module.

MODULES (LEGACY-4) > SIGNAL STATUS > DTE SIGNALS**Read security: 5**

The following signals are monitored (these options are read-only):

DTR	Data terminal ready from DTE	DCD	Data carrier detect to DTE
DSR	Data set ready to DTE	CTS	Clear to send to DTE
RTS	Request to send from DTE		

MODULES (LEGACY-4) > PORT STATS**Write security: 5; Read security: 5**

Shows statistics for each port of the Legacy Data Option Module including a frame count of transmitted and received frames, errors, and async/sync statistics.

MODULES (LEGACY-4) > PORT STATS > PRT**Read security: 5**

Displays the operating port number. There are four available ports on the Legacy Data Option Module.

MODULES (LEGACY-4) > PORT STATS > CLR**Write security: 3; Read security: 5**

Clears all statistics for the selected port of the Legacy Data Option Module.

MODULES (LEGACY-4) > PORT STATS > FR IN**Read security: 5**

(Frames In) Displays the total received frames since the last reset.

MODULES (LEGACY-4) > PORT STATS > FR OUT**Read security: 5**

(Frames Out) Displays the total transmitted frames since the last reset.

MODULES (LEGACY-4) > PORT STATS > ERR FR**Read security: 5**

(Errored Frames) Displays the total errored received frames since the last reset.

MODULES (LEGACY-4) > PORT STATS > OVER ERR**Read security: 5**

(Overrun Errors) Displays a count of the receive FIFO (first in first out) buffer overrun frames. Overrun frames indicate that the external clock for the port may be too fast.

MODULES (LEGACY-4) > PORT STATS > DCD LOSS ERR**Read security: 5**

(DCD Loss Errors) Displays the total time the data carrier detect signal on the port was lost since the last reset.

MODULES (LEGACY-4) > PORT STATS > ASYNC/SYNC STATS**Read security: 5**

Displays additional statistics for ports configured for Async operation.

MODULES (LEGACY-4) > PORT STATS > ASYNC/SYNC STATS > FR ERR**Read security: 5**

(Errored Frames) Displays the total errored received frames since the last reset.

MODULES (LEGACY-4) > PORT STATS > ASYNC/SYNC STATS > PAR ERR**Read security: 5**

(Parity Errors) Displays the total number of received frames containing parity errors.

MODULES (LEGACY-4) > PORT STATS > ASYNC/SYNC STATS > BREAKS**Read security: 5**

Displays the total number of async break characters received on the port.

MODULES (LEGACY-4) > TEST > PRT**Read security: 5**

Displays the operating port number. There are four available ports on the Legacy Data Option Module.

MODULES (LEGACY-4) > TEST > DTE LOCAL LOOPBACK**Write security: 4; Read security: 5**

Initiates a DTE local loopback towards the user equipment at the DB-78 port. When **ENABLED**, all data

received from the DTE will be echoed back to the DTE.



Enabling this test will disrupt data flow on the selected port.

MODULES MENU (NXT1 HSSI AND NXT1 HSSI/V.35 OPTION MODULES)

The ATLAS 550 system controller automatically detects the presence of the NxT1 HSSI and NxT1 HSSI/V.35 Option Modules when they are installed in the system (NxT1 HSSI listed as **NxT1 HSSI** and NxT1 HSSI/V.35 listed as **NxHSSV35**). All menus listed below as **NxT1 HSSI** apply to both the NxT1 HSSI and NxT1 HSSI/V.35 Option Modules unless otherwise specified. To see the menus for the NxT1 HSSI and NxT1 HSSI/V.35 Option Modules via the terminal menu, use the arrow keys to scroll to the **MODULES** menu and press <Enter> to access the module choices. V.35 is available (on the 1200346L2 module only) when using the optional adapter cable (ADTRAN P/N 3125I081). Some of the following menus do not apply when configured for V.35 mode. Refer to the *NxT1 HSSI/V.35 Option Module Quick Start Guide* for a menu tree containing a complete listing of menus.

MODULES (NXT1 HSSI) > INFO

Read security: 5

Provides information about the module part number, serial number, and board revision.

MODULES (NXT1 HSSI) > INFO > PART NUMBER

Read security: 5

Displays the part number of the module.

MODULES (NXT1 HSSI) > INFO > SERIAL NUMBER

Read security: 5

Displays the serial number of the module.

MODULES (NXT1 HSSI) > INFO > ASSEMBLY REVISION

Read security: 5

Displays the assembly revision of the installed module.

MODULES (NXT1 HSSI) > INFO > FIRMWARE REVISION

Read security: 5

Displays the firmware revision of the installed module.

MODULES (NXT1 HSSI) > T1 MENUS

Read security: 5

Provides information about the four T1 interfaces located on the NxT1 HSSI and NxT1 HSSI/V.35 Option Modules.

MODULES (NXT1HSSI) > T1 MENUS > ALARM STATUS**Read security: 5**

Displays the current alarm status for each of the built-in T1 ports located on the NxT1 HSSI and NxT1 HSSI/V.35 Option Modules.

MODULES (NXT1HSSI) > ALARM STATUS > PRT**Read security: 5**

Indicates the operating port number for the selected T1 interface. There are four available T1 interfaces on the NxT1 HSSI and NxT1 HSSI/V.35 Option Modules.

MODULES (NXT1HSSI) > ALARM STATUS > ALARMS**Read security: 5**

Provides a listing of possible alarm conditions on the T1 interface. An asterisk (*) indicates the presence of an alarm condition and a hyphen (-) indicates no active alarm. The following alarms are monitored:

LOS	Indicates a loss of signal detected on the port interface.
RED	Indicates the inability to frame data received on the port. Alternately referred to as Out of Frame (OOF).
YELLOW	Receiving a remote alarm (RAI) on the interface from the far end.
BLUE	Receiving unframed all ones from the port Alarm Indicator Signal (AIS).
DS0 ALARM	Displays per-DS0 alarm status; that is, at least one DS0 channel is in alarm if an asterisk (*) appears. These alarms usually indicate the failure to receive the protocol that has been configured for the DS0.

MODULES (NXT1HSSI) > ALARM STATUS > RX LEVEL**Read security: 5**

(Receive Level) Indicates the strength of the signal received on the port (in dB).

MODULES (NXT1HSSI) > PERFORMANCE CURRENT**Write security:3; Read security: 5**

The performance fields (either current, 15-minute total, or 24-hour total) provide status on key performance measures as specified in ANSI T1.403 and AT&T TR54016 for the T1/PRI port. Except for **CLR**, these fields are all read-only. The monitored parameters include the following:

PRT	Displays the port number
CLR	Clears performance information for the selected port
ES	Errored Second (ES) is a second with one or more error events OR one or more Out Of Frame events OR one or more Controlled Slips
BES	Bursty Errored Second (BES) is a second with more than one, but less than 320 error events
SES	Severely Errored Second (SES) is a second with 320 or more error events OR one or more Out Of Frame events

SEFS	Severely Errored Frame Second is a second that contains four consecutive errored framing patterns.
LOFC	Loss of Frame Count is a count of seconds in which a valid framing pattern could not be obtained.
CSS	Controlled Slip Second
UAS	Unavailable Second
LCV	Line Code Violation
PCV	Path Code Violation
LES	Line Errored Second

MODULES (NXT1HSSI) > PERFORMANCE 15MIN

Write security:3; Read security: 5

Stores the performance data for the previous 15-minute window. Refer to *Modules (NxT1HSSI) > Performance Current* for a detailed description of these fields.

MODULES (NXT1HSSI) > PERFORMANCE 24HR

Write security:3; Read security: 5

Stores the performance data for the previous 24-hour window. Refer to *Modules (NxT1HSSI) > Performance Current* for a detailed description of these fields.

MODULES (NXT1HSSI) > CONFIGURATION

Write security:3; Read security: 5

All of the following configurable parameters apply to whether the port is connected to a Primary Rate ISDN circuit or a channelized T1 circuit.

MODULES (NXT1HSSI) > CONFIGURATION > PORT

Read security: 5

Displays the operating port number. There are four available T1 ports on the NxT1 HSSI and NxT1 HSSI/V.35 Option Modules.

MODULES (NXT1HSSI) > CONFIGURATION > PORT NAME

Write security: 3; Read security: 5

Accepts any alpha-numeric name up to 16 characters long, to uniquely identify each T1 port on the NxT1 HSSI and NxT1 HSSI/V.35 Option Modules.

MODULES (NXT1HSSI) > CONFIGURATION > FRAME

Write security: 2; Read security: 5

This field must be set to match the frame format of the circuit to which it is connected, available from the network supplier. Choose either **D4** or **ESF**.

MODULES (NXT1HSSI) > CONFIGURATION > CODE**Write security: 2; Read security: 5**

Set this field to match the line code of the circuit to which it is connected (this information is available from the network supplier). Choose either **AMI** (Alternate Mark Inversion) or **B8ZS** (Bipolar Eight Zero Substitution).

MODULES (NXT1HSSI) > CONFIGURATION > TX YEL**Write security: 3; Read security: 5**

Controls the transmission of yellow alarms. Choose either **ON** or **OFF**.

MODULES (NXT1HSSI) > CONFIGURATION > LBO**Write security: 2; Read security: 5**

Selects the Line Build Out (LBO) for the network interface. When connecting an ATLAS 550 port to a DSX-1 interface, this parameter is typically set to match the distance (in feet) between the ATLAS 550 and the device with which it is connecting. When you select this item, a list of choices displays (**0 dB, -7.5 dB, -15 dB, -22 dB, 266 FT, 399 FT, 533 FT, 655 FT**). Select the appropriate option.

MODULES (NXT1HSSI) > TEST**Write security: 5; Read security: 5**

These options initiate different types of tests and display test results.

MODULES (NXT1HSSI) > TEST > PORT**Read security: 5**

Displays the operating port number. There are four available T1 interfaces on the NxT1 HSSI and NxT1 HSSI/V.35 Option Modules.

MODULES (NXT1HSSI) > TEST > LOC LB**Write security: 4; Read security: 5**

Initiates a loopback on near-end (local) port (see Figure 12). The following options are available:

LINE	Metallic loopback
PAYLD	Payload loopback - framing and clocking are regenerated

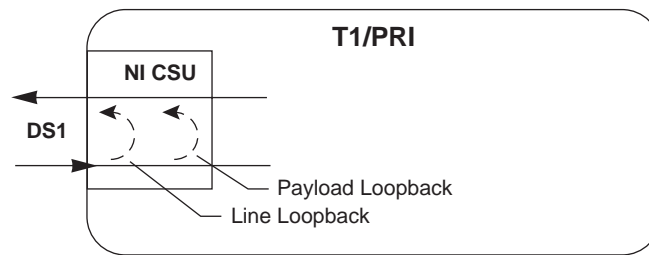

Figure 12. T1/PRI Loopback Test Diagram

MODULES (NXT1HSSI) > IMUX MENUS

Read security: 5

Contains the inverse muxing configuration parameters for the NxT1 HSSI Option Module.

MODULES (NXT1HSSI) > IMUX MENUS > STATUS

Read security: 5

Displays status information for the T1 data streams mapped to the HSSI interface.

MODULES (NXT1HSSI) > IMUX MENUS > STATUS > PORT

Read security: 5

Indicates the port number. Displays the port number for the T1s mapped to the HSSI interface. Ports 1 through 4 are the T1 interfaces located on the NxT1 HSSI or NxT1 HSSI/V.35 Option Modules. Ports 5 through 8 are T1s mapped to the NxT1 HSSI or NxT1 HSSI/V.35 Option Modules in the **DEDICATED MAPS**.

MODULES (NXT1HSSI) > IMUX MENUS > STATUS > LINK

Read security: 5

Displays status information for the T1 data streams mapped to the HSSI interface. The following status messages may be displayed:

IN TEST	The T1 interface originating the T1 data stream is in test mode.
IN ALARM	The T1 interface originating the T1 data stream is in test mode.
OK	The T1 data stream is performing normal operation.
INACTIVE	The T1 data stream is not mapped to the HSSI interface.

MODULES (NXT1HSSI) > IMUX MENUS > CONFIG

Write security: 5; Read security: 5

Contains parameters to include T1 data streams to the HSSI interface.

MODULES (NXT1HSSI) > IMUX MENUS > CONFIG > PORT**Read security: 5**

Indicates the port number. Displays the port number for the T1s mapped to the HSSI interface. Ports 1 through 4 are the T1 interfaces located on the NxT1 HSSI or NxT1 HSSI/V.35 Option Module. Ports 5 through 8 are T1s mapped to the NxT1 HSSI or NxT1 HSSI/V.35 Option Module in the **DEDICATED MAPS**.

MODULES (NXT1HSSI) > IMUX MENUS > CONFIG > GRP ASSOC

(Group Association) Associates T1s (either mapped to this card and/or the on-board T1s) with the HSSI interface data stream. To add the T1 to the data stream, select the **GROUP1** option.

MODULES (NXT1HSSI) > IMUX MENUS > CONFIG > SCRAMBLE

Enabling the **SCRAMBLE** option configures the NxT1 HSSI Module to prevent ones density violations when transmitting ADTRAN IMUX headers on a T1 circuit with AMI line coding.



*Use extreme caution when disabling the **SCRAMBLE** option. ADTRAN recommends enabling the **SCRAMBLE** option for normal use.*

MODULES (NXT1HSSI) > HSSI MENUS**Read security: 5**

Provides status, configuration, and testing parameters for the 50-pin SCSI-II HSSI interface.

MODULES (NXT1HSSI) > HSSI MENUS > STATUS**Read security: 5**

Displays the current status of the HSSI interface.

MODULES (NXT1HSSI) > HSSI MENUS > STATUS > PORT**Read security: 5**

Indicates the operating port number. There is one available HSSI interface on the NxT1 HSSI and NxT1 HSSI/V.35 Option Modules.

MODULES (NXT1HSSI) > HSSI MENUS > STATUS > IFCE TYPE**Read security: 5**

(Interface Type) Displays the current configuration of the module interface as either **HSSI**, **V.35**, or **UNKNOWN**. The V.35 interface is only available using the NxT1 HSSI/V.35 Option Module (P/N 1200346L2).

MODULES (NXT1HSSI) > HSSI MENUS > STATUS > LOOPBACK**Read security: 5**

Displays the current loopback status of the HSSI interface. The following loopback status messages may

The following loopback status messages may display:

LOCAL DTE LOOPBACK	A local DTE Loopback occurs at the DTE port of the DCE, and is used to test the link between the DTE and the DCE (NxT1 HSSI or NxT1 HSSI/V.35 Option Modules).
LOCAL LINE LOOPBACK	A local line loopback occurs in the IMUX engine and is used to test functionality between the DTE and the IMUX engine.
REMOTE LINE LOOPBACK	A remote line loopback occurs at the T1 interface and is used to test functionality between the DTE and the T1 interfaces.

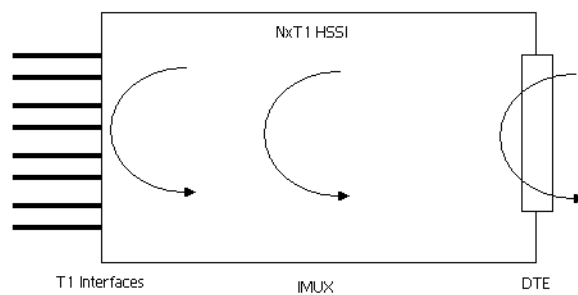

Figure 13. HSSI Interface Loopback Test Diagram

MODULES (NXT1HSSI) > HSSI MENUS > STATUS > CA**Read security: 5**

(Not applicable when using the NxT1 HSSI/V.35 Option Module - P/N 1200346L2.) Displays the status of the data Communications equipment Available (CA) signal from the DCE. CA will be asserted by the DCE, independently of TA, when the DCE is prepared to both send and receive data to and from the DTE. This indicates that the DCE has obtained a valid data communications channel. Data transmission should not commence until TA has also been asserted by the DTE.

MODULES (NXT1HSSI) > HSSI MENUS > STATUS > LA AND LB**Read security: 5**

Displays the status of the loopback circuit A and B signals. LA and LB are asserted by the DTE to enable a loopback on the DCE and its associated data communications channel. There are four loopback options:

LA	LB	LOOPBACK
Off	Off	No Loopback Active
On	On	Local DTE Loopback is Active
On	Off	Local Line Loopback is Active
Off	On	Remote Line Loopback is Active

MODULES (NXT1HSSI) > HSSI MENUS > STATUS > LC**Read security: 5**

Displays the status of the loopback circuit C signal. LC is an optional loopback request signal from the DCE to the DTE, requesting the DTE to provide a loopback path to the DCE.

MODULES (NXT1HSSI) > HSSI MENUS > STATUS > TA**Read security: 5**

Displays the status of the data Terminal equipment **AVAILABLE** signal. TA will be asserted by the DTE (independently of CA) when the DTE is prepared to both send and receive data to and from the DCE. Valid data transmission should not commence until CA has also been asserted by the DCE. If the data communications channel requires a keep alive data pattern when the DTE is disconnected, then the DCE shall supply this pattern while TA is de-asserted.

When using the NxT1 HSSI Module (1200346L2 only) in V.35 mode, TA displays the status of the Request to Send (**RTS**) signal. When RTS is active in a V.35 configuration, Clear to Send (**CTS**) is also active.

MODULES (NXT1HSSI) > HSSI MENUS > STATUS > RX RATE**Read security: 5**

Displays the current average receive data rate on the HSSI interface.

MODULES (NXT1HSSI) > HSSI MENUS > STATUS > TX RATE**Read security: 5**

Displays the current average transmit data rate on the HSSI interface.

MODULES (NXT1HSSI) > HSSI MENUS > CONFIG**Write security: 5; Read security: 5**

Provides configuration parameters for the HSSI interface including data clocking.



When using the NxT1 HSSI/V35 Module in V.35 mode, Data Set Ready (DSR) and Data Carrier Detect (DCD) are always active.

MODULES (NXT1HSSI) > HSSI MENUS > CONFIG > PORT NAME**Read security: 5**

Accepts any alpha-numeric name up to 16 characters long, to uniquely identify the HSSI interface on the NxT1 HSSI and NxT1 HSSI/V.35 Option Modules

MODULES (NXT1HSSI) > HSSI MENUS > CONFIG > TX CLK**Write security: 5; Read security: 5**

Controls the clock used by the NxT1 HSSI/V.35 Module to accept the transmit (TX) data from the DTE. This is usually set to **NORMAL**. If the interface cable is long, causing a phase shift in the data, the clock can be set to **INVERTED**. This switches the phase of the clock, which compensates for a long cable.

MODULES (NXT1HSSI) > HSSI MENUS > CONFIG > CTS (V.35)**Write security: 5; Read security: 5**

(Available only on the NxT1 HSSI/V.35 Option Module - P/N 1200346L2.) Determines the behavior of the Clear To Send (CTS) signal. If set to **NORMAL**, CTS will follow the Request To Send (RTS) signal. If set to **FORCED ON**, CTS will always be asserted.

MODULES (NXT1HSSI) > HSSI MENUS > CONFIG > DSR (V.35)**Write security: 5; Read security: 5**

(Available only on the NxT1 HSSI/V.35 Option Module - P/N 1200346L2.) Determines the behavior of the Data Set Ready (DSR) signal. If set to **NORMAL**, DSR will generally be asserted when the interface is capable of passing data. If set to **FORCED ON**, DSR will always be asserted. If set to **REMOTE DTR**, the value of DSR will track the value of the remote unit's DTR signal.

MODULES (NXT1HSSI) > HSSI MENUS > CONFIG > IFCE AUTO DEACT**Write security: 5; Read security: 5**

This feature allows a user to set an active DS1 threshold that is used to control the status of the module's DTE interface. If the number of active DS1 links falls below the threshold while this setting is Enabled, the module's DTE interface will be deactivated. The module will not automatically restore operation on the DTE interface until the number of DS1 links reaches the threshold value. The DTE interface may be manually activated.



*The Interface Automatic Deactivation feature is not available when **CA** (data Communication equipment Available signal) is configured **OFF** or **DCD** (Data Carrier Detect) is configured **FORCED ON**.*

MODULES (NXT1HSSI) > HSSI MENUS > CONFIG > DCD (V.35)**Write security: 5; Read security: 5**

(Available only on the NxT1 HSSI/V.35 Option Module - P/N 1200346L2.) Determines the behavior of the Data Carrier Detect (DCD) signal (also called RLSD on some interfaces). If set to Normal, DCD will generally be asserted when the interface is capable of passing data. If set to Forced On, DCD will always be asserted. If set to Remote RTS, the value of DCD will track the value of the remote unit's RTS signal.



*DCD is not configurable when the Interface Automatic Deactivation (IFACE AUTO DEACT) feature is **ON**.*

MODULES (NXT1HSSI) > HSSI MENUS > CONFIG > CA**Write security: 5; Read security: 5**

(Not applicable in V.35 mode.) Asserts the data Communications equipment **AVAILABLE** signal from the DCE. CA will be asserted by the DCE, independently of TA, when the DCE is prepared to both send and receive data to and from the DTE. This indicates that the DCE has obtained a valid data communications channel. Data transmission should not commence until TA has also been asserted by the DTE.

MODULES (NXT1HSSI) > HSSI MENUS > TEST**Write security: 4; Read security: 5**

Provides access to testing functionality for the HSSI and HSSI/V.35 interfaces for the NxT1 HSSI or NxT1 HSSI/V.35 Option Modules.

MODULES (NXT1HSSI) > HSSI MENUS > TEST > PORT**Read security: 5**

Indicates the operating port number. The NxT1 HSSI and NxT1 HSSI/V.35 Option Modules have one available HSSI (or HSSI/V.35) interface.

MODULES (NXT1HSSI) > HSSI MENUS > TEST > LOCAL LPBK**Write security: 4; Read security: 5**

Activates a local loopback on the HSSI interface. The following local loopbacks are available:

- | | |
|-------------------|---|
| LOCAL LINE | Activates a loopback of the received T1 data streams at the DTE interface. |
| T1 FRAMER | Activates a loopback of the received T1 data streams after the data has been processed by the T1 framer located on the NxT1 HSSI or NxT1 HSSI/V.35 Option Modules. All data received during an active T1 FRAMER local loopback will be regenerated (re-framed) and transmitted back out the DTE interface. |
| LOCAL DTE | Activates a loopback of all data received at the DTE. All data received during an active LOCAL DTE loopback will be echoed out the DTE interface. |

MODULES (NxT1HSSI) > HSSI MENUS > TEST > REMOTE LPBK (HSSI)

Write security: 4; Read security: 5

Transmits a loopback request to the remote DTE interface. The following local loopbacks are available:

EXTERNAL DCE Transmits a loopback request to the remote DTE interface. All data transmitted out the HSSI (or HSSI/V.35) DTE interface will be echoed back by the remote DCE equipment.

MODULES MENU (ETHERNET SWITCH MODULE)

The ATLAS 550 system controller automatically detects the presence of the Ethernet Switch Module when it is installed in the system (listed as **ENET-8**). To see the menus for the Ethernet Switch Module via the terminal menu, use the arrow keys to scroll to the **MODULES** menu and press <Enter> to access the module choices. Refer to the *Ethernet Switch Module Quick Start Guide* for a menu tree containing a complete listing of menus.

MODULES (ENET-8) > INFO

Read security: 5

Provides information about the module part number, serial number and assembly revision.

MODULES (ENET-8) > INFO > PART NUMBER

Read security: 5

Displays the part number of the module.

MODULES (ENET-8) > INFO > SERIAL NUMBER

Read security: 5

Displays the serial number of the module.

MODULES (ENET-8) > INFO > ASSEMBLY REVISION

Read security: 5

Displays the assembly revision of the installed module.

MODULES (ENET-8) > STATUS

Read security: 5

Displays the status of each Ethernet port located on the Ethernet Switch Option Module.

MODULES (ENET-8) > STATUS > PORT

Read security: 5

Indicates the operating port number. There are eight available Ethernet interfaces on the Ethernet Switch Option Module.

MODULES (ENET-8) > STATUS > LINK STATUS

Read security: 5

Indicates whether there is an active Ethernet link connected to the interface. An active connection is indicated with a **LINK UP** status message. **LINK DOWN** indicates there is no active Ethernet connection on the

interface.

MODULES (ENET-8) > STATUS > SPEED

Read security: 5

Displays the current speed of the Ethernet interface. All Ethernet interfaces on the Ethernet Switch Option Module are capable of 10BaseT (listed as **10 MBPS**) and 100BaseTX (listed as **100 MBPS**) operation.

MODULES MENU (RESOURCE HOST MODULE)

The ATLAS 550 system controller automatically detects the presence of the Resource Host Module when it is installed in the system (listed as **Rsc HOST**). To see the menus for the Resource Host Module via the terminal menu, use the arrow keys to scroll to the **MODULES** menu and press <Enter> to access the module choices. Refer to the *Resource Host Module Quick Start Guide* for a menu tree containing a complete listing of menus.

MODULES (RSC HOST) > INFO

Read security: 5

Provides information about the module part number, serial number and assembly revision.

MODULES (RSC HOST) > INFO > PART NUMBER

Read security: 5

Displays the part number of the module.

MODULES (RSC HOST) > INFO > SERIAL NUMBER

Read security: 5

Displays the serial number of the module.

MODULES (RSC HOST) > INFO > ASSEMBLY REVISION

Read security: 5

Displays the assembly revision of the installed module.

MODULES MENU (VCOM OPTION MODULE)

The ATLAS 550 system controller automatically detects the presence of the Voice Compression (VCOM) Resource Module when it is installed in the system (listed as **VCOM-x** where x is **4** for 1200312L1, **8** for 1200312L2, **16** for 1200312L3, and **24** for 1200312L4). To see the menus for the VCOM Resource Module via the terminal menu, use the arrow keys to scroll to the **MODULES** menu and press <Enter> to access the module choices. Refer to the *VCOM Resource Module Quick Start Guide* for a menu tree containing a complete listing of menus.

MODULES (VCOM-x) > INFO

Read security: 5

Provides information about the module part number, serial number and assembly revision.

MODULES (VCOM-x) > INFO > PART NUMBER**Read security: 5**

Displays the part number of the module.

MODULES (VCOM-x) > INFO > SERIAL NUMBER**Read security: 5**

Displays the serial number of the module.

MODULES (VCOM-x) > INFO > ASSEMBLY REVISION**Read security: 5**

Displays the assembly revision of the installed module.

MODULES (VCOM-x) > INFO > FIRMWARE REVISION**Read security: 5**

Displays the current firmware revision of the selected module.

MODULES (VCOM-x) > STATUS**Read security: 5**

Displays the status of each of the voice compression resources.

MODULES (VCOM-x) > STATUS > DEVICE**Read security: 5**

Indicates the resource number of the packet voice device listed. On the ATLAS 550, packet voice devices are numbered 1-24.

MODULES (VCOM-x) > STATUS > STATUS**Read security: 5**

Indicates the condition of the individual packet voice device. This field may display the following:

N/A	This device is not populated on the selected VCOM Resource Module.
AVAILABLE	This resource is available for voice compression and functioning properly. If a VCOM-4 Option Module is installed, 4 voice compression resources will be AVAILABLE and the rest will display N/A . The same principle applies to the VCOM-8, 24, and 32 Option Modules.
PENDING	This resource is currently changing state.
BUSY	This resource is currently in use.
TESTING	This resource is currently being tested and is not available for use.
FAILED	This resource has failed testing and is not available for use.
RELOADED	This resource was reinitialized after excessive errors.

MODULES (VCOM-x) > STATUS > ALGORITHM**Read security: 5**

Denotes the voice compression algorithm being used by the packet voice device. Any packet voice device can use any available compression algorithm. When ATLAS 550 chooses a packet voice device for a particular call, the voice compression algorithm is set to match the dial plan endpoint configuration. Refer to the Frame Relay menu section of this manual for more information.

N/A	This device has not been assigned a voice compression algorithm.
G.723.1	CCITT G.723.1 compression; 6.3 kbps bandwidth.
NETCODER	Proprietary NETCODER compression; 6.4 kbps bandwidth.



Some voice compression standards may be used only under specific licensing arrangements due to existing patents. The ATLAS 550 provides complete management of these licensed resources; therefore, users are not required to take additional steps to ensure conformance with licensing provisions. For example, the ATLAS 550 manages its resources so users never exceed the maximum licensed number of simultaneous connections.

MODULES (VCOM-x) > STATUS > SILENCE**Read security: 5**

Voice endpoints continue to originate frame relay traffic during periods of relative silence. The ATLAS 550 expects to receive such silence frames; therefore, silence compression is **DISABLED** by default. Some voice endpoints can be configured so that no silence frames are transmitted during periods of relative silence. For compatibility with these devices, the ATLAS 550 can be configured to expect that silence suppression is **ENABLED**; thus, no frame relay traffic is generated during periods of silence. Both voice endpoints must agree on the silence suppression setting.

MODULES (VCOM-x) > STATUS > CONNECTION**Read security: 5**

Helps identify a suspect packet voice device if a particular call reports poor quality. The displayed packet identifier and the dial plan endpoint identify the call using this packet voice device.

MODULES (VCOM-x) > STATUS > FRAME TYPE**Read security: 5**

Displays the kind of frame the ATLAS 550 receives from the frame relay endpoint connected to the VCOM channel, allowing users to monitor the kind of data being carried on the network and processed by the ATLAS 550. (The ATLAS 550 interprets the most-recently received frame from the endpoint.)

During a voice connection, the frame type displays as **VOICE**. For a FAX connection, a variety of frame types display. Initially, **VOICE** displays indicating that although the call has completed, the answering FAX machine has not yet announced its 2100 HZ tone. After completing the 2100 Hz, both FAX endpoints repeat a V.21 cycle for each page of the FAX document.

Each packet the ATLAS 550 receives from its connected frame relay endpoint is classified into one of the following groups:

BLANK	No frame has yet been received from the endpoint, or a FAX connection is between protocol states.
DTMF	Dual-tone, multi-frequency (DTMF) digit received.
VOICE	Receiving voice frames. A connection to a FAX endpoint shows a VOICE status until the FAX protocol is established.
2100 HZ TONE	FAX single-frequency tone detected indicating the beginning of a FAX session.
V.21	FAX single-frequency tone detected indicating the beginning of a FAX page.
V.27TER (2400 BPS)	FAX data reception of 2400 bps using protocol V.27ter.
V.27TER (4800 BPS)	FAX data reception of 4800 bps using protocol V.27ter.
V.29 (7200 BPS)	FAX data reception of 7200 bps using protocol V.29.
V.29 (9600 BPS)	FAX data reception of 9600 bps using protocol V.29.
V.33 (12000 BPS)	FAX data reception of 12000 bps using protocol V.33.
V.33 (14400 BPS)	FAX data reception of 14400 bps using protocol V.33.

MODULES (VCOM-X) > CONFIG

Write security: 4; Read security: 5

Provides diagnostic tools for suspected problems; under normal operation, users do not configure the packet voice devices.

MODULES (VCOM-X) > CONFIG > CONFIGURE VCOM DEVICES

Write security: 4; Read security: 5

Contains configuration parameters for individual VCOM devices.

MODULES (VCOM-X) > CONFIG > CONFIGURE VCOM DEVICES > DEVICE

Read security: 5

Indicates the resource number of the packet voice device listed. On the ATLAS 550, packet voice devices are numbered 1-24.

MODULES (VCOM-X) > CONFIG > CONFIGURE VCOM DEVICES > STATE

Write security: 4; Read security: 5

Controls the configuration state of the individual packet voice device. The ATLAS 550 determines the initial configuration state of each device. ATLAS uses this configuration information to determine which packet voice devices are functional and may be used, which are defective and should not be used, or which are not present on the module and should not be used. Users who suspect an individual packet voice device of improper operation can manually disable that device to prevent ATLAS from attempting to use it. The

possible states are defined below.

DEFERRED	Devices which fail built-in testing are automatically marked as DEFERRED , indicating that the ATLAS 550 declines to use the device.
AVAILABLE	The device is properly functioning and can be used when required. The ATLAS 550 automatically marks devices that pass built-in testing as AVAILABLE .
DISABLED	Marking a device as DISABLED prevents the ATLAS 550 from attempting to use it. You can mark a device currently in use as disabled without disturbing the connection, but the device will not be eligible for use in future calls until you re-mark it as AVAILABLE . This is helpful if you suspect that a particular device is malfunctioning and do not want any calls routed to it.

MODULES (VCOM-X) > CONFIG > GAIN SETTINGS

Write security: 5; Read security: 5

Contains the configuration for output and input gain for the VCOM Resource Module.

MODULES (VCOM-X) > CONFIG > GAIN SETTINGS > OUTPUT GAIN

Write security: 3; Read security: 5

Output gain is applied in the receive direction. Choices range from **+12 dB** (loudest) to **-12 dB** (softest) in 3 dB increments. This setting takes affect immediately.

MODULES (VCOM-X) > CONFIG > GAIN SETTINGS > INPUT GAIN

Write security: 3; Read security: 5

Input gain is applied in the transmit direction. Choices range from **-12 dB** (softest) to **+12 dB** (loudest) in 3 dB increments. This setting does not affect currently active calls.

MODULES (VCOM-X) > CONFIG > CURRENT FAX STATUS

Write security: 5; Read security: 5

Enables or disables fax over packet capability using the voice compression module.

MODULES (VCOM-X) > STATISTICS

Write security: 4; Read security: 5

These options initiate different types of tests and display test results.

MODULES (VCOM-X) > STATISTICS > DEVICE

Read security: 5

Indicates the resource number of the packet voice device listed. On the ATLAS 550, packet voice devices are numbered 1-24.

MODULES (VCOM-X) > STATISTICS > USAGE TIME**Read security: 5**

Measures the total elapsed time that a packet voice device has the status **BUSY**. The time is expressed with millisecond precision. Available packet voice devices are assigned new connections using a round-robin technique where all other available packet voice devices must be used before a given device is assigned a new connection. This scheme tends to use all packet voice devices evenly. If a given device shows significantly less elapsed usage time than other packet voice devices on the same ATLAS 550, that device may be faulty.

MODULES (VCOM-X) > STATISTICS > ATLAS FRMS**Read security: 5**

(ATLAS Frames) Counts every frame that the ATLAS 550 sends to or receives from the packet voice device. This count indicates activity but does not indicate the actual amount of frame relay data exchanged. The total number of frames handled by the packet voice device is given by the following equation:

$$\text{Frames}_{(\text{ATLAS})\text{Total}} = \text{Frames}_{\text{ATLAS}} + \text{Frames}_{(\text{ATLAS})\text{Dropped}}$$

See the **ATLAS DROP** definition below for a description of the term: $\text{Frames}_{(\text{ATLAS})\text{Dropped}}$

MODULES (VCOM-X) > STATISTICS > ATLAS DROP**Read security: 5**

A counter that measures each frame that is dropped or discarded during communication between the ATLAS 550 and the packet voice device; i.e., ATLAS Frames Dropped. The exchange protocol is designed so that no frames should be discarded during this operation. A consistent pattern of dropped frames by a given packet voice device may indicate a faulty packet voice device or an overloaded ATLAS 550 system.



The discarded frame indicated by this value does not reflect network-level performance management, but indicates an anomalous condition within the ATLAS 550 unit. Persistently dropped frames may indicate a problem with the ATLAS 550 unit or the Voice Compression Resource Module.

MODULES (VCOM-X) > STATISTICS > VCOM FRMS**Read security: 5**

Counts every frame successfully sent to or received from the ATLAS 550 system controller. This is an indication of activity but does not indicate the actual amount of packet data exchanged. The following equation gives the total number of frames handled for this packet voice device by the ATLAS 550:

$$\text{Frames}_{(\text{VCOM})\text{Total}} = \text{Frames}_{\text{VCOM}} + \text{Frames}_{(\text{VCOM})\text{Dropped}}$$

See the **VCOM DROP** definition below for a description of the term: $\text{Frames}_{(\text{VCOM})\text{Dropped}}$

MODULES (VCOM-X) > STATISTICS > VCOM DROP**Read security: 5**

Counter that measures each frame dropped or discarded by ATLAS 550 during communication with the ATLAS 550 system controller about a packet voice device. The exchange protocol is designed so that no frames should be discarded during this operation. A consistent pattern of dropped frames by a given packet voice device may indicate a faulty packet voice device or an overloaded ATLAS 550 system.



The discarded frame indicated by this value does not reflect network-level performance management but indicates an anomalous condition within the ATLAS 550 unit. Persistently dropped frames may indicate a problem with the ATLAS 550 unit or the VCOM module.

MODULES (VCOM-X) > STATISTICS > CLEAR**Write security: 4; Read security: 5**

Resets the elapsed usage time and frame counters for this packet voice device. Ordinarily, users won't reset these performance measurements. However, this feature can be useful when testing that a suspected problem has been resolved and when zeroing the various counters would make observing future events easier.



Resetting these performance counters has no effect on the performance values accessible via the SNMP network management interface.

MODULES (VCOM-X) > STATISTICS > RELOADS**Write security: 4; Read security: 5**

Number of times since module reboot that this device has been reloaded due to a failure.

MODULES MENU (32 CHANNEL ADPCM RESOURCE MODULE)

The ATLAS 550 system controller automatically detects the presence of the 32 Channel ADPCM Resource Module when it is installed in the system (listed as **ADPCM-32**). To see the menus for the 32 Channel ADPCM Resource Module via the terminal menu, use the arrow keys to scroll to the **MODULES** menu and press <Enter> to access the module choices. Refer to the *32 Channel ADPCM Resource Module Quick Start Guide* for a menu tree containing a complete listing of menus.

MODULES (ADPCM-32) > INFO**Read security: 5**

Provides information about the module part number, serial number and assembly revision.

MODULES (ADPCM-32) > INFO > PART NUMBER**Read security: 5**

Displays the part number of the module.

MODULES (ADPCM-32) > INFO > SERIAL NUMBER**Read security: 5**

Displays the serial number of the module.

MODULES (ADPCM-32) > INFO > ASSEMBLY REVISION**Read security: 5**

Displays the assembly revision of the installed module.

MODULES (ADPCM-32) > INFO > FIRMWARE REVISION**Read security: 5**

Displays the current firmware revision of the selected module.

MODULES (ADPCM-32) > STATUS**Read security: 5**

Displays the status of each of the packet voice resources.

MODULES (ADPCM-32) > STATUS > DEVICE**Read security: 5**

Indicates the resource number of the packet voice device listed. On the ATLAS 550, packet voice devices are numbered 1-24.

MODULES (ADPCM-32) > STATUS > STATUS**Read security: 5**

Indicates the condition of the individual packet voice device. This field may display the following:

N/A	This device is not populated on the selected 32 Channel ADPCM Resource Module.
AVAILABLE	This resource is available for voice compression and functioning properly.
PENDING	This resource is currently changing state.
BUSY	This resource is currently in use.
TESTING	This resource is currently being tested and is not available for use.
FAILED	This resource has failed testing and is not available for use.
RELOADED	This resource was reinitialized after excessive errors.

MODULES (ADPCM-32) > STATUS > ALGORITHM**Read security: 5**

Denotes the voice compression algorithm being used by the packet voice device. Voice data may be encoded using any of a variety of compression algorithms or codecs. The codec for an individual call is selected when the connection is configured. When ATLAS 550 assigns a packet voice device to a particular call, the that packet voice device is switched to the proper codec. Refer to the Frame Relay menu section of this manual for more information.



Some voice compression standards may be used only under specific licensing arrangements due to existing patents. The ATLAS 550 provides complete management of these licensed resources; therefore, users are not required to take additional steps to ensure conformance with licensing provisions. For example, the ATLAS 550 manages its resources so users never exceed the maximum licensed number of simultaneous connections.

MODULES (ADPCM-32) > STATUS > CONNECTION**Read security: 5**

Helps identify a suspect packet voice device if a particular call reports poor quality. The displayed packet identifier and the dial plan endpoint identify the call using this packet voice device.

MODULES (ADPCM-32) > CONFIG**Write security: 4; Read security: 5**

Provides diagnostic tools for suspected problems; under normal operation, users do not configure the packet voice devices.

MODULES (ADPCM-32) > CONFIG > CONFIGURE ADPCM-32 DEVICES**Write security: 4; Read security: 5**

Contains configuration parameters for individual ADPCM-32 devices.

MODULES (ADPCM-32) > CONFIG > CONFIGURE ADPCM-32 DEVICES > DEVICE**Read security: 5**

Indicates the resource number of the packet voice device listed. On the ATLAS 550, packet voice devices are numbered 1-24.

MODULES (ADPCM-32) > CONFIG > CONFIGURE ADPCM-32 DEVICES > STATE**Write security: 3; Read security: 5**

Controls the configuration state of the individual packet voice device. The ATLAS 550 determines the initial configuration state of each device. ATLAS uses this configuration information to determine which packet voice devices are functional and may be used, which are defective and should not be used, or which are not present on the module and should not be used. Users who suspect an individual packet voice device of improper operation can manually disable that device to prevent ATLAS from attempting to use it. The

possible states are defined below.

DEFERRED	Devices which fail built-in testing are automatically marked as DEFERRED , indicating that the ATLAS 550 declines to use the device.
AVAILABLE	The device is properly functioning and can be used when required. The ATLAS 550 automatically marks devices that pass built-in testing as AVAILABLE .
DISABLED	Marking a device as DISABLED prevents the ATLAS 550 from attempting to use it. You can mark a device currently in use as disabled without disturbing the connection, but the device will not be eligible for use in future calls until you re-mark it as AVAILABLE . This is helpful if you suspect that a particular device is malfunctioning and do not want any calls routed to it.

MODULES (ADPCM-32) > STATISTICS

Write security: 5; Read security: 5

These options initiate different types of tests and display test results.

MODULES (ADPCM-32) > STATISTICS > DEVICE

Read security: 5

Indicates the resource number of the packet voice device listed. On the ATLAS 550, packet voice devices are numbered 1-24.

MODULES (ADPCM-32) > STATISTICS > USAGE TIME

Read security: 5

Measures the total elapsed time that a packet voice device has the status **BUSY**. The time is expressed with millisecond precision. Available packet voice devices are assigned new connections using a round-robin technique where all other available packet voice devices must be used before a given device is assigned a new connection. This scheme tends to use all packet voice devices evenly. If a given device shows significantly less elapsed usage time than other packet voice devices on the same ATLAS 550, that device may be faulty.

MODULES (ADPCM-32) > STATISTICS > ATLAS FRMS

Read security: 5

(ATLAS Frames) Counts every frame that the ATLAS 550 sends to or receives from the packet voice device. This count indicates activity but does not indicate the actual amount of frame relay data exchanged. The total number of frames handled by the packet voice device is given by the following equation:

$$\text{Frames}_{(\text{ATLAS})\text{Total}} = \text{Frames}_{\text{ATLAS}} + \text{Frames}_{(\text{ATLAS})\text{Dropped}}$$

See the **ATLAS DROP** definition below for a description of the term: $\text{Frames}_{(\text{ATLAS})\text{Dropped}}$

MODULES (ADPCM-32) > STATISTICS > ATLAS DROP**Read security: 5**

A counter that measures each frame that is dropped or discarded during communication between the ATLAS 550 and the packet voice device; i.e., ATLAS Frames Dropped. The exchange protocol is designed so that no frames should be discarded during this operation. A consistent pattern of dropped frames by a given packet voice device may indicate a faulty packet voice device or an overloaded ATLAS 550 system.



The discarded frame indicated by this value does not reflect network-level performance management, but indicates an anomalous condition within the ATLAS 550 unit. Persistently dropped frames may indicate a problem with the ATLAS 550 unit or the Voice Compression Resource Module.

MODULES (ADPCM-32) > STATISTICS > ADPCM-32 FRMS**Read security: 5**

Counts every frame successfully sent to or received from the ATLAS 550 system controller. This is an indication of activity but does not indicate the actual amount of packet data exchanged. The following equation gives the total number of frames handled for this packet voice device by the ATLAS 550:

$$\text{Frames}_{(\text{ADPCM})\text{Total}} = \text{Frames}_{\text{ADPCM}} + \text{Frames}_{(\text{ADPCM})\text{Dropped}}$$

See the **ADPCM-32 DROP** definition below for a description of the term: $\text{Frames}_{(\text{ADPCM})\text{Dropped}}$

MODULES (ADPCM-32) > STATISTICS > ADPCM-32 DROP**Read security: 5**

Counter that measures each frame dropped or discarded by ATLAS 550 during communication with the ATLAS 550 system controller about a packet voice device. The exchange protocol is designed so that no frames should be discarded during this operation. A consistent pattern of dropped frames by a given packet voice device may indicate a faulty packet voice device or an overloaded ATLAS 550 system.



The discarded frame indicated by this value does not reflect network-level performance management but indicates an anomalous condition within the ATLAS 550 unit. Persistently dropped frames may indicate a problem with the ATLAS 550 unit or the 32 Channel ADPCM Resource Module.

MODULES (ADPCM-32) > STATISTICS > CLEAR**Write security: 3; Read security: 5**

Resets the elapsed usage time and frame counters for this packet voice device. Ordinarily, users will not reset these performance measurements. However, this feature can be useful when testing that a suspected problem has been resolved and when zeroing the various counters would make observing future events easier.



Resetting these performance counters has no effect on the performance values accessible via the SNMP network management interface.

MODULES MENU (Nx 56/64 BONDING RESOURCE MODULE)

The ATLAS 550 system controller automatically detects the presence of the Nx 56/64 BONDing Resource Module when it is installed in the system (listed as **BONDING**). To see the menus for the Nx 56/64 BONDing Resource Module via the terminal menu, use the arrow keys to scroll to the **MODULES** menu and press <Enter> to access the module choices. Refer to the *Nx 56/64 BONDing Resource Module Quick Start Guide* for a menu tree containing a complete listing of menus.

MODULES (BONDING) > INFO

Read security: 5

Provides information about the module part number, serial number and assembly revision.

MODULES (BONDING) > INFO > PART NUMBER

Read security: 5

Displays the part number of the module.

MODULES (BONDING) > INFO > SERIAL NUMBER

Read security: 5

Displays the serial number of the module.

MODULES (BONDING) > INFO > BOARD REVISION

Read security: 5

Displays the board revision of the installed module.

MODULES (BONDING) > INFO > FIRMWARE REVISION

Read security: 5

Displays the current firmware revision of the Nx 56/64 BONDing Resource Module.

MODULES (BONDING) > STATUS

Read security: 5

Indicates the current status of a particular BONDING session.

MODULES (BONDING) > STATUS > STATUS

Read security: 5

Displays the current status of the BONDING session.

IDLE	Indicates the number of Idle BONDING resources for a particular BONDING engine.
RESERVED	BONDING resources reserved for a BONDING session that is in the process of coming up.
NEGOTIATING	A single channel is connected and negotiating the BONDING call for a particular BONDING session.
ADD CHANNELS	The initial BONDING negotiation was successful, and the ATLAS 550 is in the process of adding channels to the BONDING session.

BONDING	The remaining channels were brought up successfully, and the BONDING session is now ready to pass data.
TERMINATED	The BONDING session has been terminated for some reason and is in the process of freeing BONDING resources.

MODULES (BONDING) > STATUS > NUMBCHANNELS

Read security: 5

Displays the number of bearer channels used in this BONDING session. When the number is displayed in the format X/Y, Y is the number of BONDING resources reserved for this session, and X is the number of calls belonging to this session that are up. If just a number is displayed, then all calls are up, and the number displayed is the number of BONDING resources in use for this session.

MODULES (BONDING) > STATUS > DATA RATE

Read security: 5

Displays the data rate for this BONDING session. The number in the parenthesis is the data rate of the individual bearer channels.

MODULES (BONDING) > STATUS > BONDED EP

Read security: 5

Displays the slot and port of the terminating endpoint that is using this BONDING session.

MODULES (BONDING) > CONFIGURATION

Write security: 3; Read security: 5

All of the following configurable parameters apply to the Nx 56/64 BONDing Resource Module. In most applications the default values will be correct.

MODULES (BONDING) > CONFIGURATION > TXINIT TIMER (SEC)

Write security: 3; Read security: 5

Specifies the length of time the originating endpoint attempts to detect the BONDING negotiation pattern from the answering endpoint before deciding the BONDING call has failed.

MODULES (BONDING) > CONFIGURATION > TXFA TIMER (SEC)

Write security: 3; Read security: 5

Specifies the length of time both endpoints attempt to detect the BONDING frame pattern when a call is connected before deciding the BONDING call has failed. When interoperating with other manufacturers' BONDING equipment, it may be necessary to change this time so that it matches **TXADD01**.

MODULES (BONDING) > CONFIGURATION > TXADD01 TIMER (SEC)

Write security: 3; Read security: 5

Specifies the length of time both endpoints wait for additional calls to be connected at the end of negotiation before deciding that the BONDING call has failed. The factory default setting is sufficient for most calls to connect, although when dialing overseas it may be necessary to lengthen this timer to allow for slower call routing.

MODULES (BONDING) > CONFIGURATION > TXDEQ TIMER (SEC)**Write security: 3; Read security: 5**

Specifies the length of time both endpoints attempt to equalize the network delay between the bearer channels before deciding the BONDING call has failed.

MODULES (BONDING) > CONFIGURATION > TANULL TIMER (SEC)**Write security: 3; Read security: 5**

Specifies the length of time the answering endpoint attempts to detect the BONDING negotiation pattern from the originating endpoint before deciding the BONDING call has failed. It may be necessary to shorten this timer if the DTE equipment using the BONDING module also has timer constraints for completing non-BONDING parameter negotiation.

MODULES (BONDING) > CONFIGURATION > TCID TIMER (SEC)**Write security: 3; Read security: 5**

Specifies the length of time both endpoints attempt to negotiate an agreeable value for bearer channels and channel capacities before deciding the BONDING call has failed.

MODULES (BONDING) > CONFIGURATION > CALL STAGGER**Write security: 3; Read security: 5**

Specifies the amount of delay between placing calls for outgoing BONDING sessions. The following call stagger values are available:

NO STAGGER	There is no delay between the call dialing of a BONDING session.
500 MS	Wait approximately ½ second between the call dialing of a BONDING session.
1 SEC.	Wait approximately 1 second between the call dialing of a BONDING session.
2 SEC.	Wait approximately 2 seconds between the call dialing of a BONDING session.

PACKET MANAGER

The **PACKET MANAGER** submenus define and configure all layer 2 connections, including frame relay endpoints (Figure 14). These submenus include **PACKET ENDPNTS**, **PACKET CNCTS**, **CNCTS SORT** and **FRAME RELAY IQ**.

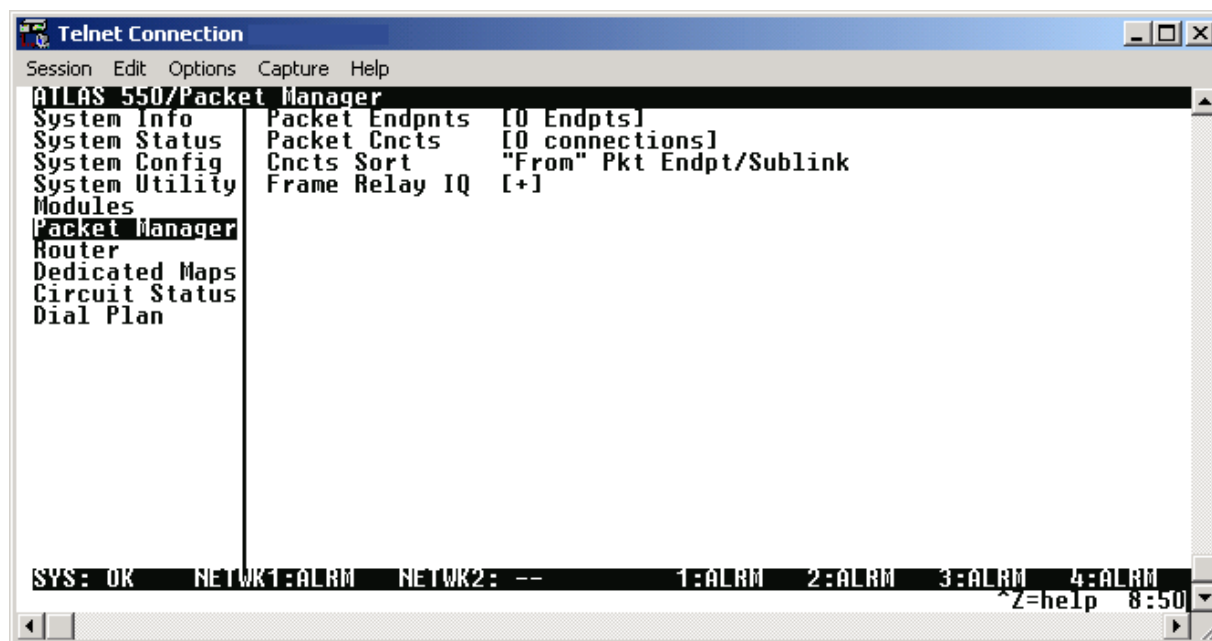

Figure 14. Packet Manager Menu

PACKET MANAGER > PACKET ENDPNTS

Read security: 5

Defines, monitors, and tests a packet endpoint. Submenus include **STATUS**, **PERFORMANCE**, **CONFIG**, **TEST**, **ENDPNT COUNT**, and **ENDPNTS SORT**.

PACKET MANAGER > PACKET ENDPNTS > STATUS

Read security: 5

Displays the status of each packet endpoint including the packet endpoint name, the protocol type, the signaling role, the signaling type, the signaling activity, and the connections. The configuration choices are given below.

PACKET MANAGER > PACKET ENDPNTS > STATUS > ENDPNT NAME

Read security: 5

Displays the packet endpoint name as defined in the **PACKET ENDPNTS/CONFIG** menu.

PACKET MANAGER > PACKET ENDPNTS > STATUS > PROTOCOL**Read security: 5**

Displays the layer 2 protocol for this packet endpoint. **FR** indicates this packet endpoint is configured for frame relay. **TBOP** indicates this packet endpoint is configured for Transparent Bit Oriented Protocol (TBOP). **PPP** indicates this packet endpoint is configured for the Point-to-Point Protocol. **SDLC** indicates this packet endpoint is configured for SDLC signaling.



SDLC signaling is only available using the Legacy Data Option Module (P/N 1200342L1).

PACKET MANAGER > PACKET ENDPNTS > STATUS > SIG ROLE**Read security: 5**

Displays the frame relay signaling role for this packet endpoint. The following options indicate the signaling role for this packet endpoint. *These settings are not applicable for PPP.*

USER	Indicates the user side of the User to Network Interface (UNI).
NETWORK	Indicates the network side of the UNI.
BOTH	Indicates the packet endpoint is operating in Network to Network Interface (NNI) mode.

PACKET MANAGER > PACKET ENDPNTS > STATUS > SIG TYPE**Read security: 5**

Displays the frame relay signaling type used on this packet endpoint. *This setting is not applicable for PPP, TBOP, or SDLC endpoints.*

ANNEX A	Signaling using ITU-T Q.933-A.
ANNEX D	Signaling using ANSI T1.617-D.
LMI	Signaling using Group of Four.

PACKET MANAGER > PACKET ENDPNTS > STATUS > SIG STATE - FRAME RELAY**Read security: 5**

(Valid only for Frame Relay endpoints.) Indicates the frame relay signaling state on this packet endpoint. The possible states are defined below.

UP	Indicates that there is active frame relay signaling on this endpoint. The packet endpoint must be defined by the frame relay configuration settings to show active frame relay signaling.
DOWN	The packet endpoint stays in this state only when the physical line is down.

PACKET MANAGER > PACKET ENDPNTS > STATUS > SIG STATE - PPP**Read security: 5**

(Valid only for PPP endpoints.) Indicates the status of the PPP negotiation. The possible states are defined below.

INITIAL	This is the first state of LCP negotiation. If the packet endpoint is connected to a physical port in the DEDICATED MAP , this state will usually transition to the STARTING state to begin the PPP negotiation.
STARTING	The packet endpoint stays in this state only when the physical line is down.
REQ - SENT	The packet endpoint has sent an LCP configuration request to the peer and is waiting for an “acknowledge.”
ACK - RECVD	The packet endpoint has received an “acknowledge” from the peer for the sent configuration request.
ACK - SENT	The packet endpoint has acknowledged the peer’s configuration request, but the peer has not acknowledged us.
OPENED	LCP negotiation on the packet endpoint has finished; authentication, if enabled, occurs now.
CLOSING	The packet endpoint has sent the peer a “terminate” request and is waiting for the peer’s acknowledgement.
CLOSED	The packet endpoint has received the peer’s acknowledgement to the sent terminate request; this is followed by the initial state.
STOPPING	The packet endpoint has received a terminate request from the peer.
STOPPED	The packet endpoint has acknowledged the peer’s terminate request.
NOT CONNECTED	The packet endpoint is not connected to the router in the PACKET CNCTS menu.

PACKET MANAGER > PACKET ENDPNTS > STATUS > CURRENT PORT**Read security: 5**

Displays the connections for the packet endpoint. The letter **U** in this field indicates that this packet endpoint is used in the **PACKET CNCTS** map. The remainder of the field indicates the physical port this packet endpoint is connected to in the **DEDICATED MAP**. If the port is a channelized interface such as a T1, the DS0 assignment is also provided.

PACKET MANAGER > PACKET ENDPNTS > PERFORMANCE**Write security: 3; Read security: 5**

Displays performance information for each packet endpoint including the endpoint name, the protocol used, link stats, and sublink stats.

PACKET MANAGER > PACKET ENDPNTS > PERFORMANCE > ENDPNT NAME**Read security: 5**

Displays the packet endpoint name as defined in the **PACKET ENDPNTS/CONFIG** menu (see also *Packet*

Manager > Packet Endpnts > Config > Endpnt Name on page 196).

PACKET MANAGER > PACKET ENDPNTS > PERFORMANCE > PROT

Read security: 5

Displays the layer 2 protocol for this packet endpoint. **FR** indicates this packet endpoint is configured for frame relay. **TBOP** indicates this packet endpoint is configured for Transparent Bit Oriented Protocol (TBOP). **PPP** indicates this packet endpoint is configured for the Point-to-Point Protocol. **SDLC** indicates this packet endpoint is configured for SDLC signaling.



SDLC signaling is only available using the Legacy Data Option Module (P/N 1200342L1).

PACKET MANAGER > PACKET ENDPNTS > PERFORMANCE > LINK STATS - FRAME RELAY

Write security: 3; Read security: 5

Displays layer 2 performance statistics. The statistics fields for frame relay reflect the total count since last cleared. The available statistic information is discussed below.

TX PACKETS	Total number of frame relay packets transmitted through this packet endpoint, including both user data (on all PVCs) and signaling.
RX PACKETS	Total number of frame relay packets received through this packet endpoint on all PVCs.
STATE CHANGES	Total number of times that frame relay signaling has gone active or inactive.
SIGNALING ERRORS	Total number of signaling frames received with PVC signaling protocol violations.
SIGNALING TIMEOUTS	Number of times signaling polls were not received in the time specified in T391 in the PACKET ENDPNTS/CONFIG menu.
ASYNC STATUS TX	Full status not transmitted during the normal full status cycle. An asynchronous status message is used to quickly activate a link.
ASYNC STATUS RX	Full status not received during the normal full status cycle. An asynchronous status message is used to quickly activate a link.
FULL STATUS TX	Number of full status polls transmitted by this packet endpoint.
FULL STATUS RX	Number of full status polls received by this packet endpoint.
LINK INTEGRITY STATUS TX	Number of link integrity polls transmitted by this packet endpoint.
LINK INTEGRITY STATUS RX	Number of link integrity polls received by this packet endpoint.
CLEAR COUNTERS	Clears all values in this submenu.

PACKET MANAGER > PACKET ENDPNTS > PERFORMANCE > LINK STATS - TBOP AND SDLC**Write security: 3; Read security: 5**

Displays layer 2 performance statistics. The statistics fields for TBOP and SDLC reflect the total count since last cleared. The available statistic information is discussed below.

TX PACKETS**Read security: 5**

Total number of HDLC or SDLC packets transmitted through this packet endpoint.

RX PACKETS**Write security: 3; Read security: 5**

Total number of HDLC or SDLC packets received through this packet endpoint.

CLEAR COUNTERS**Write security: 3; Read security: 5**

Clears all values in this submenu.

PACKET MANAGER > PACKET ENDPNTS > PERFORMANCE > LINK STATS - PPP**Write security: 3; Read security: 5**

Displays layer 2 performance statistics. The statistics fields for PPP reflect the total count since last cleared. The available statistic information is discussed below.

LCP STATE**Read security: 5**

Displays the current state of the LCP negotiations.

IPCP**Read security: 5**

Displays the UP if PPP IP control has successfully negotiated.

TX PACKETS**Read security: 5**

Number of packets transmitted over this link.

RX PACKETS**Read security: 5**

Number of packets received over this link.

CLEAR COUNTERS**Write security: 3; Read security: 5**

Resets the Tx and Rx packet counters.

PACKET MANAGER > PACKET ENDPNTS > PERFORMANCE > SUBLINK STATS - FRAME RELAY**Write security: 3; Read security: 5**

Displays frame relay performance statistics for supported packet endpoint sublinks. These statistic fields reflect the total count since cleared. *These settings are not applicable for PPP or TBOP.*

NAME**Write security: 3; Read security: 5**

Alphanumeric characters (up to 16 characters) to create a user-defined name for the sublink (PVC).

DLCI**Write security: 3; Read security: 5**

Local address for each PVC as assigned by the carrier.

STATE**Write security: 3; Read security: 5**

Indicates if this particular sublink (PVC) has been defined as active by a full status poll, and also indicates if the PVC is in backup mode.

ACTIVE	PVC is active.
INACTIVE	PVC is inactive.
ACTIVE/BU	PVC is active, but in backup mode.
INACTIVE/BU	PVC is inactive and in backup mode.

TX PCKTS**Write security: 3; Read security: 5**

Total number of frame relay user data packets transmitted over this PVC.

RX PCKTS**Write security: 3; Read security: 5**

Total number of frame relay user data packets received over this PVC.

STATISTICS**Write security: 3; Read security: 5**

Provides additional information, as follows, on the individual sublink:

RESET COUNTERS**Write security: 3; Read security: 5**

Resets all sublink counters.

FECN COUNT**Write security: 3; Read security: 5**

Total number of FECN bits received on this PVC.

BECN COUNT**Write security: 3; Read security: 5**

Total number of BECN bits received on this PVC.

DE DISCARD COUNT**Write security: 3; Read security: 5**

Total number of Discard Eligible bits that have been received on this PVC.

ACTIVE FLAGS**Write security: ADTRAN USE ONLY**

For ADTRAN internal use only.

PACKET MANAGER > PACKET ENDPNTS > CONFIG**Write security: 3; Read security: 5**

Creates and configures packet endpoints.

PACKET MANAGER > PACKET ENDPNTS > CONFIG > ENDPNT NAME**Write security: 3; Read security: 5**

Alphanumeric string (up to 16 characters in length) to enter a user-definable name (such as the name of the frame relay provider or the circuit ID).

PACKET MANAGER > PACKET ENDPNTS > CONFIG > PROT**Write security: 3; Read security: 5**Defines the protocol operating on this port. **FRAME RELAY** configures this packet endpoint for frame relay signaling. **TBOP** configures this endpoint as transparent bit oriented protocol. **PPP** configures this packet endpoint as point-to-point protocol. **SDLC** configures this packet endpoint as an SDLC endpoint.*SDLC is only available for use with the Legacy Data Option Module (P/N 1200342L1).***PACKET MANAGER > PACKET ENDPNTS > CONFIG > CONFIG - FRAME RELAY****Write security: 3; Read security: 5**

Contains the configuration parameters for this packet endpoint.

SIGNALING ROLE**Write security: 3; Read security: 5**

Displays the frame relay signaling role for this packet endpoint. The following options indicate the signaling role of this packet endpoint.

OFF	The remote device does not support frame relay signaling.
AUTO	Detects the role of the device on the other end of the circuit and automatically sets this packet endpoint to the appropriate value.
BOTH	Operates in NNI mode.
NETWORK	Acts as the network side of the UNI interface.
USER	Acts as the user side of the UNI interface.

SIGNALING TYPE**Write security: 3; Read security: 5**

Displays the frame relay signaling type for this packet endpoint. The following options indicate the signaling type for this packet endpoint.

AUTO	Detects the signaling type of the device on the other end of the circuit and automatically sets this packet endpoint to the same signaling type.
ANNEX A	Transmits and responds to ITU-T Q.933-A standards.
ANNEX D	Transmits and responds to ANSI T1.617-D standards.
LMI	Transmits and responds to Group of Four specifications.

USER POLL TIMER (T391)**Write security: 3; Read security: 5**

Sets the polling interval to the network in seconds.

USER POLLS PER STATUS (N391)**Write security: 3; Read security: 5**

Controls how many link integrity polls occur between full status polls.

USER BAD EVENT THRESHOLD (N392)**Write security: 3; Read security: 5**

Sets the number of bad polling events that will cause the link to be declared down in N393 polls.

USER EVENT WINDOW SIZE (N393)**Write security: 3; Read security: 5**

Defines the number of poll events in each monitored window.



*For most applications, the **USER POLL TIMER**, **USER POLLS PER STATUS**, **USER BAD EVENT THRESHOLD**, and **USER EVENT WINDOW SIZE** configuration parameters should be left in the default state. Use caution when changing these parameters.*

NET POLL RESPONSE TIMEOUT (T392)**Write security: 3; Read security: 5**

Determines how long this packet endpoint will wait without receiving a poll before declaring the poll bad.



Ensure that this timer is greater than the T391 on the user side of the UNI; otherwise, erratic behavior will result.

NET POLLS PER STATUS (N391)**Write security: 3; Read security: 5**

Sets the number of link integrity polls before a full status is transmitted.

NET BAD EVENTS THRESHOLD (N392)**Write security: 3; Read security: 5**

Sets the number of bad polling events that will cause the link to be declared down in N393 polls.

NET EVENT WINDOW SIZE (N393)**Write security: 3; Read security: 5**

Defines the number of poll events in each monitored window.



If the number of bad polls reaches N392 in any N393 period, the link will be declared down. When N393 good polls are received, the link will be declared active again.

PACKET MANAGER > PACKET ENDPNTS > CONFIG > CONFIG - PPP**Write security: 3; Read security: 5**

Displays the configuration for this packet endpoint.

AUTHENTICATION**Write security: 3; Read security: 5**

Contains the Authentication parameters for this endpoint.

RX METHOD**Write security: 3; Read security: 5**

These are methods the ATLAS 550 uses to authenticate the peer. **NONE** is selected when you do not want to authenticate the peer. **PAP**, **CHAP**, or **EAP** is selected when you will allow the peer to be authenticated with one of the listed authentication protocols. In this case, the most secure method will be used first (**EAP**, then **CHAP**, then **PAP**). **CHAP** or **EAP** is selected when you will authenticate the peer only using one of the encrypted authentication protocols. **EAP** is selected when you will authenticate the peer only using the **EAP** authentication protocol.

TX METHOD**Write security: 3; Read security: 5**

This field displays a list of the methods that we will allow the peer to authenticate us with. This is of use when a peer wants to do **PAP** just to get your password. None is selected when you do not want to be authenticated by the peer. **PAP**, **CHAP**, or **EAP** is selected when you will let the peer use one or all of the authentication protocols. **CHAP** or **EAP** is selected when you will let the peer use only one of the encrypted authentication protocols. **EAP** is selected when you will let the peer use only the **EAP** authentication protocol.

TX USERNAME**Write security: 3; Read security: 5**

The username that the peer will use to authenticate the ATLAS 550.

TX PASSWORD**Write security: 3; Read security: 5**

The password that the peer will use to authenticate the ATLAS 550.

DEBUG LOG**Write security: 3; Read security: 5**

The following events can be viewed in the event log when PPP events have been turned to **INFO**.

LCP DEBUGGING**Write security: 3; Read security: 5**

This turns on LCP negotiation debugging.

IPCP DEBUGGING**Write security: 3; Read security: 5**

This turns on IPCP negotiation debugging.

BCP DEBUGGING**Write security: 3; Read security: 5**

This turns on BCP negotiation debugging.

AUTHENTICATION DEBUGGING**Write security: 3; Read security: 5**

This turns on authentication debugging.

UNKNOWN PROTOCOL DEBUGGING**Write security: 3; Read security: 5**

This turns on debugging for all unknown protocols received on this link.

MAX CONFIG**Write security: 3; Read security: 5**

This value is the number of unanswered configuration requests that should be transmitted before giving up on negotiation. The default value is 10.

MAX TIMER**Write security: 3; Read security: 5**

This value is the number of seconds to wait between unanswered configuration requests. The default value is 2 seconds.

MAX FAILURE**Write security: 3; Read security: 5**

Due to the nature of PPP, configuration options may not be agreed upon between two PPP peers. This value is the number of configuration-NAKs that should occur before an option is configuration-rejected. This allows a connection to succeed that might otherwise fail. The default value is 5.

KEEPALIVE**Write security: 3; Read security: 5**

Configures the ATLAS 550 to send keepalive frames on PPP connections that are not currently in use for data.

PACKET MANAGER > PACKET ENDPNTS > CONFIG > CONFIG - SDLC**Write security: 3; Read security: 5**

Contains the configuration parameters for the SDLC packet endpoints.

WARNING

Extreme caution should be used when changing the following parameters from their default state.

POLL RESPONSE TIMEOUT**Write security: 3; Read security: 5**

Sets the number of seconds the ATLAS 550 waits for a poll response before marking the poll as unanswered.

MINIMUM POLL TIMER**Write security: 3; Read security: 5**

Sets the number of seconds the ATLAS 550 waits between polls. The timer is started when the first poll is sent and will be restarted when the next poll is sent.

SLOW POLL RATIO**Write security: 3; Read security: 5**

Configures the ATLAS 550 to send polls to unresponsive remote units at a slower rate than normal. The number entered sets the ration. When a remote unit is polled repeatedly and no answer is received, the ATLAS 550 will move the unit from the normal poll interval to the slow poll interval. If 5 is entered here, the remote units on the slow poll will only get polled after the responsive units have been polled 5 times.

DISCONNECT THRESHOLD**Write security: 3; Read security: 5**

Sets the threshold for considering a remote unit inactive. This is determined using unanswered status polls.

TRANSMIT DELAY**Write security: 3; Read security: 5**

Configures the ATLAS 550 to introduce a delay between packets transmitted on this endpoint (in seconds). The ATLAS 550 will transmit a packet (any traffic - data, poll, etc.) then wait the entered seconds before transmitting another packet.

CTS OPTION**Write security: 3; Read security: 5**

Configures the Clear To Send (CTS) signal on this interface. CTS may be forced on or can be configured to be asserted only when Request To Send (RTS) is asserted.

DATA FORMAT**Write security: 3; Read security: 5**

Configures the data format scheme used on this SLDC endpoint for either NRZ (Non-Return to Zero) or NRZI (Non-Return to Zero Inverted). Using NRZ configures the Legacy Data Module to encode using ones and zeroes represented by opposite and alternating high and low voltages. There is no return to a zero reference voltage between encoded bits. Using NRZI configures the Legacy Data Module to encode ones with a voltage change and zeroes with no voltage change. NRZI encoding is also known as transition coding

PACKET MANAGER > PACKET ENDPNTS > CONFIG > SUBLINKS - FRAME RELAY**Write security: 3; Read security: 5**

Contains the configuration parameters for individual sublinks, or PVCs. The following parameters are available.

NAME**Write security: 3; Read security: 5**

User-definable name for the DLCI.

DLCI**Write security: 3; Read security: 5**

Local address for each PVC as assigned by the carrier.

QOS**Write security: 3; Read security: 5**

Quality of service. These values can be used to assign a guaranteed amount of bandwidth available for this connection. The sum of all QOS values for the sublink should not exceed the Committed Information Rate (CIR).

BURST**Write security: 3; Read security: 5**

Sets the burst rate used by this virtual circuit for data traffic. A value of zero means that the burst rate is not limited. The value is in kilobits/second. If voice traffic is flowing on ANY sublink on the port carrying THIS sublink, you should enter a value for this setting. Otherwise, leave this field set to default (zero). If the service provider has supplied a 'Be' value, enter that value in this field. The burst rate defines the amount that this virtual circuit is allowed to exceed the CIR. If the service provider has not supplied an excess burst rate, enter the wire speed in this field.

CONFIG**Write security: 3; Read security: 5**

Allows configuration of parameters for each DLCI.

FRAGMENTATION THRESHOLD**Write security: 3; Read security: 5**

Max packet size allowed on this PVC. A zero value disables fragmentation. Fragmentation is used to improve the quality of voice transmission. A good value is $R/300$, where R is the smallest of the ATLAS 550 link rates or the far end link rate in bits per second. For example, if a DLCI comes from an FSU 5622 running on a 56K DDS line and is delivered to the ATLAS 550 on a full T1, the lower rate is 56000 and the value is 186 or 187. Entered values between 1 and 127 are adjusted upward.

DLCI STATE**Write security: 3; Read security: 5**

Controls how the state of this DLCI is reported to any packet connections within ATLAS 550 attempting to send or receive data on this DLCI.

AUTO	Passes the state as reported by the frame relay switch. Set DLCI STATE to AUTO for normal operation.
FORCE ACTIVE	This DLCI disregards the status as reported from the switch and reports Active to all packet endpoints within ATLAS 550.
FORCE INACTIVE	Reports status as DOWN to all packet endpoints within ATLAS 550.

DIAGNOSTIC MODE**Write security: 3; Read security: 5**

Controls operation of PVC testing options. To allow the far end to measure delay, select **ECHO FAR-END LOOPBACKS**. To continuously measure in-band delay, select **IN-BAND DELAY MEASUREMENT**. To turn off continuous diagnostic functions, select **PASS-THROUGH DIAGNOSTIC PACKETS**.

ECHO FAR-END LOOPBACKS

Generates and transmits a response on this DLCI to the remote equipment if an ADTRAN proprietary diagnostic message is received on this DLCI.

IN-BAND DELAY MEASUREMENT

Generates a diagnostic packet to measure delay through the frame relay network. This process requires that the equipment at the remote site be ADTRAN IQ compatible.

PASS-THROUGH DIAGNOSTIC PACKETS

Used when ATLAS 550 is acting as a frame relay switch. Transmits a diagnostic packet out the packet endpoint connected to this DLCI, if a diagnostic packet is received on this packet endpoint.

PRIMARY | BACKUP SELECTION**Write security: 3; Read security: 5**

Allows you to define a sublink as a primary or a backup sublink. **PRIMARY** defines a normal sublink and includes the menus **ENABLE BACKUP SUPPORT**, **BACKUP PACKET ENDPT**, and **BACKUP SUBLINK**. **BACKUP** defines a backup sublink and includes the menus **PRIMARY PACKET ENDPT** and **PRIMARY SUBLINK**.

ENABLE BACKUP SUPPORT**Write security: 3; Read security: 5**

(Available for Primary packet endpoints only.) **YES** displays the backup menus. **NO** hides the backup menus.

BACKUP PACKET ENDPT**Write security: 3; Read security: 5**

*(Visible only if **ENABLE BACKUP SUPPORT** is set to **YES**.)* Selects **BACKUP PACKET ENDPT** that contains the **BACKUP SUBLINK** to be tied to this sublink.

BACKUP SUBLINK**Write security: 3; Read security: 5**

*(Visible only if **ENABLE BACKUP SUPPORT** is set to **YES**.)* Selects the **BACKUP SUBLINK** to be tied to this sublink.

PRIMARY PACKET ENDPT**Write security: 3; Read security: 5**

(Visible only for Backup packet endpoints.) Selects the **PRIMARY PACKET ENDPT** that contains the **PRIMARY SUBLINK** to be tied to this sublink.

PRIMARY SUBLINK**Write security: 3; Read security: 5**

(Visible only for Backup packet endpoints.) Selects the **PRIMARY SUBLINK** to be tied to this sublink.



*The fields **BACKUP MODE**, **SWITCH ON SUBLINK DOWN**, **SWITCH ON LMI INACTIVE**, **SWITCH ON BACKUP ACTIVE**, **BACKUP DELAY IN SECONDS**, and **RESTORE DELAY IN SECONDS** display if **PRIMARY** (with **BACKUP SUPPORT**) or **BACKUP** is enabled.*

BACKUP MODE**Write security: 3; Read security: 5**

Provides switching options.

AUTO	Provides normal operation.
FORCED	Forces a switch to backup.
DISABLED	Disables backup switching.

SWITCH ON SUBLINK INACTIVE**Write security: 3; Read security: 5**

Provides switching options if the sublink goes down. Select **YES** to switch to backup if the primary sublink goes down, otherwise select **NO**.

SWITCH ON LMI DOWN**Write security: 3; Read security: 5**

Provides switching options for LMI signaling. Select **YES** to switch to backup if LMI signaling is inactive on the primary link, otherwise select **NO**.

SWITCH ON BACKUP ACTIVE**Write security: 3; Read security: 5**

Provides switching options if the backup sublink goes active. Select **YES** to switch to backup if the backup sublink goes active, otherwise select **NO**.

BACKUP DELAY IN SECONDS**Write security: 3; Read security: 5**

The amount of time within which any of the enabled switch criteria must be met before service is switched to the backup circuit.

RESTORE DELAY IN SECONDS**Write security: 3; Read security: 5**

The amount of time within which the criteria for switching to backup are reached before service is returned to the primary circuit.

PACKET MANAGER > PACKET ENDPNTS > CONFIG > USAGE**Read security: 5**

This field displays a 7-character summary of the references to this link. Each position is populated with a dash (-) or a character indicating the resource represented. The characters are as follows:

- 1** Packet connection in the first dedicated map
- 2** Packet connection in the second dedicated map
- 3** Packet connection in the third dedicated map
- 4** Packet connection in the fourth dedicated map
- 5** Packet connection in the fifth dedicated map
- Reserved and currently not is use
- S** Used as a Packet Endpoint in the switched dial plan
- U** Used by one or more packet switch connections or packet voice entries

PACKET MANAGER > PACKET ENDPNTS > TEST**Write security: 3; Read security: 5**

Provides menus for controlling options and setting for packet endpoints.

PACKET MANAGER > PACKET ENDPNTS > TEST > ENDPNT NAME**Write security: 3; Read security: 5**

Displays the name of the packet endpoint.

PACKET MANAGER > PACKET ENDPNTS > TEST > PROTOCOL**Write security: 3; Read security: 5**

Displays the protocol running on the packet endpoint.

PACKET MANAGER > PACKET ENDPNTS > TEST > SUBLINK - FRAME RELAY**Write security: 3; Read security: 5**

Displays test menus for the packet endpoint sublinks. The menus vary depending on the protocol. Testing is not supported on TBOP or PPP.

NAME**Read security: 5**

Displays the user-defined name for the DLCI.

DLCI**Read security: 5**

Displays the local address for each PVC as assigned by the carrier.

TEST**Write security: 3; Read security: 5**

Displays the test mode for the PVC.

START**Write security: 3; Read security: 5**

The fixed duration that Test is not running and the DLCI is not configured for continuous in-band delay measurement. To change this option, set **DIAGNOSTIC MODE** to **IN-BAND DELAY**

MEASUREMENT (also see *Packet Manager > Packet Endpnts > Config > Config - SDLC, In-band Delay Measurement option*).

CONTDLY**Write security: 3; Read security: 5**

The fixed duration **TEST** is not running and the DLCI is configured for continuous in-band delay measurement. The following **RESULTS** menu accumulates these measurements.

STOP**Write security: 3; Read security: 5**

The fixed duration **TEST** is running. The following **DURATION** field shows the time remaining in the current test.

DURATION**Read security: 5**

Shows the duration in seconds for the fixed-duration test.

RESULTS [MN/AV/MX DLY]**Read security: 5**

Displays the minimum, average, and maximum delay for the delay-measurement test. To display the additional test results, place the cursor over this field and press <Enter> on the keyboard. The displayed times are in milliseconds.

ECHO PKT TX**Read security: 5**

Displays the total number of test packets that have been transmitted.

ECHO PKT RX**Read security: 5**

Displays the total number of test packets that have been received.

ECHO PKT DROPPED**Read security: 5**

Displays the total number of packets lost in the receiving direction (traveling from the remote ADTRAN frame relay device to the ATLAS).

RMT PKT DROPPED**Read security: 5**

Displays the total number of packets lost in the transmit direction (traveling from the ATLAS to the remote ADTRAN frame relay device).

MIN DELAY**Read security: 5**

Displays the minimum round trip delay for the current test period.

MAX DELAY**Read security: 5**

Displays the maximum round trip delay for the current test period.

AVG DELAY**Read security: 5**

Displays the average round trip delay for the current test.

RESET COUNTERS**Write security: 3; Read security: 5**

Resets the counters.

PACKET MANAGER > PACKET ENDPNTS > ENDPT COUNT**Read security: 5**

Displays the total number of packet endpoints configured.

PACKET MANAGER > PACKET ENDPNTS > ENDPTS SORT**Write security: 3; Read security: 5**

Provides sorting options for the packet endpoints. **SORTING BY NAME** sorts packet endpoints alphabetically by name. If you do not want to sort packet endpoints, set this option to **OFF**.

PACKET MANAGER > PACKET CNCTS**Write security: 3; Read security: 5**

After packet endpoints are defined, they are connected in the packet connects (**PACKET CNCTS**) map. **PACKET CNCTS** connects upper layer protocols from packet endpoint to packet endpoint. You can think of it as a dedicated map for virtual ports rather than physical ports.

PACKET MANAGER > PACKET CNCTS > FROM: PEP**Write security: 3; Read security: 5**

Selects one packet endpoint for the packet connection. Packet endpoints created in the packet endpoint configuration are visible on a pull-down menu which includes the **ROUTER** option. This router is the internal ATLAS 550 router and can be used multiple times within the **PACKET CNCTS** menu.

PACKET MANAGER > PACKET CNCTS > SUBLINK**Write security: 3; Read security: 5**

If the packet endpoint selected in **FROM: PEP** supports sublinks, they are available in this menu. In frame relay, this is the PVC from which you are selecting to groom data.

PACKET MANAGER > PACKET CNCTS > TO: PEP**Write security: 3; Read security: 5**

Selects the other packet endpoint for the packet connection. Refer to **FROM: PEP** above for more detail.

PACKET MANAGER > PACKET CNCTS > SUBLINK**Write security: 3; Read security: 5**

If the **To: PEP** packet endpoint supports sublinks, the available sublinks are shown within this menu, which includes the **ROUTER** option.

PACKET MANAGER > PACKET CNCTS > PROTOCOL**Write security: 3; Read security: 5**

Selects the protocols for this packet connection. Selecting the protocols on each individual connection allows the mixing of data from multiple sources onto a single PVC. Available protocols include the following: **ALL**, **IP**, **BRIDGE IP**, **PACKET VOICE**, **SNA**, **SNAP**, and **TRANSPARENT PROTOCOLS (TBOP, TASYNC, and SDLC)**.

NOTE

1. *If **ALL** is selected, additional connections from that PVC are not allowed.*
2. *If **ROUTER** is selected as one packet endpoint, **IP** is automatically set as the **PROTOCOL**.*
3. *If a **TBOP** packet endpoint is selected as one packet endpoint, **TRANSPARENT** is automatically set as the **PROTOCOL**.*
4. *Selecting **SDLC** signaling on an endpoint requires a Legacy Data Module (P/N 1200342L1).*

PACKET MANAGER > PACKET CNCTS > CONFIG**Write security: 3; Read security: 5**

Determines data source and destination. The available options depend on the protocol selected.

CONFLICT	Indicates DLCI mismatch.
FROM	Indicates data source.
TO	Indicates data destination.

PACKET MANAGER > CNCTS SORT**Write security: 3; Read security: 5**

Determines the order in which connections are displayed within **PACKET CNCTS**. Options include **FROM PKT ENDPT/SUBLINK**, **TO PKT ENDPT/SUBLINK**, **CONNECTION PROTOCOL**, and **OFF**.

PACKET MANAGER > FRAME RELAY IQ**Write security: 2; Read security: 5**

Gathers and stores statistical information in the submenus **ENABLE IQ STATS**, **PORT ENABLES**, **CONFIG**, and **VIEW IQ STATISTICS**.

PACKET MANAGER > FRAME RELAY IQ > ENABLE IQ STATS**Write security: 2; Read security: 5**

Globally enables and disables IQ statistics gathering. IQ statistics are only gathered when this option is enabled. This field defaults to the original setting of [15 MIN, 7 DAYS, 96 INTS] when re-enabled.

PACKET MANAGER > FRAME RELAY IQ > PORT ENABLES**Write security: 2; Read security: 5**

Enables and disables IQ statistics gathering for each port. Use the submenus **NAME**, **ENABLE**, **ALL SUBLINKS**, and **SUBLINKS** to configure the individual ports.

PACKET MANAGER > FRAME RELAY IQ > PORT ENABLES > NAME**Read security: 5**

Displays the port number and name.

PACKET MANAGER > FRAME RELAY IQ > PORT ENABLES > ENABLE**Write security: 2; Read security: 5**

Enables and disables IQ statistics gathering for the port identified in **NAME**.

PACKET MANAGER > FRAME RELAY IQ > PORT ENABLES > ALL SUBLINKS**Write security: 2; Read security: 5**

Provides an easy way to enable or disable IQ statistics gathering on all sublinks. When this activator reads **DISABLE**, pressing <Enter> disables IQ statistics gathering on all sublinks. When it reads **ENABLE**, pressing <Enter> enables IQ statistics gathering on all sublinks.

PACKET MANAGER > FRAME RELAY IQ > PORT ENABLE > SUBLINKS**Write security: 2; Read security: 5**

Identifies the PVC to be polled. Indicates the number of sublinks that ATLAS 550 will collect IQ data for

within the given link.

NAME	Displays the user-designated name of the sublink (up to 15 characters).
DLCI	Displays the Data Link Connection Identifier (circuit number).
ENABLE	Indicates collection of IQ data for the target DLCI.

PACKET MANAGER > FRAME RELAY IQ > CONFIG

Write security: 2; Read security: 5

Sets the parameters for IQ statistics gathering.

PACKET MANAGER > FRAME RELAY IQ > CONFIG > CURRENT PIVS

Write security: 2; Read security: 5

Identifies resources used by IQ statistics storage. A PIV is a port or PVC per interval. ATLAS can track up to 10,000 PIVs. Think of it as a resource meter. The PIV number is derived from the **MAX DAYS** and **MAX INTERVALS** selected by the user. Changing one affects the other.

PACKET MANAGER > FRAME RELAY IQ > CONFIG > INTERVAL PERIOD

Write security: 2; Read security: 5

Sets the period for IQ statistics gathering. Options are **5, 10, 15, 20,** and **30 MINUTES**.

PACKET MANAGER > FRAME RELAY IQ > CONFIG > MAX DAYS

Write security: 2; Read security: 5

Defines the number of history day intervals to keep. Maximum entry is dependent on the **MAX INTERVALS** setting.

PACKET MANAGER > FRAME RELAY IQ > CONFIG > MAX INTERVALS

Write security: 2; Read security: 5

Defines the number of history intervals to keep. Maximum entry is dependent on the **MAX DAYS** setting.

PACKET MANAGER > FRAME RELAY IQ > VIEW IQ STATISTICS

Read security: 5

Displays statistical information gathered for intervals and days on a port and for intervals and days on sublinks (PVCs or DLCIs).

PACKET MANAGER > FRAME RELAY IQ > VIEW IQ STATISTICS > INTERVAL AND DAY

Read security: 5

Descriptions of the statistics available in the **INTERVAL** or **DAY** submenus follow:

RX FRAMES**Read security: 5**

The number of frames the port received for the interval or day.

RX BYTES**Read security: 5**

The number of bytes the port received for the interval or day.

MAX RX THRU**Read security: 5**

The maximum throughput the port received for the interval or day.

AVG RX THRU**Read security: 5**

The average throughput the port received for the interval or day.

MAX RX UTIL%**Read security: 5**

The maximum utilization the port received for the interval or day.

AVG RX UTIL%**Read security: 5**

The average utilization the port received for the interval or day.

TX FRAMES**Read security: 5**

The number of frames the port transmitted for the interval or day.

TX BYTES**Read security: 5**

The number of bytes the port transmitted for the interval or day.

MAX TX THRU**Read security: 5**

The maximum throughput the port transmitted for the interval or day.

AVG TX THRU**Read security: 5**

The average throughput the port transmitted for the interval or day.

MAX TX UTIL%
Read security: 5

The maximum utilization the port transmitted for the interval or day.

AVG TX UTIL%
Read security: 5

The average utilization the port transmitted for the interval or day.

PORT UA TIME
Read security: 5

Time, in seconds, the port is unavailable due to physical or frame relay outage.

SIG DOWN TIME
Read security: 5

Time, in seconds, the signaling state has been down.

SIGNAL ERROR
Read security: 5

The number of PVC signaling frames received with protocol violations.

SIGNAL T/O
Read security: 5

The number of PVC signal time-outs. Either T391 seconds elapsed without receiving a response to a poll or T392 seconds elapsed without receiving a poll.

SIG STATE CHG
Read security: 5

The number of state changes for the PVC signaling protocol. This number includes transitions from down state to up state and vice-versa.

RX FULL STAT
Read security: 5

The number of PVC-signaling, full-status frames received.

TX FULL STAT
Read security: 5

The number of PVC-signaling, full-status frames transmitted.

RX LI ONLY
Read security: 5

The number of PVC-signaling, link integrity only frames received.

TX LI ONLY**Read security: 5**

The number of PVC-signaling, link integrity only frames transmitted.

ASYNC STATUS**Read security: 5**

The number of single PVC status frames received.

DISCARD FRAME**Read security: 5**

The number of frames discarded by the IQ unit.

ABORTS**Read security: 5**

The number of frames received without proper flag termination.

CRC ERROR**Read security: 5**

The number of frames received with CRC errors.

OCTET ALIGN**Read security: 5**

The number of frames received with a bit count not divisible by eight.

LENGTH ERROR**Read security: 5**

The number of frames received that are less than 5 bytes or greater than 4500 bytes.

EA VIOLATION**Read security: 5**

The number of frames received with errors in the EA field of the frame relay header.

INACTIVE DLCI**Read security: 5**

The number of frames received while the PVC is in the inactive state.

INVALID DLCI**Read security: 5**

The number of frames received with a DLCI value less than 16 or greater than 1007, not including PVC signaling frames.

PACKET MANAGER > FRAME RELAY IQ > VIEW IQ STATISTICS > SUBLINK**Read security: 5**Descriptions of the statistics available in the **INTERVAL** or **DAY** submenus follow:**RX FRAMES****Read security: 5**

The number of frames the port received for the interval or day.

RX BYTES**Read security: 5**

The number of bytes the port received for the interval or day.

MAX RX THRU**Read security: 5**

The maximum throughput the port received for the interval or day.

AVG RX THRU**Read security: 5**

The average throughput the port received for the interval or day.

MAX RX UTIL%**Read security: 5**

The maximum utilization the port received for the interval or day.

AVG RX UTIL%**Read security: 5**

The average utilization the port received for the interval or day.

TX FRAMES**Read security: 5**

The number of frames the port transmitted for the interval or day.

TX BYTES**Read security: 5**

The number of bytes the port transmitted for the interval or day.

MAX TX THRU**Read security: 5**

The maximum throughput the port transmitted for the interval or day.

AVG TX THRU**Read security: 5**

The average throughput the port transmitted for the interval or day.

MAX TX UTIL%**Read security: 5**

The maximum utilization the port transmitted for the interval or day.

AVG TX UTIL%**Read security: 5**

The average utilization the port transmitted for the interval or day.

PVC IA TIME**Read security: 5**

Time, in seconds, the PVC has been in the inactive state for the interval or day.

Rx FECN**Read security: 5**

The number of FECNs the PVC has received for the interval or day.

Tx FECN**Read security: 5**

The number of FECNs the PVC has transmitted for the interval or day.

Rx DE**Read security: 5**

The number of DEs the PVC has received for the interval or day.

Tx DE**Read security: 5**

The number of DEs the PVC has transmitted for the interval or day.

Rx CR**Read security: 5**

The number of CRs the PVC has received for the interval or day.

Tx CR**Read security: 5**

The number of CRs the PVC has transmitted for the interval or day.

LOST FRAMES**Read security: 5**

The number of lost frames on the PVC for the interval or day.

RMT LOST FRMS**Read security: 5**

The number of remote lost frames on the PVC for the interval. Applies only if **IN-BAND SEQUENCE NUMBER** is **ENABLED** on the PVC.

RX BURST SEC**Read security: 5**

The number of bursty seconds the PVC received for the interval or day.

TX BURST SEC**Read security: 5**

The number of bursty seconds the PVC transmitted for the interval or day.

MIN RX FRAME**Read security: 5**

The minimum frame size the PVC received for the interval or day.

MAX RX FRAME**Read security: 5**

The maximum frame size the PVC received for the interval or day.

AVG RX FRAME**Read security: 5**

The average frame size the PVC received for the interval or day.

MIN TX FRAME**Read security: 5**

The minimum frame size the PVC transmitted for the interval or day.

MAX TX FRAME**Read security: 5**

The maximum frame size the PVC transmitted for the interval or day.

AVG TX FRAME**Read security: 5**

The average frame size the PVC transmitted for the interval or day.

MIN FRAME DLY**Read security: 5**

The minimum delay in milliseconds on the **PVC IN-BAND DELAY MEASUREMENT** is **ENABLED** (see *Packet Manager > Packet Endpnts > Config > Config - SDLC* on page 200, the **IN-BAND DELAY MEASUREMENT** option) for the PVC or if PVC diagnostics are being performed.

MAX FRAME DLY**Read security: 5**

The maximum delay in milliseconds on the PVC for the interval or day. Applies only if **IN-BAND DELAY MEASUREMENT** is **ENABLED** (see *Packet Manager > Packet Endpnts > Config > Config - SDLC* on page 200, the **IN-BAND DELAY MEASUREMENT** option) for the PVC or if PVC diagnostics are being performed.

AVG FRAME DLY**Read security: 5**

The average delay in milliseconds on the PVC for the interval or day. Applies only if **IN-BAND DELAY MEASUREMENT** is **ENABLED** (see *Packet Manager > Packet Endpnts > Config > Config - SDLC* on page 200, the **IN-BAND DELAY MEASUREMENT** option) for the PVC or if PVC diagnostics are being performed.

PVC STATE CHANGE**Read security: 5**

The number of state changes for this PVC for the interval or day.

ROUTER

The ATLAS 550 router uses the integral 10/100BaseT Ethernet port to transmit local area network (LAN) traffic over the wide area network (WAN) to a remote LAN. By integrating the router into the network access device, you benefit from the cost savings of not requiring an external router. To view the menu options for the Router, see Figure 15. All routing functions within the ATLAS are configured and monitored from the **ROUTER** menu.

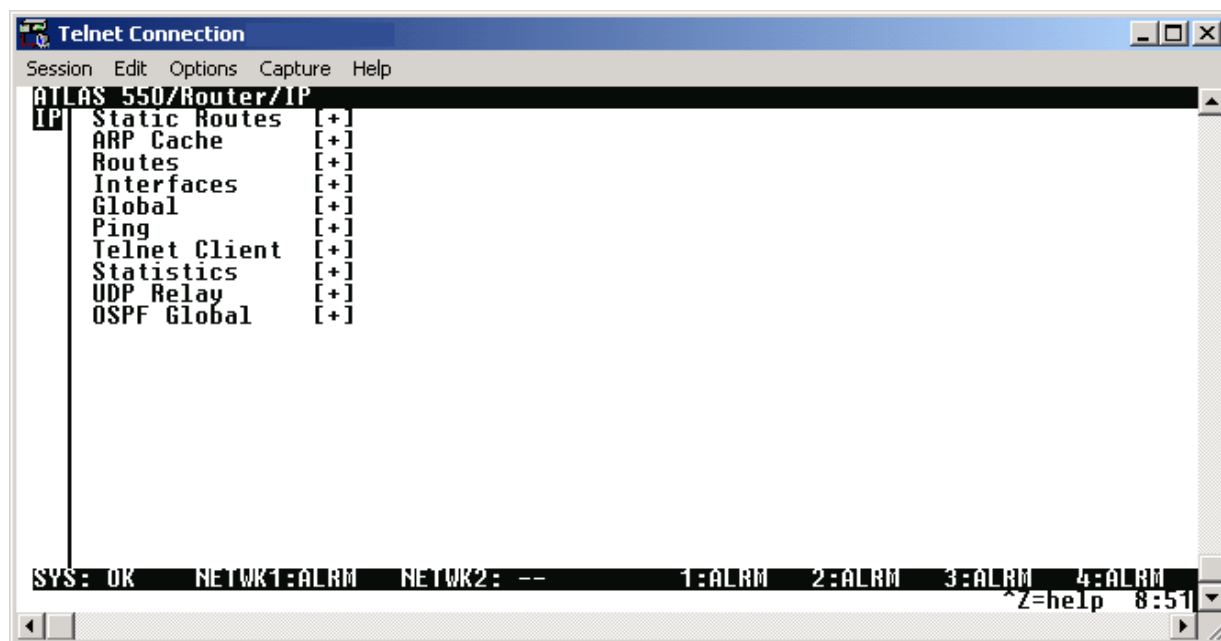

Figure 15. Router Menu (IP Selected)

ROUTER > IP > STATIC ROUTES

Write security: 2; Read security: 2

The **STATIC ROUTES** menu manages static IP routes. You can create, modify, and delete routes using this menu.

ROUTER > IP > STATIC ROUTES > IP ADDRESS

Write security: 2; Read security: 2

Defines the IP address of the host or network device being routed to.

ROUTER > IP > STATIC ROUTES > NETMASK

Write security: 2; Read security: 2

Determines the number of bits used in the above-defined IP address for routing. If a host address is entered for the IP address, this field must be set to 255.255.255.255.

ROUTER > IP > STATIC ROUTES > GATEWAY**Write security: 2; Read security: 2**

Defines the IP address of the router to receive the forwarded IP packet.

ROUTER > IP > STATIC ROUTES > INTERFACE**Write security: 2; Read security: 2**

Defines the interface (either Ethernet or frame relay DLCIs) to which IP packets with this address will be routed.

ROUTER > IP > STATIC ROUTES > HOPS**Write security: 2; Read security: 2**

Defines the number of router hops required to get to the network or host. Maximum distance is 15 hops.

ROUTER > IP > STATIC ROUTES > COST**Write security: 2; Read security: 2**

Defines the total cost of sending a packet to the selected network. Normally, the cost is based on the available bandwidth.

ROUTER > IP > STATIC ROUTES > ENABLED**Write security: 2; Read security: 2**

Adds a static route to the router.

ROUTER > IP > STATIC ROUTES > ADVERTISE**Write security: 2; Read security: 2**

When set to **YES**, this static route is advertised over all interfaces on which a route advertisement protocol (e.g., RIP) is enabled. When set to **NO**, this is a private route.

ROUTER > IP > ARP CACHE**Write security: 2; Read security: 2**

The **ARP CACHE** menu displays the contents of the ATLAS Address Resolution Protocol (ARP) cache. All resolved cache entries time out after 20 minutes. Unresolved entries time out in 3 minutes.

ROUTER > IP > ARP CACHE > IP ADDRESS**Read security: 2**

Displays the IP address used for resolving MAC address.

ROUTER > IP > ARP CACHE > MAC ADDRESS**Read security: 2**

Resolves Ethernet address. If set to all zeros, there is no resolution for that address.

ROUTER > IP > ARP CACHE > TIME**Read security: 2**

Displays the minutes since the entry was last referenced.

ROUTER > IP > ARP CACHE > TYPE**Read security: 2**Defines this entry as **DYNAMIC** or **STATIC**.**ROUTER > IP > ARP CACHE > INTERFACE****Read security: 2**

Displays the interface upon which this entry was found.

ROUTER > IP > ARP CACHE > TX PENDING**Read security: 2**

Displays the number of transmit packets pending a reply.

ROUTER > IP > ROUTES**Write security: 2; Read security: 2**The **ROUTES** menu displays the contents of the ATLAS routing table. All static and discovered routes are displayed from this menu.**ROUTER > IP > ROUTES > IP ADDRESS****Read security: 2**

Displays the IP address of the destination host or network.

ROUTER > IP > ROUTES > NETMASK**Read security: 2**

Displays the subnet mask applied to the destination address.

ROUTER > IP > ROUTES > GATEWAY**Read security: 2**

Displays the IP address of the next-hop router or host receiving the forwarded IP packet.

ROUTER > IP > ROUTES > INTERFACE**Read security: 2**

Displays the next-hop router or host interface through which IP packets are routed, as defined here:

LOCAL	Forwards the packet directly to the ATLAS router.
ENO IP	Forwards the packet through the ATLAS Ethernet port.
ENDPOINT NAME	Forwards the packet using the DLCI number.

ROUTER > IP > ROUTES > USED**Read security: 2**

Displays the number of times the router has referenced this route.

ROUTER > IP > ROUTES > CLR**Write security: 2; Read security: 2**

Clears the **USED** menu and resets the value to zero.

ROUTER > IP > ROUTES > FLAGS**Read security: 2**

Indicates the properties of this routing table entry, composed of the following letters:

- | | |
|-----------|--|
| H | - route is a host route |
| G | - route is a gateway route |
| DR | - route learned dynamically from RIP |
| I | - route learned from an ICMP redirect |
| A | - route learned from IARP |
| P | - route is private and is not advertised with RIP |
| T | - route is to a triggered port (updated only when table changes) |

ROUTER > IP > ROUTES > HOPS**Read security: 2**

Displays the number of router hops required to get to the network or host. Ranges from 0 to 16. If set to 16, the route is defined as infinite and cannot be used.

ROUTER > IP > ROUTES > COST**Read security: 2**

Displays the total cost of sending a packet to the specified network. Normally, the cost is based on the available bandwidth.

ROUTER > IP > ROUTES > TTL**Read security: 2**

Displays the number of seconds until the address is removed from table. A value of **999** means the route is static.

ROUTER > IP > INTERFACES**Write security: 2; Read security: 2**

The **INTERFACES** menu configures and monitors all interfaces connected to the ATLAS router. These include the Ethernet and frame relay DLCIs connected in the **PACKET MANAGER/ PACKET CNCTS**.

ROUTER > IP > INTERFACES > NETWORK NAME**Read security: 2**

Displays the name of the interface connected to the ATLAS router, as follows:

ENO IP	ATLAS Ethernet port
ENDPOINT NAME	DLCI Number

ROUTER > IP > INTERFACES > ADDRESS**Write security: 2; Read security: 2**

Defines the individual interface IP address. If this field is left as **0.0.0.0**, it is treated as an unnumbered interface.

ROUTER > IP > INTERFACES > SUBNET MASK**Write security: 2; Read security: 2**

Defines the subnet mask applied to the address defined for this link. If the interface IP address is unnumbered, leave as **0.0.0.0**.

ROUTER > IP > INTERFACES > IARP**Write security: 2; Read security: 2**

The Inverse ARP (**IARP**) menu is only present when this interface is a frame-relay network interface. ATLAS sends Inverse ARP packets to determine the IP address on the other end of the virtual circuit. ATLAS always responds to Inverse ARP requests with its IP address for the requested DLCI.

ENABLE	Causes ATLAS to dynamically send Inverse ARP packets to determine the IP address on the other end of the virtual circuit. When an Inverse ARP packet is not responded to, no route is placed in the IP route table. If the Inverse ARP packet is responded to, a route is placed in the IP route table.
DISABLE	Instructs ATLAS not to generate Inverse ARP request packets. In this case, the FAR-END ADDRESS parameter may be used to statically assign a route address (see the following, Far-End Address).

ROUTER > IP > INTERFACES > FAR-END ADDRESS**Write security: 2; Read security: 2**

This menu is only present for frame-relay network interfaces, and it is only selectable when **IARP** is disabled. Use this menu to specify the IP address of the device on the other end of the virtual circuit. If that IP address is non-zero, a static route to the far-end network will be added using the interface **SUBNET-MASK**. If **0.0.0.0** has been specified for the **SUBNET-MASK**, a default subnet mask is used, based on the class of the Far-End Address.

ROUTER > IP > INTERFACES > MTU**Write security: 2; Read security: 2**

Defines maximum number of bytes in a datagram transmitted over this interface (Maximum Transmit Unit).

ROUTER > IP > INTERFACES > RIP**Write security: 2; Read security: 2**

Configures routing information protocol (RIP) on this interface.

MODE**Write security: 2; Read security: 2**

Allows RIP to be enabled or disabled on a per-interface basis.

TX ONLY	RIP advertisements are periodically transmitted, but are not listened to on this virtual circuit.
RX ONLY	RIP advertisements are not transmitted on this virtual circuit, but they are listened to.
TX AND RX	RIP advertisements are periodically transmitted and are listened to on this virtual circuit.

**NOTE***If RIP/MODE is OFF, PROTOCOL, METHOD, and UPDATE will not be visible.***PROTOCOL****Write security: 2; Read security: 2***(Only visible if RIP is enabled.)* Sets the version of RIP being used on this interface. The options are **RIP V1** and **RIP V2**. If **RIP V2** is used, a new menu, **AUTHENTICATION**, opens.**NOTE***If RIP V2 is used, a user-defined secret may have to be created.***METHOD****Write security: 2; Read security: 2***(Only visible if RIP is enabled.)* Defines the method used to send RIP route advertisements. The options are listed below:

NONE	All routes in the router table are advertised through this interface with no modification of the routing metric.
SPLIT HORIZON	Only advertises routes not learned through this interface.
POISON REVERSE	All routes are advertised, but the routes learned through this interface are “poisoned” with an infinite route metric.

UPDATES**Write security: 2; Read security: 2**

Defines when RIP advertisements are transmitted.

PERIODIC

RIP advertisements are periodically transmitted.

TRIGGERED

RIP advertisements are transmitted only when new routes are learned, and learned routes do not age.

AUTHENTICATION**Write security: 2; Read security: 2**

Defines the secret used to advertise routes when using RIP V2.

REDISTRIBUTE DEFAULT GATEWAY**Write security: 2; Read security: 2**

Enables or disables the transmission of the Default Gateway to be sent with RIP on a per interface basis.

ROUTER > IP > INTERFACES > PROXY ARP**Write security: 2; Read security: 2**

Enables or disables Proxy ARP on this interface. Allows the network portion of a group of addresses to be shared among several physical network segments. When **ENABLED**, and an ARP (address resolution protocol) request is received on the Ethernet port, the address is looked-up in the IP routing table. If the forwarding port is not on the Ethernet port and the route is not the default route, the router answers the request with its own hardware address. When **DISABLED** (default), the router only responds to ARP request received for its own address.

The ARP protocol itself provides a way for devices to create a mapping between physical (i.e., Ethernet) addresses and logical IP addresses. **PROXY ARP** uses the mapping feature by instructing a router to answer ARP requests as a “proxy” for the IP addresses behind one of its ports. The device which sent the ARP request then correctly assumes that it can reach the requested IP address by sending packets to the physical address that was returned. This technique effectively hides the fact that a network has been (further) subnetted.

ROUTER > IP > GLOBAL**Write security: 2; Read security: 2**

Provides a way to configure various settings for the Ethernet port. The following menus are available for review and editing:

ROUTER > IP > GLOBAL > DEFAULT GATEWAY**Write security: 2; Read security: 2**

Defines or changes the default gateway. Enter the default gateway address by entering a decimal number into the appropriate field and then pressing <Enter> to move to the next field. You will need a default gateway if the LAN contains multiple segments. This address is composed of four decimal numbers, each in the range of 0 to 255, separated by periods. This value is set to **0.0.0.0** by default. Contact your LAN administrator for the appropriate address.

ROUTER > IP > GLOBAL > DEFAULT METRIC**Write security: 2; Read security: 2**

Defines the default gateway metric. Enter the default gateway metric by pressing <Enter> and entering a decimal number.

ROUTER > IP > GLOBAL > DEFAULT GATEWAY COST**Write security: 2; Read security: 2**

Defines the default gateway cost. Enter the default gateway metric by pressing <Enter> and entering a decimal number.

ROUTER > IP > PING**Write security: 2; Read security: 2**

Allows you to send pings (ICMP requests) to devices accessible via the network.



Only one ping session can be active at a time.

ROUTER > IP > PING > IP ADDRESS**Write security: 2; Read security: 2**

Specifies the IP address to ping.

ROUTER > IP > PING > COUNT**Write security: 2; Read security: 2**

Specifies the number of pings to send. The maximum value is 99.

ROUTER > IP > PING > SIZE**Write security: 2; Read security: 2**

Specifies the size in bytes of the data portion of the ping request. The default value is 64 bytes, and the maximum size is 1024 bytes.

ROUTER > IP > PING > TIMEOUT**Write security: 2; Read security: 2**

Specifies the time in milliseconds to wait for the ping reply before timing out. The default timeout is three seconds, and the maximum timeout value is ten seconds.

ROUTER > IP > PING > ROUND TRIP MIN**Read security: 2**

Displays the minimum round trip time of the ping request/reply of the current set of pings.

ROUTER > IP > PING > ROUND TRIP AVG**Read security: 2**

Displays the average round trip time of the ping request/reply of the current set of pings.

ROUTER > IP > PING > ROUND TRIP MAX**Read security: 2**

Displays the maximum round trip time of the ping request/reply of the current set of pings.

ROUTER > IP > PING > TX STATS**Read security: 2**Displays the number of ping requests transmitted (**n txed**), the number of ping replies received (**n rxed**) and the number of ping requests that were lost (**n lost**).**ROUTER > IP > PING > RESET STATS****Write security: 2; Read security: 2**

Resets all ping statistics to zero. If the ping client is active, this menu will stop it.

ROUTER > IP > PING > START/STOP**Write security: 2; Read security: 2**

If the ping client is currently idle, this menu sends pings to the specified address. If the ping client is active, the menu stops sending pings.

ROUTER > IP > TELNET CLIENT**Write security: 2; Read security: 2**

Allows a user to open a Telnet session to any device listed in the ATLAS 550 route table.

ROUTER > IP > TELNET CLIENT > ADDRESS**Write security: 2; Read security: 2**

Defines the IP address assigned to the remote unit you are trying to connect to.

ROUTER > IP > TELNET CLIENT > ESCAPE CHAR**Write security: 2; Read security: 2**Defines the Telnet client escape character. Typing the combination characters will close the active Telnet session to the remote unit specified in the **ADDRESS** field.

OPTION	KEYSTROKE
^]	<Ctrl> +]
^ \	<Ctrl> + \
^ [<Ctrl> + [
^ ^	<Ctrl> + <Shift> + 6
^ _	<Ctrl> + <Shift> + -

ROUTER > IP > TELNET CLIENT > PORT**Write security: 2; Read security: 2**Defines the port used in the remote login session. Default (for Telnet) is **23**.**ROUTER > IP > TELNET CLIENT > CONNECT****Write security: 2; Read security: 2**Activator used to start a Telnet session to the remote unit configured in the **ADDRESS** field.**ROUTER > IP > STATISTICS****Write security: 2; Read security: 2**This section describes the following **STATISTICS** submenus (see the tables below and on the pages following):

- IP (see Table 6)
- ICMP (see Table 7 on page 229)
- TCP (see Table 8 on page 230)
- UDP (see Table 9 on page 231)
- IP Fast Cache (see Table 10 on page 231)

All of these statistics are taken from the MIB-II variables in RFC 1156. To clear the accumulated statistics, press <Enter> or **CLEAR**.**Table 6. IP Statistics**

Name	Description
FORWARDING	The indication of whether this ATLAS 550 is acting as an IP gateway in respect to the forwarding of datagrams received by, but not addressed to, this ATLAS 550. IP gateways forward datagrams; hosts do not (except those Source-Routed via the host).
DEFAULT TTL	The default value inserted into the Time-To-Live field of the IP header of datagrams originated at this ATLAS 550, whenever a TTL value is not supplied by the transport layer protocol.
INRECEIVES	The total number of input datagrams received from interfaces, including those received in error.
INHDRERRORS	The number of input datagrams discarded due to errors in their IP headers, including bad checksums, version number mismatch, other format errors, time-to-live exceeded, errors discovered in processing their IP options, etc.
INADDRERRORS	The number of input datagrams discarded because the IP address in their IP header's destination field was not a valid address to be received at this ATLAS 550. This count includes invalid addresses (e.g., 0.0.0.0) and addresses of unsupported Classes (e.g., Class E). For entities which are not IP Gateways and therefore do not forward datagrams, this counter includes datagrams discarded because the destination address was not a local address.

Table 6. IP Statistics (Continued)

Name	Description
FORWDATAGRAMS	The number of input datagrams for which this ATLAS 550 was not their final IP destination, as a result of which an attempt was made to find a route to forward them to that final destination. In entities which do not act as IP Gateways, this counter will include only those packets which were Source-Routed via this ATLAS 550, and the Source-Route option processing was successful.
INUNKNOWNPROTOS	The number of locally-addressed datagrams received successfully but discarded because of an unknown or unsupported protocol.
INDISCARDS	The number of input IP datagrams for which no problems were encountered to prevent their continued processing, but which were discarded (e.g., for lack of buffer space). Note that this counter does not include any datagrams discarded while awaiting re-assembly.
INDELIVERS	The total number of input datagrams successfully delivered to IP user-protocols (including ICMP).
OUTREQUESTS	The total number of IP datagrams which local IP user-protocols (including ICMP) supplied to IP in requests for transmission. Note that this counter does not include any datagrams counted in FORWDATAGRAMS .
OUTDISCARDS	The number of output IP datagrams for which no problem was encountered to prevent their transmission to their destination, but which were discarded (e.g., for lack of buffer space). Note that this counter would include datagrams counted in FORWDATAGRAMS if any such packets met this (discretionary) discard criterion.
OUTNOROUTES	The number of IP datagrams discarded because no route could be found to transmit them to their destination. Note that this counter includes any packets counted in FORWDATAGRAMS which meet this “no-route” criterion. Note also that this includes any datagrams which a host cannot route because all of its default gateways are down.
REASMTIMEOUT	The maximum number of seconds which received fragments are held while they are awaiting reassembly at this ATLAS 550.
REASMREQDS	The number of IP fragments received which needed to be reassembled at this ATLAS 550.
REASMOKS	The number of IP datagrams successfully reassembled.
REASMFALS	The number of failures detected by the IP reassembly algorithm (for whatever reason: timed out, errors, etc.). Note that this is not necessarily a count of discarded IP fragments since some algorithms (notably RFC 815s) can lose track of the number of fragments by combining them as they are received.
FRAGOKS	The number of IP datagrams that have been successfully fragmented at this ATLAS 550.
FRAGFALS	The number of IP datagrams that have been discarded because they needed to be fragmented at this ATLAS 550 but could not be, e.g., because their “Don't Fragment” flag was set.

Table 6. IP Statistics (Continued)

Name	Description
FRAGCREATES	The number of IP datagram fragments that have been generated as a result of fragmentation at this ATLAS 550.
CLEAR	Clears the accumulated statistics.

Table 7. ICMP Statistics

Name	Description
INMSGs	The total number of ICMP messages which the ATLAS 550 received. Note that this counter includes all those counted by INERRORS .
INERRORS	The number of ICMP messages which the ATLAS 550 received but determined as having errors (bad ICMP checksums, bad length, etc.)
INDESTUNREACHS	The number of ICMP Destination Unreachable messages received.
INTIMEEXCDS	The number of ICMP Time Exceeded messages received.
INPARMPROBS	The number of ICMP Parameter Problem messages received.
INSRQQUENCHS	The number of ICMP Source Quench messages received.
INREDIRECTS	The number of ICMP Redirect messages received.
INECHOS	The number of ICMP Echo (request) messages received.
INECHOREPS	The number of ICMP Echo Reply messages received.
INTIMESTAMPS	The number of ICMP Timestamp (request) messages received.
INTIMESTAMPREPS	The number of ICMP Timestamp Reply messages received.
INADDRMASKS	The number of ICMP Address Mask Request messages received.
INADDRMASKREPS	The number of ICMP Address Mask Reply messages received.
OUTMSGs	The total number of ICMP messages which this ATLAS 550 attempted to send. Note that this counter includes all those counted by ICMPOUTERRORS .
OUTERRORS	The number of ICMP messages which this ATLAS 550 did not send due to problems discovered within ICMP such as a lack of buffers. This value should not include errors discovered outside the ICMP layer such as the inability of IP to route the resultant datagram. In some implementations there may be no types of error which contribute to this counter's value.
OUTDESTUNREACHS	The number of ICMP Destination Unreachable messages sent.
OUTTIMEEXCDS	The number of ICMP Time Exceeded messages sent.
OUTPARMPROBS	The number of ICMP Parameter Problem messages sent.
OUTSRQQUENCHS	The number of ICMP Source Quench messages sent.
OUTREDIRECTS	The number of ICMP Redirect messages sent.

Table 7. ICMP Statistics (Continued)

Name	Description
OUTECHOS	The number of ICMP Echo (request) messages sent.
OUTECHOREPS	The number of ICMP Echo Reply messages sent.
OUTTIMESTAMPS	The number of ICMP Timestamp (request) messages sent.
OUTTIMESTAMPREPS	The number of ICMP Timestamp Reply messages sent.
OUTADDRMASKS	The number of ICMP Address Mask Request messages sent.
OUTADDRMASKREPS	The number of ICMP Address Mask Reply messages sent.
CLEAR	Clears the accumulated statistics.

Table 8. TCP Statistics

Name	Description
RTOALGORITHM	The algorithm used to determine the timeout value used for retransmitting unacknowledged octets.
RTOMIN	The minimum value permitted by a TCP implementation for the retransmission timeout, measured in milliseconds. More refined semantics for objects of this type depend upon the algorithm used to determine the retransmission timeout. In particular, when the timeout algorithm is rsre(3), an object of this type has the semantics of the LBOUND quantity described in RFC 793.
RTOMAX	The maximum value permitted by a TCP implementation for the retransmission timeout, measured in milliseconds. More refined semantics for objects of this type depend upon the algorithm used to determine the retransmission timeout. In particular, when the timeout algorithm is rsre(3), an object of this type has the semantics of the UBOUND quantity described in RFC 793.
MAXCONN	The limit on the total number of TCP connections the ATLAS 550 can support. In entities where the maximum number of connections is dynamic, this object should contain the value -1.
ACTIVEOPENS	The number of times TCP connections have made a direct transition to the SYN-SENT state from the CLOSED state.
PASSIVEOPENS	The number of times TCP connections have made a direct transition to the SYN-RCVD state from the LISTEN state.
ATTEMPTFAILS	The number of times TCP connections have made a direct transition to the CLOSED state from either the SYN-SENT state or the SYN-RCVD state, plus the number of times TCP connections have made a direct transition to the LISTEN state from the SYN-RCVD state.
ESTABRESETS	The number of times TCP connections have made a direct transition to the CLOSED state from either the ESTABLISHED state or the CLOSE-WAIT state.

Table 8. TCP Statistics (Continued)

Name	Description
CURRESTAB	The number of TCP connections for which the current state is either ESTABLISHED or CLOSE-WAIT.
INSEGS	The total number of segments received, including those received in error. This count includes segments received on currently established connections.
OUTSEGS	The total number of segments sent, including those on current connections but excluding those containing only retransmitted octets.
RETRANSSEGS	The total number of segments retransmitted - that is, the number of TCP segments transmitted containing one or more previously transmitted octets.
CLEAR	Clears the accumulated statistics.

Table 9. UDP Statistics

Name	Description
INDATAGRAMS	The total number of UDP datagrams delivered to UDP users.
NOPORTS	The total number of received UDP datagrams for which there was no application at the destination port.
INERRORS	The number of received UDP datagrams that could not be delivered for reasons other than the lack of an application at the destination port.
OUTDATAGRAMS	The total number of UDP datagrams sent from this ATLAS 550.
CLEAR	Clears the accumulated statistics.

Table 10. IP Fast Cache Statistics

Name	Description
HITS	Total number of times the ATLAS 550 went into the Fast Cache and successfully retrieved an IP address.
MISSES	Total number of times the ATLAS 550 went into the Fast Cache and failed to retrieve an IP address.
CLEAR	Clears the accumulated statistics.

ROUTER > IP > STATISTICS > CLEAR

Write security: 2; Read security: 2

Clears current statistics in the IP, ICMP, TCP, UDP, and IP Fast Cache statistics tables.

ROUTER > IP > UDP RELAY**Write security: 2; Read security: 2**

Allows the router to act as a relay agent for UDP (User Datagram Protocol) broadcast packets. Normally, a router will not forward UDP broadcast packets. However, many network applications use UDP broadcasts to configure addresses, host names, and other information. If hosts using these protocols are not on the same network segment as the servers providing the information, the client programs will not receive a response without enabling the UDP relay agent.

ROUTER > IP > UDP RELAY > ENABLE**Write security: 2; Read security: 2**

Enables/disables the router to act as a relay agent.

ROUTER > IP > UDP RELAY > RELAY TABLE**Write security: 2; Read security: 2**

(Available only when UDP Relay is **ENABLED**.) Lists up to four relay destination servers (**RELAY TABLE 0-3**). Each server can be configured using the following menus: **ENABLE**, **IP**, and **UDP**.

ENABLE**Write security: 2; Read security: 2**

Enables/disables this field. Select either **STANDARD** or **SPECIFIED**. (**DISABLE** is not used.)

**STANDARD
(DEFAULT)**

Relays any of the following standard UDP protocols: DHCP, TFTP, DNS, NTP (Network Time Protocol, port 123), NBNS (NetBIOS Name Server, port 137), NBDG (Net BIOS Datagram, port 138), and BootP.

SPECIFIED

Specifies the UDP port (1 to 65,535) in the UDP Port columns (maximum of three per server).

IP**Write security: 2; Read security: 2**

Defines the IP address of the server that receives the relay packet.

UDP PORTS 1 - 3**Write security: 2; Read security: 2**

Specifies the UDP ports to relay. These fields are active only when **ENABLE** is set to **SPECIFIED**.

DEDICATED MAPS

The **DEDICATED MAPS** menu assigns dedicated connections between any two ports in the ATLAS 550. This section describes the **DEDICATED MAPS** menu items (see Figure 16). These options are module-dependent; that is, the menu items available depend on the module selected.

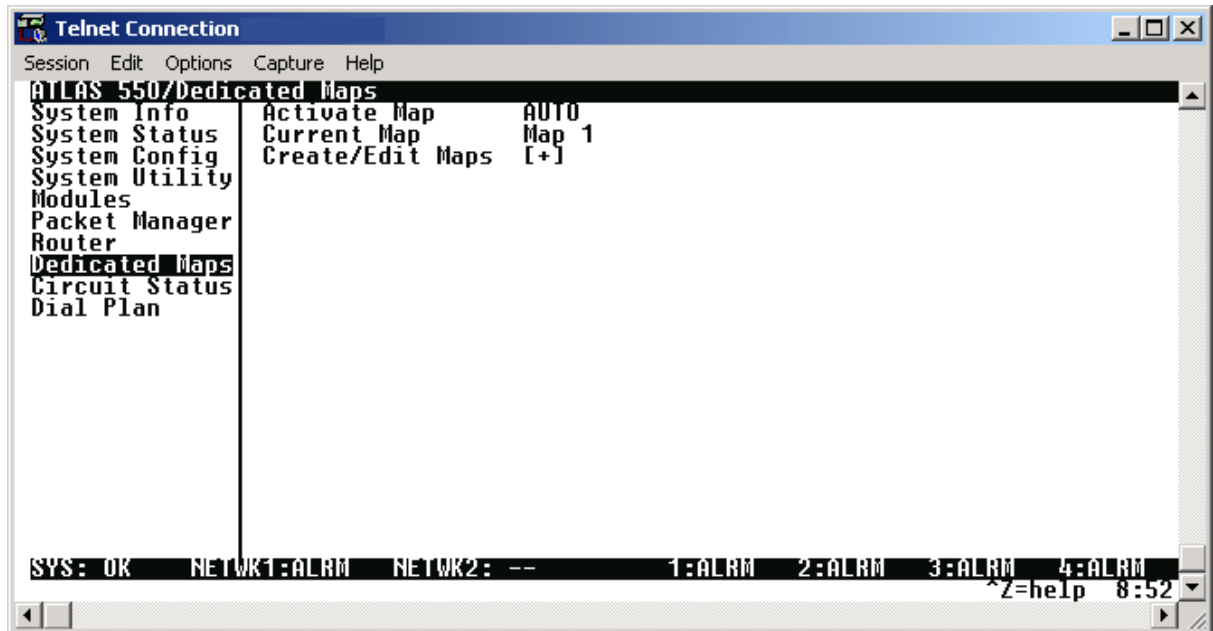

Figure 16. Dedicated Maps Menu

DEDICATED MAPS > ACTIVATE MAP

Write security: 3; Read security: 5

Activates a dedicated map—automatically or manually. You can have up to five different dedicated maps, each with an optionally specified name. The configuration choices are:

- | | |
|-------------------------|---|
| AUTO | Automatically activates a particular dedicated map at the time and day specified in the ACTIVATE TIME field. |
| MAPS 1 THROUGH 5 | Allows you to manually activate a specific dedicated map. To manually activate a dedicated map, highlight the ACTIVATE MAP field and press <Enter>. Choose the desired dedicated map from the popup menu list. |

DEDICATED MAPS > CURRENT MAP

Read security: 5

Displays the name of the currently active dedicated map (read-only).

DEDICATED MAPS > CREATE/EDIT MAPS**Write security: 3; Read security: 5**

Creates new maps and defines settings, as well as edits existing maps. To add a new map, position the cursor in the index column and press < I >. ATLAS 550 automatically names the maps in the sequence in which they are created. You can change the names with **MAP NAME**.

DEDICATED MAPS > CREATE/EDIT MAPS > #**Write security: 3; Read security: 5**

Displays the index number of the available maps.

DEDICATED MAPS > CREATE/EDIT MAPS > MAP NAME**Write security: 3; Read security: 5**

Displays the name of the dedicated map. The name can contain up to 57 alpha-numeric characters, including spaces and special characters. To edit the name, press <Enter> and type in the new name.

DEDICATED MAPS > CREATE/EDIT MAPS > SORT TO/FROM**Write security: 3; Read security: 5**

Specifies sort order based on the end points set in **CONNECTS/FROM CONFIG** and **CONNECTS/TO CONFIG**. You can also turn **OFF** this option. The sort feature is helpful when you are attempting to find a particular connection in a large connection list.

DEDICATED MAPS > CREATE/EDIT MAPS > CONNECTS**Write security: 3; Read security: 5**

Enters the dedicated map connections. Press <Enter> to activate the submenus.

 **NOTE**

*Some of the options available in this submenu change depending on the type of modules selected in the **FROM** or **TO** fields. For more information on these submenus, refer to the individual module discussions in this section.*

 **NOTE**

*You must return to **DEDICATED MAPS** in the **MAIN MENU** for changes to take effect.*

DEDICATED MAPS > CREATE/EDIT MAPS > CONNECTS > FROM SLT**Write security: 3; Read security: 5**

Specifies the slot to use for the **FROM** connection. When you select this option, a list of all of the slots and the modules installed in the slots displays. Select the appropriate slot and press <Enter>.

DEDICATED MAPS > CREATE/EDIT MAPS > CONNECTS > PORT**Write security: 3; Read security: 5**

Specifies the port to use for the **FROM** connection. When you select this option, a list of ports and module types appears. Select the appropriate port and module type, and press <Enter>.

DEDICATED MAPS > CREATE/EDIT MAPS > CONNECTS > TO SLOT/SERVICE**Write security: 3; Read security: 5**

Specifies the slot to use for the second end of a connection. Select this option, and a list of all of the slots and the modules installed in the slots displays. Pick the appropriate slot and press <Enter>. A **PKTENDPT** or **PKTVOICE** endpoint may also be selected as the service for the connection.

DEDICATED MAPS > CREATE/EDIT MAPS > CONNECTS > PORT/PEP**Write security: 3; Read security: 5**

Specifies the port to use for the second end of a connection. When you select this option, a list of ports and module types appears. Select the appropriate port and module type, and press <Enter>. If a **PKTENDPT** or **PKTVOICE** endpoint is selected for the **To SLOT/SERVICE** field, the available packet endpoints or packet voice endpoints will display in the drop down menu after pressing <Enter>.

DEDICATED MAPS > CREATE/EDIT MAPS > CONNECTS > FROM CONFIG**Write security: 3; Read security: 5**

Specifies the configuration for the **FROM** connection. The selections displayed in this field are based on the type of module selected in the **FROM SLT** option. For detailed information on submenus for a particular module type, please refer to the **DEDICATED MAPS** menu discussion for the appropriate network, option, or resource module.

DEDICATED MAPS > CREATE/EDIT MAPS > CONNECTS > TO CONFIG**Write security: 3; Read security: 5**

Specifies the configuration for the **To** connection. The selections displayed in this field are based on the type of module selected in the **To SLT** option. For detailed information on submenus for a particular module type, please refer to the **DEDICATED MAPS** menu discussion for the appropriate network, option, or resource module.

DEDICATED MAPS > CREATE/EDIT MAPS > CONNECTS > SIG**Write security: 3; Read security: 5**

Specifies whether the ATLAS 550 uses active Robbed-Bit Signaling (RBS) on the connection. Selecting **ON** allows the ATLAS 550 to preserve signaling bits between the two endpoints of the connection. Selecting **OFF** ignores the signaling bits of the connection. This selection is automatically set to **OFF** when RBS does not apply. For example, a T1-to-Nx connection is set to **OFF**.

DEDICATED MAPS > CREATE/EDIT MAPS > ACTIVATE TIME**Write security: 3; Read security: 5**

Sets the time when the map becomes active if you have selected **AUTO** in the **ACTIVATE MAP** field. Enter this time in hh:mm:ss 24-hour format.

DEDICATED MAPS > CREATE/EDIT MAPS > ENBL DAY**Security level: 3; Read security: 5**

Specifies which days of the week the map is active.

DEDICATED MAPS (T1/PRI NETWORK OR DUAL/QUAD T1/PRI MODULES)**DEDICATED MAPS (T1/PRI) > CREATE/EDIT MAPS > CONNECTS****Write security: 3; Read security: 5**

Enters the dedicated map connections. Press <Enter> to activate the submenus.

DEDICATED MAPS (T1/PRI) > CREATE/EDIT MAPS > CONNECTS > TO/FROM CONFIG**Write security: 3; Read security: 5**Specifies the configuration for the **TO/FROM** connection. The following selections may apply to the T1/PRI Network Interface and Dual/Quad T1/PRI Option Modules, depending on the application:**DS0 SELECTION****Write security: 3; Read security: 5**Defines DS0s for a T1 port. Use this field to define the DS0s for this connection. You can enter the DS0s in several ways. For example, to enter DS0s one through five, enter **1-5**. For DS0s one and five, enter **1,5**.**DS0 AVAILABLE****Write security: 3; Read security: 5**

Indicates which DS0s of the T1 are assigned. DS0 assignment is based on the following items.

DIGIT 0-9	This DS0 is available. The digit that displays in this field represents the last digit of the DS0 number.
*	This DS0 has been requested for this connection, but the DS0 is not yet activated for this port.
!	This DS0 is used by this port in this connection and is currently activated.
S	This DS0 is used in the switched DIAL PLAN .
S	This DS0 is used in the switched DIAL PLAN and conflicts with this connection.
N	This DS0 is already used in this DEDICATED MAP .
N	This DS0 is already used in this DEDICATED MAP and conflicts with this connection.

DS0 RATE**Write security: 3; Read security: 5**Sets the DS0 rate to either 56 or 64 kbps. This field is only valid for T1 ports mapped to a **PKT ENDPNT**.

T1 TRUNK CONDITIONING SERVICE**Write security: 3; Read security: 5**

Sets known values in the signaling bits and the data field for outgoing DS0s which are cross-connected to a T1 port experiencing alarms.

The trunk conditioning process consists of a 2.5 second transmission (indicating call termination), followed by a continuous transmission signaling the final condition as chosen by the user. This selection is only valid for T1 ports having **RBS** set to **ON**.

This option defines to ATLAS 550 the type of signaling being used on the trunk: **E&M, LS/GS NETWORK OR USER, SW56**, or **CUSTOM**.

T1 TRUNK CONDITIONING STATE**Write security: 3; Read security: 5**

*(Available only when **T1 TRUNK CONDITIONING SERVICE** is enabled.)* Defines the final fault signaling state.

IDLE	Used for one-way trunks; that is, for outgoing or incoming calls only – not both.
SEIZED	Used for two-way trunks. Prevents connected equipment from attempting to use a failed trunk for an outgoing call.

T1 FAULT SIGNALING**Write security: 3; Read security: 5**

*(Available only when **T1 TRUNK CONDITIONING SERVICE** is enabled.)* Displays the final fault signaling state of the AB bits. This field is read-only unless **CUSTOM** is chosen for the **T1 TRUNK CONDITIONING SERVICE** option.

T1 TROUBLE CODE VALUE**Write security: 3; Read security: 5**

*(Available only when **T1 TRUNK CONDITIONING SERVICE** is enabled.)* Displays the Hex value of the 2.5 second pre-alarm transmission.

DEDICATED MAPS (E1/PRA NETWORK INTERFACE)**DEDICATED MAPS (E1/PRA) > CREATE/EDIT MAPS > CONNECTS****Write security: 3; Read security: 5**

Enters the dedicated map connections. Press <Enter> to activate the submenus.

DEDICATED MAPS (E1/PRA) > CREATE/EDIT MAPS > CONNECTS > TO/FROM CONFIG**Write security: 3; Read security: 5**

Specifies the configuration for the **TO/FROM** connection. The following selections may apply to the E1/PRA Network Interface Module, depending on the application:

TS0 SELECTION**Write security: 3; Read security: 5**

Defines TS0s for an E1 port. Use this field to define the TS0s for this connection. You can enter the TS0s in several ways. For example, to enter TS0s one through five, enter **1-5**. For TS0s one and five, enter **1,5**.

TS0 AVAILABLE**Write security: 3; Read security: 5**

Indicates which TS0s of the E1 are assigned. TS0 assignment is based on the following items:

DIGIT 0-9	This TS0 is available. The digit that displays in this field represents the last digit of the TS0 number.
*	This TS0 has been requested for this connection, but the TS0 is not yet activated for this port.
!	This TS0 is used by this port in this connection and is currently activated.
S	This TS0 is used in the switched DIAL PLAN .
S	This TS0 is used in the switched DIAL PLAN and conflicts with this connection.
N	This TS0 is already used in this DEDICATED MAP .
N	This TS0 is already used in this DEDICATED MAP and conflicts with this connection.

TS0 RATE**Write security: 3; Read security: 5**

Sets the TS0 rate to either 56 or 64 kbps. This field is only valid for E1 ports mapped to a **PKT ENDPNT**.

E1 TROUBLE CODE SERVICE**Write security: 3; Read security: 5**

Sets known values in the signaling bits and the data field for outgoing TS0s which are cross-connected to a E1 port experiencing alarms.

The trunk conditioning process consists of a 2.5 second transmission (indicating call termination), followed by a continuous transmission signaling the final condition as chosen by the user. Set the **E1 TROUBLE CODE SERVICE** field to **OFF** or **VOICE**.

T1 TROUBLE CODE VALUE**Write security: 3; Read security: 5**

Displays the Hex value of the 2.5 second pre-alarm transmission.

DEDICATED MAPS (QUAD/OCTAL FXS MODULE)

DEDICATED MAPS (FXS) > CREATE/EDIT MAPS > CONNECTS

Write security: 3; Read security: 5

Enters the dedicated map connections. Press <Enter> to activate the submenus.

DEDICATED MAPS (FXS) > CREATE/EDIT MAPS > CONNECTS > TO/FROM CONFIG

Write security: 3; Read security: 5

Specifies the configuration for the **TO/FROM** connection. The following selections may apply to the Quad/Octal FXS Option Modules, depending on the application:

PORTS

Write security: 3; Read security: 5

Defines ports to be used for this connection.

PORTS AVAILABLE

Write security: 3; Read security: 5

Indicates which ports of the module are assigned. Port assignment is based on the following items:

DIGIT 0-9	This DS0 is available. The digit that displays in this field represents the last digit of the DS0 number.
*	This DS0 has been requested for this connection, but the DS0 is not yet activated for this port.
!	This DS0 is used by this port in this connection and is currently activated.
S	This DS0 is used in the switched DIAL PLAN .
S	This DS0 is used in the switched DIAL PLAN and conflicts with this connection.
N	This DS0 is already used in this DEDICATED MAP .
N	This DS0 is already used in this DEDICATED MAP and conflicts with this connection.

SIGNALING METHOD

Write security: 3; Read security: 5

Defines the mode of operation of the selected voice port. The signaling on the T1 mapped to this voice port must match. The options include **LOOPSTART**, **GROUNDSTART**, and **PLAR**.

ANSWER SUPERVISION**Write security: 3; Read security: 5**

Configures answer supervision for the appropriate voice port. Answer supervision (when the far end answers the call) is indicated by using reverse battery polarity. This is valid for an outbound call only. On an FXS interface type we respond to LSAS (Line Side Answer Supervision) signaling on the T1. Our response is to reverse battery polarity on (T-R). Telco must configure their T1 for LSAS if this is not a point-to-point T1.

E&M CONVERSION**Write security: 3; Read security: 5**

Configures the selected voice port for E&M signaling conversion. By enabling this option, other selections become available that are E&M trunk specific. This option is sometimes referred to as TANDEM conversion. The following submenu items become visible when **E&M CONVERSION** is **ENABLED**:

E&M SUPERVISION**Write security: 3; Read security: 5**

*(Available only when **E&M CONVERSION** is enabled.)* Configures the E&M trunk as either Immediate start or Wink start. This configuration is for the Rx and Tx direction. When DNIS delay is set, this option only configures the Rx direction.

DIAL TONE**Write security: 3; Read security: 5**

*(Available only when **E&M CONVERSION** is enabled.)* Configures the ATLAS 550 to generate Dial Tone out the selected FXS port in response to the 2W going off hook (outgoing call). Generally, dial tone is provided by the Class 5 switch delivering the T1, but in some instances, the switch cannot provide dial tone.

RINGBACK**Write security: 3; Read security: 5**

*(Available only when **E&M CONVERSION** is enabled.)* Configures the ATLAS 550 to generate ringback tone to the far end while the selected FXS port is ringing. Generally, ringback is provided by the Class 5 switch delivering the T1, but in some instances, the switch cannot provide ringback tones.

DNIS DELAY**Write security: 3; Read security: 5**

*(Available only when **E&M CONVERSION** is enabled.)* Defines the time we delay after transmitting a wink in response to the 2W going off hook (after ringing) before we send off hook in the RBS signaling. This field is only valid for E&M conversion. The timing is as follows:

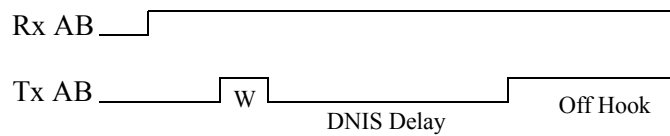

The following submenu item becomes visible when **DNIS DELAY** is activated:

DNIS WINK TIMEOUT**Write security: 3; Read security: 5**

When **DNIS DELAY** is **ENABLED**, a wink will be returned to the originating switch after 5 seconds if the FXS does not detect an off hook. This option, when **DISABLED**, allows the FXS port to ring without winking until the call is answered.



Trunks can be taken out of service by telco if there is No wink. Use caution when disabling this option.

DEDICATED MAPS (QUAD/OCTAL FXO MODULE)**DEDICATED MAPS (FXO) > CREATE/EDIT MAPS > CONNECTS****Write security: 3; Read security: 5**

Enters the dedicated map connections. Press <Enter> to activate the submenus.

DEDICATED MAPS (FXO) > CREATE/EDIT MAPS > CONNECTS > TO/FROM CONFIG**Write security: 3; Read security: 5**

Specifies the configuration for the **TO/FROM** connection. The following selections may apply to the Quad/Octal FXO Option Module, depending on the application:

PORTS**Write security: 3; Read security: 5**

Defines ports to be used for this connection.

PORTS AVAILABLE**Write security: 3; Read security: 5**

Indicates which ports of the module are assigned. Port assignment is based on the following items:

DIGIT 0-9	This DS0 is available. The digit that displays in this field represents the last digit of the DS0 number.
*	This DS0 has been requested for this connection, but the DS0 is not yet activated for this port.
!	This DS0 is used by this port in this connection and is currently activated.
S	This DS0 is used in the switched DIAL PLAN .
S	This DS0 is used in the switched DIAL PLAN and conflicts with this connection.
N	This DS0 is already used in this DEDICATED MAP .
N	This DS0 is already used in this DEDICATED MAP and conflicts with this connection.

SIGNALING METHOD**Write security: 3; Read security: 5**

Defines the mode of operation of the selected voice port. The signaling on the T1 mapped to this voice port must match. The options include **LOOPSTART**, **GROUNDSTART**, and **DPT**.

ANSWER SUPERVISION**Write security: 3; Read security: 5**

Configures answer supervision for the appropriate voice port. Answer supervision (when the far end answers the call) is indicated by using reverse battery polarity. This is valid for an outbound call only. When the FXO originates a call, it looks for reverse polarity on the 2W interface. If reverse battery is detected, LSAS is transmitted on the T1. This requires Loopstart interfaces to be polarity dependent.



Keep this option disabled unless you are certain you need LSAS capability.

DEDICATED MAPS (DUAL NX 56/64 MODULE)**DEDICATED MAPS (V35NX) > CREATE/EDIT MAPS > CONNECTS****Write security: 3; Read security: 5**

Enters the dedicated map connections. Press <Enter> to activate the submenus.

DEDICATED MAPS (V35NX) > CREATE/EDIT MAPS > CONNECTS > TO/FROM CONFIG**Write security: 3; Read security: 5**

Specifies the configuration for the **FROM** connection. The following selections may apply to the Dual Nx 56/64 Option Module, depending on the application:

DS0 SELECTION**Write security: 3; Read security: 5**

Defines DS0s for an Nx port. Use this field to define the DS0s for this connection. This field only applies to Nx-to-Nx or Nx-to-Pkt Endpt connections.

DS0 RATE**Write security: 3; Read security: 5**

Sets the DS0 rate to either 56 or 64 kbps.

DEDICATED MAPS (DUAL USSI MODULE)

DEDICATED MAPS (USSI) > CREATE/EDIT MAPS > CONNECTS**Write security: 3; Read security: 5**

Enters the dedicated map connections. Press <Enter> to activate the submenus.

DEDICATED MAPS (USSI) > CREATE/EDIT MAPS > CONNECTS > TO/FROM CONFIG**Write security: 3; Read security: 5**

Specifies the configuration for the **FROM** connection. The following selections may apply to the Dual USSI Option Module, depending on the application:

DS0 SELECTION**Write security: 3; Read security: 5**

Defines DS0s for an USSI port. Use this field to define the DS0s for this connection. This field only applies to USSI-to-USSI, USSI-to-Nx or USSI-to-Pkt Endpt connections.

DS0 SELECTION**Write security: 3; Read security: 5**

Defines DS0s for an USSI port. Use this field to define the DS0s for this connection. This field only applies to USSI-to-USSI, USSI-to-Nx or USSI-to-Pkt Endpt connections.

DS0 RATE**Write security: 3; Read security: 5**

Sets the DS0 rate to either 56 or 64 kbps.

DEDICATED MAPS (OCTAL E&M MODULE)

DEDICATED MAPS (E&M) > CREATE/EDIT MAPS > CONNECTS**Write security: 3; Read security: 5**

Enters the dedicated map connections. Press <Enter> to activate the submenus.

DEDICATED MAPS (E&M) > CREATE/EDIT MAPS > CONNECTS > TO/FROM CONFIG**Write security: 3; Read security: 5**

Specifies the configuration for the **TO/FROM** connection. The following selections may apply to the Octal E&M Option Module, depending on the application:

PORTS**Write security: 3; Read security: 5**

Defines ports to be used for this connection.

PORTS AVAILABLE**Write security: 3; Read security: 5**

Indicates which ports of the module are assigned. Port assignment is based on the following items:

DIGIT 0-9	This DS0 is available. The digit that displays in this field represents the last digit of the DS0 number.
*	This DS0 has been requested for this connection, but the DS0 is not yet activated for this port.
!	This DS0 is used by this port in this connection and is currently activated.
S	This DS0 is used in the switched DIAL PLAN .
S	This DS0 is used in the switched DIAL PLAN and conflicts with this connection.
N	This DS0 is already used in this DEDICATED MAP .
N	This DS0 is already used in this DEDICATED MAP and conflicts with this connection.

DEDICATED MAPS (NXT1 HSSI AND NXT1 HSSI/V.35 MODULES)**DEDICATED MAPS (NXT1 HSSI) > CREATE/EDIT MAPS > CONNECTS****Write security: 3; Read security: 5**

Enters the dedicated map connections. Press <Enter> to activate the submenus.

DEDICATED MAPS (NXT1 HSSI) > CREATE/EDIT MAPS > CONNECTS > TO/FROM CONFIG**Write security: 3; Read security: 5**

Specifies the configuration for the **TO/FROM** connection. The following selection applies to the NxT1 HSSI and NxT1 HSSI/V.35 Option Modules when connected to a port on a T1 Module. This is the only valid application for the NxT1 HSSI and NxT1 HSSI/V.35 Option Modules.

DS0 SELECTION**Write security: 3; Read security: 5**

Defines DS0s for the T1 port. Use this field to define the DS0s for this connection.



For the NxT1 HSSI and NxT1 HSSI/V.35 Option Modules, any entry in the DS0 selection field that is less than 24 DS0s is disregarded. The NxT1 HSSI and NxT1 HSSI/V.35 Option Modules requires the use of all 24 DS0s on a T1 for proper operation.

DS0s AVAILABLE**Write security: 3; Read security: 5**

Indicates which DS0s of the T1 are assigned. DS0 assignment is based on the following items:

DIGIT 0-9	This DS0 is available. The digit that displays in this field represents the last digit of the DS0 number.
*	This DS0 has been requested for this connection, but the DS0 is not yet activated for this port.
!	This DS0 is used by this port in this connection and is currently activated.
S	This DS0 is used in the switched DIAL PLAN .
S	This DS0 is used in the switched DIAL PLAN and conflicts with this connection.
N	This DS0 is already used in this DEDICATED MAP .
N	This DS0 is already used in this DEDICATED MAP and conflicts with this connection.

T1 TROUBLE CODE SERVICE**Write security: 3; Read security: 5**

Sets known values in the signaling bits and the data field for outgoing DS0s which are cross-connected to a T1 port experiencing alarms.

The trunk conditioning process consists of a 2.5 second transmission (indicating call termination), followed by a continuous transmission signaling the final condition as chosen by the user. This selection is only valid for T1 ports having **RBS** set to **ON**.

This option defines the type of signaling being used on the trunk: **E&M**, **LS/GS NETWORK OR USER**, **SW56**, or **CUSTOM**.

T1 TROUBLE CODE VALUE**Write security: 3; Read security: 5**

*(Available only when **T1 TROUBLE CODE SERVICE** is enabled.)* Displays the Hex value of the 2.5 second pre-alarm transmission.

DEDICATED MAPS (LEGACY DATA MODULE)**DEDICATED MAPS (LEGACY) > CREATE/EDIT MAPS > CONNECTS****Write security: 3; Read security: 5**

Enters the dedicated map connections. Press <Enter> to activate the submenus.

DEDICATED MAPS (LEGACY) > CREATE/EDIT MAPS > CONNECTS > TO/FROM CONFIG**Write security: 3; Read security: 5**

Specifies the configuration for the **FROM** connection. The following selections apply to a connection between the Legacy Data Option Module and a Packet Endpoint. This is the only valid application for the

Legacy Data Option Module.

SYNC/ASYNC

Write security: 3; Read security: 5

Configures the port for either synchronous or asynchronous data transmission.



*The mode of operation depends on the protocol selected in the **PACKET MANAGER** menus.*

INTERFACE TYPE

Write security: 3; Read security: 5

Configures the physical interface of the port as EIA-232 or V.35. Selecting V.35 requires the NxT1 HSSI/V.35 Option Module (P/N 1200346L2) and the purchase of the option V.35 cables (P/N 1200348L1).

BIT RATE

Write security: 3; Read security: 5

Sets the interface bit rate for the port. Selections range from 2400 baud to 128 kbaud.

TD CLOCK SOURCE

Write security: 3; Read security: 5

Configures the interface to provide or recover data clocking.



*This clock source is used **ONLY** on the Legacy Data Option Module and cannot be used as a source for system timing.*

TRANSMIT IDLE CODE

Write security: 3; Read security: 5

Configures the port to use Flags or Ones as the idle code.

DEDICATED MAPS (PKT ENDPT - PACKET ENDPOINT)**DEDICATED MAPS (PKT ENDPT) > CREATE/EDIT MAPS > CONNECTS**

Write security: 3; Read security: 5

To assign a packet endpoint to a physical port, select the port in the **FROM SLOT/PORT** field and configure the **TO SLOT/PORT** as follows:

DEDICATED MAPS (PKT ENDPT) > CREATE/EDIT MAPS > CONNECTS > TO SLOT/SERVICE

Write security: 3; Read security: 5

Select **PKT ENDPT** to activate a list of available packet endpoints in the **To PORT** field.

DEDICATED MAPS (PKT ENDPT) > CREATE/EDIT MAPS > CONNECTS > TO PORT/PEP**Write security: 3; Read security: 5**

Press <Enter> and select the appropriate packet endpoint to assign the endpoint to a physical port.

DEDICATED MAPS (PKT ENDPT) > CREATE/EDIT MAPS > CONNECTS > TO/FROM CONFIG**Write security: 3; Read security: 5**

Specifies the configuration for the **TO/FROM** connection. The following selections apply to the packet endpoint:

TRANSMIT IDLE CODE**Write security: 3; Read security: 5**

Configures the ATLAS 550 to send idle code on the packet endpoint with marks or flags.

RECEIVE IDLE CODE**Write security: 3; Read security: 5**

Defines the idle code (either marks or flags) the ATLAS 550 should expect on the selected packet endpoint.

DEDICATED MAPS (PKT VOICE - PACKET VOICE ENDPOINT)

DEDICATED MAPS (PKT VOICE) > CREATE/EDIT MAPS > CONNECTS**Write security: 3; Read security: 5**

Enters the dedicated map connections. Press <Enter > to activate the submenus.

DEDICATED MAPS (PKT VOICE) > CREATE/EDIT MAPS > CONNECTS > TO SLOT/SERVICE**Write security: 3; Read security: 5**

Select **PKT VOICE** to activate a list of available packet endpoints in the **TO PORT** field.

DEDICATED MAPS (PKT VOICE) > CREATE/EDIT MAPS > CONNECTS > TO PORT/PEP**Write security: 3; Read security: 5**

Press <Enter> and select the appropriate packet endpoint from the drop-down list.

DEDICATED MAPS (PKT VOICE) > CREATE/EDIT MAPS > CONNECTS > TO/FROM CONFIG**Write security: 3; Read security: 5**

Specifies the configuration for the **TO/FROM** connection. The following selections apply to the **PKT VOICE** connections:

DLCI**Write security: 3; Read security: 5**

Press <Enter > and select the appropriate DLCI from the drop-down list.

VOICE PORT**Write security: 3; Read security: 5**

Identifies the voice port address of the remote unit. Express units support ports 1 and 2. A remote ATLAS supports ports 1 through 255.

CONFLICT REPORT**Write security: 3; Read security: 5**

Describes existing conflicts. Potential problems include DLCI unavailable or Voice port already in use.

VOICE COMPRESSION**Write security: 3; Read security: 5**

Configures the compression algorithm used on the selected packet voice endpoint. The default compression algorithm in the FSU and Express 52XX series is G.723.1. Valid codecs for the VCOM Module include G.723.1 and NetCoder. Valid codecs for the ADPCM-32 Module include G.711, G.726, and Transparent. The ADPCM-32 Module will only operate with another ATLAS containing an ADPCM-32 Module. Both endpoints must agree on the selected compression algorithm.



The ADPCM-32 Resource Module will not interoperate with the FSU and Express series products.

SILENCE SUPPRESSION**Write security: 3; Read security: 5**

Reduces the total system bandwidth load by preventing ATLAS from sending frames containing a special silence code during periods of silence. Both endpoints must agree to use silence suppression. By default, silence suppression is **DISABLED**. To prohibit silence frames from transmitting and to decrease the total system bandwidth, **ENABLE** this feature.

SIGNALING**Write security: 3; Read security: 5**

Signaling method on the packet voice endpoint. Both endpoints must agree about the compression algorithm choice. Options are **E&M IMMEDIATE**, **E&M WINK**, and **LOOPSTART**.

CIRCUIT STATUS

The **CIRCUIT STATUS** menu allows the user to view the status of all circuits configured for dedicated circuit backup (see Figure 17).

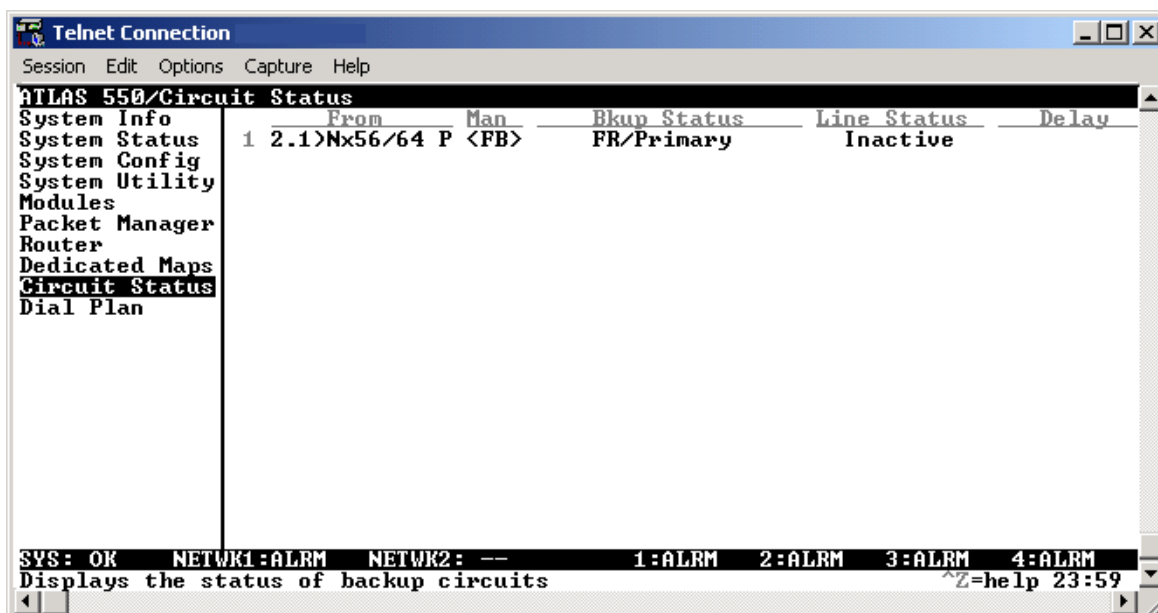

Figure 17. Circuit Status Menu

CIRCUIT STATUS > FROM

Read security: 5

Indicates the slot, port, and name of the endpoint configured for backup.

CIRCUIT STATUS > MAN (MANUAL BACKUP)

Write security: 3; Read security: 5

This activator forces a link in/out of backup.

FB Force Backup

FR Force Restore

CIRCUIT STATUS > BKUP STATUS (BACKUP STATUS)**Read security: 5**

The displayed string indicates the current status of the dedicated line. The following messages may display in the **BACKUP STATUS** field.

FB	Backup was forced through the interface menu.
FR	Restore was forced through the interface menu.
PRIMARY	The link is active.
DIALING	Attempting to dial the backup link.
BACKUP FAILED	Exceeded MAX NUM REDIALS .
RETRY DIAL [NUM]	Will retry backup dialing in [num] seconds.
PRIMARY DOWN	The link is in error and waiting on backup.
ANSWERING	The link is answering a backup endpoint.
BACKUP	The link is in backup.

CIRCUIT STATUS > LINE STATUS**Read security: 5**

Displays the overall status of the connection. The following messages may display in the **LINE STATUS** field.

UNKNOWN	Endpoints do not support (or are not configured) for monitoring.
ACTIVE	The connection is up and running.
INACTIVE	The connection is down due to configuration (i.e., DTR is down).
DATA ALARM	The FROM endpoint is in data alarm.
NETWORK ALARM	The TO endpoint is in network alarm.
NET/DATA ALARM	Both the FROM endpoint and the TO endpoint are in alarm.
DATA UNKNOWN	The status of the FROM endpoint is unknown.

CIRCUIT STATUS > DELAY

When present, this indicates that one ATLAS 550 has detected a change in state and is counting down to delay/restore.

CIRCUIT STATUS > TEST**Write security: 1; Read security: 5**

Contains a test activator and test status displays for dedicated dial backup circuits.

CIRCUIT STATUS > TEST > LAST RUN TIME**Read security: 5**

(Not visible until a circuit has been tested.) Displays the date and time of the last test call made through this dedicated dial backup circuit.

CIRCUIT STATUS > TEST > NEXT RUN TIME**Read security: 5**

*(Not visible unless **TEST CALL** is configured for non-manual operation in the **INTERFACE CONFIG** for the **CIRCUIT BACKUP ENDPOINT**.)* Displays the date and time of the next schedule test call to be made through this dedicated dial backup circuit.

CIRCUIT STATUS > TEST > LAST TEST STATUS**Read security: 5**

Displays the status of the last test call made through this dedicated dial backup circuit. The following status messages may display:

IDLE	No current test call on this dedicated dial backup circuit
PASSED	Passed last manual or scheduled test
FAILED	Failed last manual or scheduled test

CIRCUIT STATUS > TEST > PASS : FAIL**Read security: 5**

Displays the number of successful and unsuccessful test calls made through this dedicated dial backup circuit.

CIRCUIT STATUS > TEST > TEST NOW**Write security: 5; Read security: 5**

Press to initiate a test call on the dedicated dial backup circuit.

DIAL PLAN

The **DIAL PLAN** submenus set global ATLAS 550 switch parameters as well as individual parameters for each ATLAS 550 port handling a switched call (see Figure 18). The individual ports are separated into two port types: network and user. Network ports terminate a connection from the network. User ports terminate incoming calls and, in turn may be connected to user equipment.

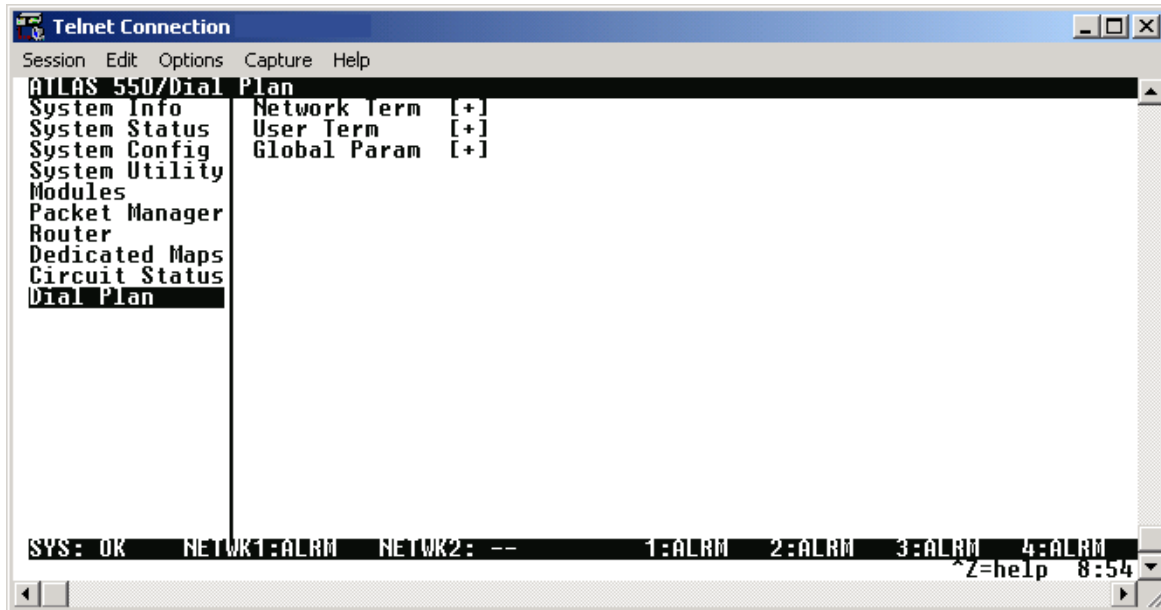

Figure 18. Dial Plan Menu

DIAL PLAN > NETWORK TERM

Write security: 3; Read security: 5

This menu allows the user to define option parameters for ports which terminate a connection from the network.



*In applications where two ATLAS 550 units are used in a point-to-point configuration, a port in the ATLAS 550 at one end would act as the network (**USER TERM**), while the ATLAS 550 at the opposite end would be terminating a network connection (**NETWORK TERM**).*

DIAL PLAN > NETWORK TERM > SLOT/SVC

Write security: 3; Read security: 5

Selects the ATLAS 550 slot or service that terminates a network connection.

DIAL PLAN > NETWORK TERM > PORT/PEP**Write security: 3; Read security: 5**

Selects the ATLAS 550 port or packet endpoint that terminates a network connection.



There may be more than one “endpoint” associated with a particular port. If a T1 is connected to the PSTN, some DS0s may be used for long distance, while others are used for local calls. These would constitute two “endpoints” (trunks) over a single physical port.

DIAL PLAN > NETWORK TERM > SIG**Write security: 3; Read security: 5**

Defines the type of signaling being used for this connection (endpoint). Select **RBS** for a T1 using Robbed Bit Signaling or **PRI** for a Primary Rate ISDN interface. Select **NFAS** for a non-facility associated signalling interface or **NONE** for OSC when bonding DS0s. This selection is only necessary if a T1/PRI is selected as the **SLOT/PORT** type.



One HDLC resource is used by each PRI or each Packet Endpoint.

DIAL PLAN > NETWORK TERM > OUT#ACCEPT**Write security: 3; Read security: 5**

Defines the parameters for the outgoing calls that ATLAS 550 sends to the network.

DIAL PLAN > NETWORK TERM > OUT#ACCEPT > SRC ID**Write security: 3; Read security: 5**

Identifies the call source ID from which this endpoint accepts calls. This field simplifies the creation of a dial plan in applications where the criterion for switching calls to a certain endpoint is a function of which endpoint originated the call. **SRC ID** may be entered with the usual wild card entries (except \$).

X	=	Any digit 0 through 9
[1,3,5]	=	Any of these digits
0	=	Default value

The default ID for all source endpoints all accept numbers is 0. This results in all calls being routed based on the dialed number.

DIAL PLAN > NETWORK TERM > OUT#ACCEPT > ACCEPT NUMBER**Write security: 3; Read security: 5**

Designates which numbers this endpoint passes on toward the network. The accept list may consist of multiple entries. The numbers are defined using the following “wild cards”:

X	=	Any single digit
N	=	Any single digit 2 through 9
\$	=	Any number of digits of any value
9	=	This specific number
[1,2,3...]	=	A single digit in this group

Example: 1-800-\$ only permits toll-free, long distance calls to 1-800. If this were used, then a second accept number would need to be specified (NXX-XXXX) permitting local numbers to be dialed.



Any specific entry takes precedence over a wild card. For example, if endpoint A was designated as \$ while endpoint B accepted 963-800X, then an incoming call to 963-800X would only be accepted by endpoint B.

DIAL PLAN > NETWORK TERM > OUT#ACCEPT > SEARCH**Write security: 3; Read security: 5**

Instructs ATLAS 550 in which order to search for an accept number match. Normally, all searches are set to primary. The secondary search selection forces ATLAS 550 to only accept a call at this endpoint if all primary endpoints are unavailable.

PRIMARY SEARCH All long distance calls should go out a PRI directly to an IXC (MCI, ATT, etc.), and local calls should go out a T1 to the LEC. It may be desirable to place long distance calls on the local exchange if all of the IXC trunks are unavailable (busy or in alarm). In this case, the primary accept number for the local exchange would be N\$, and the secondary accept would be 1\$.

SECONDARY SEARCH The same accept rules apply for all secondary number searches as for primary searches.

DIAL PLAN > NETWORK TERM > OUT#ACCEPT > DATA 64K, DATA 56K, AUDIO, SPEECH**Write security: 3; Read security: 5**

Reflects the bearer capability the network has provisioned for this line. If the ISDN lines were purchased with different services provisioned, then ATLAS 550 would send the call out of the port which supports the type of service the call requires.

For example, the network termination is on a pair of BRIs (with the same phone number) with one provisioned for data and the other for voice. By enabling data in one and not the other, ATLAS 550 ensures that calls bearing data will be sent out the right BRI interface.

DIAL PLAN > NETWORK TERM > OUT#ACCEPT > TREAT CALL AS**Write security: 3; Read security: 5**

Allows the incoming call to be treated as the selected call type, regardless of the actual incoming call type. The default selection, **AS RECEIVED**, effectively disables the feature by using the actual call type. Other options include **DATA 64K** and **DATA 56K**.

DIAL PLAN > NETWORK TERM > OUT#REJ**Write security: 3; Read security: 5**

Defines parameters for outgoing calls that ATLAS 550 will not send to the network.

DIAL PLAN > NETWORK TERM > OUT#REJ > REJECT NUMBER**Write security: 3; Read security: 5**

Identifies which numbers this endpoint will not pass on toward the network. The reject list may consist of multiple entries. The reject list may be used to more easily specify the call filtering desired. The wildcards are identical as in **OUT#ACCEPT** (see *Dial Plan > Network Term > Out#Accept* on page 254).



The reject list takes precedence over the accept list. For example, 1-900-\$ rejects all 1-900 long distance calls, and 1-\$ rejects all long distance calls.

DIAL PLAN > NETWORK TERM > OUT#REJ > DATA 64K, DATA 56K, AUDIO, SPEECH**Write security: 3; Read security: 5**

Rejects outgoing calls based on call type. For example, setting the reject number to **\$**, Digital 56/64 to **ENABLED**, and Audio and Speech to **DISABLED** will reject all digital calls, but accept analog calls.



This list may remain blank if the accept list meets desired filtering.

DIAL PLAN > NETWORK TERM > IFCE CONFIG**Write security: 3; Read security: 5**

Specifies the configuration parameters for the endpoint. The selections displayed in this field are based on the type of module selected in the **SLOT/SVC** option. For detailed information on submenus for a particular module type, please refer to the dial plan interface configuration menu discussion for the appropriate network, option, or resource module.



*Some of the options available in this submenu change depending on the type of modules selected in the **SLT/SVC** or **PRT/PEP** fields. For more information on these submenus, refer to the individual module interface configuration discussions in this section.*

DIAL PLAN > NETWORK TERM > SUBST TEMPL**Write security: 3; Read security: 5**

The substitution template allows the ATLAS 550 to select calls (based on telephone number) and substitute

a user-defined number for the received digits after the call has been processed by the switchboard. Substitution templates are created for each entry in the **DIAL PLAN**.

DIAL PLAN > NETWORK TERM > SUBST TEMPL > ORIGINAL#

Write security: 3; Read security: 5

Designates the number(s) to be the search criteria for the substitution template. The pattern can be a specific number, or wildcards can be used as part of the number specification.

X	=	Any single digit
N	=	Any single digit 2 through 9
\$	=	Any number of digits of any value
9	=	This specific number
[1,2,3...]	=	A single digit in this group

Example: 963-812[012] would be 963-8120 to 963-8122.

DIAL PLAN > NETWORK TERM > SUBST TEMPL > SUBSTITUTED#

Write security: 3; Read security: 5

Designates the number to be substituted for the number(s) defined in the **ORIGINAL#** field. The pattern can be a specific number, or wildcards can be used as a part of the number specification.

X	=	Any single digit
N	=	Any single digit 2 through 9
\$	=	Any number of digits of any value
9	=	This specific number
[1,2,3...]	=	A single digit in this group

Punctuation characters () - + are ignored and a comma is interpreted as a .5 second pause in the dial string.

Example: The **ORIGINAL#** field contains **\$** and the **SUBSTITUTED#** field contains **,256\$**. All calls routed out this connection will be delayed .5 seconds and contain a 256 prefix.



*Wildcards used in the **SUBSTITUTED#** field are only valid when used in the same position (relative to the end of the digit string) as the **ORIGINAL#** field.*

DIAL PLAN > USER TERM

Write security: 3; Read security: 5

This menu allows you to define option parameters for ports which terminate a connection from user

equipment. In this case, ATLAS 550 is acting as the network.



In applications where two ATLAS 550 units are used in a point-to-point configuration, a port in the ATLAS 550 at one end would act as the network (user termination), while the ATLAS 550 at the opposite end would be terminating a network connection (network termination).

DIAL PLAN > USER TERM > SLOT/SVC

Write security: 3; Read security: 5

Selects the ATLAS 550 slot or service that terminates a user connection.

DIAL PLAN > USER TERM > PORT/PEP

Write security: 3; Read security: 5

Selects the ATLAS 550 port or packet endpoint that terminates a user connection.



There may be more than one "endpoint" associated with a particular port. If a T1 is connected to the PSTN, some DS0s may be used for long distance, while others are used for local calls. These would constitute two "endpoints" (trunks) over a single physical port.

DIAL PLAN > USER TERM > SIG

Write security: 3; Read security: 5

Defines the type of signaling being used for this connection (endpoint). Select **RBS** for a T1 using robbed bit signaling or **PRI** for a Primary Rate ISDN interface. This selection is only necessary if a T1/PRI is selected as the **SLOT/PORT** type.



One HDLC resource is used by each PRI or each Packet Endpoint.

DIAL PLAN > USER TERM > IN#ACCEPT

Write security: 3; Read security: 5

Defines the parameters for the incoming calls that ATLAS 550 accepts from the network.

DIAL PLAN > USER TERM > IN#ACCEPT > SRC ID**Write security: 3; Read security: 5**

Identifies the call source ID from which this endpoint accepts calls. This field simplifies the creation of a dial plan in applications where the criterion for switching calls to a certain endpoint is a function of which endpoint originated the call. **SRC ID** may be entered with the usual wild card entries (except \$).

X	=	Any digit 0 through 9
[1,3,5]	=	Any of these digits
0	=	Default value

The default ID for all source endpoints all accept numbers is 0. This results in all calls being routed based on the dialed number.

DIAL PLAN > USER TERM > IN#ACCEPT > ACCEPT NUMBER**Write security: 3; Read security: 5**

Designates which numbers this endpoint will accept (terminate) from the network. The accept list may consist of multiple entries. The numbers are defined using the following wildcards:

X	=	Any single digit
N	=	Any single digit 2 through 9
\$	=	Any number of digits of any value
9	=	This specific number
[1,2,3...]	=	A single digit in this group

Example: 963-8000 would be a specific incoming number that would be accepted by this endpoint. If this endpoint consisted of a T1 with multiple DS0s, a "hunt" group for 963-8000 would be formed. The entry \$ would accept any call.



Any specific entry will take precedence over a wildcard. For example, if endpoint A was designated as \$ while endpoint B accepted 963-800X, then an incoming call to 963-800X would only be accepted by endpoint B.

DIAL PLAN > USER TERM > IN#ACCEPT > SEARCH**Write security: 3; Read security: 5**

Instructs ATLAS 550 in which order to search for an accept number match. Normally, all searches are set to primary. The secondary search selection forces ATLAS 550 to only accept a call at this endpoint if all

primary endpoints are unavailable.

PRIMARY SEARCH	All long distance calls should go out a PRI directly to an IXC (MCI, ATT, etc.), and local calls should go out a T1 to the LEC. It may be desirable to place long distance calls on the local exchange if all of the IXC trunks are unavailable (busy or in alarm). In this case, the primary accept number for the local exchange would be N\$, and the secondary accept would be 1\$.
SECONDARY SEARCH	The same accept rules apply for all secondary number searches as for primary searches.

DIAL PLAN > USER TERM > IN#ACCEPT > DATA 64K, DATA 56K, AUDIO, SPEECH

Write security: 3; Read security: 5

Reflects the bearer capability of the attached user equipment (typically a TA). If the attached TA can only handle digital calls, then a voice call sent to this endpoint would be rejected.

DIAL PLAN > USER TERM > IN#ACCEPT > TREAT CALL AS

Write security: 3; Read security: 5

Allows the incoming call to be treated as the selected call type, regardless of the actual incoming call type. The default selection, **AS RECEIVED**, effectively disables the feature by using the actual call type. Other options include **DATA 64K** and **DATA 56K**.

DIAL PLAN > USER TERM > OUT#REJ

Write security: 3; Read security: 5

Defines the parameters for the outgoing calls that ATLAS 550 will not send to the network.

DIAL PLAN > USER TERM > OUT#REJ > REJECT NUMBER

Identifies which numbers this endpoint will not pass on toward the network. Use when the outgoing call filter is different for different users sharing this endpoint. The wildcards are identical as in **OUT#ACCEPT** (see *Dial Plan > Network Term > Out#Accept* on page 254).



[0,1]-\$ rejects all long distance calls, but only for this User termination. If permitted in the Network termination endpoint, this user could not dial long distance numbers while other users could.

DIAL PLAN > USER TERM > OUT#REJ > DATA 64K, DATA 56K, AUDIO, SPEECH

Rejects outgoing calls based on call type. For example, setting the reject number to \$, Digital 56/64 to **ENABLED**, and Audio and Speech to **DISABLED**, rejects all digital calls while not rejecting analog calls.



This list may remain blank if the accept list meets desired filtering.

DIAL PLAN > USER TERM > IFCE CONFIG**Write security: 3; Read security: 5**

Specifies the configuration parameters for the endpoint. The selections displayed in this field are based on the type of module selected in the **SLOT/SVC** option. For detailed information on submenus for a particular module type, please refer to the dial plan interface configuration menu discussion for the appropriate network, option, or resource module.

 **NOTE**

*Some of the options available in this submenu change depending on the type of modules selected in the **SLOT/SVC** or **PORT/PEP** fields. For more information on these submenus, refer to the individual module interface configuration menu discussions in this section.*

DIAL PLAN > USER TERM > SUBST TEMPL**Write security: 3; Read security: 5**

The substitution template allows the ATLAS 550 to select calls (based on telephone number) and substitute a user-defined number for the received digits after the call has been processed by the switchboard. Substitution templates are created for each entry in the **DIAL PLAN**.

DIAL PLAN > USER TERM > SUBST TEMPL > ORIGINAL#**Write security: 3; Read security: 5**

Designates the number(s) to be the search criteria for the substitution template. The pattern can be a specific number, or wildcards can be used as part of the number specification.

X	=	Any single digit
N	=	Any single digit 2 through 9
\$	=	Any number of digits of any value
9	=	This specific number
[1,2,3...]	=	A single digit in this group

Example: 963-812[012] would be 963-8120 to 963-8122.

DIAL PLAN > USER TERM > SUBST TEMPL > SUBSTITUTED#**Write security: 3; Read security: 5**

Designates the number to be substituted for the number(s) defined in the **ORIGINAL#** field. The pattern can be a specific number, or wildcards can be used as a part of the number specification.

X	=	Any single digit
N	=	Any single digit 2 through 9
\$	=	Any number of digits of any value
9	=	This specific number
[1,2,3...]	=	A single digit in this group

Punctuation characters () - + are ignored and a comma is interpreted as a .5 second pause in the dial string.

Example: The **ORIGINAL#** field contains **\$** and the **SUBSTITUTED#** field contains **,256\$**. All calls routed out this connection will be delayed .5 seconds and contain a 256 prefix.



*Wildcards used in the **SUBSTITUTED#** field are only valid when used in the same position (relative to the end of the digit string) as the **ORIGINAL#** field.*

DIAL PLAN > GLOBAL PARAM**Write security: 2; Read security: 5**

Sets ATLAS 550 options which apply to all switched operations, both incoming and outgoing calls.

DIAL PLAN > GLOBAL PARAM > END OF NUMBER TIMEOUT**Write security: 3; Read security: 5**

Sets the length of time ATLAS 550 waits before assuming the outgoing dialed number is complete. The default value is six seconds. This timeout will only be invoked if the dialed number does not match one of the patterns set in the **NUMBER COMPLETE TEMPLATE** menu (see *Nbr Complete Templates* below).

DIAL PLAN > GLOBAL PARAM > COUNTRY CODE**Write security: 3; Read security: 5**

The country code. Enter your international country code using only digits. For the United States, enter 1.

DIAL PLAN > GLOBAL PARAM > AREA OR CITY CODE**Write security: 3; Read security: 5**

The local area code. Use for sending caller ID to the network.

DIAL PLAN > GLOBAL PARAM > NBR COMPLETE TEMPLATES**Write security: 3; Read security: 5**

Sets completed number patterns for outgoing calls so that ATLAS 550 recognizes when the phone number is complete. Fields include the index number (#) and **PATTERN**. For example, a local number will be 7 digits long while a long distance (1+ area code + number) will be 11 digits long. The ATLAS 550 defaults cover almost any installation, and these templates should not require any additional user input – except for unusual circumstances. The template allows the use of the following wildcard inputs to define numbers:

X	=	Any single digit
N	=	Any single digit 2 through 9
911	=	This specific number
[1,2,3...]	=	A single digit in this group

DIAL PLAN > GLOBAL PARAM > NUMBER TYPE TEMPLATES**Write security: 3; Read security: 5**

Sets call type patterns. ISDN interfaces require that a number type be sent over the D channel when a call is sent or received. A normal RBS trunk does not send a type designator, but uses prefixes instead. For example, “1 +” prefix is a national long distance call type while a “011 +” prefix is an international long distance call type. These templates form a table to permit ATLAS 550 to translate the RBS prefix into a call type for ISDN and vice-versa.



The ATLAS 550 default templates should cover all applications and should not need to be added to by the user except for very rare circumstances.

DIAL PLAN > GLOBAL PARAM > NUMBER TYPE TEMPLATES > #**Write security: 3; Read security: 5**

Denotes an entry number. The maximum number of entries is 50. Press < I > to insert a new entry and < D > to delete any entry.

DIAL PLAN > GLOBAL PARAM > NUMBER TYPE TEMPLATES > PREFIX

Sets the prefix for the number type. Only digits 0 and 1 are allowed (maximum of six characters).

DIAL PLAN > GLOBAL PARAM > NUMBER TYPE TEMPLATES > PATTERN

Modifies an entry when you press <Enter> (maximum of 40 characters). A pattern for a normal long distance call, for example, would be 1+(NXX) NXX - XXXX. Note that the symbols (), +, -, and space are not required and are only used to improve the readability of this example.

DIAL PLAN > GLOBAL PARAM > NUMBER TYPE TEMPLATES > NUMBER TYPE

Lists valid selections when you press <Enter>. Selections include **LOCAL**, **NATIONAL**, **INTERNATIONAL**, **PRIVATE**, and **UNKNOWN**.

DIAL PLAN > GLOBAL PARAM > AUTOMATIC ROUTEBACK REJECTION

Write security: 1; Read security: 5

When enabled, **AUTOMATIC ROUTEBACK REJECTION** prevents calls entering through network termination interfaces from being forwarded out another network interface. Such an event could happen if an incoming call specifies a number that has no endpoint configured to accept it and another network interface has a call acceptance entry which could accept it (such as \$). Without automatic rejection, such a call would be forwarded back to the network. The network would in turn resend the call to the unit until all incoming resources are consumed.

WARNING

*Use extreme caution when disabling **AUTOMATIC ROUTEBACK REJECTION**.*

DIAL PLAN > GLOBAL PARAM > COLLISION RESPONSE

Write security: 0; Read security: 0

When forced, the **COLLISION RESPONSE** will enable the ATLAS to perform **AUTOMATIC** retransmission of **SETUP** messages when faced with a collision situation. Forcing this response is not advised.

WARNING

*Use extreme caution when forcing **COLLISION RESPONSE**.*

DIAL PLAN > GLOBAL PARAM > GLOBAL TONE TYPE

Write security: 1; Read security: 5

Specifies the dialing digit tone encoding to be used throughout the entire system. **DTMF** (dual-tone-multi frequency) and **MF** (multi frequency) are the available options.

DIAL PLAN (T1/PRI) > NETWORK AND DUAL/QUAD T1/PRI MODULES)

All menu items in this section (listed as **T1/PRI**) apply to T1 Network and Dual/Quad Module interfaces configured in the **DIAL PLAN**.

DIAL PLAN (T1/PRI) > NETWORK TERM (PRI)

Write security: 3; Read security: 5

This menu allows the user to define option parameters for ports which terminate a PRI connection from the network.

DIAL PLAN (T1/PRI) > NETWORK TERM (PRI) > IFCE CONFIG (PRI)

Write security: 3; Read security: 5

Specifies the configuration parameters for the endpoint.

DIAL PLAN (T1/PRI) > NETWORK TERM (PRI) > IFCE CONFIG (PRI) > SWITCH TYPE

Write security: 3; Read security: 5

Defines the type of PRI switch to which the port is connected. If connected to another ATLAS 550, both need to be set to the same switch type. The following options are available:

- Lucent 5E
- National ISDN
- Northern DMS 100
- AT&T 4ESS

DIAL PLAN (T1/PRI) > NETWORK TERM (PRI) > IFCE CONFIG (PRI) > FIRST DS0

Write security: 3; Read security: 5

Defines the first DS0 for this endpoint. The ATLAS 550 uses DS0s, starting with this selection, to send and receive calls to and from the network. The outgoing calls which are allowed or restricted over these DS0s are set by **OUT#ACCEPT** (see *Dial Plan > Network Term > Out#Accept* on page 254) and **OUT#REJECT** (see *Dial Plan > Network Term > Out#Rej* on page 256).

DIAL PLAN (T1/PRI) > NETWORK TERM (PRI) > IFCE CONFIG (PRI) > NUMBER OF DS0S

Write security: 3; Read security: 5

Specifies the number of DS0s ATLAS 550 uses for this endpoint.

DIAL PLAN (T1/PRI) > NETWORK TERM (PRI) > IFCE CONFIG (PRI) > OUTGOING NUMBER CONVERSION

Write security: 3; Read security: 5

Converts outgoing (towards the network) numbers to the selected numbering plan and type option.

AS DIALED	Sends the digits provided as an unknown number type.
ISDN-NATIONAL PREFERRED	Regardless of what type of number is received, the outgoing number is substituted with ISDN-National as the number plan and type. Ten digits are always sent to the network. Leading ones, if present, are stripped out and the area code (provisioned under DIAL PLAN/GLOBAL PARAMETERS) is added, if only seven digits are supplied. This action may be required in areas with ten-digit local dialing.
ISDN-SUBSCRIBER PREFERRED	Examines the incoming number and if seven digits are received or if a ten-digit number is received with an area code that matches the area code provisioned in the global parameters, the number is forwarded to the network as a seven-digit number defined as ISDN-Subscriber number plan and type. If the incoming number is ten digits, but with a different area code, it is forwarded to the network as ISDN-National preferred.
ISDN-NATIONAL DMS RESERVED PREFERRED	Ignores the incoming numbering plan and type and substitutes the ISDN/Telephony numbering plan and National number type. Ten digits are sent to the network. Leading ones, if present, are stripped out and the area code set in global parameters is added if only seven digits are supplied. This action may be required in areas with ten-digit local dialing.
ISDN-NATIONAL AS DIALED	Sends the digits provided as National number type.



When **SWITCH TYPE** is set to **4ESS**, many installations require the National form where possible; this may also be the preferred form in 10-digit calling areas.

DIAL PLAN (T1/PRI) > NETWORK TERM (PRI) > IFCE CONFIG (PRI) > STRIP MSD

Write security: 3; Read security: 5

Strips a selected quantity (choose from **NONE, 1, 2, AND 3**) of the most significant digits (MSD) of a dialed number prior to being forwarded out of the port.

Example: A network port could be set to accept all calls beginning with 9 (9\$), and then with **STRIP MSD** set to **1**, all digits would be sent toward the network except the leading 9.



STRIP MSD does not affect **CALL ACCEPT** criteria. All of the digits (including the MSDs that are subsequently stripped) are used as accept criterion.

DIAL PLAN (T1/PRI) > NETWORK TERM (PRI) > IFCE CONFIG (PRI) > NETWORK SPECIFIC FACILITY VOICE AND DATA

Write security: 3; Read security: 5

Enables the sending of appropriate information to the PSTN. The default for this option is **NORMAL**, and in this case no Network Specific Facility Information Element is sent. Unless one of the services listed below is subscribed to, the selection should remain set to **NORMAL**.

The list below indicates services that may be subscribed to from the PSTN. These services require that specific information (such as a Network Specific Facility Information Element) be sent to the network during call setup.

- AT&T Megacom 800
- AT&T Megacom
- AT&T Accunet
- AT&T Long Distance
- AT&T SDN
(Switched Digital Network)
- AT&T International-800
- AT&T Dial-It 900/Multiquest
- National ISDN INWATS
- Nortel Private Network
- Nortel InWats
- Nortel OutWats
- Nortel Foreign Exchange
- Nortel Tie Trunk

DIAL PLAN (T1/PRI) > NETWORK TERM (PRI) > IFCE CONFIG (PRI) > CALLED DIGITS TRANSFERRED

Write security: 3; Read security: 5

Some PRI switches may be provisioned to send only a portion of the called number (like DID). This menu item allows the ATLAS 550 to know how many digits to expect (choose from **NONE, THREE, FOUR, SEVEN, and ALL**). The default is **ALL** and would almost always be correct. If less than **ALL** digits are sent, then the **PREFIX** is defined as follows:

PREFIX

Write security: 3; Read security: 5

Displays only if **CALLED DIGITS TRANSFERRED** is not set to **ALL**. Enter the prefix for the digits received.

Example: If the number of digits is four and the number called is 963-8615, the telco's PRI switch sends only 8615 and the prefix is set to 963. This entire number is then used to determine which ATLAS 550 user port endpoint should receive the call.

DIAL PLAN (T1/PRI) > NETWORK TERM (PRI) > IFCE CONFIG (PRI) > OUTGOING CALLER ID

Write security: 3; Read security: 5

Defines the number to use to provide Caller ID to the network for outgoing calls sent through this endpoint. Choose from **SEND AS PROVIDED, SUBSTITUTE IF NOT PRESENT, or SUBSTITUTE ALWAYS**.



The Caller ID number must be specific (i.e., no wildcards).

DIAL PLAN (T1/PRI) > NETWORK TERM (PRI) > IFCE CONFIG (PRI) > SOURCE ID**Write security: 3; Read security: 5**

Simplifies the creation of a dial plan in applications where the criterion for switching calls to a certain endpoint is a function of which endpoint originated the call.

DEFAULT VALUE = 0. Zero is the default ID for all endpoints and all accept numbers. With default values, all calls are routed based only on the dialed number.

Multiple endpoints can have the same **SOURCE ID**.

When creating the **CALL ACCEPT** list, specify a **SOURCE ID(s)** as well as a dialed number or range of dialed numbers to accept.

Example: An application requires that all calls that originate from Port 1 of the ATLAS 830 in Slot 1 be switched to Port 2 of that same module. Assign a unique **SOURCE ID** (e.g., 7) to Port 1 of the module, and then configure Port 2 to only accept calls from that unique **SOURCE ID (7)**.

DIAL PLAN (T1/PRI) > NETWORK TERM (PRI) > IFCE CONFIG (PRI) > SWAP ANI/DNIS**Write security: 3; Read security: 5**

Swaps the ANI and DNIS numbers received from the network. ANI (Automatic Number Identification) is the billing number of the calling party, and DNIS (Dialed Number Identification Service) is the called party number.



With this swap, the ATLAS 550 switchboard uses ANI to route the call. The accept number in the dial plan must use the ANI number, not the DNIS number.

DIAL PLAN (T1/PRI) > NETWORK TERM (PRI) > IFCE CONFIG (PRI) > B CHANNEL SELECTION**Write security: 3; Read security: 5**

Determines how the ATLAS 550 switchboard uses B channels for call routing. The Circular method can be used for call load balancing among the available B channels on this interface.

NORMAL	Always start with the last channel configured (i.e., for a full PRI channel 23 would be used if available).
CIRCULAR	Contiguous channels from last to first.

DIAL PLAN (T1/PRI) > NETWORK TERM (PRI) > IFCE CONFIG (PRI) > BUSY OPTION**Write security: 3; Read security: 5**

Defines the response propagated to the CPE upon receipt of a **DISCONNECT USER-BUSY** message from the network.

NORMAL	Send a progress message to the CPE and map busy tones.
PASS-THRU	Send a DISCONNECT USER-BUSY message to the User Term CPE device.

DIAL PLAN (T1/PRI) > NETWORK TERM (RBS)**Write security: 3; Read security: 5**

This menu allows the user to define option parameters for ports which terminate an RBS T1 connection

from the network.

DIAL PLAN (T1/PRI) > NETWORK TERM (RBS) > IFCE CONFIG (RBS)

Write security: 3; Read security: 5

Specifies the configuration parameters for the endpoint.

DIAL PLAN (T1/PRI) > NETWORK TERM (RBS) > IFCE CONFIG (RBS) > FIRST DS0

Write security: 3; Read security: 5

Defines to the ATLAS 550 the first DS0 for this endpoint. The ATLAS 550 uses DS0s, starting with this selection, to send and receive calls to and from the network. The outgoing calls which are allowed or restricted over these DS0s are set by **OUT#ACCEPT** (see *Dial Plan > Network Term > Out#Accept* on page 254) and **OUT#REJECT** (see *Dial Plan > Network Term > Out#Rej* on page 256).

DIAL PLAN (T1/PRI) > NETWORK TERM (RBS) > IFCE CONFIG (RBS) > NUMBER OF DS0s

Write security: 3; Read security: 5

Specifies the number of DS0s ATLAS 550 uses for this endpoint.

DIAL PLAN (T1/PRI) > NETWORK TERM (RBS) > IFCE CONFIG (RBS) > DS0s AVAILABLE

Write security: 3; Read security: 5

Indicates which DS0s of the T1 have been defined in this switched endpoint (indicated by “!”), in another switched endpoint (indicated by “s”), or in a **DEDICATED MAP** (indicated by “n”). This field is read-only. The following characters may display in this field:

0-9	This DS0 is available. The digit that displays in this field represents the last digit of the DS0 number.
*	This port is requesting this DS0 for this connection, but the DS0 is not yet activated.
!	This DS0 is used by this endpoint.
s	This DS0 is used elsewhere in the switched DIAL PLAN .
S	This DS0 is in the switched dial plan and conflicts with this endpoint.
N	This DS0 is used in one or more DEDICATED MAPS .
N	This DS0 is in one or more DEDICATED MAPS , and conflicts with this endpoint.

DIAL PLAN (T1/PRI) > NETWORK TERM (RBS) > IFCE CONFIG (RBS) > SIGNALING METHOD

Write security: 3; Read security: 5

Defines to the ATLAS 550 the type of signaling to be used across this trunk. The signaling selected needs to match the signaling being provided by the network (PSTN). The following choices are available:

- E&M Immediate
- E&M Wink
- Loop Start
- Ground Start
- Feature Group D



The ATLAS 550 converts signaling types between network and user terminations.

DIAL PLAN (T1/PRI) > NETWORK TERM (RBS) > IFCE CONFIG (RBS) > FGD TX SEQUENCE

Write security: 3; Read security: 5

Displayed only if **SIGNALING METHOD** is configured for **FEATURE GROUP D**. Defines to the ATLAS 550 the format in which to present the outgoing digits. Choices: **NORMAL** if no digits are to be sent; **ANI/DNIS** to send both ANI and DNIS; **DNIS** to send DNIS only; **ANI** to send ANI only.

DIAL PLAN (T1/PRI) > NETWORK TERM (RBS) > IFCE CONFIG (RBS) > FGD RX SEQUENCE

Write security: 3; Read security: 5

Displayed only if **SIGNALING METHOD** is configured for **FEATURE GROUP D**. Defines to the ATLAS 550 the format in which to receive the incoming digits. Choices: **NORMAL** if no digits are to be received; **ANI/DNIS** to receive both ANI and DNIS; **DNIS** to receive DNIS only; **ANI** to receive ANI only.

DIAL PLAN (T1/PRI) > NETWORK TERM (RBS) > IFCE CONFIG (RBS) > WINK AFTER ANI/DNIS

Write security: 3; Read security: 5

Displayed only if **SIGNALING METHOD** is configured for **FEATURE GROUP D**. When enabled, the ATLAS 550 will transmit a wink after ANI/DNIS digits are transmitted.

DIAL PLAN (T1/PRI) > NETWORK TERM (RBS) > IFCE CONFIG (RBS) > DIGIT SUPPRESSION

Write security: 3; Read security: 5

When enabled, no digits will be sent toward the network/PBX after going off-hook on an outgoing call.

DIAL PLAN (T1/PRI) > NETWORK TERM (RBS) > IFCE CONFIG (RBS) > DIRECT INWARD DIALING

Write security: 3; Read security: 5

Defines to the ATLAS 550 whether Direct Inward Dialing (**DID**) is being used by the network. If **DID** is **ENABLED**, then the following information must be defined.

DIAL PLAN (T1/PRI) > NETWORK TERM (RBS) > IFCE CONFIG (RBS) > DID DIGITS TRANSFERRED

Write security: 3; Read security: 5

Defines the number of digits sent to ATLAS 550 from the network if **DID** is used. This option only displays if **DID** is set to **ENABLED**.

DIAL PLAN (T1/PRI) > NETWORK TERM (RBS) > IFCE CONFIG (RBS) > DID NUMBER PREFIX

Write security: 3; Read security: 5

Defines to the ATLAS 550 the prefix digits which are not received as a part of the DID number. The ATLAS 550 uses the combination of prefix and DID number to determine the user endpoint that should receive the incoming call. This option only displays if **DID** is set to **ENABLED**. If **DID** is **DISABLED**, then you

must define the trunk number.



If Feature Group D is used, DID only refers to DNIS digits.

DIAL PLAN (T1/PRI) > NETWORK TERM (RBS) > IFCE CONFIG (RBS) > TRUNK NUMBER

Write security: 3; Read security: 5

When the network connection does not provide DID digits, the ATLAS 550 must be given a number to use to determine which user endpoint should receive the incoming call. **TRUNK NUMBER** displays only when **DID** is set to **DISABLED**.



The trunk number must be specific (i.e., no wildcards).

Example: To connect an incoming DS0 (trunk) to an endpoint with the accept number of 963-8615, set the trunk number to 963-8615.

DIAL PLAN (T1/PRI) > NETWORK TERM (RBS) > IFCE CONFIG (RBS) > STRIP MSD

Write security: 3; Read security: 5

Strips a selected quantity (choose from **NONE**, **1**, **2**, and **3**) of the most significant digits (MSD) of a dialed number prior to being forwarded out of the port.

Example: A network port could be set to accept all calls beginning with 9 (9\$), and then with **STRIP MSD** set to **1**, all digits would be sent toward the network except the leading 9.



***STRIP MSD** does not affect **CALL ACCEPT** criteria. All of the digits (including the MSDs that are subsequently stripped) are used as accept criterion.*

DIAL PLAN (T1/PRI) > NETWORK TERM (RBS) > IFCE CONFIG (RBS) > SOURCE ID

Write security: 3; Read security: 5

Simplifies the creation of a **DIAL PLAN** in applications where the criterion for switching calls to a certain endpoint is a function of which endpoint originated the call.

DEFAULT VALUE = 0. Zero is the default ID for all endpoints and all accept numbers. With default values, all calls are routed based only on the dialed number.

Multiple endpoints can have the same **SOURCE ID**.

When creating the **CALL ACCEPT** list, specify a **SOURCE ID(s)** as well as a dialed number or range of dialed numbers to accept.

Example: An application requires that all calls that originate from Port 1 of the ATLAS 550 in Slot 1 be switched to Port 2 of that same module. Assign a unique **SOURCE ID** (e.g., 7) to Port 1 of the module, and

then configure Port 2 to only accept calls from that unique **SOURCE ID** (7).

DIAL PLAN (T1/PRI) > NETWORK TERM (RBS) > IFCE CONFIG (RBS) > DS0 SELECTION**Write security: 3; Read security: 5**

Determines how the ATLAS 550 switchboard uses DS0s for call routing.

NORMAL	Always start with the last channel configured (i.e., for a full PRI channel 23 would be used if available).
CIRCULAR	Contiguous channels from last to first. Use this for call load balancing among the available DS0s on this interface.
ALIGNED	Provides the ability to maintain alignment between T1s as if they were in dedicated map mode. This scenario requires DS0 SELECTION set to ALIGNED on both interfaces (usually on User Term and on Net Term). An interface that has DS0 SELECTION set to ALIGNED will only process a call from the switchboard on the same DS0 that the incoming call was received.

Example: The unit receives an incoming call on DS0 17. The switchboard looks for an interface who has matching accept criteria to the number it received. A match is found on interface "Z" that has **DS0 SELECTION** set to **ALIGNED**. This causes interface "Z" to only process the call if it has DS0 17 available. If all matching interfaces have **DS0 SELECTION** set to **ALIGNED** and none of those interfaces have DS0 17 available, then a busy or fast busy will be returned to the calling party.

DIAL PLAN (T1/PRI) > USER TERM (PRI)**Write security: 3; Read security: 5**

This menu allows the user to define option parameters for ports which emulate a PRI connection.

DIAL PLAN (T1/PRI) > USER TERM (PRI) > IFCE CONFIG (PRI)**Write security: 3; Read security: 5**

Specifies the configuration parameters for the endpoint.

DIAL PLAN (T1/PRI) > USER TERM (PRI) > IFCE CONFIG (PRI) > SWITCH TYPE**Write security: 3; Read security: 5**

Defines the type of PRI switch that the ATLAS 550 emulates. If connected to another ATLAS 550, both need to be set to the same switch type. The following options are available:

- Lucent 5E
- National ISDN
- Northern DMS 100
- AT&T 4ESS

DIAL PLAN (T1/PRI) > USER TERM (PRI) > IFCE CONFIG (PRI) > FIRST DS0**Write security: 3; Read security: 5**

Defines to the ATLAS 550 the first DS0 for this endpoint. The ATLAS 550 uses DS0s, starting with this selection, to send and receive calls to and from the network. The outgoing calls which are allowed or restricted over these DS0s are set by **OUT#ACCEPT** (see *Dial Plan > Network Term > Out#Accept* on page 254) and **OUT#REJECT** (see *Dial Plan > Network Term > Out#Rej* on page 256).

DIAL PLAN (T1/PRI) > USER TERM (PRI) > IFCE CONFIG (PRI) > NUMBER OF DS0s**Write security: 3; Read security: 5**

Specifies the number of DS0s ATLAS 550 uses for this endpoint.

DIAL PLAN (T1/PRI) > USER TERM (PRI) > IFCE CONFIG (PRI) > STRIP MSD**Write security: 3; Read security: 5**Strips a selected quantity (choose from **NONE**, **1**, **2**, and **3**) of the most significant digits (MSD) of a dialed number prior to being forwarded out of the port.Example: A network port could be set to accept all calls beginning with 9 (9\$), and then with **STRIP MSD** set to **1**, all digits would be sent toward the network except the leading 9.**STRIP MSD** does not affect **CALL ACCEPT** criteria. All of the digits (including the MSDs that are subsequently stripped) are used as accept criterion.**DIAL PLAN (T1/PRI) > USER TERM (PRI) > IFCE CONFIG (PRI) > NETWORK SPECIFIC FACILITY VOICE AND DATA****Write security: 3; Read security: 5**Enables the sending of appropriate information to the PSTN. The default for this option is **NORMAL**, and in this case no Network Specific Facility Information Element is sent. Unless one of the services listed below is subscribed to, the selection should remain set to **NORMAL**.

The list below indicates services that may be subscribed to from the PSTN. These services require that specific information (such as a Network Specific Facility Information Element) be sent to the network during call setup.

- AT&T SDN
- AT&T International-800
- Nortel InWats
- AT&T Megacom 800
- AT&T Dial-It 900/Multiquest
- Nortel OutWats
- AT&T Megacom
- National ISDN INWATS
- Nortel Foreign Exchange
- AT&T Accunet
- Nortel Private Network
- Nortel Tie Trunk
- AT&T Long Distance

DIAL PLAN (T1/PRI) > USER TERM (PRI) > IFCE CONFIG (PRI) > CALLED DIGITS TRANSFERRED**Write security: 3; Read security: 5**Defines the number of digits to forward from the called number. When attached to a PBX, the PBX may be provisioned to expect to receive fewer than all of the called digits of the incoming call; however, this option would normally be set to **ALL**. Choose from **NONE**, **THREE**, **FOUR**, **SEVEN**, or **ALL**.

DIAL PLAN (T1/PRI) > USER TERM (PRI) > IFCE CONFIG (PRI) > OUTGOING CALLER ID**Write security: 3; Read security: 5**

Defines the number to use to provide Caller ID to the Network for outgoing calls sent through this endpoint. Choose from **SEND AS PROVIDED**, **SUBSTITUTE IF NOT PRESENT**, or **SUBSTITUTE ALWAYS**.



The Caller ID number must be specific (i.e., no wildcards).

DIAL PLAN (T1/PRI) > USER TERM (PRI) > IFCE CONFIG (PRI) > SOURCE ID**Write security: 3; Read security: 5**

Simplifies the creation of a dial plan in applications where the criterion for switching calls to a certain endpoint is a function of which endpoint originated the call.

DEFAULT VALUE = 0. Zero is the default ID for all endpoints and all accept numbers. With default values, all calls are routed based only on the dialed number.

Multiple endpoints can have the same **SOURCE ID**.

When creating the **CALL ACCEPT** list, specify a **SOURCE ID(s)** as well as a dialed number or range of dialed numbers to accept.

Example: An application requires that all calls that originate from Port 1 of the ATLAS 550 in Slot 1 be switched to Port 2 of that same module. Assign a unique **SOURCE ID** (e.g., 7) to Port 1 of the module, and then configure Port 2 to only accept calls from that unique **SOURCE ID** (7).

DIAL PLAN (T1/PRI) > USER TERM (PRI) > IFCE CONFIG (PRI) > SWAP ANI/DNIS**Write security: 3; Read security: 5**

Swaps the ANI and DNIS numbers received from the network. **ANI** (Automatic Number Identification) is the billing number of the calling party, and **DNIS** (Dialed Number Identification Service) is the called party number.



With this swap, the ATLAS 550 switchboard uses ANI to route the call. The accept number in the dial plan must use the ANI number, not the DNIS number.

DIAL PLAN (T1/PRI) > USER TERM (PRI) > IFCE CONFIG (PRI) > B CHANNEL SELECTION**Write security: 3; Read security: 5**

Determines how the ATLAS 550 switchboard uses B channels for call routing. The Circular method can be used for call load balancing among the available B channels on this interface.

NORMAL	Always start with the last channel configured (i.e., for a full PRI channel 23 would be used if available).
CIRCULAR	Contiguous channels from last to first.

DIAL PLAN (T1/PRI) > USER TERM (PRI) > IFCE CONFIG (PRI) > BUSY OPTION**Write security: 3; Read security: 5**

Defines the response propagated to the CPE upon receipt of a **DISCONNECT USER-BUSY** message from the network.

- | | |
|------------------|---|
| NORMAL | Send a Progress message to the CPE and map busy tones. |
| PASS-THRU | Send a DISCONNECT USER-BUSY message to the User Term CPE device. |

DIAL PLAN (T1/PRI) > USER TERM (RBS)**Write security: 3; Read security: 5**

This menu allows the user to define option parameters for ports which emulate an RBS T1 connection from the network.

DIAL PLAN (T1/PRI) > USER TERM (RBS) > IFCE CONFIG (RBS)**Write security: 3; Read security: 5**

Specifies the configuration parameters for the endpoint.

DIAL PLAN (T1/PRI) > USER TERM (RBS) > IFCE CONFIG (RBS) > FIRST DS0**Write security: 3; Read security: 5**

Defines the first DS0 for this endpoint. The ATLAS 550 uses DS0s, starting with this selection, to send and receive calls to and from the network. The outgoing calls which are allowed or restricted over these DS0s are set by **OUT#ACCEPT** (see page 181) and **OUT#REJECT** (see page 183).

DIAL PLAN (T1/PRI) > USER TERM (RBS) > IFCE CONFIG (RBS) > NUMBER OF DS0s**Write security: 3; Read security: 5**

Specifies the number of DS0s ATLAS 550 uses for this endpoint.

DIAL PLAN (T1/PRI) > USER TERM (RBS) > IFCE CONFIG (RBS) > DS0s AVAILABLE**Write security: 3; Read security: 5**

Indicates which DS0s of the T1 have been defined in this switched endpoint (indicated by “!”), in another switched endpoint (indicated by “s”), or in a **DEDICATED MAP** (indicated by “n”). This field is read-only. The following characters may display in this field:

- | | |
|------------|---|
| 0-9 | This DS0 is available. The digit that displays in this field represents the last digit of the DS0 number. |
| * | This port is requesting this DS0 for this connection, but the DS0 is not yet activated. |
| ! | This DS0 is used by this endpoint. |
| S | This DS0 is used elsewhere in the switched DIAL PLAN . |
| S | This DS0 is in the switched dial plan and conflicts with this endpoint. |
| N | This DS0 is used in one or more DEDICATED MAPS . |
| N | This DS0 is in one or more DEDICATED MAPS , and conflicts with this endpoint. |

DIAL PLAN (T1/PRI) > USER TERM (RBS) > IFCE CONFIG (RBS) > SIGNALING METHOD**Write security: 3; Read security: 5**

Defines the type of signaling to be used across this trunk. The signaling selected needs to match the signaling being provided by the network. The following choices are available:

- E&M Immediate
- E&M Wink
- Loop Start
- Ground Start
- Feature Group D



The ATLAS 550 converts signaling types between network and user terminations.

DIAL PLAN (T1/PRI) > USER TERM (RBS) > IFCE CONFIG (RBS) > FGD TX SEQUENCE**Write security: 3; Read security: 5**

Displayed only if **SIGNALING METHOD** is configured for **FEATURE GROUP D**. Defines the format in which to present the outgoing digits. Choices: **NORMAL** if no digits are to be sent; **ANI/DNIS** to send both ANI and DNIS; **DNIS** to send DNIS only; **ANI** to send ANI only.

DIAL PLAN (T1/PRI) > USER TERM (RBS) > IFCE CONFIG (RBS) > FGD RX SEQUENCE**Write security: 3; Read security: 5**

Displayed only if **SIGNALING METHOD** is configured for **FEATURE GROUP D**. Defines the format in which to receive the incoming digits. Choices: **NORMAL** if no digits are to be received; **ANI/DNIS** to receive both ANI and DNIS; **DNIS** to receive DNIS only; **ANI** to receive ANI only.

DIAL PLAN (T1/PRI) > USER TERM (RBS) > IFCE CONFIG (RBS) > WINK AFTER ANI/DNIS**Write security: 3; Read security: 5**

Displayed only if **SIGNALING METHOD** is configured for **FEATURE GROUP D**. When enabled, the ATLAS 550 will transmit a wink after ANI/DNIS digits are transmitted.

DIAL PLAN (T1/PRI) > USER TERM (RBS) > IFCE CONFIG (RBS) > DIRECT INWARD DIALING**Write security: 3; Read security: 5**

Defines whether Direct Inward Dialing (**DID**) is being used by the network. If **DID** is **ENABLED**, then the following information must be defined.

DIAL PLAN (T1/PRI) > USER TERM (RBS) > IFCE CONFIG (RBS) > CALLER ID NUMBER**Write security: 3; Read security: 5**

Defines the number the ATLAS 550 uses to provide caller ID to the network for outgoing calls sent

through this endpoint. This item is optional.



The Caller ID number must be specific (i.e., no wildcards).

DIAL PLAN (T1/PRI) > USER TERM (RBS) > IFCE CONFIG (RBS) > DID DIGITS TRANSFERRED

Write security: 3; Read security: 5

Defines the number of digits sent to ATLAS 550 from the network if **DID** is used. This option only displays if **DID** is set to **ENABLED**.



*If **FEATURE GROUP D** is used, **DID** only refers to **DNIS** digits.*

DIAL PLAN (T1/PRI) > USER TERM (RBS) > IFCE CONFIG (RBS) > STRIP MSD

Write security: 3; Read security: 5

Strips a selected quantity (choose from **NONE**, **1**, **2**, and **3**) of the most significant digits (MSD) of a dialed number prior to being forwarded out of the port.

Example: A network port could be set to accept all calls beginning with 9 (9\$), and then with **STRIP MSD** set to **1**, all digits would be sent toward the network except the leading 9.



***STRIP MSD** does not affect **CALL ACCEPT** criteria. All of the digits (including the MSDs that are subsequently stripped) are used as accept criterion.*

DIAL PLAN (T1/PRI) > USER TERM (RBS) > IFCE CONFIG (RBS) > SOURCE ID

Write security: 3; Read security: 5

Simplifies the creation of a **DIAL PLAN** in applications where the criterion for switching calls to a certain endpoint is a function of which endpoint originated the call.

DEFAULT VALUE = 0. Zero is the default ID for all endpoints and all accept numbers. With default values, all calls are routed based only on the dialed number.

Multiple endpoints can have the same **SOURCE ID**.

When creating the **CALL ACCEPT** list, specify a **SOURCE ID(s)** as well as a dialed number or range of dialed numbers to accept.

Example: An application requires that all calls that originate from Port 1 of the ATLAS 830 in Slot 1 be switched to Port 2 of that same module. Assign a unique **SOURCE ID** (e.g., 7) to Port 1 of the module, and then configure Port 2 to only accept calls from that unique **SOURCE ID** (7).

DIAL PLAN (T1/PRI) > USER TERM (RBS) > IFCE CONFIG (RBS) > DIAL ON OFFHOOK**Write security: 3; Read security: 5**

Defines a number that is automatically sent to the switchboard when a call on this endpoint is initiated (goes off hook).

**NOTE**

*The **DIAL ON OFFHOOK** number must be specific (i.e., no wildcards).*

DIAL PLAN (T1/PRI) > USER TERM (RBS) > IFCE CONFIG (RBS) > DS0 SELECTION**Write security: 3; Read security: 5**

Determines how the ATLAS 550 switchboard uses DS0s for call routing.

NORMAL	Always start with the last channel configured (i.e., for a full PRI channel 23 would be used if available).
CIRCULAR	Contiguous channels from last to first. Use for call load balancing among the available DS0s on this interface.
ALIGNED	Provides the ability to maintain alignment between T1s as if they were in dedicated map mode. This scenario requires DS0 SELECTION set to ALIGNED on both interfaces (usually on User Term and on Net Term). An interface that has DS0 SELECTION set to ALIGNED will only process a call from the switchboard on the same DS0 that the incoming call was received.

Example: The unit receives an incoming call on DS0 17. The switchboard looks for an interface who has matching accept criteria to the number it received. A match is found on interface "Z" that has **DS0 SELECTION** set to **ALIGNED**. This causes interface "Z" to only process the call if it has DS0 17 available. If all matching interfaces have **DS0 SELECTION** set to **ALIGNED** and none of those interfaces have DS0 17 available, then a busy or fast busy will be returned to the calling party.

DIAL PLAN (E1/PRA NETWORK MODULE)

*E1 TS0s are referred to as DS0s throughout the **DIAL PLAN** menus.*

DIAL PLAN (E1/PRA) > NETWORK TERM (PRA)**Write security: 3; Read security: 5**

This menu allows the user to define option parameters for ports which terminate a PRA connection from the network.

DIAL PLAN (E1/PRA) > NETWORK TERM (PRA) > IFCE CONFIG (PRA)**Write security: 3; Read security: 5**

Specifies the configuration parameters for the endpoint.

DIAL PLAN (E1/PRA) > NETWORK TERM (PRA) > IFCE CONFIG (PRA) > SWITCH TYPE**Write security: 3; Read security: 5**

Defines the type of PRA switch to which the port is connected. If connected to another ATLAS 550, both need to be set to the same switch type. The following option is available:

- ETSI/DSS1

DIAL PLAN (E1/PRA) > NETWORK TERM (PRA) > IFCE CONFIG (PRA) > FIRST DS0**Write security: 3; Read security: 5**

Defines the first DS0 for this endpoint. The ATLAS 550 uses DS0s, starting with this selection, to send and receive calls to and from the network (PSTN). The outgoing calls which are allowed or restricted over these DS0s are set by **OUT#ACCEPT** (see *Dial Plan > Network Term > Out#Accept* on page 254) and **OUT#REJECT** (see *Dial Plan > Network Term > Out#Rej* on page 256).

DIAL PLAN (E1/PRA) > NETWORK TERM (PRA) > IFCE CONFIG (PRA) > NUMBER OF DS0S**Write security: 3; Read security: 5**

Specifies the number of DS0s ATLAS 550 uses for this endpoint.

DIAL PLAN (E1/PRA) > NETWORK TERM (PRA) > IFCE CONFIG (PRA) > STRIP MSD**Write security: 3; Read security: 5**

Strips a selected quantity (choose from **NONE**, **1**, **2**, and **3**) of the most significant digits (MSD) of a dialed number prior to being forwarded out of the port.

Example: A network port could be set to accept all calls beginning with 9 (9\$), and then with **STRIP MSD** set to **1**, all digits would be sent toward the network except the leading 9.



STRIP MSD does not affect **CALL ACCEPT** criteria. All of the digits (including the MSDs that are subsequently stripped) are used as accept criterion.

DIAL PLAN (E1/PRA) > NETWORK TERM (PRA) > IFCE CONFIG (PRA) > NETWORK SPECIFIC FACILITY VOICE AND DATA**Write security: 3; Read security: 5**

Enables the sending of appropriate information to the PSTN. Currently not supported for E1/PRA use.

DIAL PLAN (E1/PRA) > NETWORK TERM (PRA) > IFCE CONFIG (PRA) > CALLED DIGITS TRANSFERRED**Write security: 3; Read security: 5**

Some PRI switches may be provisioned to send only a portion of the called number (like DID). This menu item allows the ATLAS 550 to know how many digits to expect (choose from **NONE**, **THREE**, **FOUR**, **SEVEN**, and **ALL**). The default is **ALL** and would almost always be correct. If less than **ALL** digits are sent, then the **PREFIX** is defined as follows:

PREFIX**Write security: 3; Read security: 5**

Displays only if **CALLED DIGITS TRANSFERRED** is not set to **ALL**. Enter the prefix for the digits received.

Example: If the number of digits is four and the number called is 963-8615, the telco's PRI switch sends only 8615 and the prefix is set to 963. This entire number is then used to determine which ATLAS 550 user port endpoint should receive the call.

DIAL PLAN (E1/PRA) > NETWORK TERM (PRA) > IFCE CONFIG (PRA) > OUTGOING CALLER ID**Write security: 3; Read security: 5**

Defines the number to use to provide Caller ID to the network for outgoing calls sent through this endpoint. Choose from **SEND AS PROVIDED**, **SUBSTITUTE IF NOT PRESENT**, or **SUBSTITUTE ALWAYS**.



The Caller ID number must be specific (i.e., no wildcards).

DIAL PLAN (E1/PRA) > NETWORK TERM (PRA) > IFCE CONFIG (PRA) > SOURCE ID**Write security: 3; Read security: 5**

Simplifies the creation of a dial plan in applications where the criterion for switching calls to a certain endpoint is a function of which endpoint originated the call.

DEFAULT VALUE = 0. Zero is the default ID for all endpoints and all accept numbers. With default values, all calls are routed based only on the dialed number.

Multiple endpoints can have the same **SOURCE ID**.

When creating the **CALL ACCEPT** list, specify a **SOURCE ID(s)** as well as a dialed number or range of dialed numbers to accept.

Example: An application requires that all calls that originate from Port 1 of the ATLAS 550 in Slot 1 be switched to Port 2 of that same module. Assign a unique **SOURCE ID** (e.g., 7) to Port 1 of the module, and then configure Port 2 to only accept calls from that unique **SOURCE ID** (7).

DIAL PLAN (E1/PRA) > NETWORK TERM (PRA) > IFCE CONFIG (PRA) > SWAP ANI/DNIS**Write security: 3; Read security: 5**

Swaps the ANI and DNIS numbers received from the network. ANI (Automatic Number Identification) is the billing number of the calling party, and DNIS (Dialed Number Identification Service) is the called party number.



With this swap, the ATLAS 550 switchboard uses ANI to route the call. The accept number in the dial plan must use the ANI number, not the DNIS number.

DIAL PLAN (E1/PRA) > NETWORK TERM (PRA) > IFCE CONFIG (PRA) > B CHANNEL SELECTION**Write security: 3; Read security: 5**

Determines how the ATLAS 550 switchboard uses B channels for call routing. The Circular method can be used for call load balancing among the available B channels on this interface.

NORMAL	Always start with the last channel configured (i.e., for a full PRI channel 23 would be used if available).
CIRCULAR	Contiguous channels from last to first.

DIAL PLAN (E1/PRA) > USER TERM (PRA)

Write security: 3; Read security: 5

This menu allows the user to define option parameters for ports which emulate a PRA connection.

DIAL PLAN (E1/PRA) > USER TERM (PRA) > IFCE CONFIG (PRA)

Write security: 3; Read security: 5

Specifies the configuration parameters for the endpoint.

DIAL PLAN (E1/PRA) > USER TERM (PRA) > IFCE CONFIG (PRA) > SWITCH TYPE

Write security: 3; Read security: 5

Defines the type of PRA switch that the ATLAS 550 emulates. If connected to another ATLAS 550, both need to be set to the same switch type. The following option is available:

- ETSI/DSS1

DIAL PLAN (E1/PRA) > USER TERM (PRA) > IFCE CONFIG (PRA) > FIRST DS0

Write security: 3; Read security: 5

Defines the first DS0 for this endpoint. The ATLAS 550 uses DS0s, starting with this selection, to send and receive calls to and from the network. The outgoing calls which are allowed or restricted over these DS0s are set by **OUT#ACCEPT** (see *Dial Plan > Network Term > Out#Accept* on page 254) and **OUT#REJECT** (see *Dial Plan > Network Term > Out#Rej* on page 256).

DIAL PLAN (E1/PRA) > USER TERM (PRA) > IFCE CONFIG (PRA) > NUMBER OF DS0s

Write security: 3; Read security: 5

Specifies the number of DS0s ATLAS 550 uses for this endpoint.

DIAL PLAN (E1/PRA) > USER TERM (PRA) > IFCE CONFIG (PRA) > STRIP MSD

Write security: 3; Read security: 5

Strips a selected quantity (choose from **NONE**, **1**, **2**, and **3**) of the most significant digits (MSD) of a dialed number prior to being forwarded out of the port.

Example: A network port could be set to accept all calls beginning with 9 (9\$), and then with **STRIP MSD** set to **1**, all digits would be sent toward the network except the leading 9.



STRIP MSD does not affect **CALL ACCEPT** criteria. All of the digits (including the MSDs that are subsequently stripped) are used as accept criterion.

DIAL PLAN (E1/PRA) > USER TERM (PRA) > IFCE CONFIG (PRA) > NETWORK SPECIFIC FACILITY VOICE AND DATA

Write security: 3; Read security: 5

Enables the sending of appropriate information to the PSTN. Currently not supported for E1/PRA use.

DIAL PLAN (E1/PRA) > USER TERM (PRA) > IFCE CONFIG (PRA) > CALLED DIGITS TRANSFERRED**Write security: 3; Read security: 5**

Defines the number of digits to forward from the called number. When attached to a PBX, the PBX may be provisioned to expect to receive fewer than all of the called digits of the incoming call; however, this option would normally be set to **ALL**. Choose from **NONE**, **THREE**, **FOUR**, **SEVEN**, or **ALL**.

DIAL PLAN (E1/PRA) > USER TERM (PRA) > IFCE CONFIG (PRA) > OUTGOING CALLER ID**Write security: 3; Read security: 5**

Defines the number to use to provide Caller ID to the network for outgoing calls sent through this endpoint. Choose from **SEND AS PROVIDED**, **SUBSTITUTE IF NOT PRESENT**, or **SUBSTITUTE ALWAYS**.

 **NOTE**

The Caller ID number must be specific (i.e., no wildcards).

DIAL PLAN (E1/PRA) > USER TERM (PRA) > IFCE CONFIG (PRA) > SOURCE ID**Write security: 3; Read security: 5**

Simplifies the creation of a dial plan in applications where the criterion for switching calls to a certain endpoint is a function of which endpoint originated the call.

DEFAULT VALUE = 0. Zero is the default ID for all endpoints and all accept numbers. With default values, all calls are routed based only on the dialed number.

Multiple endpoints can have the same **SOURCE ID**.

When creating the **CALL ACCEPT** list, specify a **SOURCE ID(s)** as well as a dialed number or range of dialed numbers to accept.

Example: An application requires that all calls that originate from Port 1 of the ATLAS 550 in Slot 1 be switched to Port 2 of that same module. Assign a unique **SOURCE ID** (e.g., 7) to Port 1 of the module, and then configure Port 2 to only accept calls from that unique **SOURCE ID (7)**.

DIAL PLAN (E1/PRA) > USER TERM (PRA) > IFCE CONFIG (PRA) > SWAP ANI/DNIS**Write security: 3; Read security: 5**

Swaps the ANI and DNIS numbers received from the network. ANI (Automatic Number Identification) is the billing number of the calling party, and DNIS (Dialed Number Identification Service) is the called party number.

 **NOTE**

With this swap, the ATLAS 550 switchboard uses ANI to route the call. The accept number in the dial plan must use the ANI number, not the DNIS number.

DIAL PLAN (E1/PRA) > USER TERM (PRA) > IFCE CONFIG (PRA) > B CHANNEL SELECTION**Write security: 3; Read security: 5**

Determines how the ATLAS 550 switchboard uses B channels for call routing. The Circular method can be used for call load balancing among the available B channels on this interface.

NORMAL	Always start with the last channel configured (i.e., for a full PRI channel 23 would be used if available).
CIRCULAR	Contiguous channels from last to first.

DIAL PLAN (BRI DBU NETWORK INTERFACE AND QUAD BRI/U MODULES)

All menu items in this section (listed as **U-BRI**) apply to BRI DBU Network and Quad BRI/U Module interfaces configured in the **DIAL PLAN**.

DIAL PLAN (U-BRI) > NETWORK TERM**Write security: 3; Read security: 5**

This menu allows the user to define option parameters for ports which terminate a BRI connection from the network.

DIAL PLAN (U-BRI) > NETWORK TERM > IFCE CONFIG**Write security: 3; Read security: 5**

Specifies the configuration parameters for the endpoint.

DIAL PLAN (U-BRI) > NETWORK TERM > IFCE CONFIG > SWITCH TYPE**Write security: 3; Read security: 5**

Defines the type of BRI switch to which the port is connected. If connected to another ATLAS 550, both need to be set to the same switch type. The following options are available:

- Lucent 5E
- Northern DMS 100
- National ISDN

DIAL PLAN (U-BRI) > NETWORK TERM > IFCE CONFIG > SPID LIST**Write security: 3; Read security: 5**

To properly operate with a network ISDN switch, the BRI interface must have Service Profile Identifiers (SPIDs) and phone number(s) that match the SPID(s) and phone number(s) programmed into the ISDN switch for this line. Each BRI may have one or more phone numbers and SPIDs. The **SPID LIST** submenu defines these parameters to ATLAS.

PHONE NUMBER**Write security: 3; Read security: 5**

The phone number(s) assigned to this BRI phone line.

SPID NUMBER**Write security: 3; Read security: 5**

This entry must match the SPID number(s) which has been set in the network's ISDN switch (or in the PBX) for this BRI line. A SPID must be entered for each phone number.

CALLS**Write security: 3; Read security: 5**

The number of calls (1 or 2) which can be received or sent on this number/SPID.

D64, D56, AUDIO, SPEECH**Write security: 3; Read security: 5**

These options reflect the network provisions for this SPID. If the BRI was purchased with different services provisioned for the SPIDs, then the call must match the services supported.

DIAL PLAN (U-BRI) > NETWORK TERM > IFCE CONFIG > STRIP MSD**Write security: 3; Read security: 5**

Strips a selected quantity (choose from **NONE**, **1**, **2**, and **3**) of the most significant digits (MSD) of a dialed number prior to being forwarded out of the port.

Example: A network port could be set to accept all calls beginning with 9 (9\$), and then with **STRIP MSD** set to **1**, all digits would be sent toward the network except the leading 9.



STRIP MSD does not affect **CALL ACCEPT** criteria. All of the digits (including the MSDs that are subsequently stripped) are used as accept criterion.

DIAL PLAN (U-BRI) > NETWORK TERM > IFCE CONFIG > SOURCE ID**Write security: 3; Read security: 5**

Simplifies the creation of a dial plan in applications where the criterion for switching calls to a certain endpoint is a function of which endpoint originated the call.

DEFAULT VALUE = 0. Zero is the default ID for all endpoints and all accept numbers. With default values, all calls are routed based only on the dialed number.

Multiple endpoints can have the same **SOURCE ID**.

When creating the **CALL ACCEPT** list, specify a **SOURCE ID(s)** as well as a dialed number or range of dialed numbers to accept.

Example: An application requires that all calls that originate from Port 1 of the ATLAS 550 in Slot 1 be switched to Port 2 of that same module. Assign a unique **SOURCE ID** (e.g., 7) to Port 1 of the module, and then configure Port 2 to only accept calls from that unique **SOURCE ID** (7).

DIAL PLAN (U-BRI) > NETWORK TERM > IFCE CONFIG > SWAP ANI/DNIS**Write security: 3; Read security: 5**

Swaps the ANI and DNIS numbers received from the network. ANI (Automatic Number Identification) is

the billing number of the calling party, and DNIS (Dialed Number Identification Service) is the called party number.

DIAL PLAN (U-BRI) > USER TERM

Write security: 3; Read security: 5

This menu allows the user to define option parameters for ports which emulate a BRI connection.

DIAL PLAN (U-BRI) > USER TERM > IFCE CONFIG

Write security: 3; Read security: 5

Specifies the configuration parameters for the endpoint.

DIAL PLAN (U-BRI) > USER TERM > IFCE CONFIG > SWITCH TYPE

Defines the type of BRI switch the ATLAS 550 emulates. If connected to another ATLAS 550, both need to be set to the same switch type. The following options are available:

- Lucent 5E
- Northern DMS 100
- National ISDN

DIAL PLAN (U-BRI) > USER TERM > IFCE CONFIG > SPID LIST

The port, acting as the network, must use a Service Profile Identifier (SPID) and phone number(s) in order to satisfy the ISDN connection protocol expected by the user's terminal adapter (TA).

PHONE NUMBER

Write security: 3; Read security: 5

The phone number(s) assigned to this BRI phone line.

SPID NUMBER

Write security: 3; Read security: 5

This entry must match the SPID number(s) which has been set in the network's ISDN switch (or in the PBX) for this BRI line. A SPID must be entered for each phone number.



The ATLAS 550 does not support autoSPID detection software which some terminal adapters offer.

CALLS

Write security: 3; Read security: 5

The number of calls (1 or 2) which can be received or sent on this number/SPID.

D64, D56, AUDIO, SPEECH

Write security: 3; Read security: 5

These options reflect the network provisions for this SPID. If the BRI was purchased with different services provisioned for the SPIDs, then the call must match the services supported.

DIAL PLAN (U-BRI) > USER TERM > IFCE CONFIG > STRIP MSD

Strips a selected quantity (choose from **NONE**, **1**, **2**, and **3**) of the most significant digits (MSD) of a dialed number prior to being forwarded out of the port.

Example: A network port could be set to accept all calls beginning with 9 (9\$), and then with **STRIP MSD** set to **1**, all digits would be sent toward the network except the leading 9.



STRIP MSD does not affect **CALL ACCEPT** criteria. All of the digits (including the MSDs that are subsequently stripped) are used as accept criterion.

DIAL PLAN (U-BRI) > USER TERM > IFCE CONFIG > SOURCE ID

Simplifies the creation of a dial plan in applications where the criterion for switching calls to a certain endpoint is a function of which endpoint originated the call.

DEFAULT VALUE = 0. Zero is the default ID for all endpoints and all accept numbers. With default values, all calls are routed based only on the dialed number.

Multiple endpoints can have the same **SOURCE ID**.

When creating the **CALL ACCEPT** list, specify a **SOURCE ID(s)** as well as a dialed number or range of dialed numbers to accept.

Example: An application requires that all calls that originate from Port 1 of the ATLAS 550 in Slot 1 be switched to Port 2 of that same module. Assign a unique **SOURCE ID** (e.g., 7) to Port 1 of the module, and then configure Port 2 to only accept calls from that unique **SOURCE ID** (7).

DIAL PLAN (U-BRI) > USER TERM > IFCE CONFIG > SWAP ANI/DNIS

Swaps the ANI and DNIS numbers received from the network. ANI (Automatic Number Identification) is the billing number of the calling party, and DNIS (Dialed Number Identification Service) is the called party number.

DIAL PLAN (U-BRI) > USER TERM > IFCE CONFIG > OUTGOING CALLER ID

Defines the number for the ATLAS 550 to use to provide Caller ID to the Network for outgoing calls sent through this endpoint. Choose from **SEND AS PROVIDED**, **SUBSTITUTE IF NOT PRESENT**, or **SUBSTITUTE ALWAYS**.



The Caller ID number must be specific (i.e., no wildcards).

DIAL PLAN (QUAD/OCTAL FXS MODULE)**DIAL PLAN (FXS) > USER TERM**

Write security: 3; Read security: 5

This menu allows the user to define option parameters for ports which emulate an analog FXS connection

from the Network (PSTN).

DIAL PLAN (FXS) > USER TERM > IFCE CONFIG

Write security: 3; Read security: 5

Specifies the configuration parameters for the endpoint.

DIAL PLAN (FXS) > USER TERM > IFCE CONFIG > PORTS AVAILABLE

Write security: 3; Read security: 5

Indicates which ports of the Quad/Octal FXS Option Modules have been defined in this switched endpoint (indicated by “! “), in another switched endpoint (indicated by “s”), or in a **DEDICATED MAP** (indicated by “n”). This field is read-only. The following characters may display in this field:

0-9	This port is available.
*	This port is requesting this port for this connection, but the port is not yet activated.
!	This port is used by this endpoint.
S	This port is used elsewhere in the switched DIAL PLAN .
S	This port is in the switched dial plan and conflicts with this endpoint.
N	This port is used in one or more DEDICATED MAPS .
N	This port is in one or more DEDICATED MAPS , and conflicts with this endpoint.
•	This port is the wrong kind of port for this endpoint.

DIAL PLAN (FXS) > USER TERM > IFCE CONFIG > NUMBER OF PORTS

Write security: 3; Read security: 5

Specifies the number of ports ATLAS 550 uses for this endpoint.

DIAL PLAN (FXS) > USER TERM > IFCE CONFIG > SIGNALING METHOD

Write security: 3; Read security: 5

Defines to the ATLAS 550 the type of signaling to be used across this trunk. The signaling selected needs to match the signaling being provided by the network (PSTN). The following choices are available:

- Loop Start
- Ground Start



The ATLAS 550 converts signaling types between two endpoints (network or user terms).

DIAL PLAN (FXS) > USER TERM > IFCE CONFIG > FORWARD DISCONNECT

Write security: 3; Read security: 5

In Loop Start applications, **FORWARD DISCONNECT** configures the length of time loop current will stop

flowing once the far end has terminated the call. Applications requiring Forward Disconnect are Fax Servers and ACDs.

DIAL PLAN (FXS) > USER TERM > IFCE CONFIG > DIRECT INWARD DIALING

Write security: 3; Read security: 5

Defines to the ATLAS 550 whether Direct Inward Dialing (**DID**) is being used by the network. If **DID** is **ENABLED**, then the following information must be defined:

DIAL PLAN (FXS) > USER TERM > IFCE CONFIG > DID DIGITS TRANSFERRED

Write security: 3; Read security: 5

Defines the number of digits sent to ATLAS 550 from the network if **DID** is used. This option only displays if **DID** is set to **ENABLED**.

DIAL PLAN (FXS) > USER TERM > IFCE CONFIG > CALLER ID NUMBER

Write security: 3; Read security: 5

Defines the number the ATLAS 550 uses to provide caller ID to the network for outgoing calls sent through this endpoint. This item is optional.



The Caller ID number must be specific (i.e., no “wild cards”).

DIAL PLAN (FXS) > USER TERM > IFCE CONFIG > STRIP MSD

Write security: 3; Read security: 5

Strips a selected quantity (choose from **NONE**, **1**, **2**, and **3**) of the Most Significant Digits (MSD) of a dialed number prior to being forwarded out of the port.

Example: A network port could be set to accept all calls beginning with 9 (9\$), and then with **STRIP MSD** set to **1**, all digits would be sent toward the network except the leading 9.



***STRIP MSD** does not affect **CALL ACCEPT** criteria. All of the digits (including the MSDs that are subsequently stripped) are used as accept criterion.*

DIAL PLAN (FXS) > USER TERM > IFCE CONFIG > SOURCE ID**Write security: 3; Read security: 5**

Simplifies the creation of a **DIAL PLAN** in applications where the criterion for switching calls to a certain endpoint is a function of which endpoint originated the call.

DEFAULT VALUE = 0. The default ID for all endpoints is 0 and all accept numbers is 0. With default values, all calls are routed based only on the dialed number.

Multiple endpoints can have the same **SOURCE ID**.

When creating the **CALL ACCEPT** list, specify a **SOURCE ID(s)** as well as a dialed number or range of dialed numbers to accept.

Example: An application requires that all calls that originate from Port 1 of the ATLAS 550 in Slot 1 be switched to Port 2 of that same module. Assign a unique **SOURCE ID** (e.g., 7) to Port 1 of the module, and then configure Port 2 to only accept calls from that unique **SOURCE ID** (7).

DIAL PLAN (FXS) > USER TERM > IFCE CONFIG > PORT SELECTION**Write security: 3; Read security: 5**

Determines how the ATLAS 550 switchboard uses FXS ports for call routing. The **CIRCULAR** method can be used for call load balancing among the available ports on the module.

NORMAL	Always start with the lowest numbered available port (i.e., for a Quad FXS Module with four configured interfaces, Port 1 would always be used first if available).
CIRCULAR	Contiguous ports from last to first.
ALIGNED	Provides the ability to maintain alignment between ports as if they were in dedicated map mode. This scenario requires PORT SELECTION set to ALIGNED on both interfaces (usually on User Term and on Net Term). An interface that has PORT SELECTION set to ALIGNED will only process a call from the switchboard on the same port that the incoming call was received.

Example: The unit receives an incoming call on Port 3. The switchboard looks for an interface who has matching accept criteria to the number it received. A match is found on interface "Z" that has **PORT SELECTION** set to **ALIGNED**. This causes interface "Z" to only process the call if it has Port 3 available. If all matching interfaces have **PORT SELECTION** set to **ALIGNED** and none of those interfaces have Port 3 available, then a busy or fast busy will be returned to the calling party.

DIAL PLAN (FXS) > USER TERM > IFCE CONFIG > DIAL ON OFFHOOK**Write security: 3; Read security: 5**

Defines a number that is automatically sent to the switchboard when a call on this endpoint is initiated (goes off hook).



The Dial on Offhook number must be specific (i.e., no "wild cards").

DIAL PLAN (FXS) > USER TERM > IFCE CONFIG > ANI TO CALLER ID**Write security: 3; Read security: 5**

Use this option to generate (FSK) Caller ID out the FXS user term port to the subscriber. The ATLAS 550 generates Caller ID from the calling party number (typically when the call is terminated from a PRI). The calling party number may also come from a Trunk Number on a network term entry, or from the Caller ID field on a user term entry (if the call comes from one of these sources).

Additional CPE equipment is needed to receiver Caller ID, such as a Caller ID box. To receive Calling Name information, this equipment must support Multiple Data Message Format (MDMF).



Calling Name will only be delivered (with the number) if a call is received from a PRI that has been provisioned to provide Calling Name information. Otherwise, only the Calling Party Number will be generated.

DIAL PLAN (QUAD/OCTAL FXO MODULE)**DIAL PLAN (FXO) > NETWORK TERM****Write security: 3; Read security: 5**

This menu allows the user to define option parameters for ports which terminate an analog FXO connection from the Network (PSTN).

DIAL PLAN (FXO) > NETWORK TERM > IFCE CONFIG**Write security: 3; Read security: 5**

Specifies the configuration parameters for the endpoint.

DIAL PLAN (FXO) > NETWORK TERM > IFCE CONFIG > PORTS AVAILABLE**Write security: 3; Read security: 5**

Indicates which ports of the Quad/Octal FXO Option Modules have been defined in this switched endpoint (indicated by “! “), in another switched endpoint (indicated by “s”), or in a **DEDICATED MAP** (indicated by “n”). This field is read-only. The following characters may display in this field:

0-9	This port is available.
*	This port is requesting this port for this connection, but the port is not yet activated.
!	This port is used by this endpoint.
S	This port is used elsewhere in the switched DIAL PLAN .
S	This port is in the switched dial plan and conflicts with this endpoint.
N	This port is used in one or more DEDICATED MAPS .
N	This port is in one or more DEDICATED MAPS , and conflicts with this endpoint.
•	This port is the wrong kind of port for this endpoint.

DIAL PLAN (FXO) > NETWORK TERM > IFCE CONFIG > NUMBER OF PORTS

Write security: 3; Read security: 5

Specifies the number of ports ATLAS 550 uses for this endpoint.

DIAL PLAN (FXO) > NETWORK TERM > IFCE CONFIG > SIGNALING METHOD

Write security: 3; Read security: 5

Defines to the ATLAS 550 the type of signaling to be used across this trunk. The signaling selected needs to match the signaling being provided by the network (PSTN). The following choices are available:

- Loop Start
- Ground Start



The ATLAS 550 converts signaling types between two endpoints (network or user terms).

DIAL PLAN (FXO) > NETWORK TERM > IFCE CONFIG > DIGIT SUPPRESSION

Write security: 3; Read security: 5

When **ENABLED**, no digits will be sent toward the network/PBX after going off-hook on an outgoing call.

DIAL PLAN (FXO) > NETWORK TERM > IFCE CONFIG > DIRECT INWARD DIALING

Write security: 3; Read security: 5

Defines to the ATLAS 550 whether Direct Inward Dialing (**DID**) is being used by the network. If **DID** is **ENABLED**, then the following information must be defined:

DIAL PLAN (FXO) > NETWORK TERM > IFCE CONFIG > DID DIGITS TRANSFERRED

Write security: 3; Read security: 5

Defines the number of digits sent to ATLAS 550 from the network if **DID** is used. This option only displays if **DID** is set to **ENABLED**.

DIAL PLAN (FXO) > NETWORK TERM > IFCE CONFIG > DID PREFIX

Write security: 3; Read security: 5

*(Visible only if **DIRECT INWARD DIALING** is set to Enabled.)* Defines the prefix digits which are not received as a part of the DID number. The ATLAS 550 uses the combination of prefix and DID number to determine the user endpoint that should receive the incoming call. If **DIRECT INWARD DIALING** is **DISABLED**, a **TRUNK NUMBER** must be defined.

DIAL PLAN (FXO) > NETWORK TERM > IFCE CONFIG > TRUNK NUMBER

Write security: 3; Read security: 5

*(Visible only if **DIRECT INWARD DIALING** is set to Disabled.)* When the network connection does not provide DID digits, the ATLAS 550 must be given a number to use to determine which user endpoint should receive the incoming call.



*The **TRUNK NUMBER** must be specific (i.e., no “wild cards”).*

DIAL PLAN (FXO) > NETWORK TERM > IFCE CONFIG > STRIP MSD**Write security: 3; Read security: 5**

Strips a selected quantity (choose from **NONE**, **1**, **2**, and **3**) of the Most Significant Digits (MSD) of a dialed number prior to being forwarded out of the port.

Example: A network port could be set to accept all calls beginning with 9 (9\$), and then with **STRIP MSD** set to **1**, all digits would be sent toward the network except the leading 9.



STRIP MSD does not affect **CALL ACCEPT** criteria. All of the digits (including the MSDs that are subsequently stripped) are used as accept criterion.

DIAL PLAN (FXO) > NETWORK TERM > IFCE CONFIG > SOURCE ID**Write security: 3; Read security: 5**

Simplifies the creation of a **DIAL PLAN** in applications where the criterion for switching calls to a certain endpoint is a function of which endpoint originated the call.

DEFAULT VALUE = 0. The default ID for all endpoints is 0 and all accept numbers is 0. With default values, all calls are routed based only on the dialed number.

Multiple endpoints can have the same **SOURCE ID**.

When creating the **CALL ACCEPT** list, specify a **SOURCE ID(s)** as well as a dialed number or range of dialed numbers to accept.

Example: An application requires that all calls that originate from Port 1 of the ATLAS 550 in Slot 1 be switched to Port 2 of that same module. Assign a unique **SOURCE ID** (e.g., 7) to Port 1 of the module, and then configure Port 2 to only accept calls from that unique **SOURCE ID** (7).

DIAL PLAN (FXO) > NETWORK TERM > IFCE CONFIG > PORT SELECTION**Write security: 3; Read security: 5**

Determines how the ATLAS 550 switchboard uses FXO ports for call routing. The **CIRCULAR** method can be used for call load balancing among the available ports on the module.

NORMAL	Always start with the lowest numbered available port (i.e., for a Quad FXO Module with four configured interfaces, Port 1 would always be used first if available).
CIRCULAR	Contiguous ports from last to first.
ALIGNED	Provides the ability to maintain alignment between ports as if they were in dedicated map mode. This scenario requires PORT SELECTION set to ALIGNED on both interfaces (usually on User Term and on Net Term). An interface that has PORT SELECTION set to ALIGNED will only process a call from the switchboard on the same port that the incoming call was received.

Example: The unit receives an incoming call on Port 3. The switchboard looks for an interface who has matching accept criteria to the number it received. A match is found on interface "Z" that has **PORT SELECTION** set to **ALIGNED**. This causes interface "Z" to only process the call if it has Port 3 available. If all matching interfaces have **PORT SELECTION** set to **ALIGNED** and none of those interfaces have Port 3 available, then a busy or fast busy will be returned to the calling party.

DIAL PLAN (FXO) > USER TERM**Write security: 3; Read security: 5**

This menu allows the user to define option parameters for ports which terminate an analog FXO connection from the Network (PSTN).

DIAL PLAN (FXO) > USER TERM > IFCE CONFIG**Write security: 3; Read security: 5**

Specifies the configuration parameters for the endpoint.

DIAL PLAN (FXO) > USER TERM > IFCE CONFIG > PORTS AVAILABLE**Write security: 3; Read security: 5**

Indicates which ports of the Quad/Octal FXO Option Modules have been defined in this switched endpoint (indicated by “!”), in another switched endpoint (indicated by “s”), or in a **DEDICATED MAP** (indicated by “n”). This field is read-only. The following characters may display in this field:

0-9	This port is available.
*	This port is requesting this port for this connection, but the port is not yet activated.
!	This port is used by this endpoint.
S	This port is used elsewhere in the switched DIAL PLAN .
S	This port is in the switched dial plan and conflicts with this endpoint.
N	This port is used in one or more DEDICATED MAPS .
N	This port is in one or more DEDICATED MAPS , and conflicts with this endpoint.
•	This port is the wrong kind of port for this endpoint.

DIAL PLAN (FXO) > USER TERM > IFCE CONFIG > NUMBER OF PORTS**Write security: 3; Read security: 5**

Specifies the number of ports ATLAS 550 uses for this endpoint.

DIAL PLAN (FXO) > USER TERM > IFCE CONFIG > SIGNALING METHOD**Write security: 3; Read security: 5**

Defines to the ATLAS 550 the type of signaling to be used across this trunk. The signaling selected needs to match the signaling being provided by the network (PSTN). The following choices are available:

- DPT

DPT mode operation configures the ATLAS 550 to send DID digits out the **USER TERM** port toward the user equipment. DPT mode is one-way operation only. Outbound calls originating from the user equipment will not be processed.



The ATLAS 550 converts signaling types between two endpoints (network or user terms).

DIAL PLAN (FXO) > USER TERM > IFCE CONFIG > DIRECT INWARD DIALING**Write security: 3; Read security: 5**

Defines to the ATLAS 550 whether Direct Inward Dialing (**DID**) is being used by the network. **DID** is **ENABLED** when configuring the FXO Module for **USER TERM** operation and the following information must be defined:

DIAL PLAN (FXO) > USER TERM > IFCE CONFIG > DID DIGITS TRANSFERRED**Write security: 3; Read security: 5**

Defines the number of digits sent to ATLAS 550 from the network if **DID** is used. This option only displays if **DID** is set to **ENABLED**.

DIAL PLAN (FXO) > USER TERM > IFCE CONFIG > STRIP MSD**Write security: 3; Read security: 5**

Strips a selected quantity (choose from **NONE**, **1**, **2**, and **3**) of the Most Significant Digits (MSD) of a dialed number prior to being forwarded out of the port.

Example: A network port could be set to accept all calls beginning with 9 (9\$), and then with **STRIP MSD** set to **1**, all digits would be sent toward the network except the leading 9.



STRIP MSD does not affect Call Accept criteria. All of the digits (including the MSDs that are subsequently stripped) are used as accept criterion.

DIAL PLAN (FXO) > USER TERM > IFCE CONFIG > SOURCE ID**Write security: 3; Read security: 5**

Simplifies the creation of a **DIAL PLAN** in applications where the criterion for switching calls to a certain endpoint is a function of which endpoint originated the call.

DEFAULT VALUE = 0. The default ID for all endpoints is 0 and all accept numbers is 0. With default values, all calls are routed based only on the dialed number.

Multiple endpoints can have the same **SOURCE ID**.

When creating the **CALL ACCEPT** list, specify a **SOURCE ID(s)** as well as a dialed number or range of dialed numbers to accept.

Example: An application requires that all calls that originate from Port 1 of the ATLAS 550 in Slot 1 be switched to Port 2 of that same module. Assign a unique **SOURCE ID** (e.g., 7) to Port 1 of the module, and then configure Port 2 to only accept calls from that unique **SOURCE ID** (7).

DIAL PLAN (FXO) > NETWORK TERM > IFCE CONFIG > PORT SELECTION**Write security: 3; Read security: 5**

Determines how the ATLAS 550 switchboard uses FXO ports for call routing. The **CIRCULAR** method can be used for call load balancing among the available ports on the module.

NORMAL

Always start with the lowest numbered available port (i.e., for a Quad FXO Module with four configured interfaces, Port 1 would always be used first if available).

CIRCULAR	Contiguous ports from last to first.
ALIGNED	Provides the ability to maintain alignment between ports as if they were in dedicated map mode. This scenario requires PORT SELECTION set to ALIGNED on both interfaces (usually on User Term and on Net Term). An interface that has PORT SELECTION set to ALIGNED will only process a call from the switchboard on the same port that the incoming call was received.

Example: The unit receives an incoming call on Port 3. The switchboard looks for an interface who has matching accept criteria to the number it received. A match is found on interface “Z” that has **PORT SELECTION** set to **ALIGNED**. This causes interface “Z” to only process the call if it has Port 3 available. If all matching interfaces have **PORT SELECTION** set to **ALIGNED** and none of those interfaces have Port 3 available, then a busy or fast busy will be returned to the calling party.

DIAL PLAN (OCTAL E&M MODULE)

DIAL PLAN (E&M) > USER TERM

Write security: 3; Read security: 5

This menu allows the user to define option parameters for ports which emulate an analog E&M connection from the Network (PSTN).

DIAL PLAN (E&M) > USER TERM > IFCE CONFIG

Write security: 3; Read security: 5

Specifies the configuration parameters for the endpoint.

DIAL PLAN (E&M) > USER TERM > IFCE CONFIG > PORTS AVAILABLE

Write security: 3; Read security: 5

Indicates which ports of the Quad/Octal E&M Option Modules have been defined in this switched endpoint (indicated by “!”), in another switched endpoint (indicated by “s”), or in a **DEDICATED MAP** (indicated by “n”). This field is read-only. The following characters may display in this field:

0-9	This port is available.
*	This port is requesting this port for this connection, but the port is not yet activated.
!	This port is used by this endpoint.
S	This port is used elsewhere in the switched DIAL PLAN .
S	This port is in the switched dial plan and conflicts with this endpoint.
N	This port is used in one or more DEDICATED MAPS .
N	This port is in one or more DEDICATED MAPS , and conflicts with this endpoint.
•	This port is the wrong kind of port for this endpoint.

DIAL PLAN (E&M) > USER TERM > IFCE CONFIG > NUMBER OF PORTS

Write security: 3; Read security: 5

Specifies the number of ports ATLAS 550 uses for this endpoint.

DIAL PLAN (E&M) > USER TERM > IFCE CONFIG > SIGNALING METHOD**Write security: 3; Read security: 5**

Defines to the ATLAS 550 the type of signaling to be used across this trunk. The signaling selected needs to match the signaling being provided by the network (PSTN). The following choices are available:

- E&M Wink
- E&M Immediate



The ATLAS 550 converts signaling types between two endpoints (network or user terms).

DIAL PLAN (E&M) > USER TERM > IFCE CONFIG > DIRECT INWARD DIALING**Write security: 3; Read security: 5**

Defines to the ATLAS 550 whether Direct Inward Dialing (**DID**) is being used by the network. If **DID** is **ENABLED**, then the following information must be defined:

DIAL PLAN (E&M) > USER TERM > IFCE CONFIG > DID DIGITS TRANSFERRED**Write security: 3; Read security: 5**

Defines the number of digits sent to ATLAS 550 from the network if **DID** is used. This option only displays if **DID** is set to **ENABLED**.

DIAL PLAN (E&M) > USER TERM > IFCE CONFIG > CALLER ID NUMBER**Write security: 3; Read security: 5**

Defines the number the ATLAS 550 uses to provide caller ID to the network for outgoing calls sent through this endpoint. This item is optional.



The Caller ID number must be specific (i.e., no “wild cards”).

DIAL PLAN (E&M) > USER TERM > IFCE CONFIG > STRIP MSD**Write security: 3; Read security: 5**

Strips a selected quantity (choose from **NONE**, **1**, **2**, and **3**) of the Most Significant Digits (MSD) of a dialed number prior to being forwarded out of the port.

Example: A network port could be set to accept all calls beginning with 9 (9\$), and then with **STRIP MSD** set to **1**, all digits would be sent toward the network except the leading 9.



Strip MSD does not affect Call Accept criteria. All of the digits (including the MSDs that are subsequently stripped) are used as accept criterion.

DIAL PLAN (E&M) > USER TERM > IFCE CONFIG > SOURCE ID**Write security: 3; Read security: 5**

Simplifies the creation of a **DIAL PLAN** in applications where the criterion for switching calls to a certain endpoint is a function of which endpoint originated the call.

DEFAULT VALUE = 0. The default ID for all endpoints is 0 and all accept numbers is 0. With default values, all calls are routed based only on the dialed number.

Multiple endpoints can have the same **SOURCE ID**.

When creating the **CALL ACCEPT** list, specify a **SOURCE ID(s)** as well as a dialed number or range of dialed numbers to accept.

Example: An application requires that all calls that originate from Port 1 of the ATLAS 550 in Slot 1 be switched to Port 2 of that same module. Assign a unique **SOURCE ID** (e.g., 7) to Port 1 of the module, and then configure Port 2 to only accept calls from that unique **SOURCE ID** (7).

DIAL PLAN (E&M) > USER TERM > IFCE CONFIG > PORT SELECTION**Write security: 3; Read security: 5**

Determines how the ATLAS 550 switchboard uses E&M ports for call routing. The **CIRCULAR** method can be used for call load balancing among the available ports on the module.

NORMAL	Always start with the lowest numbered available port (i.e., for a Octal E&M Module with four configured interfaces, Port 1 would always be used first if available).
CIRCULAR	Contiguous ports from last to first.
ALIGNED	Provides the ability to maintain alignment between ports as if they were in dedicated map mode. This scenario requires PORT SELECTION set to ALIGNED on both interfaces (usually on User Term and on Net Term). An interface that has PORT SELECTION set to ALIGNED will only process a call from the switchboard on the same port that the incoming call was received.

Example: The unit receives an incoming call on Port 3. The switchboard looks for an interface who has matching accept criteria to the number it received. A match is found on interface "Z" that has **PORT SELECTION** set to **ALIGNED**. This causes interface "Z" to only process the call if it has Port 3 available. If all matching interfaces have **PORT SELECTION** set to **ALIGNED** and none of those interfaces have Port 3 available, then a busy or fast busy will be returned to the calling party.

DIAL PLAN (E&M) > USER TERM > IFCE CONFIG > DIAL ON OFFHOOK**Write security: 3; Read security: 5**

Defines a number that is automatically sent to the switchboard when a call on this endpoint is initiated (goes off hook).



The Dial on Offhook number must be specific (i.e., no "wild cards").

DIAL PLAN (DUAL Nx56/64 MODULE)

DIAL PLAN (V35Nx) > USER TERM

Write security: 3; Read security: 5

This menu allows the user to define option parameters for ports configured for V.35 connections.

DIAL PLAN (V35Nx) > USER TERM > IFCE CONFIG

Write security: 3; Read security: 5

Specifies the configuration parameters for the endpoint.

DIAL PLAN (V35Nx) > USER TERM > IFCE CONFIG > PORTS AVAILABLE

Write security: 3; Read security: 5

Indicates which ports of the selected Dual Nx 56/64 Option Module have been defined in this switched endpoint (indicated by “!”), in another switched endpoint (indicated by “s”), or in a **DEDICATED MAP** (indicated by “n”). This field is read-only. The following characters may display in this field:

0-4	This port is available.
*	This port is requesting this port for this connection, but the port is not yet activated.
!	This port is used by this endpoint.
S	This port is used elsewhere in the switched DIAL PLAN .
S	This port is in the switched dial plan and conflicts with this endpoint.
N	This port is used in one or more DEDICATED MAPS .
N	This port is in one or more DEDICATED MAPS , and conflicts with this endpoint.

DIAL PLAN (V35Nx) > USER TERM > IFCE CONFIG > NUMBER OF PORTS

Write security: 3; Read security: 5

Specifies the number of V.35 ports ATLAS 550 uses for this endpoint.

DIAL PLAN (V35Nx) > USER TERM > IFCE CONFIG > NUMBER TO DIAL

Write security: 3; Read security: 5

Specifies the number to dial on an outgoing call.

DIAL PLAN (V35Nx) > USER TERM > IFCE CONFIG > CALL TYPE

Write security: 3; Read security: 5

Configures the call type (either **56K** or **64K**) used for outgoing calls from this endpoint.

DIAL PLAN (V35Nx) > USER TERM > IFCE CONFIG > DIAL CALL AS

Write security: 3; Read security: 5

Allows the outgoing call to be treated as the selected call type. Options include **DIGITAL** (for 56K or 64K

data calls), **VOICE** (for speech calls), and **AUDIO** (for 3.1kHz audio calls).

DIAL PLAN (V35Nx) > USER TERM > IFCE CONFIG > SOURCE ID

Write security: 3; Read security: 5

Simplifies the creation of a dial plan in applications where the criterion for switching calls to a certain endpoint is a function of which endpoint originated the call.

DEFAULT VALUE = 0. Zero is the default ID for all endpoint and all accept numbers. With default values, all calls are routed based only on the dialed number.

Multiple endpoints can have the same **SOURCE ID**.

When creating the **CALL ACCEPT** list, specify a **SOURCE ID(s)** as well as a dialed number or range of dialed numbers to accept.

Example: An application requires that all calls that originate from Port 1 of the ATLAS 550 in Slot 1 be switched to Port 2 of that same module. Assign a unique **SOURCE ID** (e.g., 7) to Port 1 of the module, and then configure Port 2 to only accept calls from that unique **SOURCE ID** (7).

DIAL PLAN (V35Nx) > USER TERM > IFCE CONFIG > MIN DS0's

Set this to 1 for typical single-call connections. Setting this greater than 1 will restrict connections to endpoints supporting aggregation (e.g., BONDING) of the specified number of DS0s.

DIAL PLAN (V35Nx) > USER TERM > IFCE CONFIG > MAX DS0's

Set this to 1 for typical single-call connections. Setting this greater than 1 will accommodate connections to endpoints supporting aggregation (e.g., BONDING) of up to the specified number of DS0s. This also sets the number of DS0s presented in the negotiation of outgoing aggregate calls.

DIAL PLAN (DUAL USSI MODULE)

DIAL PLAN (USSI) > USER TERM

Write security: 3; Read security: 5

This menu allows the user to define option parameters for ports configured for USSI interface connections.

DIAL PLAN (USSI) > USER TERM > IFCE CONFIG

Write security: 3; Read security: 5

Specifies the configuration parameters for the endpoint.

DIAL PLAN (USSI) > USER TERM > IFCE CONFIG > PORTS AVAILABLE**Write security: 3; Read security: 5**

Indicates which ports of the selected Dual USSI Option Module have been defined in this switched endpoint (indicated by “!”), in another switched endpoint (indicated by “s”), or in a **DEDICATED MAP** (indicated by “n”). This field is read-only. The following characters may display in this field:

0-4	This port is available.
*	This port is requesting this port for this connection, but the port is not yet activated.
!	This port is used by this endpoint.
s	This port is used elsewhere in the switched dial plan.
S	This port is in the switched dial plan and conflicts with this endpoint.
n	This port is used in one or more dedicated maps.
N	This port is in one or more dedicated maps, and conflicts with this endpoint.

DIAL PLAN (USSI) > USER TERM > IFCE CONFIG > NUMBER OF PORTS**Write security: 3; Read security: 5**

Specifies the number of USSI interface ports ATLAS 550 uses for this endpoint.

DIAL PLAN (USSI) > USER TERM > IFCE CONFIG > NUMBER TO DIAL**Write security: 3; Read security: 5**

Specifies the number to dial on an outgoing call.

DIAL PLAN (USSI) > USER TERM > IFCE CONFIG > CALL TYPE**Write security: 3; Read security: 5**

Configures the call type (either **56K** or **64K**) used for outgoing calls from this endpoint.

DIAL PLAN (USSI) > USER TERM > IFCE CONFIG > DIAL CALL AS**Write security: 3; Read security: 5**

Allows the outgoing call to be treated as the selected call type. Options include **DIGITAL** (for 56K or 64K data calls), **VOICE** (for speech calls), and **AUDIO** (for 3.1kHz audio calls).

DIAL PLAN (USSI) > USER TERM > IFCE CONFIG > SOURCE ID**Write security: 3; Read security: 5**

Simplifies the creation of a dial plan in applications where the criterion for switching calls to a certain endpoint is a function of which endpoint originated the call.

DEFAULT VALUE = 0. Zero is the default ID for all endpoints and all accept numbers. With default values, all calls are routed based only on the dialed number.

Multiple endpoints can have the same **SOURCE ID**.

When creating the **CALL ACCEPT** list, specify a **SOURCE ID(s)** as well as a dialed number or range of dialed numbers to accept.

Example: An application requires that all calls that originate from Port 1 of the ATLAS 550 in Slot 1 be switched to Port 2 of that same module. Assign a unique **SOURCE ID** (e.g., 7) to Port 1 of the module, and then configure Port 2 to only accept calls from that unique **SOURCE ID** (7).

DIAL PLAN (USSI) > USER TERM > IFCE CONFIG > MIN DS0'S

Write security: 3; Read security: 5

Set this to 1 for typical single-call connections. Setting this greater than 1 will restrict connections to endpoints supporting aggregation (e.g., BONDING) of the specified number of DS0s.

DIAL PLAN (USSI) > USER TERM > IFCE CONFIG > MAX DS0'S

Write security: 3; Read security: 5

Set this to 1 for typical single-call connections. Setting this greater than 1 will accommodate connections to endpoints supporting aggregation (e.g., BONDING) of up to the specified number of DS0s. This also sets the number of DS0s presented in the negotiation of outgoing aggregate calls.

DIAL PLAN (QUAD BRI S/T MODULE)

DIAL PLAN (S/T BRI) > USER TERMINATION

Write security: 2; Read security: 5

The Quad BRI S/T Module acts like the network while interfacing to user equipment (terminal adapters). When you are working in the network termination section of the **DIAL PLAN** menu and **SLT** is defined as a S/T BRI module, the following interface configuration options are available:



Using the Quad BRI S/T Module on a User Term endpoint requires the use of a straight-through ISDN S/T cable.

DIAL PLAN (S/T BRI) > USER TERMINATION > IFCE CONFIG > SWITCH TYPE

Write security: 2; Read security: 5

Defines the type of ISDN switch that the port will simulate. If connected to another ATLAS, both need to be set to the same type. The following options are available:

- Lucent 5E
- National ISDN
- Northern DMS 100
- Euro ISDN

DIAL PLAN (S/T BRI) > USER TERMINATION > IFCE CONFIG > SPID LIST

Write security: 2; Read security: 5

The port, acting as the network, must use a SPID and a phone number in order to satisfy the ISDN connection protocol expected by the user's Terminal Adapter (TA).

PHONE NUMBER

Write security: 3; Read security: 5

The phone number(s) assigned to this BRI phone line.

SPID NUMBER**Write security: 3; Read security: 5**

Defines the SPID number(s) used for this BRI line. Although the value of the SPID is not significant, a SPID must be entered for each phone number. For convenience, the SPID can be set to be the same as the phone number. The Quad BRI S/T Module does not support autoSPID detection software which some terminal adapters offer.



No SPID Number is needed for the Euro-ISDN Switch Type.

CALLS**Write security: 3; Read security: 5**

For User terminations, the number of calls is fixed at 2.

D64, D56, AUDIO, SPEECH**Write security: 3; Read security: 5**

These options reflect the network provisions for this SPID. If the BRI was purchased with different services provisioned for the SPIDs, then the call must match the services supported.

DIAL PLAN (PKT ENDPT - PACKET ENDPOINTS)**DIAL PLAN (PKT ENDPT) > USER TERM****Write security: 3; Read security: 5**

This menu allows the user to define option parameters for ports configured as packet endpoints.

DIAL PLAN (PKT ENDPT) > USER TERM > IFCE CONFIG**Write security: 3; Read security: 5**

Specifies the configuration parameters for the endpoint.

DIAL PLAN (PKT ENDPT) > USER TERM > IFCE CONFIG > OUTDIAL NUMBER**Write security: 3; Read security: 5**

Defines the number dialed to originate a call.

DIAL PLAN (PKT ENDPT) > USER TERM > IFCE CONFIG > OUTGOING CALL TYPE**Write security: 3; Read security: 5**

Selects the terminating resource type, either **DIGITAL 64K** or **DIGITAL 56K**.

DIAL PLAN (PKT ENDPT) > USER TERM > IFCE CONFIG > REDIAL TIMER**Write security: 3; Read security: 5**

Selects the time delay in seconds between redial attempts.

DIAL PLAN (PKT ENDPT) > USER TERM > IFCE CONFIG > RANDOMIZE TIMER**Write security: 3; Read security: 5**

Enables/disables random delay added to the redial timer to avoid glare.

DIAL PLAN (PKT ENDPT) > USER TERM > IFCE CONFIG > RETRY COUNT**Write security: 3; Read security: 5**

Defines the number of redials to attempt.

DIAL PLAN (PKT ENDPT) > USER TERM > IFCE CONFIG > OUTGOING CALLER ID**Write security: 3; Read security: 5**

Defines the presentation of the calling party number for this endpoint.

DIAL PLAN (PKT ENDPT) > USER TERM > IFCE CONFIG > SOURCE ID**Write security: 3; Read security: 5**Simplifies the creation of a **DIAL PLAN** in applications where the criterion for switching calls to a certain endpoint is a function of which endpoint originated the call.

DEFAULT VALUE = 0. Zero is the default value for all endpoints and all accept numbers. With default values, all calls are routed based only on the dialed number.

Multiple endpoints can have the same **SOURCE ID**.

When creating the **CALL ACCEPT** list, specify a **SOURCE ID(s)** as well as a dialed number or range of dialed numbers to accept.

Example: An application requires that all calls that originate from Port 1 of the ATLAS 550 in Slot 1 be switched to Port 2 of that same module. Assign a unique **SOURCE ID** (e.g., 7) to Port 1 of the module, and then configure Port 2 to only accept calls from that unique **SOURCE ID** (7).

DIAL PLAN (PKT ENDPT) > USER TERM > IFCE CONFIG > ROUTE INCOMING CALL**Write security: 3; Read security: 5**

Used to define the method which incoming calls are associated to the packet endpoints. This item has three options:

USING INCOMING NUM	Endpoint selection based on the incoming number.
USING CALLING PARTY NUM	Selection based on the Caller ID as presented by the calling party. If this option is selected, the CALL PARTY NUMBER field is made available to the interface configuration. This number allows you to configure the calling part number used to select this packet endpoint.
USING DBU HANDSHAKE	Selection based on a proprietary protocol. This option is only available to packet endpoints with backup sublinks. DBU HANDSHAKE is required to interoperate with ADTRAN IQ and Express family products. It enables the association of incoming calls with packet endpoints in cases where there is a single call-in number (hunt group) and no Caller ID information available.



DBU HANDSHAKE *must be disabled for DBU between two ATLAS products.*

DIAL PLAN (PKT ENDPT) > USER TERM > IFCE CONFIG > SUPPORT DBU HANDSHAKE

Write security: 3; Read security: 5



DBU HANDSHAKE *must be disabled for DBU between two ATLAS products.*

This option is only available when the packet endpoint selected in the **PORT/PEP** field has backup sublinks. **SUPPORT DBU HANDSHAKE** enables/disables the generation and acceptance of ADTRAN frame relay handshake upon connection. If the endpoint is configured to route incoming calls based on the handshake information, this option is automatically enabled. If another call routing method is in effect, however, this option can be enabled to support the use of handshake information at the far end of the link.

DIAL PLAN (PKT ENDPT) > USER TERM > IFCE CONFIG > SUPPORT DBU HANDSHAKE

Write security: 3; Read security: 5

Controls contents of the ADTRAN frame-relay handshake upon connection of a backup PVC. Normally this field should be set to **AUTO**. The **FORCED** mode is present for compatibility with older IQ units.

DIAL PLAN (PKT ENDPT) > USER TERM > IFCE CONFIG > CALL PARTY NUMBER

Write security: 3; Read security: 5

*(Visible only if **GROUP** is selected in the **PORT/PEP** field.)* Enter the expected calling part number in this field. The ATLAS 550 will use the number entered here to compare to the number presented by the incoming call when configured to route based on Call Party Number.

DIAL PLAN (PKT ENDPT) > USER TERM > IFCE CONFIG > MIN DS0's

Write security: 3; Read security: 5

Set this to 1 for typical single-call connections. A value greater than 1 will restrict connections to endpoints supporting aggregation (e.g., BONDING) of the specified number of DS0s.

DIAL PLAN (PKT ENDPT) > USER TERM > IFCE CONFIG > MAX DS0's

Write security: 3; Read security: 5

Set this to 1 for typical single-call connections. A value greater than 1 will accommodate connections to endpoints supporting aggregation (e.g., BONDING) of up to the specified number of DS0s. This also sets the number of DS0s presented in the negotiation of outgoing aggregate calls.

DIAL PLAN (PKT ENDPT) > USER TERM > IFCE CONFIG > CALL ROUTING TABLE

Write security: 3; Read security: 5

This table is only visible if **GROUP** is selected in the **PRT/PEP** field. The table format changes, based on the

selected routing option. For each case, **CALL PARAMS** contain **OUTDIAL#**, **CALLER ID**, **SOURCE ID**, and **MIN/MAX DS0s**, as described above.

DIAL PLAN (CKT BACKUP - CIRCUIT BACKUP ENDPOINTS)

DIAL PLAN (CKT BACKUP) > USER TERM

Write security: 3; Read security: 5

This menu allows the user to define option parameters for ports configured as backup endpoints.

DIAL PLAN (CKT BACKUP) > USER TERM > IFCE CONFIG

Write security: 3; Read security: 5

Specifies the configuration parameters for the endpoint.

DIAL PLAN (CKT BACKUP) > USER TERM > IFCE CONFIG > ORIGINATE/ANSWER

Write security: 3; Read security: 5

The following selections are available for the **ORIGINATE/ANSWER** menu item:

ORIGINATE	The endpoint will originate the backup call.
ANSWER	The endpoint will answer any incoming calls, but will only go into backup if an error is detected.
ANSWER ANY	The endpoint will answer any incoming calls and go immediately into backup.

DIAL PLAN (CKT BACKUP) > USER TERM > IFCE CONFIG > OUTGOING CALL TYPE

Write security: 3; Read security: 5

This only applies to originating endpoints.

DIAL PLAN (CKT BACKUP) > USER TERM > IFCE CONFIG > SOURCE ID

Write security: 3; Read security: 5

Simplifies the creation of a dial plan in applications where the criterion for switching calls to a certain endpoint is a function of which endpoint originated the call.

DEFAULT VALUE = 0. Zero is the default ID for all endpoints and accept numbers. With default values, all calls are routed based only on the dialed number.

Multiple endpoints can have the same **SOURCE ID**.

When creating the **CALL ACCEPT** list, specify a **SOURCE ID(s)** as well as a dialed number or range of dialed numbers to accept.

DIAL PLAN (CKT BACKUP) > USER TERM > IFCE CONFIG > OUTDIAL NUMBER

Write security: 3; Read security: 5

This only applies to originating endpoints. This is the number dialed when the endpoint goes into backup.

DIAL PLAN (CKT BACKUP) > USER TERM > IFCE CONFIG > FORCE MODE**Write security: 3; Read security: 5**

This forces the backup state of this endpoint. This is a configuration setting, so it will retain its value until it is changed. To temporarily force an endpoint into backup, or to force a restore, try the Manual activator.

DIAL PLAN (CKT BACKUP) > USER TERM > IFCE CONFIG > BACKUP CRITERIA**Write security: 3; Read security: 5**

Criteria for automatic backup. Note that this setting affects the available options for **RESTORE CRITERIA**.

NET/DATA FAIL DBU is initiated when either the network fails (possible causes include Red, Yellow, Blue, or LOS alarms) or when the Nx56/64 module detects a loss of data transitions on the V.35 interface. If Net/Data Fail is selected, the V.35 Nx INBAND option must be ON. The remote TSU INBAND option must also be enabled.



*When **BACKUP CRITERIA** is configured for **NET/DATA FAIL**, the **RESTORE CRITERIA** must be **MANUAL ONLY**.*

NET FAIL DBU is initiated when there is a network failure. Possible causes include LOS, RED, Yellow, or Blue alarms.

MANUAL The ATLAS will never initiate DBU until it is manually set to do so.

DIAL PLAN (CKT BACKUP) > USER TERM > IFCE CONFIG > RESTORE CRITERIA**Write security: 3; Read security: 5**

This only applies to originating endpoints. These are criteria for automatically coming out of backup. Note that **NETWORK SUCCESS** is only available when a backup criterion is not **NET/DATA FAIL**.

NET SUCCESS When network is out of alarm

MANUAL ONLY Only by the Manual activator

DIAL PLAN (CKT BACKUP) > USER TERM > IFCE CONFIG > STARTUP DELAY**Write security: 3; Read security: 5**

The amount of time to wait after creating or changing the endpoint before allowing backup.

DIAL PLAN (CKT BACKUP) > USER TERM > IFCE CONFIG > BACKUP DELAY**Write security: 3; Read security: 5**

The amount of time to delay after detecting an alarm before going into backup. This only applies to originating endpoints. If the circuit comes out of alarm before this time has expired, the endpoint will not go into backup.

DIAL PLAN (CKT BACKUP) > USER TERM > IFCE CONFIG > RESTORE DELAY**Write security: 3; Read security: 5**

The amount of time to delay after clearing an alarm before coming out of backup. This only applies to originating endpoints. If the circuit goes into alarm before this time has expired, the endpoint will remain in backup.

DIAL PLAN (CKT BACKUP) > USER TERM > IFCE CONFIG > MAX NUM REDIALS**Write security: 3; Read security: 5**

The backup endpoint will attempt this many retries before giving up and declaring a backup failure. This only applies to originating endpoints.

DIAL PLAN (CKT BACKUP) > USER TERM > IFCE CONFIG > REDIAL TIMER**Write security: 3; Read security: 5**

The amount of time delayed between a failed backup call and the redial. This only applies to originating endpoints.

DIAL PLAN (CKT BACKUP) > USER TERM > IFCE CONFIG > ENABLE SCHEDULE**Write security: 3; Read security: 5**

Use this menu to schedule the times when backup is enabled. The following selections are available for the **ENABLE SCHEDULE** menu item.

ENABLE TIME**Write security: 3; Read security: 5**

This is the time of day to enable dial backup.

DISABLE TIME**Write security: 3; Read security: 5**

This is the time of day to disable dial backup. If the disable time is earlier than the enable time, backup monitoring will be active across midnight.

DAYS ENABLED**Write security: 3; Read security: 5**

Use this record to enable/disable backup monitoring on particular days of the week.

DIAL PLAN (CKT BACKUP) > USER TERM > IFCE CONFIG > TEST CALL**Write security: 3; Read security: 5**

This only applies to originating endpoints. Use this menu to schedule regularly occurring test calls. The following selections are available for the **TEST CALL** menu item.

PERIOD**Write security: 3; Read security: 5**

How often test calls are to be made

NEXT TEST TIME**Write security: 3; Read security: 5**

The date of the next scheduled test call

DIAL PLAN (CKT BACKUP) > USER TERM > IFCE CONFIG > MIN NUM DS0s**Write security: 3; Read security: 5**

This option will specify the number of DS0s to use for this switched call. If this number is **1**, all calls will be directed to the endpoint, and not use a BONDING resource. Any number other than **1** will use BONDING resources to inverse multiplex the multiple switched channels together.

DIAL PLAN (CKT BACKUP) > USER TERM > IFCE CONFIG > MAX NUM DS0s**Write security: 3; Read security: 5**

This option will specify the number of DS0s to use for this switched call. If this number is **1**, all calls will be directed to the endpoint, and not use a BONDING resource. Any number other than **1** will use BONDING resources to inverse multiplex the multiple switched channels together.

DIAL PLAN (PKT VOICE - PACKET VOICE ENDPOINT)

DIAL PLAN (PKT VOICE) > NETWORK TERM**Write security: 3; Read security: 5**

This menu allows the user to define option parameters for ports configured as network packet voice endpoints.

DIAL PLAN (PKT VOICE) > NETWORK TERM > IFCE CONFIG**Write security: 3; Read security: 5**

Specifies the configuration parameters for the endpoint.

DIAL PLAN (PKT VOICE) > NETWORK TERM > IFCE CONFIG > DLCI**Write security: 3; Read security: 5**

Selects the appropriate DLCI for this dial plan entry.

DIAL PLAN (PKT VOICE) > NETWORK TERM > IFCE CONFIG > VOICE PORT**Write security: 3; Read security: 5**

Identifies the voice port address of the remote unit. FSU 5622s support ports 1 and 2. A remote ATLAS supports ports 1 through 255.

DIAL PLAN (PKT VOICE) > NETWORK TERM > IFCE CONFIG > CONFLICT REPORT**Write security: 3; Read security: 5**

Describes existing conflicts. Potential problems include DLCI unavailable or Voice port already in use.

DIAL PLAN (PKT VOICE) > NETWORK TERM > IFCE CONFIG > VOICE COMPRESSION**Write security: 3; Read security: 5**

Configures the compression algorithm used on the selected packet voice endpoint. The default compression algorithm in the FSU and Express 52XX series is G.723.1. Valid codecs for the VCOM Module include **G.723.1** and **NETCODER**. Valid codecs for the ADPCM-32 Module include **G.711**, **G.726**, and **TRANSPARENT**. The ADPCM-32 Module will only operate with another ATLAS containing an ADPCM-32 Module. Both endpoints must agree on the selected compression algorithm.



The ADPCM-32 Resource Module will not interoperate with the FSU and Express series products.

DIAL PLAN (PKT VOICE) > NETWORK TERM > IFCE CONFIG > SILENCE SUPPRESSION**Write security: 3; Read security: 5**

Reduces the total system bandwidth load by preventing ATLAS from sending frames containing a special silence code during periods of silence. Both endpoints must agree to use silence suppression. By default, silence suppression is Disabled. To prohibit silence frames from transmitting and to decrease the total system bandwidth, **ENABLE** this feature.

DIAL PLAN (PKT VOICE) > NETWORK TERM > IFCE CONFIG > SIGNALING METHOD**Write security: 3; Read security: 5**

Selects the type of signaling that the remote port is configured to expect. Available options include **E&M IMMEDIATE**, **E&M WINK**, and **LOOP START**.

DIAL PLAN (PKT VOICE) > NETWORK TERM > IFCE CONFIG > DIRECT INWARD DIALING**Write security: 3; Read security: 5**

Defines whether Direct Inward Dialing (**DID**) is used by the remote equipment. If **DID** is enabled, then the following options must be configured:

DIAL PLAN (PKT VOICE) > NETWORK TERM > IFCE CONFIG > DID DIGITS TRANSFERRED**Write security: 3; Read security: 5**

Defines the number of digits sent to ATLAS from the network if **DIRECT INWARD DIALING** is **ENABLED**.

DIAL PLAN (PKT VOICE) > NETWORK TERM > IFCE CONFIG > DID PREFIX**Write security: 3; Read security: 5**

Defines to ATLAS the prefix digits which are not received as a part of the DID number. ATLAS uses the combination of prefix and DID number to determine the user endpoint that should receive the incoming call.

DIAL PLAN (PKT VOICE) > NETWORK TERM > IFCE CONFIG > TRUNK NUMBER**Write security: 3; Read security: 5**

Determines which user endpoint should receive the incoming call when the network connection does not

provide DID digits. This field only displays if **DIRECT INWARD DIALING** is set to **DISABLED**.

DIAL PLAN (PKT VOICE) > NETWORK TERM > IFCE CONFIG > STRIP MSD

Write security: 3; Read security: 5

Strips a selected quantity (choose from **NONE**, **1**, **2**, and **3**) of the most significant digits (MSD) of a dialed number prior to being forwarded out of the port.

Example: A network port could be set to accept all calls beginning with 9 (9\$), and then with **STRIP MSD** set to **1**, all digits would be sent toward the network except the leading 9.



STRIP MSD does not affect **CALL ACCEPT** criteria. All of the digits (including the MSDs that are subsequently stripped) are used as accept criterion.

DIAL PLAN (PKT VOICE) > NETWORK TERM > IFCE CONFIG > SOURCE ID

Write security: 3; Read security: 5

Simplifies the creation of a dial plan in applications where the criterion for switching calls to a certain endpoint is a function of which endpoint originated the call.

DEFAULT VALUE = 0. Zero is the default ID for all endpoints and accept numbers. With default values, all calls are routed based only on the dialed number.

Multiple endpoints can have the same **SOURCE ID**.

When creating the **CALL ACCEPT** list, specify a **SOURCE ID(s)** as well as a dialed number or range of dialed numbers to accept.

DIAL PLAN (PKT VOICE) > USER TERM

Write security: 3; Read security: 5

This menu allows the user to define option parameters for ports configured as user packet voice endpoints.

DIAL PLAN (PKT VOICE) > USER TERM > IFCE CONFIG

Write security: 3; Read security: 5

Specifies the configuration parameters for the endpoint.

DIAL PLAN (PKT VOICE) > USER TERM > IFCE CONFIG > DLCI

Write security: 3; Read security: 5

Selects the appropriate DLCI for this dial plan entry.

DIAL PLAN (PKT VOICE) > USER TERM > IFCE CONFIG > VOICE PORT

Write security: 3; Read security: 5

Identifies the voice port address of the remote unit. FSU 5622s support ports 1 and 2. A remote ATLAS supports ports 1 through 255.

DIAL PLAN (PKT VOICE) > USER TERM > IFCE CONFIG > CONFLICT REPORT**Write security: 3; Read security: 5**

Describes existing conflicts. Potential problems include DLCI unavailable or Voice port already in use.

DIAL PLAN (PKT VOICE) > USER TERM > IFCE CONFIG > VOICE COMPRESSION**Write security: 3; Read security: 5**

Configures the compression algorithm used on the selected packet voice endpoint. The default compression algorithm in the FSU and Express 52XX series is G.723.1. Valid codecs for the VCOM Module include **G.723.1** and **NETCODER**. Valid codecs for the ADPCM-32 Module include **G.711**, **G.726**, and **TRANSPARENT**. The ADPCM-32 Module will only operate with another ATLAS containing an ADPCM-32 Module. Both endpoints must agree on the selected compression algorithm.



The ADPCM-32 Resource Module will not interoperate with the FSU and Express series products.

DIAL PLAN (PKT VOICE) > USER TERM > IFCE CONFIG > SILENCE SUPPRESSION**Write security: 3; Read security: 5**

Reduces the total system bandwidth load by preventing ATLAS from sending frames containing a special silence code during periods of silence. Both endpoints must agree to use silence suppression. By default, silence suppression is **DISABLED**. To prohibit silence frames from transmitting and to decrease the total system bandwidth, **ENABLE** this feature.

DIAL PLAN (PKT VOICE) > USER TERM > IFCE CONFIG > SIGNALING METHOD**Write security: 3; Read security: 5**

Selects the type of signaling that the remote port is configured to expect. Available options include the following: **E&M IMMEDIATE**, **E&M WINK**, and **LOOP START**.

DIAL PLAN (PKT VOICE) > USER TERM > IFCE CONFIG > DIRECT INWARD DIALING**Write security: 3; Read security: 5**

Defines whether or not Direct Inward Dialing (**DID**) is used by the remote equipment. If **DID** is enabled, then the following options must be configured:

DIAL PLAN (PKT VOICE) > USER TERM > IFCE CONFIG > DID DIGITS TRANSFERRED**Write security: 3; Read security: 5**

Defines the number of digits ATLAS 550 send to the user equipment. This field only displays if **DIRECT INWARD DIALING** is **ENABLED**.

DIAL PLAN (PKT VOICE) > USER TERM > IFCE CONFIG > CALLER ID NUMBER**Write security: 3; Read security: 5**

Defines the number ATLAS uses to provide Caller ID to the network for outgoing calls sent through this endpoint. This field only displays if **DIRECT INWARD DIALING** is set to **DISABLED**, and **USER TERM** is selected. Setting this menu item is optional.

DIAL PLAN (PKT VOICE) > USER TERM > IFCE CONFIG > STRIP MSD**Write security: 3; Read security: 5**

Strips a selected quantity (choose from **NONE**, **1**, **2**, and **3**) of the most significant digits (MSD) of a dialed number prior to being forwarded out of the port.

Example: A network port could be set to accept all calls beginning with 9 (9\$), and then with **STRIP MSD** set to **1**, all digits would be sent toward the network except the leading 9.



STRIP MSD does not affect **CALL ACCEPT** criteria. All of the digits (including the MSDs that are subsequently stripped) are used as accept criterion.

DIAL PLAN (PKT VOICE) > USER TERM > IFCE CONFIG > SOURCE ID**Write security: 3; Read security: 5**

Simplifies the creation of a dial plan in applications where the criterion for switching calls to a certain endpoint is a function of which endpoint originated the call.

DEFAULT VALUE = 0. The default ID for all endpoints is 0 and all accept numbers is 0. With default values, all calls are routed based only on the dialed number.

Multiple endpoints can have the same **SOURCE ID**.

When creating the **CALL ACCEPT** list, specify a **SOURCE ID(s)** as well as a dialed number or range of dialed numbers to accept.

DETAIL LEVEL PROCEDURES

DLP-001	Connecting the Terminal or PC to the CONTROL/CRAFT Port	317
DLP-002	Logging in to the System	319
DLP-003	Setting IP Parameters for the ATLAS 550	323
DLP-004	Verifying Communications Over an IP LAN	325
DLP-005	Adding/Removing Users and Changing Password Security Levels	329
DLP-006	Updating the Firmware Using TFTP	331
DLP-007	Updating the Firmware Using XMODEM	335
DLP-008	Saving the Current Configuration Using TFTP	339
DLP-009	Loading a Configuration Using TFTP	341
DLP-010	Saving the Current Configuration Using XMODEM	343
DLP-011	Loading a Configuration Using XMODEM	345
DLP-012	Connecting the ATLAS 550 to an External Modem	347
DLP-013	Using the ADTRAN Utility Syslog with the ATLAS 550	351
DLP-014	Connecting the Alarm Contacts	355
DLP-015	Using the Alarm Connections and ACO Button	359

CONNECTING THE TERMINAL OR PC TO THE CONTROL/CRAFT PORT

Introduction

ATLAS 550 management and provisioning are facilitated by a series of intuitive menus that are accessible on a computer screen. Connecting either a VT100 terminal or a PC with terminal emulation software to the **CONTROL IN** port on the rear of the unit or the **CRAFT** interface on the unit faceplate allows access to the menus and management features of ATLAS 550. This section specifies how to connect the VT100 terminal or PC to the ATLAS 550.

The front **CRAFT** interface for the ATLAS 550 is located on the faceplate of the unit and is an RJ-45 connector. Access can also be made to the ATLAS 550 from the back of the unit through the port labeled **CONTROL IN**. It is also an RJ-45 connector, and is located on the lower right corner of the back of the unit.

Prerequisite Procedures

The ATLAS 550 must be powered for terminal communication to function.

Tools and Materials Required

- VT100 compatible terminal or computer with terminal emulation software
- Appropriate cable to connect terminal to the ATLAS 550 (shipped with unit)

WARNING

To prevent electrical shock, do not install equipment in a wet location or during a lightning storm.



Electronic modules can be damaged by static electrical discharge. Before handling modules, wear an antistatic discharge wrist strap to prevent damage to electronic components. Place modules in antistatic packing material when transporting or storing. When working on modules, always place them on an approved antistatic mat that is electrically grounded.

DLP-001

Perform Steps Below in the Order Listed

1. Connect a VT100 terminal to ATLAS 550.

- Set the parameters of the VT100 terminal to:
 - 9600 baud rate
 - 8 data bits
 - No parity
 - 1 stop bit
 - No flow control
- If the terminal has a parallel setting, disable it and use serial port.
- Plug the RJ-45 male end of the data cable into the ATLAS 550. Make the connection to the VT100 terminal as appropriate for your equipment.

2. Connect a PC emulating a VT100 terminal to ATLAS 550.

Most personal computers or laptops can run communications software that will emulate a VT100 terminal. Windows programs such as Terminal[®] or Hyperterminal[®] are two such examples in the Windows format. However, there are many other adequate, commercially available software packages which will allow your PC or laptop to emulate a VT100 terminal. Certain configuration items must be set on a PC or laptop for it to act as a VT100 terminal for the ATLAS 550.

- Set the parameters of the communications software to:
 - 9600 baud rate
 - 8 data bits
 - No parity
 - 1 stop bit
 - No flow control
- Set the PC for direct connect on the appropriate com port (instead of dial up connection).
- Plug the RJ-45 male end of the data cable into the ATLAS 550. Make connection to the PC or laptop as appropriate for your equipment.

You are now ready to log in to ATLAS 550, as described in DLP-002, *Logging in to the System*.

Follow-up Procedures

Once this procedure is complete, return to the procedure which referred you to this DLP and continue with the tasks indicated there.

LOGGING IN TO THE SYSTEM

Introduction

Once connected to the ATLAS 550 via either a VT100 terminal or PC configured as a VT100 terminal, it is necessary to log in to the system to gain access to the management and provisioning functions. This DLP provides specific steps for logging into the system and accessing the various management and provisioning functions.

Prerequisite Procedures

Complete DLP-001, *Connecting the Terminal or PC to the CONTROL/CRAFT Port* before logging in to ATLAS 550.

Tools and Materials Required

- Data cable to connect to a VT100 terminal or a PC configured as a VT100 terminal (shipped with unit)
- VT100 terminal or PC configured as a VT100 terminal

WARNING

To prevent electrical shock, do not install equipment in a wet location or during a lightning storm.



CAUTION

Electronic modules can be damaged by static electrical discharge. Before handling modules, wear an antistatic discharge wrist strap to prevent damage to electronic components. Place modules in antistatic packing material when transporting or storing. When working on modules, always place them on an approved antistatic mat that is electrically grounded.

DLP-002

Perform Steps Below in the Order Listed

1. After connecting to the system, a blank screen will appear.
Pressing any key will display the login screen shown below.

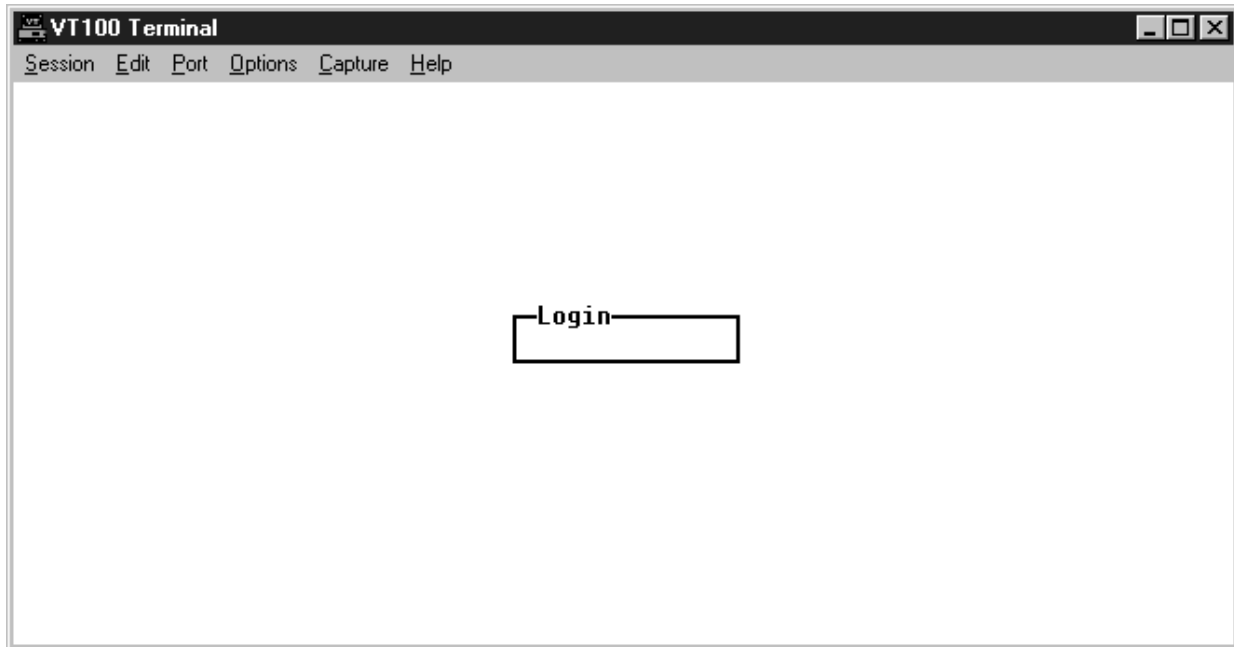

The cursor will blink at the **LOGIN** field, waiting for a password to be entered.

2. At the **LOGIN** field, enter the password for the ATLAS 550.

The manufacturer's default password for the ATLAS 550 system is "**password**" in lowercase letters.

The ATLAS 550 has six levels of access granted to a user. The lowest level of access (Level 5) is read-only, and allows a user to see, but not change, the current configuration of the system. The top level of access (Level 0) is read-write and allows the user to both see and change system configuration parameters.

After initial login, the System Administrator is able to define levels of access for various users. (See DLP-005, *Adding/Removing Users and Changing Password Security Levels* for more details.)

3. Upon entering the correct password, the ATLAS 550 **MAIN MENU** is displayed as shown below.

```

Telnet Connection - 10.2.15.56
Session Edit Options Capture Help
ATLAS 550/System Info
System Info      System Name      ATLAS 550
System Status    System Location  Adtran ATLAS 550
System Config    System Contact   Adtran ATLAS 550
System Utility   Firmware Revision ATLAS 550 Rev. B0018 08/31/00 09:56:14
Modules          System Uptime    5 days 19 hours 52 min 11 secs
Packet Manager   Startup Mode     Power cycle
Router           Current Time/Date (24h) Wednesday September 6 11:19:12 2000
Dedicated Maps   Installed Memory Flash:2097152 bytes DRAM:16777216 bytes
Circuit Status   Serial Number    A17B2616
Dial Plan        Boot ROM Rev     A.01 01/13/00

SYS: OK  NETWK1:ONLN  NETWK2: --  1:ALARM  2:ALARM  3: --  4: --
System Information menu  ^Z=help 11:19

```

4. You are now logged in to the ATLAS menu system.



You may also connect to the unit via Telnet if the IP parameters have been provisioned (as discussed in DLP-003).

Follow-up Procedures

Once this procedure is complete, return to the procedure which referred you to this DLP and continue with the tasks indicated there.

SETTING IP PARAMETERS FOR THE ATLAS 550

Introduction

If the ATLAS 550 is connected to an IP network for Telnet, TFTP, or SNMP management, several IP parameters must be set for the unit to communicate with the network. These parameters are described in this DLP along with the procedures for setting them.



*Please see your Network Administrator for the proper assignment of the following parameters: **IP ADDRESS**, **SUBNET MASK**, and **DEFAULT GATEWAY**.*

Prerequisite Procedures

This procedure assumes that the ATLAS 550 unit is connected to an IP network and is powered up.

Tools and Materials Required

- Data cable to connect to either a VT100 terminal or a PC configured as a VT100 terminal
- VT100 terminal or PC configured as a VT100 terminal



To prevent electrical shock, do not install equipment in a wet location or during a lightning storm.



Electronic modules can be damaged by static electrical discharge. Before handling modules, wear an antistatic discharge wrist strap to prevent damage to electronic components. Place modules in antistatic packing material when transporting or storing. When working on modules, always place them on an approved antistatic mat that is electrically grounded.

DLP-003

Perform Steps Below in the Order Listed

1. Connect the ATLAS 550 unit to your VT100 system (details found in DLP-001).
2. Login to the system with maximum rights (details for logging in are in DLP-002).
3. From the **SYSTEM CONFIG** menu, select the **ETHERNET PORT** option and press <Enter>.



The next three steps will require confirmation after each change.

4. From the **SYSTEM CONFIG/ETHERNET** menu, select the **IP ADDRESS** option and press <Enter>.
Enter the appropriate IP address.
5. From the **SYSTEM CONFIG/ETHERNET** menu, select the **SUBNET MASK** option and press <Enter>.
Enter the appropriate Subnet Mask.
6. From the **SYSTEM CONFIG/ETHERNET** menu, select the **DEFAULT GATEWAY** option and press <Enter>.
Enter the appropriate Default Gateway.
7. Left arrow to highlight the **ETHERNET** submenu to save changes.
8. Escape out to the **SYSTEM CONFIG** menu and logoff by pressing <Ctrl + L>.

Follow-up Procedures

Once this procedure is complete, return to the procedure which referred you to this DLP and continue with the tasks indicated there.

VERIFYING COMMUNICATIONS OVER AN IP LAN

Introduction

When an **ETHERNET** port is connected to a local area network (LAN), test steps must be performed on the ATLAS 550 to ensure that the unit is communicating properly over the network. This procedure outlines those steps.

Prerequisite Procedures

Before beginning this procedure, the unit should be physically connected to the LAN and the provisioning tasks detailed in DLP-003 should be complete.

Tools and Materials Required

- Access to a PC or other computer connected to the LAN

WARNING

To prevent electrical shock, do not install equipment in a wet location or during a lightning storm.



Electronic modules can be damaged by static electrical discharge. Before handling modules, wear an antistatic discharge wrist strap to prevent damage to electronic components. Place modules in antistatic packing material when transporting or storing. When working on modules, always place them on an approved antistatic mat that is electrically grounded.

DLP-004

Perform Steps Below in the Order Listed

1. Ascertain the ATLAS 550 IP address.

If you do not already have the IP Address for the ATLAS 550, either obtain it from the network administrator or manually check for the address in the **SYSTEM CONFIG/ETHERNET PORT/IP ADDRESS** menu of the Network Management interface.



You must login with maximum rights to modify the IP parameters on the ATLAS 550.

2. Ping the ATLAS 550 unit from a remote computer on the network.

Using a remote computer system connected to the LAN, perform an ICMP Ping on the IP Address of the ATLAS 550. Verify that the unit responds properly.

If the ATLAS 550 fails to respond, try the following:

- Verify that the proper IP Address, Subnet Mask, and Default Gateway are provisioned in the unit (see DLP-003 for details).
- Verify that the ATLAS 550 is properly cabled into the LAN and that the Ethernet cable is properly seated in the RJ-45 jack on the rear of the unit.
- If the ATLAS 550 is connected to a hub or other network device that provides a carrier sense light for each port, verify that the carrier sense light for the port to which the ATLAS 550 is connected is lit. If this light is not lit, check the cabling between the hub and the shelf. The connection may also be verified using the **ETHERNET** LED located on the front panel of the ATLAS 550.
- Verify the IP Address, Subnet Mask, and Default Gateway on the remote computer system.

If none of these steps are successful, contact the LAN Administrator for assistance.



*Refer to the documentation of the computer system if you are unsure how to perform a Ping command. Most computers running a networked version of Microsoft Windows™ or UNIX allow a Ping to be performed by typing **ping <IP Address>** at a command line prompt. Typically, the Ping program will respond by indicating that the remote IP Address has responded in a certain amount of time or that no response was received.*



*Some versions of Ping will continue running until you explicitly tell them to stop. If the program does not terminate on its own, type **<CTRL+C>** to get the program to stop.*

3. Telnet to the ATLAS 550.

From the same computer used in the previous step, Telnet to the ATLAS 550 and verify that the Telnet session is properly opened (see DLP-002 for logging in to a system and establishing a Telnet session). Once the Telnet session is established, press <CTRL+L> to logout and close the session.



*Refer to the documentation of the computer system if you are unsure how to perform a Telnet. Most computers running a networked version of Microsoft Windows™ or UNIX allow a Telnet to be performed by typing **telnet <IP Address>** at a command line prompt. Telnet is a utility common on many local area networks that allows remote access to another computer or piece of equipment.*

Follow-up Procedures

Once this procedure is complete, return to the procedure which referred you to this DLP and continue with the tasks indicated there.

ADDING/REMOVING USERS AND CHANGING PASSWORD SECURITY LEVELS

Introduction

All menu items in the ATLAS 550 are protected by passwords of varying security levels. By assigning different passwords to different security levels, the ATLAS 550 System Administrator can control which users can view or change various menu items. You can assign multiple passwords at the same access level. This way, different users with the same access privileges can have different passwords. This procedure details the steps which must be performed to add or remove user profiles and assign password security levels in the ATLAS 550.

Tools and Materials Required

- VT100 terminal or PC with VT100 terminal emulation software

WARNING

To prevent electrical shock, do not install equipment in a wet location or during a lightning storm.



Electronic modules can be damaged by static electrical discharge. Before handling modules, wear an antistatic discharge wrist strap to prevent damage to electronic components. Place modules in antistatic packing material when transporting or storing. When working on modules, always place them on an approved antistatic mat that is electrically grounded.

DLP-005

Perform Steps Below in the Order Listed

1. Connect to the ATLAS 550 using either the **ETHERNET**, **CONTROL IN**, or **CRAFT** interfaces.

If you are not already connected to the unit's **CONTROL IN** or **CRAFT** interfaces (either with a VT100 compatible terminal or with a PC running VT100 emulation software), follow the procedure in DLP-001.

Alternately, if the unit is part of a management cluster connected to the local network, you may use a PC connected to the network to Telnet into the unit. Use the procedures in DLP-003 and DLP-004 to connect to the **ETHERNET** interface.

2. Login to the unit.

Login to the unit using the read-write password (see DLP-002 for details).

3. Go to the SYSTEM CONFIG menu and select the ACCESS PASSWORDS menu and press <Enter>.
4. To add a new user profile and password, select the first column (0) and press I (for insert).
5. Give the new user profile a name by selecting the LABEL field, pressing <Enter> and typing the user defined name.
6. Personalize the password for the appropriate label by selecting the PASSWORD field, pressing <Enter>, then typing the desired password.
7. Determine the password level for the corresponding label.

The ATLAS 550 contains six different password levels. The table below gives a brief description of each level.

Select level...	If you want the user to....
5	Have read-only permission for all menu items - minimum rights
4	Have read permission for all menu items and permission to use test commands
3	Have access to all commands except passwords, flash download, authentication methods, and interface configurations
2	Have access to all commands except passwords, flash download, and authentication methods
1	Have access to all commands except passwords
0	Have permission to edit every menu item, including creating and editing passwords -- maximum rights

8. Assign the password level to the appropriate label by selecting the ACCESS RIGHTS field and choosing the level decided upon in Step 7.

Passwords for the ATLAS 550 system are case sensitive. The default password for a new user profile is "**password**". The current password displays as a series of asterisks (*****).

Follow-up Procedures

Once this procedure is complete, return to the procedure which referred you to this DLP and continue with the tasks indicated there.

UPDATING THE FIRMWARE USING TFTP

Introduction

The ATLAS 550 supports firmware updates via the 10/100BaseT **ETHERNET** port using either TFTP from a network server or the **CONTROL IN** or **CRAFT** interfaces using XMODEM. This DLP provides the steps for a successful firmware upgrade using the 10/100 BaseT **ETHERNET** port and a TFTP server.

Tools and Materials Required

- A PC with Telnet client software
- A TFTP server accessible on the local network (A TFTP server is provided with the unit as part of the ADTRAN Utilities software.)

WARNING

To prevent electrical shock, do not install equipment in a wet location or during a lightning storm.



CAUTION

Electronic modules can be damaged by static electrical discharge. Before handling modules, wear an antistatic discharge wrist strap to prevent damage to electronic components. Place modules in antistatic packing material when transporting or storing. When working on modules, always place them on an approved antistatic mat that is electrically grounded.

DLP-006

Perform Steps Below in the Order Listed

1. Connect to the ATLAS 550 using the **ETHERNET** interface.

If you are not already connected to the unit's **ETHERNET** port using Telnet client software, use the procedure in DLP-003 to connect to the unit.

2. Login to the unit.

Login to the unit using the read-write password (see DLP-002 for details).

3. Go to the **SYSTEM UTILITY** menu and select the **UPDATE FIRMWARE** menu; press <Enter>.

4. Select the **MODULE SLOT** menu and press <Enter>.

Select the appropriate module slot to update. The module slot for the ATLAS 550 system controller will be module slot 0.

5. Go to the **TRANSFER METHOD** menu and select TFTP.

6. Enter into TFTP **SERVER IP ADDRESS**, the IP address of the network TFTP server.

7. Enter into TFTP **SERVER FILENAME**, the full path name and filename of the update file.

8. From the **RESTART SCHEDULE** menu, select the time for the module to perform a restart after completing the update.

RESTART IMMEDIATELY AFTER UPDATE restarts the system immediately after the update is complete.

RESTART AT SPECIFIED DATE AND TIME allows you to select when the updated system will restart. If you select this option, a new field called **RESTART DATE AND TIME** displays below the current field. To use that option, enter the time in 24-hour format (such as 23:00:00 for 11:00 pm). Enter the date in mm-dd-yyyy format (for example, 09-30-2000).

9. **VIEW CURRENT UPDATE STATUS** to verify the progress of the current firmware update or to identify any errors encountered during the download.

Refer to the table on the following page for a detailed description of messages found in this field.

10. Select **BEGIN FIRMWARE UPDATE** to start the update. Enter Y to confirm the transfer and to set up the module to receive the TFTP Upload.

During the TFTP upload, various status messages display in **CURRENT UPDATE STATUS** to indicate progress. The following table describes these messages.

Message	Meaning
Contacting Server	Indicates communication with the TFTP network server is trying to be established with the specified server address in the TFTP SERVER IP ADDRESS field.
Beginning TFTP Transfer	Indicates communication with the TFTP network server has been established and the update file is being transferred between the ATLAS 550 and the TFTP network server.
Completed	Indicates the ATLAS 550 successfully received the update file.
Error: File Not Found	Indicates the TFTP network server was unable to locate the specified file name or path in the TFTP SERVER FILENAME field.
Error: Access Violation	Indicates the TFTP network server denied the ATLAS 550 access to the given update filename and path. Please verify appropriate user rights are selected for the specified path.

11. When the update has successfully completed, **IDLE** displays in the **CURRENT UPDATE STATUS** field and **MODULE UPDATE COMPLETE** displays in the **PREVIOUS UPDATE STATUS** field.

The ATLAS 550 will either restart immediately and resume operation, or will restart at the specified time and day of the week—depending on your selection.

Follow-up Procedures

Once this procedure is complete, return to the procedure which referred you to this DLP and continue with the tasks indicated there.

UPDATING THE FIRMWARE USING XMODEM

Introduction

The ATLAS 550 supports firmware updates via the **ETHERNET** port using either TFTP from a network server or the **CONTROL IN** or **CRAFT** interfaces using XMODEM. This procedure outlines the steps for a successful firmware upgrade using the **CONTROL IN** or **CRAFT** interfaces and XMODEM software.

Tools and Materials Required

- VT100 terminal or PC with VT100 terminal emulation software
- XMODEM software

WARNING

To prevent electrical shock, do not install equipment in a wet location or during a lightning storm



CAUTION

Electronic modules can be damaged by static electrical discharge. Before handling modules, wear an antistatic discharge wrist strap to prevent damage to electronic components. Place modules in antistatic packing material when transporting or storing. When working on modules, always place them on an approved antistatic mat that is electrically grounded.

DLP-007

Perform Steps Below in the Order Listed

1. Connect to the ATLAS 550 using the RJ-45 **CONTROL IN** or **CRAFT** interface.

If you are not already connected to the shelf's **CONTROL IN** or **CRAFT** interface (either with a VT100 compatible terminal or with a PC running VT100 emulation software), follow the procedure in DLP-001. Connecting to the **CONTROL IN** or **CRAFT** interface limits the upgrade procedure to XMODEM only.

2. Login to the unit.

Login to the unit using the read-write password (see DLP-002 for details).

3. Go to the **SYSTEM UTILITY** menu and select the **UPDATE FIRMWARE** menu; press <Enter>.

4. Select the **MODULE SLOT** menu and press <Enter>.

Select the appropriate module slot to update. Select **SLOT 0** to update the system controller.



Selecting **ALL MODULES OF A TYPE** and **SYS CTRL** will force a controller reboot during the update.

5. Go to the **TRANSFER METHOD** menu and select XMODEM.
6. From the **RESTART SCHEDULE** menu, select the time for the module to perform a restart after completing the update process.

RESTART IMMEDIATELY AFTER UPDATE restarts the system immediately after the update is complete. **RESTART AT SPECIFIED DATE AND TIME** allows you to select when the updated system will restart. If you select this option, a new field called **RESTART DATE AND TIME** displays below the current field. To use that option, enter the time in 24-hour format (such as 23:00:00 for 11:00 pm). Enter the date in mm-dd-yyyy format (for example, 09-30-2000).

7. View **CURRENT UPDATE STATUS** to verify the progress of the current firmware update or to identify any errors encountered during the download.
8. Select **BEGIN FIRMWARE UPDATE** to start the update. Enter Y to confirm the transfer and set up the module to receive the XMODEM Upload.

When the ATLAS 550 is ready to receive the XMODEM upload, the menu screen will clear and display **Awaiting XMODEM Upload...<Ctrl-X> twice to Cancel**. If this does not appear, please review the steps above for possible configuration errors.

9. From the terminal emulation software, begin the XMODEM upload by using the appropriate command sequence. This may take several minutes.

If necessary, refer to the terminal emulation software documentation for help. Also, when specifying the filename, ensure that the file transferred is the one provided by ADTRAN. Otherwise, the update will not complete successfully.

Because XMODEM data is being transferred in-band through the menu interface, the VT100 menus of the ATLAS 550 will be inoperable from the **CONTROL IN** or **CRAFT** interfaces. You can cancel the update at any time within the terminal emulation software. (Please consult the documentation provided by the terminal emulation software to determine how to do this).

10. When the update has successfully completed, **IDLE** displays in the CURRENT UPDATE STATUS field and **MODULE UPDATE COMPLETE** displays in the PREVIOUS UPDATE STATUS field.

The ATLAS 550 will either restart immediately and resume operation or restart at the specified time and day of the week, depending on your selection.

Alternately, if the unit is part of a management cluster connected to the local network, you may use a PC connected to the network to Telnet into the unit. By utilizing the **ETHERNET** port, the ATLAS 550 may be quickly upgraded using TFTP, provided there is a TFTP server on the local network. The ATLAS 550 ships with ADTRAN Utilities software, which includes a TFTP server. See DLP-006, *Updating the Firmware Using TFTP* for more details.

Follow-up Procedures

Once this procedure is complete, return to the procedure which referred you to this DLP and continue with the tasks indicated there.

SAVING THE CURRENT CONFIGURATION USING TFTP

Introduction

The ATLAS 550 supports configuration transfers from the unit (via the 10/100BaseT **ETHERNET** port) to a TFTP server located on the network. This DLP provides the steps for a successful configuration transfer using the **ETHERNET** port and a TFTP server.

Tools and Materials Required

- A PC with a Telnet client software
- A TFTP server accessible on the local network (A TFTP server is provided with the unit as part of the ADTRAN Utilities software).

WARNING

To prevent electrical shock, do not install equipment in a wet location or during a lightning storm.



CAUTION

Electronic modules can be damaged by static electrical discharge. Before handling modules, wear an antistatic discharge wrist strap to prevent damage to electronic components. Place modules in antistatic packing material when transporting or storing. When working on modules, always place them on an approved antistatic mat that is electrically grounded.

DLP-008

Perform Steps Below in the Order Listed

1. Connect to the ATLAS 550 using the **ETHERNET** interface.
If you are not already connected to the unit's **ETHERNET** port using Telnet client software, use the procedure in DLP-003 to connect to the unit.
2. Login to the unit.
Login to the unit using the read-write password (see DLP-002 for details).
3. Go to the SYSTEM UTILITY menu and select the CONFIGURATION TRANSFER menu; press <Enter>.
4. Set the TFTP SERVER IP ADDRESS to the IP address of the machine running the TFTP Server Program.



*If you are using the ADTRAN TFTP server, the IP address displays in the **STATUS** field. For other TFTP servers, please refer to the appropriate documentation.*

5. Change **TFTP** server filename to a unique filename. This will be the name of the configuration file saved to the remote server.
Some TFTP servers constrain the format of the filename depending on the operating system of the server. For example, a TFTP server running on a PC under Windows 3.1 may only permit 8.3 format filenames (8 characters, period and three extension characters).
6. Select the SAVE CONFIG REMOTELY menu field and press <Enter>.
Respond with **Y** to confirm request.
7. View **CURRENT TRANSFER STATUS** to verify the progress of the current transfer.
8. When the transfer has successfully completed, **IDLE** displays in the **CURRENT TRANSFER STATUS** field and **TFTP DOWNLOAD COMPLETE** displays in the **PREVIOUS TRANSFER STATUS** field.



*TFTP is **not** secure. No passwords are required for client access. Anyone can access files through the IP port on the server machine if they know the target file's name.*

Follow-up Procedures

Once this procedure is complete, return to the procedure which referred you to this DLP and continue with the tasks indicated there.

LOADING A CONFIGURATION USING TFTP

Introduction

The ATLAS 550 supports configuration uploads to a unit (via the **ETHERNET** port) to a TFTP server located on the network. This DLP provides the steps for a successful configuration upload using the **ETHERNET** port and a TFTP server.

Tools and Materials Required

- A PC with a Telnet client software
- A TFTP server accessible on the local network (A TFTP server is provided with the unit as part of the ADTRAN Utilities software).

WARNING

To prevent electrical shock, do not install equipment in a wet location or during a lightning storm



Electronic modules can be damaged by static electrical discharge. Before handling modules, wear an antistatic discharge wrist strap to prevent damage to electronic components. Place modules in antistatic packing material when transporting or storing. When working on modules, always place them on an approved antistatic mat that is electrically grounded.

DLP-009

Perform Steps Below in the Order Listed

1. Connect to the ATLAS 550 using the **ETHERNET** interface.
If you are not already connected to the unit's **ETHERNET** port using Telnet client software, use the procedure in DLP-003 to connect to the unit.
2. Login to the unit.
Login to the unit using at least a level 3 password (see DLP-002 for details).
3. Go to the **SYSTEM UTILITY** menu and select the **CONFIGURATION TRANSFER** menu; then press <Enter>.
4. Set the **TFTP SERVER IP ADDRESS** to the IP address of the machine running the TFTP Server Program.



*If you are using the ADTRAN TFTP server, the IP address displays in the **STATUS** field. For other TFTP servers, please refer to the appropriate documentation.*

5. Change **TFTP SERVER FILENAME** to a unique filename including path. This will be the name of the configuration file retrieved from the remote server.
Some TFTP servers constrain the format of the filename depending on the operating system of the server. For example, a TFTP server running on a PC under Windows 3.1 may only permit 8.3 format filenames (8 characters, period and three extension characters).



The ATLAS 550 system is rebooted immediately after a configuration is successfully loaded. No additional confirmation is requested, and any online sessions will be terminated.

6. Select the **LOAD AND USE CONFIG** menu field and press <Enter>.
Respond with **Y** to confirmation request.
7. View **CURRENT TRANSFER STATUS** to verify the progress of the current upload.
8. When the upload has successfully completed, **IDLE** displays in the **CURRENT TRANSFER STATUS** field and **TFTP DOWNLOAD COMPLETE** displays in the **PREVIOUS TRANSFER STATUS** field.



*TFTP is **not** secure. No passwords are required for client access. Anyone can access files through the IP port on the server machine if they know the target file's name.*

Follow-up Procedures

Once this procedure is complete, return to the procedure which referred you to this DLP and continue with the tasks indicated there.

SAVING THE CURRENT CONFIGURATION USING XMODEM

Introduction

The ATLAS 550 supports configuration transfers from the unit using a VT100 terminal or terminal emulator (with XMODEM) and the **CONTROL IN** or **CRAFT** interface. This DLP provides the steps for a successful configuration transfer using the **CONTROL IN** or **CRAFT** port and XMODEM.

Tools and Materials Required

- VT100 terminal or PC with VT100 terminal emulation software
- XMODEM software

WARNING

To prevent electrical shock, do not install equipment in a wet location or during a lightning storm.



CAUTION

Electronic modules can be damaged by static electrical discharge. Before handling modules, wear an antistatic discharge wrist strap to prevent damage to electronic components. Place modules in antistatic packing material when transporting or storing. When working on modules, always place them on an approved antistatic mat that is electrically grounded.

DLP-010

Perform Steps Below in the Order Listed

1. Connect to the ATLAS 550 using the RJ-45 **CONTROL IN** or **CRAFT** interface.

If you are not already connected to the unit's **CONTROL IN** or **CRAFT** interface (either with a VT100 compatible terminal or with a PC running VT100 emulation software), follow the procedure in DLP-001. Connecting to the **CONTROL IN** or **CRAFT** interface limits the config transfer procedure to XMODEM Only.

2. Login to the unit.
3. Go to the **SYSTEM UTILITY** menu and select **CONFIGURATION TRANSFER** menu; press <Enter>. Login to the unit using the read-write password (see DLP-002 for details).
4. Set the **TRANSFER METHOD** menu to XMODEM.
5. Select **SAVE CONFIG REMOTELY** to start the transfers. Enter Y to confirm the transfer and prepare the ATLAS 550 for the transfer download. The following message is displayed: "This will begin sending a copy of the current system configuration."
6. Configure the VT100 terminal or terminal emulation software to **Receive** (and prompt for a filename).
7. View the **CURRENT TRANSFER STATUS** to verify the progress of the current transfer.
8. From the terminal emulation software, begin the XMODEM transfer by using the appropriate command sequence. For Windows HyperTerminal, select Transfer>Receive File. Enter the filename (including path) and select XMODEM as the transfer method.

If necessary, refer to the terminal emulation software documentation for help. Also, when specifying the filename, ensure that the file saved has a .cfg extension. Otherwise, the file may not be available for uploading into other ATLAS 550 units.

Because XMODEM data is being transferred in-band through the menu interface, the VT100 menus of the ATLAS 550 will be inoperable from the **CONTROL IN** or **CRAFT** interfaces. You can cancel the update at any time within the terminal emulation software. (Please consult the documentation provided by the terminal emulation software to determine how to do this.)

9. When the transfer has successfully completed, **IDLE** displays in the **CURRENT TRANSFER STATUS** field and XMODEM **DOWNLOAD COMPLETE** displays in the **PREVIOUS TRANSFER STATUS** field.

Follow-up Procedures

Once this procedure is complete, return to the procedure which referred you to this DLP and continue with the tasks indicated there.

LOADING A CONFIGURATION USING XMODEM

Introduction

The ATLAS 550 supports configuration uploads from a unit using a VT100 terminal or terminal emulator (with XMODEM) and the **CONTROL IN** or **CRAFT** interface. This DLP provides the steps for a successful configuration upload using the **CONTROL IN** or **CRAFT** port and XMODEM.

Tools and Materials Required

- VT100 terminal or PC with VT100 terminal emulation software
- XMODEM software

WARNING

To prevent electrical shock, do not install equipment in a wet location or during a lightning storm.



Electronic modules can be damaged by static electrical discharge. Before handling modules, wear an antistatic discharge wrist strap to prevent damage to electronic components. Place modules in antistatic packing material when transporting or storing. When working on modules, always place them on an approved antistatic mat that is electrically grounded.

DLP-011

Perform Steps Below in the Order Listed

1. Connect to the ATLAS 550 using the RJ-45 **CONTROL IN** or **CRAFT** interface.
If you are not already connected to the unit's **CONTROL IN** or **CRAFT** interface (either with a VT100 compatible terminal or with a PC running VT100 emulation software), follow the procedure in DLP-001. Connecting to the **CONTROL IN** or **CRAFT** interface limits the config transfer procedure to XMODEM Only.
2. Login to the unit.
Login to the unit using the read-write password (see DLP-002 for details).
3. Go to the **SYSTEM UTILITY** menu and select **CONFIGURATION TRANSFER** menu; press <Enter>
4. Set the **TRANSFER METHOD** menu to XMODEM.
5. Select **LOAD AND USE CONFIG** to start the transfer. Enter Y to confirm the transfer and prepare the ATLAS 550 for the transfer download.



The ATLAS 550 system is rebooted immediately after a configuration is successfully loaded. No additional confirmation is requested, and any online sessions will be terminated.

When the ATLAS 550 is ready to receive the XMODEM configuration file, the menu screen will clear and display **Awaiting XMODEM Upload...<Ctrl-X> twice to Cancel**. If this does not appear, please review the steps above for possible configuration errors.

6. From the terminal emulation software, begin the XMODEM transfer by using the appropriate command sequence. For Windows HyperTerminal, select Transfer>Send File. Enter the filename (including path) and select XMODEM as the transfer method. ATLAS 550 configuration files should have a .cfg extension.

If necessary, refer to the terminal emulation software documentation for help.

Because XMODEM data is being transferred in-band through the menu interface, the VT100 menus of the ATLAS 550 will be inoperable from the **CONTROL IN** or **CRAFT** interfaces. You can cancel the update at any time within the terminal emulation software. (Please consult the documentation provided by the terminal emulation software to determine how to do this.)

7. View **CURRENT TRANSFER STATUS** to verify the progress of the current upload.
8. When the transfer is complete, the ATLAS 550 will reboot and the login screen will appear. The unit is now operational.

Follow-up Procedures

Once this procedure is complete, return to the procedure which referred you to this DLP and continue with the tasks indicated there.

CONNECTING THE ATLAS 550 TO AN EXTERNAL MODEM

Introduction

The ATLAS 550 can be accessed and managed via a modem, allowing the same capabilities to the user as if connected to the local **CONTROL IN** or **CRAFT** ports. Access is provided either by a female RJ-45 connector, labeled **CONTROL IN**, located on the lower right corner of the back of the unit or by the **CRAFT** port, located on the lower left of the front of the unit.

Prerequisite Procedures

The ATLAS 550 should be mounted in its permanent location before connecting to an external modem.

Tools and Materials Required

- Female RJ-45 to Male DB-25 Connector (shipped with unit)
- Modem
- Modem Cable

WARNING

To prevent electrical shock, do not install equipment in a wet location or during a lightning storm.



CAUTION

Electronic modules can be damaged by static electrical discharge. Before handling modules, wear an antistatic discharge wrist strap to prevent damage to electronic components. Place modules in antistatic packing material when transporting or storing. When working on modules, always place them on an approved antistatic mat that is electrically grounded.

DLP-012

Perform Steps Below in the Order Listed

1. Mount the modem in its permanent position.
2. Connect power to the modem using manufacturer instructions.
3. Configure the modem as follows:

Speed	9600 bps
Data bits	8
Parity	none
Stop bits	1
Flow control	hardware
Auto answer	on
DTR	ignore
4. Connect the male RJ-45 connector of the data cable to the female RJ-45 connector, labeled **CONTROL IN**, located on the lower right corner of the back of the unit or to the **CRAFT** port, located on the lower left of the front of the unit.
5. Route the data cable to the modem.
6. Connect the other end of the cable to the RJ-45 end of the connector (RJ-45 to male DB-25). Then, connect the DB-25 end of the connector to the modem, configured as described above.
7. Connect the modem to the POTS line as required by the manufacturer.
8. Login to the ATLAS 550 system. (Refer to DLP-002 for detailed instructions).
9. From the **MAIN MENU**, select the **SYSTEM CONFIG** menu and press the right arrow key to enter the right-pane menus.
10. From the **SYSTEM CONFIG** menu, select the **CHAIN PORT** menu and press <Enter>. Once in the **CHAIN PORT** menus, press the right arrow key to enter the right-pane menus.
11. From the **CHAIN PORT** menus, select the **PORT TYPE** menu and select **DIAL**.

WARNING

*If you are connected to the ATLAS 550 using the **CRAFT** or **CONTROL IN** interfaces, changing the **PORT TYPE** mode to **DIAL** will terminate your session. You **MUST** have Ethernet access to the ATLAS 550 to change the **PORT TYPE** back to **DIRECT** and restore your terminal session.*

NOTE

*To complete the connection to the unit, the ATLAS 550 must now be called from a PC configured to emulate a VT100 terminal, with communication software set as in step 3 and configured for **DIAL** mode.*

Follow-Up Procedures

Once this procedure is complete, return to the procedure which referred you to this DLP and continue with the tasks indicated there.

USING THE ADTRAN UTILITY SYSLOG WITH THE ATLAS 550

Introduction

The ATLAS 550 Event Log is used to log various message types at settable threshold levels. The Event Log is a useful tool for troubleshooting switchboard (or call connection) activities including the viewing of digits received, digits transferred, and ISDN Messages. The Event Log can maintain the most recent 350 lines of data in a first in/first out buffer. To ensure that important data is not lost, saving the Event Log messages to an external Syslog server is advised. The ATLAS 550 ships with an ADTRAN provided Syslog server.

Prerequisite Procedures

This procedure assumes that the ATLAS 550 unit is connected to an IP network and is powered up.

Tools and Materials Required

- Syslog server (provided on ATLAS 550 System CD in ADTRAN Utilities)

WARNING

To prevent electrical shock, do not install equipment in a wet location or during a lightning storm.



Electronic modules can be damaged by static electrical discharge. Before handling modules, wear an antistatic discharge wrist strap to prevent damage to electronic components. Place modules in antistatic packing material when transporting or storing. When working on modules, always place them on an approved antistatic mat that is electrically grounded.

DLP-013

Setting Up the ATLAS 550 to use the Syslog

1. Login to the system with maximum rights (details for logging in are in DLP-002). Once you have logged into the ATLAS 550, go to **SYSTEM CONFIG/SYSLOG SETUP**. Set the options as follows:
 - **TRANSMISSION:** Enabled
 - **HOST IP ADDRESS:** Enter the IP address of the PC where the Syslog host resides
 - **HOST FACILITY:** Specify the facility destination of log events; Options are **LOCAL0** to **LOCAL7**

Setting Up the Syslog Host

1. On your PC, go to **START/PROGRAMS/ADTRAN UTILITIES/SYSLOG**. When the Syslog window opens, you will see **LOCAL0** through **LOCAL7** listed on the left. This should correspond with the **HOST FACILITY** specified in the ATLAS 550. The Syslog program must be open on your PC in order for it to record ATLAS 550 information. The Syslog files can be viewed through the Syslog window, and they are also available under the ADTRAN Utilities Folder named **LOCALX.TXT**, where X can equal 0 through 7. You can also view the **LOCALX.TXT** file by clicking on **EDIT LOG**.

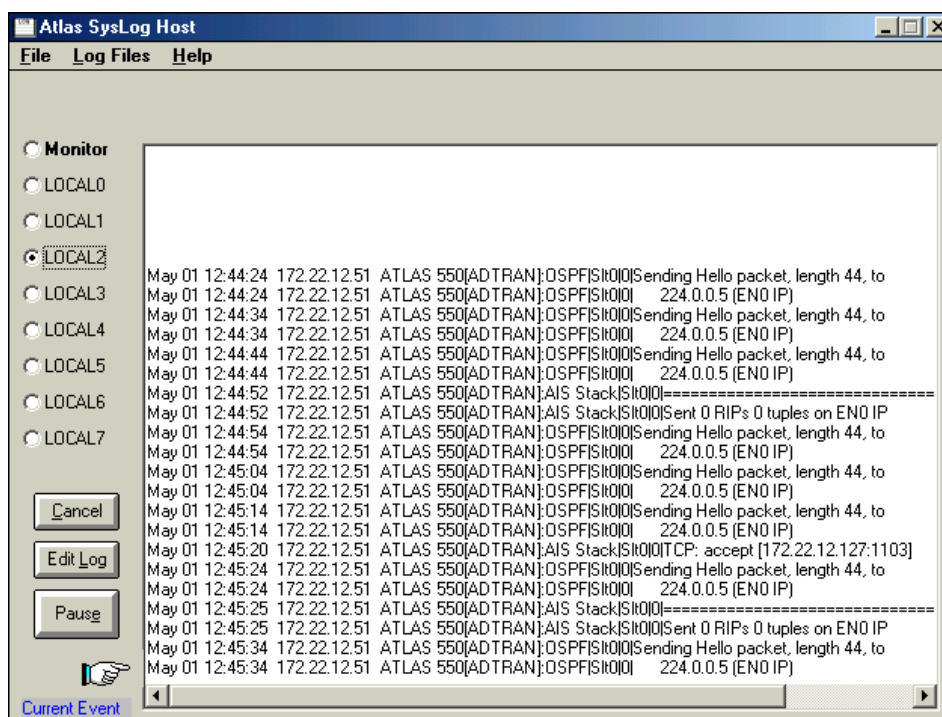

Any event logged in the ATLAS 550 event log (**SYSTEM STATUS/EVENT LOG**) should also appear in the Syslog.

Additional Syslog Features

- The **MONITOR** feature allows all Syslog messages to be pre-filtered by **SYSTEM NAME**, **SOURCE**, **SLOT**, and **PORT** before displaying these messages to the user and logging the message to the pre-designated monitor log file. Various filter options may be defined by selecting **SOURCE**. The figure below shows the **SOURCE FILTER** window. When the **MONITOR** button is selected, the file will be logged to **LOCAL8.TXT**. To look at the text file, click on the **EDIT LOG** button on the left side of the Syslog screen.

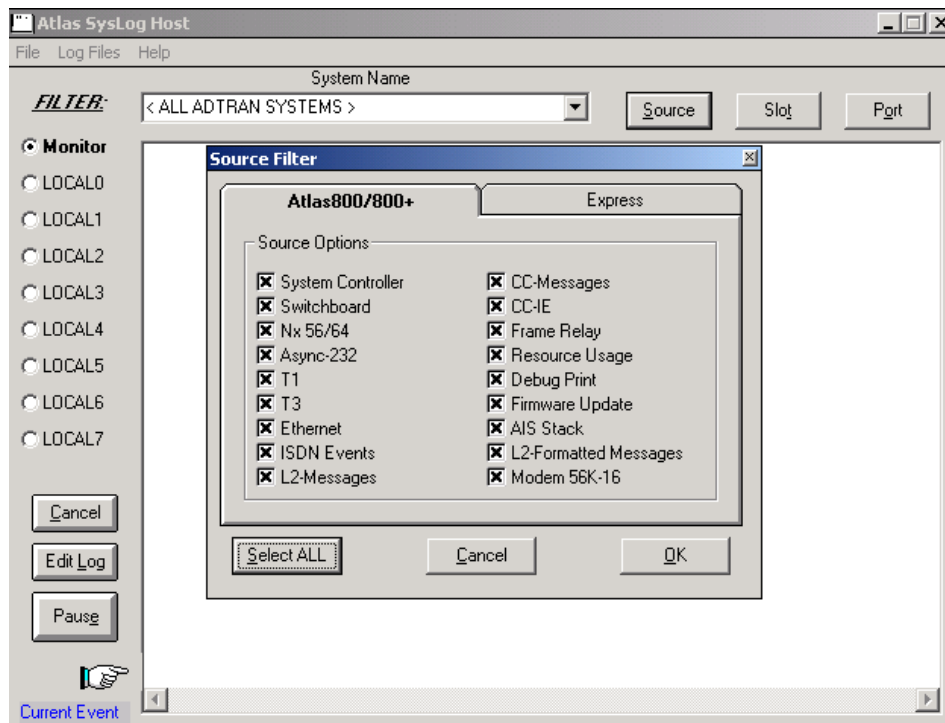

Only the Source Options that are selected with an 'x' will be displayed in the Syslog file. In this example, all options will be displayed.

- Under the **LOG FILES** menu option, the user may erase log files, define Red events, set priorities, and clear Red events. The **ERASE LOG FILES** option erases the specified txt log file. **DEFINE RED EVENTS** allows the user to predefine a message priority condition so that if the condition occurs, the file is highlighted in red. In the first figure on the next page, any **CRITICAL** or **MAJOR** condition causes any **LOCAL0** through **LOCAL7** facility to become highlighted in red if it receives a critical or major alarm.

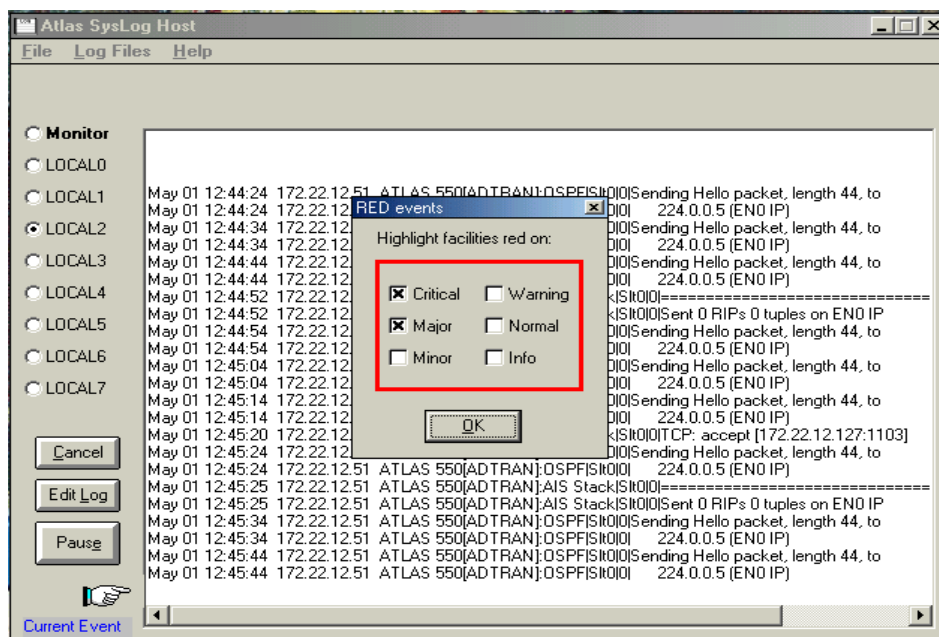

- The **PROPERTIES** menu allows the user to specify the types of messages to be logged to an ASCII text file. Mark the lowest priority Event Log message you want to log to the Syslog server text file. For example, the figure below shows that all messages will be logged to the text file.

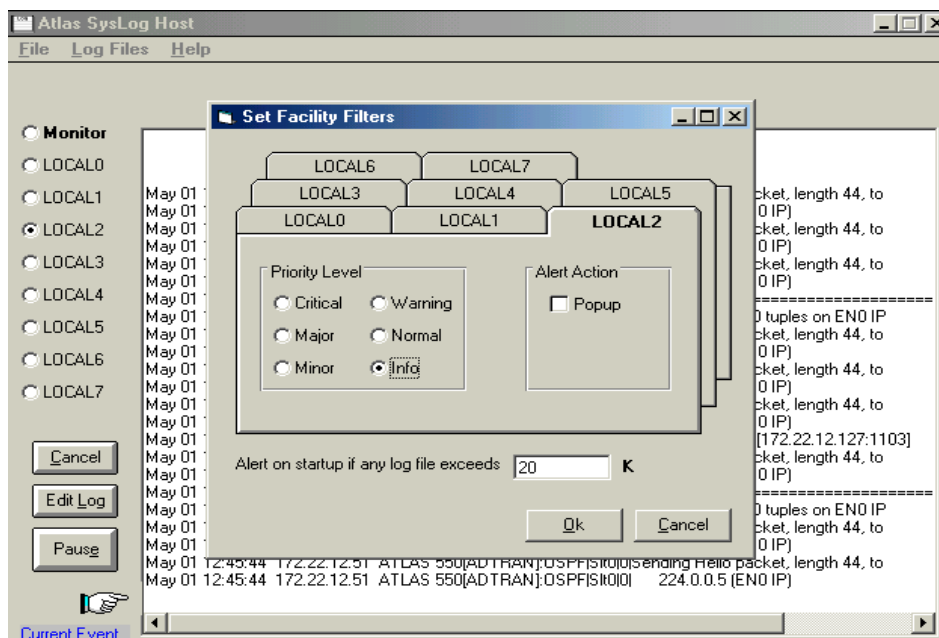

- The **HELP** menu also explains these features. Click on **HELP/CONTENTS/SYSLOG HOST DAEMON** for further explanation of Syslog features.

Follow-up Procedures

Once this procedure is complete, return to the procedure which referred you to this DLP and continue with the tasks indicated there.

CONNECTING THE ALARM CONTACTS

Introduction

This DLP explains how to connect the alarm contacts on the ATLAS 550.

Prerequisite Procedures

Before making alarm connections, the unit should be mounted in its permanent location.

Tools and Materials Required

- Wire strippers
- Small, straight slot screwdriver
- 22 or 24 AWG 2-conductor twisted pair cross connect wire

WARNING

To prevent electrical shock, do not install equipment in a wet location or during a lightning storm.



Electronic modules can be damaged by static electrical discharge. Before handling modules, wear an antistatic discharge wrist strap to prevent damage to electronic components. Place modules in antistatic packing material when transporting or storing. When working on modules, always place them on an approved antistatic mat that is electrically grounded.

DLP-014

Perform Steps Below in the Order Listed

1. For the alarm relay contacts labeled ALARM, determine whether the external alarm reporting device uses a normally open (NO) or normally closed (NC) circuit for alarm relay. For the external monitor labeled **RELAY MON**, the ATLAS 550 uses a NO circuit for alarm relay.
2. Using standard Telco cross-connect wire, determine and cut the length required to reach from the alarm headers to the alarm-reporting device(s).
3. Using wire strippers, strip 1 inch from both ends of each wire.
4. Remove both terminal blocks.
5. Using the small straight slot screwdriver, loosen the screws in both terminal blocks.
6. For the four-position terminal block, insert one strand into the third slot (counted from the left) for the COM connection from the ATLAS 550.
7. Insert another strand into either the first slot or the second slot for the NC or NO connections, respectively.
8. For the two-position terminal block, insert one strand into the first slot (counted from the left) for the Alarm Out signal. Insert the other strand into the last slot for the Alarm In signal. Complete this step only if you wish to have the ATLAS 550 monitor for external alarms.
9. Connect the wires to the appropriate terminals on the external device(s) being used.

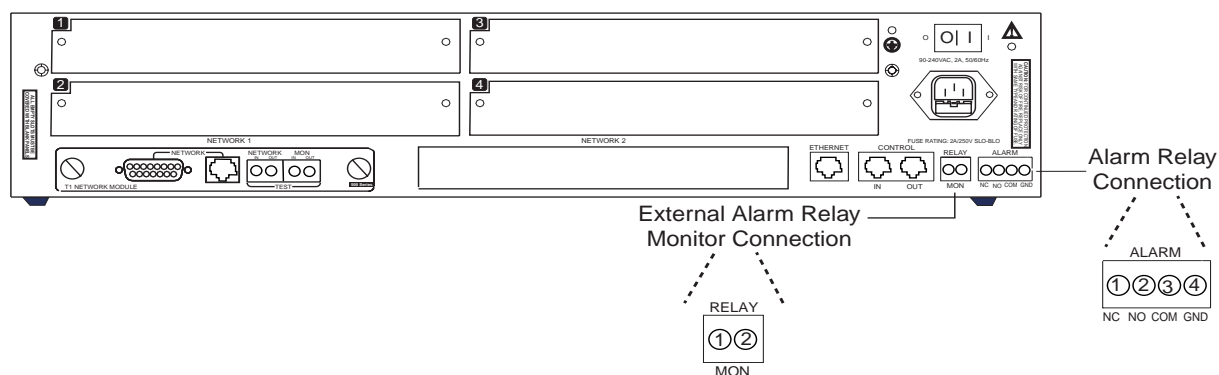

Table 1. Alarm Relay Connector Pinout

Pin	Name	Description
1	Normally Closed (NC)	Opens when a selected alarm condition is present.
2	Normally Open (NO)	Closes when a selected alarm condition is present.
3	Common (COM)	Common connection between external circuitry and NC or NO terminal.
4	Chassis Ground (GND)	

Table 2. External Relay Monitor Connector Pinout

Pin	Name	Description
1	Alarm Out	Outputs EIA-232 level signal for connection to external alarm contacts.
2	Alarm In	Monitors signal coming from external alarm contacts.

Follow-up Procedures

Once this procedure is complete, return to the procedure which referred you to this DLP and continue with the tasks indicated there.

USING THE ALARM CONNECTIONS AND ACO BUTTON

Introduction

The alarm connections alert the user when a selected alarm condition exists. The alarm may be cleared by pressing the Alarm Cut-Off (**ACO**) switch on the front panel of the ATLAS 550. This procedure details the steps which must be performed to use the ATLAS 550 alarm connections and **ACO** switch.

This procedure should be performed at installation on each ATLAS 550 shelf that is wired out to external office alarm equipment.

Prerequisite Procedures

Before beginning this procedure, the ATLAS 550 should be mounted in its permanent location and the alarm contacts should be connected (see DLP-014).

Tools and Materials Required

- VT100 terminal or PC with VT100 terminal emulation software

WARNING

To prevent electrical shock, do not install equipment in a wet location or during a lightning storm.



CAUTION

Electronic modules can be damaged by static electrical discharge. Before handling modules, wear an antistatic discharge wrist strap to prevent damage to electronic components. Place modules in antistatic packing material when transporting or storing. When working on modules, always place them on an approved antistatic mat that is electrically grounded

DLP-015

Perform the Steps Below in the Order Listed

To Begin

1. Connect to the ATLAS 550 using either the **ETHERNET**, **CONTROL IN**, or **CRAFT** interfaces.

If you are not already connected to the unit's **CONTROL IN** or **CRAFT** interfaces (either with a VT100 compatible terminal or with a PC running VT100 emulation software), use the procedure in DLP-001 to connect to the **CONTROL IN** or **CRAFT** interface.

Alternately, if the unit is part of a management cluster connected to the local network, you may use a PC connected to the network to Telnet into the unit. Use the procedures in DLP-003 and DLP-004 to connect to the **ETHERNET** interface.

2. Login to the unit.

Login to the unit using the read-write password (see DLP-002 for details).

Configure the Alarm Relay

1. Go to the SYSTEM CONFIG menu and press the right arrow key to access the right-pane menus. Select the ALARM RELAY THRESHOLD menu and choose the appropriate threshold level. The ALARM RELAY will set for this threshold and all other alarms of greater importance. Refer to Section 7, *System Event Logging* of this user manual for a listing of all alarms and levels of importance.



*Setting the threshold to **NORMAL** will not set the **ALARM RELAY** for **NORMAL** events. No **NORMAL** events set the **ALARM RELAY**.*

Configure the Alarm Monitor



Complete the following steps only if you wish to monitor for external alarms.

1. Go to the SYSTEM CONFIG menu and press the right arrow key to access the right-pane menus. Then, select the EVENT LOGGING menu and press <Enter>. Once in the EVENT LOGGING menu, press the right arrow key to access the right-pane menus.
2. From the EVENT LOGGING menu, select the EXTERNAL INPUT menu and set it to the same value as the ALARM RELAY THRESHOLD. Any event on the ALARM MONITOR will now be logged in the EVENT LOG and set the ALARM RELAY.

Clearing the Alarm Relay Remotely

1. Go to the SYSTEM CONFIG menu and press the right arrow key to access the right-pane menus. Then, select the ALARM RELAY RESET field and press <Enter>.



*The **ALARM RELAY** may be cleared locally by pressing the **ACO** switch.*

Follow-up Procedures

Once this procedure is complete, return to the procedure which referred you to this DLP and continue with the tasks indicated there.

CONFIGURATION GUIDES

Dial Backup for Dedicated T1 Circuits..... CFG-001

DIAL BACKUP FOR DEDICATED T1 CIRCUITS

Introduction

Dial backup is an ATLAS 550 capability which allows you to create alternate data connections in the unit to ensure data integrity in the event of a primary circuit failure. This note will explain what dial backup is and how to configure an ATLAS 550 to support it. There are three steps to configuring the ATLAS 550 for dial backup: Configuring the Dedicated T1 Data Link, Configuring the Dial Backup PRI, and Configuring the Dial Backup Endpoint.



The primary link to be backed up must be a data link to a V.35 port. Dedicated dial backup for T1 ports is not currently supported.

Before You Begin

This application requires an ATLAS 550 containing firmware B.01 or later, a V.35 Nx Module (P/N 1200311L1), and a BONDing Module (P/N 1200326L1) if bonding of B channels is required.

Description

The ATLAS 550 will either originate or answer a dial backup call upon detection of a network failure or data failure on the T1/E1. A network failure is any physical layer T1/E1 failure, such as red alarm or loss of signal (LOS). A data failure is detected when the ATLAS 550 no longer receives keep-alive responses over the 8K inband channel. The data criteria for dial backup can only be used when configured to monitor the inband channel.

CFG-001

To Configure the Sample Network, Perform the Steps Below in the Order Listed

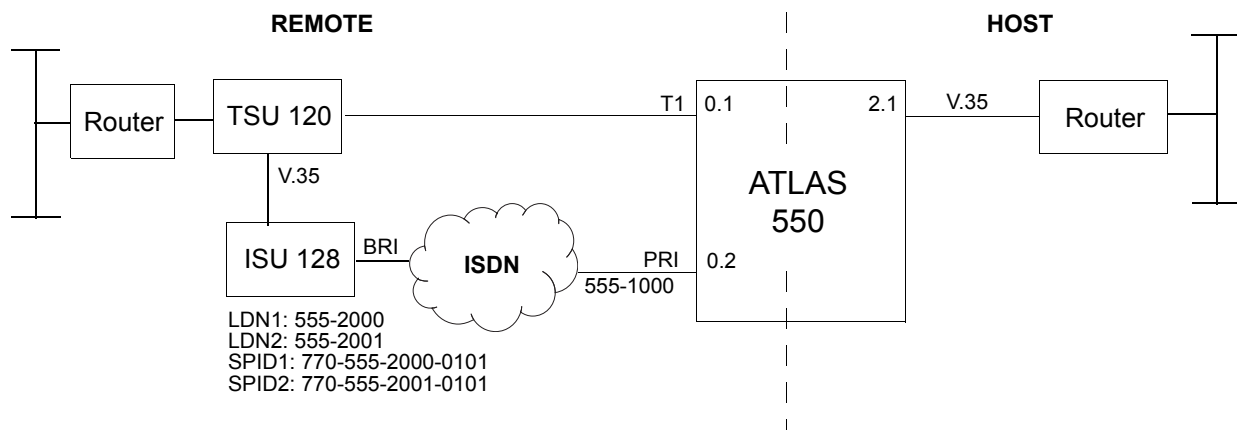

Configuring the DEDICATED T1 Data Link

1. Log into the ATLAS 550 unit with access level 4 or greater.
Please refer to the ATLAS manual for more details on passwords and access levels.
2. From the main menu, select the DEDICATED MAPS menu field. Once the DEDICATED MAPS menu is selected, press the right arrow key to move to the right-pane menu items, then select the CREATE/EDIT MAPS field and press <Enter>.

```

ATLAS 550/Dedicated Maps/Create/Edit Maps
Create/Edit Maps
Map Name Sort TO/FROM Connects Activate Time Enbl Day
1 Map 1 FROM [Cncts=0] 00:00:00 [Enable]
2 Map 2 FROM [Cncts=0] 00:00:00 [Disabl]
3 Map 3 FROM [Cncts=0] 00:00:00 [Disabl]
4 Map 4 FROM [Cncts=0] 00:00:00 [Disabl]
5 Map 5 FROM [Cncts=0] 00:00:00 [Disabl]

SYS: OK NETWK1:ALRM NETWK2: -- 1:ALRM 2:ALRM 3: -- 4: --
^Z=help 5:12

```

3. Move to the **CONNECTS** field and press <Enter>. Once in the **CONNECTS** menus, press the right arrow key to enter the right-pane menu items.

```

ATLAS 550/Dedicated Maps/Create/Edit Maps [1]/Connects [1]
Connects
Enbl Day # FROM SLT Port TO SLT/S Prt/PEP From Config To Config SIG
1 None None None None N/A N/A
SYS: OK NETWK1:ALRM NETWK2: -- 1:ALRM 2:ALRM 3: -- 4: --
INS/DEL ^Z=help 5:21
    
```

4. To enter the slot location of the V.35 module that will connect to the Host side router, select the **FROM SLT** column and press <Enter> to display a list of available slots. For the sample network, choose **S2)V35Nx-2**.

```

ATLAS 550/Dedicated Maps/Create/Edit Maps [1]/Connects [1]/FROM Slot
Connects
Enbl Day # FROM SLT Port TO SLT/S Prt/PEP From Config To Config SIG
1 None None None None N/A N/A
FROM Slot
S1>T1/PRI-2
S2>V35Nx-2
N1>T1/PRI-1
SYS: OK NETWK1:ALRM NETWK2: -- 1:ALRM 2:ALRM 3: -- 4: --
^Z=help 5:23
    
```

5. To enter the port location of the V.35 port that will connect to the Host side router, select the **PORT** column and press <Enter> to display a list of available ports. For the sample network, choose **1)Nx56/64 PORT**.

```

ATLAS 550/Dedicated Maps/Create/Edit Maps [1]/Connects [1]/Port
Connects
Enbl Day # FROM SLT Port TO SLT/S Prt/PEP From Config To Config SIG
1 S2>V35Nx None None None N/A N/A
Port
1)Nx56/64 Port
2)Nx56/64 Port
SYS: OK NETWK1:ALRM NETWK2: -- 1:ALRM 2:ALRM 3: -- 4: --
^Z=help 5:28
    
```

6. To enter the slot location of the T1 Module that will connect to the network T1 circuit, select the **TO SLT** column and press <Enter> to display a list of available slots. For the sample network, choose **N1)T1/PRI 1**.

```

ATLAS 550/Dedicated Maps/Create/Edit Maps[1]/Connects[1]/TO Slot/Service
Connects # FROM SlT Port TO SlT/S Prt/PEP From Config To Config SIG
Enbl Day 1 S2>U35Nx 1>Nx56/ None None N/A N/A

TO Slot/Service
S1>T1/PRI-2
S2>U35Nx-2
N1>T1/PRI-1
PktEndpt
PktVoice

SYS: OK NETWK1:ALRM NETWK2: -- 1:ALRM 2:ALRM 3: -- 4: --
^Z=help 5:33

```

7. To enter the port location of the T1 port that will connect to the network T1 circuit, select the **PORT** column and press <Enter> to display a list of available ports. For the sample network, choose **1)T1/PRI**.

```

ATLAS 550/Dedicated Maps/Create/Edit Maps[1]/Connects[1]/Port/Pkt Endpt
Connects # FROM SlT Port TO SlT/S Prt/PEP From Config To Config SIG
Enbl Day 1 S2>U35Nx 1>Nx56/ N1>T1/PR None N/A N/A

Port/Pkt Endpt
1>T1/PRI

SYS: OK NETWK1:ALRM NETWK2: -- 1:ALRM 2:ALRM 3: -- 4: --
Port or Packe: Endpoint <PEP> ^Z=help 5:35

```

8. Since a Network Module T1/PRI port was selected, the system will automatically populate the **FROM CONFIG** field with **RATE = 64K**. For option module T1/PRI interfaces, you will need to select the appropriate rate.

```

ATLAS 550/Dedicated Maps/Create/Edit Maps[1]/Connects[1]/From Config
Connects # FROM SlT Port TO SlT/S Prt/PEP From Config To Config SIG
Enbl Day 1 S2>U35Nx 1>Nx56/ N1>T1/PR 1>T1/PR [Rate=64k] [DS0=1]

SYS: OK NETWK1:ALRM NETWK2: -- 1:ALRM 2:ALRM 3: -- 4: --
^Z=help 5:42

```

- To configure the appropriate T1 DSOs, select the **To CONFIG** column and press <Enter>. Once in the **To CONFIG** menus, right arrow to the **DSO SELECTION** field, press <Enter>, and enter 1-18.

```

ATLAS 550/Dedicated Maps/Create/Edit Maps[1]/Connects[1]/To Config/DSO Selection
From Config DSO Selection 1
To Config DSOs Available *23456789012345678901234
DSO Selection
1-18
SYS: OK NETWK1:ALRM NETWK2: -- 1:ALRM 2:ALRM 3: -- 4: --
Enter a: lists [1,5,'] or ranges [1-13]. ^M=more ^Z=help 5:45
    
```

Configuring the DIAL BACKUP PRI

- From the main menu, select the DIAL PLAN menu field. Press the right arrow key to move to the right-pane menu items, then select the NETWORK TERM field and press <Enter>.

```

ATLAS 550/Dial Plan/Network Term
Network Term # Slot/Svc Port/PEP Sig Out#Accept Out#Rej Ifce Config
User Term
Global Param
SYS: OK NETWK1:ALRM NETWK2: -- 1:ALRM 2:ALRM 3: -- 4: --
Terminations of connections to the network INS ^Z=help 5:55
    
```

- To enter the slot location of the network PRI being used for Dial Backup, select the **SLOT/Svc** field and press <Enter> to display a list of available slots. For the sample network, choose **S1)T1/PRI - 2**.

```

ATLAS 550/Dial Plan/Network Term[1]/Slot/Service
Network Term # Slot/Svc Port/PEP Sig Out#Accept Out#Rej Ifce Config
User Term 1 None None [*] [*]
Global Param
Slot/Service
S1)T1/PRI-2
N1)T1/PRI-1
PktVoice
SYS: OK NETWK1:ALRM NETWK2: -- 1:ALRM 2:ALRM 3: -- 4: --
^Z=help 5:56
    
```

- To enter the port location of the network PRI being used for Dial Backup, select the **PORT/PEP** column to display a list of available ports. For the sample network, choose **1)T1/PRI**.

```

ATLAS 550/Dial Plan/Network Term[1]/Port/Packet Endpoint
Network Term # Slot/Slot Port/PEP Sig Out#Accept Out#Rej Ifce Config
User Term 1 S1>T1/PRI-2 None [*] [*]
Global Param

Port/Packet Endpoint
1)T1/PRI
2)T1/PRI

SYS: OK NETWORK1:ALRM NETWORK2: -- 1:ALRM 2:ALRM 3: -- 4: --
Select Port or Packet Endpoint ^Z=help 5:59

```

- Select the **SIG** field and press <Enter> to display a list of available signal methods. For the sample network, choose the **PRI** selection.

```

ATLAS 550/Dial Plan/Network Term[1]/Signaling
Network Term # Slot/Slot Port/PEP Sig Out#Accept Out#Rej Ifce Config
User Term 1 S1>T1/PRI-2 1)T1/PRI PRI [*] [*]
Global Param

Signaling
RBS
PRI
NONE

SYS: OK NETWORK1:ALRM NETWORK2: -- 1:ALRM 2:ALRM 3: -- 4: --
^H=more ^Z=help 6:00

```

- To enter the correct call routing information for this PRI, select the **OUT#ACCEPT** field and press <Enter>. Then, press the right arrow key to enter the right-pane menus. Select the **ACCEPT NUMBER** field and press <Enter>. To allow ALL calls to route out this PRI to the network, enter a '\$'.

```

ATLAS 550/Dial Plan/Network Term[1]/Outgoing Number Accept List[1]/Accept Number
Outgoing Number Accept List L Src ID Accept Number Search Data 64K Data 50
Outgoing Number Reject List 1 0 770-555-200101 Primary Enabled Enable
Interface Configuration

Accept Number
$

SYS: OK NETWORK1:ALRM NETWORK2: -- 1:ALRM 2:ALRM 3: -- 4: --
Match pattern - Digits 0-9, [, ., N, X, and $ ^H=more ^Z=help 12:55

```



For a detailed explanation of possible entries, highlight the **ACCEPT NUMBER** field and press <Ctrl + A>.

- To configure the parameters needed for proper operation of the PRI D channel, select the **IFCE CONFIG** field and press <Enter>. Once at the **IFCE CONFIG** menus, configure the switch type by selecting the **SWITCH TYPE** field and choosing the appropriate protocol. Remember, this is the protocol running on the Central Office switch, not the manufacturer's name. For the sample network, choose the **NATIONAL ISDN** selection.

```

ATLAS 550/Dial Plan/Network Term1/Interface Configuration/Switch Type
Outgoing Number Accept List Switch Type National ISDN
Outgoing Number Reject List First DS0 1
Interface Configuration Number of DS0s 23
Outgoing Number Conv. ISDN-National As Dialed
Strip MSD None
Mtwrk Spec. Fac. - Uoice Normal
Mtwrk Spec. Fac. - Data Normal
C Mtwrk Spec. Fac. - fered All
O -Switch Type Send as provided
S Lucent 5E 0
S Northern DMS100 Disabled
B National ISDN Normal
AT&T 4ESS

SYS: OK NETWK1:ALRM NETWK2: -- 1:ALRM 2:ALRM 3: -- 4: --
~?help 14:19
    
```

NOTE *The remaining configuration parameters are normally left at default values. For more details on these parameters, please refer to your ATLAS 550 System Manual.*

CONFIGURING THE DIAL BACKUP ENDPOINT

- From the main menu, select the DIAL PLAN menu field. Press the right arrow key to move to the right-pane menu items, then select the USER TERM field and press <Enter>.

```

ATLAS 550/Dial Plan/User Term
Network Term  # Slot/Svc Port/PEP Sig In#Accept Out#Rej Ifce Config
User Term
Global Param

SYS: OK  NETWK1:ALRM  NETWK2: --  1:ALRM  2:ALRM  3: --  4: --
Termination of connections to user equipment  INS  ^Z=help 14:23

```

- For the slot location of the backup entry, select the **SLOT/SVC** field and press <Enter> to display a list of available slots. For the sample network, choose **CIRCUIT BACKUP**.

```

ATLAS 550/Dial Plan/User Term[1]/Slot/Service
Network Term  # Slot/Svc Port/PEP Sig In#Accept Out#Rej Ifce Config
User Term    1 None None [+] [+]
Global Param

Slot/Service
S1>I1/PRI-2
S2>U35Nx-2
N1>I1/PRI-1
PktEndpt
PktVoice
Circuit Backup

SYS: OK  NETWK1:ALRM  NETWK2: --  1:ALRM  2:ALRM  3: --  4: --
^Z=help 14:27

```

- For the port location of the backup entry, select the **PORT/PEP** column and press <Enter> to display a list of available ports. This is the port that will be backed up if a failure occurs on the network T1. For the sample network, choose **2.1)Nx56/64 PORT**.

```

ATLAS 550/Dial Plan/User Term[1]/Port/Packet Endpoint
Network Term # Slot/Svc Port/PEP Sig In#Accept Out#Rej Ifce Config
User Term 1 Ckt Backup None [*] [*]
Global Param

Port/Packet Endpoint
2.1)Nx56/64 Port

SVS: OK NETWK1:ALRM NETWK2: -- 1:ALRM 2:ALRM 3: -- 4: --
Select Port or Packet Endpoint ^Z=help 14:28
    
```

NOTE The **PORT/PEP** field will only allow you to select V.35 ports that were entered in the **FROM SLT** field in the **DEDICATED MAP**.

- To enter the correct call routing information for this backup entry, select the **IN#ACCEPT** field and press <Enter>. Then, hit the right arrow key to enter the right-pane menus. Select the **ACCEPT NUMBER** field and press <Enter>. To accept calls coming from the network PRI, enter '555-1000'.

```

ATLAS 550/Dial Plan/User Term[1]/Incoming Number Accept List[1]/Accept Number
Incoming Number Accept List # Src ID Accept Number Search Data 64K Data 56
Outgoing Number Reject List 1 0 -- Primary Enabled Enable
Interface Configuration

Accept Number
555-1000

SVS: OK NETWK1:ALRM NETWK2: -- 1:ALRM 2:ALRM 3: -- 4: --
Match pattern - Digits 0-9, [], N, X, and $ ^A=more ^Z=help 14:34
    
```

NOTE For a detailed explanation of the possible entries, highlight the **ACCEPT NUMBER** field and press <Ctrl + A>.

5. Configure the **IFCE CONFIG** options for the backup link. These include the Dial Backup parameters. Navigate to the **IFCE CONFIG** option and press <Enter>. This will display a list of the Dial Backup options. The options are described following the figure.

```

ATLAS 550/Dial Plan/User Term[1]/Interface Configuration
Incoming Number Accept List  Originate/Answer  Originate
Outgoing Number Reject List  Outgoing Call Type  Digital 64
Interface Configuration      Source ID          0
                               Outdial Number     --
                               Force Mode         Auto
                               Backup Criteria    Net Fail
                               Restore Criteria   Net Success
                               Startup Delay      60
                               Backup Delay        10
                               Restore Delay       10
                               Max Num Redials    Unlimited
                               Redial Timer       10
                               Enable Schedule   [Active]
                               Test Call        [+1]
                               Min Num DS0s     1
                               Max Num DS0s     1
SYS: OK  NETWK1:ALRM  NETWK2: --  1:ALRM  2:ALRM  3: --  4: --
^Z=help 14:39

```

- **ORIGINATE/ANSWER**

ORIGINATE: The ATLAS 550 will be the originating side in the event of a failure.

ANSWER: The ATLAS 550 will answer any incoming calls, but only go into backup if an error is detected.

ANSWER ALWAYS: The ATLAS 550 will answer any incoming calls and immediately go into backup.

- **OUTGOING CALL TYPE**

DIGITAL 56K: Data rate for the backup endpoint is set to 56kbps.

DIGITAL 64K: Data rate for the backup endpoint is set to 64kbps.

- **SOURCE ID**

The **SOURCE ID** should remain in the default state unless it has been assigned elsewhere in the configuration. Please refer to the *ATLAS 550 System Manual* for a detailed discussion of the **SOURCE ID** field.

- **OUTDIAL NUMBER**

This field should contain the number you want the ATLAS 550 to dial upon going into backup.

- **FORCE MODE:**

AUTO: The ATLAS 550 will automatically follow the dial backup configuration parameters to go into backup.

FORCED: The ATLAS 550 must be manually forced to go into backup upon detection of a failure.

DISABLED: The ATLAS 550 will never go into backup regardless of data integrity.

- **BACKUP CRITERIA**

NET/DATA FAIL: DBU is initiated when either the network fails (possible causes include Red, Yellow, Blue, or LOS alarms) or when the Nx56/64 module detects a loss of data transitions on the V.35 interface. If **NET/DATA FAIL** is selected, the V.35 Nx **INBAND** option must be **ON**. The remote TSU inband must also be enabled.

NET FAIL: DBU is initiated when there is a network failure. Possible causes include LOS, Red, Yellow, or Blue alarms.

MANUAL: The ATLAS 550 will never initiate DBU until it is manually initiated.

- **RESTORE CRITERIA**

MANUAL: The primary link is restored only on manual command. This is the only option when **NET/DATA FAIL** is selected for the Backup Criteria parameter.

NET SUCCESS: The primary link is restored when the network alarm clears.

- **STARTUP DELAY**

Length of time (in seconds) that determines how long to wait before implementing the DBU capabilities after being configured.

- **BACKUP DELAY**

Length of time (in seconds) that determines how long the T1 must be in a fail state before dial backup will take affect.

- **RESTORE DELAY**

Length of time (in seconds) that determines how long the main circuit must be restored before dial back-up will switch off.

- **MAX NUMBER OF RETRIES**

Options are **NONE**, **3**, **10**, and **UNLIMITED**. This is the number of times the ATLAS 550 will redial if first DBU connection fails.

- **REDIAL TIMER**

Length of time (in seconds) that determines how long to wait before retry.

- **ENABLE SCHEDULE**

This option will take you to a different screen where you can configure times that you will allow or not allow the ATLAS 550 to go into DBU mode.

- **TEST CALL**

Options include **HOURLY**, **DAILY**, **WEEKLY**, **BI-WEEKLY**, or **MANUAL ONLY**. The ATLAS 550 can be set to automatically place a DBU test call at any one of these times. If you do not wish for the ATLAS 550 to use this feature, select **MANUAL ONLY**.

- **MIN DS0s**

Specifies the minimum number of DS0s to use for DBU. This option should be set to 1 unless you are trying to place a bonded call. Bonding requires that the BONDing Module be installed in the ATLAS 550.

- **MAX DS0s**

Specifies the maximum number of DS0s to use for DBU. The valid range for this field is 1-32.

SYSTEM EVENT LOGGING

The ATLAS 550 Event Log is used to log various message types at settable threshold levels. This section describes the entries that may be logged by the system event log. The Event Log's **CATEGORY** is particularly important – this is the minimum severity level that must be set in order that the event be logged.



*Use caution when changing **CATEGORY** values from their default levels. If too many sources have their **CATEGORY** values set too low, the number of messages being logged in a given period can be very large. If too many messages are being logged too rapidly, system performance can be adversely affected.*

The Event Log is a useful tool for troubleshooting switchboard (or call connection) activities including the viewing of digits received, digits transferred, and ISDN Messages. Since most of the events discussed in the following tables are used primarily during troubleshooting, they should be turned off in normal operation.

CONTENTS

Setting the Event Log Category	370
Viewing the Events	372
System Events	373
ISDN Cause Codes	379
Cause Code Log Entries	381

TABLES

Table 1. System Controller Events	373
Table 2. Switchboard Events	374
Table 3. Nx 56/64 Events	374
Table 4. T1 Events	375
Table 5. Ethernet Events	376
Table 6. ISDN Events	377
Table 7. Circuit Backup Events	378
Table 8. DP Outgoing Signaling Events	379
Table 9. Modem Management Module Events	379
Table 10. ISDN Cause Code Events	379
Table 11. Cause Code Log Entry Location Designations	381
Table 12. ISDN L2 Messages	381
Table 13. ISDN Call Control Messages	381
Table 14. Source: ISDN Information Elements	381

1. SETTING THE EVENT LOG CATEGORY

The following steps outline the procedure for setting up the event **CATEGORY** thresholds for the Event Log.

1. From the **MAIN MENU**, go to the **SYSTEM CONFIG** menu and press the right arrow key to enter the right-pane menus.

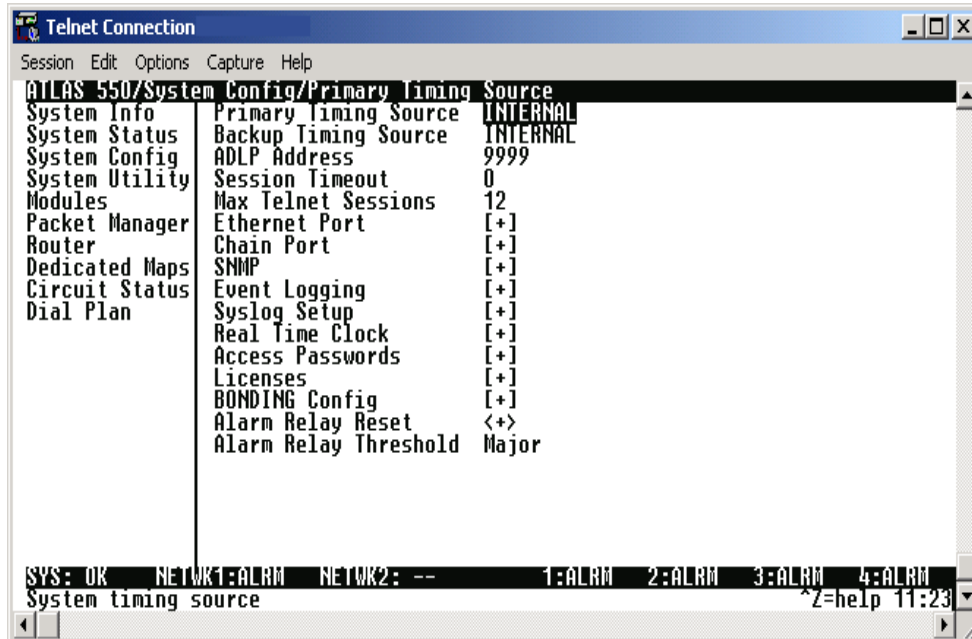

2. Select the **EVENT LOGGING** field and press <Enter>. Once in the **EVENT LOGGING** menus, press the right arrow key to access the right-pane menus.

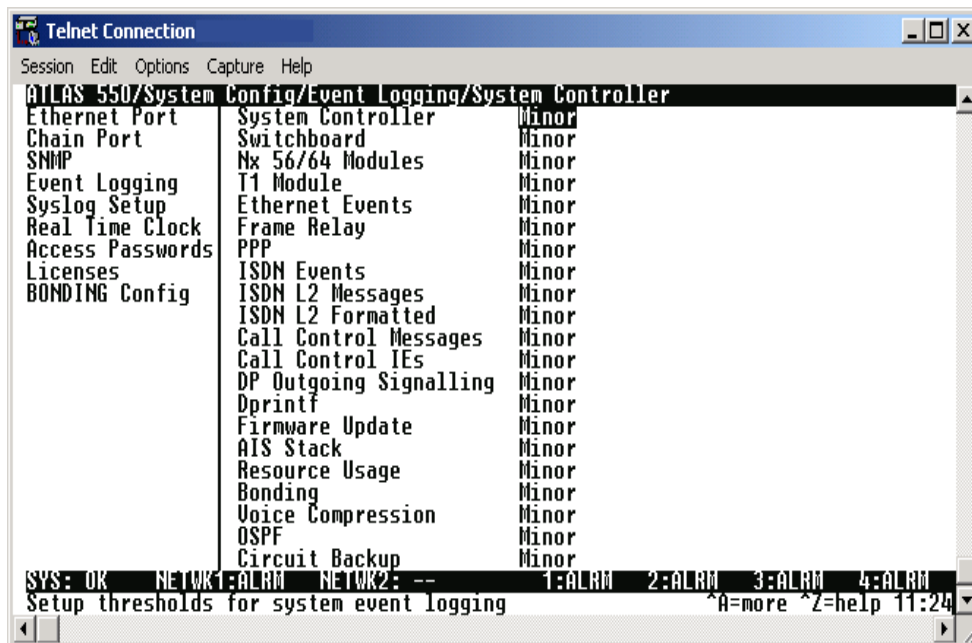

3. Refer to the tables in this section to determine the desired **CATEGORY** thresholds.
4. To change the **CATEGORY**, select the appropriate field and press <Enter>. This will provide a list of available options. Highlight the desired threshold and press <Enter> to select it. Viewing the

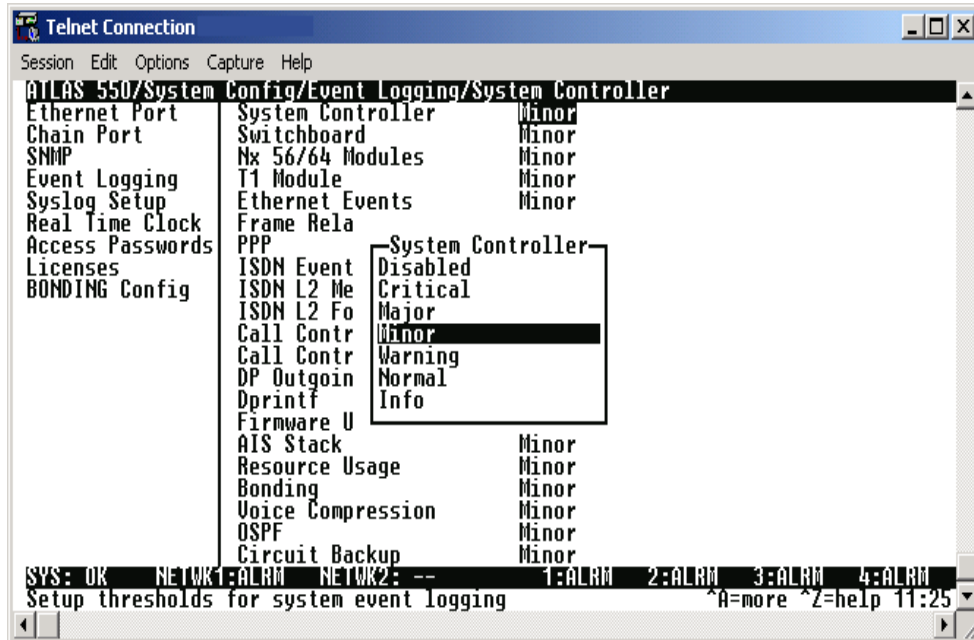

 **CAUTION** Use caution when changing **CATEGORY** values from their default levels. If too many sources have their **CATEGORY** values set too low, the number of messages being logged in a given period can be very large. If too many messages are being logged too rapidly, system performance can be adversely affected.

2. VIEWING THE EVENTS

The following steps outline the procedure for viewing **EVENT LOG** messages.

1. From the **MAIN MENU**, go to the **SYSTEM STATUS** menu and press the right arrow key to enter the right-pane menus.

The screenshot shows a Telnet connection window titled "Telnet Connection" with a menu for "ATLAS 550/System Status/Event Log". The menu items are:

```

Event Log [10 entries]
Clear System Event Log <+>
Clear System LED <+>
Ethernet Port [+]
Chain Port [+]
System Temperature Alarms >70 C [-] >85 C [-]
System Power Alarms -58 U [-] -24 U [-]
System Timing Source PRIMARY : Locked
Resource Usage [+]
Trunk Usage [+]
  
```

At the bottom of the window, there is a status bar with the text: "SYS: OK NETWORK1:ALARM NETWORK2: -- 1:ALARM 2:ALARM 3:ALARM 4:ALARM View the System Event Log ^Z=help 11:26".

2. Select the **EVENT LOG** field and press <Enter>. Once in the **EVENT LOG**, press the right arrow key to access the actual messages.

The screenshot shows the same Telnet connection window, but now displaying the event log messages. The menu items are:

```

Event Log [09/06 11:27:50]
Ethernet Port 09/06 11:27:50 Min Syste S1t1 Module Not Responding
Chain Port 09/06 11:27:47 Min Syste Ntw2 Module Not Responding
Resource Usage
Trunk Usage
  
```

At the bottom of the window, the status bar shows: "SYS: OK NETWORK1:ALARM NETWORK2: -- 1:ALARM 2:ALARM 3:ALARM 4:ALARM ^Z=help 11:27".



The **EVENT LOG** messages are stored in a first-in/first-out table. Therefore, the most recent log entry is found at the top of the log.



EVENT LOG messages may be sent to an external Syslog server for storage. Refer to DLP-013, "Using the ADTRAN Utility Syslog with the ATLAS 550" for more details.

3. SYSTEM EVENTS

The following tables provide a listing of ATLAS system events. This includes tables of events for each category, according to the order they appear in the **EVENT LOG** setup screen.

Table 1. System Controller Events

Console Log String	Category	Event
"-24 V Power Failure Cleared"	CRITICAL	-24 V power supply is functioning normally again
"-24 V Power Failure"	CRITICAL	-24 V power supply is not operating properly
"-58 V Power Failure Cleared"	CRITICAL	-58 V power supply is functioning normally again
"-58 V Power Failure"	CRITICAL	-58 V power supply is not operating properly
>70 Internal Temperature Warning Cleared	CRITICAL	Internal system temperature has cooled below 70° C
>85 Internal Temperature Warning Cleared	CRITICAL	Internal system temperature has cooled below 85° C
>70C Internal Temperature Warning	CRITICAL	Internal system temperature is greater than 70° C
>85C Internal Temperature Warning	CRITICAL	Internal system temperature is greater than 85° C
Firmware invalid	CRITICAL	Corrupted firmware
Firmware update failed	CRITICAL	Flash download failed
System Configuration Uploaded	CRITICAL	ATLAS configuration file loaded into the system and activated
Module Not Responding	WARNING	Module removed or not responding
ACO Switch pressed	MINOR	ACO switch pressed
External Alarm Detected	MINOR	Alarm detected on External Alarm Monitor
Login Failure	MINOR	Console login failure ¹
External Alarm Cleared	MINOR	External alarm cleared
Timing source changed to Internal	MINOR	Neither the primary nor the backup are valid
Timing source changed to Backup	MINOR	The primary source is not Backup valid
Timing source changed to Primary	MINOR	The timing source changed to primary
Not responding to programming	MINOR	Unable to program module

Table 1. System Controller Events (Continued)

Console Log String	Category	Event
Cold	NORMAL	System cold start ²
Firmware update completed	INFO	Flash download successful
Module Found	INFO	Module found
SNMP Authentication Failure	INFO	SNMP authentication failure ³

- 1 Three consecutive logins were attempted and failed.
- 2 Generated five seconds after the completion of system initialization.
- 3 Generated if the ATLAS receives an SNMP request from an SNMP manager defined in the ATLAS SNMP communities list but with a community name that does not match the community name defined in the SNMP communities list.

Table 2. Switchboard Events

Console Log String	Category	Event
<number> rejected: No such number	WARNING	Call rejected ¹
<number> rejected: Outgoing reject list	NORMAL	Call rejected ²
<number> rejected: Busy	NORMAL	Call rejected ³
<number> accepted: <slot> <port>	NORMAL	Call successfully routed

- 1 No such number in dial plan.
- 2 Number is on outgoing reject list.
- 3 All endpoints busy.

Table 3. Nx 56/64 Events

Console Log String	Category	Event
Nx 56/64 511 Test Pattern Active	WARNING	511 Test Pattern Activated
Nx 56/64 511 Test Pattern Cleared	WARNING	511 Test Pattern Deactivated
Nx 56/64 Bilateral Loopback Active	WARNING	Bilateral Loopback Activated
Nx 56/64 Bilateral Loopback Cleared	WARNING	Bilateral Loopback Deactivated
Nx 56/64 Excessive Zeros Alarm	WARNING	Excessive Zeros from DTE
Nx 56/64 Excessive Zeros Alarm Cleared	WARNING	Excessive Zeros condition cleared
Nx 56/64 Clock Slip Alarm Active	MAJOR	Clock Slip Alarm Active
Nx 56/64 Clock Slip Alarm Cleared	MAJOR	Clock Slip Alarm Cleared
Nx 56/64 External Clock Alarm Active	MAJOR	External Clock Alarm

Table 3. Nx 56/64 Events (Continued)

Console Log String	Category	Event
Nx 56/64 External Clock Alarm Cleared	MAJOR	External Clock Alarm Cleared
Nx 56/64 PLL Alarm Active	MAJOR	PLL Alarm Active
Nx 56/64 PLL Alarm Cleared	MAJOR	PLL Alarm Cleared
Nx 56/64 CTS Asserted	INFO	CTS Asserted
Nx 56/64 CTS Dropped	INFO	CTS Dropped
Nx 56/64 DCD Asserted	INFO	DCD Asserted
Nx 56/64 DCD Dropped	INFO	DCD Dropped
Nx 56/64 DTR Asserted	INFO	DTR Asserted
Nx 56/64 DTR Dropped	INFO	DTR Dropped
Nx 56/64 RTS Asserted	INFO	RTS Asserted
Nx 56/64 RTS Dropped	INFO	RTS Dropped

Table 4. T1 Events

Console Log String	Category	Event
T1 Curr CSS Thrs Exceeded	WARNING	Current T1 Controlled Slip Seconds Threshold Exceeded
T1 Curr ES Thrs Exceeded	WARNING	Current T1 Errored Seconds Threshold Exceeded
T1 Curr LCV Thrs Exceeded	WARNING	Current T1 Line Code Violations Threshold Exceeded
T1 Curr LES Thrs Exceeded	WARNING	Current T1 Line Errored Seconds Threshold Exceeded
T1 Curr PCV Thrs Exceeded	WARNING	Current T1 Path Code Violations Threshold Exceeded
T1 Curr SEFS Thrs Exceeded	WARNING	Current T1 Severely Errored Framing Seconds Threshold Exceeded
T1 Curr SES Thrs Exceeded	WARNING	Current T1 Severely Errored Seconds Threshold Exceeded
T1 Curr UAS Thrs Exceeded	WARNING	Current T1 Unavailable Seconds Threshold Exceeded
T1 Line Loopback Active	WARNING	Line Loopback Active
T1 Loopback Cleared	WARNING	Loopback Cleared
T1 Payload Loopback Active	WARNING	Payload Loopback Active
T1 Total CSS Thrs Exceeded	WARNING	Total T1 Controlled Slip Seconds Threshold Exceeded

Table 4. T1 Events (Continued)

Console Log String	Category	Event
T1 Tot ES Thrs Exceeded	WARNING	Total T1 Errored Seconds Threshold Exceeded
T1 Total LCV Thrs Exceeded	WARNING	Total T1 Line Code Violations Threshold Exceeded
T1 Total LES Thrs Exceeded	WARNING	Total T1 Line Errored Seconds Threshold Exceeded
T1 Total PCV Thrs Exceeded	WARNING	Total T1 Path Code Violations Threshold Exceeded
T1 Total SEFS Thrs Exceeded	WARNING	Total T1 Severely Errored Framing Seconds Threshold Exceeded
T1 Total SES Thrs Exceeded	WARNING	Total T1 Severely Errored Seconds Threshold Exceeded
T1 Total UAS Thrs Exceeded	WARNING	Total T1 Unavailable Seconds Threshold Exceeded
T1 Blue Alarm Cleared	MAJOR	Blue Alarm Cleared
T1 Blue Alarm Active	MAJOR	Blue Alarm Set
T1 D Channel Alarm Cleared	MAJOR	D Channel Alarm Cleared
T1 D Channel Alarm Active	MAJOR	D Channel Alarm Set
T1 LOS Cleared	MAJOR	LOS Alarm Cleared
T1 LOS Active	MAJOR	LOS Alarm Set
T1 Red Alarm Cleared	MAJOR	Red Alarm Cleared
T1 Red Alarm Active	MAJOR	Red Alarm Set
T1 Tx Blue Alarm Cleared	MAJOR	Tx Blue Alarm Cleared
T1 Tx Blue Alarm Active	MAJOR	Tx Blue Alarm Set
T1 Tx Yellow Alarm Cleared	MAJOR	Tx Yellow Alarm Cleared
T1 Tx Yellow Alarm Active	MAJOR	Tx Yellow Alarm Set
T1 Yellow Alarm Cleared	MAJOR	Yellow Alarm Cleared
T1 Yellow Alarm Active	MAJOR	Yellow Alarm Set

Table 5. Ethernet Events

Console Log String	Category	Event
Out of memory	CRITICAL	Not enough memory for Ethernet driver

Table 6. ISDN Events

Console Log String	Category	Event
BRI configuration failed: No ISDN resources are available	CRITICAL	No BRI resources available
PRI configuration failed: No ISDN resources are available	CRITICAL	No PRI resources available
No SPID matches the call profile: <called number> <call type>	WARNING	No Matching SPID found
No SPID with free B channels matches call type: <call type>	WARNING	No Matching SPID found
LT: Tried to call unregistered SPID <spid>	WARNING	SPID Unregistration attempted
D channel is DOWN	MAJOR	D Channel Down
<message>: Incorrectly formatted cause IE	MAJOR	Incorrectly formatted IE
BRI NT: Spid <spid> was rejected	MAJOR	SPID Failed
BRI NT: SPID Negotiations failed - resetting the link	MAJOR	SPID Negotiation failed
BRI LT: SPID <spid> received - NOT IN LIST	MAJOR	Unknown SPID received
BRI NT: SPID Negotiations failed - Retrying	MINOR	SPID Retry in progress
Configured BRI as LT	NORMAL	BRI LT configuration successful
Configured BRI as NT	NORMAL	BRI NT configuration successful
Rejected an incoming call for an unregistered SPID	NORMAL	Call Rejected
D channel is UP	NORMAL	D Channel Up
Released: No longer an ISDN line	NORMAL	ISDN line released
No outgoing B channel available for call to <number>	NORMAL	No B channels for call
Configured PRI as central office emulator	NORMAL	PRI CO configuration successful
Configured PRI as CPE	NORMAL	PRI CPE configuration successful
BRI NT: Spid <spid> registered	NORMAL	SPID registered
BRI LT: All SPIDs registered	NORMAL	SPID Registration complete
BRI NT: All SPIDs registered	NORMAL	SPID Registration complete
BRI LT: Registering SPID <spid>	NORMAL	SPID Registration in progress
BRI NT Registering SPID <spid>	NORMAL	SPID Registration in progress
Call to <called number> declared busy after leaving ATLAS	INFO	Call busy
Call to <called number> refused: Busy	INFO	Call busy

Table 6. ISDN Events (Continued)

Console Log String	Category	Event
Call to <called number> cleared from ATLAS end	INFO	Call cleared
Call to <called number> connected	INFO	Call connected
Call to <called number> disconnected by far end	INFO	Call disconnected
Call not accepted to <called number>: No channel available	INFO	Call not accepted
Call to ATLAS: <called number> received	INFO	Call received
Call to <called number> ringing	INFO	Call ringing
Dialing <called number>	INFO	Dialing number
Incoming call to <called number> accepted	INFO	Incoming call accepted
Incoming call to <called number> refused	INFO	Incoming call refused

Table 7. Circuit Backup Events

Console Log String	Category	Event
Circuit Backup Attempt Failed	MAJOR	Outgoing backup call was unsuccessful
Circuit Backup Test Call Failed	MAJOR	Outgoing backup test call was unsuccessful
Attempting Circuit Backup	MINOR	Circuit Backup call attempted to restore data circuit
Circuit Backup Active	MINOR	Port is currently in backup
Circuit Backup Deactivated, Primary Restored	MINOR	Port was in backup, but primary data function was restored
Circuit Backup Data Alarm Active	MINOR	Inband keep alive messages were disrupted or corrupted
Circuit Backup Data Alarm Cleared	MINOR	Inband keep alive messages are functioning properly
Circuit Backup Test Call Originated	INFO	Circuit Backup test call was attempted by the unit
Circuit Backup Test Call Connected	INFO	Circuit Backup test call was successfully connected to backup site
Circuit Backup Test Call Passed	INFO	Circuit Backup test call was successfully maintained for test period

Table 8. DP Outgoing Signaling Events

Console Log String	Category	Event
TX Set Rx ABCD < > Tx ABCD < > ¹	INFO	ATLAS changed signal bits on port
RX Change Rx ABCD < > Tx ABCD < >	INFO	Equipment connected to port changed signal bits

- 1 The ATLAS 550 uses only AB signaling bits. The CD signaling bits are a copy of the AB values. These values are shown in hexadecimal notation. For example, if AB signal bits are 01, then the total signal bits would be 01 01. Putting that in hexadecimal notation results in an event of Tx set Rx ABCD 0x 05.

Table 9. Modem Management Module Events

Console Log String	Category	Event
Modem Management Call Answered	INFO	Incoming call was successfully answered by the Modem Management Module
Modem Management Call Ended	INFO	Active call to Modem Management Module was disconnected

4. ISDN CAUSE CODES

In addition to the above events, certain recognized ISDN cause codes are sent to the event log from the ISDN message facility during **ISDN EVENTS**, **L2 MESSAGES**, and **L2 FORMATTED** event categories. Table 10 lists the codes applicable to the ATLAS 550 and the minimum category required for logging the cause code event.

Table 10. ISDN Cause Code Events

Cause Code Event	Category	Code
ACCESS_INFO_DISCARDED	WARNING	43
BAD_INFO_ELEM	MAJOR	99
BEAR_CAP_NOT_AVAIL	MINOR	58
CALL_REJECTED	INFO	21
CAP_NOT_IMPLEMENTED	MINOR	65
CHAN_NOT_IMPLEMENTED	MINOR	66
CHANNEL_UNACCEPTABLE	INFO	6
DEST_OUT_OF_ORDER	INFO	27
FACILITY_NOT_IMPLEMENTED	MAJOR	69
FACILITY_NOT_SUBSCRIBED	MINOR	50
FACILITY_REJECTED	INFO	29
INCOMING_CALL_BARRED	MINOR	54

Table 10. ISDN Cause Code Events (Continued)

Cause Code Event	Category	Code
INCOMPATIBLE_DEST	MAJOR	88
INTERWORKING_UNSPEC	MAJOR	127
INVALID_CALL_REF	MAJOR	81
INVALID_ELEM_CONTENTS	MAJOR	100
INVALID_MSG_UNSPEC	MAJOR	95
INVALID_NUMBER_FORMAT	INFO	28
MANDATORY_IE_LEN_ERR	MAJOR	103
MANDATORY_IE_MISSING	MAJOR	96
NETWORK_CONGESTION	WARNING	42
NETWORK_OUT_OF_ORDER	WARNING	38
NO_CIRCUIT_AVAILABLE	WARNING	34
NO_ROUTE	INFO	2
NO_USER_RESPONDING	INFO	18
NONEXISTENT_MSG	MAJOR	97
NORMAL_CLEARING	INFO	16
NUMBER_CHANGED	INFO	22
OUTGOING_CALL_BARRED	MINOR	52
PRE_EMPTED	WARNING	45
PROTOCOL_ERROR	MAJOR	111
REQ_CHANNEL_NOT_AVAIL	WARNING	44
RESP_TO_STAT_ENQ	INFO	30
SERVICE_NOT_AVAIL	MINOR	63
TEMPORARY_FAILURE	WARNING	41
TIMER_EXPIRY	MAJOR	102
UNASSIGNED_NUMBER	INFO	1
UNSPECIFIED_CAUSE	INFO	31
USER_BUSY	INFO	17
WRONG_MESSAGE	INFO	98
WRONG_MSG_FOR_STATE	MAJOR	101

5. CAUSE CODE LOG ENTRIES

Cause Code IEs that are non-Q.931 (i.e., the Coding Standard field is not 0) are logged with the following format:

<message>: <coding standard> code <cause code>

The coding standard field is one of the following: **Reserved**, **National**, or **Local**. Each Cause Code IE log entry ends with a location designation. Table 11 shows these designations. Tables 12 through 14 provide a listing of system events.

Table 11. Cause Code Log Entry Location Designations

Code	Location
INOTL	International network
INWK	Network beyond internetworking point
LN	Public network serving the local user
LPN	Private network serving the local user
RLN	Public network serving the remote user
RPN	Private network serving the remote user
TN	Transit network
U	User

Table 12. ISDN L2 Messages

Console Log String	Category	Event
<message contents>	INFO	ISDN Layer 2 (LAPD) Message *

* Provides a hex dump of the entire LAPD frame.

Table 13. ISDN Call Control Messages

Console Log String	Category	Event
Host>>CC <tag><call ID> <message>	INFO	ISDN Call Control Messages
CC>>Host <tag><call ID> <message>	INFO	ISDN Call Control Messages

Table 14. Source: ISDN Information Elements

Console Log String	Category	Event
<message contents>	INFO	ISDN Information Element *

* Provides a hex dump of the ISDN IE sent with a call control message.

ADTRAN UTILITIES

ADTRAN delivers several PC software utilities along with the ATLAS 550. These utilities are located on the CD-ROM that came with your shipment.



Review the readme file (Readme.txt) for the latest information about the utilities.

The utilities make it easier to interface with the terminal menu and transfer configuration files to and from TFTP servers. The utilities all run on Microsoft Windows 3.1 or higher. The following sections describe the Telnet, VT100, and TFTP Server utilities.

CONTENTS

Telnet Utility	384
Session Menu	385
Edit Menu	386
Options Menu	386
Capture Menu	386
Help Menu	387
VT100 Utility	387
Session Menu	388
Edit Menu	389
Port Menu	389
Options Menu	389
Capture Menu	389
Help Menu	389
TFTP Server	390
Server Menu	391
Print Log	391
Help	391
Status Field	391
Meter Field	392
Log Field	392

FIGURES

Figure 1. Telnet Menu Tree	384
Figure 2. VT100 Menu Tree	388
Figure 3. TFTP Server Interface Menu Tree	390
Figure 4. TFTP Server Interface	390

1. TELNET UTILITY

The Telnet utility delivered with the ATLAS 550 provides enhancements to standard Telnet programs that make it easier to work with ATLAS 550 options.

Access the Telnet program remotely through the 10/100BaseT Ethernet port. For a detailed description of how to work with the Telnet program, refer to *Navigating the Terminal Menus* in the User Interface Guide section of this manual. If you need help setting up the ATLAS 550 for a Telnet session, refer to the Detailed Level Procedures section of this manual.

The Telnet menus include **SESSION**, **EDIT**, **OPTIONS**, **CAPTURE**, and **HELP** (see the menu tree in Figure 1).

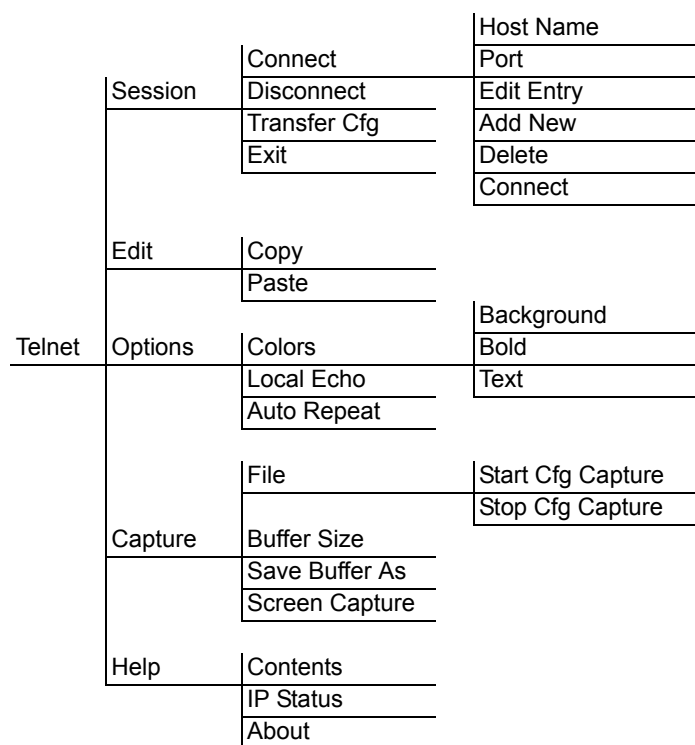

Figure 1. Telnet Menu Tree

Session Menu

Click on **SESSION** to open the Telnet session.

Connect

Opens dialog box for setting **HOST NAME** and **PORT** parameters for a Telnet session. Also lets you **EDIT ENTRY**, **ADD NEW** entry, and **DELETE** stored entries. When the parameters are set, click **CONNECT** to make the connection. Click **CANCEL** to end the session.

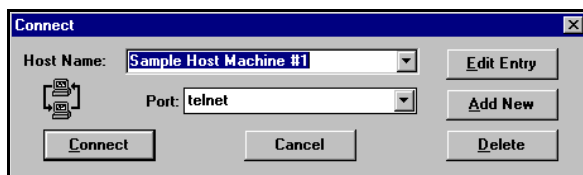

Host Name

Accepts and stores host names. You may either enter a descriptive name, an IP address, or a domain name directly from this field. Click on the drop-down arrow to display a complete list of previously stored host names.

PORT

Provides several port options. You may enter port numbers directly into this field to connect to non-standard ports or select the drop-down combo-box to display the following options:

TELNET	establishes a Telnet session
ECHO	provides a loopback for troubleshooting
DISCARD	bit bucket; discards data
DAYTIME	returns the time
CHARGEN	displays as a unique character stream; used for self-tests

Edit Entry

Changes either the unit name or the IP address of each host. Press **Tab**, **Return**, or a **period (.)** after each number in the IP address to move to the next field. If you press **Return** or **(.)** while the cursor is located in each IP field, the next field is cleared and the cursor advances into it.

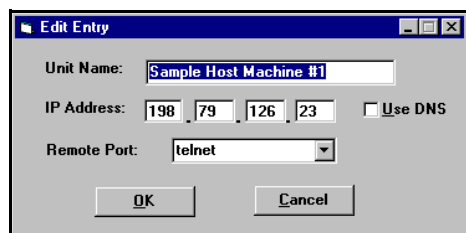

Add New

Prompts you for the same information as the **EDIT ENTRY** dialog box for new host. When enabled, the **USE DNS** (Domain Name Server) feature allows users to request **DOMAIN LOOK UP** via a DNS server on the network, rather than specifying an IP address. The name then appears in the **HOST NAME** field.

Delete

Removes a host name from the list; select the host name to remove, and click **DELETE** at the prompt.

Connect

Establishes the Telnet session.

Disconnect

Terminates the Telnet session.

To re-establish the session, select **CONNECT** from **SESSION MENU** or press **ENTER** three times. This action restores the previous connection.

Transfer Cfg

This feature is used with ADTRAN products primarily for sending configuration files to the unit.

Exit

Ends the Telnet session and closes the Telnet screen.

Edit Menu

Provides **COPY** and **PASTE** commands.

Options Menu

Provides viewing alternatives for the terminal screen.

Colors

Three options change the color of the background window (**BACKGROUND**), bold highlights (**BOLD**), and text (**TEXT**).

Local Echo

Echoes each character that you enter.

Auto Repeat

Repeats characters you select from the keyboard, if you hold down the key.

Capture Menu

Provides options for capturing screen images.

File

Sends screen options data to a file in the format options listed below:

Start Cfg Capture

Used with the ADTRAN product line to start sending the scrolling screen capture to a file storage location.

Stop Cfg Capture

Used with the ADTRAN product line to stop sending the scrolling screen capture to a file storage location.

Buffer Size

Disables terminal window scroll bars when set to zero. (This is the normal setting for ATLAS 550.) This number represents the number of lines to capture in the memory buffer.

Save Buffer As

Save screen capture to a file.

Screen Capture

Copies the text on the current Telnet screen to the clipboard. You can open any word processor and paste the clipboard contents into the program. This option is helpful when debugging.

Help Menu

Provides on-line help for using the ADTRAN Utilities.

Contents

Opens the on-line help.

IP Status

Displays the local port address and the status of the connection.

About

Displays version and owner information.

2. VT100 UTILITY

Use the VT100 to configure an ATLAS 550 which is directly connected to a PC. The VT100 display is almost identical to the Telnet display.

For a detailed description of how to work within the terminal menu, refer to *Navigating the Terminal Menus* in the User Interface Guide section of this manual. If you need help setting up the ATLAS 550 for a VT100 session, refer to the Detailed Level Procedures section of this manual.

VT100 menus include **SESSION**, **EDIT**, **PORT**, **OPTIONS**, **CAPTURE**, and **HELP** (see the menu tree in Figure 2).

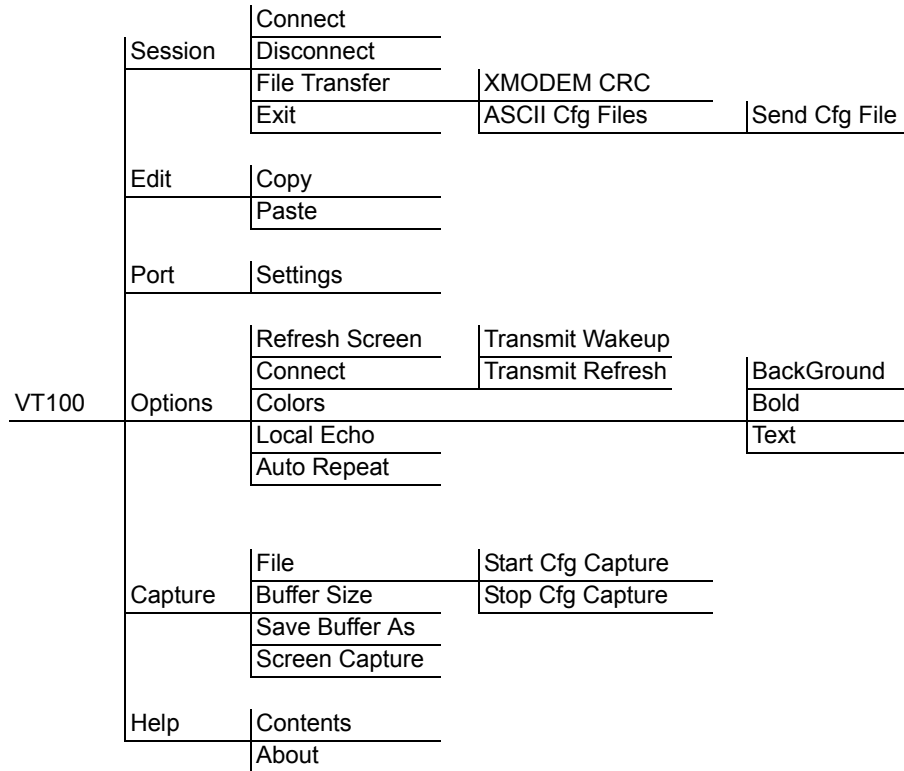

Figure 2. VT100 Menu Tree

Session Menu

Opens VT100 terminal emulation session.

Connect

Opens a specified serial port for a VT100 session.

Disconnect

Closes a specified serial port at the end of a VT100 session.

File Transfer

Uploads and downloads files to and from an ATLAS 550.

XMODEM CRC

Selects the XMODEM file transfer protocol.

ASCII Cfg Files

Selects ASCII transfer mode. Primarily useful for configuration transfers for the ADTRAN products.

Edit Menu

Identical to the Telnet **EDIT MENU** (see *Edit Menu* on page 394).

Port Menu

Changes serial COM port **SETTINGS**. Provides data rate settings from 300—57600 bps.

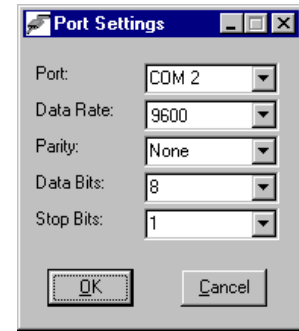

Options Menu

Provides terminal screen commands.

Refresh Screen

Redraws the screen.

Connect

Provides the options **TRANSMIT WAKEUP** and **TRANSMIT REFRESH**.

Transmit Wakeup

Provides a control sequence that puts the ATLAS 550 Control Port online in terminal mode.

Transmit Refresh

Provides a control sequence to refresh the screen automatically when connecting. (This is the default setting for the ATLAS 550.)

Colors

Identical to Telnet **COLORS MENU** (see *Colors* on page 394).

Local Echo

Echoes each character that you enter.

Auto Repeat

Repeats characters you select from the keyboard if you hold down the key.

Capture Menu

Identical to the Telnet **CAPTURE MENU** (see *Capture Menu* on page 394).

Help Menu

Provides on-line help and information about the version number.

Contents

Opens on-line help.

About

Displays version and owner information.

3. TFTP SERVER

The TFTP Server utility transfers ATLAS 550 configuration files to and from a TFTP server. You can install this program on a PC running any version of Microsoft Windows. The configuration of an ATLAS 550 can be saved offline as a backup file. The saved file may also be used to send the same configuration to multiple ATLAS 550 units. Transfer configuration files using the TFTP protocol (a TCP/IP user protocol) via the 10/100BaseT Ethernet port. The ATLAS 550 must have a valid IP address, subnet mask, and default gateway (if required), and be connected to an Ethernet network before proceeding. Figure 4 shows the TFTP server interface. For information on transferring and saving configurations using TFTP, refer to the Detailed Level Procedures section of this manual.



Files must be placed in the Application directory where you installed the product. Received files are also placed here.

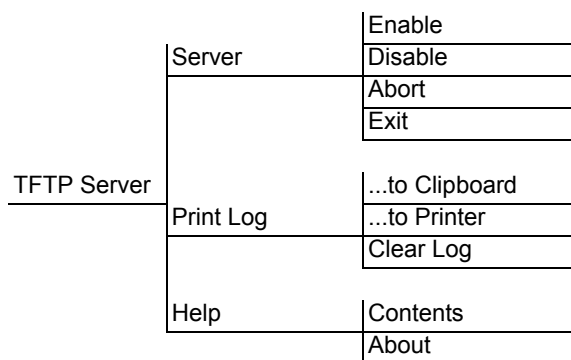

Figure 3. TFTP Server Interface Menu Tree

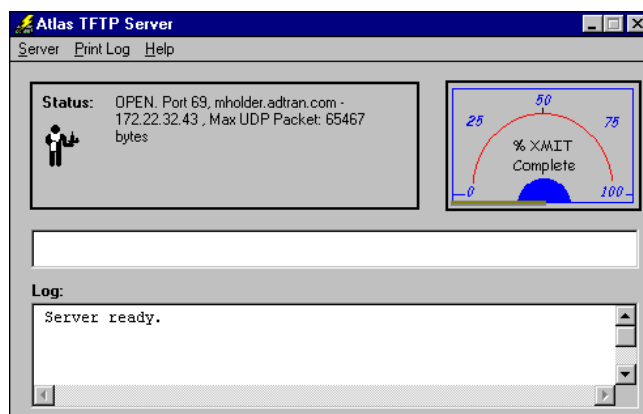

Figure 4. TFTP Server Interface

Only one configuration transfer session (upload or download) may be active at a time. The TCP/IP parameters are not saved or overwritten as part of an ATLAS 550 unit's transferred configuration to allow sending identical configurations to multiple units. When you start this program, a port is automatically opened.

Server Menu

Provides enable, disable, abort, and exit options.

Enable

Enables the TFTP server. The IP address displays in the Status field and Server Ready displays in the Log field.

Disable

Disables the TFTP server. When you select this option, the message PORT CLOSED displays in the Status field and Port Closed displays in the Log field.

Abort

Terminates a transfer that is in progress.

Exit

Terminates active transfers and closes the TFTP window.

Print Log

Provides print options.

...to Clipboard

Copies the information in the Log field to the clipboard. You can then open any word processor and paste the information into the program for review.

...to Printer

Sends the information in the Log field to the default printer.

Clear Log

Deletes the information stored in the Log field.

Help

Provides on-line help and version information.

Contents

Opens on-line help.

About

Displays version and owner information.

Status Field

This field displays general information about port and transfer status. This field is read-only. The unlabeled field in the center of the screen displays prompts about the status of active transfers, such as bytes transferred and received.

Meter Field

The **XMIT** meter provides a visual record of the transfer process.

Log Field

This field displays a record of all of the events that occur during the time the TFTP Server is enabled. Use the scroll bar to move up and down the list. To clear the information in this field, select **CLEAR LOG** from the **PRINT LOG** menu. Save this information to a file before deleting it with the **...TO CLIPBOARD** command.

MIB

This section provides a listing of SNMP Management Information Bases (MIBs) supported by the ATLAS 550. Traps supported for each MIB are also listed.

CONTENTS

MIBs SUPPORTED BY THE ATLAS 550	394
MIB Compilation Order	395
Traps Supported by the ATLAS 550	395
MIB Variables Supported by the ATLAS 550	398

1. MIBs SUPPORTED BY THE ATLAS 550

rfc1213.mib	(Standard - MIB-II)
rfc1406.mib	(Standard - DS1 and E1 Interface Types)
rfc1315.mib	(Standard - Frame Relay DTEs)
adtran.mib	(Adtran)
ads1.mib	(Adtran)
fperform.mib	(Adtran)
atproduc.mib	(Atlas)
atunit.mib	(Atlas - Unit)
atmod.mib	(Atlas - Module)
atv35nx.mib	(Atlas - Interface)
atbri.mib	(Atlas - Interface)
att1.mib	(Atlas - Interface)
atvoice.mib	(Atlas - Interface)
athssv35.mib	(Atlas - Interface)
at550.mib	(Atlas - Product Specific - Atlas 550)
atqbriu.mib	(Atlas - Product Specific - Quad BRI-U Option Module)

*Also need RFC1155-SMI, RFC1158-MIB, RFC-1212, and RFC-1215, which should come standard with any SNMP Management software package.

2. MIB COMPILATION ORDER

RFC1155-SMI (if necessary)

RFC1158-MIB (if necessary)

RFC-1212 (if necessary)

RFC-1215 (if necessary)

rfc1213.mib

rfc1406.mib

rfc1315.mib

adtran.mib

ads1.mib

fperform.mib

atproduc.mib

atunit.mib

atmod.mib

atv35nx.mib

atbri.mib

att1.mib

atvoice.mib

athssv35.mib

at550.mib

atqbriu.mib

3. TRAPS SUPPORTED BY THE ATLAS 550

rfc1215.mib	coldStart warmStart linkDown linkUp authenticationFailure
-------------	---

rfc1315.mib	frDLCIStatusChange
atunit.mib	adATLASFrSwToBkup -- 15400500 adATLASFrSwToPrimary -- 15400501
atmod.mib	adATLASModuleOffline -- 15400600 adATLASModuleOnline -- 15400601 adATLASCbuBackupAttempt -- 15400602 adATLASCbuBackupAttemptFailed -- 15400603 adATLASCbuBackupActive -- 15400604 adATLASCbuPrimaryRestored -- 15400605 adATLASCbuTestCallOriginated -- 15400606 adATLASCbuTestCallConnected -- 15400607 adATLASCbuTestCallPassed -- 15400608 adATLASCbuTestCallFailed -- 15400609
atv35nx.mib	adATLASV35NxSlipAlarmActive -- 15400700 adATLASV35NxSlipAlarmInactive -- 15400701 adATLASV35NxPLLAlarmActive -- 15400702 adATLASV35NxPLLAlarmInactive -- 15400703 adATLASV35NxZeroAlarmActive -- 15400704 adATLASV35NxZeroAlarmInactive -- 15400705 adATLASV35NxExtClkAlarmActive -- 15400706 adATLASV35NxExtClkAlarmInactive -- 15400707 adATLASV35NxRTSActive -- 15400708 adATLASV35NxRTSInactive -- 15400709 adATLASV35NxCTSActive -- 15400710 adATLASV35NxCTSInactive -- 15400711 adATLASV35NxDTRActive -- 15400712 adATLASV35NxDTRInactive -- 15400713 adATLASV35NxDSRActive -- 15400714 adATLASV35NxDSRInactive -- 15400715 adATLASV35NxDCDActive -- 15400716 adATLASV35NxDCDInactive -- 15400717

atv35nx.mib (cont.)	adATLASV35NxRIActive -- 15400718 adATLASV35NxRIInactive -- 15400719 adATLASV35NxTDAActive -- 15400720 adATLASV35NxTDInactive -- 15400721 adATLASV35NxRDActive -- 15400722 adATLASV35NxRDInactive -- 15400723 adATLASV35NxECAActive -- 15400724 adATLASV35NxECInactive -- 15400725
att1.mib	adATLAST1RxYellowActive -- 15400900 adATLAST1RxYellowInactive -- 15400901 adATLAST1RxAISActive -- 15400902 adATLAST1RxAISInactive -- 15400903 adATLAST1RedAlarmActive -- 15400904 adATLAST1RedAlarmInactive -- 15400905 adATLAST1LOSActive -- 15400906 adATLAST1LOSInactive -- 15400907 adATLAST1TxAISActive -- 15400908 adATLAST1TxAISInactive -- 15400909 adATLAST1TxYellowActive -- 15400910 adATLAST1TxYellowInactive -- 15400911 adATLAST1CurrentES -- 15400912 adATLAST1CurrentSES -- 15400913 adATLAST1CurrentSEFS -- 15400914 adATLAST1CurrentUAS -- 15400915 adATLAST1CurrentCSS -- 15400916 adATLAST1CurrentPCV -- 15400917 adATLAST1CurrentLES -- 15400918 adATLAST1CurrentLCV -- 15400919 adATLAST1TotalES -- 15400920 adATLAST1TotalSES -- 15400921 adATLAST1TotalSEFS -- 15400922

att1.mib (cont.)	adATLAST1TotalUAS -- 15400923 adATLAST1TotalCSS -- 15400924 adATLAST1TotalPCV -- 15400925 adATLAST1TotalLES -- 15400926 adATLAST1TotalLCV -- 15400927
athssv35.mib	adATLASHSSIV35IfceDeact -- 15401100 adATLASHSSIV35IfceReact -- 15401101
at550.mib	adATLAS550ExtAlarmActive -- 21900 adATLAS550ExtAlarmInactive -- 21901

4. MIB VARIABLES SUPPORTED BY THE ATLAS 550



For the MIBS listed below and on the following pages, an asterisk () signifies that Write Access is not supported.*

rfc1213.mib

(1.3.6.1.2.1)

mib-2

system

sysDescr	DisplayString	RO
sysObjectID	Object Identifier	RO
sysUpTime	TimeTicks	RO
sysContact	DisplayString	RW
sysName	DisplayString	RW
sysLocation	DisplayString	RW
sysServices	Integer	RO

interfaces			
ifNumber	Integer		RO
ifTable			
ifEntry			
	ifIndex	Integer	RO
	ifDescr	DisplayString	RO
	ifType	Integer	RO
	ifMtu	Integer	RO
	ifSpeed	Gauge	RO
	ifPhysAddress	PhysAddress	RO
	ifAdminStatus	Integer	RW*
	ifOperStatus	Integer	RO
	ifInOctets	Counter	RO
	ifInUcastPkts	Counter	RO
	ifInNUcastPkts	Counter	RO
	ifInDiscards	Counter	RO
	ifInErrors	Counter	RO
	ifInUnknownProtos	Counter	RO
	ifOutOctets	Counter	RO
	ifOutNUcastPkts	Counter	RO
	ifOutDiscards	Counter	RO
	ifOutErrors	Counter	RO
	ifSpecific -- Object	Identifier	RO
ip			
ipForwarding	Integer		RW*
ipDefaultTTL	Integer		RW
ipInReceives	Counter		RO
ipInHdrErrors	Counter		RO
ipInAddrErrors	Counter		RO

ip (continued)

ipForwDatagrams	Counter	RO
ipInUnknownProtos	Counter	RO
ipInDiscards	Counter	RO
ipInDelivers	Counter	RO
ipOutRequests	Counter	RO
ipOutDiscards	Counter	RO
ipOutNoRoutes	Counter	RO
ipReasmTimeout	Integer	RO
ipReasmReqds	Counter	RO
ipReasmOKs	Counter	RO
ipReasmFails	Counter	RO
ipFragOKs	Counter	RO
ipFragFails	Counter	RO
ipFragCreates	Counter	RO

ipAddrTable

ipAddrEntry

ipAdEntAddr	IpAddress	RO
ipAdEntIfIndex	Integer	RO
ipAdEntNetMask	IpAddress	RO
ipAdEntBcastAddr	Integer	RO
ipAdEntReasmMaxSize	Integer	RO
ipRoutingDiscards	Counter	RO

icmp

icmpInMsgs	Counter	RO
icmpInErrors	Counter	RO
icmpInDestUnreachs	Counter	RO
icmpInTimeExcds	Counter	RO
icmpInParmProbs	Counter	RO

icmp (continued)

icmpInSrcQuenchs	Counter	RO
icmpInRedirects	Counter	RO
icmpInEchos	Counter	RO
icmpInEchoReps	Counter	RO
icmpInTimestamps	Counter	RO
icmpInTimestampReps	Counter	RO
icmpInAddrMasks	Counter	RO
icmpInAddrMaskReps	Counter	RO
icmpOutMsgs	Counter	RO
icmpOutErrors	Counter	RO
icmpOutDestUnreachs	Counter	RO
icmpOutTimeExcds	Counter	RO
icmpOutParmProbs	Counter	RO
icmpOutSrcQuenchs	Counter	RO
icmpOutRedirects	Counter	RO
icmpOutEchos	Counter	RO
icmpOutEchoReps	Counter	RO
icmpOutTimestamps	Counter	RO
icmpOutTimestampReps	Counter	RO
icmpOutAddrMasks	Counter	RO
icmpOutAddrMaskReps	Counter	RO
tcp		
tcpRtoAlgorithm	Integer	RO
tcpRtoMin	Integer	RO
tcpRtoMax	Integer	RO
tcpMaxConn	Integer	RO
tcpActiveOpens	Counter	RO
tcpPassiveOpens	Counter	RO

tcp (continued)			
tcpAttemptFails	Counter	RO	
tcpEstabResets	Counter	RO	
tcpCurrEstab	Gauge	RO	
tcpInSegs	Counter	RO	
tcpOutSegs	Counter	RO	
tcpRetransSegs	Counter	RO	
tcpConnTable			
tcpConnEntry			
	tcpConnState	Integer	RW
	tcpConnLocalAddress	IpAddress	RO
	tcpConnLocalPort	Integer	RO
	tcpConnRemAddress	IpAddress	RO
	tcpConnRemPort	Integer	RO
tcpInErrs	Counter	RO	
tcpOutRsts	Counter	RO	
udp			
	udpInDatagrams	Counter	RO
	udpNoPorts	Counter	RO
	udpInErrors	Counter	RO
	udpOutDatagrams	Counter	RO
udpTable			
udpEntry			
	udpLocalAddress	IpAddress	RO
	udpLocalPort	Integer	RO
transmission			
snmp			
	snmpInPkts	Counter	RO
	snmpOutPkts	Counter	RO
	snmpInBadVersions	Counter	RO

snmp (continued)

snmpInBadCommunityNames	Counter	RO
snmpInBadCommunityUses	Counter	RO
snmpInASNParseErrs	Counter	RO
snmpInTooBig	Counter	RO
snmpInNoSuchNames	Counter	RO
snmpInBadValues	Counter	RO
snmpInReadOnly	Counter	RO
snmpInGenErrs	Counter	RO
snmpInTotalReqVars	Counter	RO
snmpInTotalSetVars	Counter	RO
snmpInGetRequests	Counter	RO
snmpInGetNexts	Counter	RO
snmpInSetRequests	Counter	RO
snmpInSetRequests	Counter	RO
snmpInTraps	Counter	RO
snmpOutTooBig	Counter	RO
snmpOutNoSuchNames	Counter	RO
snmpOutBadValues	Counter	RO
snmpOutGenErrs	Counter	RO
snmpOutGetRequests	Counter	RO
snmpOutGetNexts	Counter	RO
snmpOutSetRequests	Counter	RO
snmpOutGetResponses	Counter	RO
snmpOutTraps	Counter	RO
snmpEnableAuthenTraps	Counter	RW

rfc1406.mib**(1.3.6.1.2.1.10.18)**

ds1

dsx1ConfigTable

dsx1ConfigEntry

dsx1LineIndex	Integer	RO
dsx1IfIndex	Integer	RO
dsx1TimeElapsed	Integer	RO
dsx1ValidIntervals	Integer	RO
dsx1LineType	Integer	RW
dsx1LineCoding	Integer	RW
dsx1SendCode	Integer	RW
dsx1CircuitIdentifier	DisplayString	RW
dsx1LoopbackConfig	Integer	RW
dsx1LineStatus	Integer	RO
dsx1SignalMode	Integer	RW*
dsx1TransmitClockSource	Integer	RW
dsx1Fdl	Integer	RW*

dsx1CurrentTable

dsx1CurrentEntry

dsx1CurrentIndex	Integer	RO
dsx1CurrentESs	Gauge	RO
dsx1CurrentSESs	Gauge	RO
dsx1CurrentSEFSs	Gauge	RO
dsx1CurrentUASs	Gauge	RO
dsx1CurrentCSSs	Gauge	RO
dsx1CurrentPCVs	Gauge	RO
dsx1CurrentLESs	Gauge	RO
dsx1CurrentBESs	Gauge	RO
dsx1CurrentLCVs	Gauge	RO

dsx1IntervalTable

dsx1IntervalEntry

dsx1IntervalIndex	Integer	RO
dsx1IntervalNumber	Integer	RO
dsx1IntervalESs	Gauge	RO
dsx1IntervalSESs	Gauge	RO
dsx1IntervalSEFSs	Gauge	RO
dsx1IntervalUASs	Gauge	RO
dsx1IntervalCSSs	Gauge	RO
dsx1IntervalPCVs	Gauge	RO
dsx1IntervalLESs	Gauge	RO
dsx1IntervalBESs	Gauge	RO
dsx1IntervalLCVs	Gauge	RO

dsx1TotalTable

dsx1TotalEntry

dsx1TotalIndex	Integer	RO
dsx1TotalESs	Gauge	RO
dsx1TotalSESs	Gauge	RO
dsx1TotalSEFSs	Gauge	RO
dsx1TotalUASs	Gauge	RO
dsx1TotalCSSs	Gauge	RO
dsx1TotalPCVs	Gauge	RO
dsx1TotalLESs	Gauge	RO
dsx1TotalBESs	Gauge	RO
dsx1TotalLCVs	Gauge	RO

dsx1FracTable

dsx1FracEntry

dsx1FracIndex	Integer	RO
dsx1FracNumber	Integer	RO
dsx1FracIfIndex	Integer	RW*

rfc1315.mib**(1.3.6.1.2.1.10.32)**

frame-relay

frDlcmiTable

frDlcmiEntry

frDlcmiIfIndex	Integer	RO
frDlcmiState	Integer	RW
frDlcmiAddress	Integer	RW*
frDlcmiAddressLen	Integer	RW*
frDlcmiPollingInterval	Integer	RW
frDlcmiFullEnquiryInterval	Integer	RW
frDlcmiErrorThreshold	Integer	RW
frDlcmiMonitoredEvents	Integer	RW
frDlcmiMaxSupportedVCs	Integer	RW*
frDlcmiMulticast	Integer	RW*

frCircuitTable

frCircuitEntry

frCircuitIfIndex	Integer	RO
frCircuitDlci	Integer	RO
frCircuitState	Integer	RW
frCircuitReceivedFECNs	Counter	RO
frCircuitReceivedBECNs	Counter	RO
frCircuitSentFrames	Counter	RO
frCircuitSentOctets	Counter	RO
frCircuitReceivedFrames	Counter	RO
frCircuitReceivedOctets	Counter	RO
frCircuitCommittedBurst	Integer	RW
frCircuitExcessBurst	Integer	RW
frCircuitThroughput	Integer	RW

frErrTable				
	frErrEntry			
		frErrIfIndex	Integer	RO
		frErrType	Integer	RO
frame-relay-globals				
	frTrapState	Integer	RW*	

adtran.mib**(1.3.6.1.4.1.664)**

adtr
an

	adProductInfo			
	adProdName	DisplayString		RO
	adProdPartNumber	DisplayString		RO
	adProdCLEIcode	DisplayString		RO
	adProdSerialNumber	DisplayString		RO
	adProdRevision	DisplayString		RO
	adProdSwVersion	DisplayString		RO
	adProdPhysAddress	PhysAddress		RO
	adMgmt			
	adAdmin			
	adPerform			
	adShared			
	adIdentity			
	adConformance			

ads1.mib**(1.3.6.1.4.1.664.2.3)**

adDS1AlarmTable

adDS1AlarmEntry

adDS1AlarmIndex	Integer	RO
adDS1AlarmEnable	Integer	RW
adDS1LineEvent	Integer	RO
adDS1LineArm	Integer	RW

adDS1AlertTable

adDS1AlertEntry

adDS1AlertIndex	Integer	RO
adDS1AlertEnable	Integer	RW
adDS1CurrentAlert	Integer	RO
adDS1TotalAlert	Integer	RO
adDS1CurrentArm	Integer	RW
adDS1TotalArm	Integer	RW

adDS1CurrentThreshold

adDS1CurrentThrsES	Integer	RW
adDS1CurrentThrsSES	Integer	RW
adDS1CurrentThrsSEFS	Integer	RW
adDS1CurrentThrsUAS	Integer	RW
adDS1CurrentThrsCSS	Integer	RW
adDS1CurrentThrsPCVsf	Integer	RW
adDS1CurrentThrsPCVesf	Integer	RW
adDS1CurrentThrsLES	Integer	RW
adDS1CurrentThrsLCV	Integer	RW

adDS1TotalThreshold

adDS1TotalThrsES	Integer	RW
adDS1TotalThrsSES	Integer	RW
adDS1TotalThrsSEFS	Integer	RW
adDS1TotalThrsSEFS	Integer	RW

adDS1TotalThreshold (continued)

adDS1TotalThrsCSS	Integer	RW
adDS1TotalThrsPCVsf	Integer	RW
adDS1TotalThrsPCVesf	Integer	RW
adDS1TotalThrsLES	Integer	RW
adDS1TotalThrsLCV	Integer	RW

atunit.mib**(1.3.6.1.4.1.664.2.154.1.5)**

adATLASUnitmg

adATLASUnitInfo

adATLASUnitIfNumber	Integer	RO
---------------------	---------	----

adATLASUnitPortInfoTable

adATLASUnitPortInfoEntry

adATLASUnitPortStatus	PortStatus	RO
adATLASUnitPortIfIndex	Integer	RO
adATLASUnitPortDescription	DisplayString	RO

adATLASUnitPortSlotMapTable

adATLASUnitPortSlotMapEntry

adATLASUnitSlotAddress	Integer	RO
adATLASUnitPortAddress	Integer	RO

adATLASUnitStatus

adATLASUnitFPStatus	Integer	RO
---------------------	---------	----

atmod.mib**(1.3.6.1.4.1.664.2.154.1.6)**

adATLASModulemg

adATLASModuleInfoNumber	Integer	RO
adATLASModuleInfoTable		
adATLASModuleInfoEntry		
adATLASModuleInfoIndex	Integer	RO
adATLASModuleInfoNumIfs	Integer	RO
adATLASModuleInfoNumRsrcs	Integer	RO
adATLASModuleInfoOID	Identifier	RO
adATLASModuleInfoPartNum	DisplayString	RO
adATLASModuleInfoSerialNum	DisplayString	RO
adATLASModuleInfoHardwareRev	DisplayString	RO
adATLASModuleInfoFirmwareRev	DisplayString	RO
adATLASModuleInfoState	Integer	RW
adATLASModuleInfoStatus	Integer	RO
adATLASModuleInfoFPStatus	Integer	RO

atv35nx.mib**(1.3.6.1.4.1.664.2.154.1.7)**

adATLASV35Nxmg

adATLASV35NxIfNumber	Integer	RO
adATLASV35NxIfTable		
adATLASV35NxIfEntry		
adATLASV35NxIfIndex	Integer	RO
adATLASV35NxIfSlotNum	Integer	RO
adATLASV35NxIfPortNum	Integer	RO
adATLASV35NxIfAlarmStatus	Integer	RO
adATLASV35NxIfDTEStatus	Integer	RO
adATLASV35NxIfDataRate	Gauge	RO
adATLASV35NxIfPLLFifoStatus	Integer	RO

adATLASV35NxIfInbandStatTable

adATLASV35NxIfInbandStatEntry

adATLASV35NxIfInbandStatIndex	Integer	RO
adATLASV35NxIfInbandStatRxFrames	Counter	RO
adATLASV35NxIfInbandStatTxFrames	Counter	RO
adATLASV35NxIfInbandStatRxBytes	Counter	RO
adATLASV35NxIfInbandStatTxBytes	Counter	RO
adATLASV35NxIfInbandStatReset	Integer	RW

adATLASV35NxTstTable

adATLASV35NxTstEntry

adATLASV35NxTstIndex	Integer	RO
adATLASV35NxTstLoopbk	Integer	RW
adATLASV35NxTstLoopbkStatus	Integer	RO
adATLASV35NxTst511Pattern	Integer	RW
adATLASV35NxTstPatternSync	Integer	RO
adATLASV35NxTstPatternESs	Counter	RO
adATLASV35NxTstInjectErrs	Integer	RW
adATLASV35NxTstClearRsIts	Integer	RW

atbri.mib**(1.3.6.1.4.1.664.2.154.1.8)**

adATLASBRIfmg

adATLASBRIfNumber	Integer	RO
-------------------	---------	----

adATLASBRIfTable

adATLASBRIfEntry

adATLASBRIfIndex	Integer	RO
adATLASBRIfSlotNum	Integer	RO
adATLASBRIfPortNum	Integer	RO
adATLASBRIfAlarmStatus	Integer	RO

adATLASBRIfChanStatTable

adATLASBRIfChanStatEntry

adATLASBRIfChanStatIndex	Integer	RO
adATLASBRIfChanStatB1	Integer	RO
adATLASBRIfChanStatB2	Integer	RO
adATLASBRIfChanStatD	Integer	RO

adATLASBRITstTable

adATLASBRITstEntry

adATLASBRITstIndex	Integer	RO
adATLASBRITstLLB	Integer	RW

att1.mib**(1.3.6.1.4.1.664.2.154.1.9)**

adATLAST1mg

adATLAST1IfNumber	Integer	RO
-------------------	---------	----

adATLAST1IfTable

adATLAST1IfEntry

adATLAST1IfIndex	Integer	RO
adATLAST1IfSlotNum	Integer	RO
adATLAST1IfPortNum	Integer	RO
adATLAST1IfAlarmStatus	Integer	RO
adATLAST1IfRxLevel	Integer	RO
adATLAST1IfPLLStatus	Integer	RO
adATLAST1IfCurrentLOFC	Gauge	RO
adATLAST1IfTotalLOFC	Gauge	RO
adATLAST1IfResetPRMStats	Integer	RW

adATLAST1IfIntervalTable

adATLAST1IfIntervalEntry

adATLAST1IfIntervalIndex	Integer	RO
adATLAST1IfIntervalLOFC	Gauge	RO

adATLAST1IfDS0Table

adATLAST1IfDS0Entry

adATLAST1IfDS0Index	Integer	RO
adATLAST1IfDS0Status	Octet String	RO
adATLAST1IfDS0Alarm	Octet String	RO
adATLAST1IfDS0RxSignalStatusA	Octet String	RO
adATLAST1IfDS0RxSignalStatusB	Octet String	RO
adATLAST1IfDS0TxSignalStatusA	Octet String	RO
adATLAST1IfDS0TxSignalStatusB	Octet String	RO

adATLAST1TstTable

adATLAST1TstEntry

adATLAST1TstIndex	Integer	RO
adATLAST1TstLocalLpBk	Integer	RW
adATLAST1TstRemoteLpBk	Integer	RW
adATLAST1TstLpBkStatus	Integer	RO
adATLAST1TstPattern	Integer	RW
adATLAST1TstPatternSync	Integer	RO
adATLAST1TstPatternSyncLost	Integer	RO
adATLAST1TstPatternESs	Integer	RO
adATLAST1TstPatternBESs	Integer	RO
adATLAST1TstPatternSESs	Integer	RO
adATLAST1TstClearResults	Integer	RW
adATLAST1TstInjectError	Integer	RW

atvoice.mib**(1.3.6.1.4.1.664.2.154.1.10)**

adATLASVoicemg

adATLASVoicelfNumber	Integer	RO
----------------------	---------	----

adATLASVoicelfTable

adATLASVoicelfEntry

adATLASVoicelfIndex	Integer	RO
---------------------	---------	----

adATLASVoicelfSlotNum	Integer	RO
-----------------------	---------	----

adATLASVoicelfPortNum	Integer	RO
-----------------------	---------	----

adATLASVoicelfPortStat	Integer	RO
------------------------	---------	----

adATLASVoicelfTxSignalBits	DisplayString	RO
----------------------------	---------------	----

adATLASVoicelfRxSignalBits	DisplayString	RO
----------------------------	---------------	----

adATLASVoiceTstTable

adATLASVoiceTstEntry

adATLASVoiceTstIndex	Integer	RO
----------------------	---------	----

adATLASVoiceTst2W	Integer	RW
-------------------	---------	----

adATLASVoiceTstTxABCD	Integer	RW
-----------------------	---------	----

adATLASVoiceTst1kHzTone	Integer	RW
-------------------------	---------	----

adATLASVoiceTstLpBk	Integer	RW
---------------------	---------	----

athssv35.mib**(1.3.6.1.4.1.664.2.154.1.11)**

adATLASHSSIV35mg

at550.mib**(1.3.6.1.4.1.664.2.219)**

adATLAS550mg

adATLAS550Fpnl

adATLAS550FpnlSysLeds

adATLAS550FpnlPow Integer RO

adATLAS550FpnlSys Integer RO

adATLAS550FpnlEth Integer RO

adATLAS550FpnlRem Integer RO

adATLAS550FpnlNtwkLeds

adATLAS550FpnlNwTable

adATLAS550FpnlNwEntry

adATLAS550FpnlNwIndex Integer RO

adATLAS550FpnlNwOK Integer RO

adATLAS550FpnlNwTest Integer RO

adATLAS550FpnlNwError Integer RO

adATLAS550FpnlNwAlarm Integer RO

adATLAS550FpnlModLeds

adATLAS550FpnlModNumber Integer RO

adATLAS550FpnlMLTable

adATLAS550FpnlMLEntry

adATLAS550FpnlMLIndex Integer RO

adATLAS550FpnlMLStatus Integer RO

adATLAS550FpnlMLOnline Integer RO

adATLAS550FpnlMLTest Integer RO

atqbriu.mib**(1.3.6.1.4.1.664.2.274)**

adATLAS550QuadBRIUmg

adATLAS550QuadBRIUfTable

adATLAS550QuadBRIUfEntry

adATLAS550QuadBRIUfIndex	Integer	RO
adATLAS550QuadBRIUfNEBE	Counter	RO
adATLAS550QuadBRIUfFEBE	Counter	RO
adATLAS550QuadBRIUfResetBECOUNTS	Counts	RW

fperform.mib**(1.3.6.1.4.1.664.4.1)**

adFRPerformmg

adFRPerformHistoryControl

adFRPerformHistoryIntLength	Integer	RW
adFRPerformCurrentIntTimeRemaining	Integer	RO
adFRPerformCompletedInts	Integer	RO
adFRPerformCompletedDays	Integer	RO

adFRPerformCurrentPvcStatus

adFRPerformCurrentPvcStatusTable

adFRPerformCurrentPvcStatusEntry

adFRPerformIntPvcIfIndex	Integer	RO
adFRPerformIntPvcIndex	Integer	RO
adFRPerformIntPvcSlotIndex	Integer	RO
adFRPerformIntPVCStateChange	Counter	RO
adFRPerformIntPVCInactiveTime	Counter	RO
adFRPerformIntPVCFramesRx	Counter	RO
adFRPerformIntPVCFramesTx	Counter	RO
adFRPerformIntPVCBytesRx	Counter	RO
adFRPerformIntPVCBytesTx	Counter	RO
adFRPerformIntPVCAvgThruputTx	Gauge	RO

adFRPerformIntPVCAvgThruputRx	Gauge	RO
adFRPerformIntPVCMaxThruputTx	Counter	RO
adFRPerformIntPVCMaxThruputRx	Counter	RO
adFRPerformIntPVCAvgUtilizationTx	Gauge	RO
adFRPerformIntPVCAvgUtilizationRx	Gauge	RO
adFRPerformIntPVCMaxUtilizationTx	Counter	RO
adFRPerformIntPVCMaxUtilizationRx	Counter	RO
adFRPerformIntPVCBurstTx	Counter	RO
adFRPerformIntPVCBurstRx	Counter	RO
adFRPerformIntPVCFecnRx	Counter	RO
adFRPerformIntPVCFecnTx	Counter	RO
adFRPerformIntPVCBecnRx	Counter	RO
adFRPerformIntPVCBecnTx	Counter	RO
adFRPerformIntPVCDerRx	Counter	RO
adFRPerformIntPVCDerTx	Counter	RO
adFRPerformIntPVCCrRx	Counter	RO
adFRPerformIntPVCCrTx	Counter	RO
adFRPerformIntPVCMinFrameSizeRx	Counter	RO
adFRPerformIntPVCMinFrameSizeTx	Counter	RO
adFRPerformIntPVCMaxFrameSizeRx	Counter	RO
adFRPerformIntPVCMaxFrameSizeTx	Counter	RO
adFRPerformIntPVCAvgFrameSizeRx	Gauge	RO
adFRPerformIntPVCAvgFrameSizeTx	Gauge	RO
adFRPerformIntPVCLostFrames	Counter	RO
adFRPerformIntPVCRemoteLostFrames	Counter	RO
adFRPerformIntPVCMaxDelay	Gauge	RO
adFRPerformIntPVCMinDelay	Gauge	RO
adFRPerformIntPVCAvgDelay	Gauge	RO
adFRPerformIntPVCTimeInDBU	Counter	RO

adFRPerformIntPortStatus

adFRPerformIntPortStatusTable

adFRPerformIntPortStatusEntry

adFRPerformIntIfIndex	Integer	RO
adFRPerformIntPortSlotIndex	Integer	RO
adFRPerformIntPortFramesRx	Counter	RO
adFRPerformIntPortFramesTx	Counter	RO
adFRPerformIntPortBytesRx	Counter	RO
adFRPerformIntPortBytesTx	Counter	RO
adFRPerformIntPortAvgThruputTx	Gauge	RO
adFRPerformIntPortAvgThruputRx	Gauge	RO
adFRPerformIntPortMaxThruputTx	Counter	RO
adFRPerformIntPortMaxThruputRx	Counter	RO
adFRPerformIntPortAvgUtilizationTx	Gauge	RO
adFRPerformIntPortAvgUtilizationRx	Gauge	RO
adFRPerformIntPortMaxUtilizationTx	Counter	RO
adFRPerformIntPortMaxUtilizationRx	Counter	RO
adFRPerformIntPortFullStatusRX	Counter	RO
adFRPerformIntPortFullStatusTx	Counter	RO
adFRPerformIntPortLIOnlyRX	Counter	RO
adFRPerformIntPortLIOnlyTx	Counter	RO
adFRPerformIntPortAsyncStatusFrame	Counter	RO

adFRPerformIntPortError

adFRPerformIntPortErrorTable

adFRPerformIntPortErrorEntry

adFRPerformIntPortIndex	Integer	RO
adFRPerformIntPortErrorSlotIndex	Integer	RO
adFRPerformIntPortUnavailableTime	Counter	RO
adFRPerformIntCrcErrors	Counter	RO
adFRPerformIntAbortFrames	Counter	RO
adFRPerformIntOctectViolations	Counter	RO

	adFRPerformIntDiscardFrames	Counter	RO
	adFRPerformIntLengthErrors	Counter	RO
	adFRPerformIntEAViolations	Counter	RO
	adFRPerformIntEncapsulationErrors	Counter	RO
	adFRPerformIntInactiveDLCI	Counter	RO
	adFRPerformIntInvalidDLCI	Counter	RO
	adFRPerformIntUnroutable	Counter	RO
	adFRPerformIntSignalDownTime	Counter	RO
	adFRPerformIntSignalErrors	Counter	RO
	adFRPerformIntSignalTimeOut	Counter	RO
	adFRPerformIntSignalStateChange	Counter	RO
adFRPerformIntHistoryTime			
adFRPerformIntHistoryTimeTable			
adFRPerformIntHistoryTimeEntry			
	adFRPerformIntHistoryTimeSlotIndex	Integer	RO
	adFRPerformIntHistorySlotTotalTime	Integer	RO
	adFRPerformIntHistoryTimeStamp	DisplayString	RO
adFRPerformDayPvcStatus			
adFRPerformDayPvcStatusTable			
adFRPerformDayPvcStatusEntry			
	adFRPerformDayPvcIfIndex	Integer	RO
	adFRPerformDayPvcIndex	Integer	RO
	adFRPerformDayPvcSlotIndex	Integer	RO
	adFRPerformDayPVCStateChange	Counter	RO
	adFRPerformDayPVCInactiveTime	Counter	RO
	adFRPerformDayPVCFramesRx	Counter	RO
	adFRPerformDayPVCFramesTx	Counter	RO
	adFRPerformDayPVCBytesRx	Counter	RO
	adFRPerformDayPVCBytesTx	Counter	RO
	adFRPerformDayPVCAvgThruputTx	Gauge	RO
	adFRPerformDayPVCAvgThruputRx	Gauge	RO

adFRPerformDayPVCMaxThruputTx	Counter	RO
adFRPerformDayPVCMaxThruputRx	Counter	RO
adFRPerformDayPVCAvgUtilizationTx	Gauge	RO
adFRPerformDayPVCAvgUtilizationRx	Gauge	RO
adFRPerformDayPVCMaxUtilizationTx	Counter	RO
adFRPerformDayPVCMaxUtilizationRx	Counter	RO
adFRPerformDayPVCBurstTx	Counter	RO
adFRPerformDayPVCBurstRx	Counter	RO
adFRPerformDayPVCFecnRx	Counter	RO
adFRPerformDayPVCFecnTx	Counter	RO
adFRPerformDayPVCBecnRx	Counter	RO
adFRPerformDayPVCBecnTx	Counter	RO
adFRPerformDayPVCDerRx	Counter	RO
adFRPerformDayPVCDerTx	Counter	RO
adFRPerformDayPVCCrRx	Counter	RO
adFRPerformDayPVCCrTx	Counter	RO
adFRPerformDayPVCMinFrameSizeRx	Counter	RO
adFRPerformDayPVCMinFrameSizeTx	Counter	RO
adFRPerformDayPVCMaxFrameSizeRx	Counter	RO
adFRPerformDayPVCMaxFrameSizeTx	Counter	RO
adFRPerformDayPVCAvgFrameSizeRx	Gauge	RO
adFRPerformDayPVCAvgFrameSizeTx	Gauge	RO
adFRPerformDayPVCLostFrames	Counter	RO
adFRPerformDayPVCRemoteLostFrames	Counter	RO
adFRPerformDayPVCMaxDelay	Gauge	RO
adFRPerformDayPVCMinDelay	Gauge	RO
adFRPerformDayPVCAvgDelay	Gauge	RO
adFRPerformDayPVCTimeInDBU	Counter	RO

adFRPerformDayPortStatus

adFRPerformDayPortStatusTable

adFRPerformDayPortStatusEntry

adFRPerformDayIfIndex	Integer	RO
adFRPerformDayPortSlotIndex	Integer	RO
adFRPerformDayPortFramesRx	Counter	RO
adFRPerformDayPortFramesTx	Counter	RO
adFRPerformDayPortBytesRx	Counter	RO
adFRPerformDayPortBytesTx	Counter	RO
adFRPerformDayPortAvgThruputTx	Gauge	RO
adFRPerformDayPortAvgThruputRx	Gauge	RO
adFRPerformDayPortMaxThruputTx	Counter	RO
adFRPerformDayPortMaxThruputRx	Counter	RO
adFRPerformDayPortAvgUtilizationTx	Gauge	RO
adFRPerformDayPortAvgUtilizationRx	Gauge	RO
adFRPerformDayPortMaxUtilizationTx	Counter	RO
adFRPerformDayPortMaxUtilizationRx	Counter	RO
adFRPerformDayPortFullStatusRX	Counter	RO
adFRPerformDayPortFullStatusTx	Counter	RO
adFRPerformDayPortLIOnlyRX	Counter	RO
adFRPerformDayPortLIOnlyTx	Counter	RO
adFRPerformDayPortAsyncStatusFrame	Counter	RO

adFRPerformDayPortError

adFRPerformDayPortErrorTable

adFRPerformDayPortErrorEntry

adFRPerformDayPortIndex	Integer	RO
adFRPerformDayPortErrorSlotIndex	Integer	RO
adFRPerformDayPortUnavailableTime	Counter	RO
adFRPerformDayCrcErrors	Counter	RO
adFRPerformDayAbortFrames	Counter	RO
adFRPerformDayOctectViolations	Counter	RO

adFRPerformDayDiscardFrames	Counter	RO
adFRPerformDayLengthErrors	Counter	RO
adFRPerformDayEAViolations	Counter	RO
adFRPerformDayEncapsulationErrors	Counter	RO
adFRPerformDayInactiveDLCI	Counter	RO
adFRPerformDayInvalidDLCI	Counter	RO
adFRPerformDayUnroutable	Counter	RO
adFRPerformDaySignalDownTime	Counter	RO
adFRPerformDaySignalErrors	Counter	RO
adFRPerformDaySignalTimeOut	Counter	RO
adFRPerformDaySignalStateChange	Counter	RO
adFRPerformDayHistoryTime		
adFRPerformDayHistoryTimeTable		
adFRPerformDayHistoryTimeEntry		
adFRPerformDayHistoryTimeSlotIndex	Integer	RO
adFRPerformDayHistorySlotTotalTime	Integer	RO
adFRPerformDayHistoryTimeStamp	DisplayString	RO

Free Manuals Download Website

<http://myh66.com>

<http://usermanuals.us>

<http://www.somanuals.com>

<http://www.4manuals.cc>

<http://www.manual-lib.com>

<http://www.404manual.com>

<http://www.luxmanual.com>

<http://aubethermostatmanual.com>

Golf course search by state

<http://golfingnear.com>

Email search by domain

<http://emailbydomain.com>

Auto manuals search

<http://auto.somanuals.com>

TV manuals search

<http://tv.somanuals.com>