



Express 4100 and Express 4110 ISDN Router/Bridge

USER MANUAL

Express 4100, Data Only	1200176L1
Express 4110 with POTS Option	1200176L2

61200176L2-1A
December 1998

Trademark:

DMS-100 is a trademark of Northern Telecom, Inc.

Ethernet is a trademark of Digital Equipment Corporation, Intel Corporation, and Xerox Corporation.

ExpertISDN (patent number 5,715,241) is a trademark of ADTRAN, Inc.

Macintosh is a registered trademark of Apple Computer, Inc.

Novell, NetWare, and Internetwork Packet Exchange (IPX) are registered trademarks of Novell, Inc.

Windows is a registered trademark of Microsoft Corporation.

5ESS is a registered trademark of LUCENT.

The Express 4100 and Express 4110 incorporate Synchronous Data Compression based on either IBM or hi/fn proprietary intellectual property depending on the time of manufacture. The following trademarks and copyrights are applicable:

Stacker LZS Compression

Copyright © 1989 Carnegie Mellon University

All rights reserved.

Redistribution and use in source and binary forms are permitted provided that the above copyright notice and this paragraph are duplicated in all such forms and that any documentation, advertising materials, and other materials related to such distribution and use acknowledge that the software was developed by Carnegie Mellon University. The name of the University may not be used to endorse or promote products derived from this software without specific prior written permission. This software is provided "as is" and without any express or implied warranties, including, without limitation, the implied warranties of merchantability and fitness for a particular purpose.

hi/fn

5993 Avenida Encinas

Carlsbad, CA



901 Explorer Boulevard

P.O. Box 140000

Huntsville, AL 35814-4000

Phone: (256) 963-8000

© 1998 ADTRAN, Inc.

All rights reserved.

Printed in USA.

FCC regulations require that the following information be provided in this manual:

1. This equipment complies with Part 68 of the FCC rules. On the bottom of the equipment housing is a label that shows the FCC registration number and Ringer Equivalence Number (REN) for this equipment. If requested, provide this information to the telephone company.
2. If this equipment causes harm to the telephone network, the telephone company may temporarily discontinue service. If possible, advance notification is given; otherwise, notification is given as soon as possible. The telephone company will advise the customer of the right to file a complaint with the FCC.
3. The telephone company may make changes in its facilities, equipment, operations, or procedures that could affect the proper operation of this equipment; advance notification and the opportunity to maintain uninterrupted service is given.
4. If experiencing difficulty with this equipment, please contact ADTRAN for repair and warranty information. The telephone company may require this equipment to be disconnected from the network until the problem is corrected or it is certain the equipment is not malfunctioning.
5. This unit contains no user serviceable parts.
6. An FCC compliant telephone cord with a modular plug is provided with this equipment. In addition, an FCC compliant cable appropriate for the dial backup option ordered is provided with this equipment. This equipment is designed to be connected to the telephone network or premises wiring using an FCC compatible modular jack, which is Part 68 compliant.
7. The following information may be required when applying to the local telephone company for leased line facilities.

Service Type	Digital Facility Interface Code	Service Order Code	Network Jacks
ISDN	021S5	6.0N	RJ-49C

To ADTRAN service personnel: For continued protection against risk of fire, replace F1 with the same type and rating of fuse only: .2A, 250 V.

FEDERAL COMMUNICATIONS COMMISSION RADIO FREQUENCY INTERFERENCE STATEMENT

This equipment has been tested and found to comply with the limits for a Class B digital device, pursuant to Part 15 of the FCC Rules. These limits are designed to provide reasonable protection against harmful interference in a residential environment. This equipment generates, uses, and can radiate radio frequency energy and, if not installed and used in accordance with the instructions, may cause harmful interference to radio or TV reception, which can be determined by turning the equipment off and on. The user is encouraged to try to correct the interference by one or more of the following measures:

- Reorient or relocate the receiving antenna.
- Increase the separation between the equipment and receiver.
- Connect the equipment into an outlet on a circuit different from that to which the receiver is connected.
- Consult the dealer or an experienced radio/TV technician for help.

WARNING

Changes or modifications to this unit not expressly approved by ADTRAN will void the user's authority to operate the equipment.

YEAR 2000 Compliance

All Adtran transmission hardware and software have been tested and found to be fully compliant with the YEAR 2000 requirements. This is true for all models and revisions regardless of the date of manufacture or delivery.

Users who wish to independently verify that specific products are in compliance may contact ADTRAN Technical Support at 1-888-423-8726.

CANADIAN EMISSIONS REQUIREMENTS

This digital apparatus does not exceed the Class B limits for radio noise emissions from digital apparatus as set out in the interference-causing equipment standard entitled "Digital Apparatus," ICES-003 of the Department of Communications.

Cet appareil numérique respecte les limites de bruits radioélectriques applicables aux appareils numériques de Class B prescrites dans la norme sur le matériel brouilleur: "Appareils Numériques," NMB-003 édictée par le ministre des Communications.

CANADIAN EQUIPMENT LIMITATIONS

Notice: The Canadian Industry and Science Canada label identifies certified equipment. This certification means that the equipment meets certain telecommunications network protective, operational, and safety requirements. The Department does not guarantee the equipment will operate to the user's satisfaction.

Before installing this equipment, ensure that it is permissible to be connected to the facilities of the local telecommunications company. The equipment must also be installed using an acceptable method of connection. In some cases, the company's inside wiring associated with a single-line individual service may be extended by means of a certified connector assembly (telephone extension cord). Compliance with the above conditions may not prevent degradation of service in some situations.

Repairs to certified equipment should be made by an authorized Canadian maintenance facility designated by the supplier. Any repairs or alterations made by the user to this equipment, or equipment malfunctions, may give the telecommunications company cause to request the user to disconnect the equipment.

Users should ensure for their own protection that the electrical ground connections of the power utility, telephone lines, and internal metallic water pipe system, if present, are connected together. This precaution may be particularly important in rural areas.



Users should not attempt to make such connections themselves, but should contact the appropriate electric inspection authority, or an electrician, as appropriate.

The **Load Number (LN)** assigned to each terminal device denotes the percentage of the total load to be connected to a telephone loop which is used by the device, to prevent overloading. The termination on a loop may consist of any combination of devices subject only to the requirement that the total of the Load Numbers of all devices does not exceed 100.

IMPORTANT SAFETY INSTRUCTIONS

When using your telephone equipment, basic safety precautions should always be followed to reduce the risk of fire, electric shock and injury to persons. The precautions are listed below.

1. Do not use this product near water (for example, near a bath tub, wash bowl, kitchen sink or laundry tub, in a wet basement or near a swimming pool).
2. Avoid using a telephone (other than a cordless type) during an electrical storm. There may be a remote risk of electric shock from lightning.
3. Do not use the telephone to report a gas leak in the vicinity of the leak.
4. Use only the power cord, power supply, and/or batteries indicated in the manual. Do not dispose of batteries in a fire. They may explode. Check local codes for any special disposal instructions.

SAVE THESE INSTRUCTIONS.

AFFIDAVIT REQUIREMENTS FOR CONNECTION TO DIGITAL SERVICES

- An affidavit is required to be given to the telephone company whenever digital terminal equipment without encoded analog content and billing protection is used to transmit digital signals containing encoded analog content which are intended for eventual conversion into voiceband analog signals and transmitted on the network.
- The affidavit shall affirm that either no encoded analog content or billing information is being transmitted or that the output of the device meets Part 68 encoded analog content or billing protection specifications.
- End user/customer will be responsible to file an affidavit with the local exchange carrier when connecting unprotected CPE to a 1.544 Mbps or sub-rate digital services.
- Until such time as subrate digital terminal equipment is registered for voice applications, the affidavit requirement for subrate services is waived.

**AFFIDAVIT FOR CONNECTION OF CUSTOMER PREMISES EQUIPMENT TO
1.544 MBPS AND/OR SUBRATE DIGITAL SERVICES**

For the work to be performed in the certified territory of _____

(telco name)

State of _____

County of _____

I, _____ (name), _____

(business address), _____ (telephone number) being

duly sworn, state:

I have responsibility for the operation and maintenance of the terminal equipment to be connected to 1.544 Mbps and/or _____ subrate digital services. The terminal equipment to be connected complies with Part 68 of the FCC rules except for the encoded analog content and billing protection specifications. With respect to encoded analog content and billing protection:

I attest that all operations associated with the establishment, maintenance, and adjustment of the digital CPE with respect to analog content and encoded billing protection information continuously complies with Part 68 of the FCC Rules and Regulations.

The digital CPE does not transmit digital signals containing encoded analog content or billing information which is intended to be decoded within the telecommunications network.

The encoded analog content and billing protection is factory set and is not under the control of the customer.

I attest that the operator(s)/maintainer(s) of the digital CPE responsible for the establishment, maintenance, and adjustment of the encoded analog content and billing information has (have) been trained to perform these functions by successfully having completed one of the following (check appropriate blocks):

() A. A training course provided by the manufacturer/grantee of the equipment used to encode analog signals; or

() B. A training course provided by the customer or authorized representative, using training materials and instructions provided by the manufacturer/grantee of the equipment used to encode analog signals; or

() C. An independent training course (e.g., trade school or technical institution) recognized by the manufacturer/grantee of the equipment used to encode analog signals; or

() D. In lieu of the preceding training requirements, the operator(s)/maintainer(s) is (are) under the control of a supervisor trained in accordance with _____ (circle one) above.

I agree to provide _____ (telco's name) with proper documentation to demonstrate compliance with the information as provided in the preceding paragraph, if so requested.

_____ Signature

_____ Title

_____ Date

Transcribed and sworn to before me

This _____ day of _____, 199__

Notary Public

My commission expires:

Table of Contents

Quick Startup Guide	Quick Start-1
Setting up the ISDN Line	Quick Start-1
Connecting to an Internet Service Provider	Quick Start-2
Internet Access using Network Address Translation (NAT)	Quick Start-2
Multiprotocol Routing Between Two LANS	Quick Start-3
Remote/Home Office Accessing the Corporate LAN	Quick Start-3
Chapter 1 Understanding ISDN and the Express 4100/4110	1-1
ISDN Overview	1-1
The Express 4100/4110	1-1
Applications	1-2
Single User to Corporate LAN	1-2
Single User IP to Internet Service Provider (ISP) using Network Ad- dress Translation (NAT)	1-3
Multiple Users to Internet Service Provider (ISP) using NAT	1-4
Small Office - Home Office (SOHO) to Corporate LAN	1-5
Demand Routing and Bridging with the Express 4100/4110	1-6
Factory Default	1-6
Bridging	1-7
IP Routing.....	1-8
IPX Routing	1-9
Connection List - Simplifying and Enhancing the Dial Function	1-9
Concurrent Routing and Bridging	1-9
Routing over PPP Bridging	1-9
Network Address Translation Mode	1-10

Front Panel	1-10
LAN Indicators	1-10
WAN Indicators	1-10
Test Indicators.....	1-10
Rear Panel	1-11
ISDN Connection	1-11
Ordering ISDN	1-13
Interoperability	1-13
Connecting to the Internet	1-13
Configuration	1-14
Security	1-14
Chapter 2 Installation.....	2-1
ISDN Network Connection	2-1
Local Area Network Connection	2-1
Telephone Connection (4110 Only)	2-2
Basic Telephone Service	2-2
Supplementary Services	2-2
DTMF Keypad	2-2
Customer Premises Wiring	2-3
Chapter 3 Terminal Menu Operation and Structure.....	3-1
Terminal Menu Structure	3-1
Configuration	3-3
Dial	3-3
Status	3-3
Test	3-3
Logs	3-3
Utilities	3-3
Navigating the Terminal Menus	3-4
General Layout	3-4
Menu Path	3-4
Moving Around	3-4
Submenus [+] or [DATA]	3-4
Activation Field <+>	3-4
Editable Data Field	3-4
Read-Only Field	3-4
Navigation with the Keyboard	3-5
Security Levels	3-7

Configuration Menu	3-8
Configuration/System Info	3-8
System Name	3-8
System Location.....	3-9
System Contact	3-9
Firmware Revision	3-9
System Uptime.....	3-9
Configuration/WAN	3-10
WAN/ISDN	3-10
ISDN/Dial Line	3-10
Dial Line/ExpertISDN	3-11
Dial Line/Switch Protocol	3-11
Dial Line/Area Code	3-11
Dial Line/SPID 1	3-11
Dial Line/LDN 1 or 2	3-12
ISDN/Leased Line	3-12
Leased Line/Clock Mode	3-12
Leased Line/Channel Rate	3-12
ISDN/NEBEs	3-13
ISDN/FEBEs	3-13
WAN/POTS.....	3-13
POTS/POTS Assignment	3-13
POTS/NI-1 Conference FI	3-13
POTS/NI-1 Transfer FI	3-13
POTS/Speech Calltype Routing	3-14
Configuration/IP	3-15
IP/IP Address.....	3-15
IP/Subnet Mask.....	3-15
IP/Default Gateway.....	3-16
IP/Static Routes.....	3-16
Static Routes/Active	3-16
Static Routes/IP Address	3-16
Static Routes/Subnet Mask	3-16
Static Routes/Gateway	3-16
Static Routes/Hops	3-16
Static Routes/Private	3-17
IP/IP Router.....	3-17
IP Router/Mode	3-17
IP/RIP	3-17

RIP/Mode	3-17
RIP/Protocol	3-17
RIP/Method	3-17
RIP/Direction	3-18
RIP/V2 Secret	3-18
IP/NAT.....	3-18
NAT/DHCP Mode	3-18
NAT/DHCP Renewal Time	3-18
NAT/Web Server	3-19
IP/DNS.....	3-19
DNS/Domain Name	3-19
DNS/Server 1	3-19
DNS/Server 2	3-19
IP/UDP Relay.....	3-19
UDP Relay/Mode	3-20
UDP Relay/UDP Relay List	3-20
UDP Relay List/Relay Address	3-20
UDP Relay List/UDP Port Type	3-20
UDP Relay List/UDP Port 1, UDP Port 2, UDP Port 3	3-20
IP/Proxy ARP.....	3-21
Configuration/IPX	3-22
IPX/Mode.....	3-22
IPX/Network.....	3-22
IPX/Frame Type.....	3-23
IPX/Seed Status.....	3-23
IPX/RIP Timer.....	3-24
IPX/SAP Timer.....	3-24
Configuration/Bridge	3-25
Bridge/Mode.....	3-25
Bridge/WAN IP Bridge.....	3-26
WAN IP Bridge/Network	3-26
WAN IP Bridge/Netmask	3-26
WAN IP Bridge/Triggered	3-26
WAN IP Bridge/Proxy ARP	3-26
Bridge/WAN IPX Bridge.....	3-26
WAN IPX Bridge/Network	3-27
WAN IPX Bridge/Frame Type	3-27
WAN IPX Bridge/Seed Status	3-27
WAN IPX Bridge/Triggered	3-27

Bridge/Address Table	3-28
Address Table/Aging	3-28
Address Table/Forward Policy	3-28
Configuration/Security	3-29
Security/Authentication	3-29
Security/When	3-30
Security/Radius Server	3-30
Radius Server/Primary Server	3-30
Radius Server/Secondary Server	3-30
Radius Server/UDP Port	3-30
Radius Server/Secret	3-30
Radius Server/Retry Count	3-31
Security/PPP	3-31
Security/Filter Defines	3-32
Filter Defines /MAC Filter Defines	3-32
Filter Defines /Pattern Filter Defines	3-33
Filter Defines /IP Filter Defines	3-33
Filter Defines /IPX Filter Defines	3-34
Configuration/Connection List	3-36
Connection List/Description	3-37
Connection List/Active	3-37
Connection List/Authentication	3-37
Authentication/Tx Method	3-39
Authentication/Tx Username	3-39
Authentication/Tx Password	3-39
Authentication/Rx Username	3-39
Authentication/Rx Password	3-40
Authentication/Call ID 1	3-40
Authentication/Call ID 2	3-40
Connection List/IP	3-40
IP/Mode	3-40
IP/NAT	3-40
IP/Route	3-41
Route/IP/Net	3-41
Route/Netmask	3-41
Route/Static Route	3-41
Route/Private	3-42
Route/Hops	3-42
Route/Force IP	3-42

IP/RIP	3-42
RIP/Mode	3-42
RIP/Protocol	3-42
RIP/Method	3-43
RIP/Direction	3-43
RIP/Triggered	3-43
RIP/Retain	3-43
Connection List/IPX.....	3-44
IPX/Mode	3-44
IPX/Remote Network	3-44
IPX/Triggered	3-44
IPX/Retain	3-44
IPX/Type 20 Packets	3-45
Connection List/Bridge.....	3-45
Bridge/Mode	3-45
Connection List/Probe	3-46
Probe/Active	3-46
Probe/Interval	3-46
Probe/Update Window	3-46
Connection List/PPP	3-47
PPP/Multilink	3-47
Multilink/Mode	3-47
Multilink/Fragment	3-47
Multilink/BACP	3-47
PPP/Compression	3-48
PPP/VJ Compression	3-48
PPP/Max Config	3-48
PPP/Max Timer	3-48
PPP/Max Failure	3-49
Connection List/Dial Out	3-49
Dial Out/Number 1	3-49
Dial Out/Number 2	3-49
Dial Out/Call Type	3-49
Dial Out/Redial at 56K	3-50
Dial Out/Delay	3-50
Dial Out/Connection Timeout	3-50
Dial Out/Attempts	3-51
Dial Out/Initial Channels	3-51
Connection List/Bandwidth.....	3-51

Bandwidth/On Demand	3-51
Bandwidth/Mode	3-51
Bandwidth/Idle Timeout	3-51
Bandwidth/Preempt Time	3-51
Bandwidth/Upper Threshold	3-52
Bandwidth/Lower Threshold	3-52
Bandwidth/Min Channels	3-52
Bandwidth/Max Channels	3-52
Bandwidth/Samples	3-53
Samples/Sample Rate	3-53
Samples/Samples	3-53
Samples/Time Between Changes	3-53
Connection List/Filters	3-53
Filters/WAN-to-LAN (In)	3-53
Filters/In Exceptions	3-54
Filters/LAN-to-WAN (Out)	3-55
Filters/Out Exceptions	3-55
Filters/Demand Dial	3-55
Filters/Dem Dial Exceptions	3-56
Configuration/Management	3-57
Management/Telnet/Web.....	3-57
Telnet/Server Access	3-58
Telnet/User List	3-58
User List/Name	3-58
User List/Authen Method	3-58
User List/Password	3-58
User List/Idle Time	3-58
User List/Level	3-59
Management/SNMP.....	3-59
SNMP Access	3-59
SNMP/Communities	3-59
Communities/Name	3-59
Communities/Privilege	3-59
Communities/Manager IP	3-60
SNMP/Traps	3-60
Traps/Manager Name	3-60
Traps/Manager IP	3-60
Management/Maint Port	3-60
Maint Port/Password Protect	3-60

	Maint Port/Password	3-60
	Maint Port/Baud Rate	3-61
	Maint Port/Data Bits	3-61
	Maint Port/Parity	3-61
	Maint Port/Stop Bits	3-61
	Configuration/Terminal Mode	3-61
Dial Menu		3-62
	Dial/Description	3-62
	Dial/Dial	3-62
	Dial/Hang Up	3-63
	Dial/Status	3-63
	Dial/Channels	3-63
	Dial/Number 1	3-63
	Dial/Number 2	3-63
Status Menu		3-64
	Status/Call Sessions	3-65
	Call Sessions/Session1 and Call Sessions/Session2	3-65
	Call Sessions/Spanning Tree.....	3-66
	Status/ARP Cache	3-66
	Status/Bridge Table	3-67
	Status/IP Routes	3-67
	Status/IPX Routes	3-68
	Status/IPX Servers	3-69
	Status/WAN Stats	3-70
	Status/LAN Stats	3-70
	Status/IP Stats	3-71
Test Menu		3-73
	Test Menu/Echo Request	3-73
	Test Menu/Dial Self	3-73
Logs Menu		3-74
	Logs/Sys log Host	3-75
	Logs/PPP Log	3-75
	PPP Log/Active.....	3-75
	PPP Log/Wrap	3-75
	PPP Log/Level.....	3-75
	PPP Log/View	3-75
	PPP Log/Clear.....	3-75
	Logs/Call Log	3-75
	Call Log/Active.....	3-76

Call Log/Wrap	3-76
Call Log/Level.....	3-76
Call Log/View	3-76
Call Log/Clear	3-76
Logs/Network Log	3-76
Network Log/Active	3-76
Network Log/Wrap.....	3-76
Network Log/Level.....	3-77
Network Log/View	3-77
Network Log/Clear	3-77
Utilities Menu	3-78
Utilities/Ping	3-78
Utilities/Telnet Client	3-79
Utilities/Upgrade Menu	3-79
Upgrade/Transfer Method.....	3-79
Upgrade/Filename.....	3-79
Upgrade/Start Transfer.....	3-80
Utilities/Exit	3-80
Chapter 4 Troubleshooting	4-1
If Self-Test Fails	4-1
If the Express 4100/4110 does not read Ready	4-1
If You are Unable to Connect Calls	4-6
Chapter 5 Specifications	5-1
Specifications and Features	5-1
Network Interface	5-1
Ethernet Interface (LAN)	5-1
Switch Compatibility	5-1
Dual POTS Interface	5-1
Display	5-2
Environmental	5-2
Physical	5-3
Power	5-3
Appendix A Loop Status Messages	A-1
Appendix B Log Messages	B-1

Appendix C SNMP	C-1
Appendix D Connector Pinouts	D-1
Appendix E Terminal Mode Commands	E-1
Appendix F Frame Relay Firmware Version	F-1
Glossary	Glossary-1
Acronyms.....	Acronyms-1
Index	Index-1

List of Figures

Figure 1-1. Express 4100/4110T	1-2
Figure 1-2. Single User to Corporate LAN	1-2
Figure 1-3. Single User to Internet Service Provider	1-3
Figure 1-4. Multiple User to Internet Service Provider	1-4
Figure 1-5. SOHO to Corporate LAN	1-5
Figure 1-6. Express 4100/4110 LEDs	1-11
Figure 1-7. Express 4100/4110 Rear Panel	1-12
Figure 2-1. Wiring Scheme 1: Use existing analog telephone equipment, but replace single analog telephone service with ISDN service	2-4
Figure 2-2. Wiring Scheme 2: Retain single analog telephone service and add ISDN service	2-5
Figure 3-1. Top Level Terminal Menu	3-2
Figure 3-2. Configuration/System Info Screen	3-8
Figure 3-3. Configuration/WAN Screen	3-10
Figure 3-4. Configuration/IP Screen	3-15
Figure 3-5. Configuration/IPX Screen	3-22
Figure 3-6. Configuration/Bridge Screen	3-25
Figure 3-7. Configuration/Security Screen	3-29
Figure 3-8. Configuration/Connection List Screen	3-36
Figure 3-9. Configuration/Management Screen	3-57
Figure 3-10. Dial Screen	3-62
Figure 3-11. Status Screen	3-64
Figure 3-12. Test Screen	3-73
Figure 3-13. Logs Screen	3-74
Figure 3-14. Utilities Screen	3-78
Figure F-1. Configuration/Frame Relay Screen	F-1
Figure F-2. Status/Sessions Screen (with Frame Relay)	F-10

List of Tables

Table 2-1. Using the Flash-Hook.....	2-3
Table 4-1. Troubleshooting Calls.....	4-6
Table D-1. IBM/AT Style EIA-232 Interface.....	D-1
Table D-2. RJ-49C ISDN.....	D-1
Table D-3. RJ-11 POTS.....	D-2
Table D-4. 10BaseT Ethernet.....	D-2

Quick Startup Guide

SETTING UP THE ISDN LINE

Before configuring the Express 4100/4110, ensure that the telephone service has provided the switch type, service profile identification (SPID), and local directory number (LDN).

Example:

Switch Type	National ISDN-1
SPID1	20555512120100
SPID2	20555512130100
LDN1	5551212
LDN2	5551213

1. Connect a VT 100 async terminal, or personal computer with a terminal emulator running 9600 N-8-1, to the **MAINTENANCE** port.
2. Hold down the **Control** key and press **R**; then press **Enter** to display the top menu.
3. Using the arrow keys and **Enter** key to navigate the menu, go to the **Configuration/WAN/ISDN/Dial Line** menu. Enter the SPIDs, LDNs, and switch type.
4. Use the left arrow key or the **Escape** key to go back up the menu tree. When asked to save ISDN parameters, type **y**.
5. Connect the ISDN line to the RJ-49C jack labeled **ISDN** on the rear panel.
6. When the PWR LED remains solid, the Express 4100/4110 is ready for calling.

7. If using a POTS phone with the Express 4110, connect the POTS telephone to the POTS port.

**NOTE**

*If the SPID(s) does not work or is unknown, try activating the ExpertISDN™ feature. First enter the area code and local directory number(s); then press the **Enter** key over the ExpertISDN activator.*

CONNECTING TO AN INTERNET SERVICE PROVIDER

Internet Access using Network Address Translation (NAT)

1. Connect the 10BaseT cable from the PC's network card to the Express 4100/4110.
2. Go to the **Configuration/Connection List** menu, and then press the right arrow key to place the cursor on the **Num** column.
3. Type **I** to insert a new Connection List entry.
4. Using the arrow keys, move the cursor over the **Num** column for the inserted entry. Press **Enter** to place the subentries into the right pane.
5. Set the **Description** to an identifiable name (i.e., ISP).
6. Go into the **Authentication** field and select **PAP** or **CHAP** for the **Tx Method**.
7. Enter your user name and password (provided by your ISP) into the **Tx Username** and **Tx Password** fields.
8. Move the cursor to the left pane and highlight the IP parameters.
9. Set the **NAT** item to **Yes**. This is a very important step. The Express 4100/4110 will need to translate the "fake" IP address(es) on the PC(s) to the "real" address provided dynamically by the ISP. See "IP/NAT" on page 3-18 for more details.
10. All other IP parameters should be left at their default settings. Navigate over to the **Dial Out** parameters.
11. Enter the number into **Number 1**. If configured for two B-channel (PPP Multilink) by the ISP, enter **Number 2** if it exists and set **Initial Channels** to **2**.
12. Arrow left until the message **Save Connection List Changes** appears. Type **y** to save.
13. Go to the **Configuration/IP** menu and enter an IP address and net mask into the **IP Address** and **Subnet Mask** fields. The factory default setting will work just as well (10.0.0.1, 255.255.255.0).
14. Go into the **Configuration/IP/NAT** submenu and set **DHCP Mode** to **On**.
15. Arrow left to save the configuration.

16. Go into the **Dial** menu.
17. Set the cursor over the **Dial** parameter for the Connection List profile you just set up.
18. Press **Enter**; the Express 4100/4110 will start dialing.
19. If the call is successful, the **Status** column will read **active**. If not, make sure the number(s) are correct or reference “Troubleshooting” on page 4-1 before going on to the next step.
20. Once the call is up, the PC must generate a DHCP request to obtain the IP parameters needed to get on the Internet. Refer to your PC’s user manual or help screen.

MULTIPROTOCOL ROUTING BETWEEN TWO LANS

Remote/Home Office Accessing the Corporate LAN

The following steps can be used to set up the Express 4100/4110 on a remote LAN to access a corporate or central LAN using demand dial and dynamic bandwidth management.

1. Connect the 10BaseT cable from the hub to the Express 4100/4110.
2. Set the **IP address** and **Subnet Mask** assigned by the network administrator in the **Configuration/IP** menu.
3. For the **Default Gateway**, enter the IP address of the access server at the remote site. This creates a default route in the IP routing table that will be used with the dial-on-demand feature in the Express 4100/4110.
4. Use the arrow keys to get to the **Configuration/IPX** menu. Set the **Network value** to the IPX network supplied by the network administrator. Set the **Seed Status** to **Seed**. Arrow left and save the changes with a **y** when prompted.
5. Move to the **Configuration/Connection List**. Use the arrow keys to move the cursor over the **Num** column. Type **I** to insert a new entry.
6. Move the cursor over the **Description** field and press **Enter**. A pop up window appears in which to enter a name for this Connection List profile.
7. Move the cursor over the **Authentication** menu and press **Return**. This will place the authentication parameters into the right pane.
8. Enter the username and password under **Tx Username** and **Tx Password**. These items should be provided by the administrator at the site being dialed.

9. Use the down arrow to display the **IP** menu parameters in the right pane.
10. Move the cursor over the **Route** menu and press **Return**.
11. Enter the **IP address** and **Netmask** parameters of the access server at the remote site. This creates a static route to the access server's network which is entered into the Express 4100/4110's IP route table.
12. Move the cursor over the **RIP** menu. Check with the network administrator for the type of routing protocol used. The Express 4100/4110 supports RIP versions 1 and 2. The protocol is set in the **Protocol** parameter.
13. Select **Yes** for the **Triggered** parameter. This will prevent periodic RIP updates that keep the ISDN link from going "idle."
14. Select **Yes** for the **Retain** parameter. This will allow the routes learned from the access server to be saved in the IP routing table. Access to any of those networks from the workstation will cause this profile to be dialed.
15. Use the left arrow to get back to the previous menu. Use the down arrow to view the **IPX** menu parameters in the right pane.
16. This is similar to steps 13 and 14. Select **Yes** for **Triggered** and **Yes** for **Retain**. This will allow the ISDN link to go to an idle state and permit the Express 4100/4110 to "spoof" the server information obtained from the access server. A similar configuration must be selected on the access server.
17. Use the arrows to get the **Dial Out** menu parameters for this profile.
18. Enter the phone number of the access server in **Number 1**. If configured by the administrator to use two B-channels using Multilink PPP, set the **Initial Channels** field to **2**. Some PPP protocols, if they exist in the access server, will allow the second channel to come into play only if the bandwidth is needed. If this is the case, the Express 4100/4110 will automatically negotiate this with the access server.
19. Now move to the **Bandwidth** menu for this profile. Once there, use the right arrow to move to the **On Demand** submenu.
20. Set the **Mode** parameter to **On**. This enables the dynamic bandwidth features of the Express 4100/4110.
21. Select the **Idle Timeout** parameter and enter the number of seconds the Express 4100/4110 should wait before hanging up the connection when no traffic is present. A value of 120 seconds is typical. A value of 0 means never idle the link.

22. All the parameters for this Connection List profile are complete. To save them, press the left arrow to get to the top (main) menu; when prompted **Save Connection List changes?** enter **y**.
23. Set up the computer workstation's IP and IPX parameters as instructed by the network administrator. The Express 4100/4110's IP address should be the computer's default gateway.

When the computer which is attached to the local LAN attempts to access a host on the access server, the Express 4100/4110 will dial the number provided in the Connection List profile. The Express 4100/4110 will provide one of two B-channels based on traffic demand and POTS port usage (Express XLT model only). If no packet traffic is transmitted or received for the specified number of seconds, the Express 4100/4110 will disconnect the link until a computer on the local LAN again attempts to access a host on the access server.

If Novell's IPX protocol is being used, the link must be dialed first in the **Dial** menu to obtain the server and route information needed by the computer to boot up. Advanced users can use the Express 4100/4110's Probe feature to periodically dial the access server to obtain the route and server information, thereby removing the need to manually dial the first time.

ISDN OVERVIEW

The Integrated Services Digital Network (ISDN) is a public or private switched digital network. ISDN is an international standard for digital communications, allowing a full range of enhanced services supporting voice, data, and image applications through standard interfaces over a single telephone wire. ISDN provides a means of integrating these services and modernizing communication networks for information movement and management efficiency.

THE EXPRESS 4100/4110

The Express 4100/4110 is a standalone device that links two Local Area Networks (LANs) using a high-speed ISDN public network or leased two-wire line. Optionally, the Express 4110 has two plain old telephone service (POTS) connectors used for voice/modem applications

See Figure 1-1 on page 1-2 for an illustration of the Express 4100/4110. The 10BaseT connector operates at 10 megabits per second half duplex and accepts standard Ethernet packets encapsulated using IEEE 802.3 or Ethernet II (DIX). The maintenance port can connect to any asynchronous terminal emulating a VT 100 terminal for configuration.

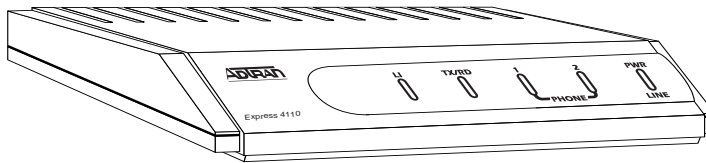

Figure 1-1. Express 4100/4110T

Applications

Single User to Corporate LAN

- Telecommuter/Home Office Access to the corporate LAN
- Single device access
- User Datagram Protocol (UDP) broadcasts are “relayed” to corporate LAN.
- Client device can obtain the Internet Protocol (IP) address dynamically using Dynamic Host Configuration Protocol (DHCP).
- Compatible with popular central site LAN access devices

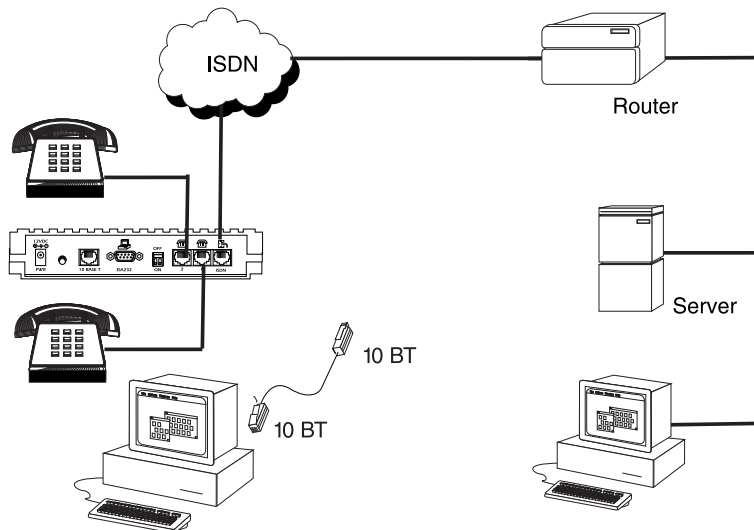

Figure 1-2. Single User to Corporate LAN

Single User IP to Internet Service Provider (ISP) using Network Address Translation (NAT)

- Provides high speed home access to the Internet
- NAT provides translation from user assigned IP addresses to ISP assigned IP addresses.
- The PC's IP address can be dynamically assigned by the Express 4100/4110.
- Overcomes the serial port speed limitations of current terminal adapter solutions
- Multilink Point-to-Point Protocol (PPP) plus compression yields effective throughput greater than 256 kbps.
- Compatible with popular ISP access devices

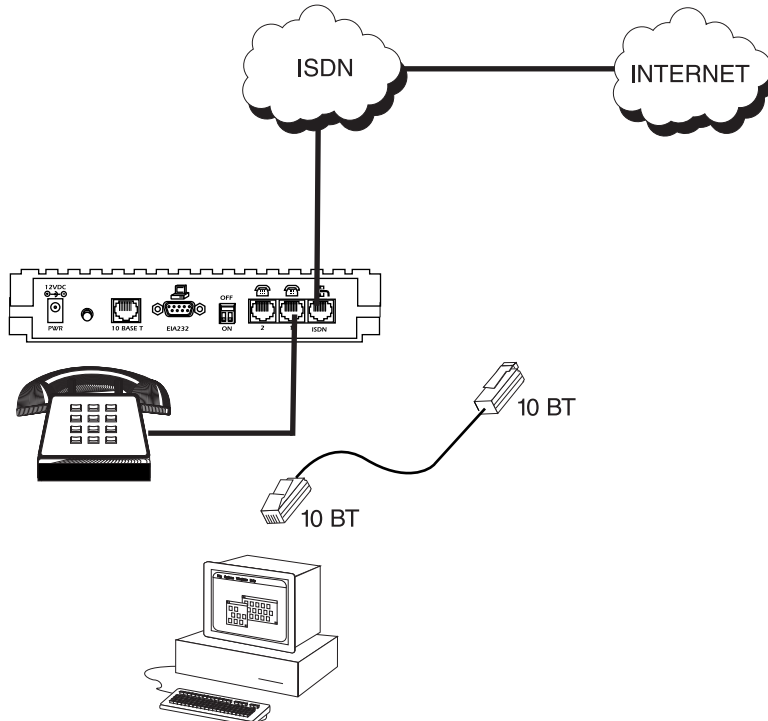

Figure 1-3. Single User to Internet Service Provider

Multiple Users to Internet Service Provider (ISP) using NAT

- Provides high speed home access to the Internet
- Multiple and simultaneous access
- The PC's IP address can be dynamically assigned by the Express 4100/4110.
- On-demand Internet access
- Multilink PPP plus compression yields effective throughput greater than 256 kbps.
- Compatible with popular ISP access devices

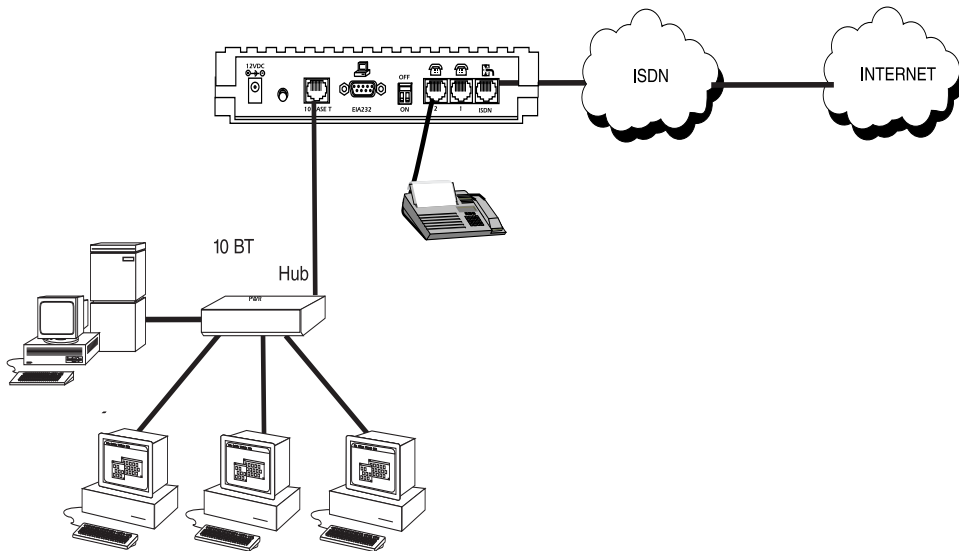

Figure 1-4. Multiple User to Internet Service Provider

Small Office - Home Office (SOHO) to Corporate LAN

- Connects the small office or home office to the corporate LAN
- Routes IP and Internet Packet Exchange (IPX) traffic from multiple devices to the corporate LAN
- Bridges all non-routed traffic (e.g., AppleTalk)
- Provides dedicated or on-demand services
- Low-cost alternative to buying a high-end router
- Compatible with popular central site LAN access devices

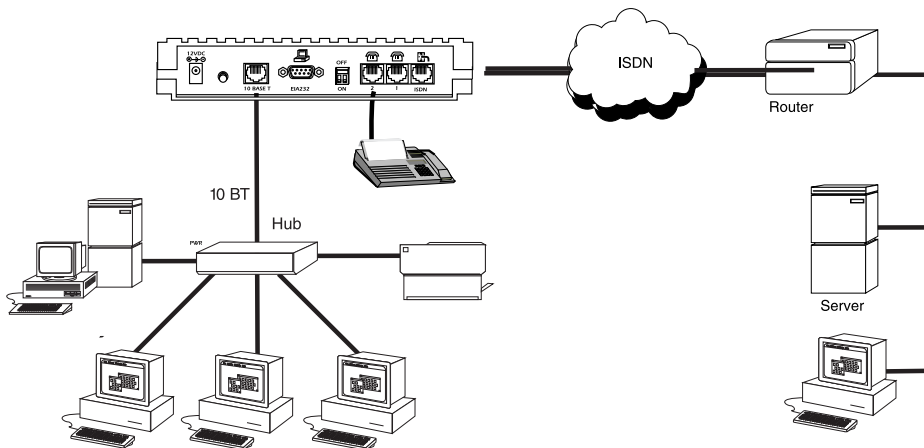

Figure 1-5. SOHO to Corporate LAN

The Express 4100/4110 provides the following basic functions:

1. **LAN Bridge:** Bridging provides a point-to-point connection between two LANs. The bridge learning function scans the source and destination media access control (MAC) addresses of all packets on its local LAN and determines which packets should be transmitted over the ISDN link. Applications include connectivity between single user or small offices to corporate LANs. The Express 4100/4110 uses the Spanning Tree Algorithm (IEEE 802.1d-ISO/IEC10038), which provides a loop-free topology and redundancy.

2. **IP Router:** The Express 4100/4110 can function as an IP router using the Routing Information Protocol (RIP) for advertising and learning routes among other routers. Static routes may also be entered into the routing table.
3. **IPX Router:** IPX routers and services can be exchanged between the Express 4100/4110 and other devices using RIP and Service Advertising Protocol (SAP). Watch dog serialization filtering and spoofing can permit the ISDN to be idle during no application traffic periods.
4. **Network Address Translation (NAT):** Single networks can connect to the Internet with this function. The Express 4100/4110 translates outgoing IP packets over the ISDN to the IP router at the Internet Service Provider. Popular Internet applications are supported.
5. **POTS:** The POTS interfaces can be used for interfacing to dual tone multi-frequency (DTMF) analog devices such as telephones, modems, fax machines, etc. The Express 4110 POTS option is available on part number 1200176L2 only.

Demand Routing and Bridging with the Express 4100/4110

The Express 4100/4110 is a dial-up ISDN IP Router and Transparent Learning Bridge that provides Dial-On-Demand and Dynamic Bandwidth Management. Its features can be easily configured and used once several basic concepts are understood.

Factory Default

The Express 4100/4110 comes from the factory configured for MAC Bridging, IP routing, and IPX routing with no filters or connection information defined. An IP address of 10.0.0.1 with a network mask of 255.255.255.0 is preloaded. Dynamic Bandwidth Management features are disabled. Although dynamic assignment of a B-channel for the analog (POTS) ports on the Express 4110 model is always available, link idle time-out and adding/removing of B-channels based on traffic is initially disabled.

Bridging

In Bridge Mode, the Express 4100/4110 can communicate with two remote networks at a time. The destination is dialed by setting up a Connection List profile and choosing **Dial** on the Dial menu. See “Configuration/Connection List” on page 3-36 for instructions on setting up a Connection List profile.

During a two B-channel PPP Multilink call, the Express 4110 automatically drops one B-channel and provides it to the POTS port when a telephone call is placed or answered. When a POTS telephone call terminates, the Express 4100 redials the second B-channel and supplies the bandwidth back to the LAN connection. Since other bandwidth management features are disabled in the factory default configuration, the dialed links remain active until the **Hang-up** command is entered from the Dial menu, terminating the session with the selected remote network.

The Connection List described in the next section may be used to automate dialing and to store additional information specific to the remote site being dialed (phone numbers, number of B-channels to dial, authentication information, Caller ID, etc.). In addition, to reduce line charges, Demand Dialing may be enabled to allow idle links to disconnect when not being used .

Simple Demand Bridging may be configured by enabling the Idle Time-Out parameter under the **Configuration/ Connection List [1]/Bandwidth/On Demand** option on the Connection List. Setting this parameter to a non-zero value allows a bridge connection to disconnect after the specified number of seconds with no traffic crossing the ISDN link. Bandwidth can be controlled using the Express 4100/4110's advanced filtering capability. When new traffic needs to be transmitted, the Express 4100/4110 will run each packet through its Demand filters defined for each Connection List profile. If a packet can pass through the filter, then the numbers for that profile are dialed. In addition, when both B-channels are selected for use, the link may be configured to add/remove the second B-channel based on the amount of traffic crossing the link. The bridged connection is terminated when the **Hang-up** option is selected from the Dial menu, but will redial if the demand filter condition is met.

IP Routing

The Express 4100/4110 operates as a dial-up IP router when the **Configuration/IP/IP Router/Mode** option is configured to **On**. The Express 4100/4110 uses an IP unnumbered WAN interface; the IP address and mask assigned to the unit's LAN interface apply to all routing and IP operations for the unit. If a default gateway is specified on the network of the Ethernet interface, the unit attempts to reach the gateway through that interface. If the gateway is specified on an unknown network, the unknown network is assigned to the router table and remains unused until that gateway becomes the peer on a WAN connection. If no default gateway is specified, the first connected peer on the WAN interface becomes the default gateway (recommended for remote applications when there are no other routers on the remote LAN).

For each profile in the Connection List that includes an IP address and has the **Configuration/Connection List/IP/Route/Static Route** option set to **Yes**, the Network Address of the specified IP address is added to the router table with the Host Address as the gateway. If the **Configuration/Connection List/IP/Route/Private** option is set to **No**, the route is advertised at the specified metric through the unit's interfaces as if a connection is active to that network. These routes are referred to as *spoofed routes*.

Attempts by any computer connected to the LAN interface to access a host on a spoofed network causes a connection to be attempted using the information from that Connection List profile. Once connected, routes advertised by the peer router are learned and advertised to the local LAN. If Bandwidth-On-Demand is enabled and an Idle Time-out value is specified, expiration of the Idle Timer causes the link to be disconnected; the routes learned from the peer router are retained if the **Configuration/Connection List/IP/RIP/Retain** option is set to **Yes** and advertised as if the connection is still active. These routes are referred to as *retained routes*. Attempts by any connected computer to access a host on any of the retained routes causes the link to be redialed. If **Hang Up** is activated from the Dial menu when the link is down, the retained routes are removed.

The Express 4100/4110 can be connected to two WAN destinations at the same time. Each B-channel is dialed to a different location. Routes learned from one WAN destination are advertised to the other using RIP.

IPX Routing

Like IP routing, the Express 4100/4110 can connect to two different sites and exchange IPX packets. Network routes and services are learned and advertised using Novell's RIP and SAP. Routes and services learned from a separate site can be retained in the Express 4100/4110 when the connection goes idle. While retained, the Express 4100/4110 can spoof RIP/SAP and watch-dog and filter serialization packets that would normally be required between the Novell server and client.

Connection List - Simplifying and Enhancing the Dial Function

The Connection List, which is accessed from the Configuration menu, provides a location to define information regarding 15 individual destinations that may be dialed. A Connection List entry is required for each destination since authentication information (method, username, password), number of B-channels, telephone numbers, Caller ID, IP, or IPX address (for routed connections), and other information can be stored for each destination defined. Defined destinations may be dialed by selecting the **Dial** activator in the Dial menu or by demand for the desired Connection List profile.

Concurrent Routing and Bridging

The Express 4100/4110 can route IP and IPX as well as bridge non-IP/IPX packets simultaneously. The Connection List profile will by default negotiate PPP network protocols to support the transmission and reception of IP, IPX, and Bridge packets. If the PPP peer does not accept a protocol, the Express 4100/4110 will fall back to any combination of routing and bridging.

Routing over PPP Bridging

The Express 4100/4110 can support legacy equipment which does not support PPP IP (IPCP) or IPX (IPXCP) protocols by allowing routing packets over the WAN connection using PPP Bridging (BCP). To perform this, the Express 4100/4110 uses a "virtual" Ethernet port. This port is set up under the **Configuration/Bridge** menu.

Network Address Translation Mode

NAT is a special mode of operation in which the Express 4100/4110 obtains a dynamically assigned IP address from the peer router (typically an Internet Service Provider). This allows a network of computers to benefit from Ethernet to ISDN speeds while still appearing to the Internet Service Provider (or central site router) as a single IP address, which is typical of PC based serial dial-up solutions.

A call is initiated to the ISP using the Dial menu or demand for a Connection List profile that has the IP parameter **NAT** set to **Yes**. The network computer's IP stack may use DHCP to request an IP address, default gateway address, and domain name server addresses from the Express 4100/4110.

Front Panel

"Express 4100/4110 LEDs" on page 1-11 shows the front panel of the Express 4100/4110. The indicators are divided into LAN functions, WAN functions, and Test functions.

LAN Indicators

- | | |
|--------------|--|
| TX/RX | Flashes green when transmitting data onto the 10BaseT connector.
Flashes yellow when receiving data from the 10BaseT connector. |
| LI | Link integrity. Illuminates when there is a good connection between the Express 4100/4110 and the Hub/NIC card. |

WAN Indicators

- | | |
|------------|--|
| PWR | Flashes when the link is inactive; solid when the link is active. |
| 1 | Flashes green when the link is being negotiated; off when the link is active. After the link is active, 1 flashes green when a call on POTS line 1 is in progress; solid green when a call is connected. |
| 2 | Flashes green when the link is being negotiated; off when the link is active. After the link is active, 2 flashes green when a call on POTS line 2 is in progress; solid green when a call is connected. |

Test Indicators

- | | |
|------------|--|
| 1/2 | A slow amber flash indicates test in progress; a fast amber flash indicates test has failed. |
|------------|--|

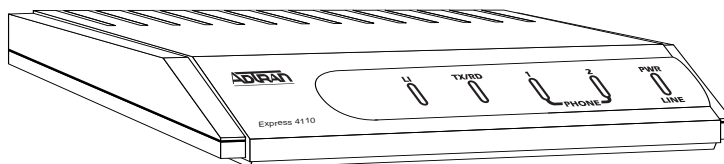

Figure 1-6. Express 4100/4110 LEDs

Rear Panel

The Express 4100/4110 has one RJ-49C jack, labeled **ISDN**, on the rear panel for network connection (see Figure 1-7). The **OFF/ON** switch block is for factory default and firmware downloading. With switch 1 in the up or **OFF** position, the 4100/4110 will go immediately into a download mode when power is enabled. Switch 1 must be in the down or **ON** position in order to boot up normally. Switch 2 in the up or **OFF** position will force the entire configuration to be factory defaulted.

ISDN Connection

From the network, ISDN is delivered by a single 2-wire 2B1Q U-interface which is connected directly to the Express 4100/4110. ISDN network termination is designed into the Express 4100/4110, eliminating the need and expense of a separate NT1. For network testing, the Express 4100/4110 responds to NT1 test commands from the telephone company central office (CO).

The Express 4100/4110 has one RJ-49C jack, labeled **ISDN**, on the rear panel for network connection (see Figure 1-7). ISDN basic rate service divides a standard telephone line into three digital channels capable of simultaneous voice and data transmission. The three channels are comprised of two bearer (B) channels at 64 kbps and one data (D) channel at 16 kbps, known as 2B+D.

The Express 4100/4110 also supports a leased digital connection allowing data to be transferred at up to 128 kbps over a 2-wire facility using the same RJ-49C jack. This type of service is a permanent connection between endpoints and is sometimes referred to as a leased connection, a dedicated connection, a nailed-up connection, or a private circuit. Leased connection or leased line is used in this manual to represent these types of services.

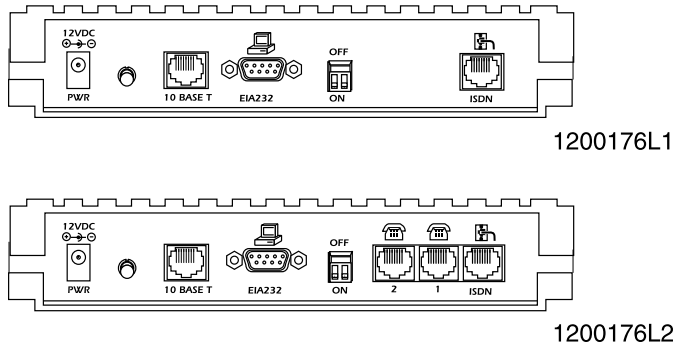

Figure 1-7. Express 4100/4110 Rear Panel

Ordering ISDN

When ordering ISDN from the telephone company, request **EZ-ISDN 1** (Capability Package U) to ensure it is set up properly. EZ-ISDN 1 is recommended by the industry for most home office/small business applications. If this is not available from your service provider or you would like more information regarding ordering ISDN, see the ADTRAN document *Ordering ISDN Service User Guide* part number 60000.015-8 or contact your telephone company for alternative line configurations. The *Ordering ISDN Service User Guide* is available on the ADTRAN home page at <http://www.adtran.com> or by calling ADTRAN.

Interoperability

The Express 4100/4110 is standards based and uses PPP developed by Internet Engineering Task Force (IETF). PPP provides a standard method of transporting multiprotocol datagrams over point-to-point links. PPP is widely accepted by many ISDN bridge/router manufacturers. The Express 4100/4110 will negotiate Multilink PPP when connecting both B-channels. The Bandwidth Allocation Protocol (BAP) may also negotiate, which enhances the management of adding and removing a B-channel. Data compression is also supported using LZS[®] technology from hi/fn[™].

Connecting to the Internet

Internet Service Providers (ISPs) assign an IP address to use when connected to their service using PPP negotiation. This assignment is based on the assumption that the user has an ISDN terminal adapter running PPP async-to-sync conversion or another rate adaption where the PPP negotiation is terminated inside the PC's IP stack. However, if an ISDN-Ethernet gateway device is used, the ISP must preassign the customer a subnet which uses multiple IP addresses. This may result in a much higher cost to the user.

The Express 4100/4110 permits the user to assign any IP addresses to the unit and computers. Operations on the network can occur normally. In fact, one B-channel can connect to the ISP using NAT while the other B-channel connects to another "private" or "fake" network. All packets transmitted or received over the ISP connection are translated. The Express 4100/4110 keeps track of the computers that request services over the Internet. A web server address can be assigned under the **Con-**

figuration/IP/NAT menu that allows incoming HTTP, FTP, and mail server requests from the Internet to be translated and forwarded to this address on the user network.

Configuration

The Express 4100/4110 is configured using a menu-based interface. This interface can be accessed via the maintenance port using any asynchronous VT 100 terminal or personal computer running a terminal emulation program, or via the LAN using a Telnet client program. To use the Telnet interface, the Express 4100/4110 must first have an IP address programmed into it via the maintenance port. The factory default is 10.0.0.1.

Security

Security on network devices is a major concern for almost anyone with a network. The Express 4100/4110 provides many tools for securing the local network from hostile users. Incoming calls can be authenticated using passwords and Caller ID. A RADIUS client can also be used.

The Telnet configuration can also be protected using the same authentication methods. Each menu item in the Express 4100/4110 has a security level associated with it. A Telnet session is assigned a privilege level which determines which menu items are accessible to the Telnet client. See “Security Levels” on page 3-7 (in Chapter 3) for more information on menu security levels.

Filters can be defined to prevent certain addresses or protocols from being transferred from LAN-to-WAN, WAN-to-LAN, or WAN-to-WAN.

After unpacking the unit, immediately inspect it for possible shipping damage. If damage is discovered, file a claim immediately with the shipping carrier; then contact the ADTRAN Repair and Return department.

ISDN NETWORK CONNECTION

The Express 4100/4110 supports either dial or leased operation. A single RJ-49C modular jack labeled **ISDN** on the rear panel provides connection to either network service.

Dial operation allows the user to dial out or receive calls over the public network.

The leased operation mode supports dedicated 2B1Q data service at rates up to 128 kbps by using a nailed up circuit, or a permanent connection between endpoints.

See “Connector Pinouts” on page D-1 for ISDN network connector pin assignments.

LOCAL AREA NETWORK CONNECTION

The Express 4100/4110 has a 10BaseT connector that provides half-duplex 10 Mbps operation over a 4-wire twisted pair.

Other types of Ethernet interfaces (i.e., AUI, 10Base2, etc.) can be accommodated by obtaining an appropriate converter.

TELEPHONE CONNECTION (4110 ONLY)

Basic Telephone Service

The Express 4110 supports an analog DTMF telephone type (AT&T 2500) with the POTS interface, part number 1200176L2. Two telephones or other analog devices (like a fax machine or modem) plug into either RJ-11 jack (labeled with drawings of telephones) on the rear of the unit. Using a multipoint line allows the POTS and data port to have unique phone numbers.

Supplementary Services

Supplementary services such as call holding, three- or six-way conferencing, call transfer, and call waiting are fully supported by the Express 4100/4110 on a touch-tone telephone. Table 2-1 explains how the flash-hook is used for handling multi-call situations.

DTMF Keypad

The following functions are performed on a touch-tone phone:

Disable call waiting:	Press **0
Enable call waiting:	Press **1
Redial last number:	Press **5
Enable ExpertISDN:	Press **6
Enter Area Code:	Press **7XXX (where XXX is a 3-digit area code. This must be entered first, before enabling ExpertISDN.)
Enter Phone Number 1:	Press **8XXXXXXXX (where XXXXXXX is the 7-digit phone number. This must be entered before enabling ExpertISDN.)
Enter Phone Number 2:	Press **9XXXXXXXX (where XXXXXXX is the 7-digit phone number. If only one phone number is assigned, this does not have to be entered.)

Table 2-1. Using the Flash-Hook

Calling a second party with an active call:

Flash-hook to place active call on hold and dial new number. Hanging up will terminate the call.

Answering an incoming call with an active call at call waiting:

Flash-hook to place active call on hold and answer incoming call. Hanging up will terminate both calls.

Conferencing Calls:

With an outgoing call on hold, and a second outgoing call active, flash-hook to conference calls. Hanging up will transfer second call.

With an incoming call on hold, and outgoing call active, flash-hook to conference calls. Hanging up will transfer calls.

With two incoming calls (one on hold and one active) flash-hook to conference calls. Hanging up transfers calls.

Answering calls on hold, and holding incoming active calls:

Flash-hook places the incoming call on hold and reconnects to outgoing call. Hanging up will terminate both calls.



NOTE

*When connecting to a National ISDN 1 switch, call conferencing and call transferring are assigned a unique feature identifier number. This number may not be the same in all areas. The **Configuration/WAN/POTS** menu contains the feature identifier numbers for conference and transfer. If these features do not work, contact your ISDN provider. They can determine the numbers for these features that can then be programmed into the Express 4100/4110.*

Customer Premises Wiring

Customer premises wiring requirements for the Express 4100/4110 vary depending on the application and existing wiring. It may be simpler for the ISDN provider to deliver another line to your location. This would eliminate the need to modify existing wiring. Figures 2-1 and 2-2 illustrate two wiring scheme possibilities.

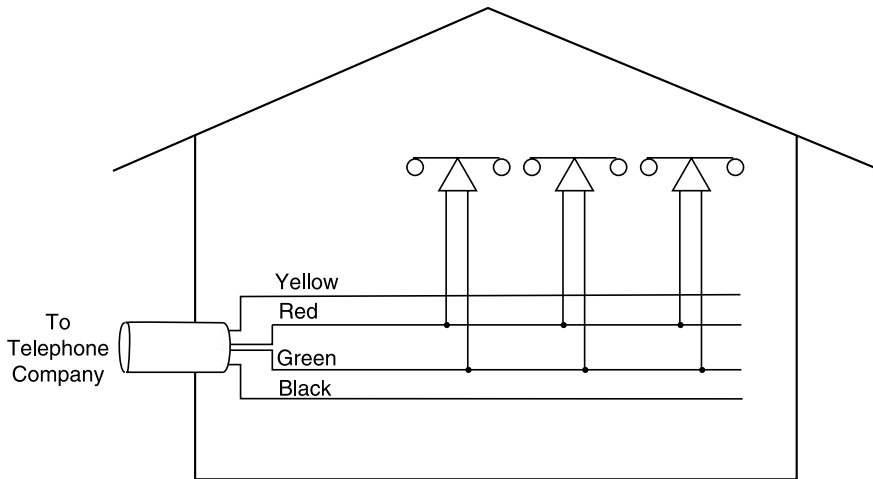

New Wiring Scheme

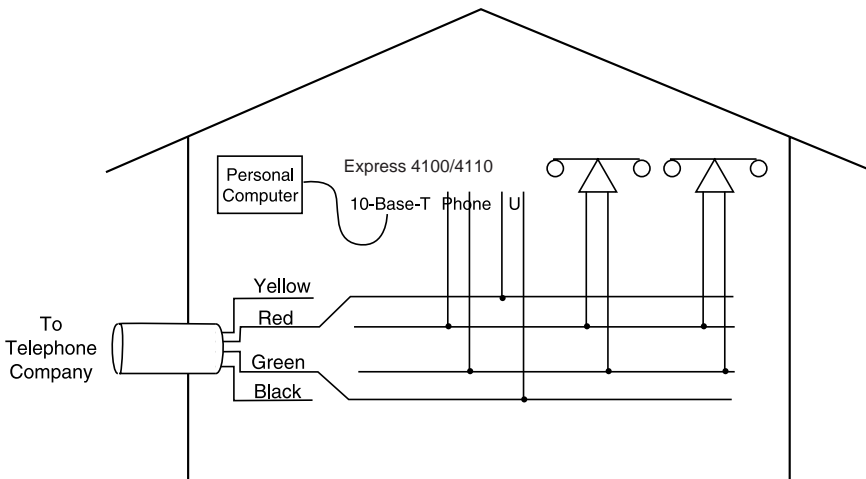

Figure 2-1. Wiring Scheme 1: Use existing analog telephone equipment, but replace single analog telephone service with ISDN service

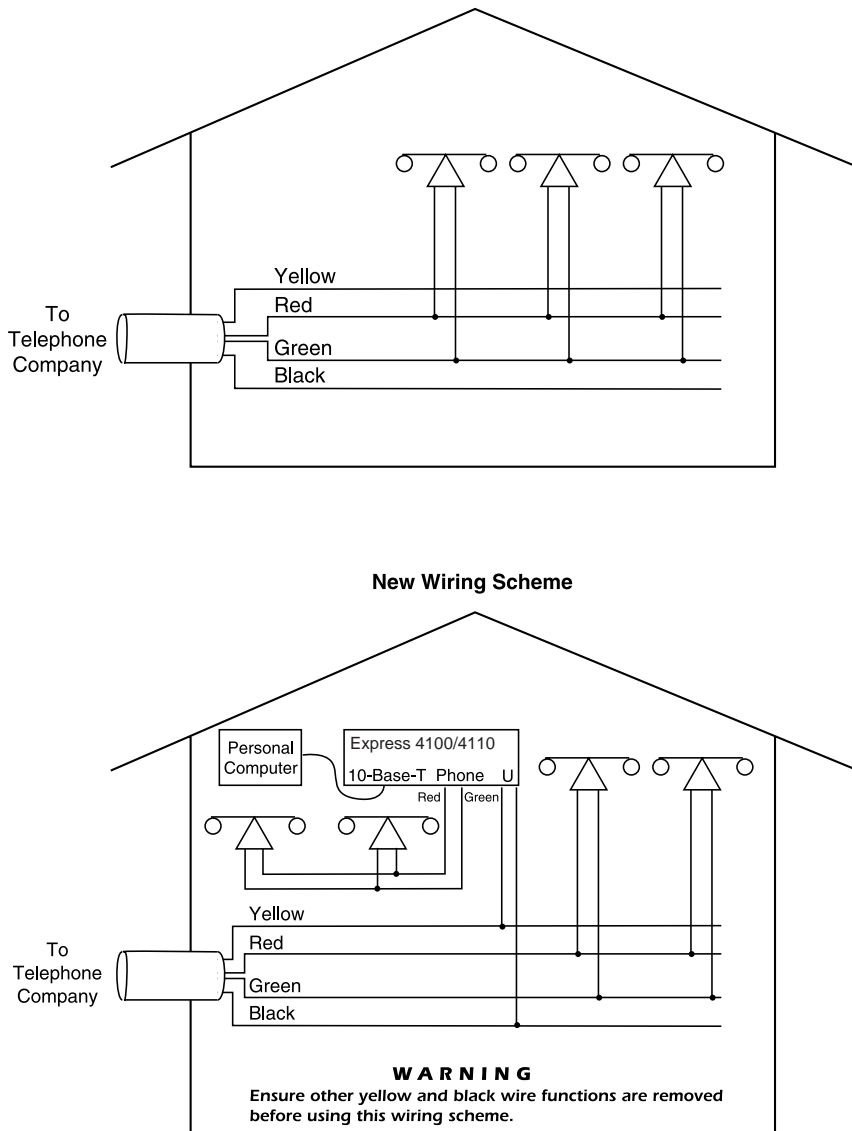

Figure 2-2. Wiring Scheme 2: Retain single analog telephone service and add ISDN service

Chapter 3 Terminal Menu Operation and Structure

TERMINAL MENU STRUCTURE

The Express 4100/4110 uses a multilevel menu structure containing both menu items and data fields. All menu operations and data display in the terminal menu window. The Express 4100/4110 is shipped in the Factory Default configuration. Connect any VT 100 or VT 220 type terminal emulator to the maintenance port. The default rate is 9600 baud 8-N-1. The terminal emulator can flow the Express 4100/4110 off using software flow control. Hardware flow control is not used.

The opening menu (the Main menu, or top-level menu) is the access point to all other operations. Each Main menu item has several functions and submenus to identify and access specific parameters. “Top Level Terminal Menu” on page 3-2 shows the top-level terminal menu. The Main menu options are described below.



In order to edit items in the terminal menus, you must have the appropriate security level. Each menu description in this section indicates the required security level required for write access. The maintenance port is always at security level 0, giving full access to all configuration items.

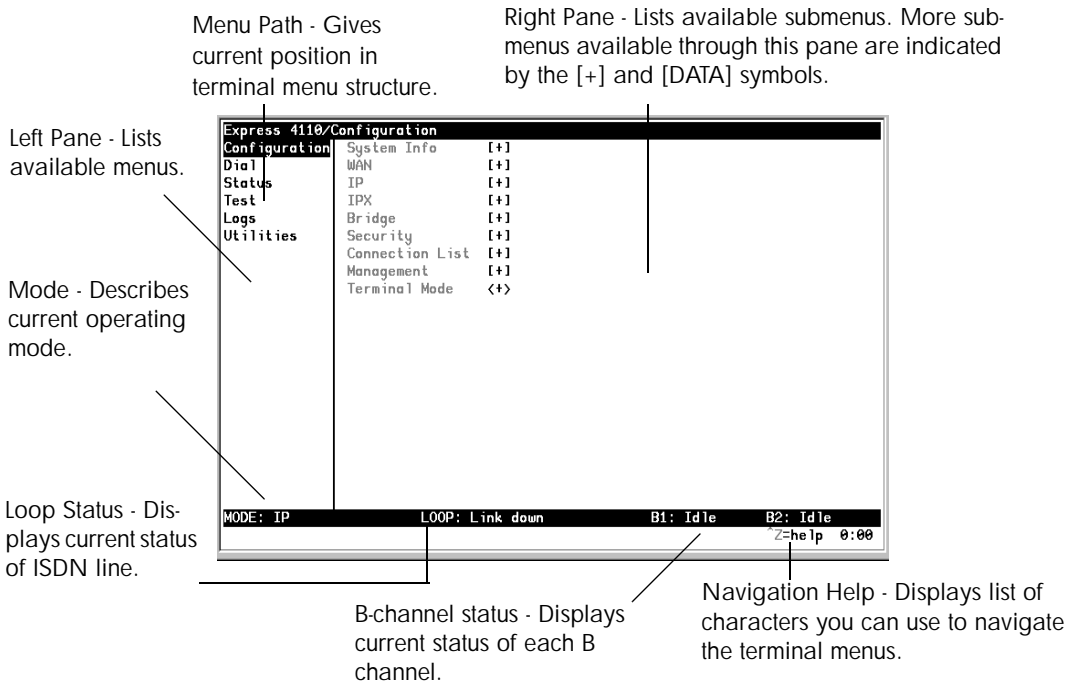

Figure 3-1. Top Level Terminal Menu

Configuration

The Configuration menu provides options to set up the operational configuration for the Express 4100/4110. See the section “Configuration Menu” on page 3-8 for detailed information.

Dial

The Dial menu is used to connect to different sites based on the Connection List. See the section “Dial Menu” on page 3-62 for more details.

Status

The Status menu provides options to review and monitor the status of the Express 4100/4110 system. See the section “Status Menu” on page 3-64 for detailed information on the available options.

Test

The Test menu can be used for performing diagnostic testing of the Express 4100/4110. See the section “Test Menu” on page 3-73 for detailed information on the tests available.

Logs

The Logs menu can be used for viewing the operational logs for the Express 4100/4110. See the section “Logs Menu” on page 3-74 for detailed information on the available options.

Utilities

The Utilities menu provides tools for system diagnostics and upgrading the Express 4100/4110. See the section “Utilities Menu” on page 3-78 for detailed information on the available options.

NAVIGATING THE TERMINAL MENUS

The following sections provide information on how to navigate through the terminal menus.

General Layout

When you first start a terminal mode session, the window shown in “Top Level Terminal Menu” on page 3-2 displays. The screen is divided into left and right panes. The left pane shows the current list of submenus, while the right pane shows the contents of a selected submenu.

Menu Path

The top line of the display shows this session’s current position (path) in the menu tree. Figure 3-1 shows the top menu level with the cursor on the Configuration submenu, so the path display shows **Express 4110/Configuration**.

Moving Around

Press **Tab** or the right arrow key to move the cursor from the left pane to the right pane. Press **Tab** or the left arrow key to move the cursor from the right pane back to the left pane. Use the up and down arrows to move around within each pane. Press **Enter** to activate a menu. Press the left arrow key or the **Escape** key to go back up the menu. The following options display throughout the menus.

Submenus **[+]** or **[DATA]**

Menus that display **[+]** or **[DATA]** indicate that more items are available when selected.

Activation Field **<+>**

Menus that display **<+>** indicate that an action is to be taken, such as activating a test.

Editable Data Field

A highlighted menu item indicates that you can enter data in that field.

Read-Only Field

An underlined field is a display field that contains read-only information.

Navigation with the Keyboard

You can use different keystrokes to navigate through the terminal menu. Press **Control-Z** to activate a pop-up screen with the available keystrokes. The following section provides a list of the available keystrokes and the results:

General Navigation	
H	Returns to the home screen.
J	Jumps between two menu items. Press J while on a menu item of interest, and you will jump back to the main screen. Go to another menu item of interest, Press J , and you will jump back to the screen that was displayed the first time you pressed J . Press J anytime you want to jump between these items.
Arrow Keys	Selects items and moves between the left and right panes. The left arrow key allows you to go back up the menu.
Enter	Activates an item or moves into submenu.
Escape	Cancels an edit. Allows you to go back up the menu. Also will dismiss the pop-up help screens.
Tab	Moves between the left and right panes.
A	Moves to the top of a screen.
Z	Moves to the bottom of a screen.
Backspace	Ascends one menu level.
Session Management	
Control-L	Logs out of the session.
Control-S	Invalidates the password entry and returns to the login screen. The Password prompt will display.
Control-R	Refreshes the screen. To save time, only the portion of the screen that has changed is refreshed. This option should be necessary only if the display picks up incorrect characters.

Configuration	
F	Restores factory default settings. This setting restores the factory defaults based on the location of the cursor. Entire submenus can be factory defaulted.
C	Copies selected items to the clipboard. The amount of information you can copy depends on the cursor location when you press C . For example, if the cursor is over an editable field, only that item is copied. If the cursor is over the index number of a list, then all of the items in the row of the list are copied. For example, if the cursor is over the Num field in the Connection List screen, all of the information associated with the Connection List entry is copied.
P	Pastes the item stored in the clipboard, if the information is compatible. You must confirm all pastes except those to a single editable field.
>	For certain types of fields, when you paste information into the field, the value increments by 1.
<	For certain types of fields, when you paste information into the field, the value decrements by 1.
I	Inserts a new item in a list. For example, add a new item to the Connection List by pressing I while the cursor is over the index number.
D	Deletes a list item. For example, delete an item from the Connection List by pressing D while the index number is active.

Security Levels

Each menu item on the configuration screens has an associated security level. The security level ranges from 0 (highest security level) to 5 (lowest security level). This level determines whether a Telnet session can access that menu item. The Telnet session is assigned a security level set by the user. Passwords can only be accessed as security level 0. The maintenance port is always at security level 0.

The security levels are assigned as follows:

Level

- | | |
|---|---|
| 0 | Access all parameters including passwords |
| 1 | Access all parameters except passwords |
| 2 | Access all parameters except passwords and authentication methods |
| 3 | Access all parameters except passwords, authentication methods, and ISDN parameters |
| 4 | Access only test and status menus |
| 5 | Access status menus only |

CONFIGURATION MENU

Configuration/System Info

The System Info menu provides basic information about the unit and displays data fields for editing information. Figure 3-2 displays the sub-menus available under this menu item.

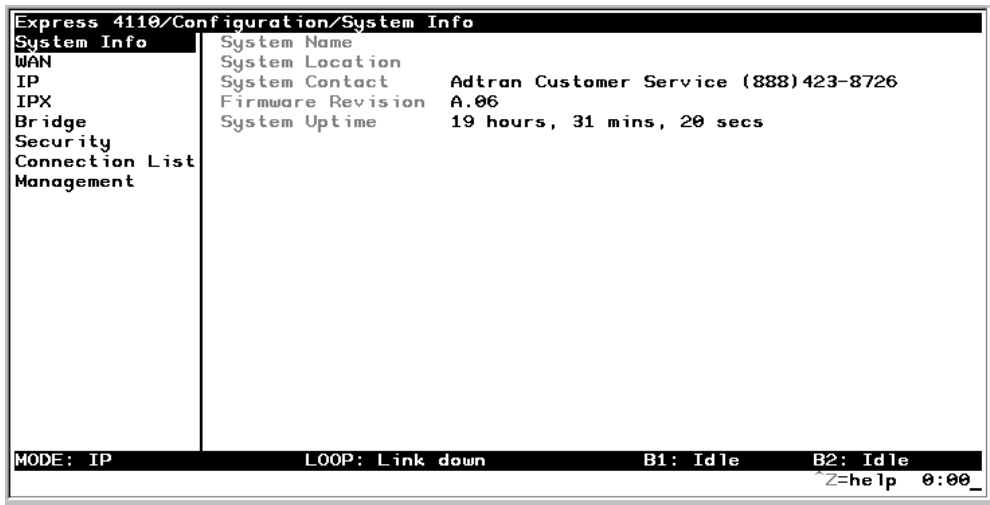

Figure 3-2. Configuration/System Info Screen

System Name

Write security: 3; Read security: 5

Provides a user configurable text string for the name of the Express 4100/4110. This name can help distinguish between different installations. You can enter up to 31 alpha-numeric characters in this field, including spaces and special characters (such as an under bar). The system name is also used for PPP authentication and IPX service name.

System Location

Write security: 3; Read security: 5

Provides a user configurable text string for the location of the Express 4100/4110. This helps to keep track of the physical location of the unit. You can enter up to 31 alpha-numeric characters in this field, including spaces and special characters (such as an under bar).

System Contact

Write security: 3; Read security: 5

Provides a user configurable text string for the contact name. This field can contain a name, phone number, or e-mail address of a person responsible for the Express 4100/4110. You can enter up to 31 alpha-numeric characters in this field, including spaces and special characters (such as an under bar).

Firmware Revision

Read security: 5

Displays the current firmware revision level of the Express 4100/4110. This field is a read-only field.

System Uptime

Read security: 5

Displays the length of time the Express 4100/4110 has been running since power up or reset. This field is a read-only field.

Configuration/WAN

The WAN menu is used to set up the ISDN parameters for the Express 4100/4110. Also, for the Express 4110, a POTS menu is provided. Figure 3-3 shows the WAN menu.

You can run the 4100/4110 with Frame Relay if you obtain the appropriate firmware. See “Frame Relay Firmware Version” on page F-1 for information.

NOTE

```

Express 4110/Configuration/WAN
System Info      ISDN  [+]
WAN              POTS  [+]
IP
IPX
Bridge
Security
Connection List
Management

MODE: IP          LOOP: Link down    B1: Idle    B2: Idle
Z=heIp 0:00
  
```

Figure 3-3. Configuration/WAN Screen

WAN/ISDN

Write security: 2; Read security: 5

Selects the mode the ISDN line is in. If connecting to the public network, select **Dial** (def). If connecting to a leased wire for back-to-back operation, select **Leased**.

ISDN/Dial Line

Dial Line parameters are entered under this menu.

Dial Line/ExpertISDN

Write security: 2; Read security: 5

The **ExpertISDN** option allows automatic determination of Service Profile Identifier (SPID) 1 and SPID 2 with entry of the Local Directory Number(s) (LDN(s)) and area code. Enter the 7-digit LDN in LDN 1 and LDN 2 (if a second number exists). The area code must be entered. The message **Auto Spid Success** will appear in the Call Log to indicate success in determining the SPID. See “Log Messages” on page B-1 for additional messages and their definitions.

Dial Line/Switch Protocol

Write security: 2; Read security: 5

Find out what kind of ISDN switch protocol the local CO is using by asking the local telephone administrator or the telephone company representative. The Express 4100/4110 can be configured for the following:

LUCENT 5ESS (def)	LUCENT 5ESS© Custom
DMS-100	Northern Telecom DMS-100™ Custom
National ISDN1	National ISDN-1 (could be a NorTel, LUCENT, or Siemens EWSD)
NEC	Nippon Electric Company Switch

Dial Line/Area Code

Write security: 2; Read security: 5

Enter 3-digit area code when using ExpertISDN.

Dial Line/SPID 1

Write security: 2; Read security: 5

The SPID is a sequence of digits used to identify ISDN terminal equipment to the ISDN switch. The SPID is assigned by the local phone company when the ISDN line is installed and it usually looks similar to the phone number. Obtain SPIDs from the telephone administrator or local telephone representative.

The number of SPIDs required (0, 1, or 2) depends on how your ISDN line is configured. For instance, a point-to-point line has no SPID. Multipoint lines may have one or two SPIDs. The Express 4100/4110 uses the presence of SPID 1 to determine if the line is

multipoint. If the line has only one SPID, then it must be entered in SPID 1.

SPID 1 =

0	1
---	---

 5 5 5 1 2 1 2

0

 SPID 2 =

0	1
---	---

 5 5 5 1 2 1 3

0



National ISDN1 switches require the addition of a two-digit terminal identifier (TID) at the end of the SPID.

Dial Line/LDN 1 or 2

Write security: 2; Read security: 5

This option allows the entry of 0, 1, or 2 LDNs. The LDN is used when placing or receiving calls. The LDN is the local phone number assigned to the line.

LDN 1 = 5 5 5 1 2 1 2

LDN 2 = 5 5 5 1 2 1 3



Disconnect the network interface from the unit before initially entering or altering the SPIDs and LDNs.

ISDN/Leased Line

Write security: 2; Read security: 5

Leased Line parameters are entered under this menu. Leased mode would be used for permanent circuits.

Leased Line/Clock Mode

Write security: 2; Read security: 5

The clock mode determines which unit will supply the clock for synchronization. If the two units are connected through channel banks, both units should be configured for Slave mode. The L100T only supports the slave mode.

Slave (def) Timing is derived from the master unit.

Leased Line/Channel Rate

Write security: 2; Read security: 5

64k Only B1 is used.

2x64k B1 and B2 go to different locations.

128k (def) B1 and B2 are used together.

ISDN/NEBEs

Read security: 5

This contains the number of Near-End-Block-Errors (NEBEs) that have been detected by the Express 4100/4110's ISDN circuitry. Continuous errors can indicate a line problem, but a burst at one time is normal.

ISDN/FEBEs

Read security: 5

This contains the number of Far-End-Block-Errors (FEBEs) that have been detected by the ISDN circuitry on the other end of the link. Continuous errors can indicate a line problem, but a burst at one time is normal.

WAN/POTS

Write security: 2; Read security: 5

POTS parameters are under this menu. They appear only under the Express 4110 version.

POTS/POTS Assignment

Write security: 2; Read security: 5

The Express 4110 can assign the POTS interface either **POTS1 to LDN 1 and POTS2 to LDN 2** (def), or **POTS2 to LDN 1 and POTS1 to LDN 2**. Once assigned, all incoming and outgoing calls on a particular port are placed to/from the assigned number.

POTS/NI-1 Conference FI

Write security: 2; Read security: 5

National ISDN Conference feature indication number is placed here. Most COs use the default of 60.

POTS/NI-1 Transfer FI

Write security: 2; Read security: 5

National ISDN Transfer feature indication number is placed here. Most COs use the default of 61.

POTS/Speech Calltype Routing

Write security: 2; Read security: 5

This allows the Express 4110 to treat incoming calls as “data over speech” when selected as **LAN**. Otherwise, when set to **POTS** (def), incoming speech calls are sent to the POTS when the destination number is the same as the POTS assignment.

Configuration/IP

The IP menu is used to set up the IP parameters for the Express 4100/4110. Any general IP-related configuration item is under this menu. Figure 3-4 shows the IP menu.

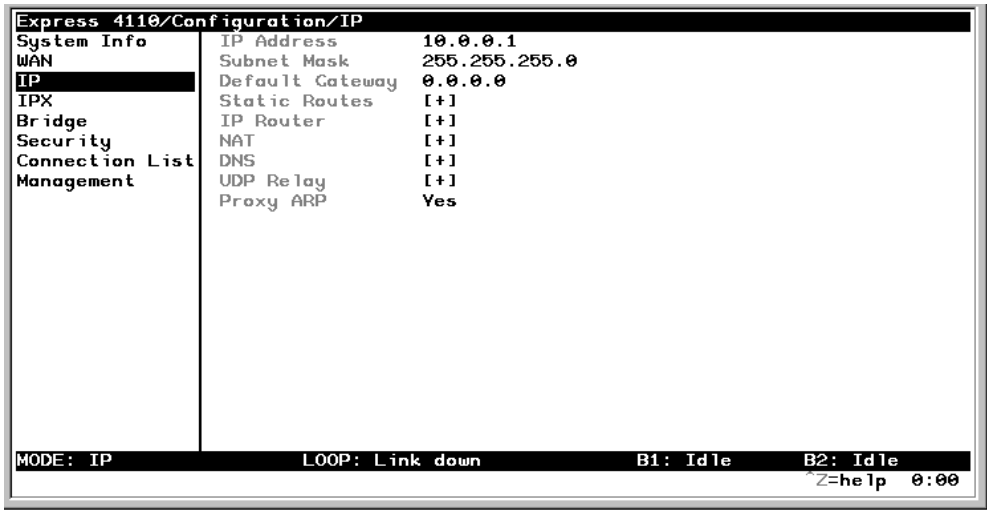

Figure 3-4. Configuration/IP Screen

IP/IP Address

Write security: 2; Read security: 5

The IP address assigned to the Express 4100/4110's Ethernet port is set here. This address must be unique within the network. Factory default is 10.0.0.1.

IP/Subnet Mask

Write security: 2; Read security: 5

The IP network mask to be applied to the Express 4100/4110's Ethernet port is set here. Factory default is 255.255.255.0.

IP/Default Gateway

Write security: 3; Read security: 5

The default gateway is used by the Express 4100/4110 for sending IP packets whose destination address is not found in the route table. If this address is all zeros, then the first WAN connection becomes the default gateway. If the address entered is not on the Ethernet segment, then an "idle route" entry is added to the route table.

IP/Static Routes

Static Routes can be inserted under this menu.

Static Routes/Active

Write security: 4; Read security: 5

Adds this static route entry to the IP routing table when set to **Yes** (def) and removes it (if it was previously added) if set to **No**.

Static Routes/IP Address

Write security: 4; Read security: 5

This is the IP address of the host or network address of the network.

Static Routes/Subnet Mask

Write security: 4; Read security: 5

This mask determines the bits in the previous IP address that are used. If this is to be a host route, it must be set to all ones (255.255.255.255).

Static Routes/Gateway

Write security: 4; Read security: 5

This is the IP address of the router to receive the forwarded IP packet.

Static Routes/Hops

Write security: 4; Read security: 5

This is the number of router hops required to get to the network or host. Maximum distance is 15 hops.

Static Routes/Private

Write security: 4; Read security: 5

When set to **No**, the Express 4100/4110 will advertise this static route using RIP. Otherwise, setting to **Yes** means that the route is kept private.

IP/IP Router

The IP router is configured under this menu as follows.

IP Router/Mode

Write security: 3; Read security: 5

When this option is set to **On** (def), the Express 4100/4110 will advertise and listen to routes from other IP routers. If **Off**, the route table is still used but only static routes are used for routing IP packets and only the Ethernet port is used. IP packets can be sent over the WAN, but only when bridged.

IP/RIP

Write security: 3; Read security: 5

The Routing Information Protocol (RIP) is supported by the Express 4100/4110. The following parameters are required for setting up the mode on the Ethernet port:

RIP/Mode

Write security: 3; Read security: 5

This option turns RIP **On** (def) or **Off**.

RIP/Protocol

Write security: 3; Read security: 5

Version can be **V1** (def) or **V2**.

RIP/Method

Write security: 3; Read security: 5

Split Horizon Only routes not learned on the Ethernet port are advertised.

Poison Reverse (def) All routes are advertised, including routes learned from the Ethernet port. These routes are poisoned.

None All routes are advertised, including routes learned from the Ethernet port. No attempt is made to poison these routes.

RIP/Direction

Write security: 3; Read security: 5

Tx and Rx (def) RIP advertisements are transmitted and listened to on the Ethernet port.

Tx only RIP advertisements are transmitted and not listened to.

Rx only RIP advertisements are listened to but not transmitted.

RIP/V2 Secret

Write security: 0; Read security: 0

This is a text string used for authenticating advertised routes.

IP/NAT

The Network Address Translation general parameters are set up under this menu.

NAT/DHCP Mode

Write security: 3; Read security: 5

When this option is set to **On**, the Express 4100/4110 acts as a DHCP server and will dynamically assign IP, network mask, default gateway, and DNS addresses to any device which transmits a broadcast DHCP request. The addresses assigned are based on the Express 4100/4110's own IP address and will be within the same network. This mode is most commonly used with the NAT functionality. The default is **Off**.

NAT/DHCP Renewal Time

Write security: 3; Read security: 5

This is the number of hours that the DHCP server should allow the device before it is required to send a new DHCP request. The default is 15 hours, and 0 represents an infinite lease.

NAT/Web Server

Write security: 3; Read security: 5

This is the IP address of a web server on the Ethernet network. When an active NAT connection is made to the Internet, any HTTP, FTP, or Mail server requests from the WAN are translated and sent to this web server.

IP/DNS

The Domain Name Server parameters used by the Express 4100/4110 are specified here. The DNS server addresses can be exchanged between PPP peers. When a connection occurs and IPCP is negotiated, the Express 4100/4110 will get the DNS server addresses from the PPP peer. If the configured DNS server addresses (**Server 1** and **Server 2**) are all zeros, the addresses from the PPP peer are used. In NAT mode, the PPP peer's DNS addresses are always used. The DNS addresses set in **Server 1** and **Server 2** are offered to a PPP peer if so requested.

DNS/Domain Name

Write security: 3; Read security: 5

This is a text string used to represent the domain name used by the Express 4100/4110.

DNS/Server 1

Write security: 3; Read security: 5

This is the IP address for the primary DNS device. It is the first server that domain name requests are sent.

DNS/Server 2

Write security: 3; Read security: 5

This is the IP address for the secondary DNS device. It is used a back-up in case the primary address does not respond to the request.

IP/UDP Relay

The Express 4100/4110 can be configured as a relay agent for UDP broadcast packets. Normally, a router will not forward UDP broadcast packets. However, many network applications use UDP broadcasts to configure addresses, host names, and other information. If hosts using these proto-

cols are not on the same network segment as the servers providing the information, the client programs will not receive a response without enabling the UDP relay agent.

UDP Relay/Mode

Write security: 3; Read security: 5

When this option is set to **On** (def), the Express 4100/4110 will act as a relay agent.

UDP Relay/UDP Relay List

Up to four relay destination servers can be specified in this list.

UDP Relay List/Relay Address

Write security: 3; Read security: 5

This is the IP address of the server that will receive the relay packet.

UDP Relay List/UDP Port Type

Write security: 3; Read security: 5

Standard (def) The following standard UDP protocols are relayed when set: DHCP, TFTP, DNS, NTP (Network Time Protocol, port 123), NBNS (NetBIOS Name Server, port 137), NBDG (NetBIOS Datagram, port 138), and BootP.

Specified When set, the UDP port (1 to 65535) can be specified in the UDP Port columns. (up to a maximum of three per server).

UDP Relay List/UDP Port 1, UDP Port 2, UDP Port 3

Write security: 3; Read security: 5

UDP Port 1, UDP Port 2, and UDP Port 3 are used for specifying UDP ports to be relayed. These fields only apply when **UDP Port Type** is set to **Specified**.

IP/Proxy ARP

Write security: 4; Read security: 5

This feature allows the network portion of a group of addresses to be shared between several physical network segments. The ARP protocol itself provides a way for devices to create a mapping between physical (i.e., Ethernet) addresses and logical IP addresses. Proxy ARP makes use of this mapping feature by instructing a router to answer ARP requests as a “proxy” for the IP addresses behind one of its ports. The device which sent the ARP request will then correctly assume that it can reach the requested IP address by sending packets to the physical address that was returned to it. This technique effectively hides the fact that a network has been (further) subnetted. If this option is set to **Yes** (def), when an ARP request is received on the Ethernet port the address is looked up in the IP routing table. If the forwarding port is not on the Ethernet port and the route is not the default route, the Express 4100/4110 will answer the request with its own hardware address. If set to **No**, the Express 4100/4110 will only respond to ARP requests received for its own IP address.

Configuration/IPX

The IPX menu is used to set up the IPX parameters for the Express 4100/4110. Any general IPX-related configuration item can be found under this menu. Figure 3-5 shows the IPX menu.

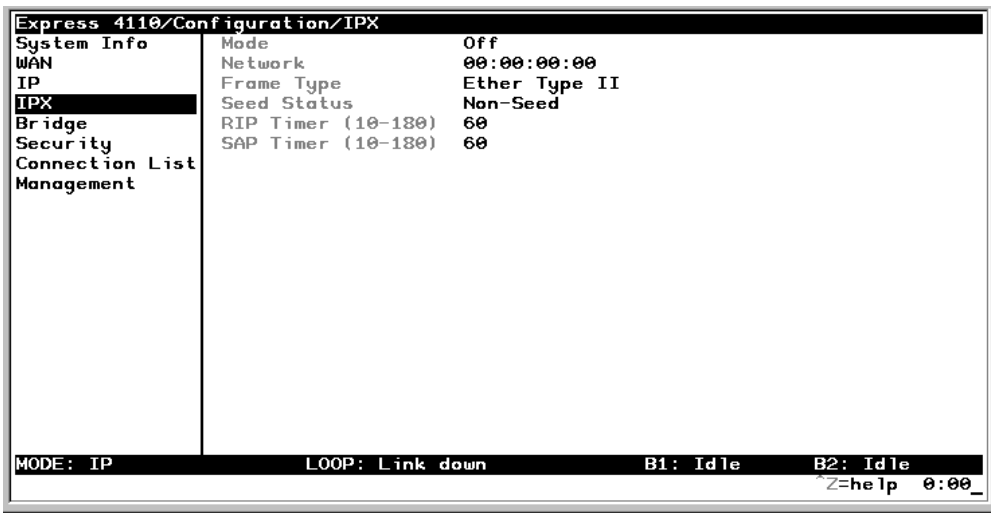

Figure 3-5. Configuration/IPX Screen

IPX/Mode

Write security: 2; Read security: 5

When this option is set to **On** (def), the Express 4100/4110 will route IPX. Setting it to **Off** will disable all IPX functionality.

IPX/Network

Write security: 2; Read security: 5

The IPX network address for the Ethernet port is set here. This is an eight-digit hexadecimal value that uniquely identifies the network segment of the Ethernet port. Accidental selection of an IPX network which is already in use on another network segment may cause hard-to-diagnose problems. IPX network numbers should be carefully tracked.

IPX/Frame Type

Write security: 2; Read security: 5

The Express 4100/4110 supports all four defined IPX frame types. The possible frame types are: **Ether Type II (def)**, **Ether 802.3 (Raw)**, or **Ether SNAP (802.2 SNAP)**. Only one frame type can be used at one time.

IPX/Seed Status

Write security: 2; Read security: 5

The seed status defines what the Express 4100/4110 is to do with the network information on the selected frame type during startup. There are three possible seeding selections specified:

- Seed** The Express 4100/4110 will listen for an IPX network number being sent by another router (including Novell software routers residing on servers) on the Ethernet segment connected to this port and use this number if it exists. If it doesn't discover a number in use, the Express 4100/4110 will use the configured IPX network number for the Ethernet segment.
- Non-Seed (def)** The Express 4100/4110 will listen for an IPX network number being sent by another router (including Novell software routers residing on servers) on the Ethernet segment connected to this port and use this number if it exists. If it doesn't discover a number in use, the Express 4100/4110 will wait indefinitely until a number is sent by another router on the Ethernet segment.
- Auto-Seed** The Express 4100/4110 will listen for an IPX network number being sent by another router (including Novell software routers residing on servers) on the Ethernet segment connected to this port and use this number if it exists. If it doesn't discover a number in use, the Express 4100/4110 will auto-generate a valid number using its routing tables.

IPX/RIP Timer

Write security: 3; Read security: 5

This value specifies how often the Express 4100/4110 sends out IPX RIP packets on the network segment attached to the Ethernet port. The RIP packets sent contain routing information about the networks for which this Express 4100/4110 is responsible. The default value is 60 seconds.

IPX/SAP Timer

Write security: 3; Read security: 5

This value specifies how often the Express 4100/4110 sends out IPX SAP (Service Access Protocol) packets on the network segment attached to the Ethernet port. The SAP packets sent contain information about the services (such as servers, printers, etc.) for which this Express 4100/4110 is responsible. The default value is 60 seconds.

Configuration/Bridge

The Bridge menu is used to set up the bridge parameters for the Express 4100/4110. The bridging function runs at the Media Access Control (MAC) level which allows any protocol packets that run over Ethernet to be forwarded. Bridging can run concurrently with the IP and IPX routing. However, certain rules apply for when packets are bridged across a WAN connection. When IP routing is active, IP packets (which include ARP packets) are not bridged. When IPX routing is active, IPX packets are not bridged. Also, the WAN IP Bridge and WAN IPX Bridge menus allow the WAN connection to bridge packets to the Express 4100/4110 but get routed as soon as they arrive at the unit. Figure 3-6 shows the Bridge menu.



Figure 3-6. Configuration/Bridge Screen

Bridge/Mode

Write security: 2; Read security: 5

When this option is set to **On** (def), the Express 4100/4110 bridge function will be enabled. Setting it to **Off** will disable all bridge functionality.

Bridge/WAN IP Bridge

When IP routing is active, the Express 4100/4110 will allow another WAN device to bridge IP packets to it using PPP BCP. Normally, two IP routers would negotiate PPP IPCP to exchange IP packets. However, if a device can only support PPP BCP, IP packets are encapsulated by the device as bridge packets. The Express 4100/4110 can treat the WAN IP Bridge as a virtual Ethernet port connected only to a WAN device which has negotiated PPP BCP. This menu allows the IP parameters for this virtual Ethernet to be set up.

WAN IP Bridge/Network

Write security: 2; Read security: 5

This is the IP address of the virtual Ethernet port.

WAN IP Bridge/Netmask

Write security: 2; Read security: 5

This is the network mask to be applied to the virtual Ethernet port.

WAN IP Bridge/Triggered

Write security: 2; Read security: 5

When set to **Yes**, only IP RIP updates are sent when the routing table has changed. When set to **No** (def), updates are sent periodically. RIP version, method, and direction are determined by the Ethernet parameters set in the **Configuration/IP/IP Router/RIP** menu.

WAN IP Bridge/Proxy ARP

If this option is set to **Yes** (def), the Express 4100/4110 will proxy ARP on the bridge IP port. See the section "IP/Proxy ARP" on page 3-21 for an explanation of the proxy ARP function.

Bridge/WAN IPX Bridge

When IPX routing is active, the Express 4100/4110 will allow another WAN device to bridge IPX packets to it using PPP BCP. Normally, two IPX routers would negotiate PPP IPXCP to exchange IPX packets. However, if a device can only support PPP BCP, IPX packets are encapsulated by the device as bridge packets. The Express 4100/4110 can treat the WAN IPX Bridge as a virtual Ethernet port connected only to a WAN

device which has negotiated PPP BCP. This menu allows the IPX parameters for this virtual Ethernet to be setup.

WAN IPX Bridge/Network

Write security: 2; Read security: 5

This is the network address of the virtual Ethernet port. See “IPX/Network” on page 3-22 for an explanation of the IPX network number.

WAN IPX Bridge/Frame Type

Write security: 2; Read security: 5

This is the frame type used for the virtual Ethernet port. See “IPX/Frame Type” on page 3-23 for an explanation of the IPX frame type.

WAN IPX Bridge/Seed Status

Write security: 2; Read security: 5

This is the seed status used for the virtual Ethernet port. See “*IPX/Seed Status*” on page 3-23 menu for an explanation of the IPX seed status.

WAN IPX Bridge/Triggered

Write security: 2; Read security: 5

When set to **Yes**, only IPX RIP and SAP updates are sent when the routing or service table has changed. When set to **No** (def), updates are sent at the same rate set for the Ethernet port (see “IPX/RIP Timer” on page 3-24 and “IPX/SAP Timer” on page 3-24).

Bridge/Address Table

The Express 4100/4110 automatically maintains a table of MAC addresses detected and associates those addresses with the LAN, WAN0, or WAN1 port from which they were received. This menu permits the user to adjust the parameters or rules for the table as addresses are learned.

Address Table/Aging

Write security: 3; Read security: 5

This is the maximum time an idle MAC address remains in the table before being removed. The value is in minutes and can range from 0 (which means never age) to 65535. The default is 5.

Address Table/Forward Policy

Write security: 3; Read security: 5

When this parameter is set to **Unknown** (def), any bridge packet with a destination MAC address that is not in the bridge table is forwarded to all other ports. When set to **Known**, the packet with the unknown destination MAC address is dropped and is not forwarded.

Configuration/Security

The Security menu is used to set up the authentication parameters needed to authenticate PPP connection over the ISDN B-channels. Also, the filter defines are placed under this menu. Figure 3-7 shows the Security menu.



Figure 3-7. Configuration/Security Screen

Security/Authentication

Write security: 1; Read security: 2

The method used for authenticating the PPP peer is selected here. The possible values are:

- None** (def) No attempt is made to authenticate the PPP peer.
- Radius** The Express 4100/4110 will act as a RADIUS client and authenticate the PPP peer using the RADIUS server. The Radius server parameters must be set up properly for this to work.
- Connection List** The Connection List profile is used to authenticate the PPP peer.

See “Configuration/Connection List” on page 3-36 for more information on authenticating.

Security/When

Write security: 1; Read security: 2

The Express 4100/4110 can be configured to authenticate the PPP peer (using the above method) for incoming calls using **Answer Only** (def), or for outgoing and incoming calls using **Originate and Answer**.

Security/Radius Server

The parameters for the radius server are configured in this menu. The RADIUS server can be used for authenticating a PPP peer (if defined under **Security/Authentication**) and for Telnet server sessions.

Radius Server/Primary Server

Write security: 1; Read security: 2

This is the IP address of the first RADIUS server that the Express 4100/4110 should attempt to communicate with when authenticating a PPP peer.

Radius Server/Secondary Server

Write security: 1; Read security: 2

This is the IP address of the back-up RADIUS server that the Express 4100/4110 should attempt to communicate with when the primary server does not respond.

Radius Server/UDP Port

Write security: 1; Read security: 2

This is the UDP port that the Express 4100/4110 should use when communicating with the RADIUS server. The default is 1645, which is the commonly used port.

Radius Server/Secret

Write security: 0; Read security: 1

The RADIUS server and Express 4100/4110 share this text string, which is used by the RADIUS server to authenticate the Express 4100/4110 that is the RADIUS client. The factory default is to not use a secret.

Radius Server/Retry Count

Write security: 1; Read security: 2

This is the number of times the Express 4100/4110 should send a request packet to the RADIUS server without a response before giving up. If the number of attempts to communicate with the primary server is equal to the retry count, the secondary server (if defined) is tried. If the secondary server does not respond within the retry count, the PPP peer (or Telnet session) is not authenticated and is dropped. The default is 5.

Security/PPP

Write security: 1; Read security: 2

The PPP peer can be authenticated using three standard methods: PAP (Password Authentication Protocol), CHAP (Challenge Handshake Protocol) and EAP (Extensible Authentication Protocol). The strength of the authentication is determined in the order EAP, CHAP, followed by PAP, where EAP is the strongest and PAP is the weakest. PAP is a clear-text protocol, which means it is sent over the PPP link in a readable format. Care must be taken not to allow highly sensitive passwords to become compromised using this method. CHAP and EAP use a one-way hashing algorithm which makes it virtually impossible to determine the password. EAP has other capabilities which allow more flexibility than CHAP.

The following selections are possible:

- | | |
|--------------------------------|--|
| PAP, CHAP, or EAP (def) | The Express 4100/4110 will ask for EAP during the first PPP LCP negotiation and allow the PPP peer to negotiate down to CHAP or PAP. |
| CHAP or EAP | The Express 4100/4110 will ask for EAP during the first PPP LCP negotiation and allow the PPP peer to negotiate down to CHAP but not PAP. |
| EAP | The Express 4100/4110 will only allow EAP to be negotiated. If the PPP peer is not capable of doing EAP, then the connection will not succeed. |

Security/Filter Defines

The Express 4100/4110 can filter packets based on certain parameters within the packet. The method used by the Express 4100/4110 allows the highest flexibility for defining filters and assigning them to a Connection List profile. The filters are set up in two steps: (1) defining the packet types, and (2) adding them to a list under the Connection List profile. See the section “Connection List/Filters” on page 3-53 for examples of how to set up filter profiles. This menu is used to define the individual filter defines based on packet type.

Filter Defines /MAC Filter Defines

Write security: 2; Read security: 3

The MAC filter is applied to bridge packets only. Bridge packets which are forwarded by the bridge functionality of the Express 4100/4110 are defined here. Up to 32 MAC defines can be specified.

Name	Identifies the filter entry
Src Addr	48-bit MAC source address used for comparison. (hexadecimal format)
Src Mask	Bits in the MAC source address which are compared. (hexadecimal format)
Dest Addr	48-bit MAC destination address used for comparison. (hexadecimal format)
Dest Mask	Bits in the MAC destination address used for comparison. (hexadecimal format)
MAC Type	16-bit MAC type field used for comparison. (hexadecimal format)
Type Msk	Bits in the MAC type field used for comparison. (hexadecimal format)

Filter Defines /Pattern Filter Defines

Write security: 2; Read security: 3

The pattern filter is applied to bridge packets only. That is any packet which is forwarded by the bridge functionality of the Express 4100/4110. Up to 32 pattern defines can be specified.

Name	Identifies the filter entry
Offset	Offset from beginning of packet of where to start the pattern comparison
Pattern	64 bits used for comparison. (hexadecimal format)
Mask	Bits in the pattern to be compared. (hexadecimal format)

Filter Defines /IP Filter Defines

Write security: 2; Read security: 3

The IP filter defines apply to any IP packet, whether it is routed or bridged. Up to 32 IP defines can be specified.

Name	Identifies the filter entry
IP Src	IP address compared to the source address. (dotted decimal format)
Src Mask	Bits which are used in the source comparison. (dotted decimal format)
IP Dest	IP address compared to the destination address. (dotted decimal format)
Dest Mask	Bits which are used in the destination comparison. (dotted decimal format)
Src Port	IP source port number used for comparison Range: 0 to 65535. (decimal format)
Src Port Cmpr	Type of comparison that is performed = means ports equal to not = means port not equal to > means port greater than < means port less than None means the source port is not compared

Dst Port	IP destination port number used for comparison Range: 0 to 65535. (decimal format)
Dst Port Cmpr	Type of comparison that is performed = means ports equal to not = means port not equal to > means port greater than < means port less than None means the destination port is not compared
Proto	Protocol used for comparison. Range: 0 to 255. (decimal format)
Proto Cmpr	Type of comparison that is performed = means protocols equal to not = means protocols not equal to > means protocols greater than < means protocols less than None means the protocol is not compared
TCP Est	Yes - only when TCP established No - only when TCP not established Ignore - ignore TCP flags

Filter Defines /IPX Filter Defines

Write security: 2; Read security: 3

The IPX filter defines apply to any IPX packet whether it is routed or bridged. Also, any IPX encapsulation type will be accounted for. Up to 32 IPX defines can be specified.

Name	Identifies the filter entry (15 characters max)
Src Net	32-bit source network address
Src Mask	Bits in the source network address which are compared. (hexadecimal format)
Dest Net	32-bit destination network address
Dest Mask	Bits in the destination network address which are compared. (hexadecimal format)

Src Socket 16-bit value which is the source socket. Range is 0-65535.

Src Socket Comp Type of comparison that is performed:

= means socket equal to

Not = means socket not equal to

> means socket greater than

< means socket less than

None - no comparison is done on source socket

Dest Socket 16-bit value which is the destination socket. Range is 0-65535.

Dest Socket Comp Type of comparison that is performed:

= means socket equal to

Not = means socket not equal to

> means socket greater than

< means socket less than

None - no comparison is done on destination socket

Type 8-bit value which is the IPX type

Type Comp Type of comparison that is performed:

= means type equal to

Not = means type not equal to

> means type greater than

< means type less than

None - no comparison is done on IPX type

Configuration/Connection List

The Express 4100/4110 uses the Connection List to specify the profile each user or group of users are to have when connected. Each profile or item in the Connection List has many configurable parameters giving high flexibility on a per user basis.

Up to 15 profiles can be defined in the Connection List. Calls cannot be originated or answered unless a Connection List profile is defined. The Express 4100/4110 factory defaults with one profile called **DEFAULT**. This profile is used for any incoming calls when **Configuration/Security/Authentication = None** or when the username of the connecting PPP peer is not found in the Connection List.

*To insert a new profile, press the **I** key when over the **Num** column. A new inserted profile will always be set up with the default parameters. To copy parameters from an old profile to this newly inserted profile, use the copy (**C**) and paste (**P**) keys. Entire configuration trees can be copied with this method.*

Figure 3-8 shows the Connection List screen.

Express 4110/Configuration/Connection List								
System Info	Num	Description	Active	Authentication	IP	IPX	Bridge	P
WAN	1	DEFAULT	Yes	[+]	[+]	[+]	[+]	
IP								
IPX								
Bridge								
Security								
Connection List								
Management								

MODE: IP LOOP: Link down B1: Idle B2: Idle
^Z=help 0:00

Figure 3-8. Configuration/Connection List Screen

Connection List/Description

Write security: 3; Read security: 4

The description is a text string that identifies the profile.

Connection List/Active

Write security: 3; Read security: 4

When set to **Yes** (def), this profile is used for authentication and user association of incoming calls. Setting to **No** is the same as deleting the item but allows the information of the profile to be saved.

To delete an unused profile, use the **D** key when the cursor is over the number in the **Num** column. Once deleted, the profile is gone permanently as soon as the Connection List is saved. Items may be deleted when **DEL** appears below the status bar.



NOTE

Connection List/Authentication

The authentication menu contains the required parameters for the authentication of the PPP peer and for being authenticated by the PPP peer.

Authentication is applied between the Express 4100/4110 and the PPP peer as follows:

1. The Express 4100/4110 as the authenticator:
 - When answering an incoming call:
 - Express 4100/4110 uses PPP method configured in **Configuration/Security/PPP**.
 - Authenticatee's username is looked up in all active Connection List profiles (**Rx Username**).
 - If found, the **Rx Password** is used for authenticating.
 - If not found, **DEFAULT** entry's **Rx Password** is used if **Rx Username** is blank.

*When answering a call, the Express 4100/4110 does not know who the PPP peer is until the authentication phase is completed. Two PPP protocols (EAP and CHAP) require the authenticator to transmit a username which the authenticatee uses to cross reference the password to use. Since the PPP peer is unknown before the authentication phase is over, the Express 4100/4110 uses the **Tx Username** in the **DEFAULT** profile to identify itself. If **Tx Username** is blank, **Configuration/System Info/System Name** is used. If that is blank, then the word "ADTRAN" is used.*



NOTE

- When originating an outgoing call:
 - Express 4100/4110 uses PPP method configured in **Configuration/Security/PPP**.
 - Authenticatee's username is compared to profile used to dial.
- Authenticating with RADIUS:
 - When **Configuration/Security/Authentication** is set to **Radius**, authentication is performed by the RADIUS server.
 - The Express 4100/4110 uses the **DEFAULT** Connection List profile for all other parameters not supported by RADIUS attributes.
 - RADIUS attributes currently supported are: framed ip, framed netmask, framed ipx network, framed routing, framed compression, and idle timeout.
- 2. The Express 4100/4110 as the authenticatee:
 - When answering an incoming call:
 - If the **Configuration/Security/Authentication** parameter is set to **None**, the **DEFAULT** profile's **Tx Username** and **Tx Password** are used by the Express 4100/4110 for authenticating itself.
 - If the **Configuration/Security/Authentication** parameter is set to **Connection List** or **RADIUS**, the Express 4100/4110 will wait until the PPP peer is authenticated before authenticating itself (except when CHAP or EAP is used). If CHAP or EAP is used, the username transmitted by the PPP peer's authentication challenge packet is looked up in the Connection List. If found, the Express 4100/4110 responds with the profile's **Tx Username** and **Tx Password** parameters. If not found, the **DEFAULT** profile's **Tx Username** and **Tx Password** parameters are used.
 - When originating an outgoing call:
 - The dial-out profile **Tx Username** and **Tx Password** are used regardless of the PPP peer's username received if CHAP or EAP is used.

Authentication/Tx Method

Write security: 2; Read security: 3

This parameter specifies how the Express 4100/4110 is to be authenticated by the PPP peer. There are four possible selections. See “Security/PPP” on page 3-31 for an explanation of the three PPP standard authentication types.

None (def)	The connection will not allow the PPP peer to authenticate it.
PAP, CHAP or EAP	The connection can be authenticated using PAP, CHAP or EAP.
CHAP or EAP	The connection can be authenticated using CHAP or EAP only.
EAP	The connection will only allow authentication by the peer using EAP.

Authentication/Tx Username

Write security: 1; Read security: 3

This is the username that is used when being authenticated by the PPP peer.

Authentication/Tx Password

Write security: 0; Read security: 1

This is the password or secret that is used when being authenticated by the PPP peer.

Authentication/Rx Username

Write security: 1; Read security: 3

This is the username that is used to match the user to the Connection List profile. During an incoming call, the Express 4100/4110 will scan all active connection profiles and match the received PPP peer’s username. If the name is not found, then the **DEFAULT** profile is used, if and only if the **DEFAULT** profile has nothing in the **Rx Username** parameter. During an outgoing call, this username does not have to match the username reported by the PPP peer.

Authentication/Rx Password

Write security: 0; Read security: 1

This is the password or secret that is used to authenticate the PPP peer. This is only necessary when **Configuration/Security/Authentication = Connection List**.

Authentication/Caller ID

Write security: 1; Read security: 3

Incoming calls can be verified using the ISDN supplied caller identifier when this is set to **Yes**. When set to **No** (def), the caller identifier is not checked.

Authentication/Call ID 1

Write security: 1; Read security: 3

The caller identification from the ISDN incoming call is compared to this number, starting from the right digits.

Authentication/Call ID 2

Write security: 1; Read security: 3

The caller identification from the ISDN incoming call is compared to this number, starting from the right digits.

Connection List/IP

The IP menu contains the parameters for exchanging IP data with the PPP peer. Static routes can also be created from here for IP dial-on-demand applications.

IP/Mode

Write security: 3; Read security: 5

Setting to **On** (def) will permit this connection profile to negotiate PPP IPCP with the PPP peer for exchanging of IP packets.

IP/NAT

Write security: 3; Read security: 5

The Express 4100/4110 can perform Network Address Translation. This feature is most widely used when connecting to the Internet. The Ether-

net network can consist of private network numbers. When this profile is connected, all IP addresses on the Ethernet side are translated into the one real IP address negotiated with the PPP peer (ISP). Multiple stations on the Ethernet side can access the Internet simultaneously. See the section “IP/NAT” on page 3-18 for more global options. Setting this option to **On** will cause the Express 4100/4110 to perform NAT. In the **Off** (def) position, the unit will route across the connection normally.

IP/Route

The IP parameters are configured in this menu. Adjusting these parameters is only necessary for certain dial-on-demand applications. Usually the Express 4100/4110 will automatically discover the PPP peer’s networks using PPP IPCP and/or RIP.

Route/IP/Net

Write security: 3; Read security: 5

The PPP peer’s IP address or network can be set here, if known. Leaving this at 0.0.0.0 means that the Express 4100/4110 will determine the PPP peer’s IP and network using the PPP IPCP.

Route/Netmask

Write security: 3; Read security: 5

This network mask is applied to the **IP/NET** address for determining the PPP peer’s network. If left as 0.0.0.0, a standard network mask is used.

Route/Static Route

Write security: 3; Read security: 5

When set to **Yes** (def), the Express 4100/4110 will add the network defined above as an idle route in the IP routing table. When an IP packet is routed to this idle route, the Express 4100/4110 will dial using this profile. When set to **No**, an idle route is not placed in the table. This is necessary for dial-on-demand applications and if the probe feature is not used.

Route/Private

Write security: 3; Read security: 5

When set to **Yes**, the Express 4100/4110 will not advertise this static route entry. A setting of **No** (def) means any static route added for this profile is advertised using RIP.

Route/Hops

Write security: 3; Read security: 5

This value is the metric or number of hops that RIP will use in advertising the static route. The range is 1 to 16 where 1 is the default. The value 16 is considered an infinite distance in RIP and is, in effect, poisoning the route.

Route/Force IP

Write security: 3; Read security: 5

When set to **Yes**, the Express 4100/4110 will force the PPP peer to use the IP address in the **IP/Net** for this profile as its WAN IP address. Normally this is set in the **No** (def) position.

IP/RIP

The RIP parameters can be adjusted from their defaults under this menu. The RIP parameters for all WAN connections are set on a per-session basis.

RIP/Mode

Write security: 3; Read security: 5

The Express 4100/4110 will perform RIP over the WAN connection when this is set to **On** (def).

RIP/Protocol

Write security: 3; Read security: 5

The Express 4100/4110 can perform version 1, **V1** (def), or version 2, **V2**, of RIP on this WAN connection.

RIP/Method

Write security: 3; Read security: 5

- Split Horizon** Only routes not learned on the WAN connection are advertised.
- Poison Reverse** (def) All routes are advertised, including routes learned from the WAN connection. These routes are poisoned.
- None** All routes are advertised, including routes learned from the WAN connection. No attempt is made to poison these routes.

RIP/Direction

Write security: 3; Read security: 5

- Tx and Rx** (def) RIP advertisements are transmitted and listened to on the WAN connection.
- Tx only** RIP advertisements are transmitted and not listened to.
- Rx only** RIP advertisements are listened to but not transmitted.

RIP/Triggered

Write security: 3; Read security: 5

When set to **Yes**, only IP RIP updates are sent when the routing table has changed and learned routes are not “aged.” When set to **No** (def), updates are sent periodically.

RIP/Retain

Write security: 3; Read security: 5

When this Connection List entry is disconnected and this parameter is set to **Yes**, all routes learned from this WAN connection are retained and their routing interface is set to idle. This permits dial-on-demand to occur using this profile for any IP network that might have been advertised by the particular PPP peer. The idle routes can be flushed or “zombied” from the routing table if a manual hangup is performed when this WAN connection is not active. See “Dial/Hang Up” on page 3-63. When this Connection List entry is disconnected and this parameter is set to **No** (def), routes learned from this session are “zombied” and are not retained.

Connection List/IPX

The IPX menu contains the parameters for exchanging IPX data with the PPP peer.

IPX/Mode

Write security: 3; Read security: 5

Setting to **On** (def) will permit this connection profile to negotiate PPP IPXCP with the PPP peer for exchanging of IPX packets.

IPX/Remote Network

Write security: 3; Read security: 5

A non-zero value in this remote network number will allow the Express 4100/4110 to add a route to the PPP peer's network to the routing table.

The Express 4100/4110 normally will treat the WAN network as an unnumbered link. This is usually referred to as being a "half-router." However, a PPP peer which wants to assign a network address to the WAN link can do so, in which case the Express 4100/4110 will go into "full-router" mode.

IPX/Triggered

Write security: 3; Read security: 5

When set to **Yes**, only IPX RIP and SAP updates are sent when the routing or service table has changed and learned routes are not "aged." When set to **No** (def), updates are sent periodically based on the RIP and SAP timers set in **Configuration/IPX/RIP Timer** and **Configuration/IPX/SAP Timer**.

IPX/Retain

Write security: 3; Read security: 5

When this Connection List entry is disconnected and this parameter is set to **Yes**, all routes learned from this WAN connection are retained and their routing interface is set to idle. This permits dial-on-demand to occur using this profile for any IPX network or service that might have been advertised by the particular PPP peer. The idle routes can be flushed or "zombied" from the routing table if a manual hangup is performed when this WAN connection is not active. See **Dial /Hang up**. When this Con-

nection List entry is disconnected and this parameter is set to **No** (def), IPX routes and services learned from this session are “zombied” and are not retained.

IPX/Type 20 Packets

Write security: 3; Read security: 5

In order for certain protocol implementations, like NetBIOS, to function in the NetWare environment, routes must allow a broadcast packet to be propagated throughout the IPX networks. The Type 20 IPX packet is used specifically for this purpose. This causes special handling of this packet by the Express 4100/4110. When a router receives this type of packet, it rebroadcasts it across all interfaces except the one it is received on and includes the network number of that interface in the data portion of the packet. The IPX Router Specification from Novell notes that Type 20 packets should not be propagated across slower links with bandwidths of less than 1Mbps (like ISDN). However, when set to **Pass** (def), the Express 4100/4110 will allow these packets to propagate over the WAN connection. This facilitates dial-on-demand applications. When set to **Block**, all Type 20 packets are not propagated across the WAN connection.

Connection List/Bridge

The Bridge menu contains the parameters needed for exchanging bridged packets with the PPP peer.

Bridge/Mode

Write security: 3; Read security: 5

When set to **On** (def), the Express 4100/4110 will attempt to negotiate PPP BCP with the PPP peer. Bridging can be used even in route mode only if the PPP peer cannot support certain PPP protocols for that particular routing protocol. See “Bridge/WAN IP Bridge” on page 3-26 and “Bridge/WAN IPX Bridge” on page 3-26 for further details.

Connection List/Probe

The Probe feature on the Express 4100/4110 is mainly used for allowing a network to have multiple virtual network connections to many destinations using the single ISDN link. The Express 4100/4110 can periodically obtain routing information from various locations and retain this in the routing tables, thereby permitting the LAN connection to be aware of the networks at this location. Probe helps keep route tables updated. When a service or network connection is required, the Express 4100/4110 can demand dial that location. This can be beneficial for remote IPX workstations that cannot boot up properly without knowing the IPX services that would be in the Express 4100/4110's SAP table.

Probe/Active

Write security: 3; Read security: 5

When set to **Yes**, the Express 4100/4110 will periodically dial this profiles dial-out number to get routing and service table updates. The default is **No**.

Probe/Interval

Write security: 3; Read security: 5

This is the time the Express 4100/4110 waits between probes. The value is in minutes and ranges from 1 to 240. The default is 15 minutes.

Probe/Update Window

Write security: 3; Read security: 5

This is the time the Express 4100/4110 stays connected during a probe. Normally route and service tables are exchanged immediately after connection. However, some routers could wait until their regular RIP or SAP time period has been reached before they advertise their routes or services to the Express 4100/4110. The value is in seconds and ranges from 5 to 180. The default is 5 seconds and assumes that a routing update is received upon connection.

Connection List/PPP

The Express 4100/4110 supports the IETF standards for the Point-to-Point Protocol. The PPP state machine running in the Express 4100/4110 can be fine-tuned to support many applications that can be employed. The configurable items under this menu can be changed from their default values for special cases.

PPP/Multilink

Multilink PPP allows the two B-channels to be used together for increased bandwidth.

Multilink/Mode

Write security: 3; Read security: 5

When this item is set to **On** (def), Multilink PPP is negotiated with the PPP peer. When **Off**, the Express 4100/4110 will only allow one B-channel for this connection.

Multilink/Fragment

Write security: 3; Read security: 5

When this item is set to **Yes** (def), the Express 4100/4110 will split outgoing packets greater than 128 bytes into two Multilink fragments and simultaneously transmit them one per B-channel. The receiving PPP peer will then reassemble them. This decreases the transport delay. However, some legacy equipment might have trouble handling fragmented packets, in which case this option should be set to **No**.

Multilink/BACP

Write security: 3; Read security: 5

The Bandwidth Allocation Control Protocol (BACP) and Bandwidth Allocation Protocol (BAP) are used to enhance Multilink PPP. Together, they allow phone numbers to be exchanged when more bandwidth is needed and member links to be dropped when bandwidth is to be decreased. When this item is set to **On**, BACP is negotiated with the PPP peer. When **Off**, the Express 4100/4110 will not run BACP/BAP but dynamic bandwidth can still be operated.

Certain rules for bandwidth-on-demand apply, depending on whether BACP is negotiated. If BACP is not negotiated, the originator of the call will perform the dynamic bandwidth adjustments on its own. If BACP is negotiated, the decisions are made on either side but the call is always from the originator.

PPP/Compression

Write security: 3; Read security: 5

The Express 4100/4110 uses LZS® technology from hi/fn™ (formerly known as STAC) for data compression. The Ascend Communications version of this compression is also supported. The Express 4100/4110 will automatically select the type of compression. Compression is negotiated when this item is set to **STAC** (def). No compression will be attempted when set to **None**.

PPP/VJ Compression

Write security: 3; Read security: 5

When this item is set to **On**, the Express 4100/4110 will perform TCP/IP header compression known as Van Jacobson compression to the PPP peer. Normally, this is not necessary over ISDN connections and can be set to **Off** (def) to disable it.

PPP/Max Config

Write security: 3; Read security: 5

This value is the number of unanswered configuration-requests that should be transmitted before giving up on a call. The possible values are 5, 10 (def), 15 and 20.

PPP/Max Timer

Write security: 3; Read security: 5

This value is the number of seconds to wait between unanswered configuration-requests. The possible values are 1 sec, 2 secs (def), 3 secs, 5 secs and 10 secs.

PPP/Max Failure

Write security: 3; Read security: 5

Due to the nature of PPP, configuration options may not be agreed upon between two PPP peers. This value is the number of configuration-naks that should occur before an option is configuration-rejected. This allows a connection to succeed that might otherwise fail. The possible values are 5 (def), 10, 15 and 20.

Connection List/Dial Out

The dialing parameters for establishing this connection are defined under this menu.

Dial Out/Number 1

Write security: 3; Read security: 5

This is the first number used for dialing up this connection.

Dial Out/Number 2

Write security: 3; Read security: 5

This is the second number used for dialing a second B-channel when adding bandwidth. If BACP/BAP is negotiated, this number is not necessary. If this number is not specified and BACP/BAP is not used, the **Number 1** number is re-dialed when adding bandwidth.

Dial Out/Call Type

Write security: 3; Read security: 5

The call type can be configured in four different ways:

Speech

Speech directs the call control software to request a Mu-law encoded speech circuit as the bearer capability for the outgoing calls. The speech option is used with an ISDN line configured for voice service. In some areas, voice service costs less than data services. A speech call type does not always guarantee an end-to-end digital connection with some local and long distance carriers.

- Audio** Audio directs the call control software to request a 3.1 kHz audio circuit as the bearer capability for the outgoing calls. The audio option is used with an ISDN line configured for voice service. In some areas, audio service costs less than data services. An audio call type does guarantee a digital end-to-end digital connection.
- 56K** 56K directs the call control software to request a 64 kbps data circuit that is rate-adapted to 56 kbps. Data 56 kbps is intended for use in circumstances where interoperability with Switched 56 service is desired.
- 64K (def)** The default call type for ISDN service is Data 64 kbps. This directs the call control software to request an unrestricted 64 kbps circuit.

Dial Out/Redial at 56K

Write security: 3; Read security: 5

Selecting **Yes (def)** causes the Express 4100/4110 to re-dial a call at the 56K call type if a 64K call type was unsuccessful. This will not occur if set to **No** or if the original call type was other than 64K.

Dial Out/Delay

Write security: 3; Read security: 5

This is the number of seconds between unsuccessful call attempts made during dial-on-demand or during dynamic bandwidth. The range is between 0 and 255, with a default of 15 seconds.

Dial Out/Connection Timeout

Write security: 3; Read security: 5

This is the amount of time the Express 4100/4110 waits for a call to be answered before giving up the attempt. Possible values are 15 secs (def), 30 secs, 1 min, 2 mins and 4 mins.

Dial Out/Attempts

Write security: 3; Read security: 5

This value is the number of attempts the Express 4100/4110 will make before giving up on the connection. This is effective for manual dialing or dynamic bandwidth calls only. The range is from 1 (def) to 255.

Dial Out/Initial Channels

Write security: 3; Read security: 5

This is the number of B-channels to dial-up on the initial connection. Possible choices are 1 (def) and 2.

Connection List/Bandwidth

The bandwidth parameters that govern this connection are set here.

Bandwidth/On Demand

The parameters under this menu control the data rates required to change bandwidth.

Bandwidth/Mode

Write security: 3; Read security: 5

When this option is set to **On**, the Express 4100/4110 will apply its bandwidth-on-demand features for this Connection List profile. If set to **Off**, none are performed.

Bandwidth/Idle Timeout

Write security: 3; Read security: 5

This is the number of seconds the ISDN line must be idle before hanging up this connection. A value of 0 (def) means the Express 4100/4110 will never drop the link based on the idle timer. The range is 0 to 255.

Bandwidth/Preempt Time

Write security: 3; Read security: 5

Occasionally an application will require to connect to a different location before the current connection's idle timer has timed out. This causes the application to have to wait for idle timer before it can use the B-channel. This preempt time allows the Connection List that is active to be dropped sooner than the normal idle time.

The value ranges from 0 to 255 and is in seconds. When bandwidth is needed for another application, the idle timer is compared to this preempt time. If the idle timer is greater, the connection is preempted. If set to 255 (def), the connection is never preempted. If set to 0, the connection is disconnected immediately when another application is requested.

Bandwidth/Upper Threshold

Write security: 3; Read security: 5

This is the percentage of bandwidth that must be at least present on one B-channel before a second B-channel is added. The range is 0 to 100 and is in percentages. The default is 80%, which is equivalent to 51.2 kbps. See the section *Bandwidth/Samples* (below) for more information on how the bandwidth rate is calculated.

Bandwidth/Lower Threshold

Write security: 3; Read security: 5

This is the percentage of maximum bandwidth the bit rate must go below on two B-channels before one is dropped. The range is 0 to 100 and is in percentages. The default is 30%, which is equivalent to 38.4 kbps. See the section *Bandwidth/Samples* (below) for more information on how the bandwidth rate is calculated.

Bandwidth/Min Channels

Write security: 3; Read security: 5

This represents the minimum number of B-channels that must be up for this Connection List profile. This value ranges from 0 to 2. The default is 0.

Bandwidth/Max Channels

Write security: 3; Read security: 5

This represents the maximum number of B-channels this Connection List profile can have. The allowed values are 1 and 2. The default is 2. A value of 1 means that no extra bandwidth can be obtained for this connection.

Bandwidth/Samples

The parameters under this menu control the rate at which the Express 4100/4110 samples the bandwidth on the B-channel(s).

Samples/Sample Rate

Write security: 3; Read security: 5

This is the time between samples used for calculating data rates on the ISDN call. The value is in seconds and ranges from 1 to 255. The default is 5 seconds.

Samples/Samples

Write security: 3; Read security: 5

This is the number of WAN data rate samples taken before a decision to change bandwidth is performed. The range is 1 (def) to 255 samples.

Samples/Time Between Changes

Write security: 3; Read security: 5

This value is the minimum time between bandwidth changes for this Connection List profile. The range is 0 to 255 seconds. The default is 60 seconds.

Connection List/Filters

The Express 4100/4110 can block packets in and out of a WAN port by use of the filters. These filters are set up on a per-Connection List profile basis. They are set up in two steps: 1) define the types of packets that would be of interest in the **Configuration/Security/Filter Defines** menu, and 2) set up the filter type and combination of defines that will cause a packet block.

Filters/WAN-to-LAN (In)

Write security: 2; Read security: 5

The packets which come into the Express 4100/4110 can be filtered in three ways:

Disabled (def)	Turns off packet input filtering. No incoming packets are blocked.
-----------------------	--

- Block All** All incoming packets from the WAN are blocked except as defined in the **Filters/In Exceptions** list.
- Forward All** All incoming packets from the WAN are not blocked except as defined in the **Filters/In Exceptions** list.

Filters/In Exceptions

Write security: 2; Read security: 5

This is a list of up to 32 filter entries which can be combined using the operations field. The operations are performed in the order they appear on the list.

- Active** Turns this entry active when set to **On**.
- Type** Selects the filter define list to reference:
- MAC** from the **Configuration/Security/Filter Defines/MAC Filter Defines** list.
 - Pattern** from the **Configuration/Security/Filter Defines/Pattern Filter Defines** list.
 - IP** from the **Configuration/Security/Filter Defines/IP Filter Defines** list.
 - IPX** from the **Configuration/Security/Filter Defines/IPX Filter Defines** list.
- Filter List Name** Selects between filters defined in the list.
- Next Oper** The next operation to use to combine with the next filter in the list:
- END** the last filter to combination.
 - AND** logically AND this filter with the next filter in the list.
 - OR** logically OR this filter with the next filter in the list.

Filters/LAN-to-WAN (Out)

Write security: 2; Read security: 5

The packets which come out toward the WAN from the Express 4100/4110 can be filtered in three ways:

- Disabled** (def) Turns off packet output filtering. No outgoing packets are blocked.
- Block All** All outgoing packets to the WAN are blocked except as defined in the **Filters/Out Exceptions** list.
- Forward All** All outgoing packets to the WAN are not blocked except as defined in the **Filters/Out Exceptions** list.

Filters/Out Exceptions

Write security: 2; Read security: 5

This is a list of up to 32 filter entries. The setup is exactly the same as the **Filter/In Exceptions** list.

Filters/Demand Dial

Write security: 2; Read security: 5

The demand dial filters have two purposes: 1) cause the Express 4100/4110 in Bridge mode to dial this Connection List profile, and 2) determine which traffic will cause the idle timer to be reset, keeping the connection active. The latter is used in Bridge or IP/IPX Router mode. The idle timer is a timer in the Express 4100/4110 which continually increments until it reaches the idle time-out parameters value set in the Connection List, at which point the connection is hung-up.

When this filter is enabled, direct control can be placed over which packets are considered as demand and which are ignored. Packets that are ignored cause a connection not to be dialed and do not reset the idle timer of an active connection. This is especially helpful for bridged connections since bridges cannot easily distinguish true demand traffic from

overhead traffic like certain broadcast and multicast packets. There are three possible selections for this parameter:

- | | |
|-----------------------|--|
| Disabled (def) | Turns off demand dial filtering. No packets cause demand dialing for this profile and all outgoing and incoming packets reset the idle timer. |
| Ignore All | When connected in any mode (Bridge, IP Router, or IPX router), the idle timer is reset only when there is a match in the Filters/Dem Dial Exceptions list. When not connected in Bridge mode only, causes the Express 4100/4110 to dial using this Connection List profile if there is a match in the Filters/Dem Dial Exceptions . |
| Demand All | When connected in any mode (Bridge, IP Router, or IPX router), the idle timer is always reset except when there is a match in the Filters/Dem Dial Exceptions list. When not connected in Bridge mode only, causes the Express 4100/4110 to dial using this Connection List profile if there is NOT a match in the Filters/Dem Dial Exceptions list. |

Filters/Dem Dial Exceptions

Write security: 2; Read security: 5

This is a list of up to 32 filter entries. The setup is exactly the same as the **Filter/In Exceptions** list.

Configuration/Management

The Express 4100/4110 can be managed using Telnet, Simple Network Management Protocol (SNMP), or the maintenance port. SNMP support is limited to MIB definitions. See “SNMP” on page C-1 for a description of the MIBs supported by the Express 4100/4110. Each of the three methods can be protected using authentication. Figure 3-9 shows the Configuration/Management menu.

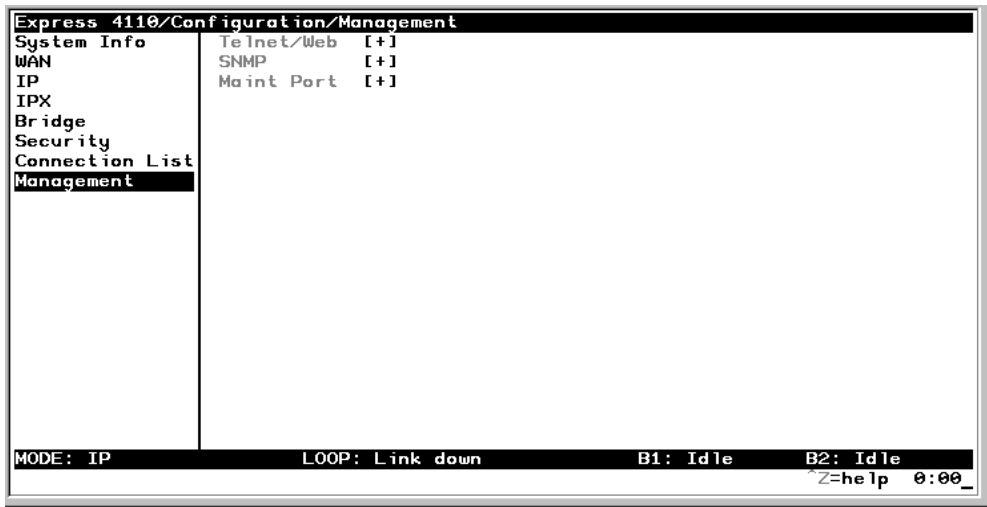

Figure 3-9. Configuration/Management Screen

Management/Telnet/Web

Any telnet client application can bring up a session to the Express 4100/4110’s Telnet server using the standard telnet TCP port. Only one session is supported at a time. All sessions require a user name and password.

Telnet/Server Access

Write security: 2; Read security: 5

This option must be set to **On** (def) to access the Express 4100/4110 via Telnet. Turning it **Off** means that access is denied.

Telnet/User List

Up to four users can be configured for access to the Express 4100/4110. Each user can be assigned a privilege and time out.

User List/Name

Write security: 1; Read security: 3

A text string of the user name for this session.

User List/Authen Method

Write security: 1; Read security: 3

The user can be authenticated in two ways:

- | | |
|-----------------|--|
| Password | The Password field is used to authenticate the user. |
| Radius | The Radius client is used for authenticating the user. |

User List/Password

Write security: 0; Read security: 3

When the authenticating method is password, this text string is used for the password.

User List/Idle Time

Write security: 1; Read security: 3

When set to non-zero, the session is automatically logged out when no activity occurs for this amount of time. The range is 0 to 255 and is in minutes. The default is 10 minutes, and a setting of 0 will never time out the session. When a timeout occurs during an edit session, all changes are saved.

User List/Level

Write security: 0; Read security: 1

This is the security level privilege that is assigned for this user. See “Security Levels” on page 3-7 for an explanation of what those levels imply. Level 0 is the default.

Management/SNMP

The Express 4100/4110 is an SNMP agent. It can respond to Get-Requests and generate traps. These two lists set up the manager, communities, and levels. See “SNMP” on page C-1 for more information on SNMP.

SNMP Access

Write security: 3; Read security: 5

When set to **No**, SNMP access is denied. When set to **On** (def), the Express 4100/4110 will respond to SNMP managers based on the following lists.

SNMP/Communities

This list is used to set up to eight SNMP communities names that the Express 4100/4110 will allow. Factory default sets the community “public” with “Get” privileges.

Communities/Name

Write security: 1; Read security: 3

This is a text string for the community name.

Communities/Privilege

Write security: 1; Read security: 3

The access for this manager can be assigned three levels.

None	No access is allowed for this community or manager.
Get	Manager can only read items.
Get/Set	Manager can read and set items.

Communities/Manager IP

Write security: 1; Read security: 3

This is the IP address of SNMP manager. If set to 0.0.0.0, any SNMP manager can access the Express 4100/4110 for this community.

SNMP/Traps

The Express 4100/4110 can generate SNMP traps. See “SNMP” on page C-1 for trap types supported. This list allows up to four managers to be listed to receive traps.

Traps/Manager Name

Write security: 2; Read security: 4

This is the text string describing the name of the entry. It is intended for easy reference and has no bearing on the SNMP trap function.

Traps/Manager IP

Write security: 2; Read security: 4

This is the IP address of the manager that is to receive the traps.

Management/Maint Port

The Express 4100/4110 has an EIA-232 connector on the back of the unit. The setup for that port is under this menu.

Maint Port/Password Protect

Write security: 0; Read security: 1

When set to **No**, the maintenance port is not password protected. When **On** (def), the Express 4100/4110 will prompt for a password upon startup.

Maint Port/Password

Write security: 0; Read security: 1

This is the text string that is used for comparison when password protecting the maintenance port. By default, no password is entered.

**NOTE**

The security level for the maintenance port is always set to 0. This gives full access to all menus.

Maint Port/Baud Rate

Write security: 5; Read security: 5

This is the asynchronous rate that the maintenance port will run. The possible values are 300, 1200, 2400, 4800, 9600 (def), 19200, 38400, 115200.

Maint Port/Data Bits

Write security: 5; Read security: 5

This is the asynchronous bit rate that the maintenance port will run. The possible values are 7 or 8 (def) bits.

Maint Port/Parity

Write security: 5; Read security: 5

This is the asynchronous parity that the maintenance port will run. The possible values are **None** (def), **Odd**, or **Even**.

Maint Port/Stop Bits

Write security:5; Read security:5

This is the stop bit used for the maintenance port. The possible values are 1 (def), 1.5 or 2.

Configuration/Terminal Mode

This is an activator which places the Express 4100/4110 terminal session into a command prompt mode. All menu options are accessible during this mode. See “Terminal Mode Commands” on page E-1 for the command structure and command list. Type **exit** to leave the terminal mode and return to the menus.

DIAL MENU

The Dial menu is used for dialing the Connection List profile setup under **Configuration/Connection List** and for checking the status of each Connection List. This list is in the same order as the Connection List entries. Figure 3-10 shows the Dial menu.

Num	Description	Dial	Hang Up	Status	Channels
1	DEFAULT	<+>	<+>	no call	0

Figure 3-10. Dial Screen

Dial/Description

Read security: 5

This read-only field is the name entered for the profile under **Configuration/Connection List/Description**.

Dial/Dial

Write security: 4; Read security: 5

This is an activator used for dialing the phone numbers in the profile. Place the cursor over the field and press **Enter** to activate the dialing function.

Dial/Hang Up

Write security: 4; Read security: 5

This is an activator used for hanging up a Connection List entry. It also removes retained routes from the IP and IPX routing tables when the call is not connected. Place the cursor over the field and press **Enter** to activate the hang up function.

Dial/Status

Read security: 5

This reflects the current status of the call:

No call	No call is active for this Connection List profile.
Connecting	Outgoing call is being placed for this profile.
Ringing	Incoming call is being answered with this profile.
PPP negotiating	Call is connected and is bringing up PPP.
Active	A session with this profile is active.

Dial/Channels

Read security: 5

This is the number of B-channels being used for this call.

Dial/Number 1

Read security: 5

This read-only field is the number entered for the profile under **Configuration/Connection List/Dial Out/Number 1**.

Dial/Number 2

Read security: 5

This read-only field is the number entered for the profile under **Configuration/Connection List/Dial Out/Number 2**.

STATUS MENU

The Express 4100/4110's Status menu contains comprehensive status and diagnostic information used in verifying configuration and identifying problems. The menus are divided into protocol types and sessions. Figure 3-11 shows the Status menu.



Figure 3-11. Status Screen

Status/Call Sessions

This menu contains the current status of all dial-in sessions and spanning tree ports.

Call Sessions/Session1 and Call Sessions/Session2

Read security: 5

The Express 4100/4110 can support up to two active connections at one time. These two menus reflect the results of PPP negotiations, user name, time connected, idle timer, and data rates for the session.

PPP Links	Reflects LCP layers active
BCP	Shows UP if PPP Bridge Control Protocol has negotiated successfully
IPCP	Shows UP if PPP IP Control Protocol has negotiated successfully
IPXCP	Shows UP if PPP IPX Control Protocol has negotiated successfully
CCP	Shows UP if PPP Compression Control Protocol has negotiated successfully
BACP	Shows UP if PPP Bandwidth Allocation Control Protocol has negotiated successfully
User	Displays the user name of the PPP peer
Number(s)	Shows the phone number dialed if outgoing call or caller ID if incoming call
Connect Time	Shows the date and time when the call last connected
Up Time	Displays how long the call has been connected
Idle Timer	Current value of the idle timer (number of seconds since filtered packet was passed through)
Tx Pkts	Number of packets transmitted
Rx Pkts	Number of packets received
Tx Bytes	Number of bytes transmitted
Rx Bytes	Number of bytes received

Tx Rate	Current application data transmission rate
Rx Rate	Current application data reception rate
Tx Link Rate	Current actual data transmission rate
Rx Link Rate	Current actual data reception rate
Tx Comp Ratio	Current transmission compression ratio
Rx Comp Ratio	Current reception compression ratio

Call Sessions/Spanning Tree

Read security: 5

When Bridge mode and Spanning Tree mode are active, this reflects the current state of the LAN and WAN ports. The following can appear:

Off	Appears when spanning tree mode is disabled
Disabled	Port is not connected (for WAN) or disabled in configuration
Listening	Port is in the listening state
Learning	Port is in the learning state
Forwarding	Port is in the forwarding state with the following possible properties:
root	is the root port
designated	is designated port
Blocking	Port is in the blocked state

Status/ARP Cache

Read security: 5

This lists the contents of the Express 4100/4110's ARP table. All resolved cache entries time out after 20 minutes. Unresolved entries time out in 3 minutes.

ARP Cache/IP Address	IP address used for resolving MAC address
ARP Cache /MAC Address	Ethernet address resolved (0=no resolution)
ARP Cache/Time	Minutes since entry was first entered

Status/Bridge Table

Read security: 5

This lists the contents of the Express 4100/4110's bridge table.

Bridge Cache/MAC Address	Ethernet address for device learned
Bridge Cache/Port	Port device learned from: LAN , WANO , or WAN1
Bridge Cache/TTL	Seconds until address is removed from table

Status/IP Routes

Read security: 5

This lists the contents of the Express 4100/4110's IP router table.

IP Routes /IP Address	Network or host destination address
IP Routes /Netmask	Network mask applied to the destination address
IP Routes /Gateway	Host or router to receive this packet
IP Routes /Port	Port gateway is located on:
local	sent directly to the Express 4100/4110 router
eth0	Express 4100/4110's ethernet port
wan0	Express 4100/4110's first PPP bundle
wan1	Express 4100/4110's second PPP bundle
idle	non-connected or "spoofed" route used for dial-on-demand
IP Routes /Use	Number of times the Express 4100/4110 has referenced the route
IP Routes/Flags	Important tags associated with this route entry
H	route is a host route
G	route is a gateway route
D	route learned dynamically from RIP
I	route learned from an ICMP redirect

P	route is private and is not advertised with RIP
T	route is to a triggered port (updates only when table changes)
IP Routes/Hops	Number of routers that must go through to get to destination. Ranges from 0-15 or 16 for infinite (can't get there from here).
IP Routes/TTL	Seconds until address is removed from table or "zombied." Value of 999 means route is static.

Status/IPX Routes

Read security: 5

This lists the contents of the Express 4100/4110's IPX router table.

IPX Routes /Network	Network destination address
IPX Routes /Gateway	Node or Ethernet address of gateway to receive this packet
IPX Routes /Port	Port gateway is located on:
local	sent directly to the Express 4100/4110 router
eth0	Express 4100/4110's ethernet port
wan0	Express 4100/4110's first PPP bundle
wan1	Express 4100/4110's second PPP bundle
idle	non-connected or "spoofed" route used for dial-on-demand
IPX Routes /Use	Number of times the Express 4100/4110 has referenced the route
IPX Routes/Hops	Number of routers that must go through to get to destination. Ranges from 0-15 or 16 for infinite (can't get there from here).

IPX Routes/Ticks

Router determined value for representing time packets take to reach the network destination. One tick is equivalent to one-eighteenth of a second.

IPX Routes/TTL

Seconds until address is removed from table. Value of 999 means route is static.

Status/IPX Servers

Read security: 5

This lists the contents of the Express 4100/4110's IPX server table.

IPX Servers/Type

The server type

IPX Servers/Name

The server name

IPX Servers/Network

The server network address

IPX Servers /Address

The servers node address

IPX Servers/Socket

The servers socket address

IPX Servers/Hops

Number of routers that must go through to get to server. Ranges from 0-15 or 16 for infinite.

IPX Servers/TTL

Seconds until address is removed from table. Value of 999 means server is static.

Status/WAN Stats

Read security: 5

This menu contains generic WAN statistics on both B-channel HDLC hardware ports.

HDLC Port 1

Tx Bytes	total number of raw bytes sent out HDLC port 1
Rx Bytes	total number of raw bytes received in HDLC port 1
Rx CRCs	total number of CRC errors detected on HDLC port 1

HDLC Port 2

Tx Bytes	total number of raw bytes sent out HDLC port 2
Rx Bytes	total number of raw bytes received in HDLC port 2
Rx CRCs	total number of CRC errors detected on HDLC port 2
Clear Counts	When activated, clears all WAN stat counts

Status/LAN Stats

Read security: 5

This menu contains statistics for the Ethernet port.

Tx Packets	Packets transmitted out the Ethernet port
Rx Packets	Packets received from the Ethernet port
Tx Errors	Total transmit errors encountered on Ethernet port
Single Collisions	total single collisions before successful transmission
Multiple Collisions	total multiple collisions before successful transmission
Excessive Collisions	total collisions that resulted in packet being dropped
Deferred Transmissions	total packets deferred due to collisions

Carrier Sense Errors	total carrier sense errors encountered (no link integrity)
Rx Errors	Total packets received in error and dropped
CRCs	total packets detected with CRC errors
Giants	total packets received that were greater than 1518 bytes
Runts	total packets received that were less than 64 bytes
Rx Collisions	total collision occurred during reception
Clear Counts	When activated, clears all LAN Stat counts.

Status/IP Stats

Read security: 5

This menu contains IP statistics that can be useful when diagnosing problems. All are taken from the SNMP MIB-2 variables.

TCP failed attempts
TCP passive connections
TCP current connections
TCP segments sent
TCP segments received
Total TCP resets
Active TCP connections
Total TCP retransmits
UDP datagrams sent
No application at dest. port
UDP datagrams received
UDP bad packets
ICMP redirected messages
ICMP packet errors
ICMP timeouts received
ICMP messages sent
ICMP messages received
ICMP specif if errors
IP datagrams reassembled
IP datagrams sent
IP datagrams received
Total forwarded datagrams
IP reassembly timeout
Discarded routing entries
Total IP fragments
Failed fragments

IP reassembly failures
Disassembled fragments
Errorfree discards
Routeless discards
Default TTL
Bad IP addresses
Successful fragments
Bad header packets
Sent datagrams to upper layers
Datagrams discarded
Bad protocol discards
Clear Counts - clears all IP stats

TEST MENU

The Express 4100/4110's Test menu contains built in tests that can be used to diagnose problems. Figure 3-12 shows the Test menu screen.



Figure 3-12. Test Screen

The following tests can be run:

Test Menu/Echo Request

Write security: 4, Read security: 5

When activated, the echo request test will begin sending continuous PPP echo request packets to any open LCP ports. Results are displayed on the screen. At least one PPP session must be up.

Test Menu/Dial Self

Write security: 4, Read security: 5

The dial self-test can be activated to check the ISDN parameters set under the **Configuration/WAN/ISDN** menu. This test starts the Express 4100/4110 dialing itself using the configured LDN numbers. Once a connec-

tion is established, it will send PPP echo request until the test is terminated. Any error or success messages will appear on the screen.

LOGS MENU

The Logs menu contain logs displaying important information about the running condition of the Express 4100/4110. The logs can be set to capture diagnostics of error conditions only by way of a log level. The levels are divided up as follows:

- level 0 - Fatal event (causes reset)
- level 1 - Critical event
- level 2 - Error event
- level 3 - Warning event
- level 4 - Notify event
- level 5 - Informational event
- level 6 - Debugging event

Figure 3-13 shows the Logs menu. The three logs available are listed after the figure.



Figure 3-13. Logs Screen

Logs/Sys log Host

Set this to the IP address or domain name (if DNS configured) of the sys log host device. All log events are sent to this device.

Logs/PPP Log

Information pertaining to the PPP negotiation and authentication will be logged here.

PPP Log/Active

When set to **Yes** (def), PPP events below or equal the log level are logged into the log.

PPP Log/Wrap

When set to **Yes** (def), new PPP events will overwrite old PPP events when the log is full. All logging will stop when the log is full and set to **No**.

PPP Log/Level

In order to log events, they must be at or below this level. Range is 0 to 6. The default is 3.

PPP Log/View

This menu displays the log list. The fields are as follows:

Date/Time	Date and time event occurred.
Level	Level associated with this event (0-6).
Message	Text message for this event. If message is too long to fit on the line, another event appears below it continuing the message.

PPP Log/Clear

This clears the log when activated.

Logs/Call Log

Information pertaining to the call placement and answering over the ISDN link.

Call Log/Active

When set to **Yes** (def), call events below or equal the log level are logged into the log.

Call Log/Wrap

When set to **Yes** (def), new Call events will overwrite old Call events when the log is full. All logging will stop when the log is full and set to **No**.

Call Log/Level

In order to log events, they must be at or below this level. Range is 0 to 6. The default is 3.

Call Log/View

This menu displays the log list. The fields are as follows:

Date/Time	Date and time event occurred.
Level	Level associated with this event (0-6).
Message	Text message for this event. If message is too long to fit on the line, another event appears below it continuing the message.

Call Log/Clear

This clears the log when activated.

Logs/Network Log

Information pertaining to the routing protocols is placed in this log.

Network Log/Active

When set to **Yes** (def), call events below or equal the log level are logged into the log.

Network Log/Wrap

When set to **Yes** (def), new Network events will overwrite old Network events when the log is full. All logging will stop when the log is full and set to **No**.

Network Log/Level

In order to log events, they must be at or below this level. Range is 0 to 6. The default is 3.

Network Log/View

This menu displays the log list. The fields are as follows:

Date/Time	Date and time event occurred.
Level	Level associated with this event (0-6).
Message	Text message for this event. If message is too long to fit on the line, another event appears below it continuing the message.

Network Log/Clear

This clears the log when activated.

UTILITIES MENU

The Express 4100/4110 has utilities embedded in it to help manage and test the network and to facilitate software upgrades. Figure 3-14 shows the Utilities menu.

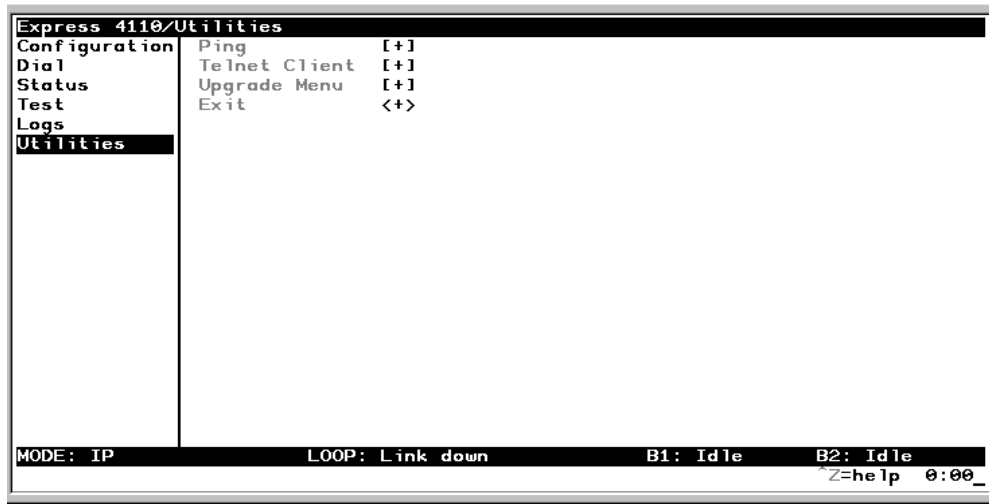

Figure 3-14. Utilities Screen

Utilities/Ping

Write security: 4; Read security: 5

The ping menu is used to send ICMP ping messages to hosts. The following items are under this menu:

Start/Stop	Activator to start and cancel a ping test.
Host Address	IP address or domain name (if DNS is configured) of device to receive the ping
Size	Total size of ping to send. Range is 40 (def) to 1500 bytes.

# of Packets	Total packets to send every two seconds
# of Transmits	Total packets sent (read only)
# of Receives	Total packets received (read only)
% Loss	Percentage loss based on ping returned from host (read only)

Utilities/Telnet Client

Write security: 4; Read security: 5

The Telnet menu can be used to activate the telnet client function in the Express 4100/4110.

Host	IP address or domain name (if DNS is configured) of Telnet server.
Activate	Starts Telnet client function. The key combination Control] cancels the session.

Utilities/Upgrade Menu

Write security: 2; Read security: 3

The Express 4100/4110's firmware can be upgraded using this menu.

Upgrade/Transfer Method

To upgrade, use **XMODEM**. Selecting **XMODEM** will load the upgrade code through the maintenance port using any PC terminal emulator with xmodem capability.

Upgrade/Filename

This is required when the transfer method is TFTP. It is the case-sensitive file name which is the upgrade code.

Upgrade/Start Transfer

This activator is used when the configurable items in this menu are complete.

*Once started, the Express 4100/4110 will prompt for erasing the flash. When the flash is erased and the upgrade transfer fails, do not turn off the unit. Retry the transfer until successful. Otherwise, if power is removed before upgrade has finished, the upgrade will have to occur from the maintenance port using XMODEM. If this happens, set a PC terminal emulation program to 115200 baud and attach to the Express 4100/4110's maintenance port. Press **Return** to display a simple terminal menu for upgrading. This menu appears when the flash code has been erased or is corrupt. The menu will also appear if you power up and hold down the **SELECT** key for at least five seconds.*



NOTE

Utilities/Exit

Write security: 5; Read security: 5

Activating this feature will exit the terminal session from the maintenance port or telnet. It is equivalent to the key combination **Control L**.

When the Express 4100/4110 powers up, it performs an internal self-test. This takes about 10 seconds. At the end of the test, the PWR LED should flash.

IF SELF-TEST FAILS

If the PWR LED is not on or continuously flashes, the following steps will verify whether or not the problem can be fixed locally.

1. Ensure the Express 4100/4110 is receiving power.
2. Power off the Express 4100/4110. Place switch 2 in the off position; then power back up. This will reset all internal settings to their factory default.
3. If the Express 4100/4110 still does not pass self-test, call ADTRAN Technical Support for assistance. See the inside back cover of this manual for information on contacting ADTRAN.

IF THE EXPRESS 4100/4110 DOES NOT READ *READY*

When the Express 4100/4110 has been set up and connected to a line, but the PWR LED does not remain on after a few minutes, proceed with the following steps:

1. Cycle power on the Express 4100/4110, leaving it off for a minimum of two seconds; then turn the power on for one minute to ensure the PWR LED still does not stay on.
2. Disconnect the Express 4100/4110. From a functioning voice phone, call the local directory number(s) provided with your line. Calling a good ISDN line with nothing connected usually results in a ring or

fast busy tone. If someone answers, or you get a not-in-service intercept, there is probably something wrong with the translation of the line. The phone service provider should be able to help.

3. If the PWR LED still flashes, there is a physical problem with the phone line (more than likely, a problem with the Layer 1 setup). The problem is in one or more of the places listed below:
 - The Express 4100/4110 software setup
 - The Express 4100/4110 hardware
 - The wiring on your premises
 - The telephone service provider's wiring
 - The telephone service provider's hardware
 - The telephone service provider's software setup

To isolate the problem, perform the following procedure:

- A. Ensure the line is plugged into the Express 4100/4110 connector marked **ISDN** on the back of the Express 4100/4110.
- B. Make sure the Express 4100/4110 is configured for Dial line service.
- C. If possible, try another piece of functioning ISDN equipment with a U-interface on the line.
- D. Talk to your service provider and ensure you have an ISDN Basic Rate U-Interface with 2B1Q line coding. (Wrong options are an S or T interface or AMI line coding).
- E. Ensure that your phone line is connected to the actual telephone line (U-interface) provided by your telephone company. Make sure your line is not connected through another piece of equipment such as an NT1 in a wiring closet.
- F. Make sure nothing else is bridged across the line pair.
- G. With a minimum of extra wiring, try connecting to the line pair at the point where the service provider's wiring ends.
- H. With the Express 4100/4110 connected to the line and powered up, talk to your service provider's repair group and inform them that your ISDN basic rate line has a physical Layer 1 problem. Ask them to check the line. Tell them that you have an NT1-like device at the end of the line.

4. If the *Loop Status* in the Express 4100/4110 Status menu continuously reads **Getting TEI #1**, then the Express 4100/4110 is physically connected to your local telephone service provider but is unable to establish logical layer 2. The problem is in one or more of the places listed below:
 - The Express 4100/4110 software setup
 - The telephone service provider's software setup
 - Hardware configuration, if the line is extended from the switch

To isolate the problem, perform the following procedure:

- A. Ensure the Express 4100/4110 is setup for the correct switch type.
 - B. Ensure the quality of your line is satisfactory by checking for near and far end block errors (NEBEs and FEBEs). If the counts are non-zero, there may be a physical link problem as described in step 3.
 - C. If possible, try another piece of functioning ISDN equipment with a U-interface on the line.
 - D. With the Express 4100/4110 connected to the line and powered up, talk to your service provider's repair group and tell them you have an ISDN basic rate line that appears physically okay but has no terminal endpoint identifier (TEI). Ask them to check the line translation and ensure that the line supports dynamic TEI allocation. Tell them that you have an NT1 and terminal adapter device connected to the line.
5. If the *Loop Status* in the Express 4100/4110 Status menu continuously reads **Register SPID #1**, then the Express 4100/4110 is physically connected to your local telephone service provider and has established logical layer 2. The Express 4100/4110 is unable to establish layer 3. The problem is in one or both of the following places:
 - The Express 4100/4110 software setup
 - The telephone service provider's software setup

To isolate the problem, perform the following procedure:

- A. Ensure the Express 4100/4110 is set up for the correct switch type.
- B. Make sure the line is multipoint.

- C. Make sure the Express 4100/4110 is set up with the correct SPID and LDN. For example:
 - SPID1 = 20572270460101
 - SPID2 = 20572270470101
 - LDN 1 = 7227046
 - LDN 2 = 7227047
 - D. If possible, try another piece of functioning ISDN equipment with a U-interface on the line.
 - E. With the Express 4100/4110 connected to the line and powered up, talk to your service provider's repair group and tell them you have an ISDN basic rate line that appears physically okay but is unable to register its SPID(s). Ask them to check the line translation, ensure the line supports dynamic TEI allocation, and verify the SPIDs. Tell them that you have an NT1 and terminal adapter device connected to the line.
6. If the *Loop Status* in the Express 4100/4110 Status menu continuously reads **Getting TEI #2**, the Express 4100/4110 has completely initialized the first phone number but is unable to establish logical layer 2 for the second phone number. The problem is in one or both of the following places:
- The Express 4100/4110 software setup
 - The telephone service provider's software setup

To isolate the problem, perform the following procedure:

- A. Ensure the line is multipoint with two phone numbers.
- B. Ensure that the Express 4100/4110 is set up with the correct SPID and LDN. For example:
 - SPID1 = 20572270460101
 - SPID2 = 20572270470101
 - LDN 1 = 7227046
 - LDN 2 = 7227047
- C. Try swapping SPID1 with SPID2 and LDN1 with LDN2. Determine if the problem is the second phone number or the quantity of phone numbers.
- D. If possible, try another piece of functioning ISDN equipment with a U-interface on the line.
- E. With the Express 4100/4110 connected to the line and powered up, talk to your service provider's repair group and tell them you have an ISDN basic rate line that appears physically okay but is unable to register its SPID(s). Ask them to check the line translation, ensure the line supports dynamic TEI allocation, and verify the SPIDs. Tell them that you have an NT1 and terminal adapter device connected to the line.

7. If the *Loop Status* in the Express 4100/4110 Status Menu continuously reads **Register SPID #2**, the Express 4100/4110 has completely initialized the first phone number but is unable to establish logical layer 3 for the second phone number. The problem is in one or both of the following places:
- The Express 4100/4110 software setup
 - The telephone service provider's software setup

To isolate the problem, perform the following procedure:

- A. Ensure the line is multipoint with two phone numbers.
- B. Ensure that the Express 4100/4110 is set up with the correct SPID and LDN. For example:
 SPID1 = 20572270460101
 SPID2 = 20572270470101
 LDN 1 = 7227046
 LDN 2 = 7227047
- C. Try swapping SPID1 with SPID2 and LDN1 with LDN2. Determine if the problem is with the second phone number or the quantity of phone numbers.
- D. If possible, try another piece of functioning ISDN equipment with a U-interface on the line.
- E. With the Express 4100/4110 connected to the line and powered up, talk to your service provider's repair group and tell them you have an ISDN basic rate line that appears physically okay but is unable to register its SPIDs. Ask them to check the line translation, ensure the line supports dynamic TEI allocation, and verify the SPIDs. Tell them that you have an NT1 and terminal adapter device connected to the line.

IF YOU ARE UNABLE TO CONNECT CALLS

See Table 4-A for corrective actions if you cannot connect calls.

Table 4-1. Troubleshooting Calls

Condition	Corrective Action
The PWR LED remains on, but calls cannot be placed.	Most likely a problem exists in the software setup (translation) at the CO switch, or the network setup in the Express 4100.
Local voice calls can be transmitted, but data calls to the same exchange cannot.	The line is probably not set up to support data calls.
Local data calls go through, but long distance data calls do not.	Ensure the far end is working. If not already doing so, place the call explicitly specifying the prefix of the long distance service (for example, 10288 for AT&T). If this does not work, then most likely the problem is that the long distance service provider is not providing long distance access.
Single B-channel calls can be made, but two B-channel calls cannot.	<p>There is most likely a problem in the software setup (translation) at the CO switch, or the network setup in the Express 4100.</p> <p>If the line has two phone numbers, make sure the second SPID and LDN are entered correctly in SPID2 and LDN2 in the Express 4100.</p> <p>Check with the local service provider to ensure that the line supports two data calls. The Express 4100 status log buffer shows the sequence of events that occurred. You need to know which piece of equipment first caused the Multilink PPP process to terminate. The status logs from both ends may be necessary to determine this.</p>

SPECIFICATIONS AND FEATURES

This section describes the standard specifications and features incorporated in the Express 4100/4110.

Network Interface

RJ-49C for ISDN Basic Rate U-Interface or RJ-49C for leased 2B1Q service.

Ethernet Interface (LAN)

Ethernet/IEEE 802.3 10BaseT.

Switch Compatibility

- LUCENT 5ESS
- NTI DMS-100
- National ISDN-1

Dual POTS Interface

- Maximum REN = 3
- Caller ID
- Ringing Signal Amplitude = 185 Vp-p (+/- 5V)
- Ringing Signal Frequency = 20 Hz (+/- 3 Hz)
- Supports 3 phones
(18 mA loop current each) at 1,000 ft, 24 AWG
- Supports 2 phones
(26 mA loop current each) at 1,000 ft, 24 AWG
- Supports 1 phone
(49 mA loop current each) at 1,000 ft, 24 AWG

- Supports 4 phones
(14 mA loop current each) at 600 ft, 24 AWG
- Supports 3 phones
(18 mA loop current each) at 600 ft, 24 AWG
- Supports 2 phones
(27 mA loop current each) at 600 ft, 24 AWG
- Supports 5 phones
(12 mA loop current each) at 300 ft, 24 AWG
- Supports 4 phones
(15 mA loop current each) at 300 ft, 24 AWG
- Supports 3 phones
(19 mA loop current each) at 300 ft, 24 AWG
- Supports 2 phones
(28 mA loop current each) at 300 ft, 24 AWG
- Supports 1 phone
(53 mA loop current each) at 300 ft, 24 AWG
- Supports 5 phones
(12 mA loop current each) at 100 ft, 24 AWG
- Supports 4 phones
(15 mA loop current each) at 100 ft, 24 AWG
- Supports 3 phones
(20 mA loop current each) at 100 ft, 24 AWG
- Supports 5 phones (13 mA loop current each) at 8 ft, 24 AWG
- Supports 4 phones (16 mA loop current each) at 8 ft, 24 AWG
- Supports 3 phones (21 mA loop current each) at 8 ft, 24 AWG

Display

Available through terminal interface or Telnet session

Environmental

- Operating Temperature: 0 - 50 °C
- Storage Temperature: 20 - 70 °C
- Relative Humidity: Up to 95% non-condensing

Physical

- Dimensions: 1.625" H x 9.0" W x 6.375" D
- Weight: 2.5 lbs

Power

- 120 VAC, 60 Hz, 7.5 W typical dissipation with POTS

The Express 4100/4110 displays current loop status of the ISDN on the bottom center line of the terminal screen. The following messages are defined:

AutoSpid Download

The Express 4100/4110 is performing the LUCENT SPID download feature.

AutoSpid X

A SPID is being attempted by ExpertISDN. X starts at 0 and counts up for each SPID format.

CALL <number>

The Express 4100/4110 is dialing the number.

Call Connect B1

Bearer channel B1 is active with a call.

Call Connect B2

Bearer channel B2 is active with a call.

Call Connect B1/B2

Bearer channels B1 and B2 are active with a call.

Connected 64K/2X64K/128K

When the Express 4100/4110 is in leased mode, this will appear when the link's layer 1 is up. The rate is determined by what it is configured for under Configuration/WAN/ISDN/Leased/Rate.

DISCONNECTING

A call is in the process of being disconnected.

DMS-100 Ready

The ISDN link layers 1 through 3 are up against a Nortel DMS-100 switch and is ready for calls.

Echo: Tx: X Rx: Y

The current transmit and receive count for the PPP echo request test.

Getting TEI #1

The Express 4100/4110's ISDN layer 1 is up and is now getting the first TEI from the ISDN network.

Getting TEI #2

The Express 4100/4110's ISDN layer 1 is up and one TEI is obtained. It is now getting the second TEI from the ISDN network.

ISDN-1 Ready

The ISDN link layers 1 through 3 are up against a switch running the ISDN-1 protocol and is ready for calls.

Layer 1 up

The Express 4100/4110's ISDN layer 1 is up.

Link down

The ISDN link is not synchronized.

Link In Sync

The ISDN link is synchronized but layer 1 is not up.

LUCENT-5ESS Ready

The ISDN link layers 1 through 3 are up against an LUCENT 5E switch and is ready for calls.

NET EOC LOOPBACK

Express 4100/4110 has received an ISDN EOC loopback command from the switch.

Register SPID #1

The Express 4100/4110's ISDN layer 1 and 2 is up and is now registering SPID 1 with the ISDN network.

Register SPID #1

The Express 4100/4110's ISDN layer 1 and 2 is up and is now registering SPID 2 with the ISDN network.

RINGING

An incoming call is ringing.

B1 and B2 Bearer Channel Status Messages

56K

Connected at 56K call type.

64K

Connected at 64K call type.

Audio

Connected at audio call type.

Dialing

Dialing out.

Holding

Connection is on hold.

Idle

No call up.

Speech

Connected at speech call type.

Release

Call being hung up.

Retriv

Held call being retrieved.

Ring

Incoming call.

Routing

Incoming call state in transition .

Waiting

Call is between states or waiting for switch.

The Express 4100/4110 Logs menu contains messages of events that occur. The definitions for some of those log messages are as follows:

PPP Log Messages

B-Channels bundled

level 5

Both B-channels are bundled under multilink PPP going to a single PPP peer.

BACP <X> down

level 5

Bandwidth Allocation Control Protocol port <X> has been dropped between Express 4100/4110 and PPP peer.

BACP <X> up

level 5

Bandwidth Allocation Control Protocol port <X> has been successfully negotiated between Express 4100/4110 and PPP peer.

BCP <X> down

level 5

Bridge Control Protocol port <X> has been dropped between Express 4100/4110 and PPP peer.

BCP <X> up

level 5

Bridge Control Protocol port <X> has been successfully negotiated between Express 4100/4110 and PPP peer.

Can't find user profile

level 2

The Express 4100/4110 could not find an appropriate user profile for an incoming call. Make sure that a profile has been entered under Configuration/Connection List or that a default profile exists. A default profile is one which has the name **DEFAULT** in the description field.

CCP <X> down

level 5

Compression Control Protocol port <X> has been dropped between Express 4100/4110 and PPP peer.

CCP <X> up

level 5

Compression Control Protocol port <X> has been successfully negotiated between Express 4100/4110 and PPP peer.

CHAP authen failed

level 3

The PPP peer has rejected the Express 4100/4110's username and/or password used for authenticating. Check to make sure the **Configuration/Connection List/Authentication** parameters **Tx Method**, **Tx Username**, and **Tx Password** are correct.

EAP authen failed

level 3

The PPP peer has rejected the Express 4100/4110's username and/or password used for authenticating. Check to make sure the **Configuration/Connection List/Authentication** parameters **Tx Method**, **Tx Username**, and **Tx Password** are correct.

IPCP <X> down

level 5

IP Control Protocol port <X> has been dropped between Express 4100/4110 and PPP peer.

IPCP <X> up

level 5

IP Control Protocol port <X> has been successfully negotiated between Express 4100/4110 and PPP peer.

IPXCP <X> down

level 5

IPX Control Protocol port <X> has been dropped between Express 4100/4110 and PPP peer.

IPXCP <X> up

level 5

IPX Control Protocol port <X> has been successfully negotiated between Express 4100/4110 and PPP peer.

LCP <X> down

level 5

Link Control Protocol port <X> has been dropped between Express 4100/4110 and PPP peer.

LCP <X> up

level 5

Link Control Protocol port <X> has been successfully negotiated between Express 4100/4110 and PPP peer.

Link is looped back

level 3

The Express 4100/4110 has dialed a location which is looping back all data. Essentially, it has negotiated PPP with itself.

MP options not the same

level 2

It is required that when LCP links are bundled that specific PPP options (MRRU and short sequence header format) be negotiated the same for all LCP links. This message occurs when those options mismatch. Probably due to misconfiguration of the PPP peer.

Negot not converging

level 2

Negotiation of the LCP layer is unattainable due to misconfiguration or the Express 4100/4110 or PPP peer is requiring authentication and the other is refusing.

No IP addr for peer

level 2

The Express 4100/4110 cannot continue the connection because there was no IP address received from the PPP peer or it was not set in **Configuration/Connection List/IP/Route/IP/Net** parameter.

No more bundles avail

level 3

The Express 4100/4110 cannot bundle more than two Multilink sessions at one time.

No Response from peer

level 2

The Express 4100/4110 has dialed or answered a call and no PPP negotiation packets were seen.

PAP authen failed

level 3

The PPP peer has rejected the Express 4100/4110's username and/or password used for authenticating. Check to make sure the **Configuration/Connection List/Authentication** parameters **Tx Method**, **Tx Username**, and **Tx Password** are correct.

Peer failed CHAP authn

level 3

The PPP peer's reported CHAP username and/or password does not match the Express 4100/4110's parameters. This is most likely caused by PPP peer sending an incorrect username and/or password. Make sure the **Configuration/Connection List/Authentication** parameters **Rx Username** and **Rx Password** are correctly entered. Also, if using RADIUS, check that the server is configured and running properly.

Peer failed EAP authn

level 3

The PPP peer's reported EAP username and/or password does not match the Express 4100/4110's parameters. This is most likely caused by PPP peer sending incorrect username and/or password. Make sure the **Configuration/Connection List/Authentication** parameters **Rx Username** and **Rx Password** are correctly entered. Also, if using RADIUS, check that the server is configured and running properly.

Peer failed PAP authn

level 3

The PPP peer's reported PAP username and/or password does not match the Express 4100/4110's parameters. This is most likely caused by PPP peer sending incorrect username and/or password. Make sure the **Configuration/Connection List/Authentication** parameters **Rx Username** and **Rx Password** are correctly entered. Also, if using RADIUS, check that the server is configured and running properly.

Peer refused authn

level 3

The PPP peer would not allow the Express 4100/4110 to authenticate it using the method set in Configuration/Security/PPP.

Peer refused SpanTree

level 4

The PPP peer would not participate in the Spanning Tree protocol. This is a warning message only. Bridging will still occur across the WAN port so care must be taken that no loop topologies exist across the connection.

PPPtX[x] ...

level 6

Advance debugging decode of transmitted PPP configuration packets.

PPPrx[x] ...

level 6

Advanced debugging decode of received PPP configuration packets.

Call Log Messages

Answer <number>

level 5

An incoming call from <number> was answered. If no caller ID is available for the ISDN line then <number> will be blank.

AutoSpid Download Not Available

level 4

Lucent AutoSpid download is not available from this ISDN switch.

AutoSpid Download Pass

level 4

Lucent AutoSpid download feature has successfully installed the SPIDs.

AutoSpid Download Started

level 4

Lucent AutoSpid download feature has started.

AutoSpid Failed

level 2

ExpertISDN has failed trying to determine the ISDN line's SPID format. This can occur if the telephone company is not using standard SPID formats.

AutoSpid Passed

level 4

ExpertISDN has finished and has determined the ISDN line's SPID format.

AutoSpid Retry

level 4

ExpertISDN is attempting another SPID format.

AutoSwitch LUCENT

level 4

ExpertISDN has determined that the switch protocol is LUCENT 5E custom.

AutoSwitch DMS

level 4

ExpertISDN has determined that the switch protocol is Nortel DMS-100.

AutoSwitch NI-1

level 4

ExpertISDN has determined that the switch protocol is National ISDN 1.

Bad call type

level 1

Internal error as a result of outgoing call attempt.

Bad Host_Call_ID

level 1

Internal error as a result of call control.

Bad phone number

level 2

An outgoing call was attempted with a badly formatted or empty phone number.

Bandwidth drop

level 4

The Express 4100/4110 is dropping a B-channel call in order to reduce bandwidth.

Bandwidth request

level 4

The Express 4100/4110 is dialing another B-channel in order to increase bandwidth.

Bandwidth Restore

level 4

The Express 4100/4110 is re-dialing destination to restore original bandwidth after POTS call bump or unexpected call drop.

Bearer Info Cap Incorrect

level 2

The bearer capability received in an information element from the switch was invalid.

Bearer Mode Incorrect

level 2

The bearer mode received in an information element from the switch was invalid.

BUSY

level 2

Called location was busy.

Call lost <number>

level 5

The Express 4100/4110 attempted to retrieve a previously held call but the call was lost for unknown reasons. If no caller ID is available for the ISDN line, then <number> will be blank for incoming calls.

Caller ID mismatch

level 3

The caller ID number did not match the numbers placed in **Configuration/Connection List/Authentication** parameters **Call ID 1** or **Call ID 2**.

CallID 1 in use

level 2

An outgoing call on LDN 1 was dumped because it was already busy with a call.

CallID 2 in use

level 2

A outgoing call on LDN 2 was dumped because it was already busy with a call.

Can't answer, Call not ringing

level 1

Internal error as a result of trying to answer a non-existent incoming call.

Cause: '<cause>' diag=<num>

level 3

The ISDN switch has sent a Cause information element describing the reason reported from the ISDN switch as <cause> for a call failure. The value <num> is the diagnostic which can be helpful for diagnosing by the telephone company or ADTRAN technical support. The following will be reported for the <cause> value:

BAD_INFO_ELEM

BEAR_CAP_NOT_AVAIL

BEARER_CAP_NOT_AUTH

CALL_REJECTED

CAP_NOT_IMPLEMENTED

CHAN_DOES_NOT_EXIST

CHAN_NOT_IMPLEMENTED

CHANNEL_UNACCEPTABLE
DEST_OUT_OF_ORDER
FACILITY_NOT_IMPLEMENT
FACILITY_NOT_SUBSCRIBED
FACILITY_REJECTED
INCOMING_CALL_BARRED
INCOMPATIBLE_DEST
INVALID_CALL_REF
INVALID_ELEM_CONTENTS
INVALID_MSG_UNSPEC
INVALID_NUMBER_FORMAT
MANDATORY_IE_LEN_ERR
MANDATORY_IE_MISSING
NETWORK_CONGESTION
NETWORK_OUT_OF_ORDER
NO_CIRCUIT_AVAILABLE
NO_ROUTE
NO_ROUTE_TO_DEST
NO_USER_RESPONDING
NON_SEL_USER_CLEAR
NONEXISTENT_MSG
NORMAL_CLEARING
NUMBER_CHANGED
OUTGOING_CALL_BARRED
PRE_EMPTED
PROTOCOL_ERROR

REQ_CHANNEL_NOT_AVAIL
RESOURCE_UNAVAIL
SERVICE_NOT_AVAIL
SERVICE_OPER_VIOLATED
TEMPORARY_FAILURE
TIMER_EXPIRY
UNASSIGNED_NUMBER
USER_ALERT_NO_ANS
USER_BUSY
WRONG_MESSAGE
WRONG_MSG_FOR_STATE

Conference <number>

level 5

The Express 4100/4110 has conferenced the held call with the active call. If no caller ID is available for the ISDN line then <number> will be blank for incoming calls.

Conference Rej <number>

level 5

The Express 4100/4110 attempted to conference but was reject by the ISDN switch. If no caller ID is available for the ISDN line, then <number> will be blank for incoming calls.

Connect Timeout

level 3

An outgoing call attempt has failed because the call was not answered or it was not routed through the ISDN network.

Connected <number>

level 5

A call from or to <number> was connected. If no caller ID is available for the ISDN line then <number> will be blank for incoming calls.

Demand calling '<user>'

level 4

A new call is being placed due to incoming packet routed to "idle" interface or bridge packet passing through demand filter. The Connection List profile used is the one with <user> in the description field.

DEST NOT ISDN

level 4

The number dialed is not ISDN. This is a warning and is most often seen for POTS calls.

Dial <number>

level 5

The Express 4100/4110 is dialing <number>.

Dialing ...

level 5

A phone on the Express 4100/4110 POTS port is dialing.

Disconnect <number>

level 5

A call from or to <number> was disconnected. If no caller ID is available for the ISDN line, then <number> will be blank for incoming calls.

Dump <number>

level 5

A call or call attempt to or from <number> has been refused. If no caller ID is available for the ISDN line, then <number> will be blank for incoming calls.

Dump call

level 3

The Express 4100/4110 has dropped an incoming call because it was busy with calls.

Fallback to 56K

level 4

The Express 4100/4110 is re-dialing the same destination at 56K call type because the 64K call type failed.

FarDN=<number>

level 5

This is far-end directory number for an incoming call.

Hangup <number>

level 5

A call from or to <number> was hung up. If no caller ID is available for the ISDN line, then <number> will be blank for incoming calls.

Hold <number>

level 5

The Express 4100/4110 has placed a call on hold. If no caller ID is available for the ISDN line, then <number> will be blank for incoming calls.

Hold Reject <number>

level 5

The Express 4100/4110 attempted to put a call on hold and it was rejected by the ISDN switch. If no caller ID is available for the ISDN line, then <number> will be blank for incoming calls.

Idle timeout

level 4

The Express 4100/4110's idle timer has expired and the current session has dropped.

L1 not up

level 2

A call attempt was stopped because ISDN layer 1 is down.

L2 not up

level 2

A call attempt was stopped because ISDN layer 2 is down trying to get first TEI.

L2 #2 not up

level 2

A call attempt was stopped because ISDN layer 2 is down trying to get second TEI.

L3 not up

level 2

A call attempt was stopped because ISDN layer 3 is down trying to register first SPID.

L3 #2 not up

level 2

A call attempt was stopped because ISDN layer 3 is down trying to register second SPID.

LDN TOO LONG

level 1

The number in either LDN 1 or LDN 2 is longer than 20 characters.

NETWORK BUSY

level 2

Called location was busy or network could not route call.

Network down

level 4

The ISDN network is unavailable due to layers 1,2 or 3 dropping.

Network up

level 4

The ISDN network layer 3 is up and is ready for calls.

No calling ID

level 2

An incoming call did not provide the caller ID number required for authentication.

No previous number

level 1

An internal error occurred with dial-on-demand function.

NOT end2end ISDN

level 4

The path that the call was routed over is not ISDN from end-to-end. This is a warning and is most often seen for POTS calls.

Power Up - last down cause: <reason>

level 0 (displayed as level 1 after the unit is reset)

This is the <reason> for the last reset. Most are caused by internal errors. Possible reasons are:

Bus Error - Bad address occurred on the internal bus

Kernel error - General operating system error

No SBCs - Mail resources used up or lost

Router stack error - Fatal error in protocol stack

general panic - general error

no rip - rip tasks could not start

out of memory - out of available memory

out of TCP ports - all TCP ports are used up

unknown error - unknown fatal error has occurred

Set timer error - Cannot set real time clock

Software Watch Dog Reset - Software watchdog was not updated

Probe: all ports busy

level 3

All ports were busy when it was time to probe. An attempt will be made on the next probe interval.

Probe failed

level 2

An attempt to connect to a probe site failed.

Probing <name>

level 4

The Express 4100/4110 is making an outgoing call to the destination specified by the description in the Connection List in order to get an update on routes.

POTS call bump

level 4

The Express 4100/4110 has dropped bandwidth on an existing data call so that a POTS call can be connected.

Retrieved <number>

level 5

The Express 4100/4110 has retrieved a previously held call. If no caller ID is available for the ISDN line, then <number> will be blank for incoming calls.

Ring <number>

level 5

An incoming call from <number> was ringing. If no caller ID is available for the ISDN line then <number> will be blank.

SOURCE NOT ISDN

level 4

The incoming calling party is not ISDN. This is a warning and is most often seen for POTS calls.

Signal 0xNN

level 4

A signal information element was received from the ISDN switch with the value NN in hexadecimal.

Transfer <number>

level 5

The Express 4100/4110 has transferred the held call with the active call. If no caller ID is available for the ISDN line, then <number> will be blank for incoming calls.

Transfer Rej <number>

level 5

The Express 4100/4110 attempted to transfer but was rejected by the ISDN switch. If no caller ID is available for the ISDN line, then <number> will be blank for incoming calls.

Network Log Messages**Attempting to add bad IP iface route: ifnum=<inter> dest=<ip>**

level 4

An IP address <ip> could not be used for the interface number <inter>.

DHCP couldn't alloc mem

level 1

A DHCP response could not be generated due to memory allocation problems.

DHCP response sent

level 4

A DHCP response was successfully sent to requesting device.

DHCP socket failed

level 1

Internal error occurred when attempting to start DHCP server.

DHCP: Host not added to ARP table

level 2

The DHCP server could not add requesting host to ARP table.

Installing bad default route: ifnum=<inter> metric=<hops> gw=<ip>

level 6

The Express 4100/4110 did not install a default route because the <inter> or <hops> was zero.

Rejecting packet with Source Routing option - src=<srcip> dest=<destip>

level 4

The Express 4100/4110 has dropped a source routed IP packet due to invalid parameters.

setmask: local IP iface(0), not done

level 6

Debug error used in determining router stack problems.

syslog: bad host

level 2

Syslog function cannot use host name or IP set in Configuration/Logs/Syslog Host.

syslog: no port

level 2

Syslog function cannot open port to send Log entries.

TEL: Telnet Session Closed

level 4

Telnet server session has been closed.

telclient bad host

level 2

Telnet client could not use host name or IP address set in Configuration/Utilities/Telnet Client/Host.

telclient bad init

level 2

Telnet client could not initialize a session.

Telnet Client: Cnr TCBF_BUFFER flag failed

level 6

Debugging message related to Telnet client function.

Telnet Client: Set TCBF_DONTBLOCK flag failed

level 6

Debugging message related to Telnet client function.

Telnet Client socket failed

level 2

Telnet client function could not open TCP socket.

Telnet server connect to <ip>

level 4

Telnet server has connected to Telnet client with IP address <ip>.

Telnet Session Closed

level 4

Telnet server has closed connection.

Telnet Session failed, error <errnum>

level 2

Telnet server could not connect to Telnet client due to error.

TELNETD: accept failed

level 2

Telnet server could not open TCP socket to incoming Telnet client.

TELNETD: Set TCPC_LISTENQ failed

level 6

Debugging message related to Telnet server function.

TELNETD: Clr TCBF_BUFFER flag failed

level 6

Debugging message related to Telnet client function.

TELNETD: could not obtain peer IP

level 2

Telnet server function could not get IP address of Telnet client.

TELNETD: Session failed, error

level 2

A Telnet server session has failed because of an error.

TELNETD: Set TCBF_DONTBLOCK flag failed

level 6

Debugging message related to Telnet client function.

TELNETD: SOCKET creation error

level 2

Telnet server could not be started due to TCP socket error.

TFTP: can't get to host

level 2

TFTP client could not get to host.

TFTP client: unable to open port

level 2

TFTP client function could not open a UDP port.

TFTP: error rcvd - <message>"

level 2

Received error with <message> from TFTP server.

TFTP: lost communication

level 2

Lost communication to TFTP client or server during transfer.

TFTP server: unable to open port

level 2

TFTP server function could not open a UDP port.

Understanding SNMP

As Local Area Network (LAN) environments became standardized over the past ten years, multi-vendor equipment grew with competition. It became necessary to manage the various vendor equipment from a single control console. Thus, the Simple Network Management Protocol (SNMP) emerged as the *de facto* standard for managing commercial Transmission Control Protocol/Internet Protocol (TCP/IP) networks.

The term *SNMP* broadly refers to the message protocols used to exchange information between the network and the managed devices, as well as to the structure of network management databases. SNMP has three basic components:

- **Network Manager:** This is a control program that collects, controls, and presents data pertinent to the operation of the network devices. It resides on a network management station.
- **Agent:** This is a control program that responds to queries and commands from the network manager and returns requested information or invokes configuration changes initiated by the manager. It resides in each network device connected.
- **MIB:** This is an index to the organized data within a network device. It defines the operating parameters that can be controlled or monitored.

When requesting the network manager to retrieve or modify a particular piece of information about a network device, the network manager transmits the request to that network device. The agent in that device interprets the incoming request, performs the requested task, and sends its

response to the network manager. The network manager collects all the data from the various network devices and presents it in a consistent form.

Using SNMP Version 1, the network manager can issue three types of commands:

- **GetRequest:** This command retrieves a single item or the first in a series from a network device.
- **GetNextRequest:** This command retrieves the next item in a series from a network device.
- **SetRequest:** This command writes information to a network device.

The network device issues two types of messages:

- **GetResponse:** This message is the response to a network manager **GetRequest** or **GetNextRequest** command.
- **Trap:** This is an unsolicited message issued by a network device to report an operational anomaly or an alarm condition to the network manager.

These messages are typically encased within informational packets and transported over the LAN or WAN.

SNMP Embedded Agent

The Express 4100/4110 supports the following groups from MIB-II: (RFC 1213)

- System Group
- UDP Group
- Interfaces Group
- ICMP Group
- Address Translation Group
- IP Group
- TCP Group

Also, the Ethernet transmission MIB is supported (RFC 1643).

The following manager requests are supported:

- Get object
- Get next object
- Set object

Communities

The Express 4100/4110 permits up to eight communities to be defined. The privilege level of each community can be set. The default community is public with read-only privileges. When the IP address is all zeros, any manager of the community can access the Express 4100/4110.

Traps

Up to four hosts can be set to receive traps. Each host entry requires an IP address of the manager.

Table D-1. IBM/AT Style EIA-232 Interface

	Pin	Name	I/O	Description
	1	CD	N/C	Carrier Detect
	2	RD	O	Receive Data
	3	TD	I	Transmit Data
	4	DTR	N/C	Data Terminal Ready
	5	GND	N/A	Signal Ground
	6	DSR	N/C	Data Set Ready
	7	RTS	I	Request to Send
	8	CTS	O	Clear to Send
	9	RI	N/C	Ring Indicator

I = Input O = Output N/A = Not Applicable N/C = Not Connected

Table D-2. RJ-49C ISDN

	Pin 4	Ring
	Pin 5	Tip

Table D-3. RJ-11 POTS



	Pin 3	Ring
	Pin 4	Tip

Table D-4. 10BaseT Ethernet

	Pin 1	RX1
	Pin 2	RX2
	Pin 3	TX1
	Pin 6	TX2

The Express 4100/4110 supports a command line interface. All menu options are configurable and readable from the terminal mode. Additional commands are also available.

Menu Commands

Every menu item in the menu structure can be accessed through the terminal mode interface. Terminal commands are as follows:

`top_menu sub_menu1 sub_menu2 ... config_item`

Each `config_item` is entered as shown below.

TYPE:	ENTERED AS:
string	printable characters within double quotes
password	printable characters within double quotes
IP address	xx.xx.xx.xx (0..9) separated by '.'
Hex	xx:xx:xx:xx (0..9,a..f) separated by ':'
enum	sub-string or [#index]
unsigned	digits (0..9)
date	mm-dd-yyyy
time	hh:mm:ss
date/time	mm-dd-yyyy hh:mm:ss

TYPE:	ENTERED AS:
activator	read only
list	followed by index with first record being 1
array	followed by index with first record being 1

One of the following key words must be used first:

info	Goes directly to Configuration/System Info menu.
isdn	Goes directly to Configuration/WAN/ISDN menu.
pots	Goes directly to Configuration/WAN/POTS menu.
ipx	Goes directly to Configuration/IPX menu.
bridge	Goes directly to Configuration/Bridge menu.
security	Goes directly to Configuration/Security menu.
connect	Goes directly to Configuration/Connection List menu.
telnet	Goes directly to Configuration/Management/Telnet menu.
snmp	Goes directly to Configuration/Management/SNMP menu.
maint	Goes directly to Configuration/Management/Maint menu.
dial	Goes directly to Configuration/Dial menu.
status	Goes directly to Configuration/Status menu.
test	Goes directly to Configuration/Test menu.
logs	Goes directly to Configuration/Logs menu.
util	Goes directly to Configuration/Utilities menu.

Some examples are listed below:

isdn spid_1 20555512340101	sets spid 1
telnet user 1 name "guest"	sets user name for telnet user list entry 1 to "guest"
dial 3 dial	dials the numbers for connection list profile number 3

Additional Commands

Other commands available from the terminal mode are given below:

save	Saves the configuration to non-volatile RAM (flash).
mac	Returns the MAC address for the Express 4100/4110.
version	Returns the firmware version and routing stack version.
reset	Resets the unit.
exit	Leaves terminal mode and returns to menus.
download	Downloads complete configuration to the terminal screen for capture.

Download/Uploading Configuration

The Express 4100/4110's configuration can be captured to a text file using the download command. The text file can be edited if required. Upload of the configuration can be accomplished by sending the text file to the Express 4100/4110 in terminal mode. A baud rate of 9600 is strongly recommended when uploading. As soon as the upload has been completed, type "save" to save the new configuration to flash. A "reset" command or power cycle 10 seconds after the save command is recommended to ensure that the new configuration is complete.

Appendix F Frame Relay Firmware Version

The Express 4100/4110 can be used with Frame Relay if you obtain the appropriate firmware by calling ADTRAN Technical Support at the number listed in the back of this manual.

Configuration/Frame Relay

Figure F-1 shows the Configuration/Frame Relay menu that appears when using this firmware. The additional menu choices available with this option are described following the figure.

```
Express L100/Configuration/Frame Relay
System Info| Maintenance Protocol   Annex D
IP          | Polling Frequency (5-30)  10
IPX        | DLCI Mapping               [+]
```

Bridge
Security
Frame Relay
PPP Profile
Management

```
MODE: IP          LOOP: Link down          E1: Idle          E2: Idle
                                         ^Z=help  0:0
```

Figure F-1. Configuration/Frame Relay Screen

Frame Relay/Maintenance Protocol

Write security: 3, Read security: 5

The Frame Relay maintenance protocol is used on the WAN port. The maintenance protocol is used to send link status and virtual circuit information between Frame Relay switches and other devices (such as routers) that communicate with them. Possible choices are listed below.

Annex D (def)	This is an ANSI standard and is the most commonly used standard in the US.
Annex A	This is the CCITT European standard.
LMI	This was developed by a vendor consortium and is also known as the "consortium" management interface specification. It is still used by some carriers in the U.S.
Static	This should be selected when there is no Frame Relay switch in the circuit. The DLCIs are assigned in the DLCI Mapping and must be the same for the device it will communicate with.

Frame Relay/Polling Frequency

Write security: 3, Read security: 5

This parameter is the interval that the Express 4100/4110 polls the Frame Relay switch using the maintenance protocol selected above. The Express 4100/4110 is required to poll the Frame Relay switch periodically to determine whether the link is active. The value is in seconds and ranges from 5 to 30 seconds with a default of 15 seconds.

Frame Relay/DLCI Mapping

This menu allows each DLCI to be mapped to a particular Frame Relay maintenance protocol. Each protocol parameter can be individually configured for each DLCI. By factory default, the DLCI map is empty.

When empty and a maintenance protocol other than static is used, the Express 4100/4110 will poll the switch to determine which DLCIs are active. These active DLCIs will attempt to determine the IP and IPX addresses on the other end of the virtual circuit using Inverse ARP

(IARP). If there is a response, the network learned will be added to the router tables and the virtual circuit will be treated as an unnumbered interface. Bridge mode is not attempted in this case.

When more than one DLCI mapping is listed, the Express 4100/4110 will try to match the DLCIs learned from the Frame Relay switch with the DLCI values in the map. If there is a match, the protocols specified in the map are used. However, if an active DLCI is not in the list it looks for an entry that has 0 in the DLCI field. This entry is considered the default entry to use when no match occurs. If this default entry is not present, the Express 4100/4110 falls back to using IARP as in the previous paragraph to determine the protocols to use with that particular virtual circuit. If a static maintenance protocol is used, at least one DLCI mapping must be specified.



*To insert a new profile, press the **I** key when over the **Num** column. A new inserted profile will always be set up with the default parameters. To copy parameters from an old profile to this newly inserted profile, use the copy (**C**) and paste (**P**) keys. Entire configuration trees can be copied with this method.*



*To delete an unused profile, use the **D** key when the cursor is over the number in the **Num** column. Once deleted, the profile is gone permanently as soon as the DLCI Mapping is saved. Items may be deleted when **DEL** appears below the status bar.*

DLCI Mapping/Active

Write security: 3, Read security: 5

When this parameter is set to **Yes** (def), the mapping is used to determine the protocols used. If set to **No**, the Express 4100/4110 will ignore the virtual circuit with this DLCI.

DLCI Mapping/DLCI

Write security: 3, Read security: 5

This is the DLCI associated with this virtual circuit. This value can range from 16 to 1007.

DLCI Mapping/IP Map

Write security: 3, Read security: 5

This menu represents the IP protocol mapping that is to take place for this DLCI.

IP Map/Active

Write security: 3, Read security: 5

When this is set to **Yes** (def), the Express 4100/4110 will attempt to transport IP packets for this DLCI. A setting of **No** means that no IP traffic or route will be exchanged.

IP Map/IARP

Write security: 3, Read security: 5

When this is set to **Yes** (def), the Express 4100/4110 will send Inverse ARP packets in order to determine the IP address on the other end of the virtual circuit. If the IARP is responded to, a route is placed in the IP route table. A setting of **No** means that the route address is to be assigned statically using the **IP Map/Far-End IP Address** parameter. The Express 4100/4110 will always respond to Inverse ARP requests.

IP Map/Far-End IP Address

Write security: 3, Read security: 5

This is the IP address of the device on the other end of the virtual circuit. When this DLCI becomes active, the Express 4100/4110 will add a route in the IP routing table.

IP Map/IP Netmask

Write security: 3, Read security: 5

The IP network mask to apply to the **Far-End IP Address** and **Link IP Address** is specified here.

IP Map/Link IP Address

Write security: 3, Read security: 5

The virtual circuit may require an IP address to be specified at this DLCI interface. This is called a numbered interface. This address is used by the Express 4100/4110 to respond to Inverse ARP requests. If this IP address is left as 0.0.0.0, the link is treated as unnumbered

and the Express 4100/4110 responds to the Inverse ARP with its Ethernet IP address.

IP Map/RIP Protocol

Write security: 3, Read security: 5

The RIP protocol can be specified per DLCI. The possible selections are **Off** (meaning no RIP packets are listened to or sent), **V1** (def) (which is RIP version 1) or **V2** (which is RIP version 2).

IP Map/RIP Method

Write security: 3, Read security: 5

The way the RIP protocol sends out its advertisements is specified here:

None	All routes in the router table are advertised out this virtual circuit with no modification of the metrics.
Split Horizon (def)	Only routes not learned from this particular virtual circuit are advertised.
Poison Reverse	All routes are advertised, but the routes learned from this port are "poisoned" with an infinite metric.

IP Map/RIP Direction

Write security: 3, Read security: 5

This parameter allows the direction at which RIP advertisements are sent and listened to be specified.

Tx and Rx (def)	RIP advertisements are periodically transmitted and are listened to on this virtual circuit.
Tx Only	RIP advertisements are periodically transmitted but are not listened to on this virtual circuit.
Rx Only	RIP is not transmitted on this virtual circuit but they are listened to.

IP Map/NAT

The Express 4100/4110 can perform Network Address Translation over a PVC. Setting this option to **On** will cause the Express 4100/4110 to translate between the Ethernet addresses and the configured

Link IP Address. Only one PVC may be used for translation at one time. If more than one IP Map is configured for NAT, the first PVC which is activated becomes the NAT port.

DLCI Mapping/IPX Map

This menu represents the IPX protocol mapping that is to take place for this DLCI.

IPX Map/Active

Write security: 3, Read security: 5

When this is set to **Yes** (def), the Express 4100/4110 will attempt to transport IPX packets for this DLCI. A setting of **No** means that no IPX traffic or route will be exchanged.

IPX Map/IARP

Write security: 3, Read security: 5

When this is set to **Yes** (def), the Express 4100/4110 will send Inverse ARP packets to determine the IPX network on the other end of the virtual circuit. If the IARP is responded to, a route is placed in the IPX route table. A setting of **No** means that the IPX network is to be assigned to the link statically using the IPX Map/Link Network parameter. The Express 4100/4110 will always respond to Inverse ARP requests.

IPX Map/Link Network

Write security: 3, Read security: 5

This is the IPX network of the link or of the other device's LAN. When this DLCI becomes active, the Express 4100/4110 will add a route to this network in the IPX routing table. This address is also used by the Express 4100/4110 to respond to Inverse ARP requests. If this IPX address is left as 0, the link is treated as unnumbered and the Express 4100/4110 responds to the Inverse ARP with its Ethernet IPX address.

DLCI Mapping/Bridge Map

This menu is used to permit bridging of packets over this DLCI. Each DLCI or virtual circuit must be assigned a bridge group. The bridge group treats all virtual circuits as one circuit. Bridge packets destined to be transmitted out a particular bridge group are copied and transmitted individually out each DLCI in the bridge group. However, incoming

bridge packets received from one DLCI are not retransmitted out the other DLCIs in the same bridge group. Any device in the bridge group must transmit to each DLCI. This requires a fully meshed circuit, meaning each device has a virtual circuit to each other.

Bridge Map/Active

Write security: 3, Read security: 5

When this is set to **Yes** (def), the Express 4100/4110 will bridge packets to and from this DLCI. Bridge packets are any packets that are not IP or IPX packets except when the router is turned off, in which case that particular router's protocol packets are bridged. A setting of **No** means that no bridging will occur.

Bridge Map/Bridge Group

Write security: 3, Read security: 5

The bridge group that this DLCI is part of is specified here as **Group 1** or **Group 2**. These groups correspond to the spanning tree protocols Bridge Group 1 and Bridge Group 2.

DLCI Mapping/Filters

The Express 4100/4110 can block packets in and out of a PVC port by use of the filters. They are set up in two steps: 1) define the types of packets that would be of interest in the **Configuration/Security/Filter Defines** menu, and 2) set up the filter type and combination of defines that will cause a packet block.

Filters/In from PVC

Write security: 2; Read security: 5

The packets which come into the Express 4100/4110 via this PVC can be filtered in three ways:

- | | |
|-----------------------|--|
| Disabled (def) | Turns off packet input filtering. No incoming packets from this PVC are blocked. |
| Block All | All incoming packets from this PVC are blocked except as defined in the Filters/In Exceptions list. |
| Forward All | All incoming packets from this PVC are not blocked except as defined in the Filters/In Exceptions list. |

Filters/In Exceptions

Write security: 2; Read security: 5

This is a list of up to 32 filter entries which can be combined using the operations field. The operations are performed in the order they appear on the list.

Active	Turns this entry active when set to On .
Type	Selects the filter define list to reference:
MAC	from the Configuration/Security/Filter Defines/MAC Filter Defines list.
Pattern	from the Configuration/Security/Filter Defines/Pattern Filter Defines list.
IP	from the Configuration/Security/Filter Defines/IP Filter Defines list.
IPX	from the Configuration/Security/Filter Defines/IPX Filter Defines list.
Filter List Name	Selects between filters defined in the list.
Next Oper	The next operation to use to combine with the next filter in the list:
END	the last filter to combination.
AND	logically AND this filter with the next filter in the list.
OR	logically OR this filter with the next filter in the list.

Filters/Out to PVC

Write security: 2; Read security: 5

The packets which transmit out this PVC from the Express 4100/4110 can be filtered in three ways:

Disabled (def)	Turns off packet output filtering. No outgoing packets to this PVC are blocked.
Block All	All outgoing packets to this PVC are blocked except as defined in the Filters/Out Exceptions list.
Forward All	All outgoing packets to this PVC are not blocked except as defined in the Filters/Out Exceptions list.

Filters/Out Exceptions

Write security: 2; Read security: 5

This is a list of up to 32 filter entries. The setup is exactly the same as the **Filter/In Exceptions** list.

Status/Sessions

Figure F-2 shows the Status/Sessions menu that appears when using the Frame Relay firmware. The additional menu choices available with this option are described following the figure.

```

Express L100/Status/Session
Session | PPP Session  [+]
ARP Cache | DLCI Table  [+]
Bridge Table | Spanning Tree [+]
IP Routes
IPX Routes
IPX Servers
WAN Stats
LAN Stats
IP Stats

MODE: IP          LOOP: Link down      B1: Idle      B2: Idle
1;20H [redacted] tion| Session  [+]          ^Z=help  0:0
    
```

Figure F-2. Status/Sessions Screen (with Frame Relay)

Sessions/PPP Session

Read security: 5

This menu reflects the results of PPP negotiations, user name, time connected, and data rates for the session.

- PPP Links** Reflects LCP layer active
- BCP** Shows UP if PPP Bridge Control Protocol has negotiated successfully
- IPCP** Shows UP if PPP IP Control Protocol has negotiated successfully

IPXCP	Shows UP if PPP IPX Control Protocol has negotiated successfully
User	Displays the user name of the PPP peer
Number(s)	Shows the phone number dialed if outgoing call or caller ID if incoming call.
Connect Time	Shows the date and time when the call last connected.
Up Time	Displays how long the call has been connected.
Tx Pkts	Number of packets transmitted
Rx Pkts	Number of packets received
Tx Bytes	Number of bytes transmitted
Rx Bytes	Number of bytes received
Tx Rate	Current application data transmission rate
Rx Rate	Current application data reception rate
Tx Link Rate	Current actual data transmission rate
Rx Link Rate	Current actual data reception rate

Sessions/DLCI Table

The status of all virtual circuits is displayed here.

DLCI	The DLCI that is associated with this virtual circuit.
State	The state of the virtual circuit:
Inactive	means the circuit exists but has been deactivated by the Frame Relay switch.

Exists	means the circuit exists at this point and should be activated soon.
Active	means the circuit is fully active.
Off	means the circuit has been turned off by the DLCI mapping active selection.
Tx Frames	Number of Frame Relay packets that have been transmitted via this DLCI.
Rx Frames	Number of Frame Relay packets that have been received via this DLCI.
Tx Bytes	Number of Frame Relay bytes that have been transmitted via this DLCI.
Rx Bytes	Number of Frame Relay bytes that have been received via this DLCI.
IP Sublfc	The IP router port assigned for this DLCI. Possible ports are fr0, fr1, ... , fr9. None means that this DLCI not used for routing IP.
IPX Sublfc	The IPX router port assigned for this DLCI. Possible ports are fr0, fr1, ... , fr9. None means that this DLCI not used for routing IPX.
Bridge Group	The bridge group that this DLCI belongs to (Group 1 or Group 2). None means that this DLCI is not used for bridging.

Sessions/Spanning Tree

Read security: 5

This option was discussed in the section “Call Sessions/Spanning Tree” on page 3-66.

Glossary

10Base2

IEEE 802.3 specification, similar to Ethernet, using thin coaxial cable that runs at 10 Mbps, with a maximum distance of 185 meters per segment. Also known as Thin Ethernet or Thinwire Ethernet.

10BaseT

IEEE 802.3 specification, using unshielded twisted-pair cabling and running at 10 Mbps.

AEP

AppleTalk Echo Protocol. Allows a node on an AppleTalk network to send a packet to another node and in return, receive an echoed copy of the packet.

B-Channel

64 kbps bearer channel used for voice, circuit, or packet switched data.

bearer service

As defined by CCITT standards, a type of telecommunication service that provides the capability for the transmission of information between user-to-network interfaces. Bearer services defined for ISDN are circuit mode and packet mode.

BOOTP

The Bootstrap Protocol allows a network node to determine certain startup information such as its IP address.

Bridge

A data communications device that connects two or more networks. A bridge stores and forwards complete packets between the networks. Bridges operate at the data-link layer of the OSI model.

CCITT

Consultative Committee on International Telephony and Telegraphy. A body of the International Telegraph Union (ITU) which prepares recommendations, commonly referred to as international standards, to resolve technical telegraph and telephone problems.

central office (CO)

In telephony, the phone company switching facility or center, usually a Class 5 end office, at which subscribers local loops terminate. Handles a specific geographic area, identified by the first three digits of the local telephone number. Usually the facilities of the local BOC.

CSMA/CD

Carrier Sense Multiple Access Collision Detect. A channel access mechanism where devices check the channel for a carrier before transmitting. If no carrier is sensed for the specified period of time, the device can transmit. If two devices transmit at once, a collision occurs and is detected by all colliding devices. This collision subsequently delays their retransmissions for a random length of time. CSMA/CD is used by Ethernet and IEEE 802.3.

D-channel

The ISDN channel that carries signalling information to control the call setup, tear-down, or invocation of supplementary services. The D-Channel may also be used to provide packet mode data service.

DDS

Dataphone Digital Service. AT&T private line service for transmitting data over a digital system. The digital transmission system transmits electrical signals directly, instead of translating the signals into tones of varied frequencies as with traditional analog transmission systems. Digital techniques provide more efficient use of transmission facilities, resulting in lower error rates and costs than analog systems.

digital hub

Designated office where DDS channels are interconnected and where synchronous network timing, testing access, and additional service features are provided.

Ethernet

A local area network used for connecting computers, printers, workstations, a terminals, servers, etc., within the same building or campus. Ethernet operates over twisted wire and coaxial cable at speeds up to 10 Mbps. Ethernet specifies a CSMA/CD.

four-wire circuits

Telephone lines using two wires for transmitting and two wires for receiving, offering much higher quality than a 2-wire circuit. All long distance circuits are 4-wire. Almost all local phone lines and analog phones are 2-wire.

group 4

A high-speed (56 kbps) facsimile protocol specific to ISDN.

hop count

A routing metric used to measure the distance between a source and a destination. Particularly used by RIP.

hub

(1) Communications center, (2) Major routing station for connecting channels, (3) DDS connecting center.

IEEE

Institute of Electrical and Electronic Engineers. Professional organization that defines network standards. IEEE LAN standards are the predominant LAN standards today and include protocols similar or virtually equivalent to Ethernet and Token Ring.

IEEE 802.1d

An algorithm used to prevent bridging loops by creating a spanning tree.

IEEE 802.2

An IEEE LAN protocol that specifies an implementation of the LLC sublayer of the data link layer. It handles errors, framing, flow control, network layer (Layer 3) service interface, and is used in LANs.

IEEE 802.3

A physical layer standard specifying a linear bus network LAN with a CSMA/CD access method on a bus topology. Ethernet follows the 802.3 standard, transmitting at 10 megabits per second. This is the most common local area network specification. Physical variations of IEEE 802.3 include 10Base2 and 10BaseT.

in-band signalling

Signalling made up of tones which pass within the voice frequency band and are carried along the same circuit as the talk path being established by the signals. Virtually all signalling (request for service, dialing, disconnect, etc.) in the U.S. is in-band signalling. Most of that signalling is MF (Multi-Frequency) dialing. The more modern form of signalling is out-of-band.

interexchange carrier

Since divestiture, any carrier registered with the FCC authorized to carry customer transmissions between LATAs interstate, or if approved by a state public utility commission, intrastate. Includes carriers such as AT&T Communications, Satellite Business Systems, GTE Telenet, GTE Sprint, and MCI.

information element

The name for the data fields within an ISDN Layer 3 message.

interworking

Communication between two types of networks or end equipment. This may or may not involve a difference in signalling or protocol elements supported.

Internet Protocol

A TCP/IP protocol describing software that tracks the Internet address of nodes, routes outgoing message, and recognizes incoming messages. Used in gateways to connect networks at OSI network Level 3 and above.

IPX

Internetwork Packet Exchange. A Novell NetWare protocol used to move information across networks.

ISDN

Integrated Services Digital Network. A network architecture that enables end-to-end digital connections. The network supports diverse services through integrated access

arrangements and defines a limited set of standard, multipurpose interfaces for equipment vendors, network providers, and customers. Interworking with a public switched telephone network is retained.

jabber

An error condition in which a network device continually transmits garbage onto the network. In IEEE 802.3, a data packet whose length exceeds that prescribed in the standard.

jitter

The slight movement of a transmission signal in time or phase that can introduce errors and loss of synchronization for high-speed synchronous communications. See phase jitter.

LATA

Local Access and Transport Area. One of 161 local telephone serving areas in the United States, generally encompassing the largest standard statistical metropolitan areas. Subdivisions established as a result of the AT&T divestiture that now distinguish local from long distance service. Circuits with both end-points within the LATA (intraLATA) are generally the sole responsibility of the local telephone company, while circuits that cross outside the LATA (interLATA) are passed on to an interexchange carrier.

loopback

A diagnostic procedure where data is sent to the device being tested, and the output of the device is fed directly back to its input, looped around, and the returning data is checked against that which was sent.

Media Access Control (MAC)

As defined by the IEEE, the lower of the two sublayers of the OSI reference model data link layer. The MAC sublayer is concerned with media access issues, such as whether token passing or contention is used.

message

The Layer 3 information that is passed between the CPE and SPCS for signalling.

multipoint line

A communications line having multiple cable access points.

Name Binding Protocol (NBP)

The AppleTalk transport-level protocol that translates a character string name into the internet address of the corresponding socket client; NBP enables AppleTalk protocols to understand user-defined zones and device names by providing and maintaining translation tables that map these names to corresponding socket addresses.

NAT

Network Address Translation occurs at the borders of stub domains. Its purpose is to translate the IP address of passing packets by changing all references of one IP address to another. Translation is performed as per RFC 1631.

netmask

A 32-bit bit mask which shows how an Internet address is to be divided into network, subnet, and host parts. The netmask has ones in the bit positions in the 32-bit address which are to be used for the network and subnet parts, and zeros for the host part. The mask should contain at least the standard network portion (as determined by the address's class), and the subnet field should be contiguous with the network portion.

non-ISDN line

Any connection from a CPE to a SPCS that is not served by D-Channel signalling.

non-ISDN trunk

Any trunk not served by either SS7 or D-Channel signalling.

NT1

Network Termination 1. A unit that provides physical and electromagnetic termination of the U-interface 2-wire transmission line, converts between Layer 1 formats used at the U- and T- reference points, and performs some maintenance functions.

phase jitter

In telephony, the measurement in degrees out-of-phase that an analog signal deviates from the reference phase of the main data-carrying signal. Often caused by alternating current components in a telecommunications network.

point-to-point protocol (PPP)

An implementation of TCP/IP which is intended for transmission using telephone lines. PPP provides router-to-router and host-to-network connections over both synchronous and asynchronous circuits.

poison routes

Routes which have an infinite metric which to other routers means the network for the route is inaccessible.

PRA

Primary Rate Access. Connects high-capacity CPE, such as PBXs, to the network. In the US, this is composed of twenty-three 64 kbps channels and one 64 kbps D-channel. Also known as Primary Rate Interface (PRI).

RIP

Routing Information Protocol. A protocol used to exchange routing information among a set of computers connected by a LAN. RIP uses hop counts as a routing metric.

router

An interface which finds the best route between two networks. Routers forward packets from one network to another, based on network layer information.

routing metric

The method by which a routing algorithm determines one route is better than another. This information is stored in routing tables. Such tables include reliability, delay bandwidth, load, MTUs, communication costs, and hop count.

RS-232-C

An EIA-specified physical interface with associated electrical signalling between DCE and DTE. The most commonly employed interface between computer devices and modems.

RTMP

Routing Table Maintenance Protocol. The AppleTalk protocol used to establish and maintain the routing information that is required by internet routers in order to route datagrams from any source socket to any destination socket in the internet. Using RTMP, internet routers dynamically maintain routing tables to reflect changes in internet topology.

service advertising protocol (SAP)

An IPX protocol through which network resources such as servers become known to clients.

servicing area

Region surrounding a broadcasting station where signal strength is at or above a stated minimum. The geographic area handled by a telephone central office facility. Generally equivalent to a LATA.

SNMP

Simple Network Management Protocol. SNMP provides a means to monitor and set network configuration and runtime parameters.

spanning tree

A loop-free subset of the topology of a network.

SPCS

Stored Program Controlled Switch. A digital switch that supports call control, routing, and supplementary services provision under software control. All ISDN switches are SPCSs.

spoofing

Spoofing reduces the required bandwidth by having devices, such as bridges or routers, answer for the remote devices. This causes the remote LAN to appear as if it is still connected to the LAN device even though it is not. The spoofing saves the WAN bandwidth, because no packet is ever sent out on the WAN.

synchronous

(1) The condition occurring when two events happen in a specific time relationship with each other, both under control of a master clock; (2) A method of data transmission requiring the transmission of timing pulses to keep the sender and receiver synchronized in their communication used to send blocks of information. Synchronous data transmission is used in high speed data circuits because there is less overhead than asynchronous transmission of characters which contain two extra bits per character to effect timing.

T1

Also T-1. A digital transmission link with a capacity of 1.544 Mbps. T1 uses two pairs of normal twisted wires. T1 normally can handle 24 voice conversations with each conversation being digitized at 64 kbps. With more advanced digital voice encoding techniques, it can handle more voice channels. T1 is a standard for digital transmission in North America.

TA

Terminal Adaptor. A DCE that connects to the ISDN S-Interface and enables non-ISDN terminal equipment to communicate over the ISDN.

TE1

Terminal Equipment Type 1. ISDN-compatible terminals.

Telnet

The TCP/IP standard protocol for remote terminal connection service. Telnet allows a user at one site to interact with a remote timesharing system at another site as if the user's terminal were connected directly to the remote machine.

TCP/IP

Transmission Control Protocol/Internet Protocol. A set of protocols developed by the Department of Defense to link dissimilar computers across many kinds of networks.

twisted pair

Two wires twisted around each other to reduce induction (interference) from one wire to the other. Several sets of twisted pair wires may be enclosed in a single cable. Twisted pair is the normal cabling from a central office to your home or office, or from your PBX to your office phone. Twisted pair wiring comes in various thicknesses. As a general rule, the thicker the cable is, the better the quality of the conversation and the longer cable can be and still get acceptable conversation quality. However, the thicker it is, the more it costs.

2B+D

The Basic Rate Interface (BRI) in ISDN. A single ISDN circuit divided into two 64 kbps digital channels for voice or data and one 16 kbps channel for low speed data (up to 9,600 baud) and signalling. 2B+D is carried on one or two pairs of wires depending on the interface, the same wire pairs that today bring a single voice circuit into your home or office. See ISDN.

23B+D

In ISDN, also known as the Primary Rate Interface. A circuit with a wide range of frequencies that is divided in twenty-three 64 kbps paths for carrying voice, data, video, or other information simultaneously. It bears a remarkable similarity to today's T1 link, except that T1 carries 24 voice channels. In ISDN, 23B+D gives twenty-three channels and one D channel for out-of-band signalling. However, in T1, signalling is handled in-band. See ISDN.

two-wire circuit

A transmission circuit composed of two wires, signal and ground, used to both send and receive information. In contrast, a 4-wire circuit consists of two pairs. One pair is used to send and one pair is used to receive. All trunk circuits (long distance) are

4-wire. A 4-wire circuit delivers better reception, but also costs more. All local loop circuits (those coming from a Class 5 central office to the subscriber's phone system) are 2-wire, unless a 4-wire circuit is requested.

U-interface

A twisted pair subscriber loop that connects the NT1 reference point to the ISDN network, as defined in the I.411 Recommendation. This interface provides Basic Rate Access with an operating frequency of 160 kbps and an information rate of 144 kbps. Under U.S. regulations, this also marks the line of demarcation between customer-owned equipment and the public network.

ZIP

Zone Information Protocol. The AppleTalk session-layer protocol used to maintain and discover the internet-wide mapping of network number ranges to zone names.

Zombie Routes

Routes that have been identified by the router to be deleted. They remain in the router's route table for a specified amount of time with an infinite metric so that all other routers will learn of this router's intention to delete them.

Acronyms

AEP	AppleTalk Echo Protocol
AMI	Alternate Mark Inversion
ARP	Address Resolution Protocol
B (Channel)	A 64 kbps digital information channel
BCP	Bridge Control Protocol
BONDING	Bandwidth On Demand Interoperability Group
BOOTP	Bootstrap Protocol
BPDU	Bridging Protocol Data Unit
bps	Bits per second
Bps	Bytes per second
BRI	Basic Rate Interface
CA	Call Appearance
CCP	Compression Control Protocol
CCITT	Consultative Committee for International Telegraphy and Telephony
CD	Carrier Detect
CPE	Customer Premises Equipment
CRC	Cyclic Redundancy Check
CSMA/CD	Carrier Sense Multiple Access Collision Detect
DHCP	Dynamic Host Configuration Protocol
DMS	Digital Multiplex Switching
DTE	Data Terminal Equipment
DTMF	Dual Tone Multi-Frequency
EKTS	Electronic Key Telephone Service

ESS	Electronic Switching System
FAX	Facsimile
FEBE	Far End Block Errors
FTP	File Transfer Protocol
ICMP	Internet Control Message Protocol
ID	Identification
IETF	Internet Engineering Task Force
I/O	Input/Output
IP	Internet Protocol
IPCP	Internet Protocol Control Protocol
IPX	Internetwork Packet Exchange
PL	Integrated Injected Logic
IEC	Inter-Exchange Carrier
ISDN	Integrated Services Digital Network
ISO	International Standardization Organization
ISP	Internet Service Provider
kbps	Kilobits per second
kHz	Kilohertz
LAN	Local Area Network
LCP	Link Control Protocol
LDN	Local Directory Number
MAC	Media Access Control
MIB	Management Information Base
MP	Multilink Protocol
MRU	Maximum Receivable Unit
MRRU	Maximum Receivable Reconstructable Unit
NBP	Name Binding Protocol
NEBE	Near End Block Errors
NIC	Network Interface Card
NI-1	National ISDN-1
NT	Network Termination
PBX	Private Branch Exchange
PC	Personal Computer

PING	Packet InterNet Groper
POTS	Plain Old Telephone Service
PPP	Point-to-Point Protocol
PRI	Primary Rate Interface
RFC	Request For Comments
RIP	Routing Information Packet, Routing Information Protocol
RTMF	Routing Table Maintenance Protocol
SAP	Service Advertising Protocol
SNMP	Simple Network Monitoring Protocol
SPCS	Stored Program Controlled Switching System
SPID	Service Profile Identifier
TCP	Transmission Control Protocol
TEI	Terminal Endpoint Identifier
TFTP	Trivial File Transfer Protocol
UDP	User Datagram Protocol
WAN	Wide Area Network
ZIP	Zone Information Protocol

Index

Numerics

10-base-T interface D-2

56K 3-50

64K 3-50

A

address table 3-28

address table/aging 3-28

address table/forward policy 3-28

agent C-1, C-2

applications

 multiple users to ISP using NAT 1-4

 single user to corporate LAN 1-2

 single user to ISP using NAT 1-3

 SOHO to corporate LAN 1-5

area code 3-11

ARP cache 3-66

audio 3-50

authentication 3-29, 3-37

 with Express L100/L100T as
 authenticatee 3-38

 with Express L100/L100T as
 authenticator 3-37

authentication/call ID 1 3-40

authentication/call ID 2 3-40

authentication/caller ID 3-40

authentication/Rx password 3-40

authentication/Rx username 3-39

authentication/Tx method 3-39

authentication/Tx password 3-39

authentication/Tx username 3-39

autospid 3-11

B

B1 and B2 bearer channel status
messages A-3

BACP 3-47

bandwidth 3-51

bandwidth on demand 1-7

bandwidth/idle timeout 3-51

bandwidth/lower threshold 3-52

bandwidth/max channels 3-52

bandwidth/min channels 3-52

bandwidth/mode 3-51

bandwidth/on demand 3-51

bandwidth/preempt time 3-51

bandwidth/samples 3-53

bandwidth/upper threshold 3-52

BAP 1-13, 3-47

basic telephone service 2-2

- baud rate 3-61
- bridge 3-45
- bridge map/active F-7
- bridge map/bridge group F-7
- bridge menu 1-9, 3-25
- bridge table 3-67
- bridge/address table 3-28
- bridge/mode 3-25, 3-45
- bridge/WAN IP bridge 3-26
- bridge/WAN IPX bridge 3-26
- bridging 1-7
 - concurrent routing and bridging 1-9
 - demand 1-6
- C**
- call log 3-75
- call log messages B-6
- call log/active 3-76
- call log/clear 3-76
- call log/level 3-76
- call log/view 3-76
- call log/wrap 3-76
- call sessions 3-65
- call sessions/session1 and session2 3-65
- call sessions/spanning tree 3-66
- call type 3-49
- call waiting 2-3
- caller ID 3-40
- channel rate 3-12
- CHAP 3-31, 3-39
- clock mode 3-12
- command line interface E-1
- command prompt mode 3-61
- commands E-4
- communities C-3
- communities/manager IP 3-60
- communities/name 3-59
- communities/privilege 3-59
- compression 3-48
- concurrent routing and bridging 1-9
- conferencing calls 2-3
- configuration 1-14
 - downloading/uploading E-4
- configuration menu 3-3, 3-8
- configuration/bridge 3-25
- configuration/connection list 3-36
- configuration/IP 3-15
- configuration/IPX 3-22
- configuration/management 3-57
- configuration/management menu 3-57
- configuration/security 3-29
- configuration/system info 3-8
- configuration/terminal mode 3-61
- configuration/WAN 3-10
- configuration/WAN screen F-1
- connecting to the internet 1-13
- connection
 - ISDN 1-11
 - LAN 2-1
 - telephone 2-2
- connection list 1-7, 1-9, 3-29, 3-36
- connection list profile
 - deleting 3-37, F-3
 - inserting 3-36
- connection list/active 3-37
- connection list/authentication 3-37
- connection list/bandwidth 3-51

connection list/bridge 3-45
connection list/description 3-37
connection list/dial out 3-49
connection list/filters 3-53
connection list/IP 3-40
connection list/IPX 3-44
connection list/PPP 3-47
connection list/probe 3-46
connector pinouts D-1
corporate LAN Quick Start-3, 1-2, 1-5
customer premises wiring 2-3

D

data bits 3-61
default gateway 3-16
demand bridging 1-6
demand dial filters 3-55
demand routing 1-6
DHCP mode 3-18
dial 1-9
dial line 3-10
dial line/area code 3-11
dial line/ExpertISDN 3-11
dial line/LDN 1 or 2 3-12
dial line/SPID 1 3-11
dial line/switch protocol 3-11
dial menu 3-3, 3-62
dial out 3-49
dial out/attempts 3-51
dial out/call type 3-49
dial out/connection timeout 3-50
dial out/delay 3-50
dial out/initial channels 3-51
dial out/number 1 3-49

dial out/number 2 3-49
dial out/redial at 56K 3-50
dial self 3-73
dial/channels 3-63
dial/description 3-62
dial/dial 3-62
dial/hang up 3-63
dial/number 1 3-63
dial/number 2 3-63
dial/status 3-63
display 5-2
DLCI mapping F-2
DLCI mapping/active F-3
DLCI mapping/bridge map F-6
DLCI mapping/DLCI F-3
DLCI mapping/filters F-7
DLCI mapping/IP map F-4
DLCI mapping/IPX map F-6
DLCI table F-11
DMS-100 3-11
DNS 3-19
DNS server 3-19
DNS/domain name 3-19
DNS/server 1 3-19
DNS/server 2 3-19
domain name 3-19
download/uploading configuration E-4
DTMF keypad 2-2

E

EAP 3-31, 3-39
echo request 3-73
EIA-232 interface D-1
embedded agent C-2

- environmental specifications 5-2
- Ethernet interface D-2
- Ethernet interface (LAN) 5-1
- ExpertISDN Quick Start-2, 2-2, 3-11
- Express L100/L100T
 - overview 1-1
- F**
- factory default 1-6
- features 5-1
- FEBE 3-13
- filter
 - setting up 3-32
- filter defines 3-32
- filter defines /IP filter defines 3-33
- filter defines /IPX filter defines 3-34
- filter defines /MAC filter defines 3-32
- filter defines /pattern filter defines 3-33

filters F-7

- setting up 3-53

- filters/dem dial exceptions 3-56
- filters/demand dial 3-55
- filters/in exceptions 3-54, F-8
- filters/In from PVC F-7
- filters/LAN-to-WAN (out) 3-55
- filters/out exceptions 3-55, F-9
- filters/Out to PVC F-9
- filters/WAN-to-LAN (in) 3-53

- firmware F-1
- firmware revision 3-9
- flash-hook 2-3
- frame relay F-1, F-10
- frame relay/DLCI mapping F-2
- frame relay/maintenance protocol F-2

- frame relay/polling frequency F-2
- frame type 3-23
- front panel 1-10
- G**
- GetNextRequest C-2
- H**
- hang up 1-8
- hang-up 1-7
- I**
- idle timeout 1-7
- IETF 1-13
- if self-test fails 4-1
- if the Express L100/L100T does not read ready 4-1
- if you are unable to connect calls 4-6
- indicators
 - LAN 1-10
 - test 1-10
 - WAN 1-10
- installation 2-1
- interface
 - Ethernet 5-1
 - network 5-1
 - POTS (dual) 5-1
- internet
 - connecting to 1-13
- internet access
 - using NAT Quick Start-2
- internet service provider
 - connecting Quick Start-2
- interoperability 1-13
- IP filter defines 3-33
- IP map/active F-4

- IP map/far-end IP address F-4
- IP map/IARP F-4
- IP map/IP netmask F-4
- IP map/link IP address F-4
- IP map/NAT F-5
- IP map/RIP direction F-5
- IP map/RIP method F-5
- IP map/RIP protocol F-5
- IP menu 3-15
- IP router 1-6, 3-17
- IP router/mode 3-17
- IP routes 3-67
- IP routing 1-8
- IP stats 3-71
- IP/default gateway 3-16
- IP/DNS 3-19
- IP/IP address 3-15
- IP/IP router 3-17
- IP/mode 3-40
- IP/NAT 3-18, 3-40
- IP/proxy ARP 3-21
- IP/RIP 3-17, 3-42
- IP/route 3-41
- IP/static routes 3-16
- IP/subnet mask 3-15
- IP/UDP relay 3-19
- IPX filter defines 3-34
- IPX map/active F-6
- IPX map/IARP F-6
- IPX map/link network F-6
- IPX menu 3-22
- IPX protocol Quick Start-5
- IPX router 1-6
- IPX routes 3-68
- IPX routing 1-9
- IPX servers 3-69
- IPX/frame type 3-23
- IPX/mode 3-22, 3-44
- IPX/network 3-22
- IPX/remote network 3-44
- IPX/retain 3-44
- IPX/RIP timer 3-24
- IPX/SAP timer 3-24
- IPX/seed status 3-23
- IPX/triggered 3-44
- IPX/type 20 packets 3-45
- ISDN
 - connection 1-11
 - network connection 2-1
 - ordering 1-13
 - overview 1-1
 - setting up the line Quick Start-1
- ISDN line
 - selecting mode 3-10
- ISDN/dial line 3-10
- ISDN/FEBEs 3-13
- ISDN/leased line 3-12
- ISDN/NEBEs 3-13
- ISP 1-13
- L**
- LAN bridge 1-5
- LAN connection 2-1
- LAN indicators 1-10
- LAN stats 3-70
- LDN 3-12
- leased line 3-12

leased line/channel rate 3-12

leased line/clock mode 3-12

LEDs 1-11

log messages B-1

logs menu 3-3, 3-74

logs/call log 3-75

logs/network log 3-76

logs/PPP log 3-75

logs/sys log host 3-75

loop status messages A-1

LUCENT 5ESS 3-11

M

MAC addresses 1-5

MAC bridging 1-6

MAC filter defines 3-32

maint port/baud rate 3-61

maint port/data bits 3-61

maint port/parity 3-61

maint port/password 3-60

maint port/password protect 3-60

maint port/stop bits 3-61

maintenance port 3-60

maintenance protocol F-2

management 3-57

management/maint port 3-60

management/SNMP 3-59

management/Telnet/web 3-57

menu commands E-1

menu structure 3-1

MIB 3-57, C-1

mode 1-8

multilink 3-47

multilink call 1-7

multilink/BACP 3-47

multilink/fragment 3-47

multilink/mode 3-47

multiprotocol routing Quick Start-3

N

NAT 1-3, 1-4, 1-6, 3-18, 3-19

NAT mode 1-10

NAT/DHCP mode 3-18

NAT/DHCP renewal time 3-18

NAT/web server 3-19

National ISDN1 3-11

NEBE 3-13

NEC 3-11

network address translation (NAT)

 internet access using Quick Start-2

network connection

 ISDN 2-1

network device

 GetResponse C-2

network interface 5-1

network log 3-76

network log messages B-17

network log/active 3-76

network log/clear 3-77

network log/level 3-77

network log/view 3-77

network log/wrap 3-76

network manager C-1

 GetRequest C-2

none 3-18

Novell 1-9

 IPX protocol Quick Start-5

O

ordering ISDN 1-13

P

packets

 filtering 3-32

PAP 3-31, 3-39

parity 3-61

password 3-58, 3-60

pattern filter defines 3-33

physical specifications 5-3

ping 3-78

poison reverse 3-17, 3-43

polling frequency F-2

POTS 1-6, 3-13

POTS interface (dual) 5-1

POTS/NI-1 conference FI 3-13

POTS/NI-1 transfer FI 3-13

POTS/POTS assignment 3-13

POTS/speech calltype routing 3-14

power requirements 5-3

PPP 1-13, 3-31, 3-47

PPP log 3-75

PPP log messages B-1

PPP log/active 3-75

PPP log/clear 3-75

PPP log/level 3-75

PPP log/view 3-75

PPP log/wrap 3-75

PPP peer 3-19

PPP/compression 3-48

PPP/max config 3-48

PPP/max failure 3-49

PPP/max timer 3-48

PPP/multilink 3-47

PPP/VJ compression 3-48

private 1-8

probe 3-46

probe/ update window 3-46

probe/active 3-46

probe/interval 3-46

proxy ARP 3-21

Q

quick startup guide Quick Start-1

R

radius 3-29, 3-58

radius server 3-30

radius server/primary server 3-30

radius server/retry count 3-31

radius server/secondary server 3-30

radius server/secret 3-30

radius server/UDP port 3-30

rear panel 1-11, 1-12

redial at 56K 3-50

remote/home office

 accessing corporate LAN Quick
 Start-3

retain 1-8

RIP 1-6, 1-9, 3-17, 3-42

RIP timer 3-24

RIP/direction 3-18, 3-43

RIP/method 3-17, 3-43

RIP/mode 3-17, 3-42

RIP/protocol 3-17, 3-42

RIP/retain 3-43

RIP/triggered 3-43

RIP/V2 secret 3-18

- RJ-11 interface D-2
- RJ-49C interface D-1
- route/force IP 3-42
- route/hops 3-42
- route/IP/net 3-41
- route/netmask 3-41
- route/private 3-42
- route/static route 3-41
- routing
 - concurrent routing and bridging 1-9
 - demand 1-6
 - IP 1-8
 - IPX 1-9
 - multiprotocol Quick Start-3
 - over PPP bridging 1-9
- Rx only 3-18
- S**
- samples/sample rate 3-53
- samples/samples 3-53
- samples/time between changes 3-53
- SAP 1-6, 1-9
- SAP timer 3-24
- security 1-14
- security levels 3-7
- security menu 3-29
- security/authentication 3-29
- security/filter defines 3-32
- security/PPP 3-31
- security/radius server 3-30
- security/when 3-30
- seed status 3-23
- self test
 - if self test fails 4-1
- sessions/DLCI table F-11
- sessions/PPP session F-10
- sessions/spanning tree F-13
- SetRequest C-2
- slave mode 3-12
- SNMP 3-59, C-1
- SNMP access 3-59
- SNMP/communities 3-59
- SNMP/traps 3-60
- SOHO (small office - home office) 1-5
- spanning tree 3-66, F-13
- spanning tree algorithm 1-5
- specifications 5-1
 - environmental 5-2
 - physical 5-3
- speech 3-49
- speech calltype routing 3-14
- SPID 3-11
- split horizon 3-17, 3-43
- static route 1-8
- static routes/active 3-16
- static routes/gateway 3-16
- static routes/hops 3-16
- static routes/IP address 3-16
- static routes/private 3-17
- static routes/subnet mask 3-16
- status menu 3-3, 3-64
- status/ARP cache 3-66
- status/bridge table 3-67
- status/call sessions 3-65
- status/IP routes 3-67
- status/IP stats 3-71
- status/IPX routes 3-68

- status/IPX servers 3-69
- status/LAN stats 3-70
- status/sessions F-10
- status/sessions screen F-10
- status/WAN stats 3-70
- stop bits 3-61
- subnet mask 3-15
- supplementary services 2-2
- switch compatibility 5-1
- switch protocol 3-11
- system contact 3-9
- system info menu 3-8
- system location 3-9
- system name 3-8
- system uptime 3-9
- T**
- telephone connection 2-2
- Telnet 1-14, 3-57
- Telnet client 3-79
- Telnet/server access 3-58
- Telnet/user list 3-58
- terminal menu
 - navigating 3-4
 - structure 3-1
 - top level 3-2
- terminal mode 3-61
- terminal mode commands E-1
- test indicators 1-10
- test menu 3-3, 3-73
- test menu/dial self 3-73
- test menu/echo request 3-73
- transfer methods 3-79
- trap C-2
- traps C-3
- traps/manager IP 3-60
- traps/manager name 3-60
- troubleshooting 4-1
 - calls 4-6
 - if self test fails 4-1
 - if self-test fails 4-1
 - if the Express L100/L100T does not read ready 4-1
 - if you are unable to connect calls 4-6
- Tx and Rx 3-18
- Tx methods 3-39
- Tx only 3-18
- type 20 packets 3-45
- U**
- UDP port type 3-20
- UDP relay 3-19
- UDP relay list 3-20
- UDP relay list/relay address 3-20
- UDP relay list/UDP port type 3-20
- UDP relay list/UDP ports 1, 2, 3 3-20
- UDP relay/mode 3-20
- UDP relay/UDP relay list 3-20
- upgrade menu 3-79
- upgrade/filename 3-79
- upgrade/start transfer 3-80
- upgrade/transfer method 3-79
- user list 3-58
- user list/authen method 3-58
- user list/idle time 3-58
- user list/level 3-59
- user list/name 3-58
- user list/password 3-58

- using keyboard to navigate menu 3-5
- utilities menu 3-3, 3-78
- utilities/exit 3-80
- utilities/ping 3-78
- utilities/Telnet client 3-79
- utilities/upgrade menu 3-79
- V**
- VJ compression 3-48
- W**
- WAN indicators 1-10
- WAN IP bridge 3-26
- WAN IP bridge proxy ARP 3-26
- WAN IP bridge/netmask 3-26
- WAN IP bridge/network 3-26
- WAN IP bridge/triggered 3-26
- WAN IPX bridge 3-26
- WAN IPX bridge/frame type 3-27
- WAN IPX bridge/network 3-27
- WAN IPX bridge/seed status 3-27
- WAN IPX bridge/triggered 3-27
- WAN menu 3-10
- WAN stats 3-70
- WAN/ISDN 3-10
- WAN/POTS 3-13
- wiring 2-3, 2-4, 2-5
- X**
- xmodem 3-79

Product Support Information

Presales Inquiries and Applications Support

Please contact your local distributor, ADTRAN Applications Engineering, or ADTRAN Sales:

Applications Engineering (800) 615-1176

Sales (800) 827-0807

Post-Sale Support

Please contact your local distributor first. If your local distributor cannot help, please contact ADTRAN Technical Support and have the unit serial number available.

Technical Support (888) 4ADTRAN

Repair and Return

If ADTRAN Technical Support determines that a repair is needed, Technical Support will coordinate with the Customer and Product Service (CAPS) department to issue an RMA number. For information regarding equipment currently in house or possible fees associated with repair, contact CAPS directly at the following number:

CAPS Department (256) 963-8722

Identify the RMA number clearly on the package (below address), and return to the following address:

ADTRAN Customer and Product Service
6767 Old Madison Pike
Progress Center
Building #6 Suite 690
Huntsville, Alabama 35807

RMA # _____

Free Manuals Download Website

<http://myh66.com>

<http://usermanuals.us>

<http://www.somanuals.com>

<http://www.4manuals.cc>

<http://www.manual-lib.com>

<http://www.404manual.com>

<http://www.luxmanual.com>

<http://aubethermostatmanual.com>

Golf course search by state

<http://golfingnear.com>

Email search by domain

<http://emailbydomain.com>

Auto manuals search

<http://auto.somanuals.com>

TV manuals search

<http://tv.somanuals.com>