

TRDDS-R Total Reach® All Rate DDS Termination Unit For Outside Plant and Customer Premise Installation and Maintenance

CONTENTS

1. GENERAL	1
2. OPTIONS	2
3. INSTALLATION	2
4. TESTING	4
5. DEPLOYMENT GUIDELINES	6
6. WARRANTY AND CUSTOMER SERVICE	7

FIGURES

Figure 1. ADTRAN TRDDS-R	1
Figure 2. Total Reach DDS Circuit Diagram	2
Figure 3. TRDDS-R Option Switch	2
Figure 4. Circuit Card Pin Assignments	3
Figure 5. Signal Loss Indication	4
Figure 6. Total Reach Dataport Bidirectional Loopback Pass-Thru Mode	6
Figure 7. Total Reach Dataport Bidirectional Loopback Normal Mode	6

TABLES

Table 1. Wiring Connections	3
Table 2. UL/CUL Telecommunications Codes	3
Table 3. Faceplate Indicators	4
Table 4. TRDDS-R and Total Reach Dataport Loopback Interoperability Matrix	4
Table 5. Latching Loopback Sequences	5
Table 6. Alternating Loopback Sequences	5
Table 7. Total Reach Dataport Loopbacks	6
Table 8. Cable Type and Temperature Loss Data @ 13.3 kHz	7
Table 9. TRDDS Insertion Loss Measurements	7

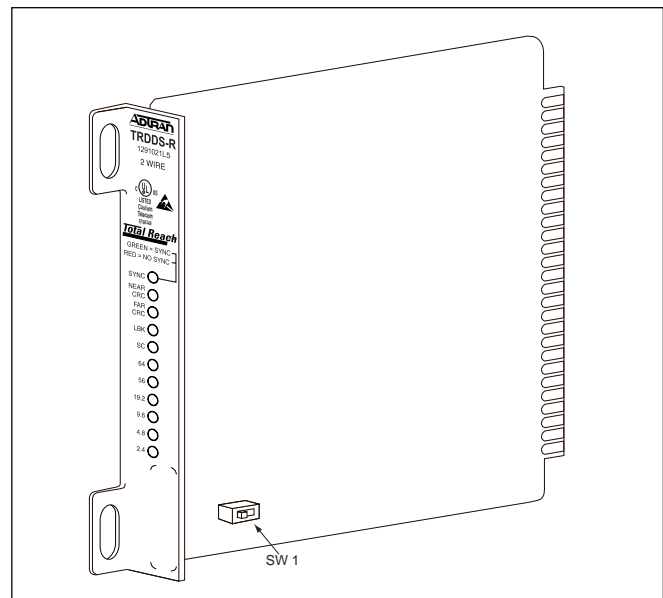

Figure 1. ADTRAN TRDDS-R

NOTE

The TRDDS-R must be used with an appropriate Total Reach dataport unit.

1. GENERAL

This practice provides installation and maintenance procedures for the ADTRAN TRDDS-R Total Reach® All Rate DDS Termination Unit. Figure 1 is an illustration of the ADTRAN TRDDS-R Unit.

The ADTRAN TRDDS-R is a span-powered termination unit designed to deliver data rates up to 64 kbps and provide testing functionality. Used in combination with a Total Reach dataport unit, the TRDDS-R converts the two-wire Total Reach signal to the traditional four-wire DDS signal for presentation to the customer.

The TRDDS-R is an auto-rate adaptive digital network interface typically located at the customer premises point-of-demarkation. The TRDDS-R will deliver a standard four-wire DDS signal up to 18 kft beyond the TRDDS-R. Both customer and network interfaces are equipped with outside plant lightning protection. The customer interface is capable of receiving signals attenuated to -45dB at the Nyquist frequency of four-wire AMI DDS. In addition to terminating the two-wire extended range signal, the TRDDS-R functions as a regenerative loopback device supporting Telco-generated testing. The TRDDS-R unit is available in T200 mechanics, and may be optioned for 0 or -10 dB output toward the customer. Figure 2 illustrates the Total Reach DDS Circuit Diagram.

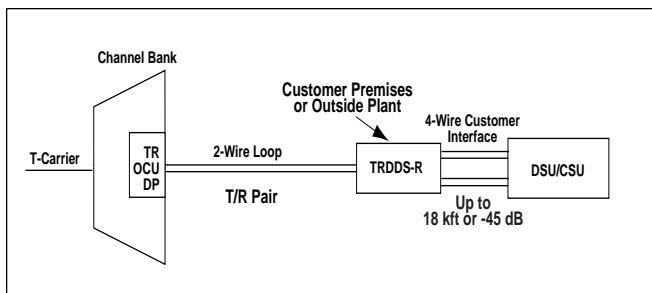

Figure 2. Total Reach DDS Circuit Diagram

Features

- Two-wire deployment
- Repeaterless operation
- Bridged tap tolerant
- Span-powered
- Auto-rate adaption on subrates, 19.2 and 56 kbps rates, including secondary channel, and 64 kbps clear channel capability
- LED indicators for Power, SYNC, NEAR/FAR CRC, Service Rate, and Loopback
- T200 mechanics
- Signal-level indication during synchronization
- Automatic data pass-thru upon detection of bidirectional central Office (CO) loopback at power-up
- Extended range on customer interface up to 18 kft or -45 dB
- Sealing Current of 12 mA on the four-wire customer interface

With -130 Vdc, ADTRAN's TRDDS system is in the A3 Class as specified in Bellcore TR-NWT-001089, Standard for Electrical Safety for Network Telecommunications Equipment.

2. OPTIONS

Rate is automatically configured from the Total Reach dataport unit. Options are selected using the SW1 switch as illustrated in Figure 3.

When 0 dB (SW1-1) is selected, the unit will transmit a 0 dB AMI signal across the four-wire interface toward the customer DSU/CSU. When -10 dB is selected, the unit will transmit a -10 dB AMI signal toward the DSU/CSU.

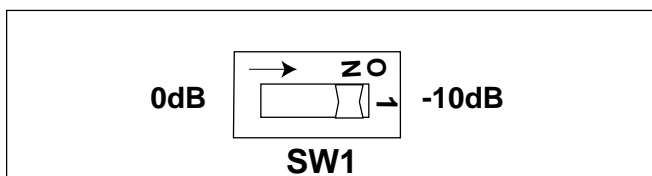

Figure 3. TRDDS-R Option Switch

3. INSTALLATION



After unpacking the unit, immediately inspect it for possible shipping damage. If damage is discovered, file a claim immediately with the carrier, and then contact ADTRAN Customer and Product Service (CAPS). See Section 6, *Warranty and Customer Service*.

CAUTION

Never install telephone wiring during a lightning storm.

Never install telephone jacks in wet locations unless the jack is specifically designed for wet locations.

Never touch uninsulated telephone wires or terminals unless the telephone line has been disconnected at the network interface.

Total Reach dataports normally provide -130 V of span-powering voltage to the TRDDS-R.

Wiring

For indoor applications, the TRDDS-R can be housed in a standard T400/T200 shelf or the ADTRAN T400/T200 Single Mount Housing, part number 1212007L1. The ADTRAN T400/T200 single environmental housing, part number 1150087L1, is recommended for outside plant applications. Connections are made using screwdown terminals on the barrier strip located on the housing. Frame ground is presented on pins 1, 11, 17, and 27 to accommodate various T400/T200 mountings. Figure 4 describes the circuit card pinout and Table 1 shows the wiring connections for the TRDDS-R for both inside and outside mounting applications.

The unit should be wired as follows:

- *Network* pair to terminal strip TT and TR positions
- *To Customer* and *From Customer* pairs through customer 8-pin modular connector

or

To Customer (DRT, DRR) and *From Customer* (DTT, DTR) to designated terminal strip positions

No rate selection is necessary for the TRDDS-R. The unit automatically adapts to the service rate of the Total Reach dataport in the Central Office (CO).

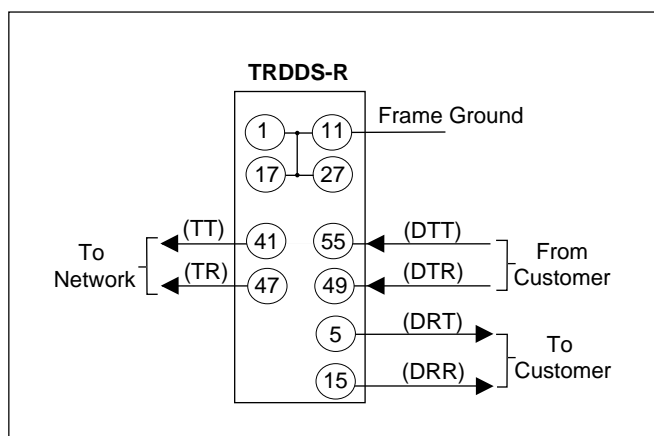

Figure 4. Circuit Card Pin Assignments

Table 1. Wiring Connections

Pair	Terminal Strip Designations	T400 Pin Number	Customer RJ48
To/From Network	TT, TR	41, 47	
To Customer (Rx)	DRT, DRR	5, 15	7, 8
From Customer (Tx)	DTR, DTT	49, 55	1, 2

Electrical Code Compliance

Table 2 shows the UL/CUL Telecommunications Codes for the TRDDS-R. The TRDDS-R complies with the requirements covered under UL 1459 third edition and is intended to be installed in an enclosure with an Installation Code (IC) of “B” or “E”. The TRDDS-R is intended for installation in restricted access locations only.

Table 2. UL/CUL Telecommunications Codes

	INPUT	OUTPUT
IC	A	-
TC	X	X
PC	C	C



Display Indicators

The TRDDS-R contains faceplate-mounted LED indicators which display the operating status and service rate. The indicators are described in Table 3.

Signal Meter

The TRDDS-R contains a signal meter that approximates the amount of dB loss on the TRDDS loop at 13.3 kHz (135 Ω termination), the Nyquist frequency of TRDDS. The signal meter on the TRDDS-R may be used to verify that the loop loss is actually within TRDDS deployment guidelines without the requirement of peripheral test equipment. The signal meter is activated automatically upon power up during the TRDDS training sequence and remains activated until synchronization occurs (usually 30-90 seconds after power-up). For example, if the signal meter only illuminates the 2.4 LED, then the loop loss is too great for TRDDS deployment. If the signal meter illuminates 2.4 and 4.8 (only two LEDs), then the TRDDS loop loss is between 50 and 56 dB and the loop is considered marginal for TRDDS deployment. If three or more rate LEDs are illuminated during TRDDS train-up, then the circuit is considered to be within TRDDS deployment guidelines. See Figure 5 for a translation of the signal meter loss ranges in dB. If the loop loss indicates a marginal loop for TRDDS deployment, then a more precise loop loss measurement can be made with the appropriate test equipment.

Table 3. Faceplate Indicators

Indicator	Status	Explanation
SYNC	ON	Unit is powered up
	Green	Synchronized with TROCU DP
	Red	Not synchronized with TROCU DP; check for continuity, load coils, and other abnormal line conditions
NEAR CRC	ON	Errors occurred on the incoming data stream during the previous second; check for abnormal line conditions closer to the TRDDS-R
FAR CRC	ON	Errors occurred toward the Total Reach dataport during the previous second; check for abnormal line conditions closer to the CO
LBK	ON	Loopback is activated towards network
	Flashing	Bidirectional loopback at Total Reach dataport, Data Pass-Thru
SC	ON	Secondary Channel enabled
64	ON	64 kbps data rate enabled
56	ON	56 kbps data rate enabled
19.2	ON	19.2 kbps data rate enabled
9.6	ON	9.6 kbps data rate enabled
4.8	ON	4.8 kbps data rate enabled
2.4	ON	2.4 kbps data rate enabled

LED	SIGNAL LOSS (dB)
SC ○	0-10
64 ○	10-20
56 ○	20-30
19.2 ○	30-40
9.6 ○	40-50
4.8 ○	50-56
2.4 ○	>56
Signal level indicated during synchronization	



Figure 5. Signal Loss Indication

Table 4. TRDDS-R and Total Reach Dataport Loopback Interoperability Matrix

Total Reach DDS Dataports	TRDDS-R Loopback Response
1291006L1, L2, L3, L4, 1410105L2, 1425105L2, 1430105L2, 1433105L1, 1433105L3, 1433105L4	NIE
1291006L5 (US West) 1433105L2 (US West)	OCU and NIE

4. TESTING

Loopback Testing

Loopback tests can be performed from the CO to verify proper loop and TRDDS-R operation. The TRDDS-R features auto-detection capability to determine the model of Total Reach dataport installed in the central office. This feature allows the TRDDS-R to support multiple loopback applications. See Table 4 for an interoperability matrix of loopback responses supported by the TRDDS-R. The TRDDS-R always provides an NIE latching loopback at all rates. See Table 5 and 6 for latching and alternating loopback sequences. The TRDDS-R supports testing of the two-wire loop from the remote end when the CO unit is performing a bidirectional loopback.

Table 5. Latching Loopback Sequences

Function	Byte Code	Number of Received Bytes
Clear existing loopbacks	Transition in progress (TIP) *0111010	Minimum of 35 TIP bytes
Identify device to be looped	Loopback select code (LSC) *1010101 - OCU *0110001 - CSU *1000001 - NIE	Minimum of 35 LSC bytes
Prepare to loop; send MAP code after 30 bytes	Loopback enabled (LBE) *1010110	Minimum of 100 LBE bytes
Activate loopback	Far-End voice (FEV) *1011010	Minimum of 32 FEV bytes
Minimum of 35 TIP bytes required to disable established latching loopback.		
*Don't Care bit		

Table 6. Alternating Loopback Sequences

Function	Received Bytes
Active loopback	Four consecutive bytes of specified loopback code *0101010 - OCU *0101000 - CSU *0101100 - DSU
Maintain loopback and test for bit errors	Data byte alternating with loopback code example: *DDDDDD1/*0101010
Clear loopback	Four consecutive data bytes without a specified loopback code
*Don't care bit	

Initiating OCU Latching Loopback to Loop the TRDDS-R (US West Only)

- SW1-6 on the TRDDS-DP must be ON to enable latching loopback response.
- From a test system or set, send an OCU latching loopback sequence.
- Send a selected test pattern and test for error-free operation.
- Upon completion of this test, advance to *Terminating OCU, CSU or NIE Latching Loopback* for latching loopback termination.

Initiating CSU Latching Loopback to Loop a DSU/CSU (US West Only)

- SW1-6 on the TRDDS-DP must be ON to enable latching loopback response.
- From a test system or set, send a CSU latching loopback sequence. This instructs the TRDDS-DP to notify the TRDDS-R of a CSU loopback request. The TRDDS-R will reverse sealing current to the DSU/CSU. The DSU/CSU should loop when reversed sealing current is detected.
- Send a selected test pattern and test for error-free operation.
- Upon completion of this test, advance to *Terminating OCU, CSU or NIE Latching Loopback* for latching loopback termination.

Network Interface Equipment Latching Loopback

The NIE latching loopback method can be used to loop the TRDDS-R at all rates. This loopback test may require programming of the loopback select code or the complete sequence into the test system.

Terminating OCU, CSU or NIE Latching Loopback

- From a test system or set, send a Latching Loopback Disable command (35 TIP bytes).

Total Reach Dataport Bidirectional Loopback Support

The Total Reach dataport will execute a bidirectional loopback when performing a loopback at the dataport. The Total Reach dataport responds to either the OCU or DS0 loopback command, whichever loopback is applicable to the dataport version. Refer to Table 7 for Total Reach dataport loopback support.

Table 7. Total Reach Dataport Loopbacks

Total Reach DDS Dataports	Total Reach DDS Dataport Loopbacks
1291006L1, L2, L3, L4, 1410105L2, 1425105L2, 1430105L2, 1433105L1 1433105L3, 1433105L4	OCU
1291006L5 (US West) 1433105L2 (US West)	DS0

If the TRDDS-R detects a bidirectional loopback during power-up synchronization, the TRDDS-R allows data to pass on the four-wire interface by entering pass-thru mode. This permits a standard, portable DDS test set, connected to the four-wire customer interface of the TRDDS-R, to verify the integrity of the two-wire loop by transmitting a test pattern and examining the returning data for synchronization and errors. The TRDDS-R LBK indicator always flashes during a Total Reach dataport bidirectional loopback in the pass-thru mode. Refer to Figure 6 for an illustration of the bidirectional loopback pass-thru mode.

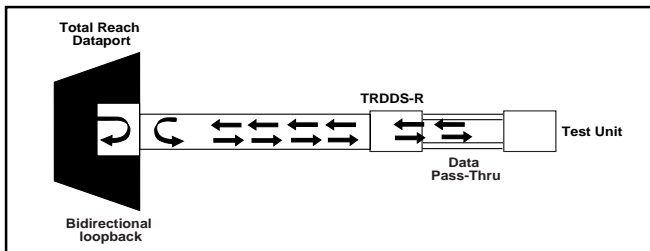

Figure 6. Total Reach Dataport Bidirectional Loopback Pass-Thru Mode

If a Total Reach dataport bidirectional loopback is invoked after the TRDDS-R achieves synchronization, the TRDDS-R will not pass or receive data from the CPE or DDS test set. This is consistent with current DDS testing methods and is referred to as the Total Reach dataport bidirectional loopback normal mode. For testing purposes, the installer may choose to initiate the TRDDS-R to pass-thru mode. Once the bidirectional loopback is executed in normal mode, unseat and reseat the TRDDS-R and allow the unit to train-up. Once trained, the TRDDS-R will revert to pass-thru mode for further testing. Refer to Figure 7 for TRDDS operation during bidirectional loopback in normal mode.

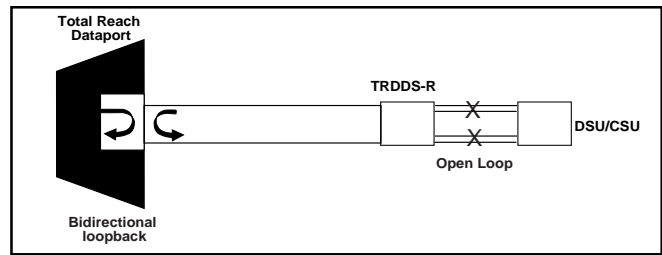

Figure 7. Total Reach Dataport Bidirectional Loopback Normal Mode

5. DEPLOYMENT GUIDELINES

The TROCU DP and TRDDS-R use technology intended to eliminate the need for repeaters and concerns over impairments caused by typical noise and bridged tap. Listed below are the loop design guidelines for TRDDS (see Tables 8 and 9 for more information):

- All loops must be nonloaded.
- Actual Measured Loss (AML) should not exceed 50 dB at 13.3 kHz (135 Ω termination), the Nyquist frequency of TRDDS.

NOTE

The 50 dB AML limit includes 6 dB of signal margin to account for potential near-end cross talk (NEXT) from other digital services that may be provisioned in the same binder group.

- Loop length should not exceed 50 kft.
- Bridged tap length should not exceed 12 kft.
- Background noise level should not exceed 34 dBm.
- Impulse noise should not exceed -40 dBm, (+50 dBm).

NOTE

Measure noise with 50 kbit weighting characteristic approximating a filter with a passband of 40 Hz to 30 kHz. Background noise level or impulse noise level is referenced from 56/ 64 kbps data rate in TR62310.

Table 8. Cable Type and Temperature Loss Data @ 13.3 kHz

PLASTIC CABLE	dB LOSS/kft	PAPER CABLE	dB LOSS/kft
19 Gauge PIC (0F)	0.5302	19 Gauge PULP (0F)	0.5616
19 Gauge PIC (70F)	0.6083	19 Gauge PULP (70F)	0.6415
19 Gauge PIC (120F)	0.6610	19 Gauge PULP (120F)	0.6955
22 Gauge PIC (0F)	0.912	22 Gauge PULP (0F)	0.9454
22 Gauge PIC (70F)	1.0258	22 Gauge PULP (70F)	1.0606
22 Gauge PIC (120F)	1.1015	22 Gauge PULP (120F)	1.1370
24 Gauge PIC (0F)	1.2571	24 Gauge PULP (0F)	1.2900
24 Gauge PIC (70F)	1.3982	24 Gauge PULP (70F)	1.4324
24 Gauge PIC (120F)	1.4917	24 Gauge PULP (120F)	1.5268
26 Gauge PIC (0F)	1.6823	26 Gauge PULP (0F)	1.6751
26 Gauge PIC (70F)	1.8568	26 Gauge PULP (70F)	1.8469
26 Gauge PIC (120F)	1.9718	26 Gauge PULP (120F)	1.9608

Table 9. TRDDS Insertion Loss Measurements

TRDDS 13.3 kHz compared to 28 kHz for traditional DDS service		
Line Configuration	@ 13.3 kHz	@ 28 kHz
27 kft 26 AWG	50.12 dB	65.35 dB
36.25 kft 24 AWG	50.00 dB	62.50 dB
50 kft 22 AWG	50.24 dB	59.33 dB

6. WARRANTY AND CUSTOMER SERVICE

ADTRAN will replace or repair this product within 10 years from the date of shipment if it does not meet its published specifications or fails while in service (see *ADTRAN Carrier Network Equipment Warranty, Repair, and Return Policy and Procedure*, document 60000087-10A).

Contact Customer and Product Service (CAPS) prior to returning equipment to ADTRAN.

For service, CAPS requests, or further information, contact one of the following numbers:

ADTRAN Technical Support

(800) 726-8663

Standard hours: Monday-Friday, 7 a.m.-7 p.m. CST

Emergency hours: 7 days/week, 24 hours/day

ADTRAN Sales

(800) 827-0807

ADTRAN Repair/CAPS

(256) 963-8722

Repair and Return Address

ADTRAN, Inc.

Customer & Product Service (CAPS) Department

901 Explorer Boulevard

Huntsville, Alabama 35806-2807

Free Manuals Download Website

<http://myh66.com>

<http://usermanuals.us>

<http://www.somanuals.com>

<http://www.4manuals.cc>

<http://www.manual-lib.com>

<http://www.404manual.com>

<http://www.luxmanual.com>

<http://aubethermostatmanual.com>

Golf course search by state

<http://golfingnear.com>

Email search by domain

<http://emailbydomain.com>

Auto manuals search

<http://auto.somanuals.com>

TV manuals search

<http://tv.somanuals.com>