

LAVATHERM 56740

User manual

Condenser Dryer

Thank you for choosing one of our high-quality products.

To ensure optimal and regular performance of your appliance please read this instruction manual carefully. It will enable you to navigate all processes perfectly and most efficiently. To refer to this manual any time you need to, we recommend you to keep it in a safe place. And please pass it to any future owner of the appliance.

We wish you much joy with your new appliance.

Contents

<u>Operating Instructions</u>	3	Cleaning fluff filter	16
<u>Important safety information</u>	3	Cleaning the door seal	17
<u>Product description</u>	6	Emptying the condensate tank	17
<u>Control panel</u>	7	Cleaning heat exchanger	18
<u>Before first use</u>	7	Cleaning the drum	19
<u>Sorting and preparing laundry</u>	7	Clean operating screen and housing	19
<u>Programme overview</u>	9	<u>What to do if ...</u>	20
<u>Daily use</u>	11	Troubleshooting by yourself	20
Switching machine on / switching light on	11	<u>Machine settings</u>	22
Opening loading door / loading laundry	11	<u>Technical data</u>	23
Selecting the programme	11	<u>Consumption values</u>	23
DELICATE function	11	<u>Hints for test institutes</u>	23
LONG ANTI-CREASE function	12	<u>Installation</u>	24
BUZZER function	12	Appliance positioning	24
TIME function	12	Removing transport safety packaging	24
DELAY START function	13	Electrical connection	25
CHILD LOCK function	13	Door reversal	26
Starting the programme	14	Special accessories	26
Changing programme	14	<u>Environment</u>	26
Putting in extra items or taking items out before end of programme	14	Environmental tips	27
Drying cycle complete / removing laundry	14	<u>Service</u>	27
<u>Care and cleaning</u>	16	<u>Guarantee/Customer Service</u>	28
		GREAT BRITAIN & IRELAND	28
		European Guarantee	29
		<u>www.electrolux.com</u>	30

Subject to change without notice

Operating Instructions

Important safety information



In the interest of your safety and to ensure the correct use, before installing and first using the appliance, read this user manual carefully, including its hints and warnings. To avoid unnecessary mistakes and accidents, it is important to ensure that all people using the appliance are thoroughly familiar with its operation and safety features. Save these instructions and make sure that they remain with the appliance if it is moved or sold, so that everyone using it through its life will be properly informed on appliance use and safety.

General safety

- It is dangerous to alter the specifications or attempt to modify this product in any way.
- This appliance is not intended for use by persons (including children) with reduced physical, sensory or lack of experience and knowledge, unless they have been given supervision or instruction concerning use of the appliance by a person responsible for their safety.
- Make sure that small pets do not climb into the drum. To avoid this, please check into the drum before using.
- Any objects such as coins, safety pins, nails, screws, stones or any other hard, sharp material can cause extensive damage and must not be placed into the machine.
- In order to avoid danger of fires caused by excessive drying, do not use appliance to dry the following items: Cushions, quilts and the like (these items accumulate heat).
- Items such as foam rubber (latex foam), shower caps, waterproof textiles, rubber backed articles and clothes or pillows fitted with foam rubber pads should not be dried in the tumble dryer.
- Always unplug the appliance after use, cleaning and maintenance.
- Under no circumstances should you attempt to repair the machine yourself. Repairs carried out by inexperienced persons may cause injury or serious malfunctioning. Contact your local Service Centre. Always insist on genuine spare parts.
- Items that have been soiled with substances such as cooking oil acetone, petrol, kerosene, spot removers, turpentine, waxes and wax removers should be washed in hot water with an extra amount of detergent before being dried in the tumble dryer.
- **Danger of explosion:** Never tumble dry items that have been in contact with inflammable solvents (petrol, methylated spirits, dry cleaning fluid and the like). As these substance are volatile, they could cause an explosion. Only tumble dry items washed with water.
- **Risk of fire:** items that have been spotted or soaked with vegetable or cooking oil constitute a fire hazard and should not be placed in the tumble dryer.
- If you have washed your laundry with stain remover you must execute an extra rinse cycle before loading your tumble dryer.

- Please make sure that no gas lighters or matches have accidentally been left in pockets of garments to be loaded into appliance

**WARNING!**

Never stop a tumble dry before the end of the drying cycle unless all items are quickly removed and spread out so that the heat is dissipated. Risk of fire!

- **Risk of electric shock!** Do not spray down the appliance with jets of water.
- The final part of a tumble dryer cycle occurs without heat (cool down cycle) to ensure that the items are left at a temperature that ensures that items will not be damaged.
- The tumble dryer is not to be used if industrial chemicals have been used for cleaning.
- Ensure you have good ventilation in the installation room to avoid the back flow of gases into the room from appliances burning other fuels, including open fires.

Installation

- This appliance is heavy. Care should be taken when moving it.
- When unpacking the appliance, check that it is not damaged. If in doubt, do not use it and contact the Service Centre.
- All packaging must be removed before use. Serious damage can occur to the product and to property if this is not adhered to. See relevant section in the user manual.
- Any electrical work required to install this appliance should be carried out by a qualified electrician or competent person.
- Care must be taken to ensure that the appliance does not stand on the electrical supply cable.
- If the machine is situated on a carpeted floor, please adjust the feet in order to allow air to circulate freely under the appliance.
- After having installed the appliance, check that it is not pressing or standing on its electrical supply cable.
- If the tumble dryer is placed on top of a washing machine, it is compulsory to use the stacking kit (optional accessory).

Use

- This appliance is designed for domestic use. It must not be used for purposes other than those for which it was designed.
- Only wash fabrics which are designed to be machine dried. Follow the instructions on each garment label.
- Do not dry unwashed items in the tumble dryer.
- Do not overload the appliance. See the relevant section in the user manual.
- Clothes which are dripping wet should not be placed in the dryer.
- Garments which have been in contact with volatile petroleum products should not be machine dried. If volatile cleaning fluids are used, care should be taken to ensure that the fluid is removed from the garment before placing in the machine.
- Never pull the power supply cable to remove the plug from the socket; always take hold of the plug itself.
- Never use the tumble dryer if the power supply cable, the control panel, the working surface or the base are damaged so that the inside of the tumble dryer is accessible.
- Fabric softeners, or similar products should be used as specified by the fabric softener instructions.

- **Caution – hot surface** : Do not touch the door light cover surface when the light is switched on.
(Only dryers equipped with internal drum light)

Child safety

- This machine is not intended for use by young children or infirm persons without supervision.
- Children should be supervised to ensure that they do not play with the appliance.
- The packaging components (e.g. plastic film, polystyrene) can be dangerous to children – danger of suffocation! Keep them out of children's reach.
- Keep all detergents in a safe place out of children's reach.
- Make sure that children or pets do not climb into the drum.

Product description

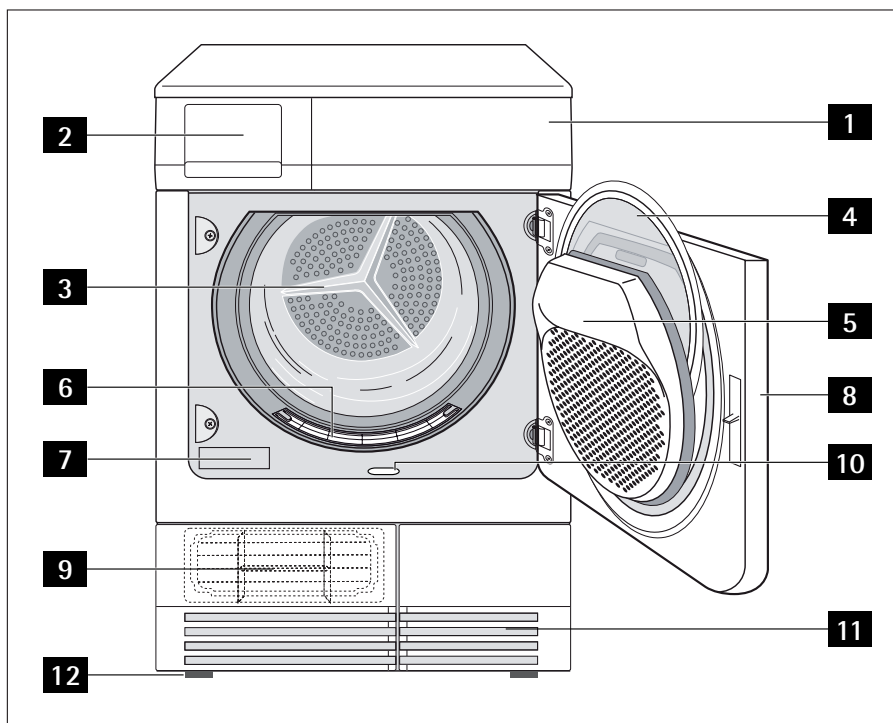

- 1** Control panel
- 2** Water reservoir
- 3** Drum light
- 4** Fine fluff filters
- 5** Course fluff filters
- 6** Fluff filters
- 7** Rating plate
- 8** Loading door (reversible)
- 9** Heat exchanger door
- 10** Button for opening door in plinth
- 11** Ventilation grille
- 12** Adjustable feet

Control panel

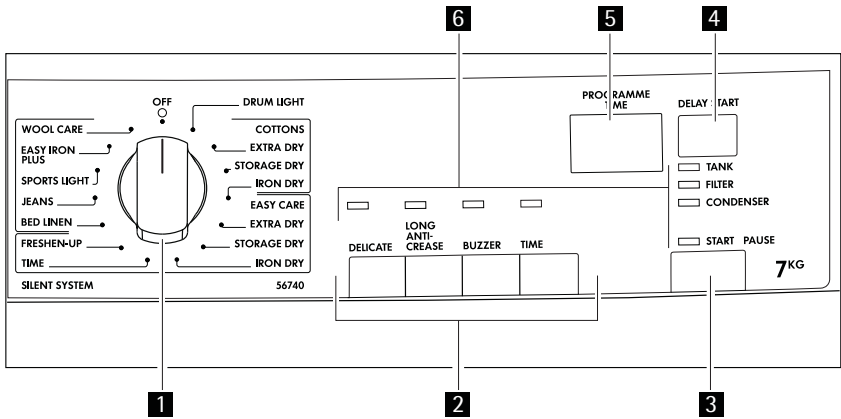

- 1 Programme knob and OFF switch
- 2 Function buttons
- 3 START PAUSE button
- 4 DELAY START button
- 5 Display
- 6 Functions and warning leds

Before first use

In order to remove any residues which may have been produced during production, wipe the dryer drum with a damp cloth or carry out a brief drying cycle (ca. 30 min.) with damp cloths in the machine.

Sorting and preparing laundry

Sorting laundry

- Sort by fabric type:
 - Cotton/linen for programmes in COTTONS programme group.
 - Mixtures and synthetics for programmes in EASY CARE programme group.
- Sorting by care label. The care labels mean:



Drying in the tumble dryer possible in principle

Dry at normal temperature

Dry at reduced temperature (press DELI-CATE button!)

Drying in the tumble dryer **not** possible



Do not place in the appliance any wet laundry which is not specified on the care label as being suitable for tumble-drying.

This appliance can be used for all wet laundry items which are labelled as suitable for tumble-drying.

- Do not dry new, coloured textiles together with light-coloured laundry items. Textile colours may bleed.
- Do not dry cotton jersey and knitwear with the EXTRA programme. Items may shrink!
- Do not dry wool in the dryer. May become entangled! After air-drying, wool may be dried with the WOOL CARE programme.

Preparing laundry

- To avoid laundry becoming tangled: close zips, button up duvet covers and tie loose ties or ribbons (e.g. of aprons).
- Empty pockets. Remove metal items (paper clips, safety pins, etc).
- Turn items with double-layered fabrics inside out (e.g. with cotton-lined anoraks, the cotton layer should be outermost). These fabrics will then dry better.

Programme overview

Programmes	max. load (weight when dry)	Additional functions					Application/properties	Care mark
		DELICATE	LONG ANTI-CREASE	BUZZER	TIME	DELAY START		
COTTONS EXTRA DRY	7 kg	•	•	•	-	•	Thorough drying of thick or multi-layered fabrics, e.g. terry towelling items, bathrobes.	
COTTONS STORAGE DRY	7 kg	•	•	•	-	•	Thorough drying of fabrics of even thicknesses, e.g. terry towelling items, knitwear, towels.	
COTTONS IRON DRY	7 kg	•	•	•	-	•	For normal thickness cotton or linen laundry, e.g. bedding, table linen.	
EASY CARE EXTRA DRY	3 kg	•	•	•	-	•	Thorough drying of thick or multi-layered fabrics, e.g. pullovers, bedding, table linen.	
EASY CARE STORAGE DRY	3 kg	•	•	•	-	•	For thin fabrics which are not ironed, e.g. easy care shirts, table linen, baby clothes, socks, lingerie with bones or wires.	
EASY CARE IRON DRY	3 kg	•	•	•	-	•	For thin fabrics which are also to be ironed, e.g. knitwear, shirts.	
TIME	7 kg	•	•	•	•	•	For further drying of individual items of laundry or for volumes up to 7 kg.	
FRESHEN-UP	1 kg	•	•	•	-	•	For refreshing or gently cleaning textiles with commercially available dry cleaning products.	
BED LINEN	3 kg	•	•	•	-	•	Bed linen (single and double sheet, pillowcase, bedspread, duvet cover).	
JEANS	7 kg	•	•	•	-	•	For leisure clothing, such as jeans, sweat-shirts, etc., of different material thicknesses (e.g. at the neck, cuffs and seams).	

Programmes	max. load (weight when dry)	Additional functions					Application/properties	Care mark
		DELICATE	LONG ANTI-CREASE	BUZZER	TIME	DELAY START		
SPORTS LIGHT	2 kg	• 2)	•	•	-	•	For sportswear, thin fabrics, polyester, which are not ironed.	
EASY IRON PLUS	1 kg (or 5 shirts)	• 2)	•	•	-	•	Special program with anti-crease mechanism for easy care fabrics such shirts and blouses; for minimum ironing effort. The results depends on the type of fabric and its finish. Place fabrics in the dryer straight after spinning; once dried, immediately remove fabrics and place on a clothes hanger.	
WOOL CARE	1 kg	•	-	•	-	•	Special programme for briefly treating woollens with warm air, after they have been dried naturally, worn or stored for long periods. Wool fibres stand up and the wool becomes soft and cosy. Recommendation: Remove fabrics immediately after drying.	

1) select DELICATE

2) set by default

Daily use

Switching machine on / switching light on

Turn the programme selector to any programme or turn it to DRUM LIGHT. The machine has been switched on. When the loading door is opened, the drum is illuminated.

Opening loading door / loading laundry

1. Open loading door:
Use force to push against the loading door (push point)
2. Load your laundry (do not force it in).



CAUTION!

- Do not jam laundry in between the loading door and rubber seal.
3. Close loading door securely. Lock must audibly lock.

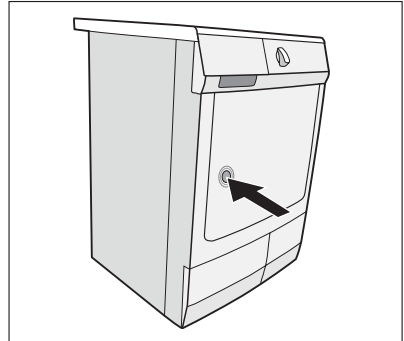

Selecting the programme

Use the programme selector to set the programme you require. The estimated time to end of the programme appears in the LCD in h:mm format (hours:minutes).

During the cycle time elapses by steps of one minute; less than 1 hour the leading zeros are not shown (ex. "59", "5", "0").

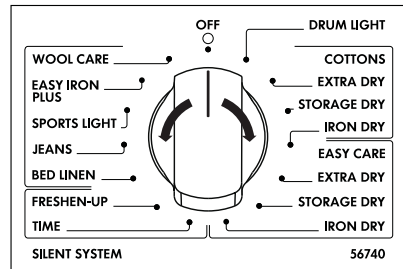

DELICATE function

For especially gentle drying of sensitive fabrics with the  care label and for temperature-sensitive textiles (e.g. acrylic, viscose). Programme is executed with reduced heat. Delicate function is only suitable for use with loads of up to 3kg.

To activate it:

1. Choose the drying programme.
 2. Press DELICATE button - the led above is on.
- To deselect function press again DELICATE button. Led above is off.

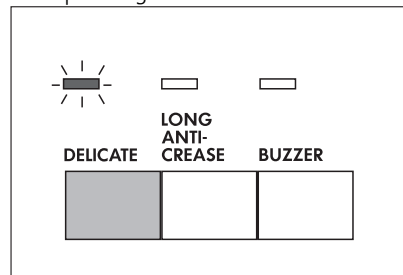

LONG ANTI-CREASE function

A long anti-crease phase lengthen the anti-crease phase (30 min.) at the end of the drying additionally by 60 minutes. The drum rotates at intervals during this phase. This keeps the laundry loose and free of creases. Phase lasts in total 90 minutes. The laundry can be removed at any time during the anti-crease phase.

To activate it:

1. Choose the drying programme.
2. Press LONG ANTI-CREASE button - the led above is on.

To deselect function press again LONG ANTI-CREASE button. Led above is off.

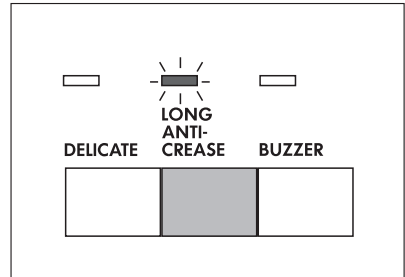

BUZZER function

The appliance is supplied with the BUZZER function deactivated.

The buzzer sounds or plays a tune when activated during:

- cycle end
- anti-crease phase and when phase starts or ends
- cycle interruption by a warning
- alarm

To activate it:

1. Choose the drying programme.
2. Press BUZZER button - the led above is on.

To deselect function press again BUZZER button. Led above is off.

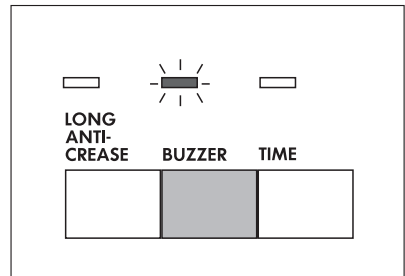

TIME function

To select the programme duration after setting the TIME programme. You can select a programme duration from 10 mins to 3 hrs in 10-minute steps.

1. Turn the programme knob to the TIME programme. The blinking 10' appears in the display. (corresponding to the COOLING programme).

2. Press the TIME button repeatedly until the desired programme duration is shown in the display, e.g. 20 for a programme of 20 minutes.

If the programme duration is not selected, the duration is automatically set to 10 mins.

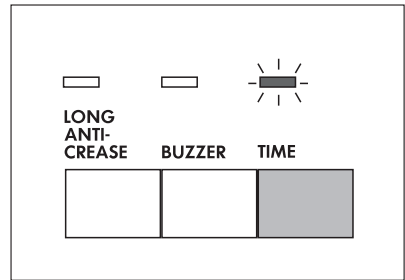

DELAY START function

i With the DELAY START button, you can delay the start of a programme by between 30 minutes (30') and a maximum of 20 hours (20h).

1. Select the programme and additional functions if necessary.
2. Press the DELAY START button as many times as necessary until the required start delay appears on the display, e.g. 12h if the programme is to be started in 12 hours.

i If the display is showing 20h and you press the button again, the time delay will be cancelled. The display will show 0' and then the duration of the selected programme.

3. To activate the delay timer, press the START PAUSE button. The amount of time remaining until the programme is set to start is continuously displayed (e.g. 15h, 14h, 13h, ... 30' etc).

The delay time icon (🕒) is on.

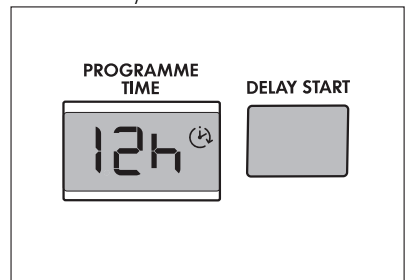

CHILD LOCK function

The child lock can be set to prevent a programme being accidentally started or a programme in operation being accidentally changed. The child lock function locks all buttons and the programme knob. The child lock can be activated or deactivated by holding down the BUZZER and TIME buttons simultaneously for 5 seconds.

- i**
- Before programme is started: Appliance cannot be used
 - After programme is started: Programme in operation cannot be changed

The  icon appears in the display to indicate that the child safety device is activated. The child safety device is not deactivated once the programme comes to an end. If you want to set a new programme, you must first deactivate the child safety device.

Starting the programme

Press the START PAUSE button. Led above stops flashing, becomes steady. The programme is started. Display shows elapsing cycle time or delay time if activated.

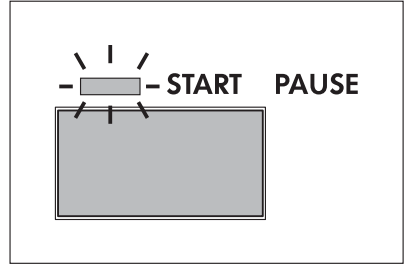

Changing programme

To change a programme which has been selected by mistake once the programme has started, first turn the programme selector to OFF and then reset the programme.

- i** The programme can no longer be changed directly once the programme has started. If nevertheless there is an attempt to change the programme on the programme knob, the programme progress display and the maintenance indicators flash. If an option button (excluding the BUZZER button) is pressed, **Err** appears in the multidisplay. The drying programme is not however affected by this (laundry protection).

Putting in extra items or taking items out before end of programme

1. Open loading door.



WARNING!

Laundry and drum can become hot. **Risk of burns!**

2. Load or remove laundry items.
3. Close loading securely. Lock must audibly lock.
4. Press the START PAUSE button to continue the drying cycle.

Drying cycle complete / removing laundry

Once the drying cycle is complete, display shows a blinking "0". If the BUZZER button has been pressed, an acoustic signal sounds intermittently for about one minute.

- i** The drying cycles are automatically followed by an anti-crease phase which lasts around 30 minutes. The drum rotates at intervals during this phase. This keeps the laundry loose and free of creases. The laundry can be removed at any time during the anti-crease phase. (The laundry should be taken out towards the end of the anti-crease phase at the latest to prevent creases from forming.) If LONG ANTI-CREASE function has been selected, the anti-crease phase is lengthened by 60 minutes.

1. Open door.
2. Before removing the laundry, remove fluff from the micro-fine filter. It is best to use a damp hand for this purpose. (See "Care and cleaning" chapter.)
3. Remove laundry.
4. Turn the programme selector to **OFF**.



After each drying cycle:

-
- Clean the micro-fine filter and fine filter
 - Drain the condensed water container
- (See chapter "Care and cleaning".)
5. Close the door.

Care and cleaning

Cleaning fluff filter

The filters collect all the fluff which accumulates during drying. To ensure that the dryer works perfectly, the fluff filters (micro-fine filter and fine strainer) must be cleaned after every drying cycle.

The warning led is on to remind you this operation.



CAUTION!

Never operate the dryer without fluff filters or with damaged or blocked fluff filters.

1. Open loading door
2. Use a damp hand to clean the micro-fine filter, which is built into the lower part of the loading aperture.

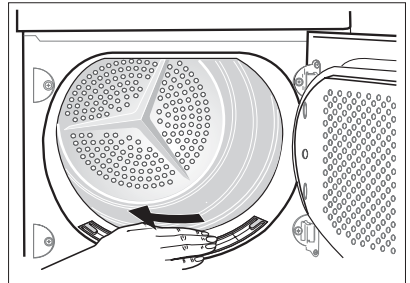

3. After a period of time, a patina due to detergent residue on laundry forms on the filters. When this occurs, clean the filters with warm water using a brush. Remove the filter from the door pulling it out. It can be positioned with the tooth facing to the left or to the right).

After cleaning do not forget to put it back.

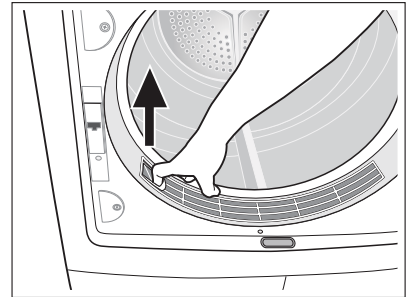

4. Push down unlock button on large mesh filter.

Large mesh filter jumps up.

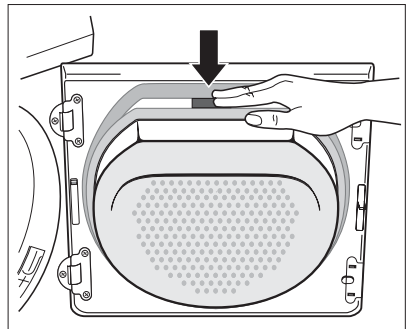

5. Take out fine strainer.
6. Remove fluff from fine strainer. It is best to use a damp hand for this purpose.

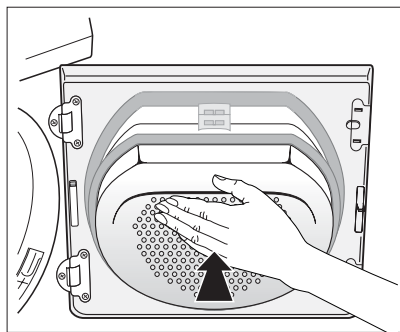
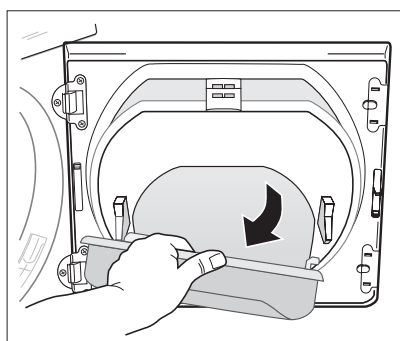
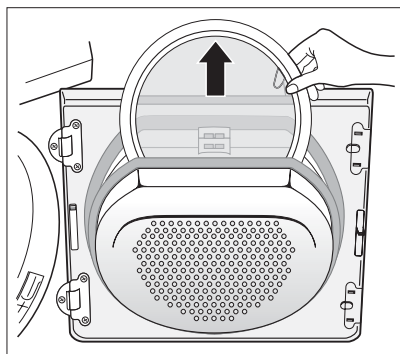

i **Clean the entire filter area**

The strainer area does not have to be cleaned after every drying cycle, but should be checked regularly and cleaned of fluff if necessary.

7. To do this, grip the top of the large mesh filter and pull it forwards until it comes loose from the two brackets.
8. Remove fluff from the entire filter area. It is best to use a vacuum cleaner for this purpose.
9. Press both journals of the large mesh filter into the brackets on the loading door until they snap into place.
10. Re-insert fine strainer.
11. Press against the large mesh filter until it locks into the interlock.

i If the fine strainer is not fitted, the large mesh filter will not snap into place and the loading door cannot be closed.

Cleaning the door seal

Wipe the door seal with a damp cloth immediately after the drying cycle has finished.

Emptying the condensate tank

Empty condensate tank after every drying cycle.

If the condensate tank is full, an active programme will break off automatically and the warning led light up. In order to continue the programme, the condensate tank must first be emptied.

**WARNING!**

The condensate is not suitable for drinking or for preparing foodstuffs.

1. Take out drawer containing condensed water container completely **1** and pull up the condensed water container's drainage pipe as far as it will go **2**.

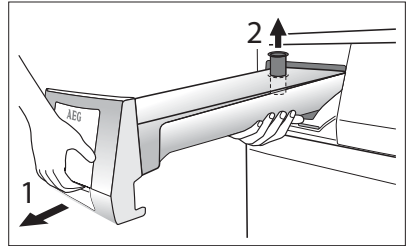

2. Pour condensed water out into a basin or similar receptacle.
3. Slide outlet connections in and refit condensate tank.

If the programme has been interrupted as a result of the condensate tank being full: Press the **START PAUSE** button to continue the drying cycle.

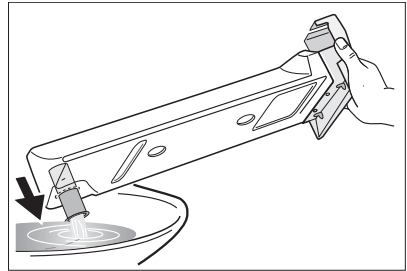

The condensate tank has a volume of approx. **4 litres**. This is sufficient for around 7kg of laundry which has previously been spun at **1000 revolutions/ minute**.



The condensate can be used as distilled water, e.g. for steam ironing. However first filter the condensate (e.g. with a coffee filter) to remove any residue and small pieces of fluff.

Cleaning heat exchanger

If the warning led is lighting, the heat exchanger needs to be cleaned.

**CAUTION!**

Operating when the heat exchanger is blocked with fluff can damage the dryer. This also increases energy consumption.

1. Open door.
2. Open door in plinth. To do this, press the release button on the bottom of the door aperture and open the door in the plinth to the left.
3. Clean fluff from the inside of the door and the heat exchanger front chamber. Wipe the door seal with a damp cloth.

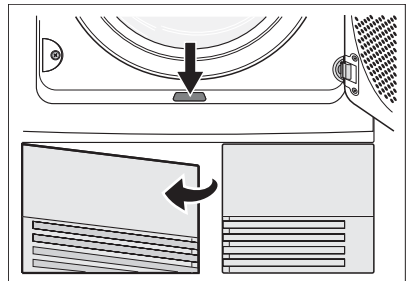

- Turn both lock washers inwards.

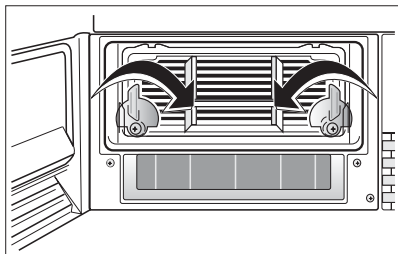

- Use the handle to pull the heat exchanger out of the base and carry it horizontally to prevent any remaining water from spilling.
- To empty the heat exchanger, hold vertically over a washing-up bowl.

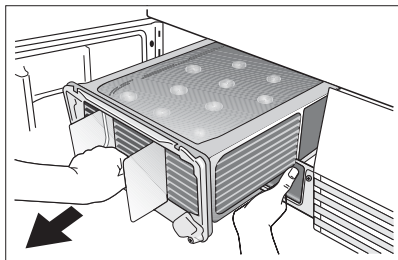

CAUTION!

Do not use sharp objects to clean. The heat exchanger could develop leaks.

- Clean heat exchanger.

It is best to use a brush or to rinse thoroughly with a hand-held shower.

- Replace heat exchanger and lock into place (turn both lock washers outwards until they snap into place).
- Close door in plinth.



CAUTION!

Never operate the dryer without the heat exchanger.

Cleaning the drum



CAUTION!

Do not use abrasives or steel wool to clean the drum.



Lime in the water or cleaning agents may form a barely visible lining on the inside of the drum. The degree to which the laundry has been dried is then no longer detected reliably. The laundry is damper than expected when removed from the dryer.

Use a standard domestic cleaner (e.g. vinegar-based cleaner) to wipe down the inside of the drum and drum ribs.

Clean operating screen and housing



CAUTION!

Do not use furniture cleaners or aggressive cleaning agents to clean the machine. Use a damp cloth to wipe down the operating screen and housing.

What to do if ...

Troubleshooting by yourself

If, during operation, the error code *E...* (plus number or letter) appears on the LCD: Switch the machine off and on again. Reset programme. Press the START PAUSE button. If the error is still displayed, please inform your local Service Force Centre and quote the error code.

Problem	Possible cause	Remedy
Dryer does not work.	Mains plug is not plugged in or fuse is not working correctly.	Plug in at mains socket. Check fuse in fuse box (domestic installation).
	Loading door is open.	Close loading door.
	Have you pressed the START PAUSE button?	Press the START PAUSE button again.
Drying results unsatisfactory.	Wrong programme selected.	Select a different programme the next time you dry (see "Programme chart" chapter).
	Lint filters clogged.	Clean lint filters.
	Fluff filter clogged.	Clean fluff filter.
	Heat exchanger clogged with lint.	Clean heat exchanger.
	Overloading of laundry.	Observe recommended loading volumes.
	Ventilation slots in base area covered up.	Uncover ventilation slots in base area.
	Residue on inside surface of drum or drum ribs.	Clean inside surface of drum and drum ribs.
	Conductance of water at installation site differs from standard setting of machine.	Re-programme standard setting for degree of drying (see 'Programming options' chapter).
Loading door does not close.	Fine strainer not in place and/or mesh filter not locked in place.	Install fine strainer and/or snap large mesh filter into place.
When a button is pressed, <i>Err</i> appears on the LCD.	Washing protection. After the start of the programme, the option can no longer be set.	Turn the programme knob to OFF. Set the programme again.
Drum light does not work.	Programme selector in OFF position.	Turn programme selector to DRUM LIGHT or to any programme.
	Defective light bulb.	Replace light bulb (see next section).

Displayed programme time changes erratically or stays unchanged for a long time.	Programme time is corrected automatically depending on type and volume of laundry and level of dampness.	Automatic process; this is not a machine fault.
Programme inactive, empty water tank warning led is lighting.	Condensate tank is full.	Empty condensate tank, then start programme with START PAUSE button.
Drying cycle ends shortly after programme starts.	Not enough washing loaded or washing loaded is too dry for selected programme.	Select time programme or higher drying level (e.g. EXTRA DRY instead of STORAGE DRY).
Drying cycle lasts an unusually long time. Note: After around 5 hours the drying cycle ends automatically (see „Drying cycle complete“).	Lint filter clogged.	Clean lint filter.
	Fluff filter clogged.	Clean fluff filter.
	Load volume too big.	Reduce load volume.
	Laundry insufficiently spun.	Laundry must be adequately spun.
	Particularly high room temperature. Temporary switching off of the compressor to avoid overload.	Automatic process, there is no fault with the appliance. If possible, lower the room temperature.

Changing the bulb for interior lighting

Only use a special bulb which is designed specially for dryers. The special bulb can be obtained from your local service centre.



When the appliance is switched on, the interior lighting switches itself off after 4 minutes when the door is open.



WARNING!

Do not use standard bulbs! These develop too much heat and may damage the machine! Before replacing the bulb, disconnect the mains plug; with a permanent connection: fully unscrew or deactivate the fuse.

1. Unscrew cover above the bulb (this can be found directly behind the loading aperture, at the top; refer to "Description of machine" section.)
2. Replace defective bulb.
3. Screw cover back down.









Check the correct positioning of o-ring gasket before screwing back the door light cover. Do not operate the dryer when missing o-ring gasket on door light cover.



WARNING!

For safety reasons, the cover must be screwed down tightly. If this is not done, the dryer must not be operated.

Machine settings

Setting	Implementation
BUZZER permanent off	<ol style="list-style-type: none"> 1. Turn the programme selector to any programme. 2. Press simultaneously the DELICATE and LONG ANTI-CREASE buttons and hold down for approx. 5 seconds. 3. The buzzer is by default always off. You can use BUZZER button to activate or deactivate sound but machine does not memorize your selection.
<div data-bbox="71 483 116 523" style="float: left; margin-right: 10px;">  </div> <p>Water hardness</p> <p><i>Water contains, a variable quantity of limestone and mineral salts of which quantities vary according to geographical locations thus varying its conductivity values.</i></p> <p><i>Relevant variations of the conductivity of the water compared to those prefixed by the factory could slightly influence the residual humidity of the laundry at the end of the cycle. Your dryer allows you to regulate the sensitivity of the drying sensor based on conductivity values of the water.</i></p>	<ol style="list-style-type: none"> 1. Turn the programme selector to any programme. 2. Press simultaneously the DELICATE and TIME buttons and hold down for approx. 5 seconds. The current setting is on the display: <ul style="list-style-type: none"> -  0 - low conductivity <300 micro S/cm -  0 = medium conductivity 300-600 micro S/cm -  0 E high conductivity >600 micro S/cm 3. Press the START PAUSE button sequentially until you set desired level. 4. To memorize setting press simultaneously the DELICATE and TIME buttons or turn knob to OFF position
<div data-bbox="71 911 116 951" style="float: left; margin-right: 10px;">  </div> <p>Emptying water tank - warning message permanent off</p> <p><i>When using an external drain for the condensed water.</i></p> <div data-bbox="452 1038 497 1078" style="float: right; margin-top: 20px;">  </div>	<ol style="list-style-type: none"> 1. Turn the programme selector to any programme. 2. Press simultaneously the LONG ANTI-CREASE and TIME buttons and hold down for approx. 5 seconds. The current setting is on the display: <ul style="list-style-type: none"> -  - led warning is permanently off -  1 - led warning is activated <p>By default the warning led is activated and is lighting always at the end of the drying cycle or during the cycle if the water container is full.</p>

Technical data



This appliance conforms with the following EU Directives:

- 2006/95/EEC dated 12.12.2006 Low Voltage Directive
- 89/336/EEC dated 03.05.1989 EMC Directive inclusive of Amending Directive 92/31/EEC
- 93/68/EEC dated 22.07.1993 CE Marking Directive

Height x width x depth	85 x 60 x 58 cm
Depth with loading door open	109 cm
Height can be adjusted by	1.5 cm
Weight when empty	approx. 40 kg
Loading volume (depends on programme) ¹⁾	max. 7 kg
Energy consumption in accordance with EN 61121 s. e. (7kg of cotton, pre-drained at 1000 rpm, COTTONS STORAGE DRY programme)	4,4 kWh
Use	Domestic
Permissible ambient temperature	+ 5°C to + 35°C

1) Different loading volume data may be needed in some countries as a result of different measuring methods.

Consumption values

The consumption values have been established under standard conditions. They may deviate when the machine is operated in domestic circumstances.

Programme	Loading volume in kg	Energy consumption in kWh
COTTONS CUPBOARD DRY ¹⁾	7	4.4
COTTONS IRON DRY ¹⁾	7	3.41
SYNTHETICS CUPBOARD DRY ²⁾	3	1.36

1) pre-drained at 1000 rpm

2) pre-drained at 1200 rpm

Hints for test institutes

Parameters possible to check by the Test Institutes:

- Energy consumption (corrected with final humidity) during the cupboard dry cotton cycle with nominal load.
- Energy consumption (corrected with final humidity) during the cupboard dry cotton cycle with half load.
- Final humidity (during cupboard dry cotton, iron dry cotton and cupboard dry easy care)
- Condensation efficiency (corrected with final humidity) during cupboard dry cotton cycle with nominal and half load

All the cycles have to be checked in accordance with EN 61121 (Tumble dryers for household use – Methods for measuring the performance).

Installation

Appliance positioning

- It is recommended that, for your convenience, the machine is positioned close to your washing machine.
- The tumble dryer must be installed in a clean place, where dirt does not build up.
- Air must be able to circulate freely all round the appliance. Do not obstruct the front ventilation grille or the air intake grilles at the back of the machine.
- To keep vibration and noise to a minimum when the dryer is in use, it should be placed on a firm, level surface.
- Once in its permanent operating position, check that the dryer is absolutely level with the aid of a spirit level. If it is not, raise or lower the feet until it is.
- The feet must never be removed. Do not restrict the floor clearance through deeppile carpets, strips of wood or similar. This might cause heat built-up which would interfere with the operation of the appliance.



The hot air emitted by the tumble dryer can reach temperatures of up to 60°C. The appliance must therefore not be installed on floors which are not resistant to high temperatures. When operating the tumble dryer, the room temperature must not be lower than +5°C and higher than +35°C, as it may affect the performance of the appliance.



WARNING!

Should the appliance be moved, it must be transported vertically.



WARNING!

The appliance must not be installed behind the lockable door, a sliding door or a door with a hinge on the opposite side to that of the appliance.

Removing transport safety packaging



CAUTION!

Before use all parts of the transport packaging must be removed.

1. Open loading door
2. Pull off adhesive strips from inside machine on top of drum.

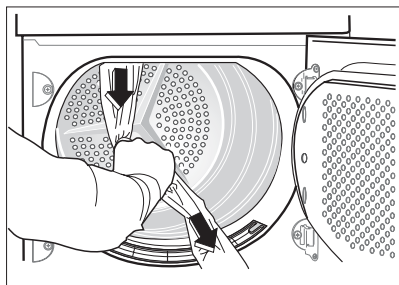

- Remove foil hose and polystyrene padding from the machine.

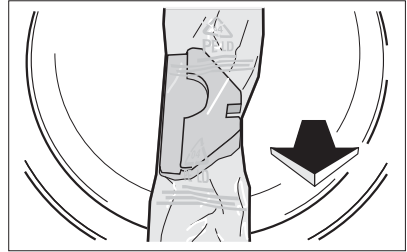

Electrical connection

Details on mains voltage, type of current and the fuses required should be taken from the rating plate. The rating plate is fitted near the loading aperture (see "Product description" chapter).

Connect the machine to an earthed socket, in accordance with current wiring regulations.



WARNING!

The manufacturer declines any responsibility for damage or injury through failure to comply with the above safety precautions.

Should the appliance power supply cable need to be replaced, this must be carried out by our Service Centre.

The appliance is supplied with a 13 amp plug fitted. In the event of having to change the fuse in the plug supplied, a 13 amp ASTA approved BS 1363/A fuse must be used.

The wires in the mains lead are coloured in accordance with the following code:

- Blue - Neutral
- cord clamp
- Brown - Live
- Green and Yellow - Earth

The wire coloured green and yellow must be connected to the terminal marked with the letter «E» or by the earth symbol \perp or coloured green and yellow.

The wire coloured blue must be connected to the terminal «N» or coloured black.

The wire coloured brown must be connected to the terminal marked «L» or coloured red.

Upon completion there must be no cut, or stray strands of wire present and the cord clamp must be secure over the outer sheath.

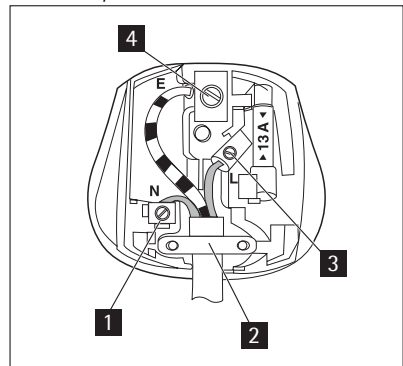

WARNING!

A cut off plug inserted into a 13 amp socket is a serious safety (shock) hazard. Ensure that the cut off plug is disposed of safely.



WARNING!

The power supply cable must be accessible after installing the machine.

Permanent connection

In the case of permanent connection it is necessary that you install a double pole switch between the appliance and the electricity supply (mains), with a minimum gap of 3 mm between the switch contacts and of a type suitable for the required load in compliance with the current electrical regulations.

The switch must not break the yellow and green earth cable at any point.

Door reversal

To make it easier to load or unload the laundry, the door can be reversed. This operation must only be carried out by a qualified engineer. Please contact your local service centre. The engineer will carry out the door reversal at your cost.

Special accessories

Intermediate installation kit for stacked washer and dryer:



Available from your Service Force Centre or your specialist dealer

These intermediate installation kits can be used to arrange the dryer and an automatic AEG-Electrolux washing machine (60 cm wide, front loading) as a space-saving washer/dryer stack. The automatic washing machine is at the bottom and the dryer is at the top.

Version to be supplied:

– with extractable stacker plate *916093151*

Read carefully the instructions supplied with the kit.

Installation kit for external condensate drain



Attached to your product

Installation kit *12512251*. for direct draining of condensate into a basin, siphon, gully, etc. The condensate tank then no longer has to be drained, it must however remain in its intended position in the machine. Refer to the "Machine settings" chapter for how to deactivate the *TANK* alert led.

Max. displacement height: 1 m from the base of the dryer; max. displacement length: 2.5 m

Read carefully the instructions supplied with the kit.

Environment

The symbol  on the product or on its packaging indicates that this product may not be treated as household waste. Instead it should be taken to the appropriate collection point for the recycling of electrical and electronic equipment. By ensuring this product is disposed of correctly, you will help prevent potential negative consequences for the environment and human health, which could otherwise be caused by inappropriate waste handling of this product. For more detailed information about recycling of this product, please contact your local council, your household waste disposal service or the shop where you purchased the product.

Packaging material

The packaging materials are environmentally friendly and can be recycled. The plastic components are identified by markings, e.g. >PE<, >PS<, etc. Please dispose of the packaging materials in the appropriate container at the community waste disposal facilities.



WARNING!

When disposing of old appliances, remove the mains cable and dispose of together with the plug. Remove the door hook and ensure it is no longer lockable to prevent young children being trapped inside.

Environmental tips

- In the dryer, laundry becomes fluffy and soft. Fabric softeners are not therefore needed when washing.
- Your dryer will function most economically if you:
 - always keep the ventilation slots on the base of the dryer unobstructed;
 - use the loading volumes specified in the programme overview;
 - ensure you have good ventilation in the installation room;
 - clean the micro-fine filter and fine strainer after each drying cycle;
 - spin the laundry well before drying. Example: Consumption data – depending on spinning speed – for 7 kg of laundry, dried using the COTTONS STORAGE DRY programme.

Revolutions per minute	Pre-draining		Drying cycle
	Residual dampness		Energy in kWh
	in litres	as a %	
1000	4.20	60	4.40
1200	3.92	56	4.20
1400	3.64	52	3.87
1800	3.15	45	3.40

Service

In the event of technical faults, please first check whether you can remedy the problem yourself with the help of the operating instructions (Chapter "What to do if...").

If you were not able to remedy the problem yourself, please contact your local service centre.

In order to be able to assist you quickly, we require the following information:

- Model description
- Product number (PNC)
- Serial number (S No.) (for numbers, see rating plate)
- Type of fault
- Any error messages displayed by the appliance

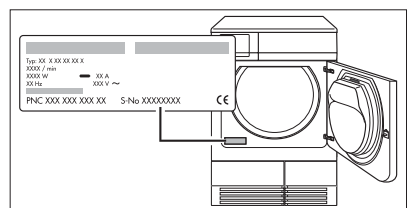

So that you have the necessary reference numbers from your appliance at hand, we recommend that you write them in here:

Model description:

PNC:

S No.:

GB **IE** Guarantee/Customer Service

GREAT BRITAIN & IRELAND

Standard guarantee conditions

We, Electrolux, undertake that if within 12 months of the date of the purchase this Electrolux appliance or any part thereof is proved to be defective by reason only of faulty workmanship or materials, we will, at our option repair or replace the same FREE OF CHARGE for labour, materials or carriage on condition that:

- The appliance has been correctly installed and used only on the electricity supply stated on the rating plate.
- The appliance has been used for normal domestic purposes only, and in accordance with the manufacturer's instructions.
- The appliance has not been serviced, maintained, repaired, taken apart or tampered with by any person not authorised by us.
- Electrolux Service Force Centre must undertake all service work under this guarantee
- Any appliance or defective part replaced shall become the Company's property.
- This guarantee is in addition to your statutory and other legal rights.

Exclusions

- Damage or calls resulting from transportation, improper use or neglect, the replacement of any light bulbs or removable parts of glass or plastic.
- Costs incurred for calls to put right an appliance which is improperly installed or calls to appliances outside the United Kingdom.
- Appliances found to be in use within a commercial environment, plus those which are subject to rental agreements.
- Products of Electrolux manufacturer that are not marketed by Electrolux

Service and Spare Parts

In the event of your appliance requiring service, or if you wish to purchase spare parts, please contact your local Service Force Centre by telephoning

0870 5 929 929

Your telephone call will be automatically routed to the Service Force Centre covering your postcode area.

For the address of your local Service Force Centre and further information about Service Force, please visit the website at

www.serviceforce.co.uk

Before calling out an engineer, please ensure you have read the details under the heading "What to do if..."

When you contact the Service Force Centre you will need to give the following details:

1. Your name, address and postcode.
2. Your telephone number.

3. Clear concise details of the fault.
4. The model and Serial number of the appliance (found on the rating plate).
5. The purchase date.

Please note a valid purchase receipt or guarantee documentation is required for in guarantee service calls.

Customer Care

For general enquiries concerning your Electrolux appliance, or for further information on Electrolux products please contact our Customer Care Department by letter or telephone at the address below or visit our website at www.electrolux.co.uk

Customer Care Department, Electrolux Major Appliances
Addington Way, Luton
Bedfordshire, LU4 9QQ

	Tel:
Electrolux	08705 950 950 ¹⁾
AEG-Electrolux	08705 350 350 ¹⁾
Zanussi-Electrolux	08705 727 727 ¹⁾

1) Calls may be recorded for training purposes

For Customer Service in The Republic of Ireland please contact us at the address below:

Electrolux Group (Irl) Ltd
Long Mile Road, Dublin 12, Republic of Ireland
Tel: +353 (0)1 4090751
Email: service.eid@electrolux.ie

European Guarantee

This appliance is guaranteed by Electrolux in each of the countries listed at the back of this user manual, for the period specified in the appliance guarantee or otherwise by law. If you move from one of these countries to another of the countries listed, the appliance guarantee will move with you subject to the following qualifications:-

- The appliance guarantee starts from the date you first purchased the appliance which will be evidenced by production of a valid purchase document issued by the seller of the appliance.
- The appliance guarantee is for the same period and to the same extent for labour and parts as exists in your new country

of residence for this particular model or range of appliances.

- The appliance guarantee is personal to the original purchaser of the appliance and cannot be transferred to another user.
 - The appliance is installed and used in accordance with instructions issued by Electrolux and is only used within the home, i.e. is not used for commercial purposes.
 - The appliance is installed in accordance with all relevant regulations in force within your new country of residence.
- The provisions of this European Guarantee do not affect any of the rights granted to you by law.

www.electrolux.com

		
Albania	+35 5 4 261 450	Rr. Pjeter Bogdani Nr. 7 Tirane
Belgique/België/Belgien	+32 2 363 04 44	Bergensesteenweg 719, 1502 Lembeek
Česká republika	+420 2 61 12 61 12	Budějovická 3, Praha 4, 140 21
Danmark	+45 70 11 74 00	Sjællandsgade 2, 7000 Fredericia
Deutschland	+49 180 32 26 622	Muggenhofer Str. 135, 90429 Nürnberg
Eesti	+37 2 66 50 030	Pärnu mnt. 153, 11624 Tallinn
España	+34 902 11 63 88	Carretera M-300, Km. 29,900 Alcalá de Henares Madrid
France	www.electrolux.fr	
Great Britain	+44 8705 929 929	Addington Way, Luton, Bedfordshire LU4 9QQ
Hellas	+30 23 10 56 19 70	4, Limnou Str., 54627 Thessaloniki
Hrvatska	+385 1 63 23 338	Slavonska avenija 3, 10000 Zagreb
Ireland	+353 1 40 90 753	Long Mile Road Dublin 12
Italia	+39 (0) 434 558500	C.so Lino Zanussi, 26 - 33080 Porcia (PN)
Latvija	+371 67313626	Kr. Barona iela 130/2, LV-1012, Riga
Lietuva	+370 5 278 06 03	Ozo 10a, LT-08200 Vilnius
Luxembourg	+352 42 431 301	Rue de Bitbourg, 7, L-1273 Hamm
Magyarország	+36 1 252 1773	H-1142 Budapest XIV, Erzsébet királyné útja 87
Nederland	+31 17 24 68 300	Vennootsweg 1, 2404 CG - Alphen aan den Rijn
Norge	+47 81 5 30 222	Risløkkvn. 2 , 0508 Oslo
Österreich	+43 18 66 400	Herziggasse 9, 1230 Wien
Polska	+48 22 43 47 300	ul. Kolejowa 5/7, Warszawa

		
Portugal	+35 12 14 40 39 39	Quinta da Fonte - Edificio Gonçalves Zarco - Q. 35 -2774-518 Paço de Arcos
Romania	+40 21 451 20 30	Str. Garii Progresului 2, S4, 040671 RO
Schweiz - Suisse - Svizzera	+41 62 88 99 111	Industriestrasse 10, CH-5506 Mägenwil
Slovenija	+38 61 24 25 731	Gerbičeva ulica 98, 1000 Ljubljana
Slovensko	+421 2 43 33 43 22	Electrolux Slovakia s.r.o., Electrolux Domáce spotrebiče SK, Seberíniho 1, 821 03 Bratislava
Suomi	www.electrolux.fi	
Sverige	+46 (0)771 76 76 76	Electrolux Service, S:t Göransgatan 143, S-105 45 Stockholm
Türkiye	+90 21 22 93 10 25	Tarlabası caddesi no : 35 Taksim İstanbul
Россия	+7 495 937 7837	129090 Москва, Олимпийский проспект, 16, БЦ "Олимпик"
Україна	+380 44 586 20 60	04074 Київ, вул.Автозаводська, 2а, БЦ "Алкон"

www.electrolux.com



To buy accessories, consumables and spare parts at our online shop please visit:
www.aeg-electrolux.co.uk

136905410-00-29022008

Free Manuals Download Website

<http://myh66.com>

<http://usermanuals.us>

<http://www.somanuals.com>

<http://www.4manuals.cc>

<http://www.manual-lib.com>

<http://www.404manual.com>

<http://www.luxmanual.com>

<http://aubethermostatmanual.com>

Golf course search by state

<http://golfingnear.com>

Email search by domain

<http://emailbydomain.com>

Auto manuals search

<http://auto.somanuals.com>

TV manuals search

<http://tv.somanuals.com>