

OPERATING INSTRUCTION UPS

AEG

PROTECT A.



PROTECT A. 1000

PROTECT A. 1400

1 **Notes on these Operating Instructions**

Duty to Provide Information

These operating instructions will help you to install and operate the Uninterruptible Power Supply (UPS), PROTECT A. 1000 or PROTECT A. 1400, all referred to as PROTECT A. in this document, safely and properly, and for its intended purpose. These operating instructions contain important information necessary to avoid dangers during operation.

Please read these instructions carefully prior to commissioning!

These operating instructions are a composite part of PROTECT A.

The operator of this unit is obliged to communicate these instructions to all personnel transporting or starting PROTECT A. or performing maintenance or any other work on the unit.

Validity

These operating instructions comply with the current technical specifications of PROTECT A. at the time of publication. The contents do not constitute a subject matter of the contract, but serve for information purposes only.

Warranty and Liability

We reserve the right to alter any specifications given in these operating instructions, especially with regard to technical data and operation.

Claims in connection with supplied goods must be submitted within eight days of receipt, along with the packing slip. Subsequent claims cannot be considered.

The warranty does not apply for damage caused by non-compliance with these instructions (such damage also includes damaging the "Q.A." warranty seal). AEG will accept no liability for consequential damage. AEG will rescind all obligations such as warranty agreements, service contracts,

etc. entered into by AEG and its representatives without prior notification in the event of maintenance and repair work being carried out with anything other than original AEG spare parts or spare parts purchased by AEG.

Handling

PROTECT A. is designed and constructed so that all necessary steps for start-up and operation can be performed without any internal manipulation of the unit. Maintenance and repair work may only be performed by trained and qualified personnel.

Hotline

If you still have questions after having read these operating instructions, please contact your dealer or our "Hotline":

Phone: +49 (0)180 5 234 787

Fax: +49 (0)180 5 234 789

Internet: www.aegpss.de

Copyright

No part of these operating instructions may be transmitted or reproduced by any electronic or mechanical means without the express prior written permission of AEG.

© Copyright AEG 2006. All rights reserved.

1.1 Declaration of Conformity

AEG

Power supply systems

Declaration of Conformity

Document - No. CE 0060

We

AEG Power Supply Systems GmbH
Emil – Siepmann – Straße 32, D – 59581 Warstein

declare under our sole responsibility that the product

Uninterruptible Power Supply (UPS)
Protect A.
type power 1000VA / 1400VA

to which this declaration relates is in conformity with the following standards or other normative documents

EN 50091-1-1:1996
EN 50091-2:1995 clause 2.4/2.5 class B
EN 61000-3-2:1995
EN 61000-3-3:1995

Following the provisions of directives

89 / 336 / EEC	EMC Directive
73 / 23 / EEC	Low Voltage Directive
93 / 68 / EEC	Marking Directive

Year of labelling the CE – Mark: 2005

Germany, 59581 Warstein, 07.11.2005

AEG PSS – Q
Quality Management



(Filmar)

AEG PSS - Product Management
Compact UPS



(Schneider)

2 Safety

2.1 Important Safety Instructions

Read these operating instructions carefully prior to commissioning of the PROTECT A. UPS and observe the safety instructions!

Only use the unit if it is in a technically perfect condition and always in accordance with its intended purpose, while being aware of safety and danger aspects, and in accordance with the operating instructions! Immediately eliminate any faults which could be detrimental to safety.

The following pictograms are used in these operating instructions to identify dangers and important information:



Danger!

Identifies risk of fatal injury to the operator.



Warning!

Identifies risk of injury and risk of damage to the unit and parts of the unit.

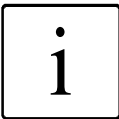

Information!

Useful and important hints for the operation of the UPS.

2.2 Safety Instructions for PROTECT A.

This chapter contains important instructions for the PROTECT A. UPS. These must be followed during assembly, operation and maintenance of the uninterruptible power supply and the batteries.



The UPS carries high voltage. **Danger! The unit may only be opened by trained and qualified personnel.** Repairs may only be carried out by qualified customer service staff!



The output may be live, even if the UPS is not connected to the mains supply, as the UPS has its own internal power supply (battery)!



For health and safety reasons, the unit must be earthed correctly!

PROTECT A. may only be operated with or connected to a 230 VAC mains with protective grounding using a mains connection cable with PE conductor (included in the delivery) that has been tested in accordance with German standards (VDE).

Danger! Risk of burning!



The battery has **powerful short-circuit currents**. Incorrect connection or isolation faults can lead to melting of the plug connections, sparking potential and **severe burns!**



The unit has a warning signal that sounds when the battery voltage of PROTECT A. is exhausted or when the UPS is not working in its normal mode.



Observe the following safety instructions to ensure permanent operational safety of and safe work with the UPS:

- ◆ Do not dismantle the UPS!
(The UPS does not contain any parts which require regular maintenance. Bear in mind that the warranty will be invalidated if the unit is opened!)
- ◆ Do not install the unit in direct sunshine or in close proximity of heaters!
- ◆ The unit is designed to be installed inside in heated rooms. Never install the UPS in the vicinity of water or in an excessively damp environment!
- ◆ Condensation may occur if the UPS is brought from a cold environment into the room where it is to be installed. The UPS must be absolutely dry prior to start-up. As a result, leave it to acclimatise for at least two hours.

- ◆ Never connect the mains input to the UPS output!
- ◆ Ensure that no fluids or foreign bodies can penetrate the UPS!
- ◆ Do not block the side air vents of the unit! Keep children away from the unit and ensure that objects are never inserted through the vents!
- ◆ Do not connect household appliances such as hairdryers to the UPS!
- ◆ The mains connection should be near the unit and easily accessible to facilitate disconnecting the AC input or pulling out the plug!
- ◆ During operation, do not disconnect the mains connection cable from the UPS or from the socket outlet in the building (shockproof socket), otherwise the protective grounding of the UPS and all the loads connected to it will be cancelled.



Danger! Electric shocks!

Even after the mains voltage has been disconnected, the components within the UPS remain connected to the battery and can thus cause electric shocks. It is therefore imperative to disconnect the battery circuit before carrying out any maintenance or repair work!



If it is necessary to replace the battery or carry out maintenance work, this must be done by or under the supervision of a person familiar with batteries and the necessary safety precautions!

Only authorised persons are allowed in the vicinity of the batteries!

When replacing the battery/batteries, the following must be observed: Only ever use identical maintenance-free sealed lead batteries with the same data as the original battery/batteries.



Danger! Explosive!

Never throw batteries into open fire. Never open or damage batteries. Electrolyte may leak out and damage skin and eyes. It may be toxic!



Batteries can cause electric shocks and high short-circuit currents.

Therefore, take the following safety precautions when working with batteries:

- ◆ Take off watches, rings and other metallic objects!
- ◆ Always use tools with insulated handles!



For personal safety reasons, never switch on the main switch when the mains connector of PROTECT A. is disconnected!

3 System Description

i PROTECT A. is an uninterruptible power supply (UPS) for essential loads such as personal computers (PCs) or ISDN telecommunication equipment and similar devices. It consists of:

- ◆ Mains filter in the mains input incl. mains energy backfeed protection
- ◆ A.V.R. control system
- ◆ (automatic voltage regulation with mains operation)
- ◆ Battery charger for charging the battery
- ◆ Battery as energy storage medium for bridging mains failures (for supplying the inverter)
- ◆ Inverter for the supply of connected loads with AC voltage during mains failures
- ◆ Static bypass switch for switching over the loads to the inverter in the case of a mains failure

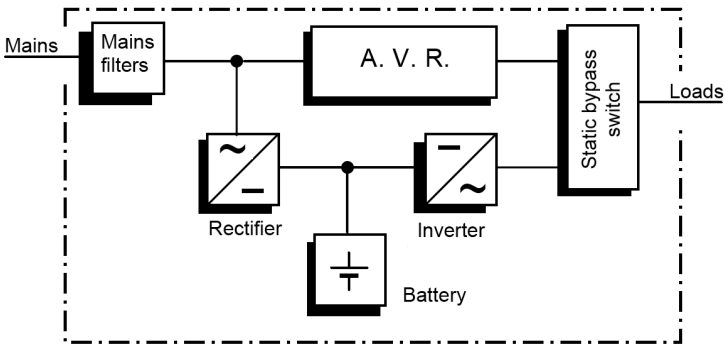

UPS Block diagram PROTECT A.

The UPS is connected to a shockproof socket between the public utility's mains and the loads to be protected.

Under normal operating conditions, i.e. if PROTECT A. is supplied with mains voltage, the battery charger will ensure that the battery is always completely charged. During this operating status, the loads connected to PROTECT A. are supplied with voltage via double mains filters which provide

effective protection against mains voltage peaks and high-frequency faults.

In case of sustained mains undervoltage or overvoltage within defined ranges, the automatic voltage regulator (A.V.R.) further stabilises the load voltage. As a result, voltage fluctuations in the public utility's mains are reduced to a level which is acceptable for the loads. This is performed without recourse to the internal energy storage, something which in turn has a positive effect on battery availability.

The static bypass switch is activated in the event of a mains failure. The inverter then takes over the voltage supply of the connected loads, in order to prevent the risk of data loss or damage to the loads. PROTECT A. supplies voltage until the battery is discharged, allowing you to shut down your IT system properly and switch it off. The standby time mainly depends on the connected loads. If the mains power supply is back to normal values, the UPS will switch back the loads to mains supply. The battery charger will then recharge the battery.

For safety reasons (as required by German standards, VDE), the mains input in the unit will be disconnected by a two-pole switch in the event of a mains failure. Energy backfeed to the mains and voltage supply to the pins of the mains connector are thus reliably avoided.

4 Set-Up and Operation

Installing the UPS is as easy as following the steps shown.

4.1 Inspection

Remove the UPS from its packaging and inspect it for damage that may have occurred during shipping. If any damage is discovered, repack the unit and return it to the place of purchase.

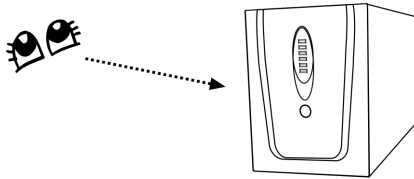

4.2 Placement

Install the UPS unit in any protected environment that provides adequate airflow around the unit which is free from excessive dust, corrosive fumes and conductive contaminants.



Do not operate your UPS in an environment where the ambient temperature or humidity is high. Also, place the UPS at least 20 cm away from the monitor to avoid interference.

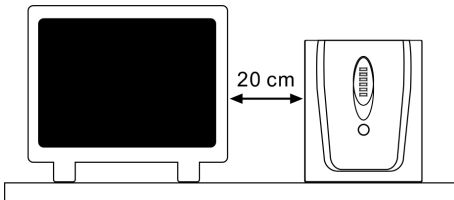

4.3 Charging

This unit is shipped from the factory with its internal battery fully charged, however, some power may be lost during shipping and the battery should be recharged prior to use. Plug the unit into an appropriate power supply and allow the UPS to charge fully by leaving it plugged in for at least 8 hours with no load (no electrical devices such as computers, monitors, etc.).

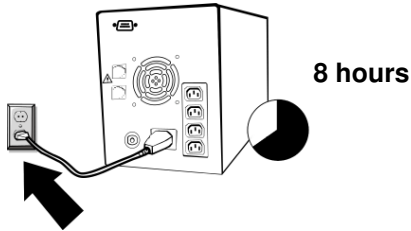

4.4 Computer connection

Connect one computer-related device to each of the power sockets found on the back of the UPS.

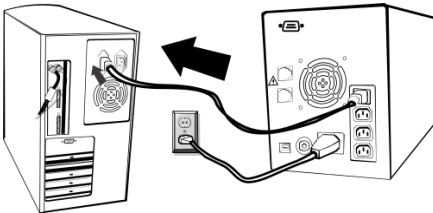

4.5 Data lines protection

Plug the incoming internet line into the "In" socket at the back of the PROTECT A. UPS.

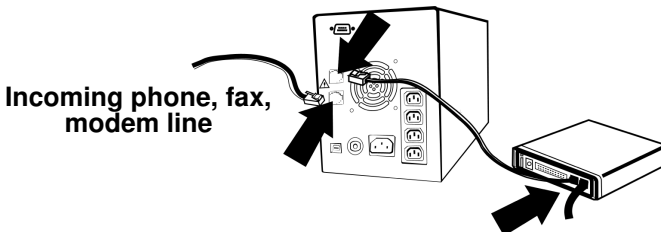

Use one more internet line cable and plug one end of the internet line cable to the “Out” socket at the back of the PROTECT A. UPS. Plug the other end of the modem input socket as shown.

4.6 USB and serial cable connection

To allow for unattended system shutdown for your operating system, connect the USB or the RS232 serial cable as shown below. For the USB serial cable just simply plug into the UPS and PC and it will be auto detected.

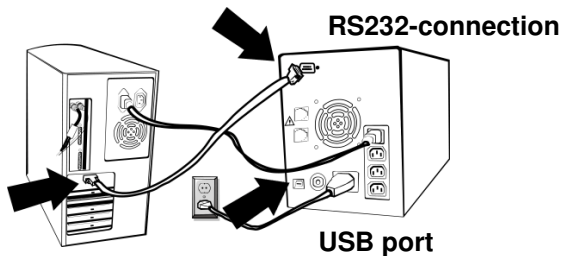

4.7 Turn On/Off

To turn on the PROTECT A., press the power switch lightly.
To turn off the PROTECT A., press the power switch again.

4.8 Deep discharge protection

The PROTECT A. is equipped with Green Power Function. For saving power and protecting the battery, this method of deep discharge protection is adopted in inverter mode.

4.9 Battery removal

Disconnect all power sources before battery replacement. Follow Fig. 1 below to remove the screw located on the bottom of the front panel and then open the front cover.

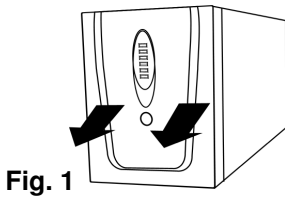

Fig. 1

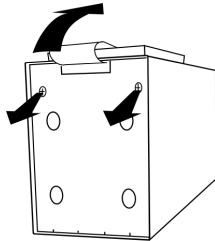

Fig. 2

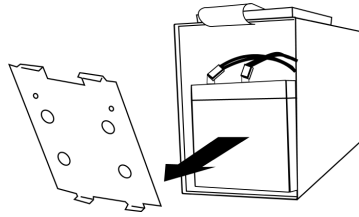

Fig. 3

After removing the front cover, follow Fig. 2 above to remove partition by unscrewing it. Then follow Fig. 3 to remove the battery.

4.10 Shutdown- and UPS management software

The "CompuWatch" software specially developed for these purposes by AEG continuously checks the mains supply and the UPS status.



In conjunction with the "intelligent" UPS, this ensures that the availability of IT components and data security are guaranteed.

The "CompuWatch" shutdown software supports different operating systems: Windows 98SE/ME, Windows NT/2000/XP, Linux SUSE, Linux RedHat, Novell NetWare, IBM AIX, HP-UX, SUN Solaris, Mac OS, and others.

Refer to the manual on the CD for details about installing the software on the various operating systems.

5 UPS overview

Connections, Operation / Display Elements:

Front view

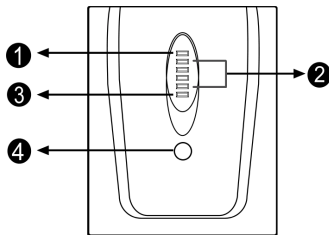

- 1 Red LED to signal "Warning/fault"
- 2 LED bar graph for UPS load and battery capacity. The bar graph show the load of the UPS system if the mains power is available (normal operation). In the battery operation, the LEDs indicate the capacity of the batteries:
 0 ~ 25%: 1. LED
 26% ~ 50%: 1. and 2. LED
 51% ~ 75%: 1., 2. and 3. LED
 76% ~ 100%: All 4 LEDs are lighting
- 3 Green LED lighting to signal "Mains"
 Green LED flashing: Battery mode
- 4 Main switch of the UPS (mains switch)

Rear view

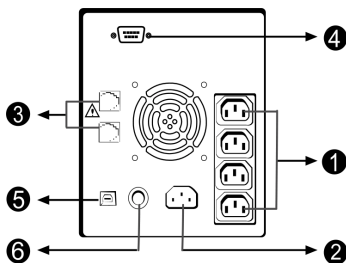

- 1 Load connections (UPS outputs)
- 2 Mains connection (UPS input)
- 3 Data line interface for phone, fax, modem
- 4 RS232 communication interface (SUB-D 9-pin socket)
- 5 USB port
- 6 Input breaker

5.1 Specifications

MODELL		PROTECT A. 1000	PROTECT A. 1400
Type		1000 VA / 600 W	1400 VA / 840 W
UPS-input	Input voltage	220 Vac / 230 Vac / 240 Vac	
	Input voltage range without battery mode	170 – 280 Vac	
	Frequency (auto selection)	50 / 60 Hz ± 5 Hz	
UPS-output	Rated output voltage /AVR-technology	220 Vac / 230 Vac / 240 Vac	
	Rated output voltage in battery mode	±10%	
	Frequency in battery mode	50 / 60 Hz ± 1 Hz	
	Transfer time at mains outage	2 – 6 ms (typical)	
	Output Waveform	Modified sinewave	
Battery	Type	12 V / 7 Ah x 2	12 V / 9 Ah x 2
	Autonomy time (full Load)	3 min	
	Recharge time (to 90% of rated capacity)	8 h	
Indicator	AC mode	Green LED lighting LED bar graph (LED 2 to 5) indicates the load capacity	
	Backup mode	Green LED flashing LED bar graph (LED 2 to 5) indicates the battery capacity	
	Fault	Red LED lighting	
Acoustic alarm	Backup mode	Sounding every 10 seconds	
	Low battery	Sounding every second	
	Overload	Sounding every 0.5 second	
	Battery replacement	Sounding every 2 seconds	
	Fault USP	Continuously sounding	
Protection		Discharge, overcharge, and overload protection	
General data	Size W x H x D (mm)	140 x 180 x 370	
	Weight (kg)	14 kg	14,5 kg
	Operating temperature range	0° - 40°C Relative humidity: 0 – 90 % (non-condensing)	
	Audible noise (1 m distance)	< 45 dB (A)	
Communication	Interfaces	USB and RS232 for status and measurement levels	
	Shutdown-Software (on CD)	Included for all typical operating systems (e.g. Windows, Linux, Mac)	

6 Trouble shooting

SYMPTOM	CAUSE	REMEDY
No LED display on the front panel	Missing battery	Charge battery up to 4 hours
	Battery fault	Replace with the same type of battery
	Power switch not pressed	Turn on the switch again
Alarm buzzer beeps continuously when AC supply is normal	UPS overload	Verify that the load matches the UPS capability as specified in the specs
When power failure, back-up time is short	UPS overload	Remove some non-critical load
	Battery voltage is too low	Charge battery 4 hours or more
	Battery fault due to high temperature operational environment, or improper treatment of battery	Replace with the same type of battery
Mains normal but LED is flashing	Fuse is blown	Replace with the same type of fuse
	Power cable is loose	Reconnect the power cable properly
Communication lost between UPS and computer.	Software not properly installed	Check the settings of the software
	Cable not properly connected	Check if the RS232-cable is properly connected to COM1 / COM2 of the computer and reconfirm the settings once again

If any abnormal situations occur that are not listed above, please call the service centre immediately.

Guarantee certificate

Type:

Serial-no.:

Date of purchase:

Trading stamp / Signature

Specifications are subject to change without notice.

AEG

Power supply systems

AEG Power Supply Systems GmbH

Emil-Siepmann-Str. 32
59581 Warstein-Belecke
Germany

Operating Instructions UPS

BAL 8000015757 EN

AEG0206EN

Free Manuals Download Website

<http://myh66.com>

<http://usermanuals.us>

<http://www.somanuals.com>

<http://www.4manuals.cc>

<http://www.manual-lib.com>

<http://www.404manual.com>

<http://www.luxmanual.com>

<http://aubethermostatmanual.com>

Golf course search by state

<http://golfingnear.com>

Email search by domain

<http://emailbydomain.com>

Auto manuals search

<http://auto.somanuals.com>

TV manuals search

<http://tv.somanuals.com>