





Dear customer,

Please read these operating instructions carefully and pay particular attention to the safety notes indicated in the first pages. We recommend that you keep this instruction booklet for future reference and pass it on to any future owners.

-  The warning triangle and/or the key words (Warning!, Caution!) emphasize information that is particularly important for your safety or correct functioning of the appliance.
-  This symbol guides you, step by step, in the operation of the appliance.
-  The information marked with this symbol provides additional instructions and practical tips on the use of the appliance.
-  Tips and information about economical and ecological use of the machine are marked with the clover symbol.

Should any problems arise, this booklet provides instructions on how to solve them by yourself; see section "Something not working?".

If this information is not sufficient, please contact our nearest SERVICE CENTRE.

Printed on recycled paper.
People who think ecologically, act accordingly...

Contents

Safety instructions	6
Disposal	8
Tips for environmental protection	8
Main features of your washer-dryer	9
Description of the appliance	10
Control panel.....	11
Programme selector dial.....	11
Programme Option buttons.....	13
PREWASH.....	14
SENSITIVE.....	14
STAIN.....	13
QUICK WASH.....	13
SPIN SPEED.....	14
RINSE HOLD.....	14
DELAY START button.....	12
START/PAUSE button.....	12
ELECTRONIC DRYING button.....	13
DRYING TIME button.....	13
Display.....	15
Programme progress display.....	15
Cancelling a programme.....	16
Altering a programme which is running.....	16
Opening the door after the programme has started.....	16
Detergent dispenser drawer.....	17
Before the first wash	17
Preparing the wash cycle	18
Sorting out and preparing the laundry.....	18
Weight of laundry.....	19
Types of fabric and care labels.....	19
Detergents and additives.....	21
Which detergent and additive?.....	21
How much detergent?.....	21
Liquid detergent.....	21
Adding a water softener (descaling product).....	21
Information on water hardness.....	21

Preparing the drying cycle	22
Load	22
Garments not suitable for drying	22
Drying symbols on garment labels	23
Duration of the drying cycle	23
Modification of the drying time	23
Fibre residue	23
Additional drying	24
How to dry	24
Drying only	24
How to wash	25
Load the laundry	25
Add detergent and additive	25
Selection of the desired wash programme	26
Selection of the desired options	26
Selection of the SPIN SPEED or RINSE HOLD option	26
Selection of the EXTRA RINSE	27
Selection of the DELAY START option	27
Starting the programme	27
At the end of the programme	28
Automatic washing and drying (NON-STOP programme)	29
Programme charts: wash and special programmes	30-31
Programme chart: drying	32
Consumption data for drying	33
Cleaning and maintenance	34
After each wash	34
Periodical cleaning	34
Exterior	34
Detergent dispenser drawer	34
Door seal	35
Drain pump	35
Water inlet filter	36
Emergency emptying out	36
Frost precautions	36
Something not working?	37
Troubleshooting	37-40
Unsatisfactory washing results	41

Technical data	42
Service	43
Instructions for installation and electrical connection.	44
Safety instructions for the installer	44
Dimensions of the appliance.	45
Front view and side view	45
Rear view	45
Installation	46
Unpacking	46
Positioning	47
Levelling	47
Water inlet	47
Water drainage	48
Electrical connection	49
Permanent connection	49



Safety instructions

The safety of AEG/ELECTROLUX appliances complies with the industry standards and with legal requirements on the safety of appliances. However, as manufacturers, we feel it is our duty to provide the following safety notes.

General safety

- Repairs to the machine must be carried out only by qualified personnel. Repairs carried out by inexperienced persons could cause serious danger. Contact your local AEG/ELECTROLUX Service Force Centre.
- Never start the machine if the electrical supply cable is damaged or the control panel or worktop are so damaged that inner components can be reached.
- Unplug the appliance before carrying out any cleaning or maintenance operations.
- Never pull the power supply cable to remove the plug from the socket; always take hold of the plug itself.
- Never spray the machine with a jet of water. Danger of electric shock!
- During high temperature wash programmes and during the drying cycle the door glass may get hot. Do not touch it!
- Let the water cool down before carrying out emergency emptying or before opening the door in an emergency.
- Small animals can gnaw electric wires and water hoses causing electrocution hazard and damage due to water leaks.

Positioning, connection, starting up

- Follow the **instructions for positioning and connection**.
- Carry out a first wash without laundry (COTTONS 60, with half the amount of detergent) in order to remove any manufacturing residue from the tub and the drum.
- Should the machine be purchased in winter, when temperatures can be below 0°, leave the appliance for 24 hours at ambient temperature before starting it.
- **Your appliance is provided of a new «antiflood device».** To make active this feature is needed close the bottom of the machine with the bottom cover that you can find inside the drum. Please read the instructions inserted into bottom cover bag.

Child safety

- Children are often not aware of how dangerous electrical appliances can be. When the machine is working, children should be carefully supervised and not be allowed to play with the appliance - there is a risk that they could become trapped inside.
- The packaging components (e.g. plastic film, polystyrene) can be dangerous to children - danger of suffocation! Keep them out of children's reach.
- Keep all detergents in a safe place out of children's reach.
- Make sure that children or pets do not climb into the drum.
- When the appliance is to be scrapped, cut off the electrical supply cable and destroy the plug with the remaining cable. Disable the door catch in order to prevent children from becoming trapped inside while playing.

Proper use

- This appliance is designed for domestic use only. If the machine is used for any other purposes or is not used correctly, the manufacturer accepts no responsibility for any damage that might occur.
- For safety reasons, the appliance must not be modified.
- Use only detergents suitable for washing machines and follow the manufacturer's instructions.
- Garments which have been in contact with flammable solvents should not be machine washed.
- Do not use your machine for dry cleaning.
- Dyes and bleaching agents may only be used if specifically permitted by the manufacturer of these products. We cannot be held responsible for any damage.
- Always unplug the appliance and turn off the water tap after use.



Disposal

Packaging materials

The materials marked with the symbol  are recyclable.

>PE<=polyethylene

>PS<=polystyrene

>PP<=polypropylene

This means that they can be recycled by disposing of them properly in appropriate collection containers.

Machine

Use authorised disposal sites for your old appliance. Help to keep your country tidy!

The symbol  on the product or on its packaging indicates that this product may not be treated as household waste. Instead it shall be handed over to the applicable collection point for the recycling of electrical and electronic equipment. By ensuring this product is disposed of correctly, you will help prevent potential negative consequences for the environment and human health, which could otherwise be caused by inappropriate waste handling of this product. For more detailed information about recycling of this product, please contact your local city office, your household waste disposal service or the shop where you purchased the product.



Tips for environmental protection

To save water, energy and to help protect the environment, we recommend that you follow these tips:

- Normally soiled laundry may be washed without prewashing in order to save detergent, water and time (the environment is protected too!).
- Use the energy saving programme when washing normally soiled garments.
- The machine works more economically if it is fully loaded (for both washing and drying cycles).
- When small loads are washed, use only half to two thirds of the recommended amount of detergent.
- The machine will consume less energy if the laundry is **adequately spun** before being dried.
- With adequate pre-treatment, stains and limited soiling can be removed; the laundry can then be washed at a lower temperature.

- If the water has a medium or high degree of hardness (starting from hardness degree II, see "Detergents and additives") water softeners must be added.
The amount of detergent can then be adjusted to hardness degree I (= soft).

Main features of your washer-dryer

- Programme and temperature setting using the programme selector.
- **Stain programme** for effectively treating stained washing.
- **Energy saving programme (60E)** for normally soiled cotton items.
- **Speed for the final spin** can be reduced to 1200, 900 or 700 rpm.
- **RINSE HOLD**: the laundry is left immersed in the final rinse water to prevent creasing.
- **Delay timer**: programme start can be delayed by 30 minutes to 23 hours (e.g. to times with a more economical power rate).
- **Programme progress display** showing the programme steps selected and the programme phase which is running.
- Because of its gentle washing action, the **special wool cycle** washes your garments with extreme care.
- **The drying programmes** will enable you to have dry and soft laundry in a short time.
- **3-compartment drawer** for detergent and fabric softener.
- **Unbalance detection device**: to prevent vibration during spinning.

Description of the appliance

Front view

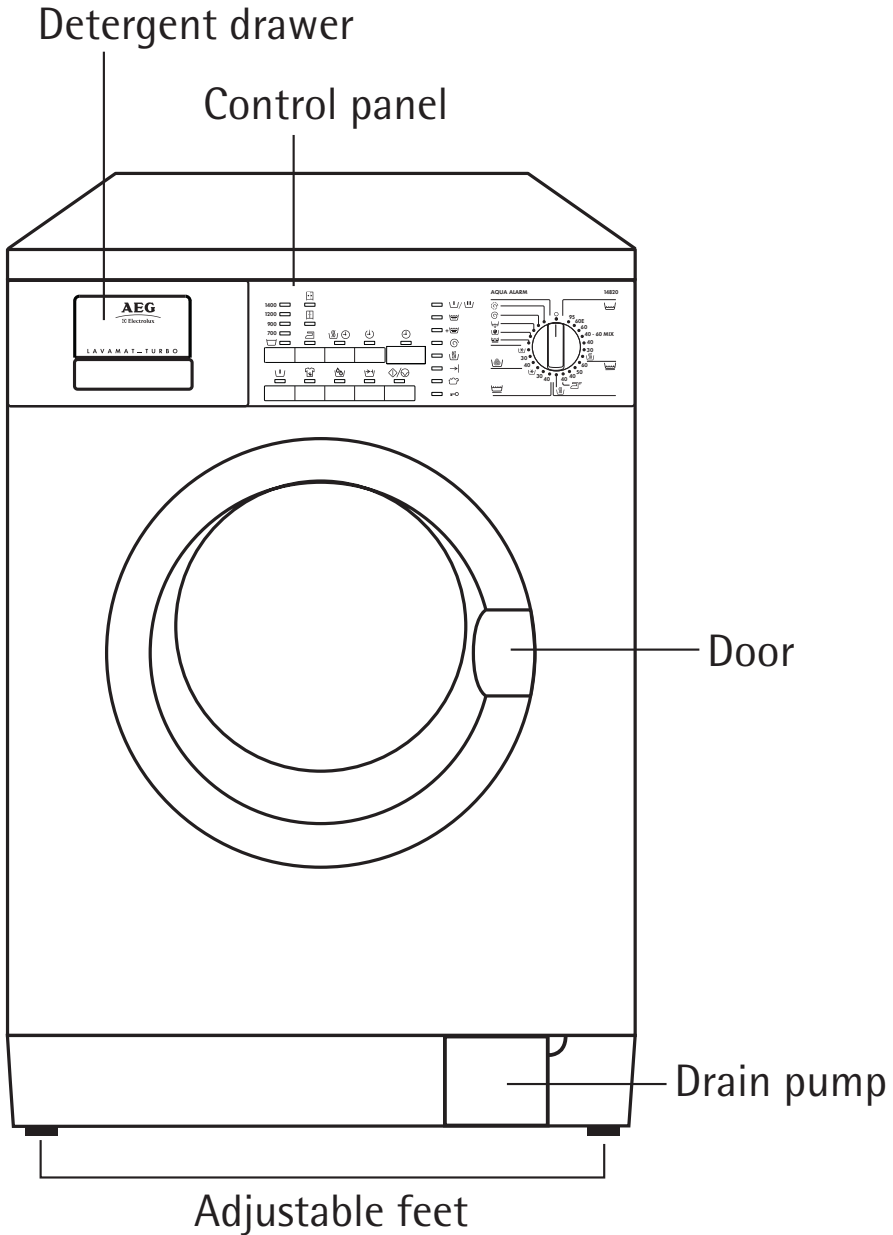



Position "60E" corresponds to the ENERGY SAVING programme for normally soiled laundry, extended washing time (cannot be combined with QUICK option). The washing temperature will decrease and the duration will be prolonged.

Position  **at 40°C** = Easy to iron.

In this position the laundry is gently washed and spun to avoid any creasing. In this way ironing is easier.

Position  = cold wash

Position  = drying

Programme Option buttons

Depending on the programme, different functions can be combined. These must be selected after choosing the desired programme and before depressing the START/PAUSE  button.

When these buttons are pressed, the corresponding pilot lights come on. When they are pressed again, the pilot lights go out.

PREWASH

The machine performs a prewash cycle at 30°C max. The prewash cycle ends with a short spin in programmes for Cotton and Synthetics, and with emptying of the water without spinning for Delicates.

This option is **not** available with the wool programme and **cannot** be used with  option.

For use when washing heavily soiled laundry.

STAIN

To treat heavily soiled or stained laundry with stain remover (extended main wash with time optimised stain action phase, **not** selectable for wool or programmes with temperatures lower than 40°C).

This function **cannot** be used with .

SENSITIVE

By depressing this button the washing intensity will be reduced. The machine adds one rinse in the programmes for COTTONS and SYNTHETICS. This option **cannot** be used with .

QUICK

By pressing this button the washing time is reduced. For use when washing lightly soiled laundry.

This option is **not** available with cotton 40-60 MIX, wool and economy programme 60E.

SPIN SPEED

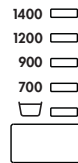

Press this button to reduce the maximum speed of the final speed proposed by the machine for the selected programme or to select  option.

The maximum spin speed for cotton is 1400 rpm, for synthetics, delicates and wool 900 rpm.











Important: By depressing at the same time buttons SPIN SPEED and  the machine will perform an extra rinse (see page 27).

RINSE HOLD

By selecting this option, the last rinse water is not emptied out, to prevent the fabrics from creasing. When the programme has finished, the  (END) pilot light on the programme progress display illuminates, the  (DOOR) pilot light is red and the door is blocked to indicate that the water must be emptied out.

To empty out water:

- select the  (drain) programme to empty out the water without spinning;
- select the  (spin) or  (delicate spin) for spinning;
- select the SPIN SPEED and depress  button;

Warning! The programme selector dial must be turned first to position  and then to the ,  or  programmes.



The  option **cannot** be selected for the automatic WASHING & DRYING programme.

DELAY START button

The wash programme can be delayed from 30, 60, 90 minutes and then 1 hour by 1 hour up to a maximum of 23 hours.

The button must be pressed after selecting the programme and before pressing the  button.

The figures indicating the delay appear for about 3 seconds in the display. The duration of the selected wash programme is then displayed. After depressing the  button, the machine starts its hourly count-down.

To cancel the preset delay, press the  button, then press the  button until the symbol  is displayed.

Then press the  button again to restart the programme.

The display shows the duration of the wash programme previously selected .

START/PAUSE button

This button has two functions:

a) Start

After having selected the required programme, press this button to start the machine. The corresponding pilot light stops flashing and remains static. If you have selected the  (DELAY START) option, the machine starts its hourly countdown.



b) Pause

To interrupt a programme which is running, press the  button: the corresponding pilot light starts to flash.

To restart the programme from the point at which it was interrupted, **press the  button again.**

ELECTRONIC DRYING button

By means of this button you can choose the required degree of drying for cottons and synthetics:

-  Extra dry (not for synthetics)
-  Store dry
-  Iron dry (not for synthetics)



The drying time is automatically adjusted by the machine: the laundry will be dried to the selected degree of dryness.

DRYING TIME button

If you wish to carry out a timed programme of dryness push the  button until the drying time you want appears in the display according to the fabrics (cotton or synthetics) you have to dry.

For cottons and synthetics you can select a drying time from 10 minutes to 130 minutes.

Display



The display shows the following information:

- **Duration of the selected programme (in minutes)**, calculated automatically on the basis of the maximum recommended load for each type of fabric.
- **Selected drying time** (max. 130 minutes for cotton and for synthetics).
After the programme has started, the time remaining is updated every minute.
- When the programme has finished, a **steadily lit zero** is displayed.
- **Delayed start**, (23 hours max.) programmed using the special button . The countdown is updated every hour and by 30 minutes during the last two hours.
- **Alarm code** indicating a fault in the machine operation (see page 37).

Programme progress display

By selecting the wash programme, the pilot lights corresponding to the various phases making up the programme come on.

After the machine has started, only the running phase pilot light stays on. When the programme has finished, the  pilot light comes on.



PREWASH/ WASH	<input type="checkbox"/>	
RINSES	<input type="checkbox"/>	
EXTRA RINSE	<input type="checkbox"/>	
SPIN	<input type="checkbox"/>	
DRYING	<input type="checkbox"/>	
END	<input type="checkbox"/>	
OVER DOSAGE	<input type="checkbox"/>	
DOOR	<input type="checkbox"/>	



When the programme has finished, if the light  (OVERDOSAGE) comes on, it indicates that too much detergent has been used.

Canceling a programme

To cancel a programme which is running, turn the programme selector dial to the RESET/O position.

Warning! After a programme which ends with water in the drum (□), turn the selector dial first to O and then to the the ,  or  programmes.

Altering an option which is running

To alter an option, first set the machine to PAUSE by pressing the /◻ button.

Any option can be modified before the machine starts it. After selecting the new option press the /◻ button again to re-start the selected programme.

To modify the selected programme turn the programme selector dial to O and then choose a new programme.

The water is **not** emptied out and after pressing the /◻ button again the machine restarts with the newly selected programme.

Opening the door after the programme has started

To open the door set the machine to PAUSE by pressing the /◻ button.

The  (DOOR) light on the control panel indicates if the door can be opened:

- green light: the door can be opened;
- red light: the door cannot be opened;



The door can be opened if:

- the machine is not already heating or drying;
- the water level is not above the bottom edge of the door;
- the drum is not turning.

If you need to open the door, switch the machine off by turning the selector dial to position O/OFF, and wait about 3 minutes before opening the door (pay attention to the temperature and the level of the water in the tub).

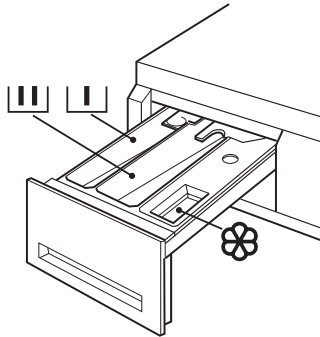
Detergent dispenser drawer



-  Compartment for prewash or stain remover. The prewash detergent is added at the beginning of the wash programme. The stain remover is added during the STAIN-Action phase in the main wash.
-  Compartment for powder or liquid detergent used for main wash. It is emptied at the beginning of the wash cycle.
-  Compartment for liquid additives (fabric softener, starch). It is emptied at the last rinse.

The quantity of additives must not exceed the "MAX" mark in the drawer.

Before the first wash

Before your first wash, we recommend that you run a cotton cycle at 60°C, **without any laundry in the machine**, to remove any manufacturing residue from the drum and tub.

Pour 1/2 a measure of detergent into the dispenser drawer and start the machine.

Preparing the wash cycle

Sorting out and preparing the laundry

- Sort out the laundry according to type of fabrics and care labels (see "Types of fabric and care labels").
- Empty pockets.
- Remove any metal parts (safety pins, clips, etc.).
- To prevent the laundry from getting damaged and forming bundles, it is advisable to close zips, button up pillowcases and quilt covers and tie up loose straps such as those of aprons.
- Turn double faced items inside out (sleeping bags, anoraks, etc.)
- Turn coloured knitted fabrics, woollens and fabrics with trim inside out.
- Wash small and delicate items (baby socks, tights) inside a laundry net or in a pillow case closed with a zip, or in larger socks.
- Treat curtains with special care. Remove all metal or plastic hooks or put them in a net or a bag. We take no responsibility for any damage.
- Whites and coloureds must be washed separately: white items can lose their whiteness.
- New coloured fabrics often have excess dyes; it is advisable to wash them separately for the first time.
- Wash small and large items together; this improves the washing result and the laundry is better distributed during spinning.
- Shake out garments before putting them into the machine.
- Insert each garment separately.

Weight of laundry

Sort of laundry	Approximate dry weights
Bathrobes	1200 g
Work shirts	300-600 g
Quilt covers	700 g
Sheets	500 g
Blouses	100 g
Hand towels	200 g
Tea towels	100 g
Shirts	200 g
Pillowcases	200 g
Night-gowns/Pyjamas	200-250 g
Tablecloths	200-300 g
Underwear	250 g

Types of fabric and care labels

The labels on garments help you to select the most suitable wash programme. The laundry should be sorted out according to the type of fabric and the instructions indicated on care labels.

Temperatures indicated on labels are always maximum temperatures.

Cotton

Linen and cottons marked with this symbol can be washed at high temperatures.

Cotton

Linen and cottons marked with this symbol are colourfast and can be washed at 60°C.

Cotton

Garments marked with these symbols have delicate colours, therefore the washing temperature must not exceed these values.

Synthetics

Mixed and synthetic fabrics marked with these symbols require a gentle wash programme and they must therefore be washed using the specific programme.

Delicates  

Microfibres, synthetics or curtains marked with these symbols require a very gentle treatment.

The DELICATES programme is suitable for this type of fabric.

Woolens and particularly delicate items    

Fabrics such as wool, wool mix or silk marked with this symbol are particularly sensitive to machine washing.

The WOOL programme  is suitable for this type of fabric.

If the label has the symbol  (do not wash), the garments must not be machine washed!

The wool wash cycle of this machine has been approved by Woolmark for the washing of machine washable Woolmark products provided that the garments are washed according to the instructions on the garment label and those issued by the manufacturer of this washing machine. M9605.

Detergents and additives

Which detergent and additive?

Use only detergents and additives for washing machines. Follow the manufacturer's instructions.

How much detergent?

The quantity depends on:

- the load:
if the manufacturer does not provide any indications on the amount of detergent for small loads, use about one third less than the suggested amount for half loads and half the amount for very small loads;
- the degree of soil:
use a small amount of detergent for lightly soiled garments. Judge the amount according to the detergent manufacturer's instructions and size of the load;
- the water hardness:
the harder the water, the more detergent required. Instructions according to water hardness are given on the detergent pack.

Liquid detergent

Liquid detergent can be poured directly into the main wash compartment of the dispenser drawer **immediately** before starting the programme, or a special dispenser can be used that is placed directly in the drum. Measure the detergent according to the manufacturer's instructions.

Adding a water softener (descaling product)

A water softener must be added when water has a medium-high degree of hardness (from degree of hardness II). Follow the manufacturer's instructions. The quantity of detergent can then always be adjusted to degree of hardness I (= soft). Information on water hardness can be obtained from your local water supply authority.

Information on water hardness

Degree of hardness	German degrees °dH	French degrees °TH
I=Soft	0-7	0-15
II=Medium	7-14	16-25
III=Hard	14-21	26-37
IV=Very hard	more than 21	more than 37

Preparing the drying cycle

As a dryer, the machine works on the condensation principle.

Therefore, **the water tap must be open and the drain hose must drain water into a sink or into the drain pipe, even during the drying cycle.**

Load

Sort of laundry	max. load (dry weight)
Linen and cottons	3 kg
Synthetics	2 kg

Warning:

Loads of washed laundry exceeding these values must be divided before being dried, otherwise poor results will be obtained.





Garments not suitable for drying

- Particularly delicate items such as synthetic curtains, woollen and silk, garments with metal inserts, nylon stockings, bulky garments such as anoraks, bedcovers, quilts, sleeping bags and duvets must not be machine dried.
- Garments padded with foam-rubber or materials similar to foam-rubber must not be machine dried; they represent a fire hazard.
- Also, fabrics containing residues of setting lotions or hair sprays, nail solvents or similar solutions must not be machine dried in order to avoid the formation of harmful vapours.

Drying symbols on garment labels

Always look at the garment label to check whether garments can be machine dried.

The following symbols refer to drying:

-  Machine drying is usually possible
-  Normal drying (normal temperature)
-  Gentle drying (reduced temperature)
-  Do not machine dry

Duration of the drying cycle





The drying time can vary according to

- the final spin speed;
- the required degree of drying (store dry or iron dry);
- the type of laundry;
- the size of load.

The usual drying times are indicated in the programme chart. As you become more familiar with the appliance, you will discover the drying times that best suit your needs according to the various type of fabric. It is a good idea to make a note of these times.

Modification of the drying time or degree of drying

(just in case of washing + drying)

If you wish to modify the drying time or degree of drying when a drying programme is running, first depress /  button to set the machine to PAUSE. After modifying the time or degree, depress /  again to continue the programme.

Fibre residue

After drying fluffy fabrics, such as new towels, it is advisable to perform the  (RINSE) programme to be sure that any residue that may remain in the tub is completely removed and does not stick to garments dried afterwards.

After each drying cycle the filter should be checked and cleaned.

Additional drying

Should the laundry still be too wet at the end of the programme, set another short drying time.



Warning! To prevent the formation of creases or shrinking of fabrics, avoid excessive drying.

i How to wash

Max. load





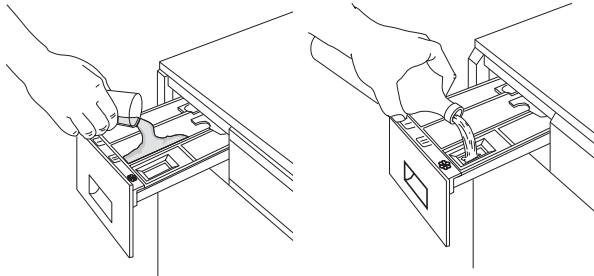

- cottons	6 kg
- synthetics and delicates	3 kg
- wool	2 kg

Load the laundry

-  Open the door.
-  Place the laundry in the drum, one item at a time. Distribute laundry as evenly as possible. Close the door.



Add detergent and additive

-  Pull the drawer out till it stops.
-  Pour the main wash detergent into compartment .
- If you wish to perform a prewash, a STAIN-Action programme, pour detergent or stain remover into compartment .
- Important!**
Do not use normal detergent for the STAIN-Action programme, always use a STAIN remover.
-  Pour the fabric softener into compartment  without exceeding the "MAX" mark.
-  Close the drawer gently, pushing it fully in.

Selection of the desired wash programme

 Turn the programme selector dial to the desired position: the lights corresponding to the different phases making up the selected programme light on. The display shows the duration of the programme.

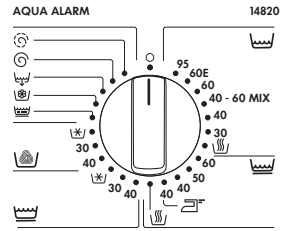

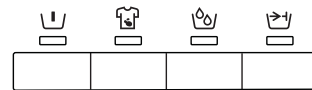

Selection of the desired options

depending on the degree of soil of the laundry. The corresponding light comes on.



Selection of the spin speed or option

 It is possible to select a lower spin speed by means of the relevant button; the light corresponding to the selected speed comes on.

Selecting  option the laundry is left immersed in the final rinse water.

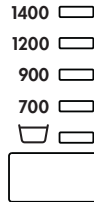

i If the spin speed is not reduced, the final spin speed will be as follows:

- cottons 1400 r.p.m.
- synthetics 900 r.p.m.
- delicates 900 r.p.m.
- wool 900 r.p.m.

EXTRA RINSE



This appliance is designed for saving water. However, for people with a very delicate skin (allergic to detergents) it may be necessary to rinse the laundry using an extra quantity of water (extra rinse).



The extra rinse is available only with the cotton, synthetics or delicate programme.

Selection of the option



Press simultaneously buttons SPIN SPEED and  for about 3 seconds: the  light comes on in the programme progress display. This function stays permanently on. To remove it press the same buttons again until the  light comes off.

Selection of the option



To delay starting of a programme, press the  button **before starting the machine**. The figures corresponding to the selected delay will be displayed for about 3 seconds, after which the duration of the selected programme will appear on the display.

When the  button is pressed, the selected delay will appear again on the display and the machine starts its countdown.

Starting the programme

1. Check that the water tap is open.
2. Press  to start the programme.







If the  option has been selected the programme will start at the end of the countdown.



If the  light is red and flashing at the start of the programme it

indicates that the door is open. Close the door and press the  button again.

If the delay start option has been selected, the machine starts its countdown, in hours, which will appear on the display. During this period it is possible to load other laundry, to modify or cancel the delay time.

- **Load other laundry:** press the  button. Open the door. Load the laundry. Close the door and press the  button again.
- **Cancel the delay time:** press the  button. Press the  button until on the display appears . Press the  button again.

Programme progress display

By selecting the wash programme, the pilot lights corresponding to the various phases making up the programme come on. After the machine has started, only the running phase pilot light stays on.

PREWASH/ WASH	
RINSES	
EXTRA RINSE	
SPIN	
DRYING	
END	
OVER DOSAGE	
DOOR	

Display

The time to the end of the programme decreases minute by minute and appears on the display.



At the end of the programme

The machine stops automatically. A zero appears on the display. The light comes on in the programme progress display, the pilot light is red and the door is blocked to indicate that the water must be emptied out.

If the option has been selected, the water must be emptied out before opening the door either.

To empty out water:

- select the (drain) programme to empty out the water without spinning;
- select the (spin) or (delicate spin) for spinning;
- select the SPIN SPEED and depress button;

Warning! The programme selector dial must be turned first to position and then to the , or programmes.

Turn the selector dial to .

Remove the laundry from the drum.

Check that the drum is empty so as to avoid any forgotten items being damaged in a subsequent wash (e.g. shrinking) or their colour running into a load of whites.

Close the water tap.









Leave the door open to prevent the formation of mildew and unpleasant smells.

i Automatic washing and drying (NON-STOP programme)

Warning! For NON-STOP programmes, it is also essential not to exceed the maximum load sizes of 3 kg for cotton and 2 kg for synthetics.

-  Load the laundry.
-  Add detergent and additive.

Do not use a dosing device/ball when carrying out a washing & drying programme.

-  Select the wash programme.
-  Select eventually the required options by means of the relevant buttons. If possible, **do not select** a spin speed lower than that proposed by the appliance to avoid a too long drying time so saving energy. By automatic washing and drying it is not possible to select a spin speed lower than 900 r.p.m. for cottons and synthetics.
-  Select the drying time or degree of drying.
-  Start the programme by depressing the /  button.
-  At the end of the programme, turn the selector dial to .
-  Remove the laundry.













i How to dry

Drying only

Max. load







































- cottons 3 kg
- synthetics 2 kg

During the drying programme the water tap must be open and the drain hose must be correctly positioned.

-  Turn the programme selector dial to drying programmes indicated by the symbol  for cottons or synthetics.
-  If you wish to carry out the timed drying press button   until the time you want appears in the display.
-  If you wish to carry out the electronic drying depress the relevant button until the light corresponding to the degree of dryness required ( extra dry,  store dry or  iron dry) illuminates.
-  Press the  button to start the programme.
-  At the end of the cycle turn the programme selector dial to  and remove the laundry.

Programme chart

Wash programmes







Wash programme	Temp.	Fabrics	Additional functions	Load	Consumption*		
					Energy kWh	Water lt.	Duration min.
 White Cottons	95°-60°	Cotton and linen, for example normally soiled work garments, sheets, household linen, underwear, towels.	    +   SPIN SPEED	6 kg	2.05	55	142
 (°)60E	60E	Cotton and linen, for example normally to lightly soiled sheets and household linen.	   +   SPIN SPEED	6 kg	1.07	52	127
 Coloured cottons	60° 40°-30° 40-60 MIX	Coloured cotton or linen fabric, shirts, underwear, towels.	    +   SPIN SPEED	6 kg	1.20	52	121
 Synthetics	60°-50° 40° 	Synthetic fabrics, underwear, coloured garments, non-shrink shirts, blouses.	    +   SPIN SPEED	3 kg	1.05	55	89
 Delicates	40°-30°  (COLD)	Delicate fabrics, for example curtains.	   +   SPIN SPEED	3 kg	0.60	57	58
 Wool	40°-30°  (COLD)	Wool, wool mixtures, silk and handwash garments.	 SPIN SPEED	2 kg	0.40	55	57

(°) In compliance with EC directive 92/75, the consumption figures indicated on the energy label refer to the 60E wash programme for cotton.

* The consumption data shown on this chart is to be considered purely indicative, as it may vary depending on the quantity and type of laundry, on the inlet water temperature and on the ambient temperature. It refers to the highest temperature for each wash programme.

Programme chart



Special programmes

Programme	Description	Programme phases	Additional functions	Load	Consumption*		
					Energy kWh	Water lt.	Duration min.
 Rinses	This programme can be used for rinsing hand washed garments.	3 rinses with liquid additive. Short spin. (900 rpm max)	 SPIN SPEED	6 kg	0.06	48	23
 Softeners	Hand washed garments to be starched or softened.	1 rinse with liquid additive. Long spin.	 SPIN SPEED	6 kg	-	20	23
 Drain	For emptying out the last rinse water in programmes with the Rinse Hold option.	The water is emptied out.		-	-	-	2
 Spin	Separate spin for cottons.	Long spin.	SPIN SPEED	6 kg	-	-	10
 Short spin	Separate spin for delicate fabrics.	Short spin. (900 rpm max)	SPIN SPEED	3 kg	-	-	6
RESET/OF F O		For cancelling the programme which is running or to switch the machine off.		-	-	-	-

* The consumption data shown on this chart is to be considered purely indicative, as it may vary depending on the quantity and type of laundry, on the inlet water temperature and on the ambient temperature.

Programme chart





Drying

Degree of drying	Type of fabric	Max. load	Spin speed	Drying time mins
 Extra dry Ideal for towelling materials	Cotton and linen (bathrobes, bath towels, etc.)	3 kg	1400	85-95
		1.5 kg	1400	45-55
 Store dry (*) Suitable for items to put away without ironing	Cotton and linen (towels, T-shirts, bathrobes)	3 kg	1400	75-85
		1.5 kg	1400	40-50
	Synthetics and mixed fabrics (jumpers, blouses, underwear, household linen)	2 kg	900	70-80
		1 kg	900	35-45
 Iron dry Suitable for ironing	Cotton and linen (sheets, tablecloths, shirts, etc.)	3 kg	1400	55-65
		1.5 kg	1400	35-45

(*) The STORE DRY drying programme for cotton is the reference programme for the Energy Label data, in compliance with standard EEC 92/75.

Consumption data for drying

The values shown in the chart have been obtained in laboratory tests. They may vary when the appliance is used at home, but they can be used as indicative values.

Degree of drying	Spin speed	Max load	Water litres	Energy kWh	Duration minutes
Cotton Extra dry 	1400	3 kg	23	2.4	85-95
Cotton Store dry 	1400	3kg	20	2.1	75-85
Cotton Iron dry 	1400	3 kg	16	1.6	55-65
Synthetics Store dry 	900	2 kg	20	1.2	70-80

Cleaning and maintenance

After each wash

☞ At the end of the wash programme, pull the dispenser drawer out a little to let it dry.

☞ Leave the door ajar to allow air to circulate.

If the machine is not used for a prolonged period:

☞ **Close the water tap and unplug the appliance.**

Periodical cleaning

Exterior

☞ Clean the outside of the cabinet with soap and water only. Rinse with clean water and dry.

Important: do not use methylated spirits, solvents or similar products to clean the cabinet.

Detergent dispenser drawer

After a while, detergents and fabric softeners leave deposits in the drawer.

☞ Clean the drawer, from time to time, by rinsing it under a running tap. To remove the drawer from the machine, press the button in the rear left-hand corner.

☞ To facilitate cleaning, the top part of the additive compartment can be removed.

☞ Detergent can also accumulate inside the drawer recess: clean it with an old toothbrush.

☞ Refit the drawer after cleaning.

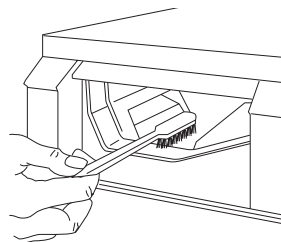
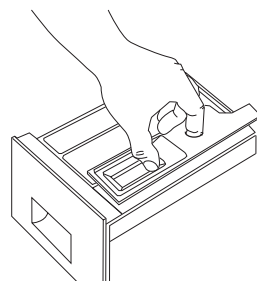
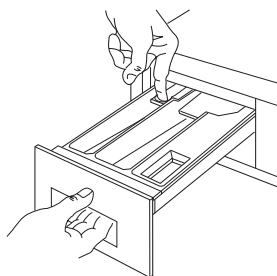

Door seal



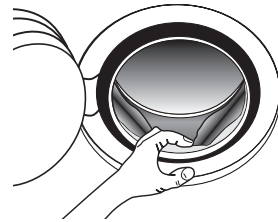







Check from time to time the door seal and eliminate eventual possible objects that could be trapped in the fold.



Drain pump

The pump should be inspected regularly and particularly if the machine does not empty and/or spin the machine makes an unusual noise during draining due to objects such as safety pins, coins etc. blocking the pump.



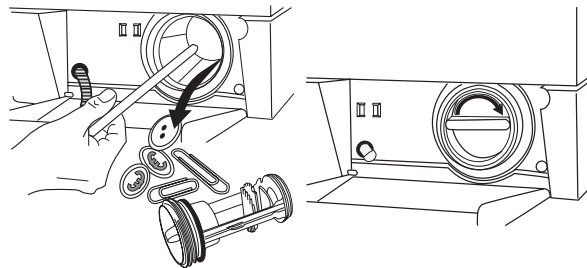
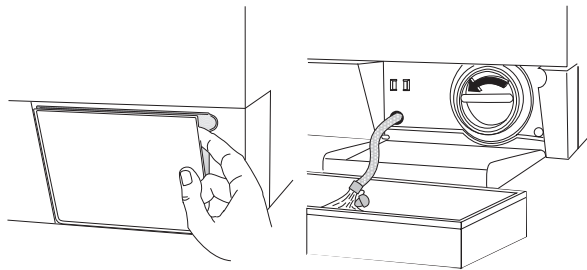

Proceed as follows:

-  Disconnect the appliance.
-  If necessary wait until the water has cooled down.
-  Open the pump door.
-  Place a container close to the pump to collect any spillage.
-  Release the emergency emptying hose, place it in the container and remove its cap.
-  When no more water comes out, unscrew the pump and remove it. Always keep a rag nearby to dry up spillage of water when removing the pump.
-  Remove any objects from the pump impeller by rotating it.
-  Put the cap back on the emergency emptying hose and place the latter back in its seat.
-  Screw the pump fully in.
-  Close the pump door.



Water inlet filter

If you notice that the machine is taking longer to fill, check that the filter in the water inlet hose is not blocked.

-  Turn off the water tap.
-  Unscrew the hose from the tap.
-  Clean the filter in the hose with a stiff brush.
-  Screw the hose back onto the tap.

Emergency emptying out

If the water is not discharged, proceed as follows to empty out the machine:

- pull out the plug from the power socket;
- close the water tap;
- if necessary, wait until the water has cooled down;
- open the the pump door;
- place a bowl on the floor and place the end of the emergency emptying hose into the bowl. Remove its cap. The water should drain by gravity into the bowl. Whe the bowl is full, put the cap back on the hose. Empty the bowl. Repeat the procedure until water stops flowing out;
- clean the pump if necessary as previously described;
- replace the emergency emptying hose in its seat after having plugged it;
- screw the pump again and close the door.

Frost precautions

If the machine is installed in a place where the temperature could drop below 0°C, proceed as follows:

- Close the water tap and unscrew the water inlet hose from the tap.
- Place the end of the emergency emptying hose and that of the inlet hose in a bowl placed on the floor and let water drain out.
- Screw the water inlet hose back on and reposition the emergency emptying hose after having put the cap on again.

By doing this, any water remaining in the machine is removed, avoiding ice forming and consequently damage to the appliance.

When you use the machine again, make sure that the ambient temperature is above 0°C.

Something not working?

- i** If during the spin cycle the machine makes an unusual whistling noise, different from the noise made by traditional washing machines, this is due to a new type of motor.



If water is not visible in the drum, this is due to the modern technology of new washing machines that use less water than traditional machines.

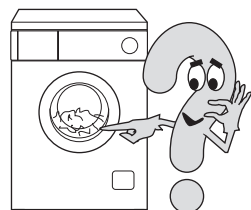

Troubleshooting

If a problem arises, you can try to solve it yourself following the instructions below.

If you call out an engineer when one of the following problems arises, or to repair a fault due to incorrect use, the call-out will be charged even if requested within the guarantee period.



During machine operation the following alarm codes may be displayed:

- **E10:** problem with the water supply
- **E20:** problem with water draining
- **E40:** door open

At the same time the light → flashes and an acoustic signal sounds.

Once the problem has been eliminated, press the ⏏/⏏ button to restart the programme. If after all checks, the problem persists, contact your local AEG/ELECTROLUX Service Force Centre.

Problem	Possible cause	Solution
The machine does not work	The main electrical fuse has blown.	Replace the fuse.
	The door is not properly closed (E40).	Close the door; the click of the lock should be heard.
	The plug is not connected.	Insert the plug.
	The ⏏/⏏ button has not been pressed.	Press the button.
	The ⏏ option has been selected.	Check the selected delay on the display.

Problem	Possible cause	Solution
The machine does not fill	The water tap is closed (E10) .	Open the water tap.
	The water inlet hose is squashed or kinked (E10) .	Check the whole length of the hose and remove the kink.
	The small filter of the water inlet hose is clogged (E10) .	Clean the filter.
	The door is not properly closed (E40) .	Close the door.
The machine fills then empties immediately	The end of the drain hose is too low.	Place the hose at the right height (see Installation section).
The machine does not empty and/or does not spin	The drain hose is squashed or kinked (E20) .	Check the whole length of the hose and remove the kink.
	The drain pump or the drain hose are clogged (E20) .	Clean the pump or check the hose.
	The  option (stop with water in drum) has been selected.	Empty out the water by selecting the  programme or  programmes.
	The laundry is not evenly distributed inside the drum.	Redistribute the laundry manually in the drum.
There is water on the floor	Too much detergent has been used.	Measure detergent according to the manufacturer's instructions.
	An unsuitable detergent has been used that creates too much foam.	Use a suitable washing machine detergent.
	One of the connectors on the water inlet hose is leaking.	Check that the hose is firmly screwed on at both ends.
	The drain pump has not been properly screwed on after cleaning.	Fully screw the pump into place.
	The cap on the emergency emptying hose has not been replaced after cleaning the pump.	Replace the cap on the emergency emptying hose after cleaning the pump.

Problem	Possible cause	Solution
The machine vibrates or is noisy	The transit bolts have not been removed.	Check that the machine has been unpacked as described in the Installation section.
	The feet have not been adjusted.	Carefully level the machine.
	There is little laundry in the drum.	Correct operation of the machine is not affected.
The door will not open	The programme is still running and the drum is turning.	Wait until the end of the programme before opening the door.
	The water level is above the bottom edge of the door.	Before opening the door, the water must be emptied out.
	The machine is heating the water or drying the clothes.	Wait until the end of the heating or drying phase.
The display shows the alarm code EFD	The water safety system starts working to prevent any flooding.	Switch the machine off, close the inlet pipe, and call the Service Force Centre.

Problem	Possible cause	Solution
Spinning starts late or the machine does not spin	The unbalance detection device that prevents excessive vibration during spinning has cut in.	<p>If the laundry is not evenly distributed inside the drum at the beginning of the spin cycle, the machine detects this and tries to redistribute it more evenly by means of a few drum rotations.</p> <p>Only when the laundry is more evenly distributed will the spin cycle be performed, at a lower speed, if the laundry is not evenly distributed.</p> <p>If, after about 16 minutes, the laundry is still tangled, the machine will not spin. Therefore, if the laundry is still wet at the end of the cycle, it is advisable to redistribute it manually inside the drum and to select the spin programme.</p>
The machine will not dry or the laundry is not dry enough	The water tap is not open (E10) .	Open the water tap.
	The drain filter is clogged.	Clean the filter.
	The drying time or degree of drying has not been selected.	Select the required time or degree of drying.
	An appropriate drying time has not been chosen.	Select the appropriate drying time suitable for the required degree of drying, according to the type of fabric (cottons or synthetics).
	There is too much laundry inside the appliance.	Reduce the load.

Unsatisfactory washing results

If the laundry looks grey and lime scale is found in the drum

- Too little detergent has been used.
- An unsuitable detergent has been used.
- Stubborn stains have not been treated prior to washing.
- The programme/temperature has not been correctly selected.

If grey stains remain on the laundry

- Laundry stained with ointments, grease or oil has been washed with an insufficient amount of detergent.
- The temperature selected for the wash programme was too low.
- Fabric softener - especially the concentrated type - has come into direct contact with the laundry. Wash these stains immediately and pour fabric softener carefully.

Foam is still visible even after the last rinse

- Modern detergents often produce foam, even in the last rinse. However the laundry has been completely rinsed.

White residue is left on the laundry

- This is due to insoluble components in modern detergents and is therefore not the result of insufficient rinsing. Shake or brush the laundry. In future, it may be better to turn garments inside out before washing them. Check the choice of detergent; try using liquid detergents.

Technical data

Height x Width x Depth	85x60x60 cm
Depth with door opened	101,5 cm
Height adjustment	± 13 mm approx.
Load (depending on programme)	6 kg
Use	domestic
Drum speed during washing	max. 55 rpm
Drum speed during spinning	1400/1200/900/700 rpm
Water pressure	0,05-0,8 MPa

CE This appliance complies with the following EC directives:

- 73/23/EEC of 19.2.1973 "Low voltage directive", including directive 93 / 68 / EEC
- 89/336/EEC of 3.5.1989 "Electromagnetic Compatibility Directive".

Service

In the section "Something not working?" some problems that can be solved by yourself are listed. Read this section in the event of problems. If you are not able to find a solution, contact the Service centre.

In all cases, explain your problem carefully, in order to facilitate troubleshooting: the engineer will be able to decide whether a service call is necessary.

Take note of the serial number (Ser. No.) and the product number (Prod. No.) indicated on the rating plate.

Ser. No.

Prod. No.

Furthermore, try to specify, as precisely as possible:

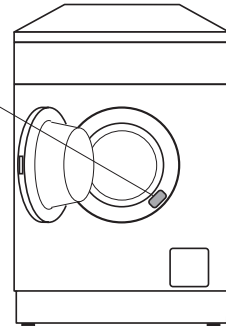
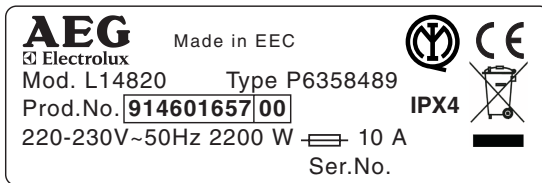

- The symptoms of the fault
- When the fault occurs
- The alarm code displayed

When can a service visit be charged during the guarantee period?

- when it should have been possible to solve the problem by yourself, with the help of the troubleshooting chart (see section "Something not working?")
- when the engineer has to come out several times because he has not been given all the relevant information he needs and so, for example, has to fetch spare parts. Repeated trips can be avoided if you prepare your call to the Service centre as described above.

Instructions for installation and electrical connection



Safety instructions for the installer

- This appliance is heavy, care should be taken when moving it.
- When unpacking the appliance, check that it is not damaged. If in doubt, do not use it and contact the retailer.
- All internal packing must be removed before using the appliance. Serious damage may be caused to the machine or adjacent furniture if the protective transit devices are not completely removed. Refer to the relevant paragraph.
- Any electrical work required to install this appliance must be carried out by a qualified electrician.
- Any plumbing work required to install this appliance must be carried out by a qualified plumber.
- After having installed the machine, check that it is not standing on its electrical supply cable.
- If the appliance is placed on a carpeted floor, ensure that air can circulate freely between the adjustable feet and the floor.
- The installation should comply with local water authority and building regulations requirements.
- Should the appliance power supply cable need to be replaced, this should be carried out by our Service Force Centre.

Dimensions of the appliance

Front view and side view

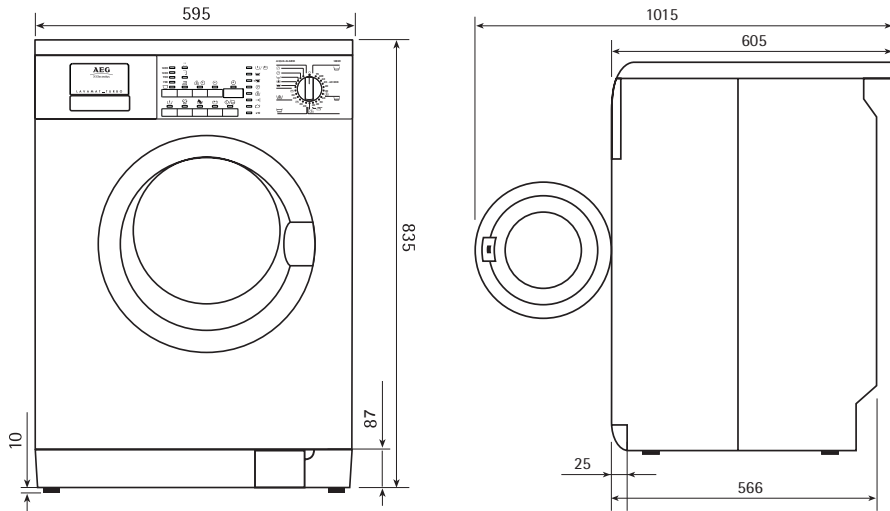

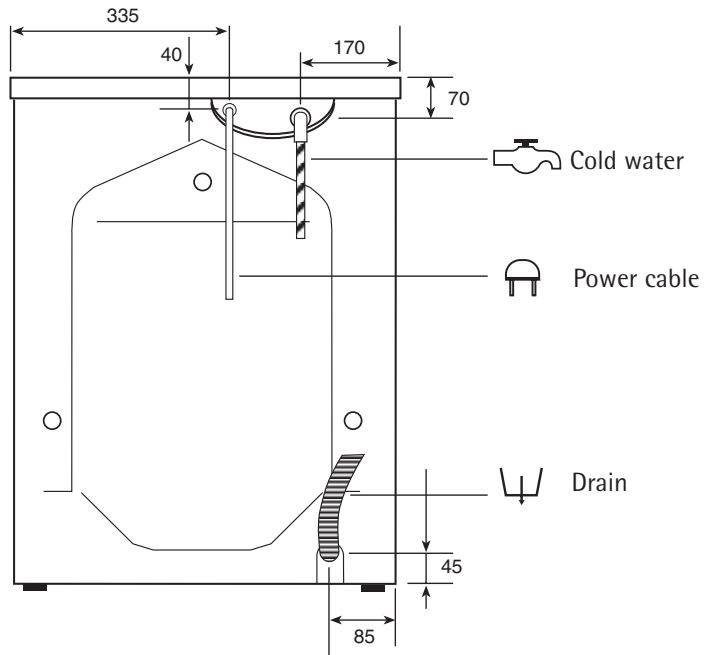

Rear view



Installation

Unpacking

 All transit bolts and packing must be removed before using the appliance.

 Using the supplied spanner, unscrew and remove the 2 rear bottom screws. Slide out the 2 plastic pins. Lay the machine on its back, taking care

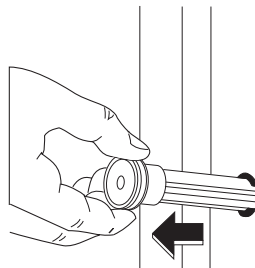
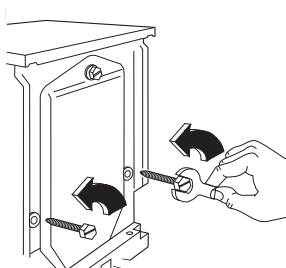

not to squash the hoses. This can be avoided by placing one of the corner packing pieces between the machine and the floor.

 Remove the polystyrene block from the bottom of the machine and release the two plastic bags.

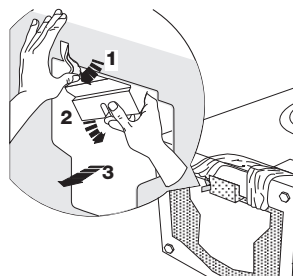

 Carefully slide out the left-hand bag removing it towards the right and then downwards.

 Slide out the right-hand bag removing it towards the left and then upwards.

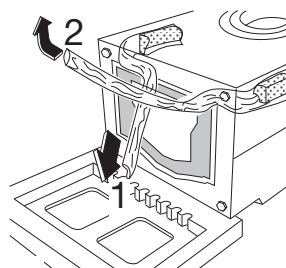

 The bottom cover plate, which can be found inside the machine with the instruction

book, will now need to be fitted. Hook the bottom of the plate «A», into position first. Then push the other end of the plate into position.

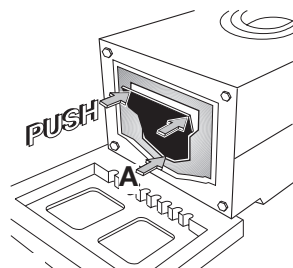

Important!

You can find more detailed instructions regarding the bottom cover assembly in its relative bag.

-  Set the machine upright and remove the remaining rear screw. Slide out the relevant pin.

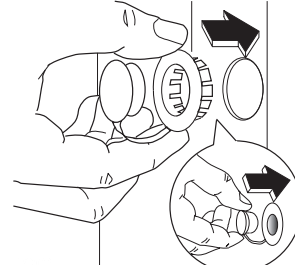
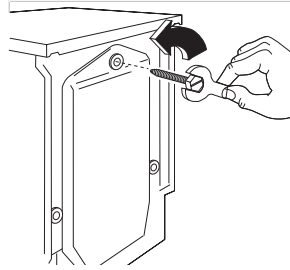

-  Plug the open holes with the plugs which you will find in the plastic bag containing the instruction booklet.

You are advised to keep all transit devices so that they can be refitted if the machine ever has to be transported again.

Positioning

Install the machine on a flat hard floor.

Make sure that air circulation around the machine is not impeded by carpets, rugs etc.

- Before placing it on small tiles, apply a rubber coating.
- Never try to correct any unevenness in the floor by putting pieces of wood, cardboard or similar materials under the machine.
- If it is impossible to avoid positioning the machine next to a gas cooker or coal-burning stove, an insulating panel (85x57 cm) covered with aluminium foil on the side facing the cooker or stove, must be inserted between the two appliances;
- The machine must not be installed in rooms where the temperature can drop below 0.
- The water inlet hose and the drain hose must not be kinked.
- Please ensure that when the appliance is installed, it is easily accessible for the engineer in the event of a breakdown.

Levelling

Carefully level by screwing the adjustable feet in or out. Never place cardboard, wood or similar materials under the machine to compensate for any unevenness in the floor.

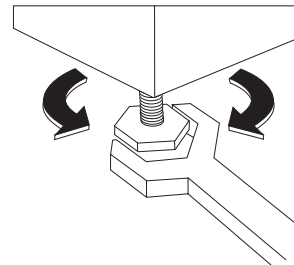

Water inlet

Connect the water inlet hose to a separate tap with a 3/4" thread.

The inlet hose is provided with a water stop device, which protects against damage caused by water leaks in the hose which could develop due to natural ageing of the hose. This fault is shown by a red sector in the window "A". Should this occur, turn the water tap off and refer to your Service Centre to replace the hose.

The other end of the inlet hose which connects to the machine can be turned in any direction. Simply loosen the fitting, rotate the hose and retighten the fitting, making sure there are no water leaks.

The inlet hose must not be lengthened. If it is too short and you do not wish to move the tap, you will have to purchase a new, longer hose specially designed for this type of use.

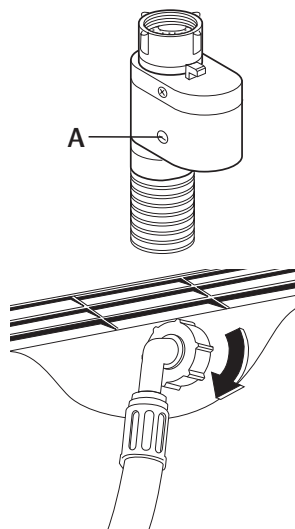

Water drainage

The end of the drain hose can be positioned in three ways:

Hooked over the edge of a sink using the plastic hose guide supplied with the machine. In this case, make sure the end cannot come unhooked when the machine is emptying.

This could be done by tying it to the tap with a piece of string or attaching it to the wall.

In a sink drain pipe branch. This branch must be above the trap so that the bend is at least 60 cm above the ground.

Directly into a drain pipe at a height of not less than 60 cm and not more than 90 cm.

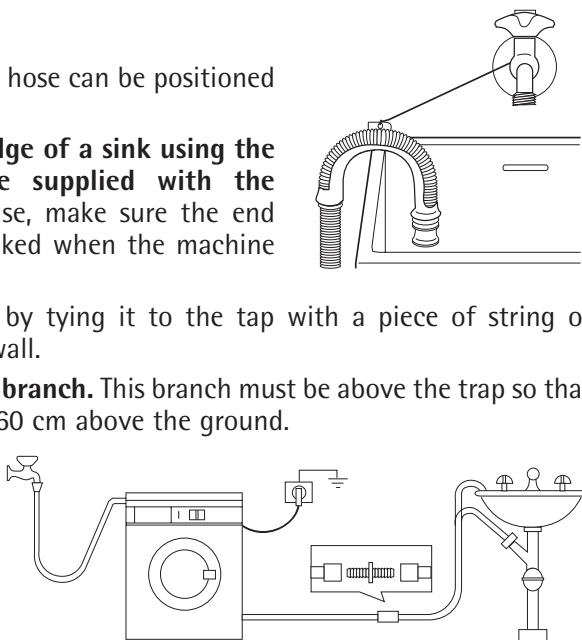

The end of the drain hose must always be **ventilated**, i.e. the inside diameter of the drain pipe must be larger than the outside diameter of the drain hose.

The drain hose must not be kinked. Run it along the floor; only the part near the drainage point must be raised.

Electrical connection

This machine is designed to operate on a 220-230 V, single-phase, 50 Hz supply.

Check that your domestic electrical installation can take the maximum load required (2.2 kW), also taking into account any other appliances in use.

Connect the machine to an earthed socket.



The manufacturer does not accept any responsibility for damage or injury through failure to comply with the above safety precaution.

Permanent connection

In the case of a permanent connection it is necessary that you install a double pole switch between the appliance and the electricity supply (mains), with a minimum gap of 3 mm between the switch contacts and of a type suitable for the required load in compliance with the current electrical regulations.

The switch must not break the yellow and green earth cable at any point.

This operation must be performed by a qualified electrician.

Important: The power supply cable must be easily accessible after installing the machine.

AEG Hausgeräte GmbH
Postfach 1036
D-90327 Nürnberg

<http://www.aeg.hausgeraete.de>

© Copyright by AEG

132986450-01-0205 Subject to change without notice
Salvo modificaciones

 **From the Electrolux Group. The world's No. 1 choice.**

The Electrolux Group is the world's largest producer of powered appliances for kitchen, cleaning and outdoor use. More than 55 million Electrolux Group products (such as refrigerators, cookers, washing machines, vacuum cleaners, chain saws and lawn mowers) are sold each year to a value of approx. USD 14 billion in more than 150 countries around the world.

Free Manuals Download Website

<http://myh66.com>

<http://usermanuals.us>

<http://www.somanuals.com>

<http://www.4manuals.cc>

<http://www.manual-lib.com>

<http://www.404manual.com>

<http://www.luxmanual.com>

<http://aubethermostatmanual.com>

Golf course search by state

<http://golfingnear.com>

Email search by domain

<http://emailbydomain.com>

Auto manuals search

<http://auto.somanuals.com>

TV manuals search

<http://tv.somanuals.com>