

# F-419 19" TFT LCD PANEL

User manual  
Mode d'emploi  
Benutzerhandbuch  
Manual de usuario



# Table of Content

<b>Precautions .....</b>	<b>2</b>
<i>Installation.....</i>	<i>2</i>
<i>Power connection.....</i>	<i>2</i>
<i>Using the Tilt.....</i>	<i>2</i>
<i>Maintenance.....</i>	<i>2</i>
<i>Transporting the monitor.....</i>	<i>3</i>
<b>Getting Started .....</b>	<b>3</b>
<i>Package contents.....</i>	<i>3</i>
<i>Installing and Removing the Base.....</i>	<i>4</i>
<i>Identifying parts and controls.....</i>	<i>5</i>
<i>Setup.....</i>	<i>6</i>
<b>Customizing your Monitor .....</b>	<b>8</b>
<i>Working with OSD Groups.....</i>	<i>8</i>
<i>Brightness &amp; Contrast .....</i>	<i>8</i>
<i>Horizontal &amp; Vertical Position.....</i>	<i>8</i>
<i>Sharpness.....</i>	<i>8</i>
<i>OSD Transparency.....</i>	<i>9</i>
<i>Phase &amp; Clock.....</i>	<i>9</i>
<i>Auto and Input Select.....</i>	<i>9</i>
<i>Horizontal &amp; Vertical OSD Position .....</i>	<i>9</i>
<i>Mode Text/Graphics .....</i>	<i>9</i>
<i>Recall .....</i>	<i>9</i>
<i>Selecting a Language.....</i>	<i>9</i>
<i>Selecting a Color Temperature setting.....</i>	<i>10</i>
<i>Exit .....</i>	<i>10</i>
<b>Troubleshooting.....</b>	<b>11</b>
<b>LCD Panel Display Technical Features and Specifications.....</b>	<b>12</b>
<b>Interface Frequency.....</b>	<b>13</b>
<b>Supported Timing List .....</b>	<b>14</b>
<b>Regulations .....</b>	<b>16</b>
<i>FCC compliance.....</i>	<i>16</i>
<i>TCO'99.....</i>	<i>17</i>

# *Precautions*

## **Installation**

- Do not cover or block the ventilation ports on the rear of the monitor.
- Do not install the monitor close to heat sources such as radiators or air ducts, or in a location exposed to direct sunlight, excessive dust, mechanical vibration, or shock.

## **Power connection**

- Use the correct power cord for your local voltage.
- Use an accessible outlet close to the monitor.
- Do not allow anything to rest on the power cable.
- Disconnect the power cable from the power supply if:
  - You will not use the monitor for an extended period.
  - The cable is damaged or frayed.
  - The monitor has been dropped or the cabinet damaged.
  - A distinct change in performance indicates a need for servicing.

## **Using the Tilt**

- Use the monitor's tilt capability to adjust its vertical orientation to an appropriate position. Grasp the top corners of the monitor with both hands and tilt to the desired angle.

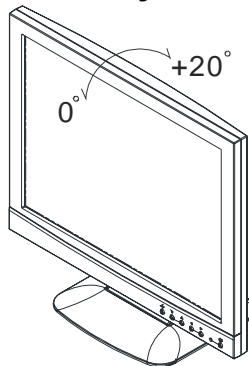

## **Maintenance**

- Clean the cabinet and controls with a soft cloth lightly moistened with a mild detergent solution. Do not use any abrasive materials or solvents such as alcohol or benzene.
- Do not rub, touch, or tap the surface of the screen with sharp or abrasive items such as pens or screwdrivers, as the screen may scratch.

- Do not insert objects or spill liquids into the ventilation ports on the monitor's rear, as fire, electric shock, and/or unit failure may result.

## Transporting the monitor

When transporting the monitor for repair or shipment, use the original carton and packing materials.

## *Getting Started*

### Package contents

Before beginning, ensure that the carton contains the following items:

- Monitor
- Base

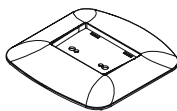

- Power cord



- Signal Cable

Analog: D-SUB Cable



Digital: DVI Cable

- Floppy/CD-ROM containing Windows® information file



- This manual

## Installing and Removing the Base

To attach the base to the monitor, do the following:

When you open the packing carton, remove the LCD monitor base, and place it on a desk or table. Then attach the LCD monitor to the base.

***Note: Make sure that the monitor's base pegs and the base stand are firmly locked together.***

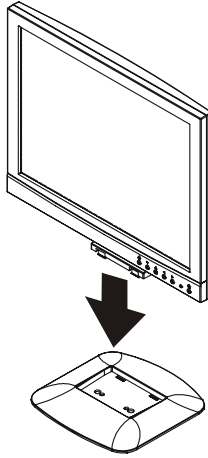

To remove the base, turn the monitor on its side or up-side down, push the pegs to lift base off monitor.

## Identifying parts and controls

The center front panel of the monitor carries the control array.



FRONT VIEW

The controls are, from left to right:



### **AUTO button**

Automatically adjusts the picture and performance. The AUTO function should be used the first time you use the monitor and after changing the resolution and/or refresh rate of the input signal.

*Note: 1) It must be pressing the AUTO button over 1 second to execute auto adjustment.*

*2) If the OSD is acting, this key function will same as down button.*



### **UP button**

Navigates within the display



### **DOWN button**

Navigates within the display



### **LEFT button**

Activates the OSD and navigates within the display



### **RIGHT button**

Activates the OSD and navigates within the display

### **LED indicator**

Indicates the monitor's operational mode; green for regular operation, and amber for power saving mode.



### **Power switch**

Turns the monitor on and off

## Setup

Follow these directions to correctly set up your monitor.

1. Remove all packing materials and wrapping from the monitor
2. Place the monitor in its desired location. Ensure that there is space around the monitor, especially the rear area.
3. With the computer turned off, connect the signal cable to the VGA port or DVI Port on your PC. Make sure connection is secure.

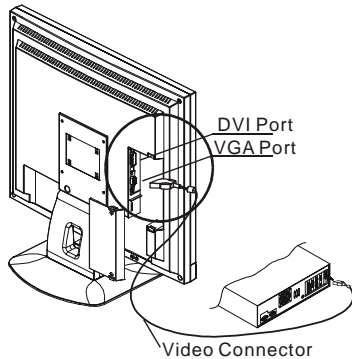

4. To connect the power cord to the Monitor AC socket.
5. Connect the plug Pin of power cord to an AC power source.

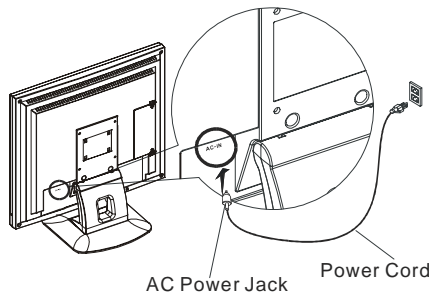

6. Turn on the computer.
7. Press the soft power switch on the monitor. The display should appear. If no display appears, check **Troubleshooting** in this manual.
8. Ensure that your computer display is set at 1024X768 pixels and 60Hz. Press the AUTO button <sup>4</sup>/<sub>5</sub> exceed 1 second. The monitor optimizes the display automatically.

**Note: The monitor is compliant with VESA FPM/PMI standards and can be wall- or arm-mounted. Before wall-mounting or arm-mounting, please disassemble the monitor stand first.**

9. Unscrew screws of the hinge bracket ❶
10. Remove the stand from LCD monitor ❷

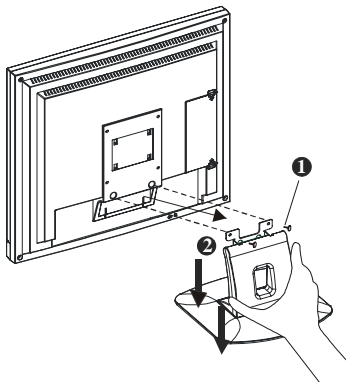

11. The rear of this LCD display has four integrated 4 mm, 0.7 pitch threaded nuts, as well as four 5 mm access holes in the plastic covering as illustrated below. These specifications meet the **VESA Flat Panel Monitor Physical Mounting Interface Standard** (paragraphs 2.1 and 2.1.3, version 1, dated 13 November 1997).

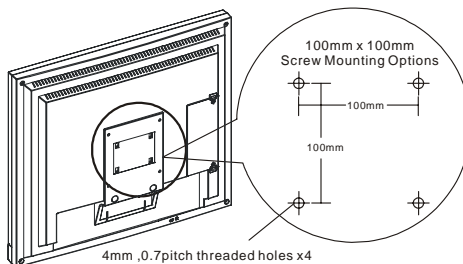



## Customizing your Monitor

The On Screen Display (OSD) system provides a full range of customizable tools to optimize your display.

**Important:** *While full customization is available, we strongly recommend using the AUTO settings, which are preset to fully optimize your monitor's performance. Simply presses the AUTO button  exceed 1 second to engage the AUTO settings. It is also recommended that you execute the AUTO function following any change made to your display from your computer.*

### Working with OSD Groups

Press any of the LEFT , or RIGHT  buttons to open the OSD window.

#### OSD Function Menu

To access OSD Main menu, simply press one of the Function Select control buttons, and the menu diagram will pop up on the screen as shown on Fig. 1-1:



Continue pressing the Function Select buttons (left/right) to scroll through the entire menu items ,then press Adjustment Control buttons (up/down) to adjust content of selected item.





### Attention

Firmware revision may have been updated into a latest version while the version number shown on all OSD menus in this manual will stay as Ver. 1.00.



### Brightness & Contrast /

1. To fine-tune the monitor's brightness and contrast, select the pertinent item from the menu.
2. Use the UP  and DOWN  buttons to set the display as desired on the 0-100 scales that appears at the bottom of the window.



### Horizontal & Vertical Position /

1. To fine-tune the display's position on the monitor screen, select the pertinent item from the menu.
2. Use the UP  and DOWN  buttons to set the display as desired on the 0-100 scales that appears at the bottom of the window.



### Sharpness

1. This function let's you select the images sharpness. Five selections are available. A smoother setting is more suitable for pictures, while a sharper setting is more suitable for text.
2. Use the UP  and DOWN  buttons to set the display image sharpness as desired.



## OSD Transparency

1. This function let's you set the transparency of the OSD menu. The transparency is adjustable from 0 to 10. 11 scales are available.
2. Use the UP  and DOWN  buttons to set the transparency of OSD manu as desired.



## Phase & Clock /

1. To fine tune picture performance to compensate for drifts in the computer signal, select the pertinent item from the menu.
2. Use the UP  and DOWN  buttons to set the display as desired that appears at the bottom of the window.



## Auto and Input Select

1. To enable the monitor's Auto Adjust capability, select Auto Adjust from the menu.
2. Use the DOWN  button to toggle Auto Adjustment, use Analog Input and use Digital Input.
3. Use the UP  button to run selecting function.

## Horizontal & Vertical OSD Position /



1. To position the OSD window to your preference, select OSD Position from the menu.
2. Use the UP  and DOWN  buttons to move the display through its available positions.

## Mode Text/Graphics



1. To choose between the monitor's automatic Sharpness optimization for Text or Graphic use, select Mode Text/Graphic from the menu.
2. Use the UP  and DOWN  buttons to toggle between TEXT and GRAPHIC as desired at the bottom of the window.

*Note: For better performance, please change to "Text" mode when display resolution is set at 720 x 400 and change to "Graphics" mode when display resolution is set to 640 x 400.*

## Recall

1. To return the monitor's settings to the factory default, select Recall from the menu.
2. Use the UP  and DOWN  buttons to toggle between YES and NO as desired at the bottom of the window.



## Selecting a Language

1. To select the language in which you wish the OSD to appear, select Language from the menu.
2. Use the UP  and DOWN  buttons to toggle through the available languages shown at the bottom of the window.

## Selecting a Color Temperature setting

The following conditions are recommended for the available settings:

Setting	Use
9300K	General Use
6500K	Color Management
USER	User color setting
Auto Color	Auto adjust to best ADC gain value.

1. Select the desired setting from the menu.
2. Selecting a User-Defined Color Balance Setting.
3. You can fine-tune the red/green/blue picture settings according to your preference or specific application.
4. Select the pertinent color category from the menu.
5. Use the UP  and DOWN  buttons to set the display as desired on the 0-100 scale or run auto color adjust function when select to auto color function.

## Exit

Select EXIT from the menu to exit the OSD menu.

## Troubleshooting

This LCD Monitor has pre-adjusted using factory standard VGA timings. Due to the output timing differences among various VGA cards in the market, users may initially experience an unstable or unclear display whenever a new display mode or new VGA card is selected.

### Attention

This LCD Monitor Supports Multiple VGA Modes.

Refer to the Standard Timing Table for a listing of modes supported by this LCD Monitor.

PROBLEM	Check Items
<ul style="list-style-type: none"> <li>• <b>Picture is unclear and unstable</b></li> </ul>	<p>The picture is unclear and unstable, please perform the following steps:</p> <ol style="list-style-type: none"> <li>1. Enter PC to "Shut Down Windows" status while you're in MS-Windows environment.</li> <li>2. Check the screen to see if there's any black vertical stripes appear. If there are, take advantage of the "Clock" function in OSD menu and adjust (by increment or decrement numbers) until those bars disappear.</li> <li>3. Move to "Phase" function in OSD menu again and adjust the monitor screen to its most clear display.</li> <li>4. Click "No" on "Shut Down Windows" and back to the normal PC operating environment.</li> </ol>
<ul style="list-style-type: none"> <li>• <b>There is no picture on LCD Monitor</b></li> </ul>	<p>If there's no picture on the LCD Monitor, please perform the following steps:</p> <ol style="list-style-type: none"> <li>1. Make sure the power indicator on the LCD Monitor is ON, all connections are secured, and the system is running on the correct timing. Refer to "Supported Timing List" for information on timing.</li> <li>2. Turn off the LCD Monitor and then turn it back on again. If there is still no picture, press the Adjustment Control button several times.</li> <li>3. If step 2 doesn't work, connect your PC system to another external CRT. If your PC system Functions properly with a CRT Monitor but it does not function with the LCD Monitor, the output timing of the VGA card may be out of the LCD's synchronous range. Please change to an alternative mode listed in the Supported Timing List or replace the VGA card, and then repeat steps 1 and 2.</li> </ol>
<ul style="list-style-type: none"> <li>• <b>There is no picture on LCD Monitor</b></li> </ul>	<p>If you have chosen an output timing that is outside of the LCD Monitor's synchronous range (Horizontal: 24 ~ 80 KHz and Vertical: 49 ~ 75 Hz), the OSD will display a "<b>Out of Range</b>" message. Choose a mode that is supported by your LCD Monitor.</p> <p>Also, if the signal cable is not connected to LCD monitor at all or properly, the monitor screen will display a message "<b>No Input Signal</b>".</p>

## *LCD Panel Display Technical Features and Specifications*

<b>Panel</b>	Screen Size	19" (48cm) diagonal
	Pixel Format	1280 x 1024 vertical strip
<b>Monitor</b>	Display Colors	16.7M with FRC or Dithering
<b>Input Signal</b>	Frequency	Horizontal: 24kHz - 80kHz, Vertical: 49Hz - 75Hz
	Max. Pixel Clock	135MHz
<b>Compatibility</b>	PC	Max to 1280 x 1024 @ 75Hz
<b>Connector</b>	Analog	15-Pin Mini D-Sub
	Digital	24 – Pin DVI
	Power	3-Pin AC Inlet
<b>Tilt</b>	Tilt Angle	0° - +20°
<b>Dimensions (W x H x D)</b>	Net	422 x 410.5 x 220mm (16.6" x 16.1" x 8.7")
<b>Weight</b>	Net	6.5Kg (14.3lb)
<b>Regulations</b>	Safety	UL/CUL, EPA, CB, TUV/GS, Nordic, NUTEK, TCO99, ISO 13406-2
	EMI	FCC, CE, BSMI, VCCI
	VESA	DDC1/2B, DPMS
<b>Power</b>	AC	100 ~ 240V, 50 /60Hz
	Consumption	<50 Watts (On), < 3 Watts (Stand-by), < 3 Watts (Suspend), 3 Watts (Off)

## ***Interface Frequency***

The following frequency range is the working period. If the entered mode between below period but not match the frequency of supported timing, display optimization not be assured. If the entered mode is out of the working period, the display will be blanking (just show “out of range”) then go to power saving.

Basically, mode judgment is regardless the sync polarity except both or more modes that are all belong to the supported timing list and could be judged by sync polarity only.

At the meantime, real entered frequency of the supported timing is not requested exactly. Normalization of VGA card’s deviation will be acceptable.

- Horizontal Frequency            24KHz ----80KHz
- Vertical Frequency                49Hz -----75Hz

## Supported Timing List

If the selected timing is NOT included in table below, this LCD monitor will use the most suitable available timing.

TIMING	FH(KHZ) FV(HZ)	SYNC POLARITY	TOTAL (DOT /LINE)	ACTIVE (DOT /LINE)	SYNC WIDTH (DOT/ LINE)	FRONT PORCH (DOT/ LINE)	BACK PORCH (DOT/LINE)	PIXEL FOREQ (MHZ)
640x350 VGA-350	31.469	+	800	640	96	16	48	25.175
	70.087	-	449	350	2	37	60	
640x350 AIC-350-50Hz	31.469	+	800	640	96	16	48	25.175
	50.03	--	629	350	2	127	150	
640x350 AIC-350-60Hz	31.469	+	800	640	96	16	48	25.175
	59.94	--	525	350	2	75	98	
640x400 AIC-400-50Hz	31.469	--	800	640	96	16	48	25.175
	50.03	+	629	400	2	102	125	
640x400 AIC-400-60Hz	31.469	--	800	640	96	16	48	25.175
	59.94	+	525	400	2	50	73	
640x400 NEC PC9801	24.83	-	848	640	64	64	80	21.05
	56.42	-	440	400	8	7	25	
640x400 VGA-GRAPH	31.469	-	800	640	96	16	48	25.175
	70.087	+	449	400	2	12	35	
640x400 NEC PC9821	31.5	-	800	640	64	16	80	25.197
	70.15	-	449	400	2	13	34	
640x480 VESA-PAL	31.469	-	800	640	96	16	48	25.175
	50.030	-	629	480	2	62	85	
640x480 VGA-480	31.469	-	800	640	96	16	48	25.175
	59.94	-	525	480	2	10	33	
640x480 APPLE MAC-480	35.00	-	864	640	64	64	96	30.24
	66.67	-	525	480	3	3	39	
640x480 VESA-480-72Hz	37.861	-	832	640	40	16	120	31.5
	72.809	-	520	480	3	1	20	
640x480 VESA-480-75Hz	37.5	-	840	640	64	16	120	31.5
	75	-	500	480	3	1	16	
720x400 VGA-400-TEXT	31.469	-	900	720	108	18	54	28.322
	70.087	+	449	400	2	12	35	
720x400 AIC-400-50Hz	31.469	--	900	720	108	18	54	28.322
	50.03	+	629	400	2	102	125	
720x400 AIC-400-60Hz	31.469	--	900	720	108	18	54	28.322
	59.94	+	525	400	2	50	73	
832x624 APPLE MAC-800	49.725	-	1152	832	64	32	224	57.2832
	74.55	-	667	624	3	1	39	
800x600 SVGA	35.156	+	1024	800	72	24	128	36
	56.25	+	625	600	2	1	22	
800x600 VESA-600-60Hz	37.879	+	1056	800	128	40	88	40
	60.317	+	628	600	4	1	23	
800x600 VESA-600-72Hz	48.077	+	1040	800	120	56	64	50
	72.188	+	666	600	6	37	23	
800x600 VESA-600-75Hz	46.875	+	1056	800	80	16	160	49.5
	75	+	625	600	3	1	21	

TIMING	FH(KHZ) FV(HZ)	SYNC POLARITY	TOTAL (DOT /LINE)	ACTIVE (DOT /LINE)	SYNC WIDTH (DOT/ LINE)	FRONT PORCH (DOT/ LINE)	BACK PORCH (DOT/LINE)	PIXEL FOREQ (MHZ)
1024x768 XGA	48.363	-	1344	1024	136	24	160	65
	60.004	-	806	768	6	3	29	
1024x768 COMPAQ-XGA	53.964	+	1328	1024	176	16	112	71.664
	66.132	+	816	768	4	8	36	
1024x768 VESA-768-70Hz	56.476	-	1328	1024	136	24	144	75
	70.069	-	806	768	6	3	29	
1024x768 VESA-768-75Hz	60.023	+	1312	1024	96	16	176	78.75
	75.029	+	800	768	3	1	28	
1024x768 APPLE MAC-768	60.24	-	1328	1024	96	32	176	80
	75.02	-	803	768	3	3	29	
1152x864 (60Hz)	54.054	+	1480	1152	96	40	192	80
	59.270	+	912	864	3	13	32	
1152x864 (70Hz)	63.851	+	1480	1152	96	32	200	94.499
	70.012	+	912	864	3	1	44	
1152x864 (75Hz)	67.50	+	1600	1152	128	64	256	108.00
	75.00	+	900	864	2	2	32	
1152x900 VG828-900-66Hz	61.795	--	1504	1152	128	30	194	92.94
	65.95	--	937	900	4	2	31	
1152x900 VG828-900-76Hz	71.732	--	1472	1152	96	16	208	105.590
	76.068	--	943	900	8	2	33	
1280x960 (60Hz)	60.00	+	1800	1280	112	96	312	108.00
	60.00	+	1000	960	3	1	36	
1280x960 (70Hz)	70.00	+	1800	1280	112	96	312	126.00
	70.00	+	1000	960	3	1	36	
1280x960 (75Hz)	75.00	+	1800	1280	112	96	312	135.00
	75.00	+	1000	960	3	1	36	
1280x1024 VESA-1024-60Hz	64	+	1688	1280	112	48	248	108
	60	+	1066	1024	3	1	38	
1280x1024 VESA-1024-75Hz	80	+	1688	1280	144	16	248	135
	75	+	1066	1024	3	1	38	

**Note:**

1. When the input display mode is not 1280 x 1024, the image is smoothly expanded to 1280 x 1024 dots with the PW164 scaling engine. After expansion from 650x350, 640x400, 640x480, 720x400, 832x624, 800x600, and 1024x768 resolution, the text may look not so sharp, and the Graphics may look not so proportional.
2. 640x400 56Hz and 1024x768 66Hz modes cannot be supported when Digital (TMDS) input.



## ***Regulations***

### **FCC compliance**

This device complies with Part 15 of the FCC Rules. Operation is subject to the following two conditions: (1) this device may not cause harmful interference, and (2) this device must accept any interference received, including interference that may cause undesired operation.

NOTE: This equipment has been tested and found to comply with the limits for a Class B digital device, pursuant to Part 15 of the FCC Rules. These limits are designed to provide reasonable protection against harmful interference in a residential installation. This equipment generates, uses and can radiate radio frequency energy and, if not installed and used in accordance with the instructions, may cause harmful interference to radio communications. However, there is no guarantee that interference will not occur in a particular installation. If this equipment does cause harmful interference to radio or television reception, which can be determined by turning the equipment off and on, the user is encouraged to try to correct the interference by one or more of the following measures:

- Reorient or relocate the receiving antenna.
- Increase the separation between the equipment and receiver.
- Connect the equipment to an outlet on a circuit different from that to which the receiver is connected.
- Consult the dealer or an experienced radio/TV technician for help.

*WARNING: Any unauthorized modification to this equipment could result in the revocation of the authorization to operate the equipment and void the product warranty.*



## TCO'99

### **Congratulations!**

You have just purchased a TCO'99 approved and labeled product! Your choice has provided you with a product developed for professional use. Your purchase has also contributed to reducing the burden on the environment and also to the further development of environmentally adapted electronics products.

### **Why do we have environmentally labeled computers?**

In many countries, environmental labeling has become an established method for encouraging the adaptation of goods and services to the environment. The main problem, as far as computers and other electronics equipment are concerned, is that environmentally harmful substances are used both in the products and during their manufacture. Since it is not so far possible to satisfactorily recycle the majority of electronics equipment, most of these potentially damaging substances sooner or later enter nature.

There are also other characteristics of a computer, such as energy consumption levels, that are important from the viewpoints of both the work (internal) and natural (external) environments. Since all methods of electricity generation have a negative effect on the environment (e.g. acidic and climate-influencing emissions, radioactive waste), it is vital to save energy. Electronics equipment in offices is often left running continuously and thereby consumes a lot of energy.

### **What does labeling involve?**

This product meets the requirements for the TCO'99 scheme which provides for international and environmental labeling of personal computers. The labeling scheme was developed as a joint effort by the TCO (The Swedish Confederation of Professional Employees), Svenska Naturskyddsforeningen (The Swedish Society for Nature Conservation) and Statens Energimyndighet (The Swedish National Energy Administration).

Approval requirements cover a wide range of issues: environment, ergonomics, usability, emission of electric and magnetic fields, energy consumption and electrical and fire safety.

The environmental demands impose restrictions on the presence and use of heavy metals, brominated and chlorinated flame retardants, CFCs (freons) and chlorinated solvents, among other things. The product must be prepared for recycling and the manufacturer is obliged to have an environmental policy which must be adhered to in each country where the company implements its operational policy. The energy requirements include a demand that the computer and/or display, after a certain period of inactivity, shall reduce its power consumption to a lower level in one or more stages. The length of time to reactivate the computer shall be reasonable for the user.

Labeled products must meet strict environmental demands, for example, in respect of the reduction of electric and magnetic fields, physical and visual ergonomics and good usability.

Below you will find a brief summary of the environmental requirements met by this product. The complete environmental criteria document may be ordered from:

### **TCO Development**

SE-114 94 Stockholm, Sweden

Fax: +46 8 782 92 07

Email (Internet): development@tco.se

Current information regarding TCO'99 approved and labeled products may also be obtained via the Internet, using the address: <http://www.tco-info.com/>

## **Environmental requirements**

### **Flame retardants**

Flame retardants are present in printed circuit boards, cables, wires, casings and housings. Their purpose is to prevent, or at least to delay the spread of fire. Up to 30% of the plastic in a computer casing can consist of flame retardant substances. Most flame retardants contain bromine or chloride, and those flame retardants are chemically related to another group of environmental toxins, PCBs. Both the flame retardants containing bromine or chloride and the PCBs are suspected of giving rise to severe health effects, including reproductive damage in fish-eating birds and mammals, due to the bio-accumulative processes. Flame retardants have been found in human blood and researchers fear that disturbances in foetus development may occur.

The relevant TCO'99 demand requires that plastic components weighing more than 25 grams must not contain flame retardants with organically bound bromine or chlorine. Flame retardants are allowed in the printed circuit boards since no substitutes are available.

### **Cadmium\*\***

Cadmium is present in rechargeable batteries and in the colour-generating layers of certain computer displays. Cadmium damages the nervous system and is toxic in high doses. The relevant TCO'99 requirement states that batteries, the colour-generating layers of display screens and the electrical or electronics components must not contain any cadmium.

### **Mercury\*\***

Mercury is sometimes found in batteries, relays and switches. It damages the nervous system and is toxic in high doses. The relevant TCO'99 requirement states that batteries may not contain any mercury. It also demands that mercury is not present in any of the electrical or electronics components associated with the labeled unit.

### **CFCs (freons)**

The relevant TCO'99 requirement states that neither CFCs nor HCFCs may be used during the manufacture and assembly of the product. CFCs (freons) are sometimes used for washing printed circuit boards. CFCs break down ozone and thereby damage the ozone layer in the stratosphere, causing increased reception on earth of ultraviolet light with e.g. increased risks of skin cancer (malignant melanoma) as a consequence.

### **Lead\*\***

Lead can be found in picture tubes, display screens, solders and capacitors. Lead damages the nervous system and in higher doses, causes lead poisoning. The relevant TCO'99 requirement permits the inclusion of lead since no replacement has yet been developed.

---

\* Bio-accumulative is defined as substances which accumulate within living organisms

\*\* Lead, Cadmium and Mercury are heavy metals which are Bio-accumulative.

## Free Manuals Download Website

<http://myh66.com>

<http://usermanuals.us>

<http://www.somanuals.com>

<http://www.4manuals.cc>

<http://www.manual-lib.com>

<http://www.404manual.com>

<http://www.luxmanual.com>

<http://aubethermostatmanual.com>

Golf course search by state

<http://golfingnear.com>

Email search by domain

<http://emailbydomain.com>

Auto manuals search

<http://auto.somanuals.com>

TV manuals search

<http://tv.somanuals.com>