

Quick Start Guide

English

Simple Steps

To Get Your "Trellis-Ready"*
AeroGarden® 6 Elite+
Up and Growing

* Trellis System not included.
See page 13 for details.

KEEP THIS GUIDE!

Model #: 100633-DSS
Input Voltage: 120V, 60Hz, 1.5A

Date Code:



IMPORTANT SAFETY INSTRUCTIONS

(SAVE THESE INSTRUCTIONS)

When using this AeroGarden6 Elite+ electrical furnishing, basic precautions should always be followed, including the following:

Read all instructions before using this AeroGarden furnishing.

1. To reduce the risk of electric shock, the AeroGarden has a specific plug. Do not change the plug in any way.

DANGER – to reduce risk of electric shock:

2. Always unplug AeroGarden from electrical outlet before cleaning or changing Grow Bulbs (light bulbs).

WARNING – to reduce risk of burns, fire, electric shock, or injury to persons:

3. Unplug AeroGarden from outlet before putting on or taking off parts.
4. Close supervision is necessary when AeroGarden is used by or near children, invalids, or disabled persons.
5. Use AeroGarden only for its intended use as described in instructions. Do not use attachments not recommended by manufacturer.
6. Never operate AeroGarden if it has a damaged cord or plug, if it is not working properly, if it has been dropped and damaged, or if it has been dropped in water. If any of these conditions occur/exist, contact www.aerogardensupport.com or your country's local distributor for instructions.
7. Keep cord away from heated surfaces.
8. Never operate furnishing with air openings blocked. Keep air openings free of lint, hair, and the like.
9. Never drop or insert any object into any electrical openings.
10. Do not use outdoors.
11. Do not operate where aerosol (spray) products are being used or where oxygen is being administered.
12. Do not touch moving parts or hot parts such as pumps, bulbs, reflective surfaces, and the like.
13. To disconnect, remove plug from outlet.
14. Do not place or submerge base, cord, plug, or lamp hood in water or other liquid to clean it.
15. Do not allow water to contact hot light bulbs.
16. Use only approved and supplied parts and accessories. Use only lamp model 100633 (N. America) or 200633 (Europe & Australia) Grow Bulbs with this AeroGarden model. Use of any other kind of accessory is not recommended. Replacement parts can be ordered from www.aerogardensupport.com or from your retailer.
17. Do not use AeroGarden for other than intended purpose.
18. This product is intended for household and residential use only. This product is not approved for commercial applications.
19. Read and follow all important notices on the AeroGarden and in the accompanying literature.
20. If supply cord is damaged, it must be replaced by manufacturer, its service agent, or similarly qualified technician in order to avoid a hazard.
21. Electrical wiring must be in accordance with local regulations.
22. This appliance is not intended for use by persons (including children) with reduced physical, sensory or mental capabilities, or lack of experience and knowledge, unless they have been given supervision or instruction concerning use of appliance by a person responsible for their safety.
23. Children should be supervised to ensure they do not play with the appliance.

SAVE THESE INSTRUCTIONS

1 Quick Start Assembly (No tools required)

A Unpack Your AeroGarden Elite+

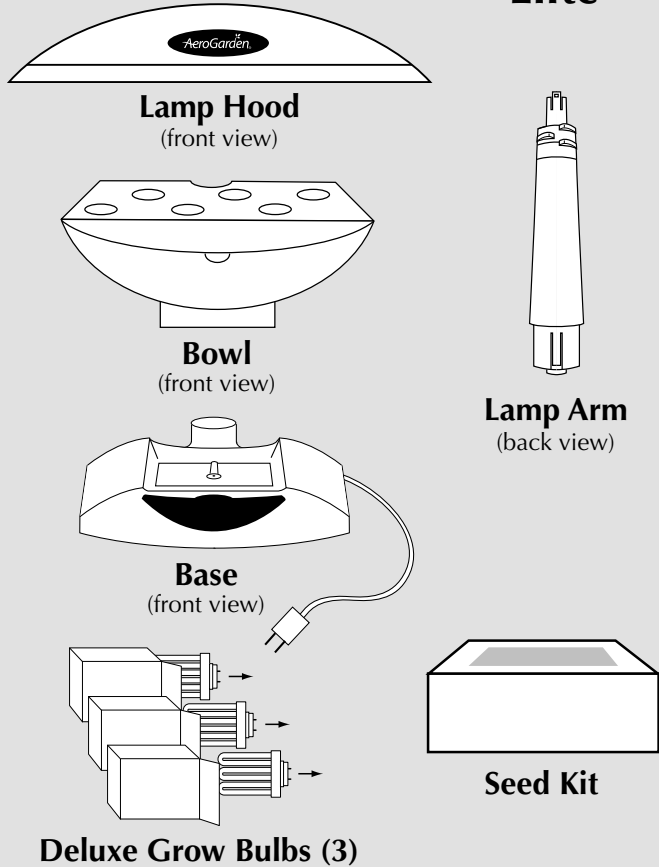

B Insert Lamp Arm into Base

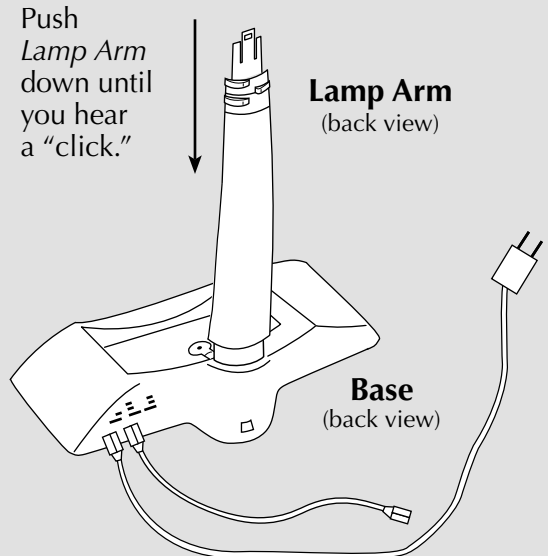

D Plug Lamp Cord into Lamp Hood

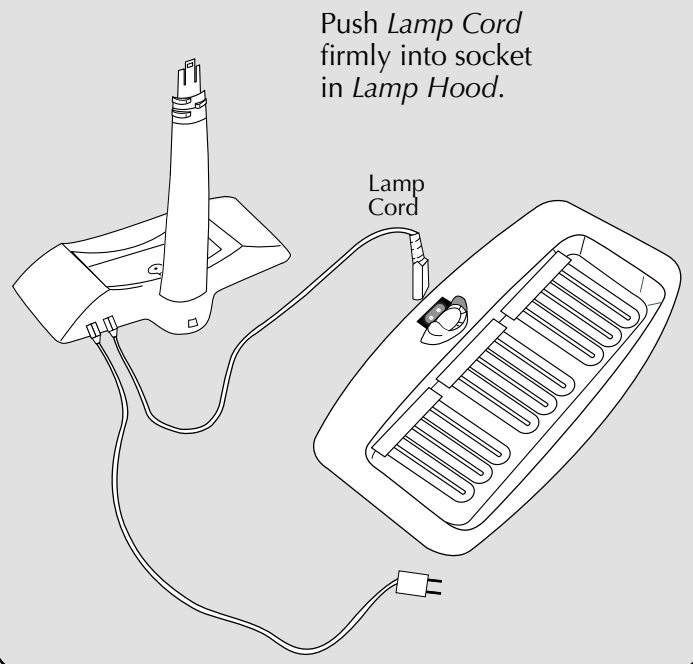

C Insert Grow Bulbs into Lamp Hood

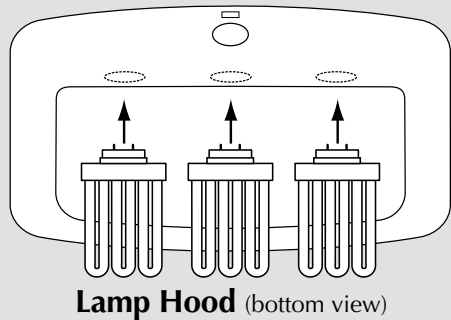

Push straight in.

DO NOT TWIST BULBS!

Remember to replace Grow Bulbs every 6 months.

Instructions Continued On Next Page **➔** 2

1 Quick Start Assembly (continued)

E Place Lamp Hood on Lamp Arm

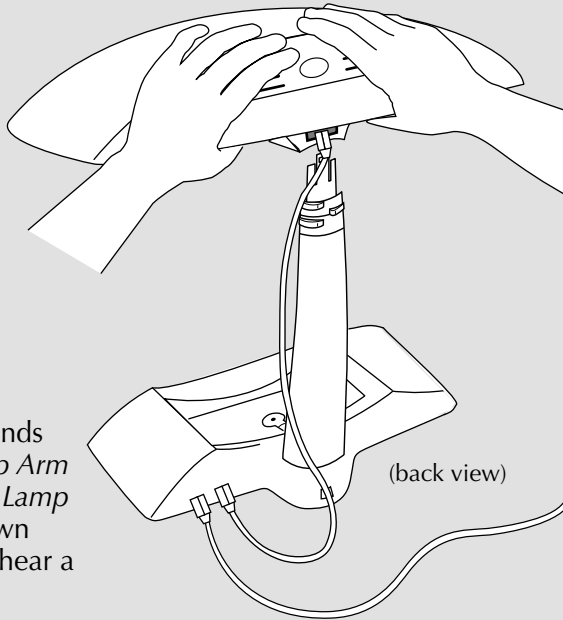

Center hands over *Lamp Arm* and push *Lamp Hood* down until you hear a "click."

F Set Bowl into Base

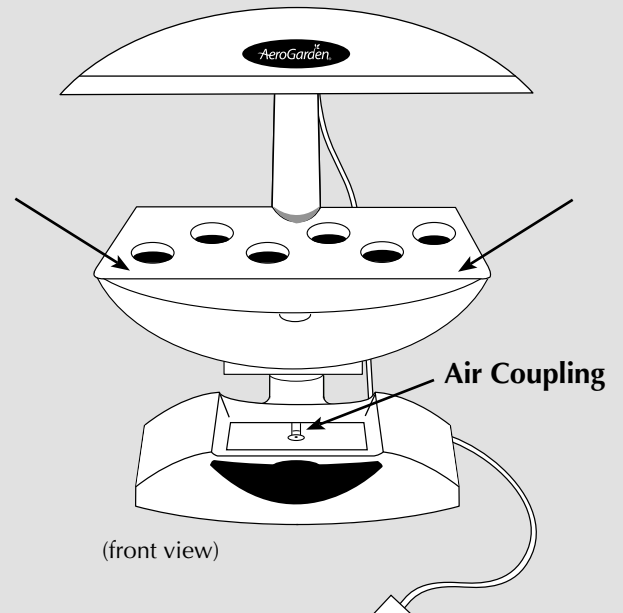

Check to be sure that *Bowl* is securely seated on *Air Coupling* in *Base*.

G Unpack Your AeroGarden⁶ Elite+

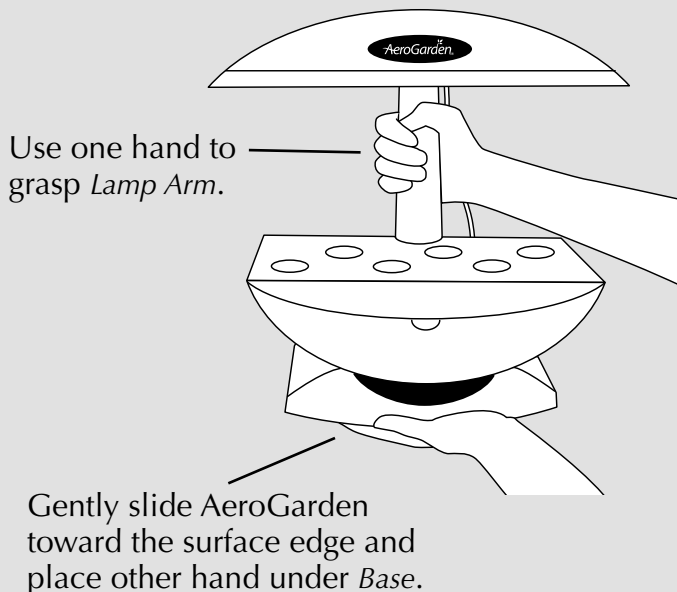

NEED ADDITIONAL HELP?
For supplies and information, visit...
www.aerogardensupport.com

H Place Your Garden

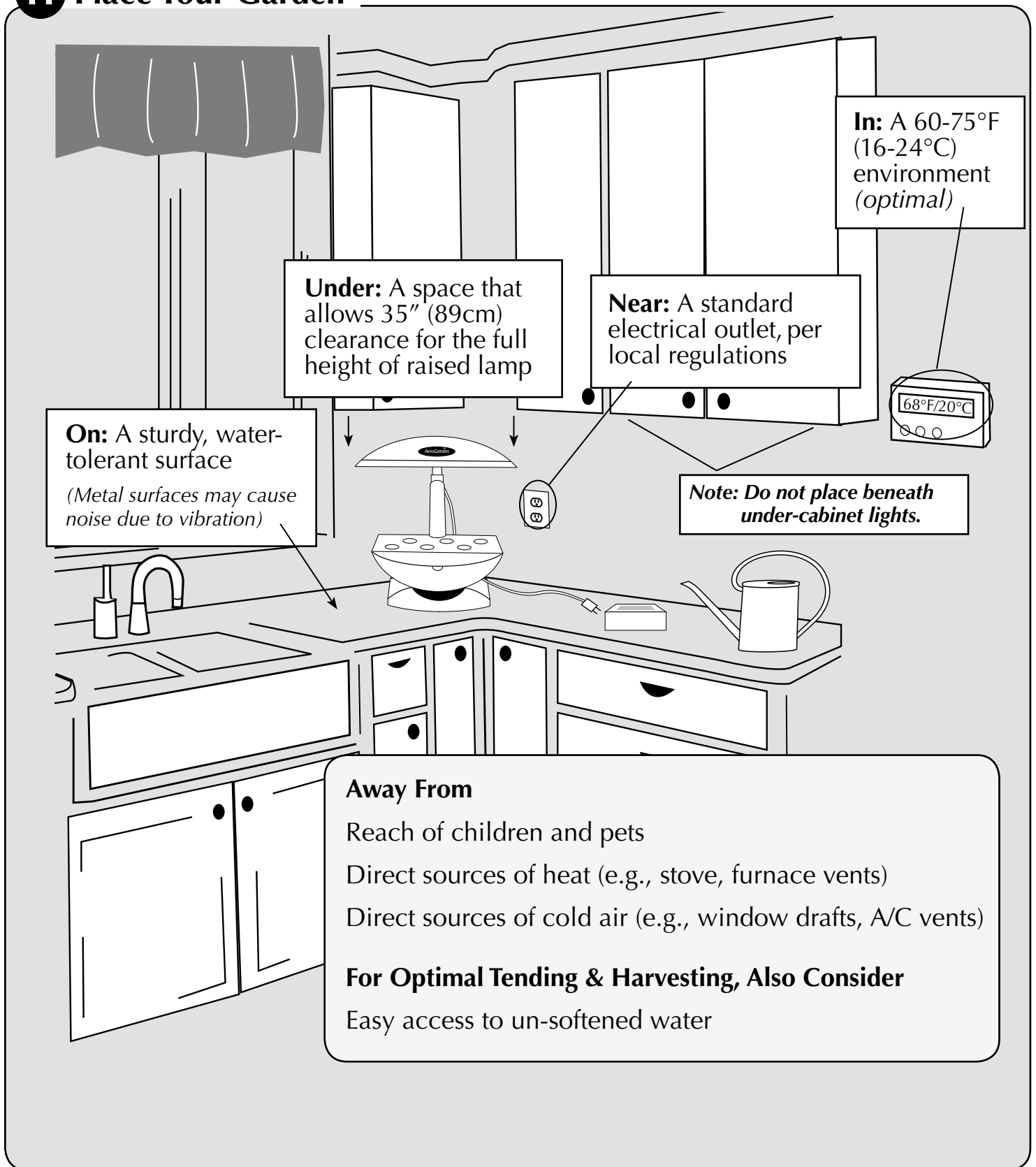

2 Planting Your Garden

A Add Water Using a Spouted Container

Use *room temperature* municipal tap, bottled or purified water. Do not use well or softened water.

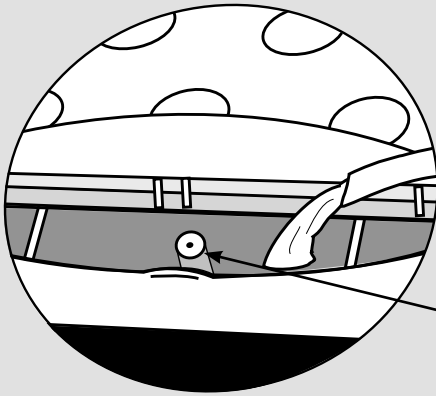

Fill to "*Fill To Here*"
(located inside Bowl)

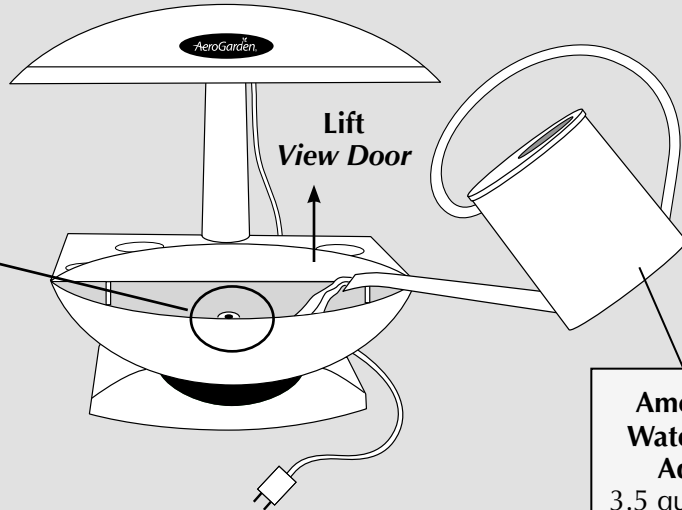

Amount of Water To Be Added:
3.5 quarts or...
3.2 liters

When additional water is needed, "Water Low" light on *Control Panel* will blink. Add water to raise level up to "*Fill To Here*" inside Bowl. It is okay to add water up to "*Fill To Here*" before "Water Low" light blinks.

B Plan Your Garden Layout



Use height information on *Seed Pod Label* to decide where to place each *Seed Pod* in *Grow Surface*.

For best results plant *Seed Pods* labeled...

"Tall" – in *Back* openings (see diagram below)

"Medium" – in *Side* openings

"Short" – in *Front* openings

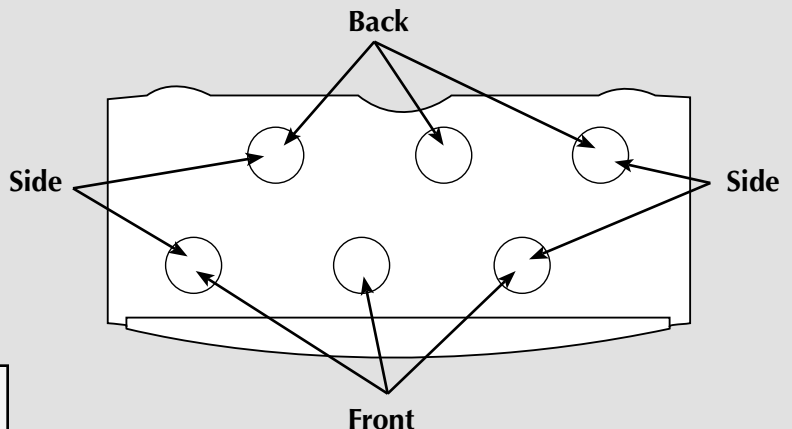

Note: Location of *Seed Pod* in *Grow Surface* does not matter if all plants are the same height.

C Plant Your Garden

If you are planting...

Herbs or Flowers* - arrange *Seed Pods* by plant height (see "Plan Your Garden Layout" on page 5).

Tomatoes or Peppers (6-pod Vegetable Series Kits) - place one *Seed Pod* in each **Front/Side** opening and one *Seed Pod* in the center **Back** opening. Place *Plant Spacers* in remaining openings.

Green Beans, Salad Greens or Live Plants - place *Seed/Plant Pods* anywhere in *Grow Surface*.

Master Gardener Kit* - arrange *Pods* in *Grow Surface* according to plant height.

*Re-arranging may be required as plants grow.

Create a Custom Garden – combine two 3-pod Seed Kits.

Important guidelines to consider when combining *Seed Kits*...

- Only combine kits from the same Series, e.g., flower with flower, herb with herb, etc.
- Consider plant height when combining *Seed Pods* from two 3-pod *Seed Kits*. Refer to "Plan Your Garden Layout" on page 5 when deciding where to place *Seed Pods* in your 6-pod AeroGarden.
- When planting – use BOTH *Starting Nutrients* (two tablets) from each 3-pod *Seed Kit*.
- All Other Feedings – use TWO *Growing Nutrients* (two tablets) from each *Seed Kit* until they are gone.

Plant your AeroGarden. Check to see that...

- A *Seed/Plant Pod* or *Plant Spacer* is in each *Grow Surface* opening.
- *Seed Pod Labels* are facing forward.
- *Seed Pods* are pressed firmly in place.

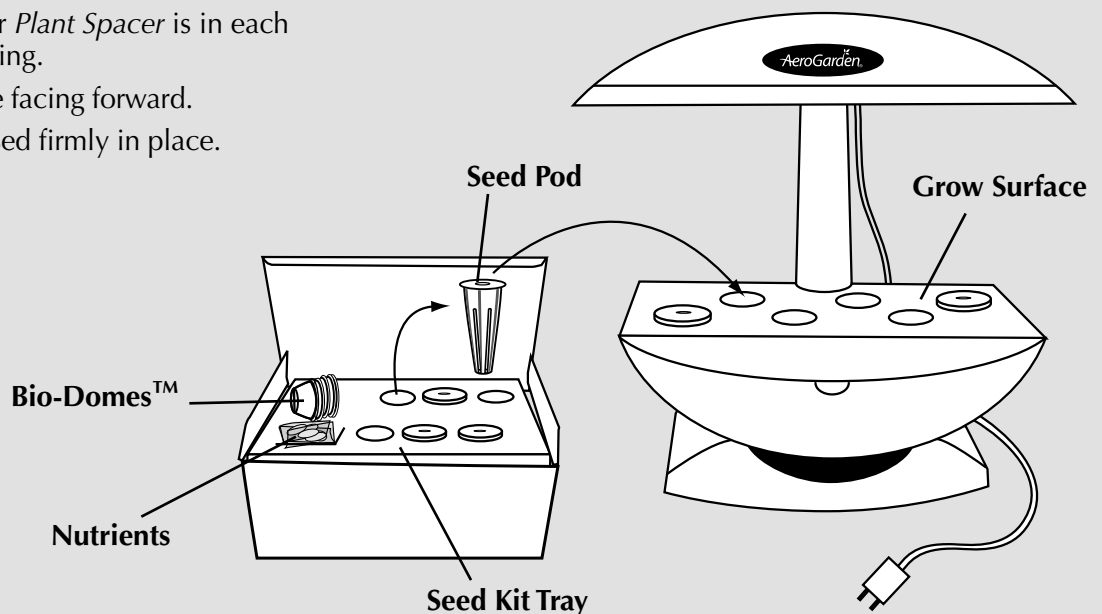

2 Planting Your Garden (continued)

D Place Bio-Domes™ on Seed Pods

Place a *Bio-Dome* on each *Seed Pod*.

Press *Bio-Dome* down until its rim almost touches *Grow Surface*.

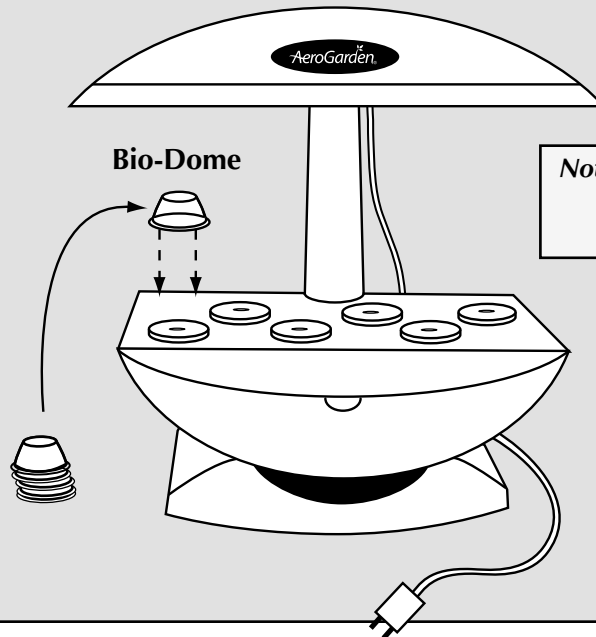

Note: Do not remove Bio-Domes until seeds have sprouted. NEVER REMOVE SEED POD LABELS.

E Add Starting Nutrient Tablets and Record Planting Date

Record Planting Date

Record the date your *Seed/Plant Kit* was planted on front cover of the *Tending & Harvesting Guide*.

Add 2 "Starting Nutrients"* directly into *Bowl*.

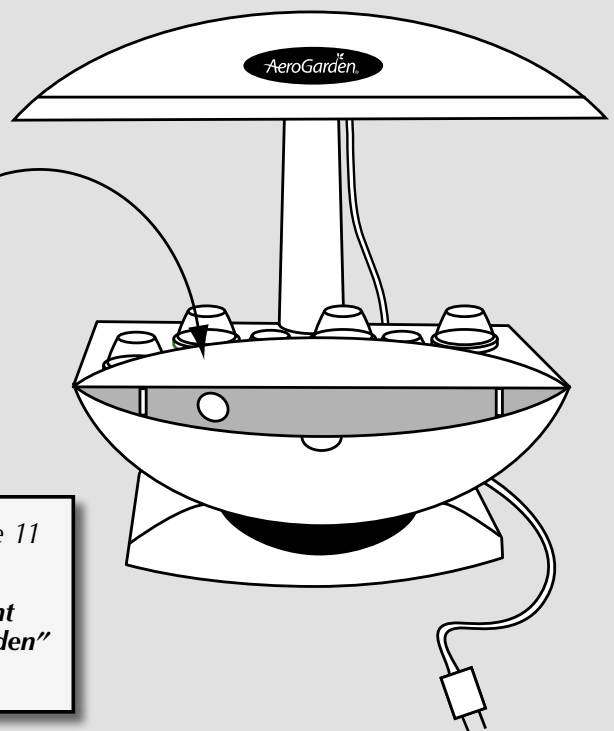

See "Add Nutrients" (*Feed Garden - Basic Feeding*) on page 11 of this guide for additional feeding instructions.

*When combining two 3-pod *Seed Kits*, be sure to use 2 nutrient tablets when feeding your *Garden* (see "Create a Custom *Garden*" on page 6).

3 Starting Your Garden

A Plug Cord into Electrical Outlet

What will happen...

- 1 A green light on *Control Panel* will illuminate.
- 2 *Grow Bulbs* will come on.
Look under Lamp Hood to check that both bulbs are lit.
If not, check to see if:
 - *Grow Bulbs* are properly inserted in *Lamp Hood* (page 2, step 1C).
 - *Lamp Cord* is plugged into *Lamp Hood* (page 2, step 1D).
 - You are getting power through the electrical outlet.
- 3 Air bubbles should be visible inside *Bowl*.
If not, check to see if:
 - *Bowl* is securely seated on *Air Coupling* in Base (see page 3, step 1F).
 - *Bowl* has water up to "Fill To Here."

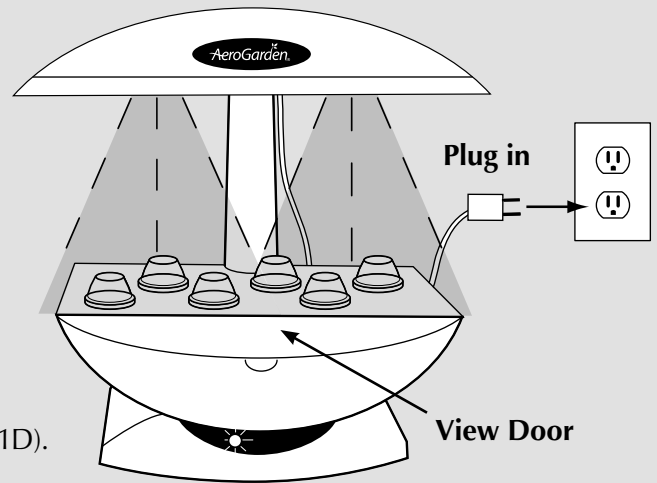

B Select Setting

Press the **SELECT** button until you reach the type of plant you are growing (Vegetables, Salad Greens, etc.).

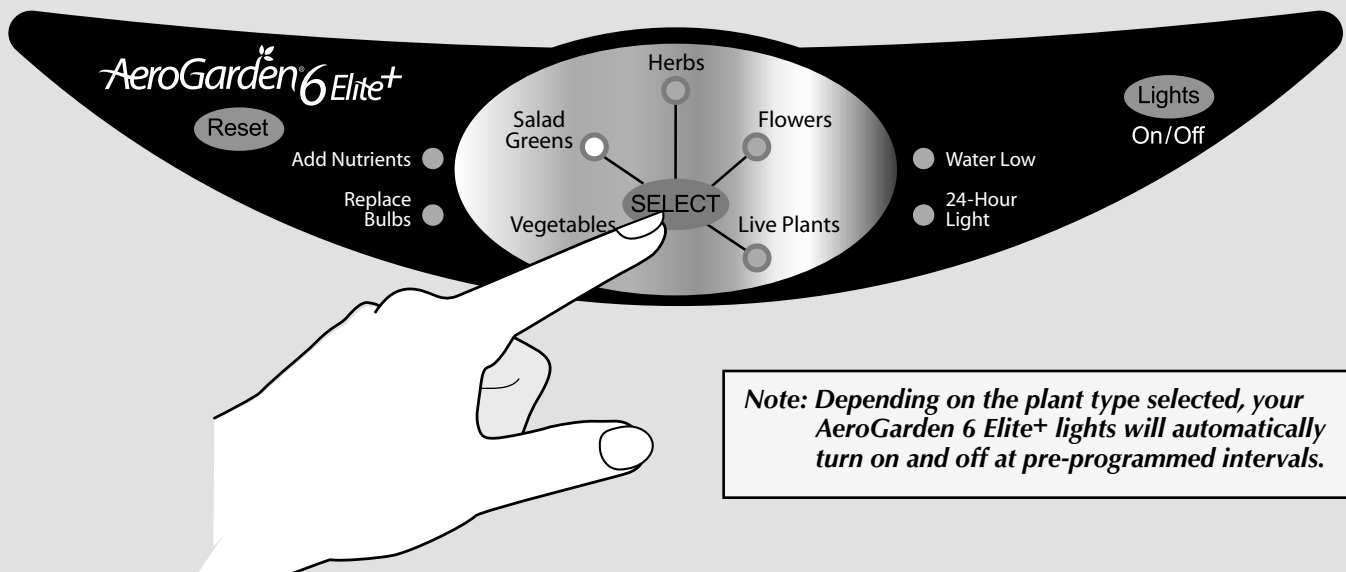

Note: Depending on the plant type selected, your AeroGarden 6 Elite+ lights will automatically turn on and off at pre-programmed intervals.

3 Starting Your Garden (continued)

C Your Light Timer

1 Your Light Timer is Set To Start Growing Your Plants...*Starting Now!*

2 If You Would Like to Change the Time of Day Your Lights Go Off...
See page 10.

- Your lights will stay on for **about 16 hours** and will shut off for **about 8 hours**.*
- Your lights will come on every day at the time you plugged in your AeroGarden 6 Elite+.*

**Except when using "24-Hour Light" setting (see below), which sets lights to be on for 24 hours.*

AeroGarden 6 Elite+ "24-Hour Light" Setting

The "24-Hour Light" setting allows you to override the built-in light timer and keep the lights on 24 hours a day. You can also customize the amount of light your plants receive by manually turning lights on and off using the "Lights" button, or setting automatic on/off times, using a standard light timer.*

Use the "24-Hour Light" setting when growing plants that thrive with continual light and moisture, such as leafy greens and some herbs.

For the more experienced gardener, the "24-Hour Light" setting provides added flexibility when planting a custom garden. You are no longer limited to the pre-programmed light schedules associated with each plant type (such as Vegetables, Herbs, etc.).

NOTE: *The "24-Hour Light" setting is not recommended for Flower or Vegetable plants – they require a daily dark period to produce flowers.*

AeroGarden 6 Elite+ – "24-Hour Light" Setting

- Press and release "Select" until light next to "24-Hour Light" is illuminated.
- To exit "24-Hour Light" setting, simply push "Select" button.

**Not included. If you use a light timer to turn lights on and off, the nutrient timer and pump will stop whenever lights are OFF. Both will start up again when lights turn back on.*

Nutrient timer does not record the time elapsed when timer is off. To ensure your plants are fed every 2 weeks, we recommend keeping track of your feeding schedule on a calendar.

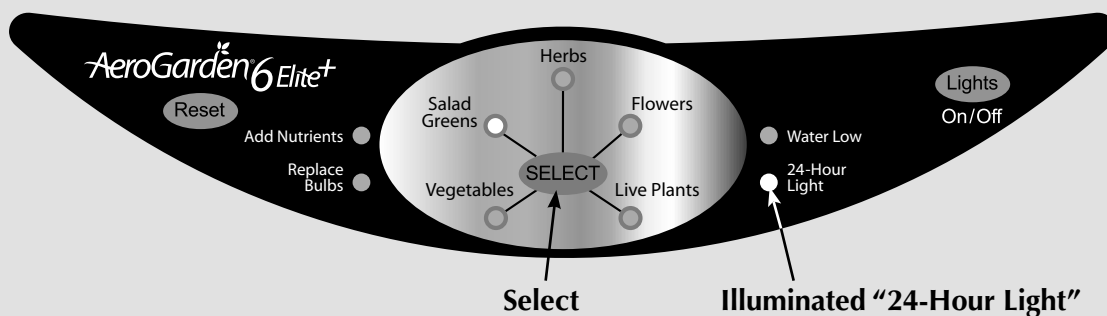

Once your AeroGarden 6 Elite+ is set on "24-Hour Light" setting, lights will remain on 24 hours a day. To shorten the amount of time lights are on, quickly press and release "Lights" button, and lights will turn off. Lights will automatically come back on within 12 hours – or, you can press and release "Lights" button again, to turn lights back on.

Personalize Your Light Timer (optional)

Your AeroGarden 6 Elite+ has lights and a built-in timer that automatically provide plants with the optimal amount of “sunlight” (about 16 hours) and “night” (about 8 hours), depending on plant type you selected.

As long as plants get this amount of light, it does not matter when lights are turned off.* Many people find it convenient to have lights go on in the morning and off at night to match their own wake and sleep schedule.

**The exceptions to this are Flower & Vegetable plants. They require a daily dark period in order to produce flowers. If your plants will receive any room light during the day (natural or artificial), we recommend setting your AeroGarden lights to be on during the day.*

5 Simple Steps...

In order to make this as simple as possible, you only need to set the time you want your AeroGarden

lights to go off (Off Time) and your built-in light timer automatically sets the On Time...nothing more for you to do.

Do the following to set the time you want your lights to go off:

- 1** Decide what time you want the lights to go OFF.
- 2** AT THAT TIME check that lights are on. If they are off, quickly press “Lights” button and immediately release. (Lights must be on in order to reset timer.)
- 3** With lights on, press and hold “Lights” button until light next to the plant type you selected starts blinking – about 5 seconds.
- 4** Release the button.
- 5** When blinking stops (about 9 seconds), the lights will go off and your lights are now set to go off at this time every day.

You can reset your timer as often as you want.

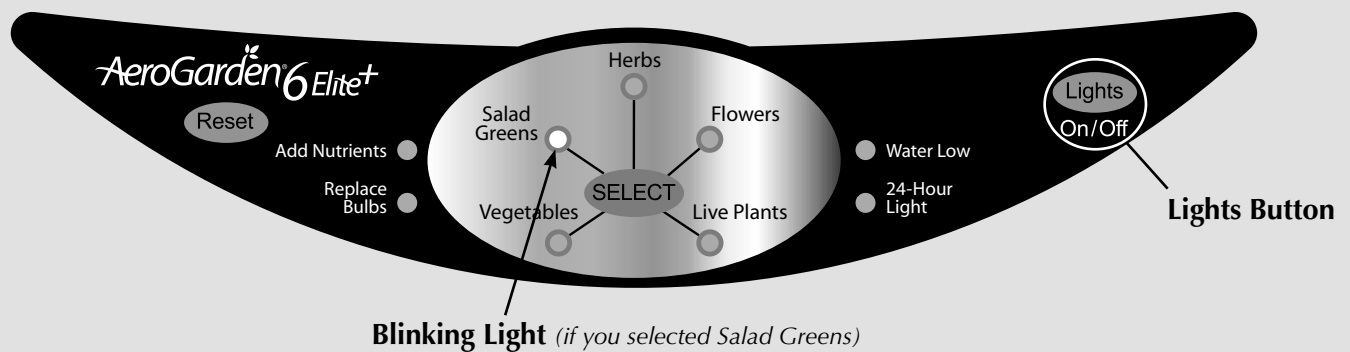

In case of power failure, your AeroGarden 6 Elite+ has a backup system that stores light, nutrient & replace bulbs timers as well as plant selection settings. When power is restored, your AeroGarden will go back to the Off-On cycle you have set.

Basic Reminders About Your AeroGarden

AeroGarden⁶ Elite⁺ Control Panel

• Select

The number of hours the lights are on and off depends on which plant type is selected. Use "Select" button to reach "24-Hour Light" setting (see page 9).

• Lights On/Off

Use to *occasionally* override built-in light timer. Once pushed, lights will stay off/on until the next time built-in light timer is set to go on/off. This will not affect the timing of your light cycle, and *occasional* use of this feature will not harm your plants.

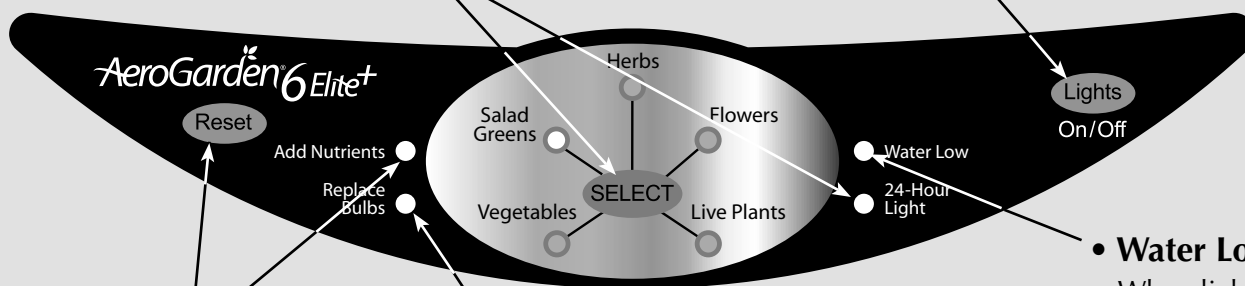

• Add Nutrients

(Feed Garden - Basic Feeding)

When "Add Nutrients" and "Water Low" lights start blinking (every 2 weeks), add 2 nutrient tablets* and fill the *Bowl* with water up to "Fill to Here." Press and release "Reset" button to restart nutrient timer and turn off blinking lights.

*See *Tending & Harvesting Guide* for plant-specific nutrient information.

• Replace Bulbs[†]

When light blinks (after 6 months of use), it is time to replace *Grow Bulbs*. Order bulbs at www.aerogardensupport.com or from your retailer. After replacing *Grow Bulbs*, press "Reset" button to restart grow bulb timer and turn off flashing light.

NOTE: If you store your AeroGarden 6 Elite⁺ between uses, grow bulb timer automatically stops when Garden is unplugged.

[†]See complete replacement instructions on next page.

• Water Low

When light blinks add water up to "Fill To Here."

• Remove Bio-Domes

When plants appear through hole in *Seed Pod Label*, remove *Bio-Dome* and discard or recycle.

NOTE: Never remove *Seed Pod Labels*.

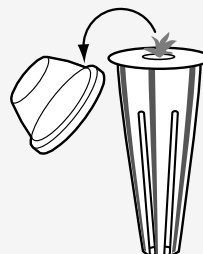

Basic Reminders About Your AeroGarden (continued)

Raise Lamp Hood (Lights)

As plants grow to **1-2" from lights**, raise *Lamp Arm* one notch at a time (each of the three *Lamp Arm* sections has three notches). Be sure *Lamp Arm* is at the lowest setting when you start your AeroGarden 6 Elite+.

1 Unplug AeroGarden 6 Elite+ and remove *Bowl* from *Base*.

2 Raise *Lamp Arm/Lamp Hood*:

- Hold *Lamp Arm* where it connects to *Lamp Hood* with one hand. With other hand, push in *Locking Lever*.
- Release *Locking Lever* while pulling up on *Lamp Arm*.
- *Locking Lever* will automatically click into next notch in the *Lamp Arm* section.

3 Replace *Bowl* on *Base* and plug in AeroGarden 6 Elite+.

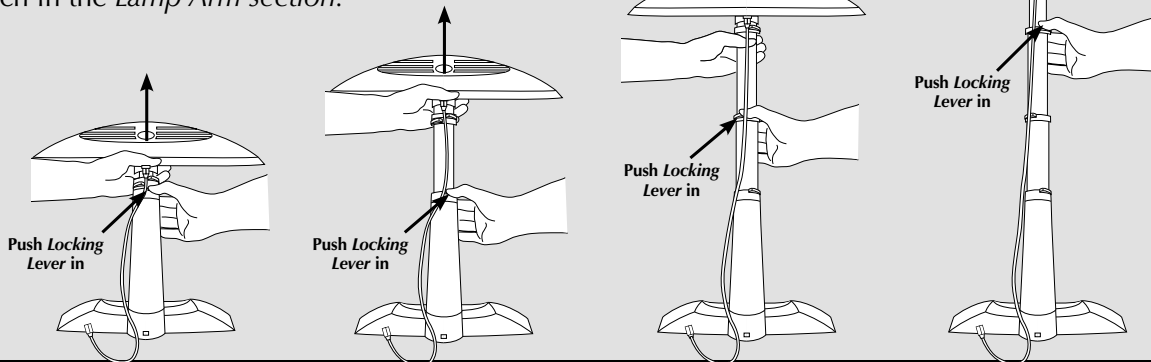

Replace Grow Bulbs – Order bulbs at www.aerogardensupport.com



When "Replace Bulbs" light on *Control Panel* begins blinking after 6 months of use...

- Unplug AeroGarden 6 Elite+.
- Remove old *Grow Bulbs* and carefully discard.*
- **IMPORTANT:** To avoid burning, be sure *Grow Bulbs* are cool before handling.
- Insert new *Grow Bulbs* into *Lamp Hood*.
- Plug in AeroGarden 6 Elite+ and press and release "Reset" button to restart grow bulb timer.

Early *Grow Bulb* Replacement

If you replace *Grow Bulbs* before "Replace Bulbs" light illuminates, be sure to restart grow bulb timer as follows:

- Press and hold "Lights" button until light next to your selected plant type starts blinking – about 5 seconds.
- Release "Lights" button. The plant type selected light will continue to blink for about 9 seconds. While plant light is still blinking...
- Quickly press and release "Reset" button. "Replace Bulbs" light will blink once and the plant selected light will stop blinking.

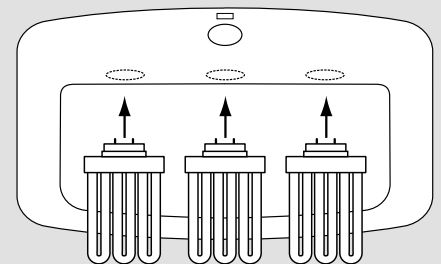

*Check with local recycling authorities for light bulb recycling availability in your area.

Basic Reminders About Your AeroGarden (continued)

(Optional) Trellis System

About the *Trellis System* (not included)

Your AeroGarden 6 Elite+ has the option of connecting a *Trellis System* to its *Lamp Hood*. The *Trellis System* allows you to easily support heavy, fruit-filled branches on full-size plants such as tomatoes, peppers and cucumbers.

If you are interested in purchasing an AeroGarden *Trellis System*, you may do so at www.aerogardensupport.com or from your retailer.

Trellis System installation

If your AeroGarden 6 Elite+ is already assembled, you will need to remove the *Lamp Hood* from *Lamp Arm*, and remove *Grow Bulbs* from the *Lamp Hood* before starting. ***It is best to do this when Garden lights are off.***

- 1 Unplug AeroGarden 6 Elite+ and carefully remove *Lamp Hood* from *Lamp Arm*.
- 2 Turn *Lamp Hood* over and remove *Grow Bulbs*. (Be sure bulbs are cool before handling.)

3 Attach *Trellis Brackets* to *Lamp Hood*

Hand tighten pre-mounted screws with phillips head screwdriver. Do not over-tighten.

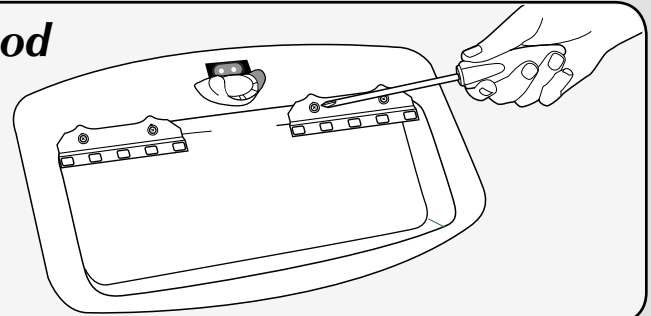

- 4 Insert *Grow Bulbs* into *Lamp Hood*.
- 5 Replace *Lamp Hood* on *Lamp Arm* and plug in AeroGarden 6 Elite+.

Use *Trellis System*

- 1 Clip *Trellis Coil* on *Bracket*.
- 2 Pull down *Trellis Coil*.
- 3 Wrap *Strap* around branch that needs support and snap closed.

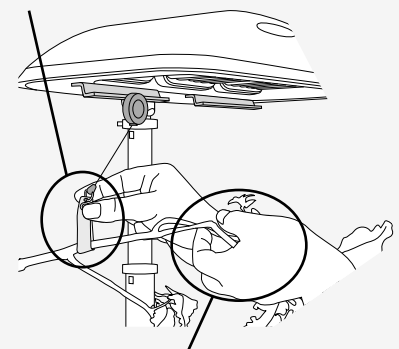
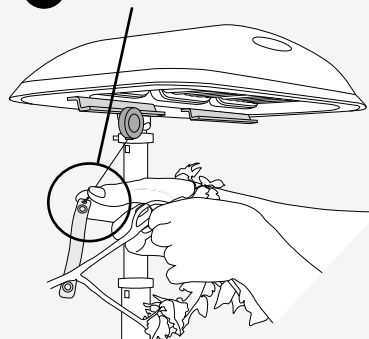
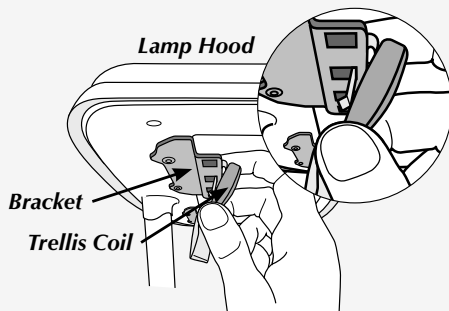

As a safety precaution, unplug AeroGarden furnishing before performing this task. Be sure *Grow Bulbs* are cool to the touch before attaching or adjusting *Trellis Coil*.

- 4 Gently push up on supported branch until it is at desired height.

Prepare For Your Next Garden

Cleaning Instructions for your AeroGarden

Use only water and mild soap when cleaning your AeroGarden (except when Sanitizing - Step 6). Do not use abrasive cleaners or run through the dishwasher.

When your garden has completed its growing cycle...

- 1 Unplug AeroGarden.
- 2 Carefully remove *Bowl* and *Grow Surface* from *Base* and bring to a sink. Set *Base* and *Lamp Hood* aside.

NEVER SUBMERSE BASE AND CONTROL PANEL IN WATER.

- 3 Remove *Grow Surface* from *Bowl* and place on a counter near a sink.
- 4 Empty contents of *Bowl* in sink.
- 5 Remove *Seed Pods* and plants from *Grow Surface*.
 - Pull *Seed Pods* out of *Grow Surface* openings.
 - Throw away *Seed Pods* and plant debris (plant growth and roots). If you compost, plant debris can be composted.

- 6 Sanitize AeroGarden.
 - Fill *Bowl* $\frac{3}{4}$ full with water.
 - Add $\frac{1}{4}$ cup (59ml) of chlorine bleach.
 - Let sit for 2 minutes.
 - Using sanitizing water, wipe *Grow Surface* and *Bowl* with soft cloth or sponge.*
*Gloves recommended.
 - Scrub underside of *Grow Surface* with soft scrub brush to remove any tangled roots.
 - Empty bleach water from *Bowl*.

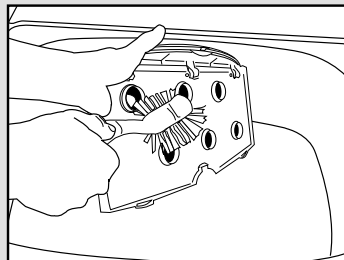
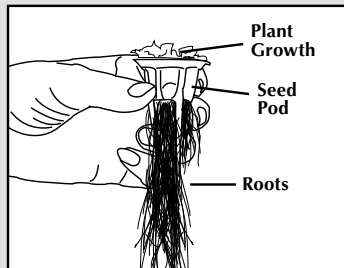
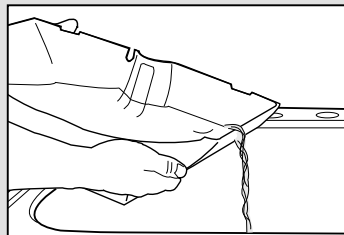
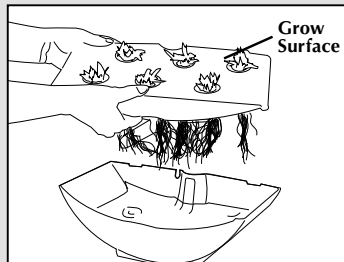

- 7 Rinse *Bowl* and *Grow Surface* with tap water. Repeat.
- 8 Towel dry *Bowl* and *Grow Surface* before putting them back together and setting them on *Base*.
- 9 If *Grow Bulbs* have been in use more than 6 months, they should be replaced at this time (see page 12).

Your AeroGarden is now ready for replanting.

Prepare For Your Next Garden (continued)

Replanting Your AeroGarden

If you have already grown a garden in your AeroGarden 6 Elite+, please follow the instructions below to reset the nutrient timer:

- Press and hold "Reset" button until red "Add Nutrients" light blinks 3 or 4 times (about 9 seconds).
- Release "Reset" button. "Add Nutrients" light will turn off.
- Your AeroGarden is now reset. (In some cases you may see other lights blink as well. This is nothing to worry about.)

NOTE: These steps do not reset grow bulb timer.

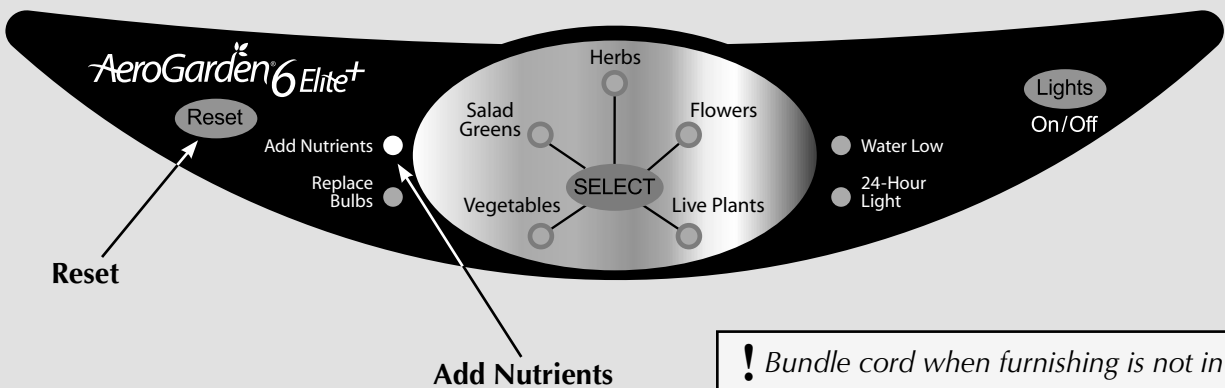

U.S. CAUTION – You are cautioned that any changes or modifications not expressly approved in this manual could void your authority to operate this equipment.

NOTE: This equipment has been tested and found to comply with the limits for a Class B digital device, pursuant to Part 15 of the FCC Rules. These limits are designed to provide reasonable protection against harmful interference in a residential installation. This equipment generates, uses, and can radiate radio frequency energy and, if not installed and used in accordance with the instructions, may cause harmful interference to radio communications. However, there is no guarantee that interference will not occur in a particular installation. If this equipment does cause harmful interference to radio or television reception, which can be determined by turning the equipment off and on, the user is encouraged to try to correct the interference by one or more of the following measures: Reorient or relocate the receiving antenna; Increase the separation between the equipment and receiver; Connect the equipment into an outlet on a circuit different from that to which the receiver is connected; or, Consult the dealer or an experienced radio/TV technician for help.

To reduce the risk of electric shock, this furnishing has a polarized plug (one blade is wider than the other). This plug will fit in a polarized outlet only one way. If the plug does not fit fully in the outlet, reverse the plug. If it still does not fit, contact a qualified electrician to install the proper outlet. Do not change the plug in any way.

CAUTION: TO PREVENT ELECTRIC SHOCK, MATCH WIDE BLADE OF PLUG TO WIDE SLOT, FULLY INSERT.

ATTENTION: POUR ÉVITER UN CHOC ÉLECTRIQUE, PRÉSENTER LA LAME LARGE À LA FENTE LARGE ET POUSSER JUSQU'AU FOND.

Free Manuals Download Website

<http://myh66.com>

<http://usermanuals.us>

<http://www.somanuals.com>

<http://www.4manuals.cc>

<http://www.manual-lib.com>

<http://www.404manual.com>

<http://www.luxmanual.com>

<http://aubethermostatmanual.com>

Golf course search by state

<http://golfingnear.com>

Email search by domain

<http://emailbydomain.com>

Auto manuals search

<http://auto.somanuals.com>

TV manuals search

<http://tv.somanuals.com>