

Errata

Title & Document Type: 6434B DC Power Supply Operating and Service Manual (Dec67)

Manual Part Number: 06434-90001

Revision Date: December 1967

HP References in this Manual

This manual may contain references to HP or Hewlett-Packard. Please note that Hewlett-Packard's former test and measurement, semiconductor products and chemical analysis businesses are now part of Agilent Technologies. We have made no changes to this manual copy. The HP XXXX referred to in this document is now the Agilent XXXX. For example, model number HP8648A is now model number Agilent 8648A.

About this Manual

We've added this manual to the Agilent website in an effort to help you support your product. This manual provides the best information we could find. It may be incomplete or contain dated information, and the scan quality may not be ideal. If we find a better copy in the future, we will add it to the Agilent website.

Support for Your Product

Agilent no longer sells or supports this product. You will find any other available product information on the Agilent Test & Measurement website:

www.tm.agilent.com

Search for the model number of this product, and the resulting product page will guide you to any available information. Our service centers may be able to perform calibration if no repair parts are needed, but no other support from Agilent is available.



OPERATING AND SERVICE MANUAL

MODEL 6434B

DC POWER SUPPLY

SERIAL NUMBER PREFIX 7G

OPERATING AND SERVICE MANUAL

HEWLETT
PACKARD  HARRISON
DIVISION

OPERATING AND SERVICE MANUAL

MODEL 6434B

DC POWER SUPPLY

SERIAL NUMBER PREFIX 7G

Printed: December, 1967

 Stock Number: 06434-90001

TABLE OF CONTENTS

Section	Page No.	Section	Page No.
I GENERAL INFORMATION	1-1	IV PRINCIPLES OF OPERATION (Continued)	
1-1 Description	1-1	4-37 SCR Regulator	4-4
1-3 Overload Protection	1-1	4-42 Bias and Reference Circuit	4-5
1-6 Cooling	1-1		
1-8 Monitoring	1-1	V MAINTENANCE	5-1
1-10 Output Terminals	1-1	5-1 General	5-1
1-12 Instrument Identification	1-1	5-3 Measurement Techniques	5-3
1-15 Ordering Additional Manuals	1-1	5-7 Performance Check	5-3
		5-8 General	5-3
II INSTALLATION	2-1	5-10 Rated Output and Meter	
2-1 Initial Inspection	2-1	Accuracy	5-3
2-3 Mechanical Check	2-1	5-13 Line Regulation	5-3
2-5 Electronic Check	2-1	5-16 Load Regulation	5-4
2-7 Installation Data	2-1	5-19 Ripple and Noise	5-4
2-9 Location	2-1	5-21 Transient Recovery Time	5-6
2-11 Power Requirements	2-1	5-23 Additional Specification Check	5-6
2-13 Power Cable	2-1	5-24 Temperature Coefficient	5-6
2-16 Repackaging for Shipment	2-1	5-27 Output Stability	5-6
		5-30 Output Impedance	5-6
III OPERATING INSTRUCTIONS	3-1	5-32 Output Inductance	5-6
3-1 Controls and Indicators	3-1	5-34 Cover Removal	5-7
3-3 Operation	3-1	5-36 Troubleshooting	5-7
3-5 Normal	3-1	5-37 General	5-7
3-9 Connecting Load	3-2	5-39 Trouble Analysis	5-8
3-13 Remote Sensing	3-2	5-46 Repair and Replacement	5-11
3-16 Remote Programming	3-3	5-48 Adjustments and Calibrations	5-14
3-25 Parallel	3-4	5-49 General	5-14
3-29 Series	3-5	5-51 Meter Zero	5-14
3-34 Auto-Tracking	3-6	5-53 Voltmeter Tracking	5-15
3-37 Operating Considerations	3-6	5-55 Ammeter Tracking	5-15
3-38 Pulse Loading	3-6	5-57 Constant Voltage Programming	
3-40 Output Capacitance	3-6	Current	5-15
3-43 Negative Voltage Loading	3-6	5-59 Zero Voltage Output	5-15
3-45 Negative Current Loading	3-7	5-61 Constant Current Programming	
		Current	5-15
IV PRINCIPLES OF OPERATION	4-1	5-63 Zero Current Output	5-15
4-1 Block Diagram Description	4-1	5-65 Bias and Reference Line	
4-9 Circuit Description	4-2	Regulation	5-15
4-10 AC Input	4-2	5-67 Line Imbalance	5-16
4-12 DC Output	4-2	5-69 Constant Current Load Reg-	
4-14 Voltage Input	4-2	ulation	5-16
4-20 Current Input	4-3		
4-24 Gating Circuit	4-3	VI REPLACEABLE PARTS	6-1
4-27 Turn-On Circuit	4-3	6-1 Introduction	6-1
4-29 SCR Regulator Control	4-3	6-4 Ordering Information	6-1

LIST OF TABLES

Table	Page No.
1-1 Specifications	1-2
5-1 Test Equipment	5-1
5-2 Normal Voltage	5-8
5-3 Bias and Reference Circuit Troubleshooting	5-9
5-4 High Output Voltage Troubleshooting	5-9
5-5 Low Output Voltage Troubleshooting	5-9
5-6 Common Troubles	5-10
5-7 Checks and Adjustments after Replacement of Semiconductor Devices	5-13
5-8 Adjustment and Calibration Summary	5-14
6-1 Reference Designators	6-1
6-2 Description Abbreviations	6-1
6-3 Code List of Manufacturers	6-2
6-4 Replaceable Parts	6-5

LIST OF ILLUSTRATIONS

Figure		Page No.	Figure		Page No.
1-1	DC Power Supply, SCR-1P Series	iv	4-1	Block Diagram	4-1
3-1	Front Panel Controls and Indicators	3-1	5-1	Differential Voltmeter Substitute, Test Setup	5-2
3-2	Normal Strapping Pattern	3-1	5-2	Output Current Measurement Technique	5-3
3-3	Remote Sensing	3-2	5-3	Constant Current, Test Setup	5-4
3-4	Remote Resistance Programming	3-3	5-4	Transient Recovery Time, Test Setup	5-5
3-5	Remote Voltage Programming	3-3	5-5	Transient Recovery Time, Waveform	5-5
3-6	Remote Resistance Programming	3-4	5-6	Output Impedance, Test Setup	5-7
3-7	Normal Parallel Connections	3-4	5-7	Servicing Printed Wiring Boards	5-12
3-8	Auto-Parallel, Two and Three Units	3-4			
3-9	Normal Series Connections	3-5			
3-10	Auto-Series, Two and Three Units	3-5			
3-11	Auto-Tracking, Two and Three Units	3-6			

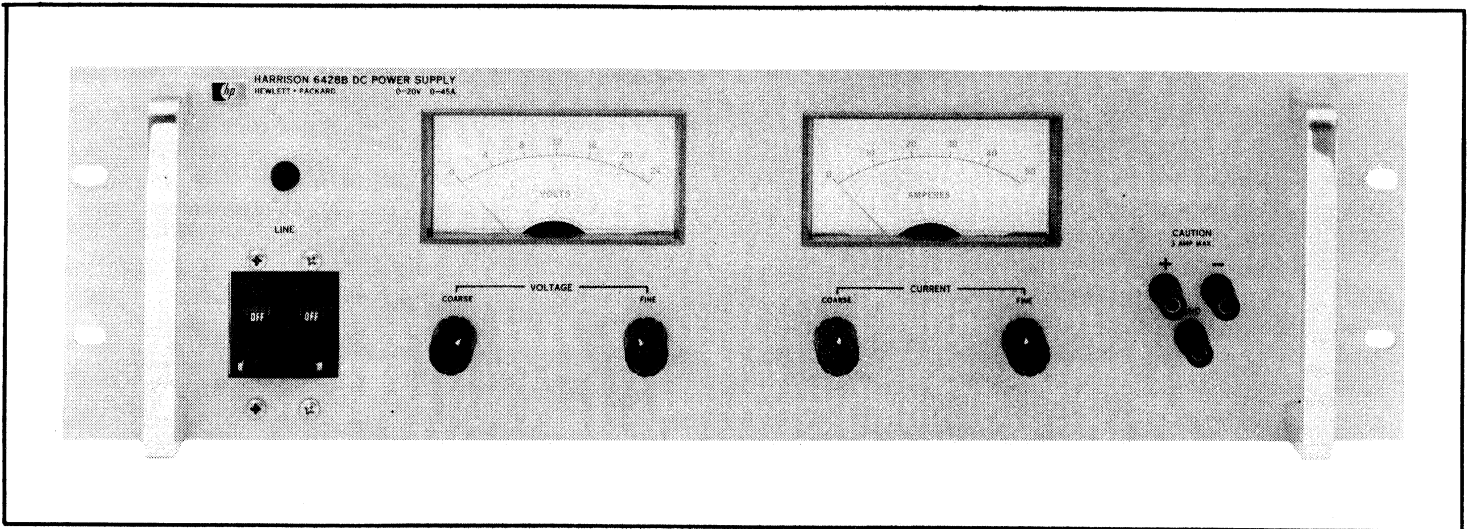

Figure 1-1. DC Power Supply, SCR-1P Series

SECTION I GENERAL INFORMATION

1-1 DESCRIPTION

1-2 Model 6434B DC Power Supply (Figure 1-1) is a completely solid-state, compact, well-regulated, constant voltage/constant current dc power supply suitable for either bench or relay rack operation. Input power is connected to a terminal strip at the rear of the power supply. The output is continuously variable between 0 and 40Vdc, and between 0 and 25 Amperes. Detailed specifications are given in Table 1-1.

1-3 OVERLOAD PROTECTION

1-4 A crossover feature protects both power supply and load in constant voltage operation. Automatic crossover circuitry switches the power supply from constant voltage to constant current operation if the output current exceeds a preset limit. This crossover circuitry also protects the load from overvoltage during constant current operation by automatically switching the power supply into constant voltage operation. The user can adjust the crossover point via the front panel controls (Paragraphs 3-7 and 3-8).

1-5 The power supply is protected from reverse voltage (positive voltage applied to negative terminal) by a diode that shunts current across the output terminals when this condition exists. The ac input components are protected by a dual circuit breaker in the ac input line. This circuit breaker is located on the front panel and serves as the on/off switch.

1-6 COOLING

1-7 A fan is used to blow air from left to right (facing front panel) through a compartment containing the major heat producing elements.

1-8 MONITORING

1-9 Two front-panel meters are provided for monitoring output voltage and current. The volt-

meter has a 0 to 50 Volt range and the ammeter has a 0 to 30 Ampere range. Each meter has a 2% accuracy at full scale.

1-10 OUTPUT TERMINALS

1-11 Output power is available via a terminal strip on the rear panel. The rear panel terminal strip also enables the power supply to be connected for different modes of operation (Paragraph 3-3). The output terminals are isolated from the chassis and either the positive or the negative terminal may be connected to the chassis via a separate ground terminal located adjacent to the output terminals. The power supply is insulated to permit operation up to 300Vdc off ground.

1-12 INSTRUMENT IDENTIFICATION

1-13 Hewlett-Packard power supplies are identified by a three-part serial number tag. The first part is the power supply model number. The second part is the serial number prefix, which consists of a number-letter combination that denotes the date of a significant design change. The number designates the year, and the letter A through L designates the month, January through December respectively. The third part is the power supply serial number.

1-14 If the serial number prefix on your power supply does not agree with the prefix on the title page of this manual, change sheets are included to update the manual. Where applicable, back-dating information is given in an appendix at the rear of the manual.

1-15 ORDERING ADDITIONAL MANUALS

1-16 One manual is shipped with each power supply. Additional manuals may be purchased from your local Hewlett-Packard field office (see list at rear of this manual for addresses). Specify the model number, serial number prefix, and  stock number provided on the title page.

Table 1-1. Specifications

<p>INPUT: 115Vac $\pm 10\%$, 57 to 63Hz, single phase, 19 Amperes, 1300 Watts max.</p> <p>RATED OUTPUT: Constant Voltage: 0 to 40Vdc Constant Current: 0 to 25 Amperes dc</p> <p>LINE REGULATION: Constant Voltage: Less than 18mV for 10% change in the nominal input voltage. Constant Current: Less than 200mA for 10% change in the nominal line voltage.</p> <p>LOAD REGULATION: Constant Voltage: Less than 40mV for 0 to 25 Ampere load change. Constant Current: Less than 200mA for 0 to 40Vdc load change.</p> <p>RIPPLE AND NOISE: 40mV rms</p> <p>OPERATING TEMPERATURE RANGE: 0°C to 55°C</p> <p>STORAGE TEMPERATURE RANGE: -40°C to +75°C</p> <p>TEMPERATURE COEFFICIENT: Constant Voltage: 0.03% plus 5mV per degree centigrade. Constant Current: 75mA per degree centigrade.</p> <p>OUTPUT STABILITY: (after 30-minute warm-up) Constant Voltage: 0.1% plus 20mV for 8 hours</p>	<p>at constant temperature. Constant Current: 250mA for 8 hours at constant temperature.</p> <p>REMOTE PROGRAMMING: Constant Voltage: 200 ohms per Volt $\pm 1\%$. Constant Current: 10 ohms per Ampere $\pm 10\%$.</p> <p>TYPICAL OUTPUT IMPEDANCE: Less than 0.01 ohm from dc to 0.5Hz. Less than 0.5 ohm from 0.5Hz to 100Hz. Less than 0.1 ohm from 100Hz to 1kHz. Less than 0.6 ohm from 1kHz to 100kHz.</p> <p>OUTPUT INDUCTANCE: 1.0 microhenry</p> <p>TRANSIENT RECOVERY TIME: In constant voltage operation, less than 200 mil- liseconds is required for output voltage recovery to within 200 millivolts of the nominal output volt- age following a load change equal to one half the maximum current rating of the power supply. Nominal output voltage is defined as the mean between the no-load and full-load voltages. The transient amplitude is less than 0.3 Volt per Ampere for any load change between 20% and 100% of rated output current. (Excluding the initial spike of approximately 100 microseconds duration which is significant only for load rise times faster than 0.1 Ampere per microsecond.)</p> <p>SIZE AND WEIGHT: 5-1/4 in. H x 19 in. W x 16-3/4 in. D, 67 lbs.</p> <p>FINISH: Light gray front panel with dark gray case.</p>
---	---

SECTION II INSTALLATION

2-1 INITIAL INSPECTION

2-2 Before shipment, the power supply was inspected and found free of mechanical and electrical defects. As soon as the power supply is unpacked, inspect it for any damage that may have occurred in transit. Also check the cushioning material for signs of severe stress (may be indication of internal damage). Save all packing materials until the inspection is completed. If damage is found, proceed as instructed in the Claim for Damage in Shipment notice on the back of the front cover of this manual.

2-3 MECHANICAL CHECK

2-4 Check that there are no broken knobs or connectors, that the external surface is not scratched or dented, that the meter faces are not damaged, and that all controls move freely. Any external damage may be an indication of internal damage.

2-5 ELECTRICAL CHECK

2-6 Check that the straps on the terminal strip at the rear of the power supply are secure and that the strapping pattern is in accord with Figure 3-2. Check the electrical performance of the power supply as soon as possible after receipt. A performance check that is suitable for incoming inspection is given in Paragraphs 5-7 through 5-22.

2-7 INSTALLATION DATA

2-8 The power supply is shipped ready for bench or relay rack (19 inch) operation.

2-9 LOCATION

2-10 Because the power supply is forced-air (fan) cooled, the air intake and outlet vents on the sides of the chassis must not be obstructed. The

power supply should be located in an area where ambient temperature does not exceed 55°C.

2-11 POWER REQUIREMENTS

2-12 The power supply is operated from a 115Vac $\pm 10\%$, 57 to 63Hz, single phase power source. At 115 Volts, 60Hz, the full load requirement is 1300 Watts at 19 Amperes. The input power line should be fused for 25 Amps at 115Vac or 15 Amps at 230Vac to allow for current surges resulting from SCR firing.

2-13 POWER CABLE

2-14 To protect operating personnel, the National Electrical Manufacturers Association (NEMA) recommends that the instrument panel and cabinet be grounded. This instrument should be used with a three-conductor power cable that has #12 AWG wire. The third conductor is the ground conductor and when the cable is plugged into an appropriate receptacle, the instrument is grounded. The offset pin on the power cable three-prong connector is the ground connection.

2-15 To preserve the protection feature when operating the instrument from a two-contact outlet, use a three-prong to two-prong adaptor and connect the green lead on the adaptor to ground.

2-16 REPACKAGING FOR SHIPMENT

2-17 To insure safe shipment of the instrument, it is recommended that the package designed for the instrument be used. The original packaging is reusable. If it is not available, contact your Hewlett-Packard field office for packing materials and information. A packing carton part number is included in the parts list.

2-18 Attach a tag to the instrument which specifies the owner, model number, full serial number, and service required, or a brief description of the trouble.

SECTION III
OPERATING INSTRUCTIONS

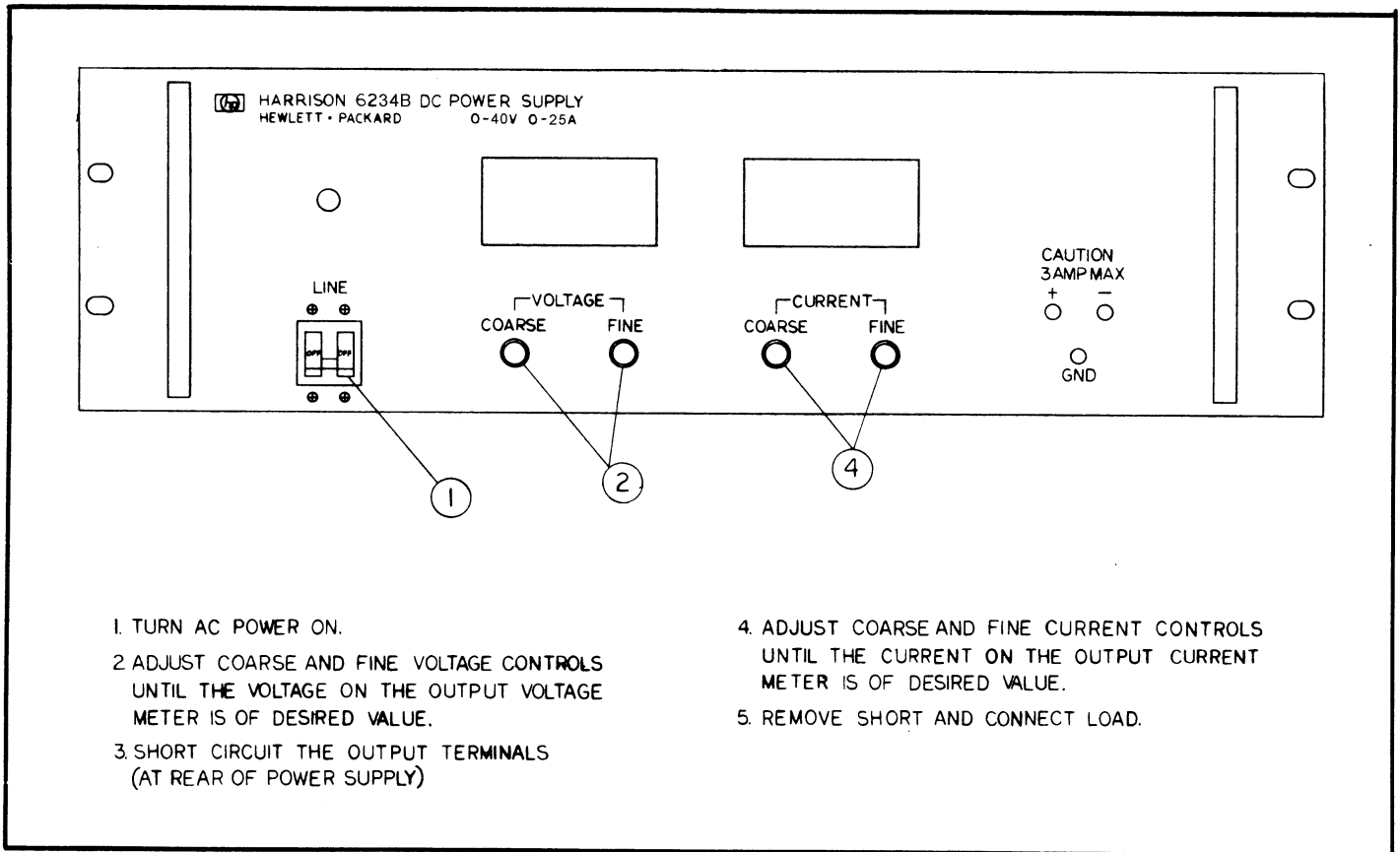

Figure 3-1. Front Panel Controls and Indicators

3-1 CONTROLS AND INDICATORS

3-2 The controls and indicators are illustrated in Figure 3-1.

3-3 OPERATION

3-4 The power supply is designed so that its mode of operation can be selected by making strapping connections between particular terminals on the terminal strip at the rear of the power supply. The terminal designations are stenciled in white on the power supply and are adjacent to their respective terminals. The strapping patterns illustrated in this section show neither terminal grounded. The operator can ground either terminal or operate the power supply up to 300Vdc off ground (floating). The ac input power is connected to the AC, ACC, and GND terminals at the rear of the power supply.

3-5 NORMAL

3-6 The power supply is normally shipped with its rear terminal strapping connections arranged for constant voltage/constant current, local sensing, local programming, single unit mode of operation. This strapping pattern is illustrated in Figure 3-2. The operator selects either a constant voltage or a constant current output using the front panel controls (local programming, no strapping changes are necessary).

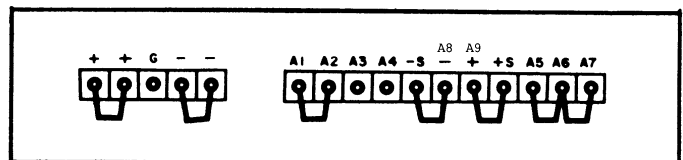

Figure 3-2. Normal Strapping Pattern

3-7 CONSTANT VOLTAGE. To select a constant voltage output, proceed as follows:

a. Turn-on power supply and adjust VOLTAGE controls for desired output voltage (output terminals open).

b. Short output terminals and adjust CURRENT controls for maximum output current allowable (current limit), as determined by load conditions. If a load change causes the current limit to be exceeded, the power supply will automatically crossover to constant current output at the preset current limit and the output voltage will drop proportionately. In setting the current limit, allowance must be made for high peak currents which can cause unwanted crossover (refer to Paragraph 3-39).

3-8 CONSTANT CURRENT. To select a constant current output, proceed as follows:

a. Short output terminals and adjust CURRENT controls for desired output current.

b. Open output terminals and adjust VOLTAGE controls for maximum output voltage allowable (voltage limit), as determined by load conditions. If a load change causes the voltage limit to be exceeded, the power supply will automatically crossover to constant voltage output at the preset voltage limit and the output current will drop proportionately. In setting the voltage limit, allowance must be made for high peak voltages which can cause unwanted crossover. (Refer to Paragraph 3-39.)

3-9 CONNECTING LOAD

3-10 Two pairs of output terminals are provided on the terminal strip at the left rear side (facing rear) of the power supply. Either pair of terminals or both may be used. The terminals are marked + and -. A separate ground terminal is located adjacent to the output terminals. The positive or negative output terminal may be grounded, or neither grounded (floating operation; permitted to 300Vdc off ground).

3-11 Each load should be connected to the power supply output terminals using separate pairs of connecting wires. This will minimize mutual coupling effects between loads and will retain full advantage of the low output impedance of the power supply. Each pair of connecting wires should be as short as possible and twisted or shielded to reduce noise pickup. (If shield is used, connect one end to power supply ground terminal and leave the other end unconnected.)

3-12 If load considerations require that the output power distribution terminals be remotely located from the power supply, then the power supply output terminals should be connected to the remote

distribution terminals via a pair of twisted or shielded wires and each load separately connected to the remote distribution terminals. For this case, remote sensing should be used (Paragraph 3-13).

NOTE

It is recommended that the voltage drop in the connecting wires not exceed 2 Volts. If a larger drop must be tolerated, please consult a Hewlett-Packard field representative.

3-13 REMOTE SENSING

3-14 Remote sensing is used to ameliorate the degradation of regulation which will occur at the load when the voltage drop in the connecting wires is appreciable. The use of remote distribution terminals (Paragraph 3-12) is an example where remote sensing may be required. Due to the voltage drop in the load leads, it may be necessary to slightly increase the current limit in constant voltage operation.

CAUTION

Turn-off power supply before rearranging strapping pattern at the power supply rear terminal strip. If the -S terminal is opened while the power supply is on, the output voltage and current may exceed their maximum ratings and result in damage to the load. The power supply will not be damaged.

3-15 Proceed as follows:

a. Turn-off power supply and arrange rear terminal strapping pattern as shown in Figure 3-3. The sensing wires will carry less than 10mA and need not be as heavy as the load wires. It is recommended that sensing and load wires be twisted and shielded. (If shield is used, connect one end to power supply negative terminal and leave the other end unconnected.)

CAUTION

Observe polarity when connecting the sensing leads to the load.

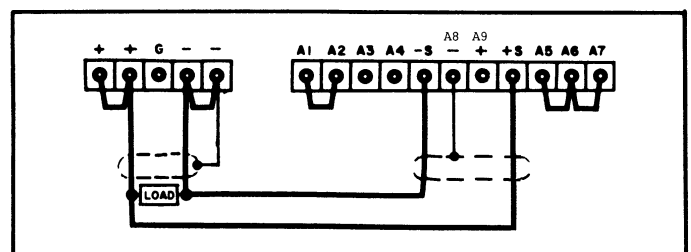

Figure 3-3. Remote Sensing

b. In order to maintain low ac output impedance, a capacitor with a minimum rating of 20,000 μ fd and 40 VdcW should be connected across the load using short leads. This capacitor must have high-frequency characteristics as good or better than C17 has (see parts list).

c. Turn-on power supply.

3-16 REMOTE PROGRAMMING

3-17 The constant voltage and constant current outputs may be programmed (controlled) from a remote location. The front-panel controls are disabled in the following instructions. Changes in the rear terminal strapping arrangement are necessary. The wires connecting the programming terminals of the power supply to the remote programming device should be twisted or shielded to reduce noise pick-up. (If shield is used, connect one end to power supply ground terminal and leave the other end unconnected.) Remote sensing (Paragraph 3-13) may be used simultaneously with remote programming. However, the strapping patterns shown in Figures 3-4, 3-5, and 3-6 employ only local sensing and do not show the load connections.

CAUTION

Turn-off power supply before rearranging strapping pattern at the power supply rear terminal strip. If the current programming terminals are opened while the power supply is on, the output current will exceed its maximum rating and may result in damage to the load. The power supply will not be damaged. The constant voltage programming terminals have a zener diode connected internally across them to limit the programming voltage and thus prevent excessive output voltage.

3-18 CONSTANT VOLTAGE. In the constant voltage mode of operation, either a resistance or voltage source can be used for remote programming. For resistance programming, the programming coefficient (fixed by the programming current) is 200 ohms per Volt (output voltage increases 1 Volt for each 200 ohms in series with programming terminals). The programming current is adjusted to within 1% of 5mA at the factory. If greater programming accuracy is required, change R39 (shunt). The programming resistance should be a stable, low noise, low-temperature (less than 30 ppm per $^{\circ}$ C) resistor with a power rating at least 10 times its actual dissipation.

3-19 The output voltage of the power supply should be 0 +20mV, -100mV when the programming resistance is zero ohms. This tolerance can be improved by changing R6. For further information on improving this tolerance, refer to Paragraph 5-63.

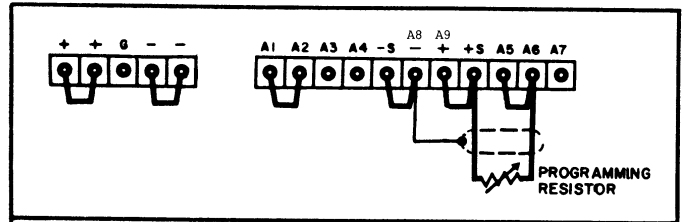

Figure 3-4. Remote Resistance Programming (Constant Voltage)

3-20 If the resistance programming device is controlled by a switch, make-before-break contacts should be used in order to avoid momentary opening of the programming terminals. To connect the remote programming resistance, arrange rear terminal strapping pattern as shown in Figure 3-4. The front-panel VOLTAGE controls are disabled when the strap between A6 and A7 is removed.

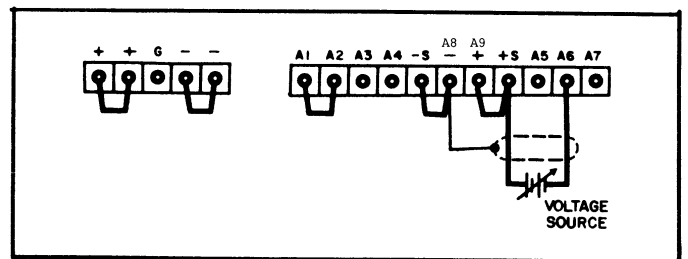

Figure 3-5. Remote Voltage Programming (Constant Voltage)

3-21 If a voltage source is used as the remote programming device, the output voltage of the power supply will vary in a 1 to 1 ratio with the programming voltage. The load on the voltage source will not exceed 25 microamperes. To connect the programming voltage, arrange rear terminal strapping pattern as shown in Figure 3-5.

3-22 CONSTANT CURRENT. In constant current operation, resistance programming is used. The resistance programming coefficient (fixed by the programming current) is 5 ohms per Ampere (output current increases 1 Ampere for each 5 ohms in series with programming terminals). The programming current is adjusted to within approximately 10% of 2mA at the factory. If greater programming accuracy is required, change R41 (shunt). The

programming resistance should be a stable, low noise, low-temperature (less than 30 ppm per °C) resistor with a power rating at least 10 times its actual dissipation.

3-23 The output current of the power supply should be 0 +100mA, -450mA when the programming resistance is zero ohms. This tolerance can be improved by changing R20. For further information on improving this tolerance, refer to Paragraph 5-61.

3-24 If the resistance programming device is controlled by a switch, make-before-break contacts should be used to avoid momentary opening of the programming terminals. To connect the remote programming resistance, arrange rear terminal strapping as shown in Figure 3-6. The front-panel CURRENT controls are disabled when the strap between A1 and A2 is removed.

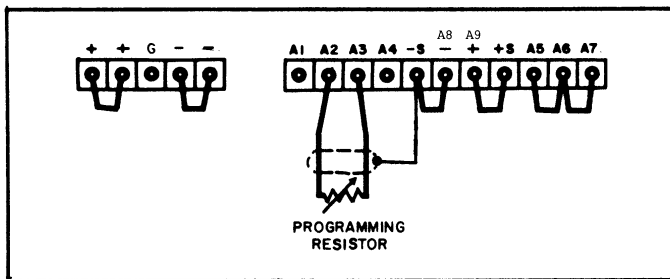

Figure 3-6. Remote Resistance Programming (Constant Current)

3-25 PARALLEL

3-26 Two or more power supplies can be connected in parallel to obtain a total output current greater than that available from one power supply. The total output current is the sum of the output currents of the individual power supplies. Each power supply can be turned-on or off separately. Remote sensing (Paragraph 3-13) and programming (Paragraph 3-16) can be used; however, the strapping patterns shown in Figures 3-7 and 3-8 employ only local sensing and programming.

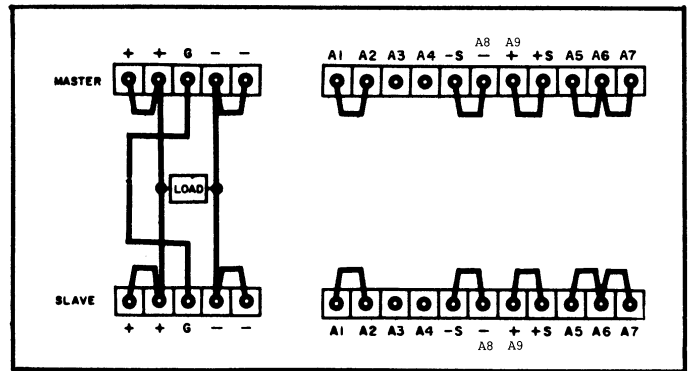

Figure 3-7. Normal Parallel Connections

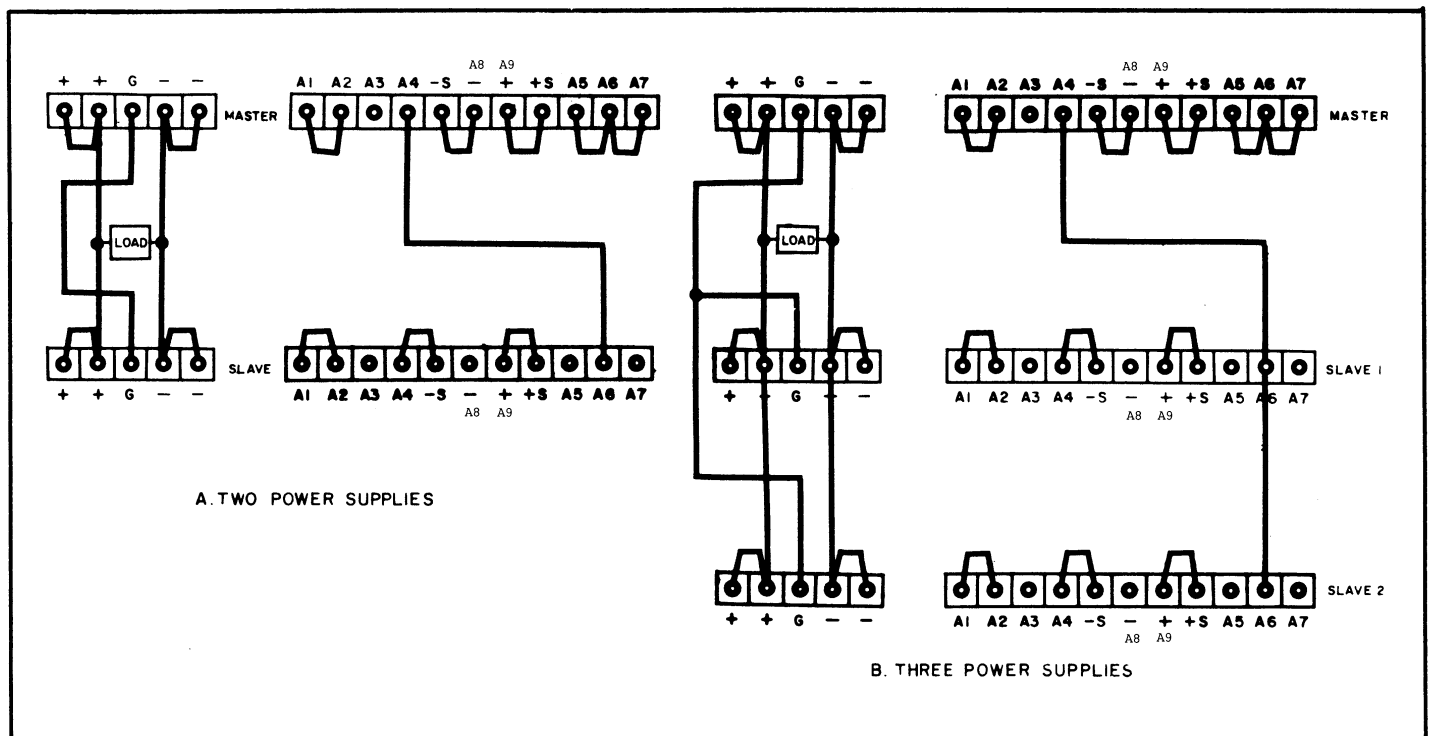

Figure 3-8. Auto-Parallel, Two And Three Units

3-27 NORMAL. The strapping pattern for normal parallel operation of two power supplies is shown in Figure 3-7. The output current controls of each power supply can be separately set. The output voltage controls of one power supply (master) should be set to the desired output voltage; the other power supply (slave) should be set for a slightly larger output voltage. The master will act as a constant voltage source; the slave will act as a constant current source, dropping its output voltage to equal the master's.

3-28 AUTO-PARALLEL. The strapping patterns for auto-parallel operation of two and three power supplies are shown in Figures 3-8A and B, respectively. Auto-parallel operation permits equal current sharing under all load conditions, and allows complete control of output current from one master power supply. The output current of each slave is approximately equal to the master's. Because the output current controls of each slave is operative, they should be set to maximum to avoid having the slave revert to constant current operation; this would occur if the master output current setting exceeded the slave's.

3-29 SERIES

3-30 Two or more power supplies can be connected in series to obtain a total output voltage higher than that available from one power supply. The total output voltage is the sum of the output voltages of the individual power supplies. A single load can be connected across the series-connected power supplies or a separate load can be connected across each power supply. The power supply has a reverse polarity diode connected internally across the output terminals to protect the power supply against reverse polarity voltage if the load is short-circuited or if one power supply is turned off while its series partners are on.

3-31 The output current controls of each power supply are operative and the current limit is equal to the lowest control setting. If any output current controls are set too low with respect to the total output voltage, the series power supplies will automatically crossover to constant current operation and the output voltage will drop. Remote sensing (Paragraph 3-13) and programming (Paragraph 3-16) can be used; however, the strapping patterns shown in Figures 3-9 and 3-10 employ only local sensing and programming.

3-32 NORMAL. The strapping pattern for normal series operation of two power supplies is shown in Figure 3-9. The output voltage controls of each power supply must be adjusted to obtain the total output voltage.

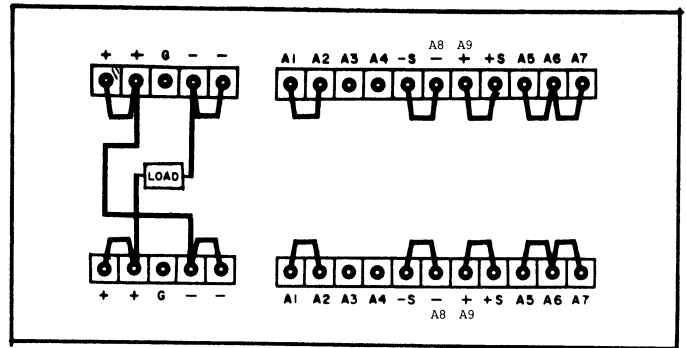

Figure 3-9. Normal Series Connections

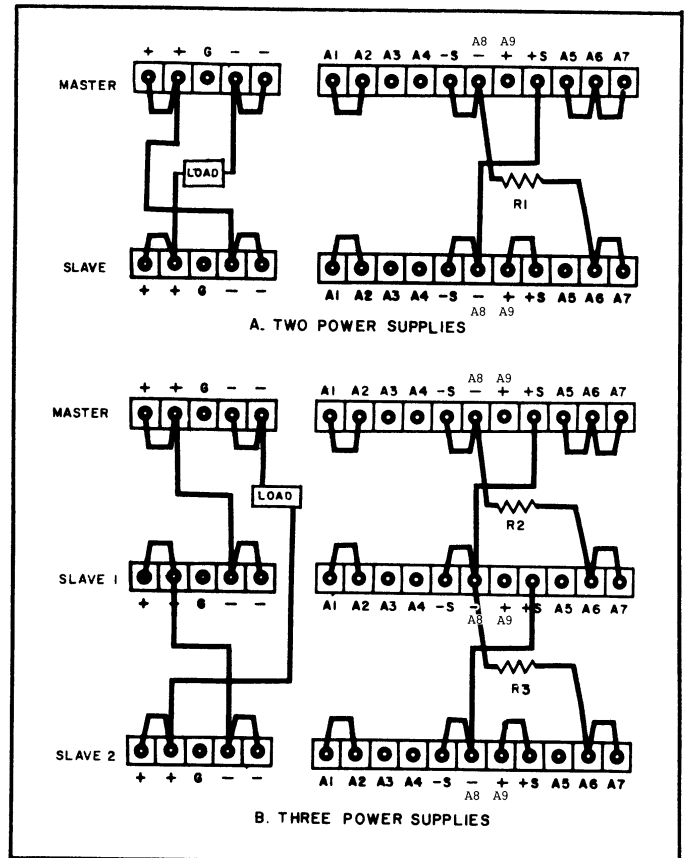

Figure 3-10. Auto-Series, Two and Three Units

3-33 AUTO-SERIES. The strapping patterns for auto-series operation of two and three power supplies are shown in Figures 3-10A and B, respectively. Auto-series operation permits control of the output voltage of several power supplies (slaves) from one master power supply. The master must be the most negative power supply of the series. To obtain positive and negative voltages, the + terminal of the master may be grounded. For a given position of the slave output voltage controls, the total output voltage is determined by the master output voltage controls. The output voltage controls of a slave determines the percentage of the total output voltage that the slave

will contribute. Turn-on and turn-off of the series is controlled by the master. In order to maintain the temperature coefficient and stability specifications of the power supply, the external resistors shown in Figures 3-10A and B, should be stable, low-temperature (less than 30ppm per °C) resistors. The value of these resistors is determined by multiplying the output voltage of the applicable slave by the programming coefficient (200 ohms/Volt).

3-34 AUTO-TRACKING

3-35 The strapping patterns for auto-tracking operation of two and three power supplies are shown in Figures 3-11A and B, respectively. Automatic tracking operation permits the output voltages of two or more power supplies to be referenced to a common buss; one of the power supplies (master) controls the magnitude of the output voltage of the others (slaves) for a given position of the slave output voltage controls. The master must be the most negative power supply in the group. The output voltage of a slave is a percentage of the master output voltage. The output voltage controls of a slave determines this percentage. Turn-on and turn-off of the power supplies is controlled by the master. Remote sensing (Paragraph 3-13) and programming (Paragraph 3-16) can be used; however, the strapping patterns shown in Figure 3-4 employ only local sensing and programming.

3-36 The value of the external resistors shown in Figure 3-11 is determined by dividing the voltage difference between the master and the applicable slave by the programming current (nominally 5mA; refer to Paragraph 3-18). Finer adjustment of the slave output voltage can be accomplished using the slave output voltage controls. In order to maintain the temperature coefficient and stability specifications of the power supply, the external resistors should be stable, low-noise, low-temperature (less than 30ppm per °C) resistors.

3-37 OPERATING CONSIDERATIONS

3-38 PULSE LOADING

3-39 The power supply will automatically cross over from constant voltage to constant current operation, or the reverse, in response to an increase (over the preset limit) in the output current or voltage, respectively. Although the preset limit may be set higher than the average output current or voltage, high peak currents or voltages (as occur in pulse loading) may exceed the preset limit and cause crossover to occur. To avoid this unwanted crossover, the preset limit must be set for the peak requirement and not the average.

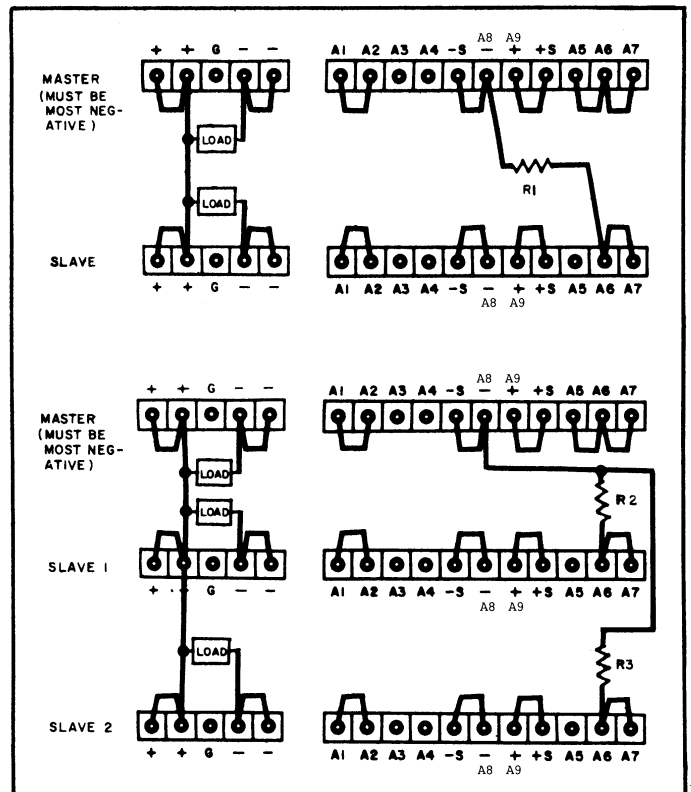

Figure 3-11. Auto-Tracking, Two and Three Units

3-40 OUTPUT CAPACITANCE

3-41 There are capacitors (internal) across the output terminals of the power supply. These capacitors help to supply high-current pulses of short duration during constant voltage operation. Any capacitance added externally will improve the pulse current capability, but will decrease the safety provided by the constant current circuit. A high-current pulse may damage load components before the average output current is large enough to cause the constant current circuit to operate.

3-42 The effects of the output capacitors during constant current operation are as follows:

- The output impedance of the power supply decreases with increasing frequency.
- The rise time of the output voltage is increased.
- A large surge current causing a high power dissipation in the load occurs when the load impedance is reduced rapidly.

3-43 NEGATIVE VOLTAGE LOADING

3-44 A diode is connected across the output terminals. Under normal operating conditions, the diode is reverse biased (anode connected to negative terminal). If a negative voltage is applied to the output terminals (positive voltage applied

to negative terminal), the diode will conduct, shunting current across the output terminals and limiting the voltage to the forward voltage drop of the diode. This diode protects the filter and output electrolytic capacitors.

3-45 NEGATIVE CURRENT LOADING

3-46 Certain types of loads may cause current to flow into the power supply in the direction oppo-

site to the output current. If the reverse current exceeds 0.6 Ampere, preloading will be necessary. For example; if the load delivers 1 Ampere to the power supply with the power supply output voltage at 18Vdc, a resistor equal to 18 ohms ($18V/1A$) should be connected across the output terminals. Thus, the 18 ohm resistor shunts the reverse current across the power supply. For more information on preloading, refer to Application Note 90, available at no charge from your  Sales Office.

SECTION IV
PRINCIPLES OF OPERATION

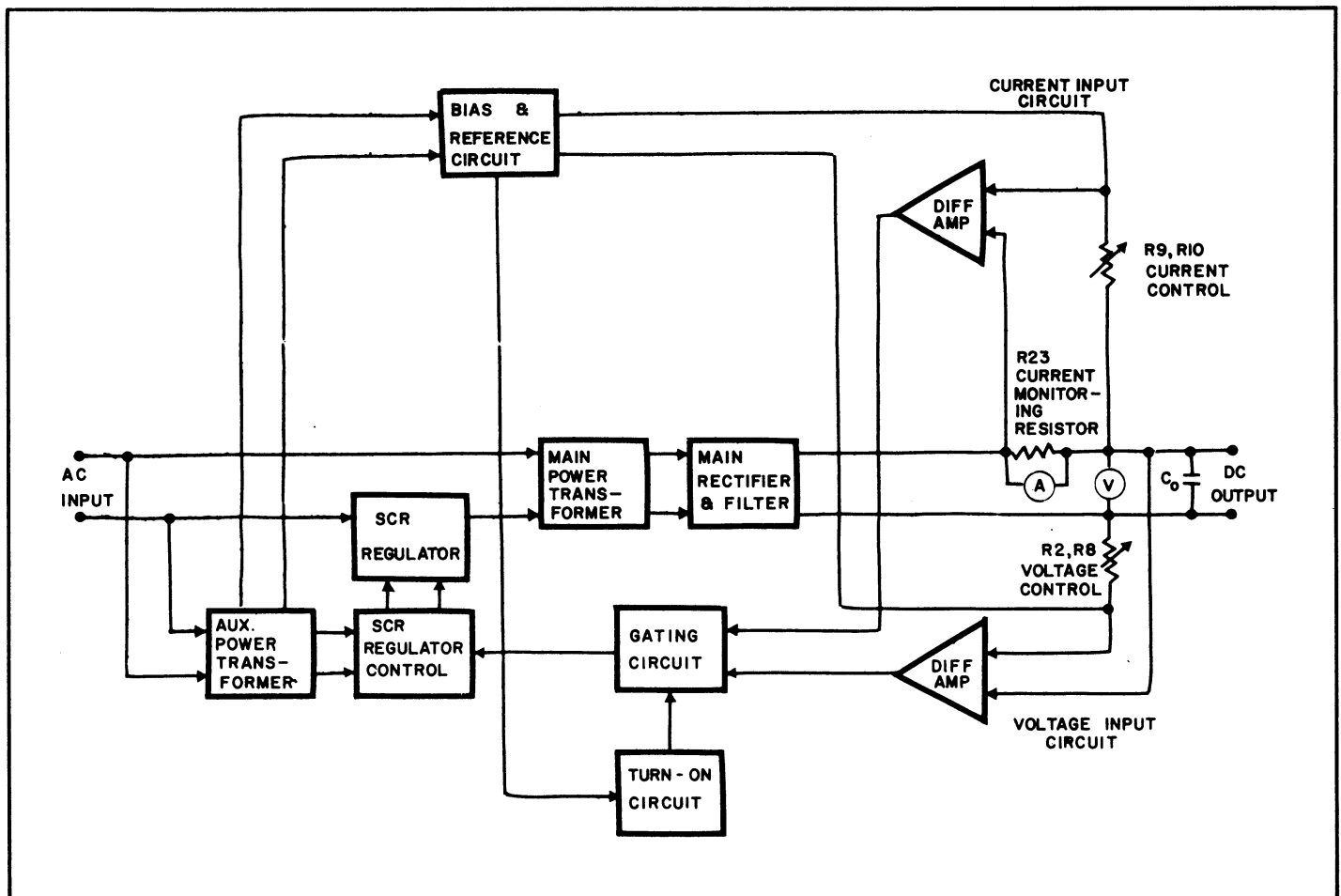

Figure 4-1. Block Diagram

4-1 BLOCK DIAGRAM DESCRIPTION (See Figure 4-1)

4-2 The main power transformer isolates the ac input from the power supply and reduces it to the voltage level required. Rectification and filtering produces a smoothed dc output across the - and + terminals. A large capacitor (C_0) is connected across the - and + terminals for low ac output impedance and to help supply large pulse currents. An SCR regulator controls the ac input to provide good regulation of the dc output. The auxiliary power transformer powers the SCR regulator control circuit and the bias and reference circuit which produces dc bias and reference voltages for the power supply.

4-3 The SCR regulator is controlled by the SCR regulator control circuit which operates in response to signals developed by the voltage or current input circuit. A gating circuit assures that only one input circuit is used at a time.

4-4 The voltage and current input circuits operate in a similar manner. Each circuit has a differential amplifier that amplifies an error voltage that is proportional to the difference between the actual output and the programmed output. The programmed output is determined by the resistance of the programming resistors (voltage and current controls). Each programming resistor has a constant current through it which is maintained by the bias and reference circuit.

4-5 The voltage input circuit differential amplifier detects the error voltage that is proportional to the difference between the voltage across its programming resistors (R2, R8) and the dc output voltage. The error voltage is amplified and passed through the gating circuit to the SCR regulator control which triggers the SCR regulator. The SCR regulator increases or decreases the ac input voltage to the main power transformer as required to maintain a constant load voltage that is equal to the programmed voltage. In constant voltage operation, the gating circuit is biased to inhibit the input from the current input circuit.

4-6 The current input circuit differential amplifier detects the error voltage that is proportional to the difference between the voltage across its programming resistors (R9-R10) and the voltage across current monitoring resistor R23. The voltage across R23 is proportional to the load current. The SCR regulator responds to the amplified error voltage by increasing or decreasing the ac input current to the main power transformers as required to maintain a constant load current. In constant current operation, the gating circuit is biased to inhibit the input from the voltage input circuit.

4-7 To prevent overvoltage and excessive surge current when the power supply is turned-on, the turn-on circuit establishes initial conditions in the gating circuit. The turn-on circuit is activated by the bias and reference circuit when the power supply is turned-off.

4-8 A voltmeter is connected across the - and + terminals to monitor the output voltage. An ammeter is connected across current monitoring resistor R23 to monitor the output current (proportional to voltage across R23).

4-9 CIRCUIT DESCRIPTION (See overall schematic at rear of manual.)

4-10 AC INPUT

4-11 The 115Vac $\pm 10\%$, 57-63Hz, single phase input is applied through circuit breaker CB1 to transformer T2 and to the series combination of transformer T1 and SCR's CR17 and CR18 which are in parallel opposition. The SCR's are used to regulate the dc output by controlling the average value of the ac input to transformer T1. Capacitors C11 and C12 smooth transients to prevent the SCR's from being triggered by a rapidly changing voltage from anode to cathode. Resistor R21 damps oscillations that may occur due to resonance of C12 and the leakage inductance of T1. The leakage inductance of T1 limits the peak input current. The fan is also energized by the ac input.

4-12 DC OUTPUT

4-13 The output of the secondary of transformer T1 is full-wave rectified by bridge rectifier CR19 through CR22 and filtered by pi-section filter C14 through C17, and L1. Resistor R29 damps the parallel resonance of L1 and C17. The dc output is regulated to a constant value by the SCR's in the ac input line. Capacitor C17 is the output capacitor. Diode CR23 is connected across the filtered dc output to protect the power supply from reverse voltage applied to the output terminals. Resistor R23 is the current monitoring resistor; the full load current flows through it. Resistors R25 and R27 are used to calibrate the voltmeter and ammeter, respectively.

4-14 VOLTAGE INPUT

4-15 The voltage input circuit is basically a differential amplifier (Q1-Q2) that detects any voltage difference between the programmed output voltage and the actual output voltage. The differential amplifier output voltage varies in proportion to the power supply output voltage variation.

4-16 Voltage divider R6-R47 maintains a slightly negative base bias to ensure that the output voltage can be programmed to zero. The output of Q2 is emitter-coupled (resistor R4) to Q1.

4-17 There are three inputs to the base of Q1; one determined by the programmed voltage (voltage controls R2-R8), the second determined by the collector voltage of Q1 (negative feedback), and the third is from the positive side of the main rectifier. The collector current of Q1 is determined by the difference between its base and emitter inputs. This difference is an error voltage that is proportional to the difference between the programmed output voltage and the actual output voltage. The negative feedback from collector to base (C4, and R17-R18 in parallel) improves the stability of the voltage-regulating feedback loop.

4-18 The input from the positive side of the main rectifier (C1 and R1) improves loop stability by making the differential amplifier insensitive to output voltage variations of four Hz or greater. Below four Hz this input is negligible. This input is necessary because the phase shift of the pi-section output filter begins to become excessive over four Hz. Resistors R1 and R5 are arranged so that the four Hz input is isolated from the negative feedback input; and so that necessary impedance levels are obtained looking out from the base of Q1. The collector output of Q1 is coupled to the gating circuit.

4-19 CLAMPING. In order to protect the differential amplifier, the base of Q1 is clamped with respect to -S by diodes CR1 and CR2 to prevent excessive base voltage in either direction. Diode CR1 clamps the base to approximately -0.7Vdc; CR2 and the base-emitter junction of Q1 clamp the base to approximately +1.4Vdc. Zener diodes VR1 and VR5 clamp the programming terminals to prevent an excessive error signal that would cause excessive output voltage. This would occur, for example, if the programming terminals were opened accidentally. To prevent overshoot when the power supply switches from constant current to constant voltage, diodes CR9 and CR10 clamp the collector of Q1. Resistor R30 provides a small bleed current for CR10.

4-20 CURRENT INPUT

4-21 The current input circuit is basically a differential amplifier (Q8-Q9) that detects any current difference between the programmed output current (proportional to voltage across current controls) and the actual output current (proportional to voltage across current monitoring resistor R23). The differential amplifier output voltage varies in proportion to the output current variation.

4-22 The input to the differential amplifier (across bases of Q8-Q9) is the voltage difference across current controls R9-R10 and current monitoring resistor R23. Because the programming current is constant in constant current operation, the voltage input to the differential amplifier varies as the load current through R23 (error voltage). Capacitors C6 and C24 and resistor R22 provide gain roll-off at high frequencies. Diode CR26 clamps the voltage (0.7Vdc) across the emitter-base junction of Q9 and R20. This clamping action prevents excessive reverse base voltage in Q9 when very large load current is drawn (output terminals shorted). To prevent overshoot when the power supply switches from constant voltage to constant current operation, diodes CR10 and CR12 clamp the collector of Q8.

4-23 Resistor R13 is the collector load for Q8. The collector output of Q8 is coupled to the gating circuit. Voltage divider R20-R46 biases the base of Q9 and maintains a slightly negative base bias to ensure that the output current can be programmed to zero. Resistor R44 provides positive feedback to improve load regulation during constant current operation.

4-24 GATING CIRCUIT

4-25 Transistor Q4 draws current from the SCR control circuit (capacitor C25). The magnitude of this current is determined by either the voltage or

current input circuit. For constant voltage operation, diode CR7 is forward biased to permit the voltage input circuit to drive Q4; diode CR8 is reverse biased to inhibit the input from the current input circuit. For constant current operation, the reverse occurs.

4-26 To prevent transients in the dc output when the power supply is turned-on, the turn-on of Q4 is delayed by capacitor C2 which charges through R12, R15 and CR5. When C2 charges sufficiently to reverse bias CR5, all the current through R15 flows to the base of Q4 to turn it on. This base current is controlled by the voltage or current input circuits via CR7 or CR8, respectively. For example, during constant voltage operation the collector voltage of Q1 (voltage input) forward biases CR17 (CR8 reverse biased by Q8), the current through CR7 will vary as Q1 collector voltage varies and thus vary Q4 base current; therefore, the collector current of Q4 is controlled by the voltage input. In a similar manner, the current input circuit controls the collector current of Q4 during constant current operation.

4-27 TURN-ON CIRCUIT

4-28 Transistor Q3 provides a path for rapidly discharging C2 (in gating circuit) when the power supply is turned-off. This assures that C2 is discharged if the power supply is turned-on shortly after turn-off. The purpose of having C2 discharged each time the power supply is turned-on is to maintain the same time delay in the turn-on of the gating circuit (refer to Paragraph 4-26).

4-29 SCR REGULATOR CONTROL (See waveshapes on schematic at rear of manual)

4-30 GENERAL. The SCR regulator control is basically a blocking oscillator (Q7 and T3) that applies pulses to the SCR regulator in response to error signals detected by the voltage or current input circuit. When transistor Q7 conducts, the pulse developed in winding 1-2 of transformer T3 is coupled to the base of Q7 (positive feedback) and to the SCR regulator (CR17 and CR18). Capacitor C27 charges in opposition to the feedback voltage and cuts off Q7. The charge time of C27 determines the pulse duration in the collector of Q7 (approximately 20 microseconds). The 35Vdc bias supplies current through R52, CR46, and CR44 to discharge C27 after Q7 stops conducting.

4-31 GATE INPUT. Throughout the operation of the blocking oscillator, capacitor C25 supplies most of the collector current for Q4 in the gating circuit (refer to Paragraph 4-25). The amount of current pulled from C25 by Q4 is determined by the input (from the voltage or current input circuit)

to the gating circuit. As a result of this current flow from C25, the voltage across C25 increases negatively with respect to the 6.0Vdc bias and has a waveshape that approximates a linear ramp. Thus, the slope of this ramp is determined by the voltage or current input circuit. Due to the time delay in the feedback loop, the slope of the ramp is constant for a half cycle of the ac input. The voltage on C25 is the emitter bias (forward bias when negative) for Q7 and therefore helps determine the point at which Q7 conducts.

4-32 AC INPUT. The ac input to transformer T2 is stepped-down and full-wave rectified by bridge rectifier CR39 through CR43. The output of the bridge rectifier is a negative-going pulsating dc (120Hz). Voltage divider R50-R51 supplies a portion of this pulsating dc through C27 to the base of Q7; thus, the base is reverse biased.

4-33 FIRING. A point is reached during each cycle of the 120Hz pulsating dc (each half cycle of the 60Hz ac input) when the reverse bias on the base and the forward bias (capacitor C25) on the emitter of Q7 are equal, and therefore Q7 has zero bias. As the ramp voltage across C25 goes more negative than the base voltage, the base-emitter junction of Q7 begins to become forward biased. When the emitter is more negative than the base by approximately 0.5 volts, Q7 conducts. The firing point of Q7 is therefore determined by both the dc output error and the line voltage change. Because Q7 saturates when it conducts, the collector voltage approximates a rectangular wave with a negative going pulse width of approximately 20 microseconds (determined by C27 and R51). The conduction of Q7 charges C25 in the positive direction (clamped by CR49). When Q7 stops conducting, the ramp across C25 begins again. However, Q7 is held cut-off by the charge on C27.

4-34 INITIAL CONDITIONS. At the beginning of each cycle of the 120Hz pulsating dc, certain initial conditions must be established on capacitors C25 and C27. When the negative-going pulsating dc is at the end of its cycle (C27 negatively charged earlier in the cycle by the feedback voltage), CR44 and CR45 become forward biased and current flows from the 35Vdc bias through R52, CR46, and CR44 to discharge C27 to approximately zero Volts and through R52, CR46, and CR45 to charge C25 to approximately 0.7 Volts (clamped by CR49). This discharge and charge occurs rapidly, so that it is completed before the next cycle begins and Q7 can conduct again. Diode CR47 provides another path for the current through CR44 so that the voltage to which C27 discharges remains predictable. As the negative-going pulsating dc increases in the next cycle, CR44 and CR45 be-

come reverse biased.

4-35 BRIDGE RECTIFIER. At the zero cross-over region of the voltage waveform on secondary winding 3-4 of transformer T2, the voltage is insufficient to forward bias the rectifiers in the bridge. In order to maintain definition between the end of one cycle of the rectified output and the beginning of the next cycle, diode CR41 provides approximately 0.7 Volts at the rectified output. The current for CR41 is supplied through CR46. As the voltage across the secondary winding moves away from the zero cross-over region, CR41 becomes reverse biased.

4-36 TRANSIENTS, DECOUPLING AND PROTECTION. Transients in the pulsating dc are reduced by R56 and C28. The base of Q7 is decoupled by C3. The voltage spike in the collector of Q7, induced by secondary winding 1-2 of transformer T3 when Q7 cuts-off, is clamped by CR48. The collector is decoupled by R53 and C26. To protect the power supply and load, thermostat TS1 opens the collector circuit of Q7 when the temperature of the SCR heat sinks exceeds 80°C.

4-37 SCR REGULATOR

4-38 The SCR regulator (CR17 and CR18) controls the ac input voltage and current to main power transformer T1 in response to the voltage and current error signals. In constant voltage operation, the ac input voltage to T1 is adjusted so that the output voltage remains constant with changing loads. In constant current operation, the ac input current to T1 is adjusted so that the output current remains constant with changing loads and the output voltage is allowed to vary.

4-39 GATING. Each half cycle of the ac input, either CR17 or CR18 is forward biased. The pulse induced in secondary windings 5-6 and 7-8 of T3 by the SCR control, turns on the SCR that is forward biased when the pulse occurs. The other SCR is not affected by the gate pulse because it is reverse biased. A gate pulse occurs each half cycle of the ac input, unless the output is open. The timing of the gate pulse with respect to the ac input is determined by the error in the dc output via the loop action.

4-40 AC INPUT CONTROL. When an SCR is gated on, it conducts until its anode-to-cathode voltage goes to approximately zero. Thus, the earlier an SCR is gated on, the greater the portion of the ac input that will be applied to T1. Because of the leakage inductance of T1, the conduction of an SCR may extend into the next half cycle. The conduction period may be shortened at high output by the voltage across capacitor C13 through C16

being reflected back into the primary. By controlling the ac input to T1 each half cycle, the average value of the voltage or current at the output of bridge rectifier CR19 through CR21 is adjusted so that dc output voltage or current is maintained constant.

4-41 PROTECTION. Diodes CR50 and CR51 prevent anode induced reverse gate currents from being fed back to the control circuit. Resistors R54 and R55 limit current in the SCR gates.

4-42 BIAS AND REFERENCE CIRCUIT

4-43 The bias and reference circuit supplies three voltages (+35, +6.0, and -19.5Vdc) for internal power supply operation, and maintains the programming currents constant. The +35Vdc is not regulated. The -19.5Vdc, +6.0Vdc, and the programming currents are regulated.

4-44 +35 AND +6.0VDC. The output of secondary winding 5-6 of transformer T2 is full-wave rectified by CR30 and CR31. Capacitors C20 and C21 each charge to the peak rectified voltage (voltage doubling). The +6.0Vdc (with respect to -S) is maintained by diodes CR6 and CR14 and by zener diode VR4. The +35Vdc includes the +6.0Vdc and the negative voltage across C20 provide the unregulated input to the -19.5Vdc regulator.

4-45 -19.5VDC. For the -19.5Vdc, transistor Q10 is the error detector/amplifier. Zener diode VR3 and diode CR27 provide a reference voltage at the emitter of Q10. Voltage divider R35-R36 supplies an error voltage to the base of Q10 which amplifies and applies it to the base of series regulator Q11. The base drive of Q11 adjusts the voltage across Q11 as required to compensate for the error in the -19.5Vdc. Resistor R37 sets the optimum current through temperature-compensated zener diode VR3. Resistor R45 improves the line regulation. Resistor R56 reduces power dissipation in Q11. Capacitor C22 stabilizes the loop.

4-46 PROGRAMMING CURRENTS. Each programming current is held constant in a similar manner. The voltage across emitter resistors R38 and R40 is held constant by VR3, CR27, and the base-emitter drop of each transistor. Thus, the emitter current in each transistor is constant and therefore the collector currents are nearly constant. The collector currents of Q5 and Q6 are the constant voltage and constant current programming currents, respectively. Resistors R39 and R41 are used for trimming. Resistors R42 and R43 are collector loads. Diode CR28 clamps the collector of Q5 to protect against excessive positive voltage (breakdown) which might occur if the voltage controls are reduced to zero rapidly (positive dc output voltage would appear at collector).

SECTION V
MAINTENANCE

5-1 GENERAL

5-2 Table 5-1 lists the type of test equipment, its required characteristics, its use, and a recommended model for performing the instructions given in this section. Upon receipt of the power supply, the performance check (Paragraph 5-7) should be made. This check is suitable for incoming inspection. Additional specification checks are given in Paragraphs 5-24 through 5-35. If a fault is detected in the power supply while making the performance check or during normal operation,

proceed to the troubleshooting procedures (Paragraph 5-39). After troubleshooting and repair (Paragraph 5-46), perform any necessary adjustments and calibrations (Paragraph 5-48). Before returning the power supply to normal operation, repeat the performance check to ensure that the fault has been properly corrected and that no other faults exist. Before doing any maintenance checks, turn-on power supply, allow a half-hour warm-up, and read the measurement techniques (Paragraph 5-3).

Table 5-1. Test Equipment

Type	Required Characteristics	Use	Recommended Model
Differential Voltmeter	Sensitivity: 1mV full scale (min.) Input impedance: 10 megohms	Measure regulation and dc voltages; calibrate meters	Ⓢ 741A (See Note 1)
AC Voltmeter	Accuracy: 2% Sensitivity: 1mV full scale (min.)	Measure ac voltages and ripple	Ⓢ 403B
Variable Voltage Transformer	Range: 90-130 Volts Equipped with voltmeter accurate within 1 Volt	Vary and measure ac input voltage	--
Oscilloscope	Sensitivity: 5mV/cm (min.) Differential input	Measure ripple and transient response	Ⓢ 130C
Battery	18Vdc	Measure transient response	--
Switch	45 Ampere capacity	Transient response; Constant current load regulation	--
Resistor	1.6 ohm, ±5% 1 kW	Load resistor	Rex Rheostat (See Note 2)
Resistor	1 milliohm, 45 Amperes 4 terminals	Current monitoring	Any 50mV, 50 Ampere meter shunt

Table 5-1. Test Equipment (Continued)

Type	Required Characteristics	Use	Recommended Model
Resistor	1,000 ohms, $\pm 1\%$, 2W non-inductive	Measure impedance	--
Resistor	100 ohms, $\pm 5\%$ 10W	Measure impedance	--
Capacitor	500 μ fd, 50 VdcW	Measure impedance	--
Oscillator	Range: 1Hz to 100kHz Accuracy: 2% Output: 10 Vrms	Measure impedance	Ⓜ 202C
Controlled-temperature Oven	Range: 0-50°C	Measure temperature stability	--
Resistance Box	Range: 0-3,600 ohms Accuracy: 0.1% plus 1 ohm Make-before-break contacts	Measure programming coefficients	Ⓜ 6931A

NOTE #1

A satisfactory substitute for a differential voltmeter is to arrange a reference voltage source and null detector as shown in Figure 5-1. The reference voltage source is adjusted so that the voltage difference between the supply being measured and the reference voltage will have the required resolution for the measurement being made. The voltage difference will be a function of the null detector that is used. For measurements at the base of transistor Q4, a null detector with input impedance of 10 megohms or greater is required. Otherwise, satisfactory null detectors are: Ⓜ 405AR digital voltmeter, Ⓜ 412A dc voltmeter, Ⓜ 419A null detector, a dc coupled oscilloscope utilizing differential input, or a 50mV meter movement with a 100 division scale. A 2mV change in voltage will result in a meter deflection of four divisions.

CAUTION

Care must be exercised when using an electronic null detector in which one input terminal is grounded to avoid ground loops and circulating currents.

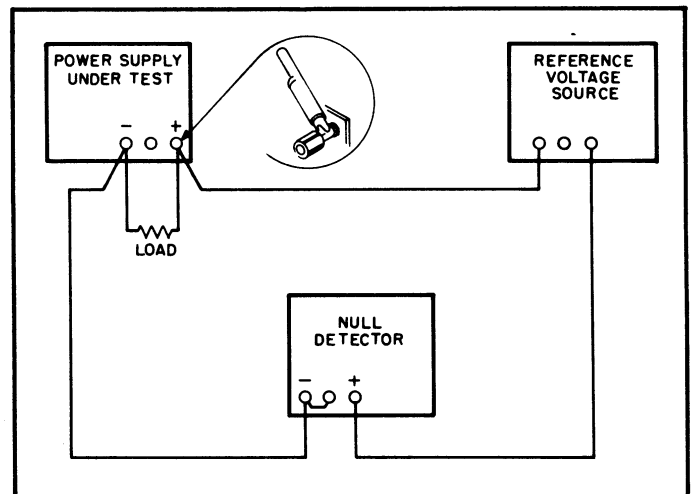

Figure 5-1. Differential Voltmeter Substitute, Test Setup

NOTE #2

To obtain 1.6 ohms, connect rheostat across output terminals, turn front-panel CURRENT controls fully clockwise (maximum), adjust front-panel VOLTAGE controls for 40Vdc and adjust rheostat until output current is 25 Amperes. Use fan to cool rheostat.

5-3 MEASUREMENT TECHNIQUES

5-4 A measurement made across the load includes the effect of the impedance of the leads connecting the load; these leads can have an impedance several orders of magnitude greater than the output impedance of the power supply. When measuring the output voltage of the power supply, use the -S and +S terminals.

5-5 For output current measurements, the current monitoring resistor should be a four-terminal resistor. The four terminals are connected as shown in Figure 5-2.

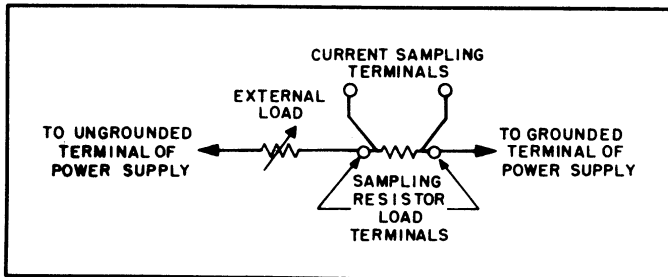

Figure 5-2. Output Current Measurement Technique

5-6 When using an oscilloscope, ground one terminal of the power supply and ground the case at the same ground point. Make certain that the case is not also grounded by some other means (power line). Connect both oscilloscope input leads to the power supply ground terminal and check that the oscilloscope is not exhibiting a ripple or transient due to ground loops, pick-up, or other means.

5-7 PERFORMANCE CHECK

5-8 GENERAL

5-9 The performance check is made using a 115 Volt, 60Hz, single-phase input power source. The performance check is normally made at a constant ambient room temperature. The temperature range specification can be verified by doing the performance check at a controlled temperature of 0°C and at a controlled temperature of 50°C. If the correct result is not obtained for a particular check, do not adjust any controls; proceed to troubleshooting (Paragraph 5-39).

5-10 RATED OUTPUT AND METER ACCURACY

5-11 CONSTANT VOLTAGE. Proceed as follows:
a. Connect the 1.6 ohm load resistor across the output terminals and the differential voltmeter across the -S and +S terminals.

- b. Turn front-panel CURRENT controls fully clockwise (maximum).
c. Turn front-panel VOLTAGE controls until front-panel voltmeter indicates 40.0Vdc.
d. The differential voltmeter should indicate 40 ± 0.80 Vdc.

5-12 CONSTANT CURRENT. Proceed as follows:

- a. Connect test setup shown in Figure 5-3.
b. Turn front-panel VOLTAGE controls fully clockwise (maximum).
c. Turn front-panel CURRENT controls until front-panel ammeter indicates 25.0 Amperes.
d. The differential voltmeter should indicate 0.5 ± 0.01 V.

5-13 LINE REGULATION

5-14 CONSTANT VOLTAGE. Proceed as follows:

- a. Connect the 1.6 ohm load resistor across the output terminals and the differential voltmeter across the -S and +S terminals.
b. Turn front-panel CURRENT controls fully clockwise (maximum).
c. Connect the variable voltage transformer between the input power source and the power supply power input. Adjust the variable voltage transformer to 105Vac.
d. Turn front-panel VOLTAGE controls until the differential voltmeter indicates 40.0Vdc.
e. Adjust the variable voltage transformer to 125Vac.
f. Differential voltmeter indication should change by less than 18mVdc.

5-15 CONSTANT CURRENT. Proceed as follows:

- a. Connect test setup shown in Figure 5-3.
b. Turn front-panel VOLTAGE controls fully clockwise (maximum).
c. Connect the variable voltage transformer between the input power source and the power supply power input. Adjust the variable voltage transformer to 105Vac.
d. Turn front-panel CURRENT controls until front-panel ammeter indicates 25 Amperes.
e. Record voltage indicated on differential voltmeter.

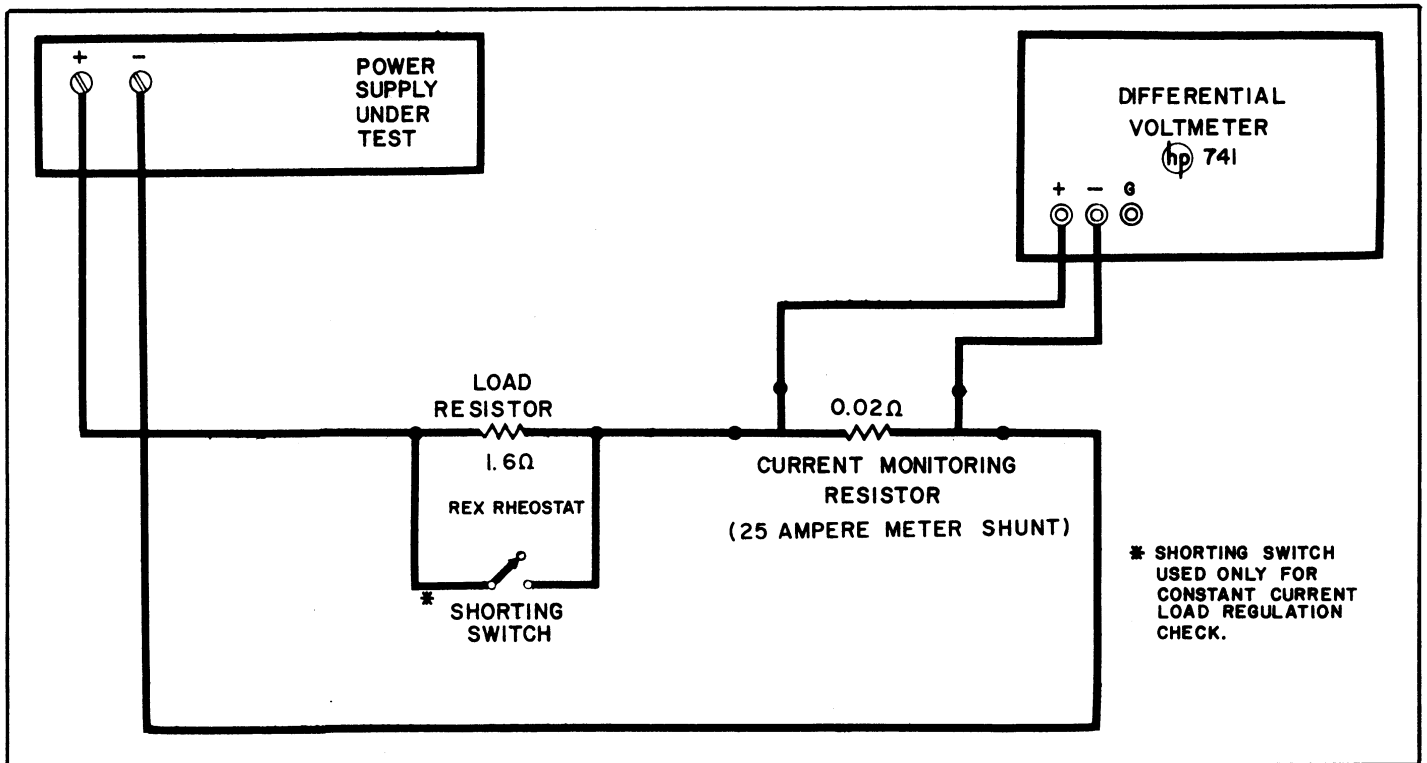

Figure 5-3. Constant Current, Test Setup

- f. Adjust the variable voltage transformer to 125Vac.
- g. Differential voltmeter indication should change by less than 4.0 mVdc.

5-16 LOAD REGULATION

5-17 CONSTANT VOLTAGE. Proceed as follows:

- a. Connect the 1.6 ohm load resistor across the output terminals and the differential voltmeter across the -S and +S terminals.
- b. Turn front-panel CURRENT controls fully clockwise (maximum).
- c. Turn the front-panel VOLTAGE controls until front-panel ammeter indicates 25 Amperes.
- d. Record voltage indicated on differential voltmeter.
- e. Disconnect load resistor.
- f. Differential voltmeter indication should change by less than 40 mVdc.

5-18 CONSTANT CURRENT. Proceed as follows:

- a. Connect test setup shown in Figure 5-3.
- b. Turn front-panel VOLTAGE controls fully clockwise (maximum).

- c. Turn front-panel CURRENT controls until front-panel ammeter indicates 25 Amperes.
- d. Record voltage indicated on differential voltmeter.
- e. Close the shorting switch.
- f. Differential voltmeter indication should change by less than 4.0 mVdc.

5-19 RIPPLE AND NOISE

5-20 Proceed as follows:

- a. Connect the 1.6 ohm load resistor across the output terminals and the ac voltmeter across the -S and +S terminals.
- b. Turn front-panel CURRENT controls fully clockwise (maximum).
- c. Connect the variable voltage transformer between the input power source and the power supply power input. Adjust the variable voltage transformer to 125Vac.
- d. Turn front-panel VOLTAGE controls until front-panel ammeter indicates 25 Amperes.
- e. The ac voltmeter should indicate less than 40 mVrms.

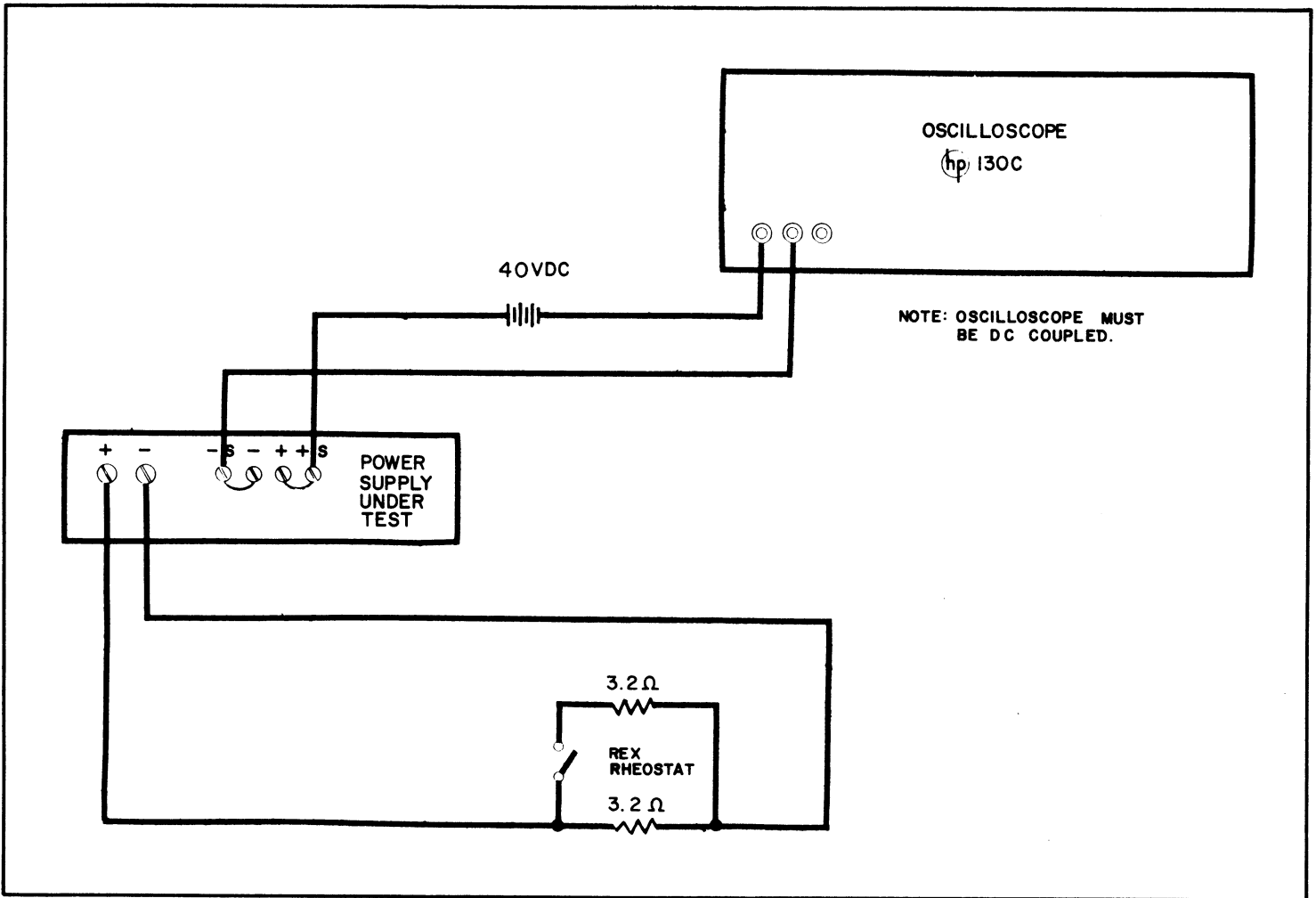

Figure 5-4. Transient Recovery Time, Test Setup

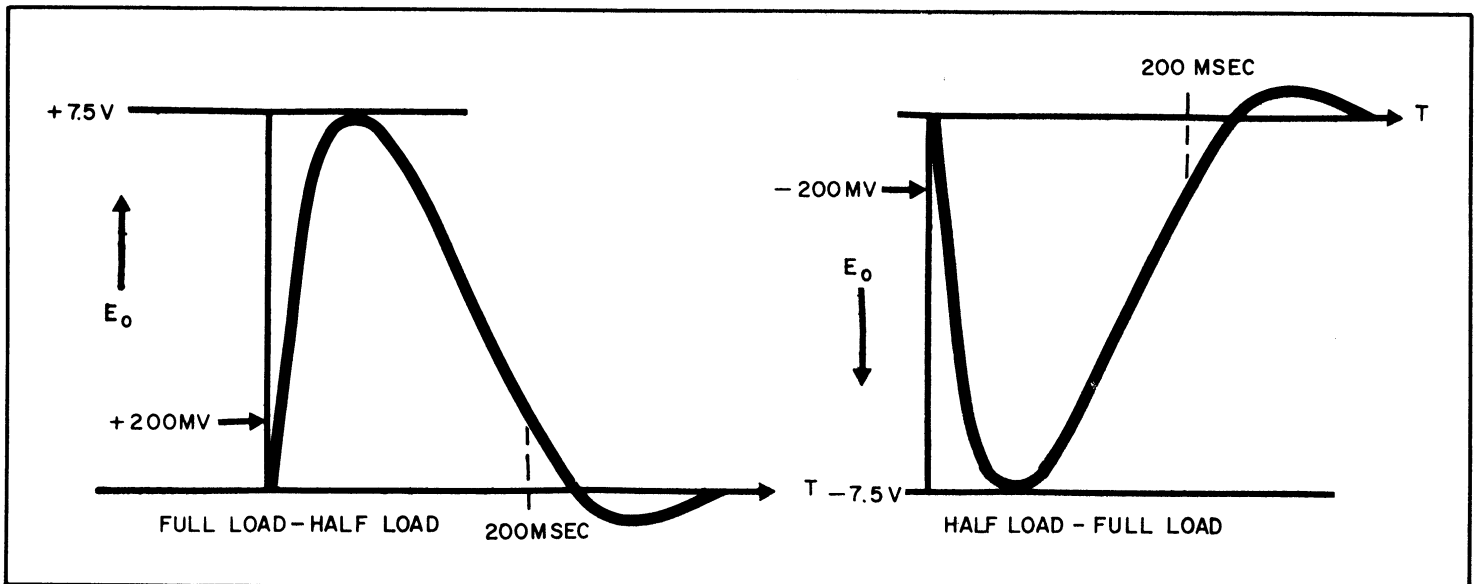

Figure 5-5. Transient Recovery Time, Waveform

5-21 TRANSIENT RECOVERY TIME

5-22 Proceed as follows:

- a. Connect test setup shown in Figure 5-4.
- b. Turn front-panel CURRENT controls fully clockwise (maximum).
- c. Turn front-panel VOLTAGE controls until front-panel ammeter indicates 25 Amperes.
- d. Open and close the switch several times and observe the oscilloscope display.
- e. Oscilloscope display should be as shown in Figure 5-5.

5-23 ADDITIONAL SPECIFICATION CHECK

5-24 TEMPERATURE COEFFICIENT

5-25 CONSTANT VOLTAGE. Proceed as follows:

- a. Connect the 1.6 ohm load resistor across the output terminals and the differential voltmeter across the -S and +S terminals.
- b. Turn front-panel CURRENT controls fully clockwise (maximum).
- c. Turn front-panel VOLTAGE controls until the differential voltmeter indicates 40Vdc.
- d. Insert the power supply into the controlled-temperature oven (differential voltmeter and load remain outside oven). Set the temperature to 30°C and allow a half-hour warm-up.
- e. Record the differential voltmeter indication.
- f. Raise the temperature to 40°C and allow a half-hour warm-up.
- g. Differential voltmeter indication should change by less than 125 mVdc from indication recorded in step e.

5-26 CONSTANT CURRENT. Proceed as follows:

- a. Connect test setup shown in Figure 5-3.
- b. Turn front-panel VOLTAGE controls fully clockwise (maximum).
- c. Turn front-panel CURRENT controls until the differential voltmeter indicates 0.5 Volts.
- d. Insert the power supply into the controlled-temperature oven (differential voltmeter and load remain outside oven). Set the temperature to 30°C and allow a half-hour warm-up.
- e. Record the differential voltmeter indication.
- f. Raise the temperature to 40°C and allow a half-hour warm-up.
- g. Differential voltmeter indication should change by less than 15 mVdc from indication recorded in step e.

5-27 OUTPUT STABILITY

5-28 CONSTANT VOLTAGE. Proceed as follows:

- a. Connect the 1.6 ohm load resistor across the output terminals and the differential voltmeter

across the -S and +S terminals.

- b. Turn front-panel CURRENT controls fully clockwise (maximum).
- c. Turn front-panel VOLTAGE controls until the differential voltmeter indicates 40Vdc.
- d. Allow a half-hour warm-up and then record the differential voltmeter indication.
- e. After eight hours, the differential voltmeter indication should change by less than 60 mVdc from indication recorded in step d.

5-29 CONSTANT CURRENT. Proceed as follows:

- a. Connect test setup shown in Figure 5-3.
- b. Turn front-panel VOLTAGE controls fully clockwise (maximum).
- c. Turn front-panel CURRENT controls until the differential voltmeter indicates 0.5 Volts.
- d. Allow a half-hour warm-up and then record the differential voltmeter indication.
- e. After eight hours, the differential voltmeter indication should change by less than 5 mVdc.

5-30 OUTPUT IMPEDANCE

5-31 Proceed as follows:

- a. Connect test setup shown in Figure 5-6.
- b. Turn front-panel CURRENT controls fully clockwise (maximum).
- c. Turn front-panel VOLTAGE controls until front-panel voltmeter indicates 9Vdc.
- d. Adjust the oscillator for a 10 V_{rms} (E_{in}), 0.5 Hz output.
- e. Calculate and record the output impedance using the following formula:

$$Z_{out} = E_o R / (E_{in} - E_o)$$

$R = 1,000$ ohms; E_o measured across power supply -S and +S terminals using ac voltmeter; E_{in} measured across oscillator output terminals using the ac voltmeter.

- f. Using the formula given in step e, calculate and record the output impedance for oscillator frequencies of 100Hz, 1kHz, and 100kHz.
- g. The output impedance calculated and recorded in steps e and f should fall into the following ranges:
 - (1) dc to 0.5Hz; less than 0.01 ohm
 - (2) 0.5Hz to 100Hz; less than 0.5 ohm
 - (3) 100Hz to 1kHz; less than 0.1 ohm
 - (4) 1kHz to 100kHz; less than 0.6 ohm

5-32 OUTPUT INDUCTANCE

5-33 Proceed as follows:

- a. Repeat steps a through c of Paragraph 5-31.
- b. Adjust the oscillator for a 10 V_{rms} (E_{in}), 10kHz output.

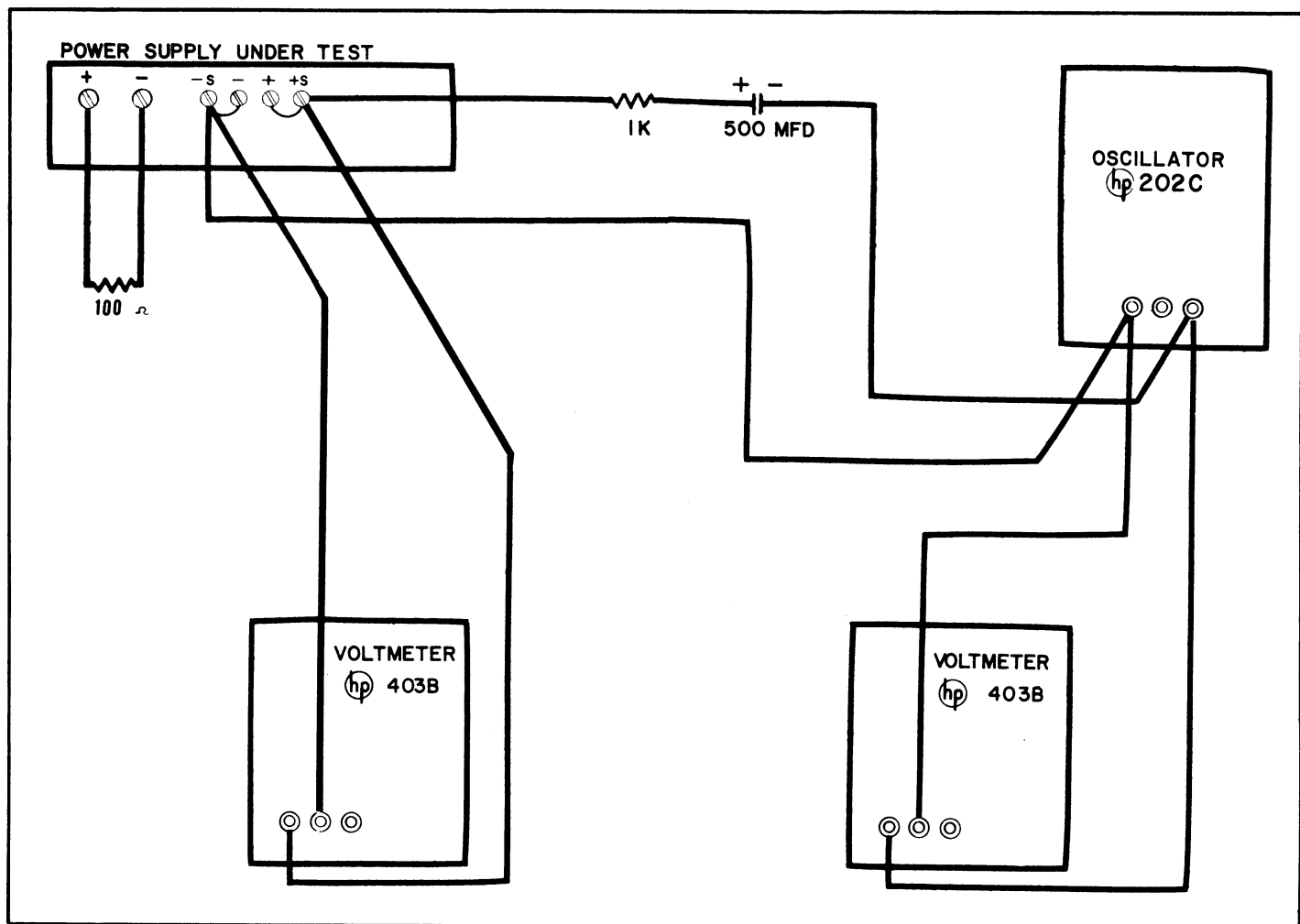

Figure 5-6. Output Impedance, Test Setup

c. Calculate and record the output inductance using the following formula:

$$L = X_1 / 2\pi f$$

X_1 is the output impedance (Z_{Out}) calculated in steps e and f of Paragraph 5-31; f is the frequency of the oscillator (determines which Z_{Out} is used).

NOTE

The equation assumes that $X_1 \gg R_{out}$ and therefore $X_1 = Z_{out}$.

d. Using the formula given in step c, calculate and record the output inductance for oscillator frequencies of 50kHz and 100kHz at 10Vrms.

e. The output inductance calculated in steps c and d should not exceed 1.0 microhenry.

5-34 COVER REMOVAL

5-35 The top and bottom covers are removed by removing both sets of six attaching screws.

5-36 TROUBLESHOOTING

5-37 GENERAL

5-38 If a fault in the power supply is suspected, remove the covers (Paragraph 5-35) and visually inspect for broken connections, burned components, etc. If the fault is not detected visually, proceed to trouble analysis (Paragraph 5-39). If the fault is detected visually or via trouble analysis, correct it and then do the performance check (Paragraph 5-7). If a part is replaced, refer to repair and replacement (Paragraph 5-47) and to adjustments and calibrations (Paragraph 5-48).

Table 5-2. Normal Voltage

From (+)	To (-)	Voltage	Typical Peak-to-Peak Values
-S	51	19.5 ±1.0Vdc	0.05V
33	27	34.1 ±1.7Vdc	1.0 V
33	-S	6.0 ±0.3Vdc	0.1 V
40	33	33.0 ±1.7Vdc	0.6 V
24	51	10.3 ±0.6Vdc	---
22	51	9.7 ±0.5Vdc	---
21	51	9.7 ±0.5Vdc	---
23	22	7.1 ±0.7Vdc	---
20	21	3.1 ±0.3Vdc	---
39	38	0.81 ±0.1Vdc	---
51	27	6.6 ±2.0Vdc	1.0 V
33	12	6.0 ±0.6Vdc	---
26	27	0.59 ±0.1Vdc	---
-S	25	10.0 ±0.5Vdc	---
14	19	0.83 ±0.1Vdc	---
-S	A6	0.04 ±0.1Vdc	---
-S	8	0.45 ±0.07Vdc	---
10	-S	0.06 ±0.1Vdc	---
19	-S	0.82 ±0.1Vdc	---
15	19	1.14 ±0.2Vdc	---
33	16	0.74 ±0.1Vdc	---
33	36	0.8 ±0.1Vdc	---
41	42	46.0 ±2.3Vpp	---
28	33	66.0 ±3.3Vpp	---
33	38	14.0 ±1.4Vdc	---

NOTE

These measurements were made with a 115 Volt, 60Hz, single-phase power input; the front-panel CURRENT controls fully clockwise (maximum); the front-panel VOLTAGE controls set for 40Vdc output; and the 1.6 ohm load resistor across the output terminals (25 Amperes). Differential voltmeter Ⓢ 741A was used for all measurements.

5-39 TROUBLE ANALYSIS

5-40 GENERAL. Before attempting trouble analysis, a good understanding of the principles of operation should be acquired by reading Section IV of this manual. Once the principles of operation are understood, logical application of this knowledge in conjunction with significant waveforms (on Figure 4-2) and with normal voltage information (Table 5-2) should suffice to isolate a fault to a part or small group of parts. As additional aids, the following are given:

a. Procedure for checking the bias and reference circuit. (Refer to Paragraph 5-42.) Trouble in this circuit could show up in many ways because it supplies internal operating voltages for

the power supply and the programming currents.

b. Procedures for checking the voltage feedback loop for the two most common troubles; high or low output voltage (Paragraph 5-43 or 5-44, respectively).

c. Paragraph 5-45 which discusses common troubles.

5-41 A defective part should be replaced (refer to the parts list in Section VI). Test points called out in the procedures are identified on the schematic diagram (Figure 4-2).

5-42 BIAS AND REFERENCE CIRCUIT. Proceed as follows:

a. Make an ohmmeter check to be certain that neither the positive nor negative terminal is grounded.

b. Turn front-panel VOLTAGE and CURRENT controls fully clockwise (maximum).

c. Turn-on power supply (no load connected).

d. Using the ac voltmeter, check voltage across secondary winding 5-6 of transformer T2. If voltage indication is not 23 ± 1.5 Vrms, transformer T2 may be defective.

e. Using the differential voltmeter, proceed as instructed in Table 5-3.

Table 5-3. Bias and Reference Circuit Troubleshooting

Step	Meter Common	Meter Positive	Normal Indication	If Indication is Not Normal, Check the Following Parts
1	33	40	$33 \pm 1.7\text{Vdc}$	CR31, C21
2	-S	33	$6.2 \pm 0.3\text{Vdc}$	CR6, CR14, VR4
3	27	33	$34.1 \pm 1.7\text{Vdc}$	CR30, C20
4	51	-S	$19.5 \pm 1.0\text{Vdc}$	Q10, Q11
5	51	24	$10.3 \pm 0.6\text{Vdc}$	CR27, VR3
6	51	22	$9.7 \pm 0.5\text{Vdc}$	R40, R43, Q6
7	51	21	$9.7 \pm 0.5\text{Vdc}$	R38, R42, Q5

Table 5-4. High Output Voltage Troubleshooting

Step	Meter Common	Meter Positive	Response	Probable Cause
1	Emitter of Q4	29	$<0.5\text{Vdc}$	a. Q4 shorted b. R16 shorted c. R15 shorted
2	14	17	$>0.85\text{Vdc}$	CR7 open
3	14	33	$<2\text{Vdc}$	a. Q1 open b. Q2 shorted c. CR1 shorted d. R2-R8 open

Table 5-5. Low Output Voltage Troubleshooting

Step	Meter Common	Meter Positive	Response	Probable Cause
1	Emitter of Q4	29	$>5\text{Vdc}$	a. Q4 open b. R16 open c. R15 open
2	14	17	$<0.4\text{Vdc}$	CR7 shorted
3	14	33	$>6\text{Vdc}$	a. Q1 shorted b. Q2 open c. R2-R8 shorted

5-43 HIGH OUTPUT VOLTAGE. Proceed as follows:

- a. Turn front-panel CURRENT controls fully clockwise (maximum).
- b. Turn front-panel VOLTAGE controls to mid-position.
- c. Turn-on power supply (no load connected).
- d. Using the ac voltmeter, check voltage across test points ACC and 45. If voltage indication is less than 1.0Vdc, CR17 or CR18 may be shorted.
- e. Using the differential voltmeter, check voltage across test points 33 and 36. If voltage is not 0.8 ± 0.12 Vdc, check T2, CR39 through CR43, R50, and R51.
- f. Using the differential voltmeter, proceed as instructed in Table 5-4.

5-44 LOW OUTPUT VOLTAGE. Proceed as follows:

- a. Turn front-panel CURRENT controls fully clockwise (maximum).
- b. Disconnect anode or cathode of diode CR8.
- c. Turn-on power supply (no load connected).
- d. Turn front-panel VOLTAGE controls clockwise and observe the front-panel voltmeter to see if the 40Vdc output can be obtained. If it can, the probable cause of the low output voltage is one or more of the following:
 - (1) CR8 shorted.
 - (2) Q8 shorted.
 - (3) Q9 open.
 - (4) Q6 open.
 - (5) R40, R43 open.
- e. If the 40Vdc output cannot be obtained in step d, reconnect diode CR8 and turn the front-panel VOLTAGE controls to mid-position.

f. Using the oscilloscope, check the following:

(1) Waveform across test points 31 (positive lead) and 33 (waveform on Figure 4-2). If peak negative voltage is less than 15 Volts, Q7, R53, CR48, C25, C26, or transformer T3 may be defective. It is also possible that thermostat TS1 has opened due to excessive heat.

(2) Ripple waveform across test points 18 (positive lead) and 48 (waveform shown on Figure 4-2). If waveform is correct (except for amplitude), proceed to step (3). If waveform is incorrect, proceed as follows:

(a) If the ripple waveform is half-wave (60Hz) instead of full-wave (120Hz), either SCR (CR17 or CR18) may be open or the applicable gate circuit for the SCR may be defective. To check the gate circuit, disconnect R54 or R55 (as applicable) and make an ohmmeter check from the open end of the resistor to test point ACC or 45 (as applicable). If the resistance is greater than 55 ohms, the gate circuit is defective.

(b) If the ripple waveform indicates that neither SCR has fired, CR17 or CR18 may be shorted.

(c) If there is no ripple waveform, both CR17 and CR18 may be open or T1 may be defective.

g. Using the differential voltmeter, proceed as instructed in Table 5-5.

5-45 COMMON TROUBLES. Table 5-6 gives the symptoms, checks, and probable causes for common troubles. The checks should be made using a 115-volt, 60Hz, single-phase power input and the test equipment listed in Table 5-1.

Table 5-6. Common Troubles

Symptom	Checks and Probable Causes
Circuit breaker CB1 trips when power supply is turned on.	Power supply has internal short. Disconnect collector of Q7, turn-on power supply and check voltages (refer to Table 5-2 or Figure 4-2). If CB1 trips with Q7 disconnected, check CR17, CR18, and T3.
Poor line regulation (constant voltage)	<ol style="list-style-type: none"> a. Check bias and reference circuit (Paragraph 5-42). Refer to Paragraph 5-66 for adjustment. b. Check line input to SCR regulator control circuit (T2, CR39 through CR43, R50, R51).
Poor load regulation (constant voltage)	<ol style="list-style-type: none"> a. Check bias and reference circuit (Paragraph 5-42). b. Power supply going into current limit. Check constant current input circuit. c. Constant voltage loop oscillates. Check adjustment of R17 (Paragraph 5-68).

Table 5-6. Common Troubles (Continued)

Symptom	Checks and Probable Cause
Poor line and load regulation (constant current)	<ul style="list-style-type: none"> a. Check bias and reference circuit (Paragraph 5-42). Refer to Paragraph 5-66 for adjustment. b. Power supply going into voltage limit. Check constant voltage input circuit. c. Constant current loop oscillates. Check adjustment of R44 (Paragraph 5-70).
High ripple	<ul style="list-style-type: none"> a. Check operating setup for ground loops. b. If output is floating (ungrounded) connect 1μf capacitor between output and ground (unless particular application prohibits this). c. Check pi-section output filter C13 through C17 and L1. d. Line imbalance. Check adjustment of R17 (Paragraph 5-67).
Poor stability (constant voltage)	<ul style="list-style-type: none"> a. Check bias and reference circuit line regulation. (Refer to Paragraph 5-66.) b. Noisy programming resistors (R2-R8). c. CR1 or CR2 leaky. d. R1, R5, R40, R41, or R43 noisy or drifting. e. Q1 or Q2 defective.
Poor stability (constant current)	<ul style="list-style-type: none"> a. Check bias and reference circuit line regulation. (Refer to Paragraph 5-66). b. Noisy programming resistors (R9-R10). c. R20, R23, R38, R39, or R42 noisy or drifting. d. Q8 defective.
Oscillates (constant voltage)	Check R18, C1, C4, and adjustment of R17 (Paragraph 5-68).
Oscillates (constant current)	Check C6, C24, R22, and adjustment of R20 (Paragraph 5-63) and adjustment of R44 (Paragraph 5-69).
Output voltage does not go to zero.	Check R6 and R47. (Refer to Paragraph 5-60.)
Output current does not go to zero.	Check R20 and R46. (Refer to Paragraph 5-64.)

5-46 REPAIR AND REPLACEMENT

5-47 Before servicing etched circuit boards, refer to Figure 5-7. After replacing a semiconductor

device, refer to Table 5-7 for checks and adjustments that may be necessary. If a check indicates a trouble, refer to Paragraph 5-36. If an adjustment is necessary, refer to Paragraph 5-48.

Excessive heat or pressure can lift the copper strip from the board. Avoid damage by using a low power soldering iron (50 watts maximum) and following these instructions. Copper that lifts off the board should be cemented in place with a quick drying acetate base cement having good electrical insulating properties.

A break in the copper should be repaired by soldering a short length of tinned copper wire across the break.

Use only high quality rosin core solder when repairing etched circuit boards. NEVER USE PASTE FLUX. After soldering, clean off any excess flux and coat the repaired area with a high quality electrical varnish or lacquer.

When replacing components with multiple mounting pins such as tube sockets, electrolytic capacitors, and potentiometers, it will be necessary to lift each pin slightly, working around the components several times until it is free.

WARNING: If the specific instructions outlined in the steps below regarding etched circuit boards without eyelets are not followed, extensive damage to the etched circuit board will result.

1. Apply heat sparingly to lead of component to be replaced. If lead of component passes through an eyelet in the circuit board, apply heat on component side of board. If lead of component does not pass through an eyelet, apply heat to conductor side of board.

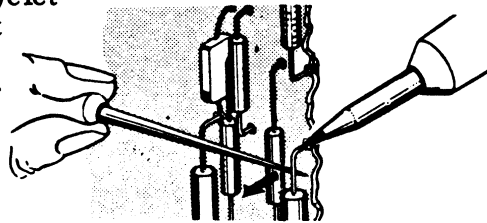

2. Reheat solder in vacant eyelet and quickly insert a small awl to clean inside of hole.

If hole does not have an eyelet, insert awl or a #57 drill from conductor side of board.

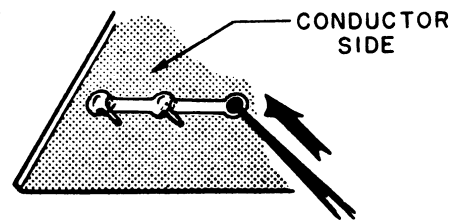

3. Bend clean tinned lead on new part and carefully insert through eyelets or holes in board.

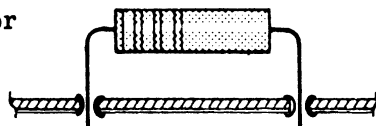

4. Hold part against board (avoid overheating) and solder leads.

Apply heat to component leads on correct side of board as explained in step 1.

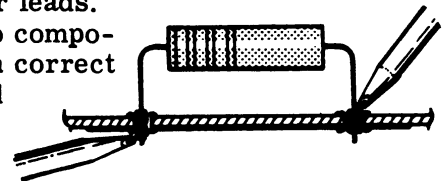

In the event that either the circuit board has been damaged or the conventional method is impractical, use method shown below. This is especially applicable for circuit boards without eyelets.

1. Clip lead as shown below.

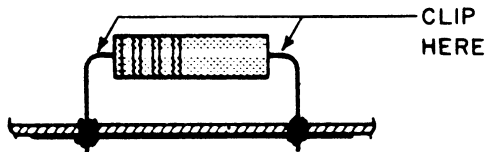

2. Bend protruding leads upward. Bend lead of new component around protruding lead.

Apply solder using a pair of long nose pliers as a heat sink.

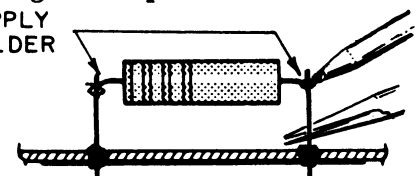

This procedure is used in the field only as an alternate means of repair. It is not used within the factory.

Figure 5-7. Servicing Printed Wiring Boards

Table 5-7. Checks and Adjustments after Replacement of Semiconductor Devices

Circuit Reference	Function	Check	Adjust
Q1, Q2	Constant voltage differential amplifier	Constant voltage line and load regulation; transient recovery time; zero voltage output	R6, R17
Q3	Turn-on circuit	Excessive transients at turn-on	--
Q4	Gating Circuit	Constant voltage/constant current line and load regulation	--
Q5	Constant voltage programming current regulator	Constant voltage programming coefficient	R38-R39
Q6	Constant current programming current regulator	Constant current programming coefficient	R40-R41
Q7	SCR regulator control	Waveforms (shown on schematic diagram at rear of manual)	R51
Q8, Q9	Constant current differential amplifier	Constant current line and load regulation; zero current output	R20, R44
Q10	Bias and reference error detector/amplifier	Bias and reference circuit line regulation	R45
Q11	Bias and reference series regulator	Bias and reference circuit line regulation	R45
CR1, CR2, CR28	Constant voltage protection	Constant voltage load regulation	--
CR6, CR9, CR10, CR11, CR12, CR14, CR27, CR46	Forward bias regulators	Voltage across each diode (0.6 to 0.85Vdc)	--
CR17, CR18	SCR regulator	Constant voltage load regulation	--
CR19, CR20, CR21, CR22	Bridge rectifier	Voltage across bridge at full output (18Vdc)	--
CR23	Output Protection	Output voltage	--
CR26	Constant current protection	Constant current line and load regulation	--
CR30, CR31	Full-wave rectifier	Rectifier output (67Vdc)	--
CR39, CR40, CR41, CR42, CR43	Bridge rectifier	Voltage across bridge (20-25 peak, full wave)	--

Table 5-7. Checks and Adjustments after Replacement of Semiconductor Devices (Continued)

Circuit Reference	Function	Check	Adjust
CR5, CR7, CR8, CR44, CR45, CR47, CR48, CR49, CR50, CR51	Diode switches	--	--
VR1	Constant voltage programming protection	Full output voltage and zero output voltage obtainable via VOLTAGE controls; voltage regulation at 18Vdc output	--
VR3	Voltage reference	Bias and reference circuit line regulation	R45
VR4	Voltage reference	6.0Vdc line regulation	--

5-48 ADJUSTMENTS AND CALIBRATIONS

5-49 GENERAL

5-50 Adjustments and calibrations may be required after performance testing (Paragraph 5-7), additional specification testing (Paragraph 5-23), troubleshooting (Paragraph 5-36), or repair and replacement (Paragraph 5-50). Test points called out in the procedures are identified on the schematic diagram (Figure 4-2). If an adjustment or calibration cannot be performed, troubleshooting is required. Table 5-8 summarizes the adjustments and calibrations. The adjustments and calibra-

tions are performed using a 115-volt, 60Hz, single-phase power input to the power supply.

5-51 METER ZERO

5-52 Proceed as follows:

- a. Turn-off power supply and allow 2 minutes for all capacitors to discharge.
- b. Rotate voltmeter zero-set screw (Figure 3-1) clockwise until the meter pointer is to the right of zero and moving to the left towards zero. Stop when pointer is on zero. If the pointer overshoots zero, continue rotating clockwise and repeat this step.

Table 5-8. Adjustment and Calibration Summary

Adjustment or Calibration	Paragraph Reference	Control Device
Meter Zero	5-52	Meter Spring
Voltmeter Tracking	5-54	R25
Ammeter Tracking	5-56	R27
Constant Voltage Programming Current	5-58	R39
Zero Voltage Output	5-60	R6
Constant Current Programming Current	5-62	R41
Zero Current Output	5-64	R20
Bias and Reference Line Regulation	5-66	R45
Line Imbalance	5-68	R17
Constant Current Load Regulation	5-70	R44

- c. When the pointer is exactly on zero, rotate the zero-set screw counterclockwise approximately 15 degrees to free the screw from the meter suspension. If pointer moves, repeat steps a through c.
- d. Repeat steps a through c for the ammeter.

5-53 VOLTMETER TRACKING

5-54 Proceed as follows:

- a. Connect the differential voltmeter across -S and +S terminals.
- b. Turn front-panel VOLTAGE controls until the differential voltmeter indicates 40Vdc.
- c. Adjust R25 until the front-panel voltmeter indicates 40Vdc.

5-55 AMMETER TRACKING

5-56 Proceed as follows:

- a. Connect test setup shown in Figure 5-3.
- b. Turn front-panel VOLTAGE controls fully clockwise (maximum).
- c. Turn front-panel CURRENT controls until the differential voltmeter indicates 0.5V.
- d. Adjust R27 until the front-panel ammeter indicates 25 Amperes.

5-57 CONSTANT VOLTAGE PROGRAMMING CURRENT

5-58 Proceed as follows:

- a. Connect a 8,000 ohm, 0.1%, 1/2W resistor between terminals +S and A6 on the rear terminal strip of the power supply.
- b. Disconnect the jumper between terminals A6 and A7.
- c. Connect the resistance box in place of R39 (shunt).
- d. Connect the differential voltmeter between the +S and -S terminals.
- e. Adjust the resistance box until the differential voltmeter indicates 40 ± 0.2 Vdc.
- f. Choose resistor R39 (shunt) equal to the resistance required in step e.

5-59 ZERO VOLTAGE OUTPUT

5-60 Proceed as follows:

- a. Connect a jumper between the +S and A7 terminals on the rear terminal strip of the power supply.
- b. Connect the differential voltmeter between the +S and -S terminals.
- c. Connect the resistance box in place of R6.
- d. Adjust the resistance box so that the voltage indicated by the differential voltmeter is between zero and ± 10 mVdc.
- e. Choose resistor R6 equal to the resist-

ance value required in step d.

5-61 CONSTANT CURRENT PROGRAMMING CURRENT

5-62 Proceed as follows:

- a. Connect test setup shown in Figure 5-3.
- b. Connect a 250 ohm, 0.1%, 1/2W resistor between terminals A2 and A3 on the rear terminal strip of the power supply.
- c. Disconnect the jumper between terminals A1 and A2.
- d. Connect the resistance box in place of R41 (shunt).
- e. Adjust the resistance box until the differential voltmeter indicates 25 ± 2.5 mVdc.
- f. Choose resistor R41 (shunt) equal to the resistance value required in step e.

5-63 ZERO CURRENT OUTPUT

5-64 Proceed as follows:

- a. Connect test setup shown in Figure 5-3.
- b. Connect a jumper between the A1 and A3 terminals on the rear terminal strip of the power supply.
- c. Connect the resistance box in place of R20.
- d. Adjust the resistance box until the voltage indicated by the differential voltmeter is between zero and 0.1 mVdc.
- e. Choose resistor R20 equal to the resistance value required in step d.

NOTE

If the resistance value required is less than 7,000 ohms or greater than 17,000 ohms, change R46. Replace the original R20.

5-65 BIAS AND REFERENCE LINE REGULATION

5-66 Proceed as follows:

- a. Connect the variable voltage transformer between the input power source and the power supply power input. Adjust the variable voltage transformer to 105Vac.
- b. Connect the differential voltmeter between the +S and -S terminals.
- c. Connect the resistance box in place of R45.
- d. Turn front-panel VOLTAGE controls until the differential voltmeter indicates 40Vdc.
- e. Adjust the variable voltage transformer to 125Vac.
- f. Adjust the resistance box until the voltage indicated by the differential voltmeter is within 18 mVdc of 40Vdc.
- g. Choose resistor R45 equal to the resistance value required in step f.

NOTE

If the resistance value required is less than 20,000 ohms, troubleshooting is required. Replace the original R45.

5-67 LINE IMBALANCE

5-68 Proceed as follows:

a. Connect the 1.6 ohm load resistor across the output terminals.

b. Turn front-panel CURRENT controls fully clockwise (maximum).

c. Connect the variable voltage transformer between the input power source and the power supply power input. Adjust the variable voltage transformer to 125Vac.

d. Turn front-panel VOLTAGE controls until front-panel ammeter indicates 25 Amperes.

e. Connect the oscilloscope across test points 18 and 48. Use internal sync.

f. Connect the resistance box in place of R17.

g. Adjust the resistance box until the oscilloscope display is similar to the waveform for test points 18-48 shown on Figure 4-2.

h. Choose resistor R17 equal to the resistance value required in step f.

NOTE

If the resistance value required is less than 5,000 ohms, troubleshooting is

required. Replace the original R17.

5-69 CONSTANT CURRENT LOAD REGULATION

5-70 Proceed as follows:

a. Perform steps a through e of Paragraph 5-18.

b. Place a 10-megohm resistor in place of R44.

c. Adjust the variable voltage transformer to 125Vac.

d. Close the shorting switch.

e. Differential voltmeter indication should change by less than 4.0 mVdc. If voltage change is greater than 4.0 mVdc, reduce the 10-megohm resistor to 9 megohms, set the variable voltage transformer to 105Vac, open the shorting switch, record the differential voltmeter indication, and repeat steps c and d. Repeat this process, reducing the 10-megohm resistor in 1-megohm steps until the voltmeter change is less than 4.0 mVdc. Changes smaller than 1-megohm may be required to obtain the optimum resistance value for R44. Choose resistor R44 equal to the optimum resistance value required.

NOTE

If the resistance value required is less than 1 megohm, troubleshooting is required. Replace the original R44.

SECTION VI REPLACEABLE PARTS

6-1 INTRODUCTION

6-2 This section contains information for ordering replacement parts.

6-3 Table 6-4 lists parts in alpha-numerical order of the reference designators and provides the following information:

- a. Reference Designators. For abbreviations, refer to Table 6-1.
- b. Description. Refer to Table 6-2 for abbreviations.
- c. Total Quantity (TQ) used in the instrument; given only first time the part number is listed.
- d. Manufacturer's part number.
- e. Manufacturer's code number. Refer to Table 6-3 for manufacturer's name and address.
- f.  Part Number.
- g. Recommended spare parts quantity (RS) for complete maintenance of one instrument during one year of isolated service.
- h. Parts not identified by a reference designator are listed at the end of Table 6-4 under Miscellaneous.

6-4 ORDERING INFORMATION

6-5 To order a replacement part, address order or inquiry to your local Hewlett-Packard sales office (see lists at rear of this manual for addresses).

6-6 Specify the following information for each part:

- a. Model and complete serial number of instrument.
- b. Hewlett-Packard part number.
- c. Circuit reference designator.
- d. Description.

6-7 To order a part not listed in Table 6-4, give a complete description of the part and include its function and location.

Table 6-1. Reference Designators

A = assembly	CR = diode
B = motor	DS = device, signaling (lamp)
C = capacitor	

Table 6-1. Reference Designators (Continued)

E = misc. electronic part	RT = thermistor
F = fuse	S = switch
J = jack	T = transformer
K = relay	V = vacuum tube, neon bulb, photocell, etc.
L = inductor	X = socket
M = meter	XF = fuseholder
P = plug	XDS = lampholder
Q = transistor	Z = network
R = resistor	

Table 6-2. Description Abbreviations

a = amperes	obd = order by description
c = carbon	p = peak
cer = ceramic	pc = printed circuit board
coef = coefficient	pf = picofarads = 10 ⁻¹² farads
com = common	pp = peak-to-peak
comp = composition	ppm = parts per million
conn = connection	pos = position(s)
crt = cathode-ray tube	poly = polystyrene
dep = deposited	pot = potentiometer
elect = electrolytic	prv = peak reverse voltage
encap = encapsulated	rect = rectifier
f = farads	rot = rotary
fxd = fixed	rms = root-mean-square
GE = germanium	s-b = slow-blow
grd = ground(ed)	sect = section(s)
h = henries	Si = silicon
Hg = mercury	sil = silver
impg = impregnated	sl = slide
ins = insulation(ed)	td = time delay
K = kilo = 1000	TiO ₂ = titanium dioxide
lin = linear taper	tog = toggle
log = logarithmic taper	tol = tolerance
mA = milli = 10 ⁻³	trim = trimmer
M = megohms	twt = traveling wave tube
ma = milliamperes	var = variable
μ = micro = 10 ⁻⁶	w/ = with
mfr = manufacturer	W = watts
mtg = mounting	w/o = without
my = mylar	cmo = cabinet mount only
NC = normally closed	
Ne = neon	
NO = normally open	

Table 6-3. Code List of Manufacturers

CODE NO.	MANUFACTURER	ADDRESS
00629	EBY Sales Co.	New York, N. Y.
00656	Aerovox Corp.	New Bedford, Mass.
00853	Sangamo Electric Company, Ordill Division (Capacitors)	Marion, Ill.
01121	Allen Bradley Co.	Milwaukee, Wis.
01255	Litton Industries, Inc.	Beverly Hills, Calif.
01281	TRW Semiconductors, Inc.	Lawndale, Calif.
01295	Texas Instruments, Inc. Semiconductor- Components Division	Dallas, Texas
01686	RCL Electronics, Inc.	Manchester, N. H.
01930	Amerock Corp.	Rockford, Ill.
02114	Ferroxcube Corp. of America	Saugerties, N. Y.
02606	Fenwal Laboratories	Morton Grove, Ill.
02660	Amphenol-Borg Electronics Corp.	Broadview, Ill.
02735	Radio Corp. of America, Commercial Receiving Tube and Semiconductor Div.	Somerville, N.J.
03508	G. E. Semiconductor Products Dept.	Syracuse, N. Y.
03797	Eldema Corp.	Compton, Calif.
03877	Transitron Electronic Corp.	Wakefield, Mass.
03888	Pyrofilm Resistor Co.	Cedar Knolls, N.J.
04009	Arrow, Hart and Hegeman Electric Co.	Hartford, Conn.
04072	ADC Electronics, Inc.	Harbor City, Calif.
04213	Caddell-Burns Mfg. Co. Inc.	Mineola, N. Y.
04404	Dymec Division of Hewlett-Packard Co.	Palo Alto, Calif.
04713	Motorola, Inc., Semiconductor Products Division	Phoenix, Arizona
05277	Westinghouse Electric Corp. Semi-Conductor Dept.	Youngwood, Pa.
05347	Ultronix, Inc.	Grand Junction, Colo.
06486	North American Electronics, Inc.	Lynn, Mass.
06540	Amathom Electronic Hardware Co., Inc.	New Rochelle, N. Y.
06555	Beede Electrical Instrument Co., Inc.	Penacook, N. H.
06666	General Devices Co., Inc.	Indianapolis, Ind.
06751	Nuclear Corp. of America, Inc., U. S. Semcor Div.	Phoenix, Arizona

CODE NO.	MANUFACTURER	ADDRESS
06812	Torrington Mfg. Co., West Div.	Van Nuys, Calif.
07137	Transistor Electronics Corp.	Minneapolis, Minn.
07138	Westinghouse Electric Corp. Electronic Tube Div.	Elmira, N. Y.
07263	Fairchild Semiconductor Div. of Fairchild Camera and Instrument Corp.	Mountain View, Calif.
07387	Birtcher Corp., The	Los Angeles, Calif.
07397	Sylvania Electric Products Inc. Mountain View Operations of Sylvania Electronic Systems	Mountain View, Calif.
07716	International Resistance Co.	Burlington, Iowa
07910	Continental Device Corp.	Hawthorne, Calif.
07933	Raytheon Mfg. Co., Semiconductor Div.	Mountain View, Calif.
08530	Reliance Mica Corp.	Brooklyn, N. Y.
08717	Sloan Company	Sun Valley, Calif.
08730	Vemaline Products Co.	Franklin Lakes, N. J.
08863	Nylomatic Corp.	Morrisville, Pa.
09182	Hewlett-Packard Co., Harrison Division	Berkeley Heights, N. J.
09353	C & K Components	Newton, Mass.
11236	CTS of Berne, Inc.	Berne, Ind.
11237	Chicago Telephone of California, Inc.	So. Pasadena, Calif.
11711	General Instrument Corp., Semiconductor Prod. Group, Rectifier Div.	Newark, N. J.
12136	Philadelphia Handle Co., Inc.	Camden, N. J.
12697	Clarostat Mfg. Co.	Dover, N. H.
14493	Hewlett-Packard Co., Loveland Division	Loveland, Colo.
14655	Cornell-Dubilier Elec. Corp.	Newark, N. J.
14936	General Instrument Corp., Semiconductor Prod. Group, Semiconductor Div.	Hicksville, N. Y.
15909	Daven Div. of Thos. Edison Industries, McGraw Edison Co.	Livingston, N. J.
16299	Corning Glass Works, Electronic Components Div.	Raleigh, N. C.
16758	Delco Radio Div. of General Motors Corp.	Kokomo, Ind.
17545	Atlantic Semiconductors, Inc.	Asbury Park, N. J.

Table 6-3. Code List of Manufacturers (Continued)

CODE NO.	MANUFACTURER	ADDRESS	CODE NO.	MANUFACTURER	ADDRESS
19315	The Bendix Corp., Eclipse Pioneer Div.	Teterboro, N.J.	73138	Helipot Div. of Beckman Instruments, Inc.	Fullerton, Calif.
19701	Electra Mfg. Co.	Independence, Kan.	73293	Hughes Components Division of Hughes Aircraft Co.	Newport Beach, Calif.
21520	Fansteel Metallurgical Corp.	No. Chicago, Ill.	73445	Amperex Electronic Co., Div. of North American Phillips Co., Inc.	Hicksville, N.Y.
22229	Union Carbide Corp., Linde Div., Kemet Dept.	Mountain View, Calif.	73506	Bradley Semiconductor Corp.	New Haven, Conn.
22767	ITT Semiconductors, A Division of International Telephone & Telegraph Corp.	Palo Alto, Calif.	73559	Carling Electric, Inc.	Hartford, Conn.
24446	General Electric Co.	Schenectady, N.Y.	73734	Federal Screw Products, Inc.	Chicago, Ill.
24455	General Electric Co., Lamp Division	Nela Park, Cleveland, Ohio	73978	Hardwick Hindle Co., Memcor Components Div.	Huntington, Ind.
24655	General Radio Co.	West Concord, Mass.	74193	Heinemann Electric Co.	Trenton, N.J.
28480	Hewlett-Packard Co.	Palo Alto, Calif.	74545	Harvey Hubbel, Inc.	Bridgeport, Conn.
28520	Heyman Mfg. Co.	Kenilworth, N.J.	74868	FXR Div. of Amphenol-Borg Electronics Corp.	Danbury, Conn.
33173	G. E., Tube Dept.	Owensboro, Ky.	75042	International Resistance Co.	Philadelphia, Pa.
35434	Lectrohm, Inc.	Chicago, Ill.	75183	Howard B. Jones Div., of Cinch Mfg. Corp. (Use 71785)	New York, N.Y.
37942	P.R. Mallory & Co., Inc.	Indianapolis, Ind.	75382	Kulka Electric Corp.	Mt. Vernon, N.Y.
42190	Muter Co.	Chicago, Ill.	75915	Littlefuse, Inc.	Des Plaines, Ill.
44655	Ohmite Manufacturing Co.	Skokie, Ill.	76493	J. W. Miller Co.	Los Angeles, Calif.
47904	Polaroid Corporation	Cambridge, Mass.	76854	Oak Manufacturing Co.	Crystal Lake, Ill.
49956	Raytheon Mfg. Co., Microwave and Power Tube Div.	Waltham, Mass.	77068	Bendix Corp., Bendix-Pacific Div.	No. Hollywood, Calif.
55026	Simpson Electric Co.	Chicago, Ill.	77221	Phaostron Instrument and Electronic Co.	South Pasadena, Calif.
56289	Sprague Electric Co.	North Adams, Mass.	77252	Philadelphia Steel and Wire Corp.	Philadelphia, Pa.
58474	Superior Electric Co.	Bristol, Conn.	77342	American Machine and Foundry, Potter and Brumfield Div.	Princeton, Ind.
61637	Union Carbide Corp.	New York, N.Y.	77630	TRW Electronics, Components Div.	Camden, N.J.
63743	Ward-Leonard Electric Co.	Mt. Vernon, N.Y.	77764	Resistance Products Co.	Harrisburg, Pa.
70563	Amperite Co., Inc.	Union City, N.J.	78189	Shakeproof Div. of Illinois Tool Works	Elgin, Ill.
70903	Belden Mfg. Co.	Chicago, Ill.	78488	Stackpole Carbon Co.	St. Marys, Pa.
71218	Bud Radio, Inc.	Willoughby, Ohio	78526	Stanwyck Winding Co., Inc.	Newburgh, N.Y.
71400	Bussmann Mfg. Div. of McGraw-Edison Co.	St. Louis, Mo.	78553	Tinnerman Products, Inc.	Cleveland, Ohio
71450	CTS Corporation	Elkhart, Ind.	79307	Whitehead Metal Products Co., Inc.	New York, N.Y.
71468	I. T. T. Cannon Electric Inc.	Los Angeles, Calif.	79727	Continental-Wirt Electronics Corp.	Philadelphia, Pa.
71590	Centralab Div. of Globe Union, Inc.	Milwaukee, Wis.	80031	Mepco Div. of Sessions Clock Co.	Morristown, N.J.
71700	The Cornish Wire Co.	New York, N.Y.	80294	Bourns, Inc.	Riverside, Calif.
71744	Chicago Miniature Lamp Works	Chicago, Ill.			
71785	Cinch Mfg. Co.	Chicago, Ill.			
71984	Dow Corning Corp.	Midland, Mich.			
72619	Dialight Corporation	Brooklyn, N.Y.			
72699	General Instrument Corp., Capacitor Div.	Newark, N.J.			
72765	Drake Mfg. Co.	Chicago, Ill.			
72982	Erie Technological Products, Inc.	Erie, Pa.			

Table 6-3. Code List of Manufacturers (Continued)

CODE NO.	MANUFACTURER	ADDRESS
81042	Howard Industries, Inc.	Racine, Wis.
81483	International Rectifier Corp.	El Segundo, Calif.
81751	Columbus Electronics Corp.	Yonkers, N.Y.
82099	Goodyear Sundries & Mechanical Co., Inc.	New York, N.Y.
82219	Sylvania Electric Products, Inc., Electronic Tube Division	Emporium, Pa.
82389	Switchcraft, Inc.	Chicago, Ill.
82647	Metals and Controls, Inc., Spencer Products	Attleboro, Mass.
82866	Research Products Corp.	Madison, Wis.
82877	Rotron Mfg. Co., Inc.	Woodstock, N.Y.
82893	Vector Electronic Co.	Glendale, Calif.
83058	Carr Fastener Co.	Cambridge, Mass.
83186	Victory Engineering Corp.	Springfield, N.J.
83298	Bendix Corp., Red Bank Div.	Eatontown, N.J.
83330	Herman H. Smith, Inc.	Brooklyn, N.Y.
83385	Central Screw Co.	Chicago, Ill.
83501	Gavitt Wire and Cable Co., Div. of Amerace Corp.	Brookfield, Mass.
83508	Grant Pulley and Hardware Co.	West Nyack, N.Y.
83594	Burroughs Corp., Electronic Components Div.	Plainfield, N.J.
83877	Yardeny Laboratories, Inc.	New York, N.Y.
84171	Arco Electronics, Inc.	Great Neck, N.Y.
84411	TRW Capacitor Div.	Ogallala, Neb.
86684	Radio Corporation of America, Electronic Components & Devices Div.	Harrison, N.J.
87034	Marco Industries Co.	Anaheim, Calif.
87216	Philco Corp. (Lansdale Div.)	Lansdale, Pa.
87585	Stockwell Rubber Co., Inc.	Philadelphia, Pa.
87929	B. M. Tower Co., Inc.	Bridgeport, Conn.

CODE NO.	MANUFACTURER	ADDRESS
88140	Cutler-Hammer, Inc.	Lincoln, Ill.
89473	General Electric Distributing Corp.	Schenectady, N.Y.
91345	Miller Dial and Nameplate Co.	El Monte, Calif.
91637	Dale Electronics, Inc.	Columbus, Neb.
91662	Elco Corp.	Willow Grove, Pa.
91929	Honeywell, Inc., Micro Switch Div.	Freeport, Ill.
93332	Sylvania Electric Prod., Inc., Semicon- ductor Prod. Div.	Woburn, Mass.
93410	Stevens Mfg. Co., Inc.	Mansfield, Ohio
94144	Raytheon Co., Components Div., Industrial Components Operation	Quincy, Mass.
94154	Tung-Sol Electric, Inc.	Newark, N.J.
94310	Tru-Ohm Products, Memcor Components Div.	Huntington, Ind.
95263	Leecraft Mfg. Co., Inc.	Long Island City, N.Y.
95354	Methode Mfg. Co.	Chicago, Ill.
96791	Amphenol Controls Div. of Amphenol- Borg Electronics Corp.	Janesville, Wis.
98291	Seaelectro Corp.	Mamaroneck, N.Y.
98978	International Electronic Research Corp.	Burbank, Calif.
99934	Renbrandt, Inc.	Boston, Mass.
THE FOLLOWING H-P VENDORS HAVE NO NUM- BERS ASSIGNED IN THE LATEST SUPPLEMENT TO THE FEDERAL SUPPLY CODE FOR MANUFAC- TURERS HANDBOOK.		
0000	Cooltron	Oakland, Calif.
00000	Plastic Ware Co.	Brooklyn, N.Y.

Reference Designator	Description	Quantity	Mfr. Part # or Type	Mfr.	Mfr. Code	Stock No.	RS
C1, 4, 5	fxd, elect 5 μ f 65vdc	3	D33689	Φ	09182	0180-1836	1
C2	fxd, elect 100 μ f 6vdc	1	30D107G0060B4	Sprague	56289	0180-1734	1
C3	fxd, film .0022 μ f 200vdc	1	192P22292	Sprague	56289	0160-0154	1
C6, 22, 25	fxd, elect 1 μ f 35vdc	3	150D105X9036A2	Sprague	56289	0180-0291	1
C7, 13, 23	NOT ASSIGNED	-	-	-	-	-	-
C8	fxd, film .01 μ f 200vdc	1	192P10392	Sprague	56289	0160-0161	1
C9, 10, 18, 19	fxd, paper .047 μ f 600vdc	4	160P47396	Sprague	56289	0160-0005	1
C11	fxd, paper .47 μ f 600vdc	1	161P47406	Sprague	56289	0160-2464	1
C12	fxd, paper .1 μ f 400vdc	1	160P10494	Sprague	56289	0160-0013	1
C14-17	fxd, elect 40,000 μ f 50vdc	4	D42343	Φ	09182	0180-1931	1
C20, 21	fxd, elect 300 μ f 40vdc	2	34D307G040GJ4	Sprague	56289	0180-1805	1
C24	fxd, elect 68 μ f 15vdc	1	150D686X0015R2	Sprague	56289	0180-1835	1
C26, 27	fxd, film .082 μ f 200vdc	2	192P82392	Sprague	56289	0160-0167	1
C28, 29	fxd, film .22 μ f 80vdc	2	192P2249R8	Sprague	56289	0160-2453	1
CB1	Circuit Breaker 25 amp 250vac max.	1	Type AM33 Curve 5	Heineman	74193	2110-0213	1
CR1, 5, 7-11, 26, 28, 39-45, 47, 48	Diode, si. 200prv 200mw	18	1N485B	Φ	09182	1901-0033	8
CR4, 13, 15, 16, 24, 25, 29, 32-38	NOT ASSIGNED	-	-	-	-	-	-
CR2, 3, 6, 12, 14, 27, 46, 49-51	Rect. si. 200ma 15prv	10	111S1	Φ	09182	1901-0461	6
CR17, 18	SCR 25A 200prv	2	C 30 B	G. E.	03508	1884-0017	2
CR19, 20	Rect. si. 20A 100prv	2	A 40 A	G. E.	03508	1901-0322	2
CR21-23	Rect. si. 20A 100prv	3	A 41 A	G. E.	03508	1901-0324	3
CR30, 31	Rect. si. 500ma 200prv	2	1N3253	R. C. A.	20735	1901-0389	2
DS1	Indicator Light, neon	1	599-124	Drake	72765	1450-0048	1
L1	Inductor, 1 mh	1		Φ	09182	9100-2188	1
L2	Choke - R. F. I.	1		Φ	09182	9100-2169	1
Q1-6, 8, 9	SS NPN si.	8	4JX16A1014	G. E.	03508	1854-0371	6
Q7, 11	SS NPN si.	2	2N3417	G. E.	03508	1854-0087	2
Q10	SS PNP si.	1	MPS 6517	Motorola	04713	1853-0065	1
R1	fxd, met. film 20K Ω \pm 1% 1/8w	1	Type CEA T-O	I. R. C.	07716	0757-0449	1
R2	var. ww 10K Ω \pm 5%	1		Φ	09182	2100-1852	1
R3, 13	fxd, met. film 43K Ω \pm 1% 1/8w	2	Type CEA T-O	I. R. C.	07716	0698-5090	1
R4, 19	fxd, met. film 100K Ω \pm 1% 1/8w	2	Type CEA T-O	I. R. C.	07716	0757-0465	1
R5, 20	fxd, met. film 12K Ω \pm 1% 1/8w	2	Type CEA T-O	I. R. C.	07716	0698-5088	1
R6, 35, 36	fxd, met. film 3K Ω \pm 1% 1/8w	3	Type CEA T-O	I. R. C.	07716	0757-1093	1
R7	fxd, met. film 4.75K Ω \pm 1% 1/8w	1	Type CEA T-O	I. R. C.	07716	0757-0437	1
R8	var. ww 200 Ω \pm 5%	1		Φ	09182	2100-1856	1
R9	var. ww 10 Ω \pm 5%	1		Φ	09182	2100-1857	1
R10	var. ww 300 Ω \pm 5%	1		Φ	09182	2100-1848	1
R11	fxd, comp 3K Ω \pm 5% 1w	1	GB 3025	A. B.	01121	0689-3025	1
R12, 15	fxd, comp 680K Ω \pm 5% 1/2w	2	EB 6845	A. B.	01121	0686-6845	1
R14, 49, 57	NOT ASSIGNED	-	-	-	-	-	-
R16, 33	fxd, comp 1K Ω \pm 5% 1/2w	2	EB 1025	A. B.	01121	0686-1025	1

Reference Designator	Description	Quantity	Mfr. Part # or Type	Mfr.	Mfr. Code	Ⓢ Stock No.	RS
R17, 39, 41, 44, 45	fxd, comp SELECTED ±5% ½w	5	Type EB	A. B.	01121		1
R18, 34, 53	fxd, comp 10K _Ω ±5% ½w	3	EB 1045	A. B.	01121	0686-1045	1
R21	fxd, comp 10 _Ω ±5% 1w	1	GB 1005	A. B.	01121	0689-1005	1
R22, 30, 50	fxd, comp 3K _Ω ±5% ½w	3	EB 3025	A. B.	01121	0686-3025	1
R23, 32	fxd, ww .04 _Ω ±10% 40w	2		Ⓢ	09182	0811-1950	1
R24	fxd, comp 47K _Ω ±5% ½w	1	EB 4735	A. B.	01121	0686-4735	1
R25	var. ww 5K _Ω (Modify)	1	Type 110-F4	C. T. S.	11236	2100-1824	1
R26	fxd, met. film 365 _Ω ±1% ¼w	1	Type CEB T-O	I. R. C.	07716	0757-0723	1
R27	var. ww 250 _Ω (Modify)	1	Type 110-F4	C. T. S.	11236	2100-0439	1
R28	fxd, ww 100 _Ω ±5% 40w	1		Ⓢ	09182	0811-1969	1
R29	fxd, ww .62 _Ω ±5% 2w	1	Type BWH	I. R. C.	07716	0811-1759	1
R31, 58	fxd, comp 33K _Ω ±5% ½w	2	EB 3335	A. B.	01121	0686-3335	1
R37	fxd, met. film 1K _Ω ±1% ¼w	1	Type CEB T-O	I. R. C.	07716	0757-0338	1
R38	fxd, met. film 2K _Ω ±1% ¼w	1	Type CEB T-O	I. R. C.	07716	0757-0739	1
R40	fxd, met. film 6.2K _Ω ±1% ¼w	1	Type CEB T-O	I. R. C.	07716	0698-5149	1
R42, 43	fxd, comp 1.3K _Ω ±5% ½w	2	EB 1325	A. B.	01121	0686-1325	1
R46	fxd, comp 15 MEG _Ω ±5% ½w	1	EB 1565	A. B.	01121	0686-1565	1
R47	fxd, comp 1 MEG _Ω ±5% ½w	1	EB 1055	A. B.	01121	0686-1055	1
R48	fxd, comp 43K _Ω ±5% ½w	1	EB 4335	A. B.	01121	0686-4335	1
R51	fxd, comp 180 _Ω ±5% ½w	1	EB 1815	A. B.	01121	0686-1815	1
R52	fxd, met. ox 3K _Ω ±5% 2w	1	Type C 42 S	Corning	16299	0698-3642	1
R54, 55	fxd, comp 47 _Ω ±5% ½w	2	EB 4705	A. B.	01121	0686-4705	1
R56	fxd, comp 39 _Ω ±5% ½w	1	EB 3905	A. B.	01121	0686-3905	1
T1	Power Transformer	1		Ⓢ	09182	9100-2187	1
T2	Bias Transformer	1		Ⓢ	09182	9100-1876	1
T3	Pulse Transformer	1		Ⓢ	09182	9100-1875	1
TS1	Thermal Switch, N. C. Open on Rise 167°F ±5°F Close on Fall 137°F ±10°F	1		Ⓢ	09182	0440-0042	1
VR1, 5	Diode, zener 23.7V ±5%	2		Ⓢ	09182	1902-3256	2
VR2	NOT ASSIGNED	-	-	-	-	-	-
VR3	Diode, zener 9.4V ±5%	1	1N2163A	Motorola	04713	1902-0763	1
VR4	Diode, zener 4.22V ±5%	1		Ⓢ	09182	1902-3070	1
	Welding Ass'y, Chassis	1		Ⓢ	09182	5060-6114	
	Welding Ass'y, Rear Chassis	1		Ⓢ	09182	06428-60001	
	Cover	2		Ⓢ	09182	5000-6009	
	Bracket - P. C. Board	1		Ⓢ	09182	5000-6012	
	Bracket - P. C. Board	1		Ⓢ	09182	5000-6014	
	Capacitor Clamp	4		Ⓢ	09182	5000-6017	
	Front Panel	1		Ⓢ	09182	06434-60001	
	Bracket - Choke	2		Ⓢ	09182	06428-00002	
	Buss Bar	2		Ⓢ	09182	06428-00003	
	Cover - D. C. Barr Strip	1		Ⓢ	09182	06428-20001	
	Heat Sink - S. C. R.	1		Ⓢ	09182	5020-5501	
	Heat Sink - Rectifier	2		Ⓢ	09182	5020-5502	
	Handle 5¼"	2		Ⓢ	09182	5020-5512	
	Cover - A. C. Barr Strip	1		Ⓢ	09182	5020-5513	
	Assembly - P. C. Board (Includes Components)	1		Ⓢ	09182	06434-60020	
	Board - Printed Circuit (Blank)	1		Ⓢ	09182	5020-5521	
	Barrier Strip	1	602-5	Kulka	75382	0360-1220	1

Reference Designator	Description	Quantity	Mfr. Part # or Type	Mfr.	Mfr. Code	Ⓢ Stock No.	RS
	Barrier Strip (Modify)	1	602-3	Kulka	75382	0360-1213	1
	Barrier Strip	1		Ⓢ	09182	0360-1238	1
	Jumper	2	602J	Kulka	75382	0360-1280	1
	Jumper	5	422-13-11-013	Cinch	71785	0360-1143	1
	Meter 3½" size SCALE 0-50V	1		Ⓢ	09182	1120-1173	1
	Meter 3½" size SCALE 0-30A	1		Ⓢ	09182	1120-1175	1
	Bezel (¼ MOD.)	2		Ⓢ	09182	4040-0296	1
	Spring	8		Ⓢ	09182	1460-0256	2
	Fastener	1	C17373-012-24B	Tinnerman	89032	0510-0123	1
	5 Way Binding Post (maroon)	1	DF 21 MN	Superior	58474	1510-0040	1
	5 Way Binding Post (black)	2	DF 21 BC	Superior	58474	1510-0039	1
	Rubber Bumpers	4	Type 2097 W	Stockwell	87585	0403-0089	1
	Knob (¼ insert pointer)	4		Ⓢ	09182	0370-0084	1
	Spacer, ¼ Hex. (Br. Cad. Pl.)	1	8-32 x ½ lg.	Ⓢ	09182	0380-0136	1
	Motor - Fan	1		Ⓢ	09182	3140-0010	1
	Casting - Mach.	1		Ⓢ	09182	5243A-20A	1
	Blade - Fan	1	4LHB182B	Ⓢ	09182	3160-0034	1
	Captive Nut	4	CLA-632-2	Pem. Eng.	46384	0590-0393	
	Shoulder Washer - double	8		Ⓢ	09182	0340-0172	2
	Standoff - Insulator	1	17A1-A6	Whitso	92825	0360-1449	1
	Spacer, ¼ Hex. (Br. Cad. Pl.)	1	6-32 x ¾ lg.	Ⓢ	09182	0380-0091	1
	Spacer, ¼ Hex. (Br. Cad. Pl.)	4	8-32 x 3/8 lg	Ⓢ	09182	0380-0718	1
	Spacer, ¼ Hex. (Br. Cad. Pl.)	4	8-32 x 5/8 lg.	Ⓢ	09182	0380-0723	1
	Spacer, Alum. #10 clear 3/8 D x 5/8 lg.	3	9323-A194	Amatom	06540	0380-0396	1
	Shoulder Washer - nylon ¼ I. D. x .630D x .090 thk.	1	Part of Kit #140A601G20	Westinghouse	05277		1
	Nut - Floating	4	C7931-1032-3B	Tinnerman	89032	0510-0012	1
	Fastener	25	C8091-632-24B	Tinnerman	89032	0510-0275	6
	Fastener	4	C8082-832-24B	Tinnerman	89032	0590-0709	1
	Fastener	4	C684-1024-24B	Tinnerman	89032	0590-0711	1
	Rubber Bumper blk. Durmo Hard 55/60	4	3066	Stockwell	87585	0403-0085	1
	Wafer - Mounting	1	H 4021	Union Car.	61637	0340-0175	1
	Cable Clamp ¼ I. D.	1	T4-4	Whitehead	79307	1400-0330	1

Option 17(208Vac Input) or 18 (230Vac Input)

REF. DESIG.	DESCRIPTION	TQ	MFR. PART NO.	MFR. CODE	Ⓢ PART NO.	RS
CR17, 18	SCR 35A 400prv	2	38639	02735	1884-0058	2
R21	fxd, comp 22 _n ±5% 1W	1	GB-2205	01121	0689-2205	1
R58	fxd, met. ox. 75K _n ±5% 2W	1	Type C42S	16299	0764-0027	1
T1	Transformer, Power	1		09182	06434-80091	1
T2	Transformer, Bias	1		09182	9100-2195	1

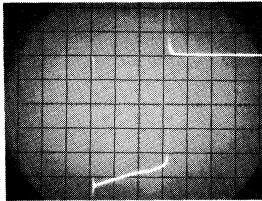

A. Test Points 31-33
5 μ sec/cm, 5v/cm

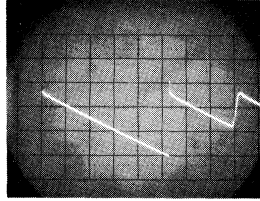

B. Test Points 29-33
1 ms/cm, 1v/cm

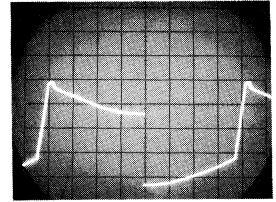

C. Test Points 37-33
1ms/cm, 1v/cm

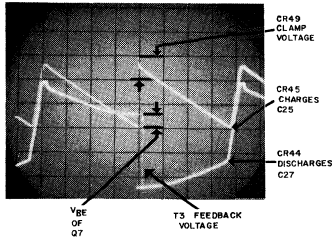

D. Waveforms B and C superimposed

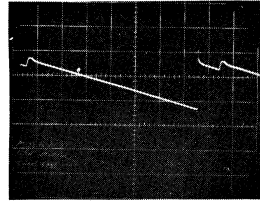

E. Same as B, except smaller load used (2v, 3a)

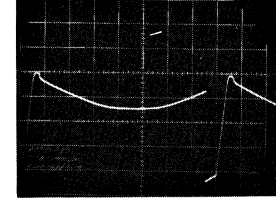

F. Same as C, except Q7 fires later due to smaller load (2v, 3a)

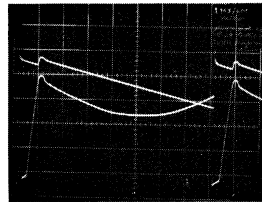

G. Waveforms E and F superimposed

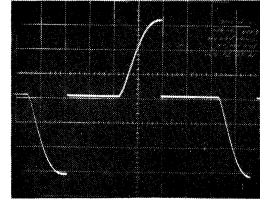

H. Test Points 45-ACC
2ms/cm, 50v/cm

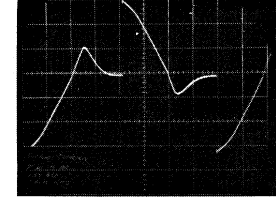

I. Test Points 45-AC
2ms/cm, 50v/cm

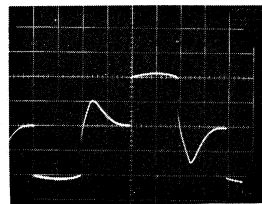

J. Test Points 47-46
2 ms/cm, 10v/cm

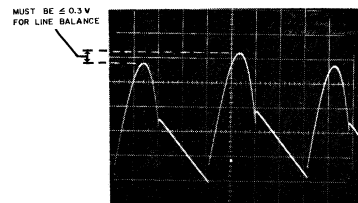

K. Test Points 48-18
2 ms/cm, 0.2v/cm

All waveforms were taken with 115 Volt, 60Hz, single-phase input and 40Vdc, 25 Ampere load (except E and F as indicated). Waveforms H and I require the oscilloscope to be ungrounded. If it is not desirable to unground the oscilloscope, use a 1-kva isolation transformer between the input power source and the power supply power input.

WARNING

If the oscilloscope is ungrounded, injury can occur if personnel touch the oscilloscope case and other equipment simultaneously.

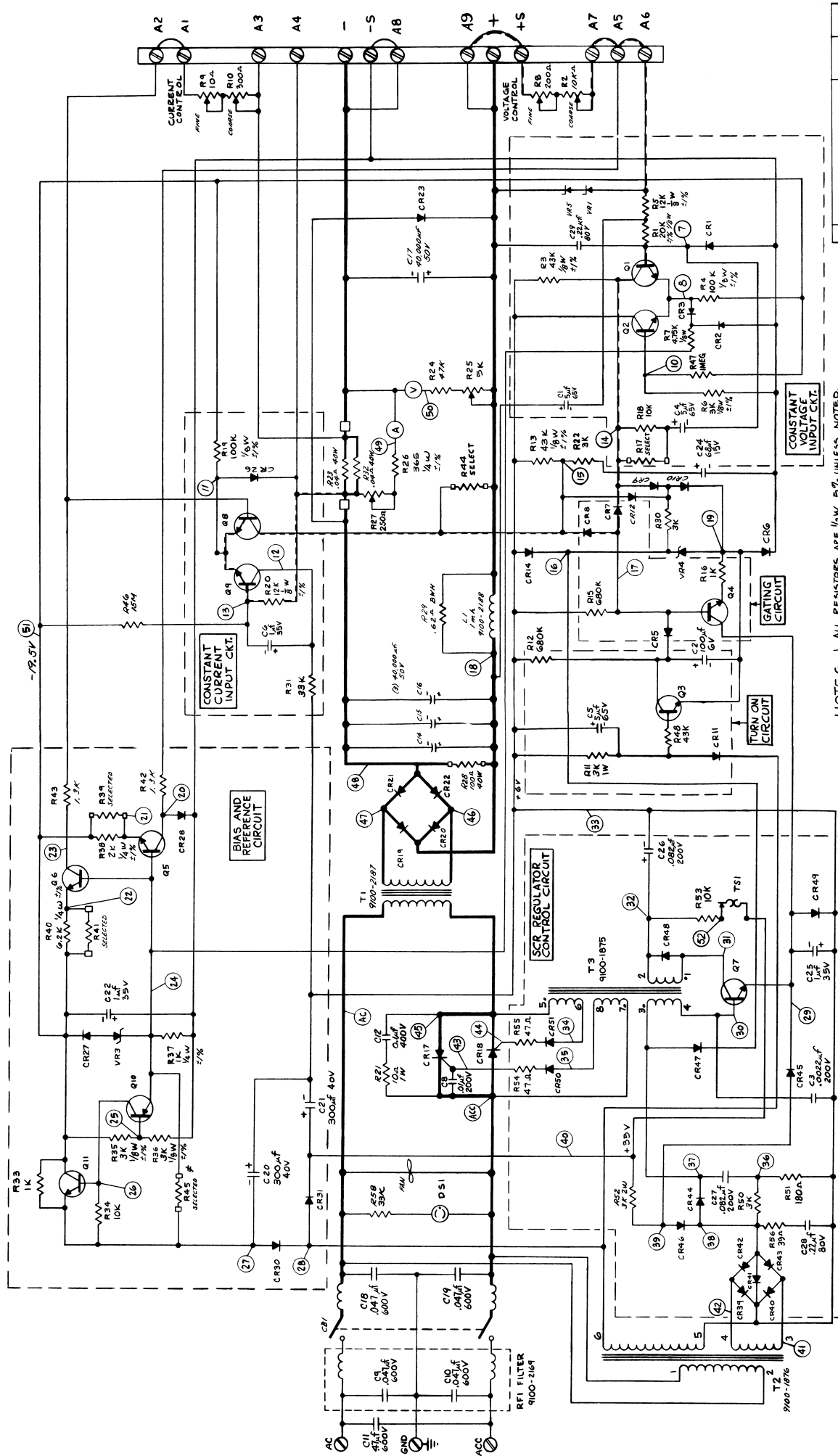

DATE	REV	BY	CHKD	DATE
9/2/52	1	AM	AM	9/2/52
TITLE		6434B SCHEMATIC		
PACKAGE		HEWLETT PACKARD		
PART NO.		0-401041 0-25 0000		
DRAWN BY		AM		
CHECKED BY		AM		
APPROVED BY		AM		
SUPERVISOR		AM		
PART NO.		0-06434-91001-1		

- NOTES
1. ALL RESISTORS ARE 1/2W, 5% UNLESS NOTED.
 2. * DENOTES 20 PPM WIRE TEMP. COEFF.
 3. REAR TERMINALS SHOWN IN NORMAL STRAPPING.
 4. INPUT VOLTAGES MEASURED AT 115V, NO LOAD.
 5. --- DENOTES VOLTAGE SIGNAL.
 6. - - - - DENOTES CURRENT SIGNAL.

7. * SELECTED FOR OPTIMUM PERFORMANCE

PATENT APPLIED FOR ON THIS CIRCUIT. LICENSE TO USE MUST BE OBTAINED IN WRITING FROM HARRISON LABORATORIES, DIV. OF HEWLETT PACKARD

ELECTRONIC INSTRUMENTATION SALES AND SERVICE

EUROPE

AUSTRIA

Unilabor H.m.B.H.
Wissenschaftliche Instrumente
Rummelhardtgasse 6/3
P.O. Box 33
Vienna 1X/71
Tel: 426 181
Cable: LABORINSTRUMENT
Vienna

BELGIUM

Hewlett-Packard Benelux S.A.
20-24 rue de l'Hôpital
Brussels
Tel: 11 22 20
Cable: PALOBEN Brussels

DENMARK

Tage Olsen A/S
Ronnegade 1
Copenhagen O
Tel: 29 48 00
Cable: TOCOPEN Copenhagen

FINLAND

INTO O/Y
Meritulinkatu 11
P.O. Box 10153
Helsinki 10
Tel: 61 133
Cable: INTO Helsinki

FRANCE

Hewlett-Packard France
2 rue Tête d'Or
Lyon, 6 - Rhône
Tel: 52 35 66
Hewlett-Packard France
150 Boulevard Massena
Paris 13e
Tel: 707 97 19
Cable: HEWPACK Paris

GERMANY

Hewlett-Packard Vertriebs-GmbH
Lietzenburger Strasse 30
1 Berlin W 30
Tel: 24 86 36

Hewlett-Packard Vertriebs-GmbH

Herrnberger Strasse 110
703 Böblingen, Württemberg
Tel: 07031-6971
Cable: HEPAG Böblingen

Hewlett-Packard Vertriebs-GmbH

Achenbachstrasse 15
4 Düsseldorf 1
Tel: 68 52 58/59

Hewlett-Packard Vertriebs-GmbH

Kurhessenstrasse 95
6 Frankfurt 50
Tel: 52 00 36
Cable: HEWPACKSA Frankfurt

Hewlett-Packard Vertriebs-GmbH

Beim Strohhause 26
2 Hamburg 1
Tel: 24 05 51/52
Cable: HEWPACKSA Hamburg

Hewlett-Packard Vertriebs-GmbH

Reginfriedstrasse 13
8 Munich 9
Tel: 69 51 21/22
Cable: HEWPACKSA Munich

GREECE

Kostos Karayannis
18, Ermou Street
Athens 126
Tel: 230 301
Cable: RAKAR Athens

IRELAND

Hewlett-Packard Ltd.
224 Bath Road
Slough, Bucks, England
Tel: Slough 28406-9, 29486-9
Cable: HEWPIE Slough

ITALY

Hewlett-Packard Italiana S.p.A.
Viale Lunigiana 46
Milan
Tel: 69 15 84
Cable: HEWPACIT Milan

Hewlett-Packard Italiana S.p.A.

Palazzo Italia
Piazza Marconi 25
Rome - Eur
Tel: 591 2544
Cable: HEWPACIT Rome

NETHERLANDS

Hewlett-Packard Benelux, N.V.
de Boelelaan 1043
Amsterdam, Z.2
Tel: 42 77 77
Cable: PALOBEN Amsterdam

NORWAY

Morgenstjerne & Co. A/S
Ingeniofirma
6 Wessels Gate
Oslo
Tel: 20 16 35
Cable: MOROF Oslo

PORTUGAL

Telectra
Rua Rodrigo da Fonseca 103
P.O. Box 2531
Lisbon 1
Tel: 68 60 72
Cable: TELECTRA Lisbon

SPAIN

Ataio Ingenieros
Urgel, 259
Barcelona, 11
Tel: 230-69-88
Ataio Ingenieros
Enrique Larreta 12
Madrid, 16
Tel: 235 43 44
Cable: TELEATAIO Madrid

SWEDEN

HP Instrument AB
Hagakersgatan 7
Möndal
Tel: 031 - 27 68 00
HP Instrument AB
Centralvägen 28
Solna
Tel: 08 - 83 08 30
Cable: MEASUREMENTS
Stockholm

SWITZERLAND

HEWPAK AG
Zurcherstrasse
8952 Schlieren
Zurich
Tel: (051) 98 18 21
Cable: HEWPACKAG Zurich

TURKEY

Telekom Engineering Bureau
P.O. Box 376 - Galata
Istanbul
Tel: 49 40 40
Cable: TELEMATION Istanbul

UNITED KINGDOM

Hewlett-Packard Ltd.
224 Bath Road
Slough, Bucks
Tel: Slough 28406-9, 29486-9
Cable: HEWPIE Slough

YUGOSLAVIA

Belram S.A.
83 avenue des Mimosas
Brussels 15, Belgium
Tel: 35 29 58
Cable: BELRAMEL Brussels

FOR AREAS NOT LISTED, CONTACT: Hewlett-Packard S.A.; 54 Route des Acacias; Geneva, Switzerland; Tel: (022) 42 81 50; Telex: 2.24.86; Cable: HEWPACKSA Geneva

AFRICA, ASIA, AUSTRALIA

AUSTRALIA

Hewlett-Packard Australia
Pty. Ltd.
22-26 Weir Street
Glen Iris, S. E. 6
Victoria
Tel: 20-1371 (4 lines)
Cable: HEWPARD Melbourne
Hewlett-Packard Australia
Pty. Ltd.
4 Grose Street
Glebe, New South Wales
Tel: 211-2235, 211-2888
Cable: HEWPARD Sydney

CEYLON

United Electricals Ltd.
P.O. Box 681
Yahala Building
Staples Street
Colombo 2
Tel: 5496
Cable: HOTPOINT Colombo

ETHIOPIA

African Salespower & Agency
Private Ltd., Co.
P.O. Box 718
Addis Ababa
Tel: 44090
Cable: ASACO Addisababa

HONG KONG

Schmidt & Co. (Hong Kong) Ltd.
P.O. Box 297
1511, Prince's Building
10, Chater Road
Hong Kong
Tel: 240168, 232735
Cable: SCHMIDTCO Hong Kong

INDIA

The Scientific Instrument
Co., Ltd.
6, Tej Bahadur Sapru Road
Allahabad 1
Tel: 2451
Cable: SICO Allahbad
The Scientific Instrument
Co., Ltd.
240, Dr. Dadabhai Naoroji Road
Bombay 1
Tel: 26-2642
Cable: SICO Bombay
The Scientific Instrument
Co., Ltd.
11, Esplanade East
Calcutta 1
Tel: 23-4129
Cable: SICO Calcutta
The Scientific Instrument Co., Ltd.
30, Mount Road
Madras 2
Tel: 86339
Cable: SICO Madras

The Scientific Instrument Co., Ltd.
B-7, Ajmeri Gate Extn.
New Delhi 1
Tel: 27-1053
Cable: SICO New Delhi

IRAN

Telecom, Ltd.
P.O. Box 1812
Teheran
Tel: 43850, 48111
Cable: BASCOM Teheran

ISRAEL

Electronics & Engineering
Div. of Motorola Israel Ltd.
16, Kremenetski Street
Tel-Aviv
Tel: 35021/2/3
Cable: BASTEL Tel-Aviv

JAPAN

Yokogawa-Hewlett-Packard Ltd.
Shinshankyu Building
No. 8, Umeda
Kita-ku, Osaka City
Tel: 0726-23-1641
Yokogawa-Hewlett-Packard Ltd.
Ito Building
No. 59, Kotori-cho
Nakamura-ku, Nagoya City
Tel: 551-0215

Yokogawa-Hewlett-Packard Ltd.
Ohashi Building
No. 59, I-chome, Yoyogi
Shibuya-ku, Tokyo
Tel: 370-2281
Cable: YOKOHEWPACK Tokyo
Telex: 232-2034

KENYA

R. J. Tilbury Ltd.
P.O. Box 2754
Suite 517/518
Hotel Ambassadeur
Nairobi
Tel: 25670, 26803, 68206
Cable: ARJAYTEE Nairobi

KOREA

American Trading Co., Korea, Ltd.
Seoul P.O. Box 1103
112-35 Sokong-Dong
Jung-ku, Seoul
Tel: 3.7049, 3.7613
Cable: AMTRACO Seoul

LEBANON

Constantin E. Macridis
Clemenceau Street
Clemenceau Center
Beirut
Tel: 220846
Cable: ELECTRONUCLEAR Beirut

MALAYSIA

MECOMB Malaysia Ltd.
2 Lorong 13/6A
Section 13
Petaling Jaya, Selangor
Cable: MECOMB Kuala Lumpur

NEW ZEALAND

Sample Electronics (N.Z.) Ltd.
8 Matipo Street
Onehunga S.E. 5
Auckland
Tel: 667-356
Cable: ELPAS Auckland

PAKISTAN (EAST)

Mushko & Company, Ltd.
31, Jinnah Avenue
Dacca
Tel: 80058
Cable: COOPERATOR Dacca

PAKISTAN (WEST)

Mushko & Company, Ltd.
Oosman Chambers
Victoria Road
Karachi 3
Tel: 51027, 52927
Cable: COOPERATOR Karachi

SINGAPORE

Mechanical and Combustion
Engineering Company Ltd.
9, Jalan Kilang
Singapore, 3
Tel: 642361-3
Cable: MECOMB Singapore

SOUTH AFRICA

F. H. Flanter & Co. (Pty.), Ltd.
Rosella House
Buitencingle Street
Cape Town
Tel: 3-3817
Cable: AUTOPHONE Cape Town

F. H. Flanter & Co. (Pty.), Ltd.
104 Pharmacy House
80 Jorissen Street
Braamfontein, Johannesburg
Tel: 724-4172

TAIWAN

Hwa Sheng Electronic Co., Ltd.
P.O. Box 1558
21 Nanking West Road
Taipei
Tel: 46076, 45936
Cable: VICTRONIX Taipei

THAILAND

The International
Engineering Co., Ltd.
P.O. Box 39
614 Sukhumvit Road
Bangkok
Tel: 913460-1-2
Cable: GYSOM Bangkok

VIETNAM

Landis Brothers and Company,
Inc.
P.O. Box H-3
216 Hien-Vuong
Saigon
Tel: 20.805
Cable: LANBROCOMP Saigon

FOR AREAS NOT LISTED, CONTACT: Hewlett-Packard Export Marketing; 1501 Page Mill Road; Palo Alto, California 94304; Tel: (415) 326-7000; Telex: 034-8461; Cable: HEWPACK Palo Alto



ELECTRONIC INSTRUMENTATION SALES AND SERVICE

UNITED STATES

ALABAMA

P.O. Box 4207
2003 Byrd Spring Road S.W.
Huntsville 35802
Tel: (205) 881-4591
TWX: 810-726-2204

ARIZONA

3009 North Scottsdale Road
Scottsdale 85251
Tel: (602) 945-7601
TWX: 910-950-1282

232 South Tucson Boulevard
Tucson 85716
Tel: (602) 623-2564
TWX: 910-952-1162

CALIFORNIA

3939 Lankershim Boulevard
North Hollywood 91604
Tel: (213) 877-1282
TWX: 910-499-2170

1101 Embarcadero Road
Palo Alto 94303
Tel: (415) 327-6500
TWX: 910-373-1280

2591 Carlsbad Avenue
Sacramento 95821
Tel: (916) 482-1463
TWX: 910-367-2092

1055 Shafter Street
San Diego 92106
Tel: (714) 223-8103
TWX: 910-335-2000

COLORADO

7965 East Prentice
Englewood 80110
Tel: (303) 771-3455
TWX: 910-935-0705

CONNECTICUT

508 Tolland Street
East Hartford 06108
Tel: (203) 289-9394
TWX: 710-425-3416

111 East Avenue
Norwalk 06851
Tel: (203) 853-1251
TWX: 710-468-3750

DELAWARE

3941 Kennett Pike
Wilmington 19807
Tel: (302) 655-6161
TWX: 510-666-2214

FLORIDA

Suite 106
9999 N.E. 2nd Avenue
Miami Shores 33138
Tel: (305) 758-3626
TWX: 810-848-7262

P.O. Box 20007
Herndon Station 32814
621 Commonwealth Avenue
Orlando
Tel: (305) 841-3970
TWX: 810-850-0113

P.O. Box 8128
Madeira Beach 33708
410 150th Avenue
St. Petersburg
Tel: (813) 391-0211
TWX: 810-863-0366

GEORGIA

P.O. Box 28234
2340 Interstate Parkway
Atlanta 30328
Tel: (404) 436-6181
TWX: 810-766-4890

ILLINOIS

5500 Howard Street
Skokie 60076
Tel: (312) 677-0400
TWX: 910-223-3613

INDIANA

4002 Meadows Drive
Indianapolis 46205
Tel: (317) 546-4891
TWX: 810-341-3263

LOUISIANA

P.O. Box 856
1942 Williams Boulevard
Kenner 70062
Tel: (504) 721-6201
TWX: 810-955-5524

MARYLAND

6707 Whitestone Road
Baltimore 21207
Tel: (301) 944-5400
TWX: 710-862-0850
P.O. Box 727
Twinbrook Station 20851
12303 Twinbrook Parkway
Rockville
Tel: (301) 427-7560
TWX: 710-828-9684

MASSACHUSETTS

Middlesex Turnpike
Burlington 01803
Tel: (617) 272-9000
TWX: 710-332-0382

MICHIGAN

24315 Northwestern Highway
Southfield 48075
Tel: (313) 353-9100
TWX: 810-232-1532

MINNESOTA

2459 University Avenue
St. Paul 55114
Tel: (612) 645-9461
TWX: 910-563-3734

MISSOURI

9208 Wyoming Place
Kansas City 64114
Tel: (816) 333-2445
TWX: 910-771-2087

2812 South Brentwood Blvd.
St. Louis 63144
Tel: (314) 644-0220
TWX: 910-760-1670

NEW JERSEY

391 Grand Avenue
Englewood 07631
Tel: (201) 567-3933
TWX: 710-991-9707

NEW MEXICO

P.O. Box 8366
Station C 87108
6501 Lomas Boulevard N.E.
Albuquerque
Tel: (505) 255-5586
TWX: 910-989-1665
156 Wyatt Drive
Las Cruces 88001
Tel: (505) 526-2485
TWX: 910-983-0550

NEW YORK

1702 Central Avenue
Albany 12205
Tel: (518) 869-8462

1219 Campville Road
Endicott 13760
Tel: (607) 754-0050
TWX: 510-252-0890

236 East 75th Street
New York 10021
Tel: (212) 879-2023
TWX: 910-581-4376

82 Washington Street
Poughkeepsie 12601
Tel: (914) 454-7330
TWX: 510-248-0012

39 Saginaw Drive
Rochester 14623
Tel: (716) 473-9500
TWX: 510-253-5981

1025 Northern Boulevard
Roslyn, Long Island 11576
Tel: (516) 869-8400
TWX: 510-223-0811

5858 East Molloy Road
Syracuse 13211
Tel: (315) 454-2486
TWX: 710-541-0482

NORTH CAROLINA

P.O. Box 5187
1923 North Main Street
High Point 27262
Tel: (919) 882-6873
TWX: 510-926-1516

OHIO

5579 Pearl Road
Cleveland 44129
Tel: (216) 884-9209
TWX: 810-421-8500

2460 South Dixie Drive
Dayton 45439
Tel: (513) 298-0351
TWX: 810-459-1925

OREGON

Westhills Mall, Suite 158
4475 S.W. Scholls Ferry Road
Portland 97225
Tel: (503) 292-9171
TWX: 910-464-6103

PENNSYLVANIA

2500 Moss Side Boulevard
Monroeville 15146
Tel: (412) 271-0724
TWX: 710-797-3650
144 Elizabeth Street
West Conshohocken 19428
Tel: (215) 248-1600, 828-6200
TWX: 510-660-8715

TEXAS

P.O. Box 7166
3605 Inwood Road
Dallas 75209
Tel: (214) 357-1881
TWX: 910-861-4081

P.O. Box 22813
4242 Richmond Avenue
Houston 77027
Tel: (713) 667-2407
TWX: 910-925-5681

GOVERNMENT CONTRACT OFFICE

225 Billy Mitchell Road
San Antonio 78226
Tel: (512) 434-4171
TWX: 910-871-1170

UTAH

2890 South Main Street
Salt Lake City 84115
Tel: (801) 486-8166
TWX: 910-925-5681

VIRGINIA

P.O. Box 6514
2111 Spencer Road
Richmond 23230
Tel: (703) 282-5451
TWX: 910-956-0157

WASHINGTON

11656 N.E. Eighth Street
Bellevue 98004
Tel: (206) 454-3971
TWX: 910-443-2303

FOR AREAS NOT LISTED, CONTACT: Hewlett-Packard; 1501 Page Mill Road; Palo Alto, California 94304; Tel: (415) 326-7000; TWX: 910-373-1267; Telex: 34-8461

CANADA

ALBERTA

10010 - 105th Street
Edmonton
Tel: (403) 424-0718
TWX: 610-831-2431

BRITISH COLUMBIA

Hewlett-Packard (Canada) Ltd.
2184 West Broadway
Vancouver
Tel: (604) 738-7520
TWX: 610-922-5050

NOVA SCOTIA

7001 Mumford Road
Suite 356
Halifax
Tel: (902) 455-0511
TWX: 610-271-4482

ONTARIO

Hewlett-Packard (Canada) Ltd.
880 Lady Ellen Place
Ottawa 3
Tel: (613) 722-4223
TWX: 610-562-1952

Hewlett-Packard (Canada) Ltd.

1415 Lawrence Avenue West
Toronto
Tel: (416) 249-9196
TWX: 610-492-2382

QUEBEC

Hewlett-Packard (Canada) Ltd.
275 Hymus Boulevard
Pointe Claire
Tel: (514) 697-4232
TWX: 610-422-3022
Telex: 01-2819

FOR AREAS NOT LISTED, CONTACT: Hewlett-Packard Inter-Americas; 1501 Page Mill Road; Palo Alto, Calif. 94304; Tel: (415) 326-7000; TWX: 910-373-1267; Telex: 034-8461; Cable: HEWPACK Palo Alto

CENTRAL AND SOUTH AMERICA

ARGENTINA

Mauricio A. Suárez
Telecomunicaciones
Carlos Calvo 224
Buenos Aires
Tel: 30-6312, 34-9087
Cable: TELEPILOT Buenos Aires

CHILE

Héctor Calcagni
Casilla 13942
Santiago
Tel: 490.505, 393.119

ECUADOR

Laboratorios de Radio-Ingeniería
Calle Guayaquil 1246
Post Office Box 3199
Quito
Tel: 12496
Cable: HORVATH Quito

MEXICO

Hewlett-Packard Mexicana,
S.A. de C.V.
Eugenia 408, Dept. 1
Mexico 12, D.F.
Tel: 43-03-79

PERU

Fernando Ezeta B.
Av. Petit Thouars 4719
Miraflores
Casilla 3061
Lima
Tel: 50346
Cable: FEPERU Lima

URUGUAY

Pablo Ferrando
S.A. Comercial e Industrial
Avenida Italia 2877
Casilla de Correo 370
Montevideo
Tel: 40-3102
Cable: RADIUM Montevideo

BRAZIL

Ciental, Importacao e
Comercio Ltda.
Avenida 13 de Maio, 13-22° andar
Rio de Janeiro G.B.
Tel: 42-9483

COLOMBIA

Instrumentacion
Henrik A. Langebaek & Cia. Ltda.
Cra. 7A N° 48-51/59
Apartado Aereo 6287
Bogota, 1 D.E.
Tel: 45-78-06, 45-55-46
Cable: AARIS Bogota

EL SALVADOR

Electrónica
27 Avenida Norte 1133
Apartado Postal 1589
San Salvador
Tel: 25-74-50
Cable: ELECTRONICA
San Salvador

NICARAGUA

Roberto Terán G.
Edificio Terán
Apartado Postal 689
Managua
Tel: 3451, 3452
Cable: ROTERAN Managua

PUERTO RICO

San Juan Electronics, Inc.
P.O. Box 5167
Ponce de León 150, Stop 3
Puerta de Tierra Santa
San Juan 00906
Tel: (809) 725-3342
Cable: SATRONICS San Juan

VENEZUELA

Citec, C.A.
Edif. Arisan-Of. #4
Avda. Francisco de Miranda
Apartado del Este 10934 Chacaito
Caracas
Tel: 71.88.05
Cable: CITECAL Caracas

COSTA RICA

Ciental, Importacao e
Comercio Ltda.
Rua Des. Eliseu Guilherme, 62
Sao Paulo 8
Tel: 70-2318
Cable: CIENTALCO, Sao Paulo

COSTA RICA

Lic. Alfredo Gallegos Gudián
Apartado 3243
San José
Tel: 21-86-13
Cable: GALGUR San José

GUATEMALA

Olander Associates Latin America
Apartado 1226
7a. Calle, 0-22, Zona 1
Guatemala City
Tel: 22812
Cable: OLALA Guatemala City

PANAMA

Electrónica Balboa, S.A.
P.O. Box 4929
Ave. Manuel Espinosa No. 13-50
Bldg. Alina
Panama City
Tel: 30833
Cable: ELECTRON Panama City

FOR AREAS NOT LISTED, CONTACT: Hewlett-Packard Inter-Americas; 1501 Page Mill Road; Palo Alto, Calif. 94304; Tel: (415) 326-7000; TWX: 910-373-1267; Telex: 034-8461; Cable: HEWPACK Palo Alto

MANUAL CHANGES
DC POWER SUPPLY
Model 6434B
Manual Serial Number Prefix 7G

Make all corrections in the manual according to errata below, then check the following table for your power supply serial number and enter any listed change(s) in the manual.

SERIAL		MAKE CHANGES
Prefix	Number	
ALL	-	Errata

SERIAL		MAKE CHANGES
Prefix	Number	

- ERRATA:
- (1) On Figures 3-2 through 3-11, change the (-) and (+) terminals on the long terminal strip to A8 and A9, respectively.
 - (2) On Figure 3-3 delete the wire connected to terminal (A9) and connect it to (+S).
 - (3) In paragraph 2-12, add the following sentence:
"The input power line should be fused for 25 Amps at 115Vac or 15 Amps at 230Vac to allow for current surges resulting from SCR firing".
 - (4) On page 6-5, change the  Part No. for CB1 to 2110-0213.
 - (5) In the Replaceable Parts Table (page 6-7) add the parts Options 17 and 18 as follows:

Option 17 (208Vac Input) or 18 (230Vac Input)

REF. DESIG.	DESCRIPTION	TQ	MFR. PART NO.	MFR. CODE	 PART NO.	RS
CR17, 18	SCR 35A 400prv	2	38639	02735	1884-0058	2
R21	fxd, comp 22 Ω \pm 5% 1W	1	GB-2205	01121	0689-2205	1
R58	fxd, met. ox. 75K Ω \pm 5% 2W	1	Type C42S	16299	0764-0027	1
T1	Transformer, Power	1		09182	06434-80091	1
T2	Transformer, Bias	1		09182	9100-2195	1

Free Manuals Download Website

<http://myh66.com>

<http://usermanuals.us>

<http://www.somanuals.com>

<http://www.4manuals.cc>

<http://www.manual-lib.com>

<http://www.404manual.com>

<http://www.luxmanual.com>

<http://aubethermostatmanual.com>

Golf course search by state

<http://golfingnear.com>

Email search by domain

<http://emailbydomain.com>

Auto manuals search

<http://auto.somanuals.com>

TV manuals search

<http://tv.somanuals.com>