Installation/User's Guide

Agilent J3919A and J3972A OC-3 ATMProbes

Consumer Warranty Statement

AGILENT TECHNOLOGIES LIMITED WARRANTY STATEMENT

AGILENT PRODUCT	DURATION OF LIMITED WARRANTY
OC-3 ATMProbes	1 year

Agilent warrants to you, the end-user customer, that Agilent hardware, accessories and supplies will be free from defects in materials and workmanship after the date of purchase, for the period specified above. If Agilent receives notice of such defects during the warranty period, Agilent will, at its option, either repair or replace products which prove to be defective. Replacement products may be either new or like-new.

Agilent warrants to you that Agilent software will not fail to execute its programming instructions after the date of purchase, for the period specified above, due to defects in material and workmanship when properly installed and used. If Agilent receives notice of such defects during the warranty period, Agilent will replace software media which does not execute its programming instructions due to such defects.

Agilent does not warrant that the operation of Agilent products will be uninterrupted or error free. If Agilent is unable, within a reasonable time, to repair or replace any product to a condition as warranted, you will be entitled to a refund of the purchase price upon prompt return of the product.

Agilent products may contain re-manufactured parts equivalent to new in performance or may have been subject to incidental use.

Warranty does not apply to defects resulting from (a) improper or inadequate maintenance or calibration, (b) software, interfacing, parts or supplies not supplied by Agilent, (c) unauthorized modification or misuse, (d) operation outside of the published environmental specifications for the product, or (e) improper site preparation or maintenance.

AGILENT MAKES NO OTHER EXPRESS WARRANTY OR CONDITION WHETHER WRITTEN OR ORAL. TO THE EXTENT ALLOWED BY LOCAL LAW, ANY IMPLIED WARRANTY OR CONDITION OF MERCHANTABILITY, SATISFACTORY QUALITY, OR FITNESS FOR A PARTICULAR PURPOSE IS LIMITED TO THE DURATION OF THE EXPRESS WARRANTY SET FORTH ABOVE. Some countries, states or provinces do not allow limitations on the duration of an implied warranty, so the above limitation or exclusion might not apply to you. This warranty gives you specific legal rights and you might also have other rights that vary from country to country, state to state, or province to province.

TO THE EXTENT ALLOWED BY LOCAL LAW, THE REMEDIES IN THIS WARRANTY STATEMENT ARE YOUR SOLE AND EXCLUSIVE REMEDIES. EXCEPT AS INDICATED ABOVE, IN NO EVENT WILL AGILENT OR ITS SUPPLIERS BE LIABLE FOR LOSS OF DATA OR FOR DIRECT, SPECIAL, INCIDENTAL, CONSEQUENTIAL (INCLUDING LOST PROFIT OR DATA), OR OTHER DAMAGE, WHETHER BASED IN CONTRACT, TORT, OR OTHERWISE. Some countries, States or provinces do not allow the exclusion or limitation of incidental or consequential damages, so the above limitation or exclusion may not apply to you.

FOR CONSUMER TRANSACTIONS IN AUSTRALIA AND NEW ZEALAND: THE WARRANTY TERMS CONTAINED IN THIS STATEMENT, EXCEPT TO THE EXTENT LAWFULLY PERMITTED, DO NOT EXCLUDE, RESTRICT OR MODIFY AND ARE IN ADDITION TO THE MANDATORY STATUTORY RIGHTS APPLICABLE TO THE SALE OF THIS PRODUCT TO YOU.

Operating Restrictions

The following warnings and operating information are shown in French followed by the English translation.

MISE EN GARDE

Cet appareil répond aux normes de la «Classe de sécurité I» et est muni d'un fil de mise à la terre pour votre protection.

WARNING

This product is a Safety Class I instrument with a protective earth terminal.

MISE EN GARDE

Pour prévenir les risques de choc électrique, la broche de mise à la terre du cordon d'alimentation ne doit pas être désactivée.

WARNING

For protection from electric shock hazard, power cord ground must not be defeated.

Restrictions d'utilisation

L'utilisateur se doit d'observer les mesures de précaution énumérées ci-dessous pour toutes les phases d'utilisation, de service et de réparation de cet appareil. Le fait de ne pas s'y conformer équivaut à ne pas respecter les mises en garde spécifiques contenues dans ce manuel et constitue une violation des normes de sécurité relatives à la conception, la fabrication et l'utilisation prévue de cet appareil. La société Agilent Technologies n'assume aucune responsabilité envers un client qui manquerait de se conformer à ces exigences.

Operating Restrictions

The following general safety precautions must be observed during all phases of operation, service, and repair of this instrument. Failure to comply with these precautions with specific warnings in this manual violate safety standards of design, manufacture, and intended use of this instrument.

Mise à la terre

Afin de minimiser les risques de choc électrique, le châssis et le cabinet de l'appareil doivent être mis à la terre. L'appareil est équipé d'un cordon d'alimentation muni d'une fiche homologuée à trois lames, compatible c.a. La prise murale et la prise femelle de la rallonge électrique doivent respecter les normes de sécurité de la «Commission électrotechnique internationale» (IEC).

Grounding

To minimize shock hazard, the instrument chassis and cabinet must be connected to an electrical ground. The instrument is equipped with a three-conductor AC power cable compatible with an approved three-contact electrical outlet. The power jack and mating plug of the power cord must meet International Electrotechnical Commission (IEC) safety standards.

Environnement

Ne faites pas fonctionner cet appareil en présence de gaz inflammables ou de vapeurs dangereuses. L'utilisation de n'importe quel appareil électrique dans ces conditions constitue un risque élevé pour votre sécurité.

Service et ajustement

Des «tensions dangereuses» résident dans cet appareil. Par conséquent, le service et l'ajustement doivent être effectués uniquement par une personne qualifiée.

Ne remplacez pas de composants lorsque le cordon d'alimentation est sous tension. Il pourrait y avoir présence de «tensions dangereuses» même lorsque l'appareil est déconnecté.

Ne faites pas de service interne ou d'ajustement sauf en présence d'une autre personne, capable de prodiguer les premiers soins et de pratiquer la réanimation.

Service non autorisé

L'installation de pièces étrangères, ou toute modification apportée à l'appareil sans le consentement de Agilent Technologies est formellement interdit. Le fait de procéder à de tels modifications sans autorisation pourrait entraîner l'annulation de la garantie de l'appareil ou de tout contrat de service.

Pour un service et des réparations autorisées, retournez l'appareil à un point de vente et service Agilent Technologies.

Environment

Do not operate the instrument in the presence of flammable gases or fumes. Operation of any electrical instrument in such an environment constitutes a definite safety hazard.

Service and Adjustment

Dangerous voltages exist within this instrument. Service and adjustment of this instrument is to be performed only by trained service personnel.

Do not replace components with the power cable connected. Dangerous voltages may be present even when the power cable is disconnected.

Do not perform internal servicing or adjustment unless another person, capable of rendering first aid and resuscitation is present.

Unauthorized Service

The installation of substitute parts or the installation of any instrument modification not authorized by Agilent Technologies is specifically forbidden. The performance of such unauthorized service can negate the instrument warranty or any maintenance agreements.

Return the instrument to a Agilent Technologies Sales and Service Office for authorized service and repair.

Notice

© Copyright Agilent Technologies, Inc.
All Rights Reserved

Reproduction, adaptation, or translation without prior written permission is prohibited, except as allowed under the copyright laws.

The information contained in this document is subject to change without notice.

Agilent Technologies, Inc. makes no warranty of any kind with regard to this material, including, but not limited to, the implied warranties of merchantability and fitness for a particular purpose. Agilent Technologies, Inc. shall not be liable for errors contained herein or for incidental or consequential damages in connection with the furnishing, performance, or use of this material.

Agilent Technologies, Inc. assumes no responsibility for the use or reliability of its software on equipment that is not furnished by Agilent Technologies, Inc.

This document contains proprietary information that is protected by copyright. All rights are reserved. No part of this document may be photocopied, reproduced, or translated to another language without the prior written consent of Agilent Technologies, Inc.

Agilent Technologies, Inc.
NetMetrix Division
5070 Centennial Boulevard
Colorado Springs, Colorado 80919-2497

Safety Information

Before you use this instrument, be sure to pay special attention to the “Safety” and “Warning” topics in this Manual. Failure to comply with the precautions or with specific warnings in this book violates safety standards of design, manufacture, and intended use of this instrument. Agilent Technologies, Inc. assumes no liability for the customer’s failure to comply with these requirements.

Electric Shock Hazard. Do not remove the system covers. To avoid electric shock, use only the supplied power cords and connect only to properly grounded (3-pin) wall outlets.

Explosion Hazard. Do not operate in the presence of flammable gases.

Fire Hazard. For continued protection against fire hazard replace only with fuse of same type and rating.

Indoor Use. This instrument is designed for indoor use.

Cleaning. To clean the instrument, use a damp cloth moistened with a mild solution of soap and water. *Do not* use harsh chemicals. *Do not* let water get into the instrument.

Product Damage. Do not use this product when:

- the product shows visible damage,
- fails to perform,
- has been stored in unfavorable conditions, or
- has been subject to severe transport stresses.

Make the product inoperative and secure it against any unintended operation. Contact your nearest Agilent Technologies, Inc. office for assistance.

Defects and Abnormal Stresses. Whenever this instrument has been damaged or wet, make the product inoperative and secure it against any unintended operation.

Warning Symbols Used in This Book



Instruction book symbol: the product will be marked with this symbol when it is necessary for the user to refer to the instruction book in order to protect against damage.



Indicates potential for electrical shock.

WARNING

An operating procedure, practice, etc. which, if not correctly followed could result in personal injury or loss of life.

CAUTION

An operating procedure, practice, etc. which, if not strictly observed, could result in damage to, or destruction of, equipment or software.

Conventions Used in this Book

NOTE

An operating procedure, practice, or information of importance, is separated from normal text as shown in this NOTE.

Terminology and conventions in this manual are handled with the following methods:

- Keys on the keyboard such as **PgDn** (page down) or **F1** (function key #1) are printed in the characters you see here.
- Text that you should type is printed in characters such as:
`Filename.ext`
- In some cases, you must press two keys simultaneously. This is represented as **CTRL + Q**.

Trademarks

Agilent is a registered trademark and OpenView is a trademark of Hewlett-Packard Company.

Microsoft, LAN Manager, MS-DOS, and Windows are either registered trademarks or trademarks of Microsoft Corporation in the United States and/or other countries.

UNIX is a registered trademark in the United States and other countries, licensed exclusively through X/Open Company Limited.

Ethernet is a trademark of Xerox Corporation.

Hayes is a registered trademark of Hayes MicroComputer Products, Inc.

IBM and Token-Ring are trademarks of International Business Machines Corporation.

Sun and Solaris are registered trademarks of Sun Microsystems, Inc.

SPARC is a registered trademark of SPARC International, Inc. Products bearing the SPARC trademark are based on an architecture developed by Sun Microsystems, Inc.

Novell and NetWare are registered trademarks of Novell Inc.

Printing History

New editions are complete revisions of this book. Update packages may contain new or additional material and be released between editions. See the date of the current edition on the back cover of this book.

First Edition July 1998 J3919-99501

Additional Help

You can obtain additional assistance in the U.S. by calling U.S. Response Center at 888 699 7280, or Internationally by calling your local Agilent Sales Office.

Contents

Consumer Warranty Statement	ii
Operating Restrictions	iv
Notice	vi
Safety Information	vii
Warning Symbols Used in This Book	viii
Conventions Used in this Book	ix
Trademarks	x
Printing History	xi
Additional Help	xi
1 Introduction	1
Installation and Configuration Overview	4
Local Terminal Configuration and Installation	4
Installation and Bootp Server Configuration	4
Probe Overview	5
System Overview	5
Supported MIBs	7
Management Stations	8
Access Security	8
Status LEDs	10
10Base-T/100Base-TX Telemetry Interface Status LEDs	10
Token-Ring Telemetry Interface Status LEDs	12
OC-3 ATM Interface Status LEDs	13
CONFIG Button	13
Included Parts	14
Optional Accessories	14
2 Local Terminal Configuration	15
Probe Configuration Using a Local Terminal	17
Using a Local Terminal	19
Modify/View Configuration Values	22
Modify/View Security Values	24
Modify/View Interface Values	25
Fast Ethernet Telemetry Interface Configuration	25

Token-Ring Telemetry Interface Configuration	29
OC-3 ATM Interface Configuration	33
Display Interface Summary	36
Modify/View Serial Port Settings	37
3 Installation	41
Selecting a Location	43
Installing the Probe	44
Table Installation	45
Rack or Cabinet Installation	45
Wall Installation	47
Connecting the Probe	49
Connecting to the Network (Out-of-Band)	50
Connecting to 10MB/s Ethernet Telemetry Networks.....	51
Connecting to 10Base-T/100Base-TX Telemetry Networks..	52
Connecting to Token-Ring Telemetry Networks.....	54
About the Information in the Following Sections	57
Connecting to an OC-3 ATM Network (In-Band)	57
Bypass Mode	60
Connecting to the Serial Port (Out-of-Band)	60
Direct Connection	61
Modem Connection	61
Data Switch Connection	66
Starting the Probe	68
Verifying the Installation	69
Out-of-Band Troubleshooting	70
Ethernet Telemetry Interface	70
OC-3 ATM Troubleshooting	71
4 Bootp Server Configuration	73
Probe Configuration Using a Bootp Server	75
Bootp Server Setup on an HP or Sun System	77
Starting the Bootp Server on an HP or Sun System	79
Bootp Server Setup on a PC	81
Using Microsoft LAN Manager	82
Using Novell NetWare	84
Starting the PC Bootp Server	85
Configuring the Bootptab File	87
Example Bootptab File	90

5 Probe Operation	91
Restarting the Probe	93
Warm Start	93
Cycling Power	95
Selecting the Warm Start Menu Item	95
Cold Start	96
Pressing the CONFIG Button Twice	96
Selecting the Cold Start Menu Item	97
6 Download New Firmware	99
Downloading Firmware using an HP-UX Workstation and a Terminal	102
Install New Download Firmware on an HP-UX Workstation . . .	102
Download Firmware to the Probe	103
Downloading Firmware using a Networked PC and a Terminal . . .	106
Setup TFTP Server for Downloading	106
Download Firmware to the Probe	106
Xmodem Download of Firmware	111
A Cables and Connectors	115
OC-3 ATM Interface Cables	117
Token-Ring Cables	118
Serial Port Interface Cables	119
Cable Connector Pin-Outs	120
The Probe's RS-232 Port Pin-Out	120
The Probe's RS-232 Modem Cable Connectors	121
25-pin Terminal/PC Cable Connectors	122
9-pin Terminal/PC Cable Connectors	122
UTP Network Connector Pin-Out	123
STP Network Connector Pin-Out	124
B Specifications	125
Protocol Encapsulation	129
Probe Memory Allocation	130
Glossary	133
Index	
Agilent Technologies, Inc. Offices	

Figures

Figure 1-1: The Probe	3
Figure 1-2: Probe System Example	6
Figure 1-3: Front Panel LEDs	11
Figure 1-4: Back Panel LEDs	12
Figure 2-1: The Probe's Rear Panel	20
Figure 2-2: The Probe's Main Menu	21
Figure 2-3: Modify/View Configuration Values Menu	22
Figure 2-4: Modify/View Security Values Menu	24
Figure 2-5: Modify/View Interface Values Menu (Fast Ethernet)	26
Figure 2-6: Modify/View Interface Values Menu (Token-Ring)	30
Figure 2-7: Modify/View Interface Values Menu (OC-3 ATM, Port 1)	33
Figure 2-8: Modify/View Interface Values Menu (OC-3 ATM, Port 2)	34
Figure 2-9: Modify/View Interface Values Menu (OC-3 ATM, Port 3)	35
Figure 2-10: Display Interface Summary	36
Figure 2-11: Modify/View Serial Port Settings Menu	38
Figure 3-1: Install the Probe in a Rack or Cabinet	46
Figure 3-2: Install the Probe on a Wall	48
Figure 3-3: The Probe's Rear Panel (Token-Ring Option Shown)	51
Figure 3-4: Connecting the Probe to a 10MB/s Ethernet Network	52
Figure 3-5: Connecting the Probe to a 10Base-T/100Base-T Network	54
Figure 3-6: Connecting the Probe using RJ-45 Connectors	55
Figure 3-7: Connecting the Probe using a Media Filter	56
Figure 3-8: Connecting the Probe using Data & DB-9 Connectors	57
Figure 3-9: Close-up of the OC-3 Interfaces	58
Figure 3-10: OC-3 System	58
Figure 3-11: Connecting the Probe to an OC-3 ATM Network	59
Figure 3-12: The Probe's Direct Connection	61
Figure 3-13: The Probe's Modem Connection	62
Figure 3-14: The Probe's Data Switch Connection	67
Figure 5-1: The Probe's Main Menu	95
Figure 6-1: Probe Main Menu (HP-UX Workstation)	104
Figure 6-2: Probe TFTP Download Menu (HP-UX Workstation)	104
Figure 6-3: Probe Main Menu (Networked PC)	108
Figure 6-4: Probe TFTP Download Menu (Networked PC)	109

Figure 6-5: Probe Main Menu (XMODEM)	111
Figure 6-6: Probe XMODEM Download Menu	112
Figure A-1: Data Connector Color Coded Connection Points	124

Tables

Table 1-1: Private MIB Access Security Privileges	9
Table 4-1: Minimum Requirements for a Bootp Server	76
Table 4-2: Bootp Server bootptab Files	87
Table 4-3: Bootptab File Tags	88
Table 4-4: Bootp Process Verification	89
Table 5-1: Probe Data and Parameters Reset by a Cold or Warm Start.	94
Table A-1: OC-3 ATM Cable Types	117
Table A-2: Token-Ring Cable Type, Vp, and Impedance	118
Table A-3: Serial Port Interface Cable	119
Table A-4: Probe's RS-232 Port Pin-Out	120
Table A-5: Probe to Modem Cable Min. Pin-Out (25-Pin to 25-Pin)	121
Table A-6: Probe to 25-Pin Terminal Cable Min. Pin-Out	122
Table A-7: Probe to 9-Pin Terminal Cable Min. Pin-Out	122
Table A-8: UTP (Type 3) Network Connector Pin-Outs	123
Table A-9: STP (Type 1) Network Connector Pin-Outs	124
Table B-1: Protocols Over AAL-5	129
Table B-2: Probe Memory Allocation	131

Introduction

Introduction

This chapter introduces the Agilent J3919A and J3972A OC-3 ATMProbes, shown in Figure 1-1 on page 3, including its installation and configuration options. The OC-3 ATMProbe supports the OC-3c, STS3C and STM-1 standards.

You can use your ATMProbe with the NetMetrix/UX software, supported by HP-UX and Solaris. The term “NetMetrix” is used in this manual to refer to Agilent NetMetrix/UX.

The following sections are included in this chapter:

- “Installation and Configuration Overview” on page 4
- “Probe Overview” on page 5

The Agilent J3919A and J3972A OC-3 ATMProbes are MIPS-based, SNMP-managed ATM interface monitor for OC-3 Asynchronous Transfer Mode (ATM) networks. The ATMProbe is an intelligent device that must be physically located at the site where the ATM circuits reside.

The base hardware configuration supports an OC-3 ATM interface, a 10Base-T/100Base-TX telemetry interface, and a SLIP connection. The OC-3 ATMProbe can also be ordered with an optional Token-Ring telemetry interface. The OC-3 ATM interface supports monitoring both directions of a full-duplex circuit simultaneously. Probe data is retrieved using SNMP via a LAN or SLIP connection.

The 10Base-T/100Base-TX telemetry interface uses a RJ-45 connector. The Ethernet telemetry interface uses an AUI connector. The telemetry port retrieves data associated with the other interfaces on probe, but does not maintain RMON or other network statistics for its own network. The optional Token-Ring telemetry interface uses either an RJ-45 or DB-9 connector. The OC-3 ATM interface uses either multimode or single-mode transceivers with two Fiber SC connectors.

The OC-3 ATMProbe also has a 6-pin mini-DIN connector (Bypass Power) that allows ATMProbe to be connected to an external optical bypass. The optical bypass maintains the network link even if the OC-3 ATMProbe has an interruption in power; it functions only when using fiber SC connectors.

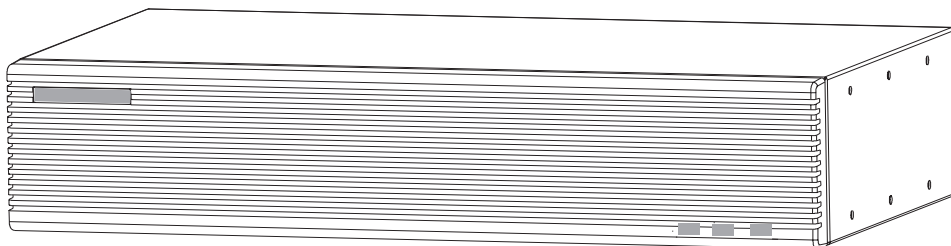

Figure 1-1: The Probe

The OC-3 ATMProbe has 32 MB of memory (optionally 64 or 128 MB), and uses FLASH EPROM. Future upgrades to the probe's firmware are easily downloaded over the LAN to multiple probes simultaneously. You can also download firmware using the probe's serial port.

The ATMProbe maintains a variety of statistical measurements on network performance, continuously keeping track of traffic levels, errors, and other important trends. Alarm thresholds can be set on any of these parameters, immediately alerting the network manager or initiating a packet trace to capture the details of the event for later analysis. AAL-5 traffic and error levels are monitored for the ATM connection. This information is available on a per-PCV basis or as an aggregate of all active SVCs. Information related to SVCs is aggregated into a single set of statistics representing all SVCs.

In addition to using SNMP and selected RMON MIB groups, the ATMProbe uses Agilent private MIB extensions to give additional capabilities. Multiple SNMP trap addresses, or groups of addresses, can be defined for event notification. A real-time utilization variable has been added, which provides the ability to alarm on instantaneous peaks of network load. An additional Out-of-Band connection to the probe can be established using Serial Link Internet Protocol (SLIP), either directly, using a modem, or by using a data switch.

Installation and Configuration Overview

To quickly install and configure your probe, it is important for you to understand the available configuration and installation options. Configuration consists of setting the probe parameters (IP address, for example). Installation consists of physically installing the probe and connecting it to the network.

You will reference different chapters of this Installation/User's Guide depending on which of the following installation and configuration options you select:

- “Local Terminal Configuration and Installation” below
- “Installation and Bootp Server Configuration” below

Local Terminal Configuration and Installation

This method of installation and configuration requires that you configure the probe first and then install the probe. These procedures are detailed in Chapter 2 “Local Terminal Configuration” and Chapter 3 “Installation”.

Installation and Bootp Server Configuration

This method of installation and configuration requires that you install the probe first and then configure the probe. These procedures are detailed in Chapter 3 “Installation” and Chapter 4 “Bootp Server Configuration”.

Probe Overview

This section provides some general information on the Agilent J3919A and J3972A OC-3 ATMProbes.

CAUTION

Since the OC-3 ATMProbe repeats the received signal, a loss of power to the probe results in an interruption of the network signal on the monitored fiber link. To eliminate this possibility, you must install the optional Optical Bypass (Option 125).

The following topics are covered:

- “System Overview” below
- “Supported MIBs” on page 7
- “Management Stations” on page 8
- “Access Security” on page 8
- “Status LEDs” on page 10
- “CONFIG Button” on page 13
- “Included Parts” on page 14

System Overview

A typical probe distributed monitoring system consists of the following:

- One or more ATMProbes
- One or more NetMetrix management stations, using NetMetrix

Figure 1-2 on page 6 shows a ATMProbe system example.

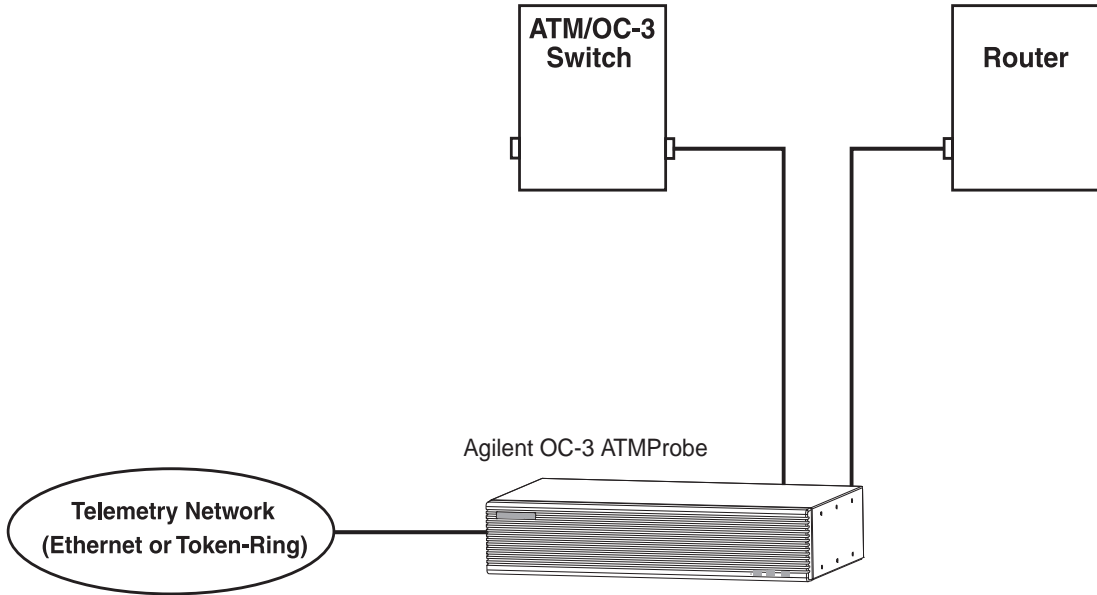

Figure 1-2: Probe System Example

Supported MIBs

The ATMProbe uses SNMP, MIB-II, Agilent private MIB extensions, and selected RMON MIB groups (groups 3,7,8, and 9) to provide the following features:

- Alarms
- Filters
- Packet Capture
- Events
- Log
- Trap
- PVC configuration
- SVC configuration
- Signaling Layer Statistics
- Signaling Layer Historical Statistics
- AAL-5 Protocol Statistics
- AAL-5 Historical Protocol Statistics
- Per PVC AAL-5 Protocol Statistics
- Per PVC AAL-5 Historical Protocol Statistics
- SVC Aggregate AAL-5 Protocol Statistics
- SVC Aggregate AAL-5 Historical Protocol Statistics

* PPP refers to PPP, HDLC, or SDLC.

The ATMProbe implements groups 3, 7, 8, and 9 of RFC 1757, the Remote Network Monitoring Management Information Base (RMON-1 MIB). Refer to the RFC for more information.

The ATMProbe also implements the Agilent Private MIB, which contains all ATM statistics and allows for configuration and administration of the probe. It provides enhanced authentication features, specification of trap destinations, remote download of new firmware revisions, serial line control, and other features. The Agilent Private MIB is available electronically with NetMetrix.

Management Stations

Management stations gather network data collected by Agilent probes. They present this information in easy-to-use and easy-to-understand text and graphic formats. You can use a management station to communicate with your probe after it has been installed and configured.

The probe communicates with the NetMetrix software running on your management station. NetMetrix management applications allow you to review and reconfigure the probe parameters (such as IP address, trap destinations, filters, and packet captures), to manage the information collected by the probe (including statistics, historical studies, alarms, and captured packet traces), and to monitor local or remote networks (by gathering network statistics from Agilent Probe agents as network monitors).

Refer to your NetMetrix documentation for more information.

Access Security

The probe's configuration menu allows network administrators to disable standard RMON functions which could be considered a security risk. The security menu allows network administrators to disable the RMON-1 packet capture capabilities of the probe to prevent network users from viewing network traffic. TFTP firmware downloads can be disabled to prevent users from downloading earlier versions of the probe firmware which did not support these new security features. For more information, refer to "Modify/View Security Values" on page 24.

The probe's private MIB uses a four-level access control scheme. An access level is assigned for each community string to be used with the probe. The access level is an integer value between one and four, with increasing degrees of authorization granted for higher authorization numbers. Each higher level is granted the rights of all lower levels in addition to the specific privileges of that level. Table 1-1 on page 9 shows specific access privileges by level.

Table 1-1: Private MIB Access Security Privileges

Default Community Name	Level	Permissions
public	1	Read access to MIB-II objects.
rmon	2	Read access to MIB-II, RMON MIB, and the probe MIB objects, excluding the objects in the accessControl group and in the captureBuffer Table.
rmon_admin	3	Write access to RMON MIB and the probe MIB objects, excluding the objects in the probeAdmin, interface, and accessControl groups. Read access to MIB-II, RMON MIB (including the captureBuffer Table), and the probe MIB objects, excluding those in the accessControl group.
Agilent_admin	4	Read and write access to all MIB-II, RMON MIB, and the probe MIB objects.

Status LEDs

Your probe has status LEDs for the base hardware configuration (the 10Base-T/100Base-TX telemetry interface), for the OC-3 ATM interface, and for the optional Token-Ring telemetry interface.

The following sections cover the possible status LEDs on your OC-3 ATMProbe:

- “10Base-T/100Base-TX Telemetry Interface Status LEDs” below
- “Token-Ring Telemetry Interface Status LEDs” on page 12
- “OC-3 ATM Interface Status LEDs” on page 13

10Base-T/100Base-TX Telemetry Interface Status LEDs

The status LEDs for the 10Base-T/100Base-TX telemetry interface are visible on the front and back of the probe. Figure 1-3 on page 11 shows the LEDs on the front of the probe and Figure 1-4 on page 12 shows the LEDs on the back of the probe.

The ~ Line On, Activity, and Fault LEDs are on the front of the probe.

On the back of the probe, there are LEDs associated specifically with each interface and a Power LED. The 10Base-T/100Base-TX telemetry interface has LEDs for Activity, Link and Collision.

Refer to the following list for information on how these LEDs work:

~ Line On or Power. This green LED is turned on when the probe is receiving power.

Activity. This green LED is turned on when data is being received from the Ethernet telemetry network or transmitted by the probe. When flashing, the frequency shows the amount of traffic. During periods of steady traffic, it may appear to stay on solid.

Link. This green LED is turned on when the probe is attached to a 10Base-T/100Base-TX network.

Collision. This yellow LED is turned on when LanProbe detects collisions on the network.

Fault. This yellow LED is turned on when the probe needs to be reset, repaired, or replaced or when new firmware is downloaded. The Fault LED is normally on during the power-on self-test, but turns off after a successful self-test or when a cold or warm start is completed.

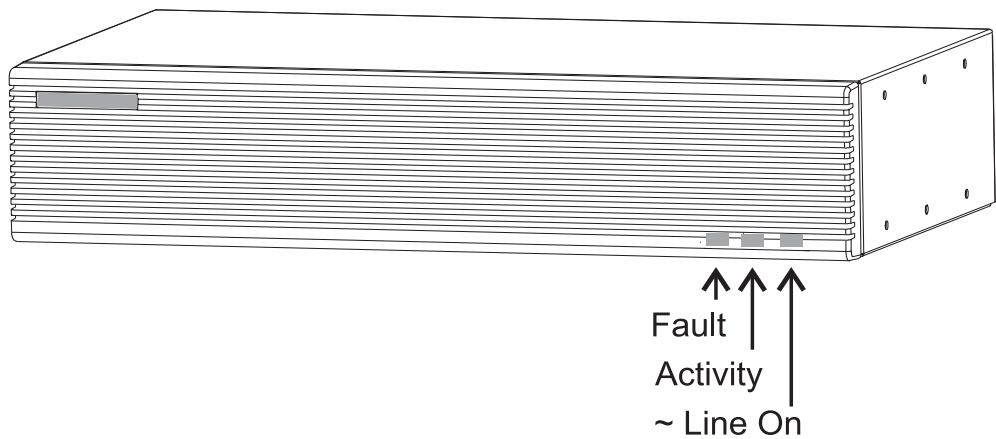
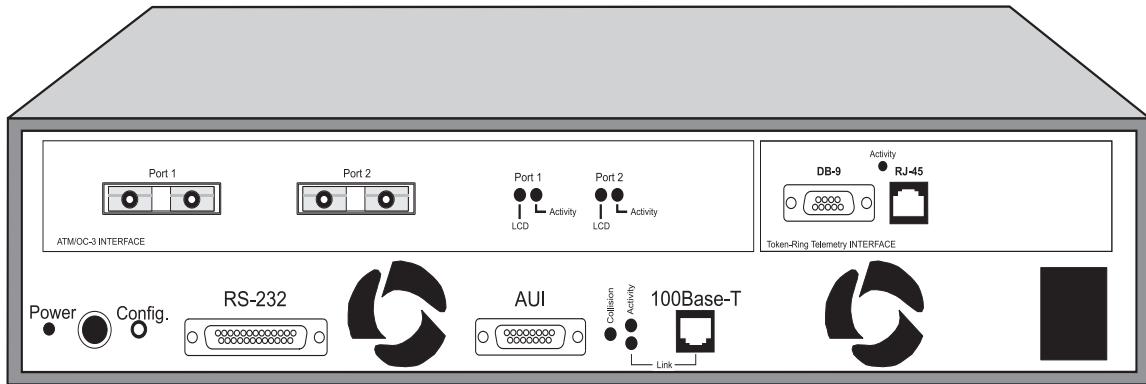
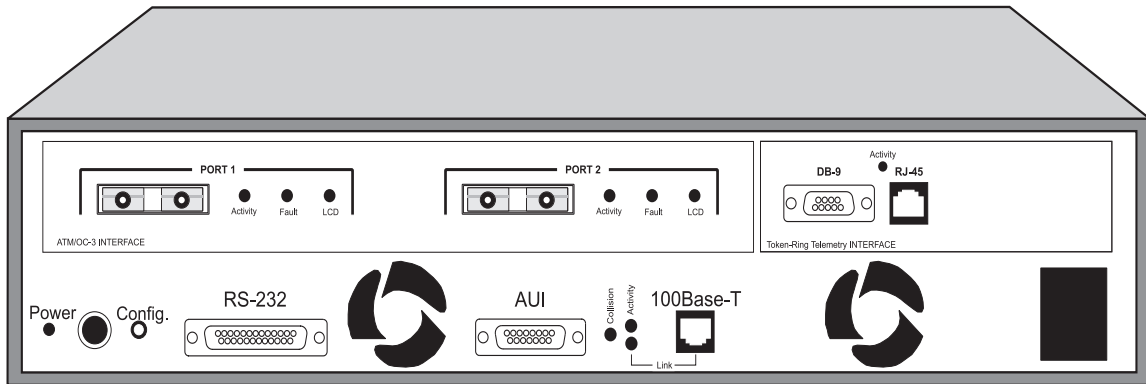

Figure 1-3: Front Panel LEDs



Agilent J3919A



Agilent J3972A

Figure 1-4: Back Panel LEDs

Token-Ring Telemetry Interface Status LEDs

The optional Token-Ring telemetry interface has an LED for **Activity**. This green LED is turned on when data is being received from the network or transmitted by the probe. When flashing, the frequency shows the amount of traffic. During periods of steady traffic, the LED may appear to stay on solid.

OC-3 ATM Interface Status LEDs

The Agilent J3919A ATM interface has LEDs for Activity and Cell Sync functions. The Agilent J3972A ATM interface additionally has a Fault LED. Refer to the following list for information on how these LEDs work:

Activity. This green LED is turned on when valid cells are received by the OC-3 ATM interface from the network. When flashing, the frequency shows the amount of traffic. During periods of steady traffic, the LED may appear to stay on solid.

Cell Sync. This yellow LED is turned on when the OC-3 ATM interface detects a loss of cell synchronization.

The following LED is on the Agilent J3972A probe only:

Fault. This yellow LED is turned on when the processor on the Agilent J3972A probe is not running. The Fault LED can turn on during the power-on self-test, but should be off when the probe is running.

CONFIG Button

The CONFIG button is used to configure the probe from a terminal or to restart the probe. The CONFIG button is recessed and located on the back of the probe near the RS-232C connector. You will need to use a narrow, pointed object (like a pen) to press the CONFIG button.

To configure the probe using a local terminal (or PC emulating a terminal), connect a terminal to the probe using a null modem cable and push the CONFIG button to display the probe's Main Menu. This operation is described in Chapter 2 "Local Terminal Configuration".

You can restart the probe (with a warm start or cold start) using the CONFIG button. These functions are described in Chapter 5 "Probe Operation".

Included Parts

The following items are included with your :Agilent J3919A or J3972A OC-3 ATMProbe:

- Agilent J3919A or J3972A OC-3 ATMProbe
- Bootp Software 3.5-inch Disk, for PCs
- Hardware Kit (5064-0339)
 - Two Mounting Brackets for the Agilent Probe
 - Four 10-mm #M4 Mounting Screws
 - Four 5/8-in #12-24 Mounting Screws
 - Four Self-Adhesive rubber feet
- Power Cord, one of the following:
 - Australian (8120-1369)
 - Danish (8120-2957)
 - European (8120-1689)
 - Japanese (8120-4753)
 - South Africa (8120-4600)
 - Swiss (8120-2104)
 - United Kingdom (8120-1351)
 - United States/Canada 125 V (8120-1378)
 - United States/Canada 250 V (8120-0698)

Optional Accessories

The following Agilent Probe accessories can be purchased from Agilent:

- *Agilent J3919A and J3972A OC-3 ATMProbes Installation/User's Guide*—this manual (J3919-99501)
- Null Modem Cable—9 pin to 25 pin (Agilent 24542G)
- Option 125, external Optical Bypass

Local Terminal Configuration

Local Terminal Configuration

This chapter describes how to use a local terminal to configure your Agilent J3919A or J3972A OC-3 ATMProbe so that it can communicate over a network. If you plan to use the Bootp server method of configuration, skip to “OC-3 ATM Interface Configuration” on page 33 and then continue with Chapter 3 “Installation”.

The following sections are covered in this chapter:

- “Probe Configuration Using a Local Terminal” on page 17
- “Using a Local Terminal” on page 19

Probe Configuration Using a Local Terminal

Some initial configuration information must be entered into the probe before it can communicate over the LAN telemetry network interface or serial port. The ATM interface must be configured before monitoring can occur.

The initial configuration for the Ethernet LAN Telemetry network (10Base-T or 100Base-TX) communication consists of the following parameters:

- IP Address
- Default Gateway IP Address (if required)
- Subnet Mask (if required)
- Autodiscovery Echo Interval

If you are configuring the optional Token-Ring LAN Telemetry interface, you need to configure the following parameters:

- Ring Speed
- Ring Number

The probe uses the following configuration parameters to display time and date information in the user interface only. The probe uses a separate internal clock to time-stamp data collected from the network.

- Date
- Time
- Time Zone

The initial configuration for communication over the serial port consists of the following parameters:

- Serial Port IP Address
- Serial Port Subnet Mask (if required)
- Serial Port Speed
- Serial Port Mode
- Modem Control String (if required)

Local Terminal Configuration

Probe Configuration Using a Local Terminal

The following OC-3 ATM interface parameters must be configured before monitoring can occur. Refer to “OC-3 ATM Interface Configuration” on page 33 for additional information.

- Cell Synchronization
- Cell Scrambling
- Network Type (UNI/NNI)

Using a Local Terminal

You can configure the probe's interfaces by connecting a terminal directly to the probe and using the probe's Main Menu. Refer to the following sections for additional information on configuring the probe after you access the probe's Main Menu:

- “Modify/View Configuration Values” on page 22
- “Modify/View Security Values” on page 24
- “Modify/View Interface Values” on page 25
- “Display Interface Summary” on page 36
- “Modify/View Serial Port Settings” on page 37

NOTE

The probe is not available to the network when you are in its configuration menus.

Use the following procedure to access the probe's Main Menu:

1. Connect a terminal or a personal computer (PC) emulating a terminal to the probe's RS-232 connector using a null modem cable. Refer to Appendix A, “Cables and Connectors”, for more information on cables.
2. Configure the terminal for 8 bits/character, 1 stop bit, no parity, Xon/Xoff handshaking, and a baud rate of 9600.
3. Connect the power cord to the probe and to a power source (either 100-120/VAC or 220-240/VAC). The probe does not have a power switch, but is turned on by connecting power.
4. Start the configuration by quickly pressing the CONFIG button on the back of the probe one time only. After about 10 seconds, the probe displays its Main Menu on the terminal. Figure 2-1 shows the location of the CONFIG button and Figure 2-2 on page 21 shows the probe's Main Menu. If the Main Menu is not displayed, verify that the previous steps in this procedure have been performed correctly.

Local Terminal Configuration Using a Local Terminal

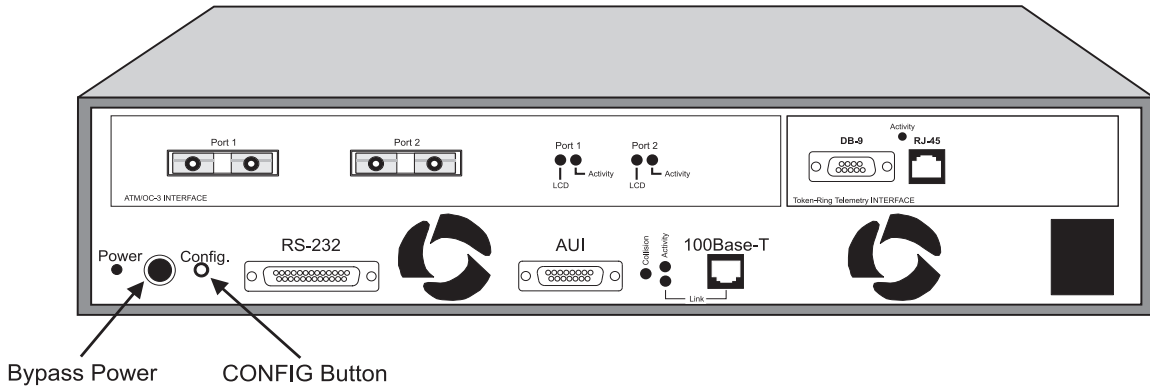

Agilent J3919A

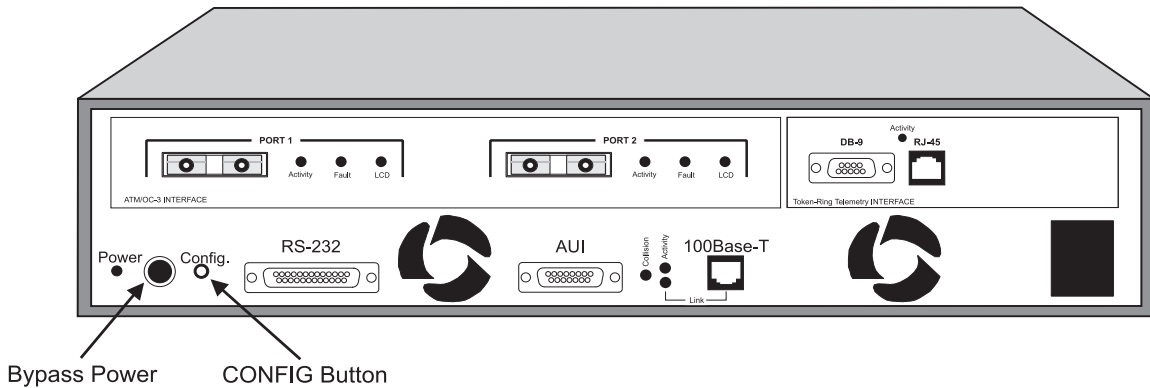

Agilent J3972A

Figure 2-1: The Probe's Rear Panel

NOTE

The probe CONFIG button is recessed. This requires the use of a narrow, pointed object (like a pen) to press the CONFIG button.

The probe executes a cold start if you press the CONFIG button twice within one second. If this happens, wait for the cold start to be completed and press the CONFIG button again to enter the configuration mode.

A warm start or cold start is completed when the Fault LED goes off. If traffic is present, the Activity LED flashes to show traffic.

```
Main Menu - Revision
1. Modify/View configuration values ->
2. Modify/View security values ->
3. Modify/View interface values ->
4. Display interface summary
5. TFTP Download new firmware ->
6. XMODEM Download new firmware ->
7. Warm start and Exit
8. Cold start and Exit
```

Figure 2-2: The Probe's Main Menu

NOTE

Item 5 in Figure 2-2 is not displayed if the **Allow TFTP firmware downloads** menu item is not enabled. Refer to “Modify/View Security Values” on page 24 for more information on enabling this menu item.

If item 5 (TFTP Download new firmware) is not displayed, the number used to access items 6, 7, and 8 will be different.

Modify/View Configuration Values

Use the following procedure to configure items in the Modify/View Configuration Values menu:

1. Press **1** to access the **Modify/View configuration values** menu item. The Modify/View Configuration Values menu is displayed, as shown in Figure 2-3.

```
Modify/View Configuration Values Menu - Firmware Rev

Memory configuration                x Mbytes
1. Autodiscovery Echo Interval (sec.) 1800
2. Date                               Wed 05/05/97
3. Time                               09:12:00
4. Time zone                           PST8PDT

S. Save changes and exit
0. Cancel changes and exit
```

Figure 2-3: Modify/View Configuration Values Menu

2. Select each field requiring configuration (one at a time) by pressing its corresponding number and then entering the values that are appropriate for your network.

Autodiscovery
Echo Interval

Press **1** and enter the autodiscovery echo interval, in seconds, as desired for your probe (optional). This parameter sets the time interval for the probe to transmit an autodiscovery frame, which is used by HP OpenView to maintain its network map.

The default value is 30 minutes (1800 seconds). A value of zero results in no transmission of autodiscovery frames.

- Date Press **2** and enter the day of the week and then the date in month/day/year format (*mm/dd/yy*, through 1999 or *mm/dd/yyyy*, starting 2000).
- Time Press **3** and enter the time of day in hours, minutes, seconds (*hh:mm:ss*) format.
- Time Zone Press **4** and enter your time zone in one to 15 characters (optional).

The Time Zone characters are stored for your convenience and are used to time-stamp probe information.

Recommended practice is to use the format of Time Zone, hours from Greenwich mean time, and then Daylight Saving Time, such as PST8PDT for Pacific Standard Time (the default). The probe does not automatically update the Time field when your local time changes from standard time to daylight savings and back.

The values you enter for date and time take effect as soon as you enter them. All other parameters do not take effect until you select the **Save Changes and Exit** menu item.

3. Press **S** to save the configuration changes and return to the probe's Main Menu. If you want to cancel your current changes and return to the probe's Main Menu, press **0**.

NOTE

The other Main Menu items are explained in other chapters of this manual. The **TFTP Download new firmware** and **XMODEM Download new firmware** menu item is described in Chapter 6 "Download New Firmware". The **Warm start and Exit** and **Cold start and Exit** menu items are explained in Chapter 5 "Probe Operation".

Modify/View Security Values

Use the following procedure to configure items in the Modify/View Security Values menu:

1. If you want to restrict access to the probe press **2** to access the **Modify/View security values** menu item, otherwise skip this section. When you press **2**, the Modify/View Security Values menu is displayed, as shown in Figure 2-4.

```
Modify/View Security Values Menu - Firmware Rev
```

```
1. Allow packet capture           Yes
2. Allow TFTP firmware downloads  Yes
S. Save changes and exit
0. Cancel changes and exit
```

Figure 2-4: Modify/View Security Values Menu

2. Select each field requiring configuration (one at a time) by pressing its corresponding number and then entering the values that are appropriate for your network. Refer to “Access Security” on page 8 for more information on security.

Allow Packet Capture Press **1** and enter Yes to allow or enter No to not allow packet capture.

Allow TFTP Firmware Downloads Press **2** and enter Yes to allow or enter No to not allow TFTP firmware downloading.

3. Press **S** to save the configuration changes and return to the probe’s Main Menu. If you want to cancel your current changes and return to the probe’s Main Menu, press **0**.

Modify/View Interface Values

After you access the Modify/View Interface Values menu, you must first select the port that you want to configure and then configure that port. For example, the possible options for the port parameter could be the following:

- [1] 1.1/Ethernet
- [2] 1.2/Serial
- [3] 3.1/ATM
- [4] 3.1/ATM-AL5
- [5] 3.1/STS3C-STM1

The Modify/View Interface Values section is divided into the following topics. Refer to the desired topic to modify or view your specific interface values.

- “Fast Ethernet Telemetry Interface Configuration” below
- “Token-Ring Telemetry Interface Configuration” on page 29
- “OC-3 ATM Interface Configuration” on page 33

Fast Ethernet Telemetry Interface Configuration

Use the following procedure to configure items in the Modify/View Interface Values menu for the Fast Ethernet Telemetry Interface:

1. Press **3** to access the **Modify/View interface values** menu item. The Modify/View Interface Values menu is displayed, as shown in Figure 2-5 on page 26.

```
Modify/View Interface Values Menu - Firmware Rev

MAC Address                00 00 C6 XX XX XX
Interface Type             Ethernet

1. Port                    1.1/Ethernet
2. Port Type               Telemetry
3. IP address              0.0.0.0
4. Default gateway IP address 0.0.0.0
5. Subnet mask             255.0.0.0

6. Physical Connector      RJ-45
7. Link Speed              Auto Negotiate

S. Save changes and exit
0. Cancel changes and exit
```

Figure 2-5: Modify/View Interface Values Menu (Fast Ethernet)

2. Select each field requiring configuration (one at a time) by pressing its corresponding number and then entering the values that are appropriate for your network.

NOTE

Refer to “Display Interface Summary” on page 36 for information on port types and port numbers for the installed interfaces.

Port

Press **1** and then press **1** again to display the Ethernet port’s configuration parameters along with their current settings. Port 1 is always the Ethernet telemetry interface (the 10Base-T/100Base-TX with RJ-45 and AUI connectors). You can then view or configure the Ethernet port’s configuration parameters.

NOTE

If the optional Token-Ring telemetry interface is **not** installed, the probe will not allow you to change the Fast Ethernet interface's port type from telemetry.

If the Token-Ring telemetry interface is installed, you can configure either the Fast Ethernet interface or the Token-Ring interface as the telemetry interface. The Fast Ethernet interface comes from the factory configured as Telemetry and the Token-Ring interface comes configured as Monitor/Transmit and is disabled. "Disabled" in this case means that the interface does not function at all, not as a Telemetry port nor as a Monitor/Transmit port. If you configure the Token-Ring interface as Telemetry, the Fast Ethernet interface automatically becomes configured as Monitor/Transmit and is disabled.

Port Type

The Fast Ethernet interface can only be used as a Telemetry port. The telemetry port does not maintain network statistics for the Fast Ethernet interface. The telemetry interface only allows the retrieval of ATM network statistics. Port 1 is the Fast Ethernet interface and it is the telemetry port by default. If the Token-Ring interface is also installed, you can select either the Fast Ethernet or the Token-Ring interface (but not both) as the telemetry port. Refer to "Token-Ring Telemetry Interface Configuration" on page 29 for information on configuring the Token-Ring interface. The probe must be configured with exactly one telemetry port.

The *Telemetry* port only receives packets destined to the telemetry port's IP address, can transmit packets onto the network, and is used for SNMP communications to the probe.

Local Terminal Configuration Using a Local Terminal

It requires the IP Address, Subnet Mask, and Default Gateway IP Address fields. The following apply to Telemetry ports:

- HP OpenView can discover the interface
- The interface is IP addressable
- The interface responds to RMON-1
- The interface will transmit all traps from the probe
- The interface will transmit all extended RMON packets sample from Monitor-only ports, Monitor/Transmit ports.

IP Address	Press 3 and enter the IP address for the probe. If the IP address is 0 . 0 . 0 . 0, the probe will transmit Bootp Requests for configuration information (including IP address) over the network. This does not apply to ports configured as Monitor-Only.
Default Gateway IP Address	Press 4 and enter the default gateway IP address for the probe (optional).
Subnet Mask	Press 5 and enter the subnet mask for the probe.
Physical Connector	Press 6 and select the physical connector. The menu only shows the physical connectors that are available. You can use the RJ-45 or AUI connector. If you select AUI, items 7 and 8 (Link Speed and Full/Half Duplex) are not available. AUI is 10MB/s half-duplex.

CAUTION

If you manually selected the Link Speed, be careful to configure it correctly. If you configure the Link Speed for 100 MB/s and you connect the probe to a 10MB/s network, the probe will generate 100% utilization for that segment.

Link Speed	Press 7 and select the Link Speed as Auto Negotiate, 10MB/s, or 100MB/s. When you configure this parameter for Auto Negotiate, the item 8 parameter (Full/Half Duplex) is not available.
------------	-------------------------------------------------------------------------------------------------------------------------------------------------------------------------------------------------

Full/Half Duplex Press **8** and select the line type as Half-Duplex or Full-Duplex. This parameter is not available unless the 10MB/s or 100MB/s option was selected for the Link Speed parameter.

Parameters do not take effect until you select the **Save Changes and Exit** menu item.

3. Press **S** to save the configuration changes and return to the probe's Main Menu. If you want to cancel your current changes and return to the probe's Main Menu, press **0**.

Token-Ring Telemetry Interface Configuration

If the optional Token-Ring telemetry interface is not installed, skip this section and continue with "OC-3 ATM Interface Configuration" on page 33. Otherwise, use the following procedure to configure items in the Modify/View Interface Values menu for the Token-Ring Telemetry Interface:

1. Press **3** to access the **Modify/View interface values** menu item. The Modify/View Interface Values menu is displayed, as shown in Figure 2-6 on page 30.

Local Terminal Configuration Using a Local Terminal

Modify/View Interface Values Menu - Firmware Rev	
MAC Address	00 00 C6 XX XX XX
Interface Type	Token Ring
1. Port	3
2. Port Type	Telemetry
3. IP address	0.0.0.0
4. Default gateway IP address	0.0.0.0
5. Subnet mask	0.0.0.0
6. Token-Ring Speed (Mbps)	16
7. Ring Number	-1
S. Save changes and exit	
0. Cancel changes and exit	

Figure 2-6: Modify/View Interface Values Menu (Token-Ring)

2. Select each field requiring configuration (one at a time) by pressing its corresponding number and then entering the values that are appropriate for your network.

Port

Press **1** and then press the number of the Token-Ring port to display the Token-Ring port's configuration parameters along with their current settings. The port number for the Token-Ring interface (if installed) depends on where it is installed. Refer to "Display Interface Summary" on page 36 for information on port types and port numbers for the installed interfaces. You can then view or configure the Token-Ring port's configuration parameters.

NOTE

If the Token-Ring telemetry interface is installed, you can configure either the Fast Ethernet interface or the Token-Ring interface as the telemetry interface. The Fast Ethernet interface comes from the factory configured as Telemetry and the Token-Ring interface comes configured as Monitor/Transmit and is disabled. “Disabled” in this case means that the interface does not function at all, not as a Telemetry port nor as a Monitor/Transmit port. If you configure the Token-Ring interface as Telemetry, the Fast Ethernet interface automatically becomes configured as Monitor/Transmit and is disabled.

Port Type	Press 2 and select the port type as Telemetry. Making this configuration change will disable the Ethernet telemetry port (port 1). You can select either the Token-Ring or the Fast Ethernet interface (but not both) as the telemetry port. The telemetry port does not maintain network statistics for the Token-Ring interface. The telemetry interface only allows the retrieval of ATM network statistics. Refer to “Fast Ethernet Telemetry Interface Configuration” on page 25 for information on configuring the Fast Ethernet interface. The probe must be configured with exactly one telemetry port.
IP Address	Press 3 and enter the IP address for the probe. If the IP address is 0 . 0 . 0 . 0, the probe will transmit Bootp Requests for configuration information (including IP address) over the network. This does not apply to ports configured as Monitor-Only.
Default Gateway IP Address	Press 4 and enter the default gateway IP address for the probe (optional).
Subnet Mask	Press 5 and enter the subnet mask for the probe.
Token-Ring Speed	Press 6 to modify or view the network speed setting. The default configuration is set to 16 Mbps network speed. You can enter values of 4 or 16 for 4 Mbps or 16 Mbps respectively or enter Auto to automatically sense the ring speed.

Local Terminal Configuration Using a Local Terminal

NOTE

Selecting Auto to automatically sense the ring speed does not function in all network installations. If the probe fails to insert into the ring with the Token-Ring Speed set to Auto, select a fixed speed of 4 or 16 to match your network.

Ring Number Press **7** and enter the local ring number (in Decimal) for your network. Set to -1 for use with ring parameter servers for automatic setting of the ring number, and set to <x> to explicitly set the ring number, where x is the ring number in decimal.

Parameters do not take effect until you select the **Save Changes and Exit** menu item.

3. Press **S** to save the configuration changes and return to the probe's Main Menu. If you want to cancel your current changes and return to the probe's Main Menu, press **0**.

OC-3 ATM Interface Configuration

You must configure two of the three ports on the probe's OC-3 ATM interface. The third port cannot be configured. Use the following procedure to configure items in the Modify/View Interface Values menu for the first port on the OC-3 ATM interface:

1. Press **3** to access the **Modify/View interface values** menu item. The Modify/View Interface Values menu for port 1 is displayed, as shown in Figure 2-7.

Modify/View Interface Values Menu - Firmware Rev

Interface Type	STS3C/STM1
1. Port	3.1/STS3C-STM1
2. Port Type	Monitor-only
3. Cell Synchronization	HEC
4. Cell Scrambling	On
S. Save changes and exit	
0. Cancel changes and exit	

Figure 2-7: Modify/View Interface Values Menu (OC-3 ATM, Port 1)

2. Select each field requiring configuration (one at a time) by pressing its corresponding number and then entering the values that are appropriate for your network.

Port Press **1** and then enter the OC-3 ATM interface's port number to display the OC-3 ATM port's configuration parameters along with their current settings. Refer to "Display Interface Summary" on page 36 for information on port types and port numbers for the installed interfaces. You can then view or configure the OC-3 ATM port's configuration parameters.

Port Type Press **2** and select the port type as Monitor-only.

Local Terminal Configuration Using a Local Terminal

Cell Synchronization Cell Synchronization is configured as HEC (Header Error Control).

Cell Scrambling Press **2** and then set Cell Scrambling to On or Off.

3. Press **S** to save the configuration changes and return to the probe's Main Menu. If you want to cancel your current changes and return to the probe's Main Menu, press **0**.

Use the following procedure to configure items in the Modify/View Interface Values menu for the second port on the OC-3 ATM interface:

1. Press **3** to access the **Modify/View interface values** menu item. The Modify/View Interface Values menu for port 2 is displayed, as shown in Figure 2-8.

Modify/View Interface Values Menu - Firmware Rev	
Interface Type	ATM
1. Port	3.1/ATM
2. Port Type	Monitor-only
3. Network Type	UNI
S. Save changes and exit	
0. Cancel changes and exit	

Figure 2-8: Modify/View Interface Values Menu (OC-3 ATM, Port 2)

2. Select each field requiring configuration (one at a time) by pressing its corresponding number and then entering the values that are appropriate for your network.

Port Press **1** and then enter the desired OC-3 ATM interface's port number to display the OC-3 ATM port's configuration parameters along with their current settings. Refer to "Display Interface Summary" on page 36 for information on port types and port numbers for the installed interfaces. You

can then view or configure the selected OC-3 ATM port's configuration parameters. The following are your OC-3 ATM port choices:

- [3] 3.1/ATM
- [4] 3.1/ATM-AL5
- [5] 3.1/STS3C-STM1

Port Type	Press 2 and select the port type as Monitor-only.
Network Type	Press 3 and then select the Network Type as UNI (User Network Interface) or NNI (Network to Network Interface or Network to Node Interface).

3. Press **S** to save the configuration changes and return to the probe's Main Menu. If you want to cancel your current changes and return to the probe's Main Menu, press **0**.

Use the following procedure to view the configure items in the Modify/View Interface Values menu for the third port on the OC-3 ATM interface. The third port cannot be configured.

1. Press **3** to access the **Modify/View interface values** menu item. The Modify/View Interface Values menu for port 3 is displayed, as shown in Figure 2-9.

```
Modify/View Interface Values Menu - Firmware Rev
Interface Type                                ATM/AL5
1. Port                                        3.1/ATM-AL5
2. Port Type                                  Monitor-only
S. Save changes and exit
0. Cancel changes and exit
```

Figure 2-9: Modify/View Interface Values Menu (OC-3 ATM, Port 3)

Local Terminal Configuration Using a Local Terminal

2. Review the parameters as needed.
3. Press **S** or **0** to return to the probe's Main Menu.

Display Interface Summary

Use the following procedure to view the Display Interface Summary screen, as shown in Figure 2-10 on page 36. The Interface Type will show the cable type (such as V.11) if the cable type can be determined.

1. Press **4** from the Main Menu to access the **Display Interface Summary** item.

The Display Interface Summary item displays the number and type of each interface, the port type, and each port's IP address.

2. Press Enter to continue from the probe's Main Menu.
3. To exit the probe's Main Menu, press **7** to execute a warm start or press **8** to execute a cold start. A cold start is required if you change the IP Address, Default Gateway or Subnet Mask. For either menu choice, the probe exits the Main Menu and restarts normal operations.

Display Interface Summary		
Interface	Port Type	IP Address
-----	-----	-----
1.1/Ethernet	Telemetry	15.6.72.216
1.2/Serial	Not Applicable	0.0.0.0
3.1/ATM	Monitor-only	Not Applicable
3.1/ATM-AL5	Monitor-only	Not Applicable
3.1/STS3C-STM1	Monitor-only	Not Applicable

Figure 2-10: Display Interface Summary

NOTE

A warm start resets all data collected by the probe. A cold start resets all data collected by the probe and also resets any user-configuration information, such as history studies, filters, and alarms to their default values. Refer to Chapter 5 “Probe Operation” for more information on what is reset by warm and cold starts.

After the probe restarts (boots), it operates normally using the new configuration information. The warm start or cold start occurs immediately and there is no visual indication of when it finishes.

4. If you are performing the initial probe configuration, prepare the probe for installation by disconnecting the power cord. You will not lose your initial configuration information.

Modify/View Serial Port Settings

You can view or modify the probe’s serial port settings by entering the Serial Port number into the Modify/View Interface Values Menu’s Port parameter. The Serial Port configuration parameters are then shown along with their current settings. Use the following procedure to configure the probe’s serial port:

1. Enter the probe’s Serial Port number into the Modify/View Interface Values Menu’s Port parameter as shown in Figure 2-5 on page 26. Refer to the “Display Interface Summary” on page 36 to determine the Serial Port number.

Local Terminal Configuration Using a Local Terminal

Modify/View Interface Values Menu - Firmware Rev	
Interface Type	Serial
1. Port	1.2/Serial
2. Port Type	Not Applicable
3. Serial port IP address	0.0.0.0
4. Serial port subnet mask	255.255.252.192
5. Serial port speed	9600
6. Serial port mode	Direct
7. Serial port hardware flow control	On
8. Modem Init String	^s^M^d1^sATE0Q0V1X4 S0=1...
9. Modem Hangup String	^d2^s+++^d2^sATH0^M^d2
10. Modem Connect Responses	/CONNECT/300/CONNECT/1200/...
11. Modem No-Connect Responses	/NO CARRIER/BUSY/NO DIALT...
S. Save Changes and Exit	
0. Cancel Changes and Exit	

Figure 2-11: Modify/View Serial Port Settings Menu

2. Select each field requiring configuration (one at a time) by selecting its corresponding number as shown in Figure 2-11 and then entering the values that are appropriate for your modem's serial port.

Serial port IP address Press **3** and then enter the serial port IP address for the probe. The default Serial Port IP Address is 0 . 0 . 0 . 0.

Serial port subnet mask Press **4** and then enter the serial port subnet mask for the probe (optional). It is recommended that you **do not** change the serial port subnet mask unless there is a conflict. The default Serial Port Subnet Mask is 255 . 255 . 255 . 192 .

Serial port speed	<p>Press 5 and then enter a serial port speed (300 to 38,400 baud) for the probe's SNMP connection. The default is 9600 baud. This speed is used only for Out-of-Band access to the probe using SNMP. It does not affect the serial connection for the local terminal, which is fixed at 9600 baud.</p> <p>Make sure that the serial port speed is set to less than or equal to the maximum speed of the modem to be used.</p>
Serial port mode	<p>Press 6 and then select the serial port mode by pressing 1 for direct connection (the default) or 2 for modem connection.</p>
Serial port hardware flow control	<p>Press 7 and then select hardware flow control Off by pressing 1 or hardware flow control On (the default) by pressing 2.</p>
Modem Init String	<p>Press 8 to enter the modem initialization string. Only the first 20 characters of the 256 character maximum will be displayed in the Modify/View Serial Port Settings menu. The default is <code>^S^M^d1^sATEOQOV1X4 S0=1 S2=43^M</code>.</p>
Modem Hangup String	<p>Press 9 to enter the modem hang-up string. Only the first 20 characters of the 256 character maximum will be displayed in the Modify/View Serial Port Settings menu. The default is <code>^d2^s+++^d2^sATHO^M^d2</code>.</p>
Modem Connect Responses	<p>Press 10 to enter the modem connect responses. Only the first 20 characters of the 256 character maximum will be displayed in the Modify/View Serial Port Settings menu. The default is <code>/CONNECT/300/CONNECT 1200/1200/CONNECT 2400/2400/CONNECT 4800/4800/CONNECT 9600/9600/CONNECT 14400/14400/CONNECT 19200/19200/CONNECT 38400/38400/.</code></p>

Local Terminal Configuration Using a Local Terminal

Modem No-Connect Responses Press **11** to enter the modem no-connect responses. Only the first 20 characters of the 256 character maximum will be displayed in the Modify/View Serial Port Settings menu. The default is /NO CARRIER/BUSY/NO DIALTONE/NO ANSWER/ERROR/.

3. Press **S** to save the serial port configuration changes and return to the probe's Main Menu. If you want to cancel these changes and return to the probe's Main Menu, press **0**.

If you need to configure any other probe parameters, make your selection from the probe's Main Menu.

3

Installation

Installation

This chapter describes how to install Agilent J3919A or J3972A OC-3 ATMProbe. Installing an Agilent probe consists of the following tasks:

- “Selecting a Location” on page 43
- “Installing the Probe” on page 44
- “Connecting the Probe” on page 49
- “Starting the Probe” on page 68
- “Verifying the Installation” on page 69

If you plan to configure the probe from a local terminal and have not yet done so, go to Chapter 2 “Local Terminal Configuration”, and perform the configuration now.

Selecting a Location

Select a location for your probe where it will be the most useful. The probe must be connected to a LAN to retrieve data. The data that can be retrieved was previously monitored from traffic present on the ATM where it is attached.

Consider the following installation requirements when selecting a location for your probe:

- A flat surface that is large enough to support the probe (requires clearance at rear and sides for cooling and rear panel access), adequate wall space, or double high space in a 19 inch rack or cabinet.
- A grounded power outlet (either 100-120/VAC or 220-240/VAC).
- Access to a Fast Ethernet connection tap or to a Token-Ring network MsAU connection (if the Token-Ring Telemetry option is installed).
- Access to the ATM connection to monitor.
- Access to an RS-232C connection (required only for Out-of-Band communication).
- Access to a phone line and a modem within 50 feet (required only for Out-of-Band communication using a modem connection).

NOTE

The MAC addresses for the probe can be found on the rear panel. It is a good idea to make a note of the interface and its address *prior* to installing your probe because some installation methods make it difficult to see the rear panel without removing the probe.

Installing the Probe

This section describes how to install your probe. First decide which installation method you are going to use and then install the probe using one of the following methods:

- “Table Installation” on page 45
- “Rack or Cabinet Installation” on page 45
- “Wall Installation” on page 47

CAUTION

Do *not* attach the power cord to the probe until the probe is completely installed. If the power cord is already attached to the probe, remove it now (you will not lose any configuration parameters). The probe does not have a power switch but becomes operational when the power is attached.

Table Installation

Use the following procedure to install the probe on a table:

1. Attach the self-adhesive rubber feet to the bottom of the probe as marked in each corner.
2. Place the probe on a flat surface (refer to the requirements as listed in “Selecting a Location” on page 43).

Rack or Cabinet Installation

You can install the probe in a rack or cabinet with either the front or rear panel facing out. You may want the rear panel facing out so that you can see the status LEDs for each port. (The front panel Fault and Activity LEDs indicate when the 10Base-T/100Base-TX telemetry interface LEDs are lit.)

Make sure you have screws that fit your rack (or cabinet) before installing the probe as noted in Step 3 below.

Use the following procedure to install the probe in a rack or cabinet:

1. Attach the installation brackets to the probe with the 10-mm #M4 screws (included), using a POZIDRIV® #2 or cross-head screwdriver as shown in Figure 3-1 on page 46.
2. Position the probe in the rack (or cabinet) and slide it up or down until the rack holes line up with the holes in the brackets.
3. Attach the probe to the rack with the 5/8-in. #12-24 screws (included). Some cabinets require 5/8-in. #10-32 screws (available as Agilent part number 2680-0302) instead of the 5/8-in. #12-24 screws.

Figure 3-1 on page 46 shows a rack or cabinet installation.

Installation

Installing the Probe

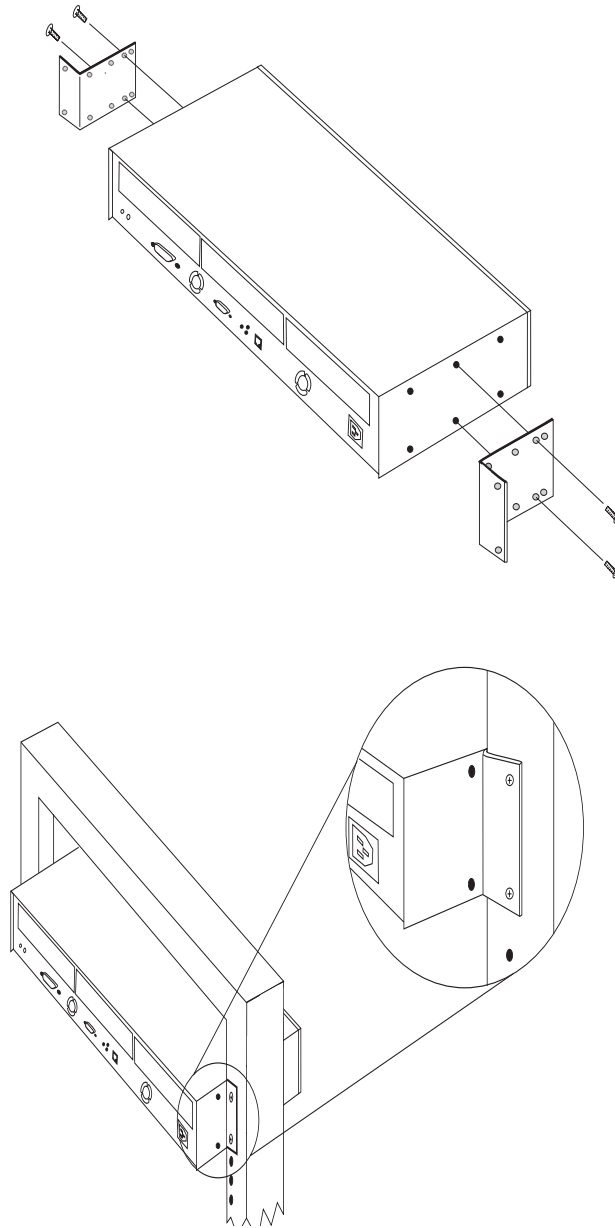

Figure 3-1: Install the Probe in a Rack or Cabinet

Wall Installation

Use the following procedure to install the probe on a wall:

1. Attach the installation brackets to the probe with the 10-mm #M4 screws (included), using a POZIDRIV® #2 or cross-head screwdriver as shown in Figure 3-2 on page 48.
2. Attach the probe to a wood surface (minimum 1/2-in. plywood or equivalent) on a wall with 5/8-in. #12 wood screws or equivalent (not included).

Figure 3-2 on page 48 shows a wall installation.

Installation
Installing the Probe

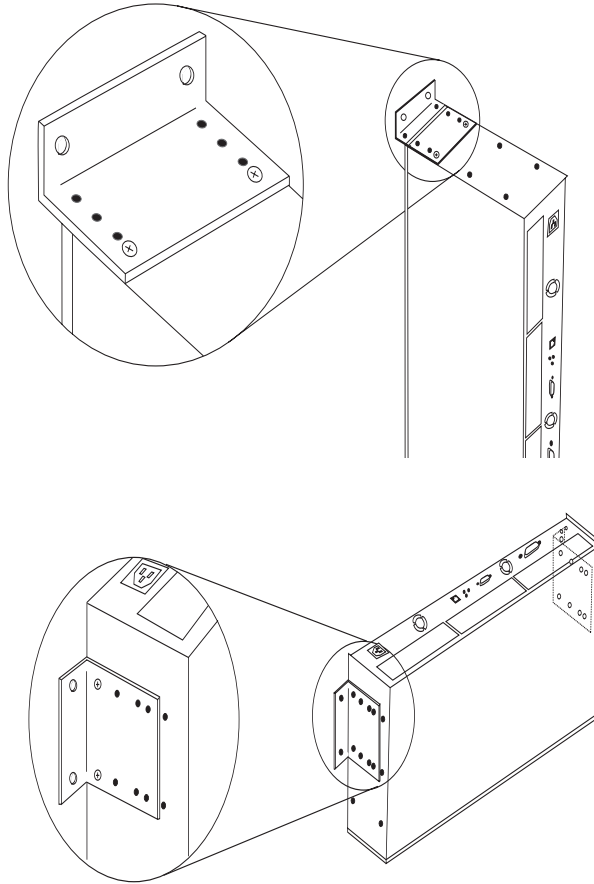

Figure 3-2: Install the Probe on a Wall

Connecting the Probe

The probe communicates with Agilent NetMetrix through Out-of-Band connections using the 10Base-T/100Base-TX or Token-Ring (optional) telemetry interfaces or by using a serial connection. You can connect to an ATM network using the OC-3 ATM interface.

You can establish both telemetry and serial Out-of-Band connections to give you the option of communicating with the probe either over the telemetry network or over the serial link, respectively. The telemetry connection has the advantage of being faster than the serial connection. The disadvantage of using only the telemetry connection is that certain network or component failures can result in a loss of communications with the probe.

The Out-of-Band serial connection can be used as the primary means of communication or as a backup link in case of a failure on your telemetry network. The disadvantage of using only the serial connection is that it is a slower means of communications.

You can connect an Optical Bypass switch and cable (optional) to the probe's Bypass Power connector as specified in the bypass switch instructions. The bypass switch allows uninterrupted network performance if the probe loses power. The probe does not require the bypass switch to function properly.

Refer to one of the following sections in this chapter for specific information on connecting the probe:

- “Connecting to the Network (Out-of-Band)” below
- “Connecting to an OC-3 ATM Network (In-Band)” on page 57
- “Connecting to the Serial Port (Out-of-Band)” on page 60

Connecting to the Network (Out-of-Band)

You can connect the probe to an Out-of-Band telemetry network as described in one of the following topics. Figure 3-3 on page 51 shows both versions of the probe's rear panel with the Token-Ring option installed.

- “Connecting to 10MB/s Ethernet Telemetry Networks” below
- “Connecting to 10Base-T/100Base-TX Telemetry Networks” on page 52
- “Connecting to Token-Ring Telemetry Networks” on page 54

CAUTION

Do not touch the probe connector pins or the cable connector pins. Static discharge may damage equipment.

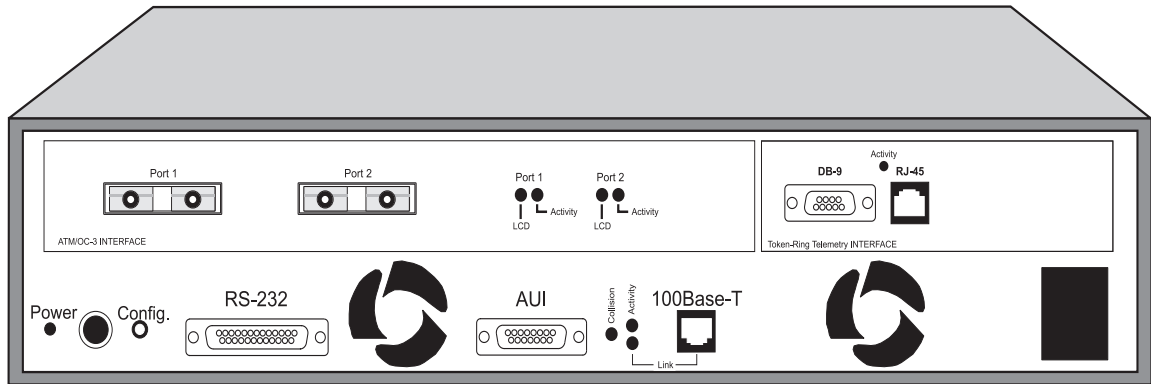

Agilent J3919A

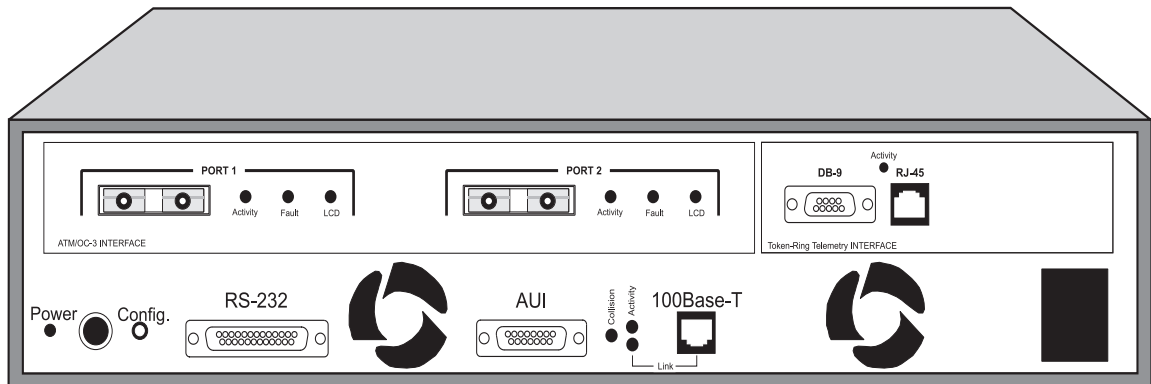

Agilent J3972A

Figure 3-3: The Probe's Rear Panel (Token-Ring Option Shown)

Connecting to 10MB/s Ethernet Telemetry Networks

You can connect the probe to the network either by connecting the RJ-45 connector to a 10Base-T/100Base-TX half-duplex network or by connecting the AUI connector to a 10MB/s Ethernet network. Use the following procedures to connect the probe's AUI connector to a 10MB/s Ethernet network for telemetry communications. Never use both the AUI and RJ-45 connectors.

Installation

Connecting the Probe

1. Connect the probe's AUI port, located on the rear panel, to the network with an AUI cable. Figure 3-4 shows how to connect the probe to a 10MB/s Ethernet network using the AUI connector.
2. Select **AUI** as the Physical Connector parameter from the Modify/View Interface Values menu.

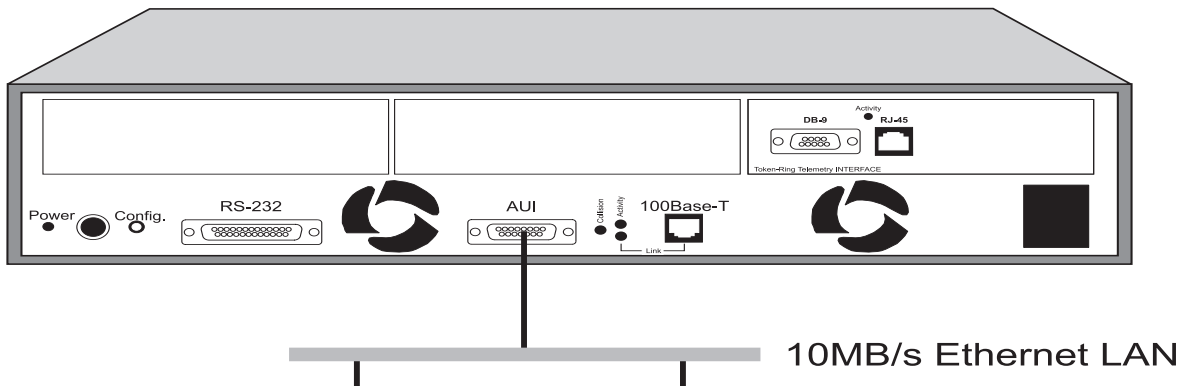

Figure 3-4: Connecting the Probe to a 10MB/s Ethernet Network

The following types of network-specific MAUs are available for connecting to the AUI port:

- Fiber-Optic MAU (Agilent 28683A) - for fiber-optic cabling
- 10Base-2 MAU (Agilent 28641B) - for ThinLAN cabling

NOTE

If the SQE test is available on the MAU, disable it.

Connecting to 10Base-T/100Base-TX Telemetry Networks

You can connect the probe to the network either by connecting the RJ-45 connector to a 10Base-T/100Base-TX half-duplex or full-duplex network or by connecting the AUI connector to a 10MB/s Ethernet network.

Use the following procedures to connect the probe's RJ-45 connector to a 10MB/s or 100MB/s Ethernet network for telemetry communications. Never use both the AUI and RJ-45 connectors.

1. Connect the probe's 10Base-T/100Base-TX (RJ-45) port, located on the rear panel, to the network using a category 5 cable. Figure 3-5 on page 54 shows how to connect the probe to a 10Base-T or 100Base-TX network.
2. Select **RJ-45** as the Physical Connector parameter from the Modify/View Interface Values menu.
3. If you are connecting to a device that supports the auto-negotiation protocol, select **Auto Negotiate** for the Link Speed parameter from the Modify/View Interface Values menu. Otherwise, select **10MB/s** (for 10MB/s Ethernet) or **100MB/s** (for 100MB/s Ethernet).

The probe will automatically negotiate the speed of the interface if the Link Speed parameter is set to **Auto Negotiate** and if the connected device supports the auto-negotiation protocol.

4. If you selected **10MB/s** or **100MB/s** for the Link Speed parameter, you must also select **Half-Duplex** for the Full/Half Duplex parameter from the Modify/View Interface Values menu.

Installation

Connecting the Probe

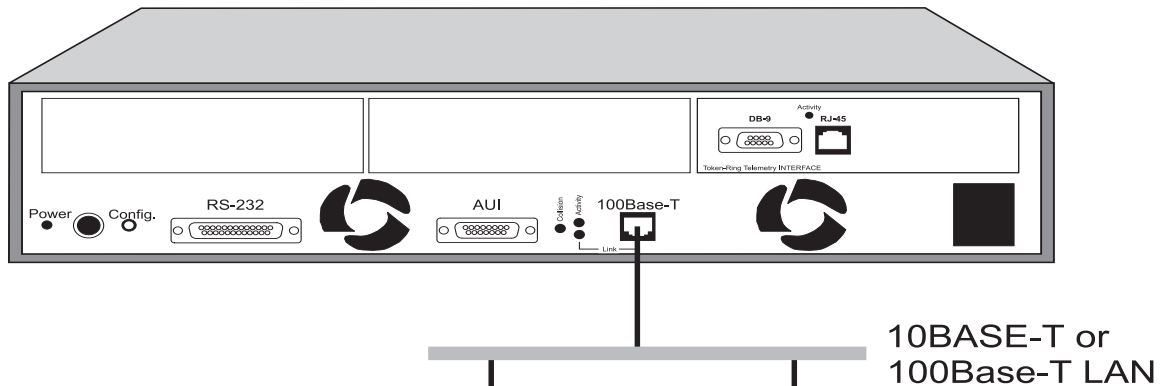

Figure 3-5: Connecting the Probe to a 10Base-T/100Base-T Network

Connecting to Token-Ring Telemetry Networks

The Token-Ring option must be installed to connect the probe to a Token-Ring telemetry network.

CAUTION

Connecting the Token-Ring interface to your network when the interface is configured to the wrong network speed (4Mb/16Mb) can cause **disruption of all traffic on your network** and it will prevent the probe from properly inserting into the ring.

You can configure the Token-Ring Speed from the Modify/View Configuration Values Menu. The probe is configured with a default setting for 16Mbps networks.

You connect the Token-Ring interface to your network by using the appropriate cables. The probe has both RJ-45 and DB-9 connectors on the rear panel for connecting to Token-Ring networks. Figure 3-3 on page 51 shows the back panel with the Token-Ring option installed.

Do not attach cables to both the Token-Ring DB-9 and RJ-45 connectors simultaneously. This causes the probe to malfunction, and can disrupt your network. You must use only one network connector at a time for correct probe operation.

CAUTION

The Token-Ring interface is **not compatible** with Token-Ring expansion modules (Local Ringhub from Madge and other vendors, for example) which require power from the Token-Ring interface. The Token-Ring interface **must** be connected directly to the MsAU.

Token-Ring networks typically use Type 3 (Unshielded Twisted Pair (UTP)) cable or Type 1 (Shielded Twisted Pair (STP)) cable. Networks using UTP cable typically use the RJ-45 type connectors and networks using STP cable typically use Token-Ring Data Connectors or DB-9 type connectors.

If your network uses RJ-45 connectors, you will need the standard cable with RJ-45 connectors on both ends to connect the probe to the ring. Connect one end of this cable to any open port of a Media Station Access Unit (MsAU) and connect the other end to the RJ-45 connector on the probe. Figure 3-6 shows the Token-Ring interface connected to a Type 3 MsAU.

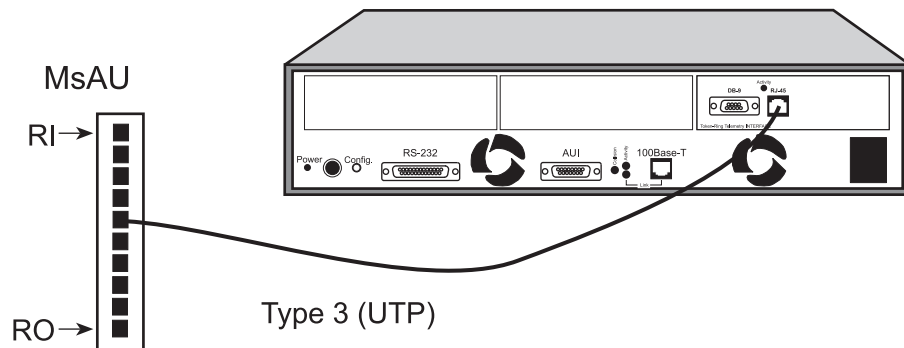

Figure 3-6: Connecting the Probe using RJ-45 Connectors

Installation Connecting the Probe

NOTE

Do not connect the probe to either the ring-in (RI) or ring-out (RO) connection port.

The Token-Ring interface can also be connected to a Type 3 MsAU using a Media Filter. The Media Filter is used to connect from STP (DB-9) to UTP (RJ-45). Figure 3-7 shows the Token-Ring interface connected to a MsAU using a Media Filter.

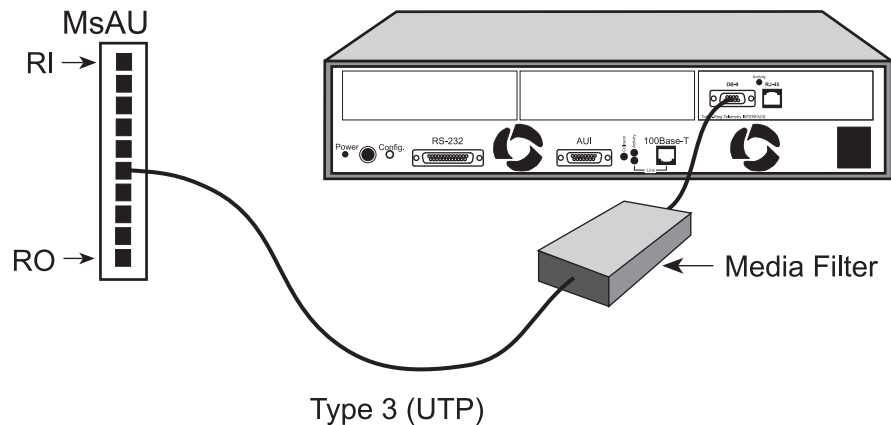

Figure 3-7: Connecting the Probe using a Media Filter

If your network uses the Token-Ring Data Connectors, you need a Type 1 cable with a Token-Ring Data Connector on one end and a DB-9 connector on the other end to connect the probe to the ring. Connect the Token-Ring Data Connector plug to any open port (excluding the RI or RO ports) of a MsAU and connect the DB-9 connector to the probe's DB-9 connector. Figure 3-8 on page 57 shows the Token-Ring interface connected to a Type 1 MsAU using Token-Ring Data and DB-9 connectors.

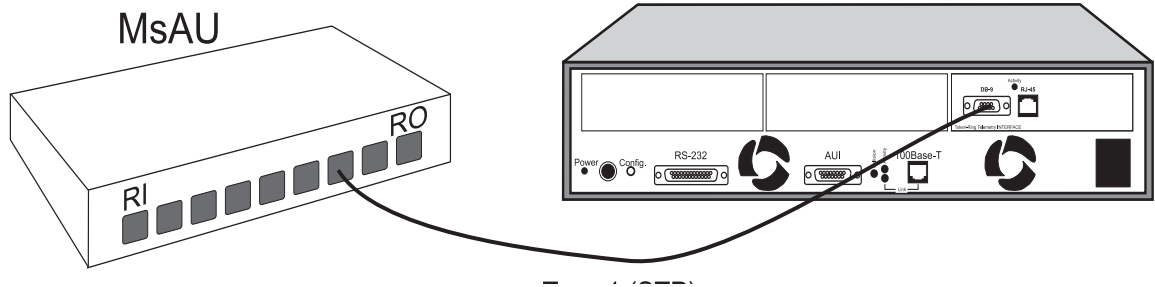

Figure 3-8: Connecting the Probe using Data & DB-9 Connectors

About the Information in the Following Sections

It is assumed that you understand the basic terminology and concepts of ATM network test interfaces.

Comprehensive coverage of network test connections and physical layer testing is beyond the scope of this Installation/User's Guide. Consequently, the information provided here covers only the basics, and only very common or generic connection schemes are shown.

Connecting to an OC-3 ATM Network (In-Band)

To connect the probe to an OC-3 ATM network, you connect the probe in-line with the network connection by using the two fiber-optic connectors and a fiber-optic cable. Figure 3-9 on page 58 shows the details of the OC-3 interfaces.

Installation Connecting the Probe

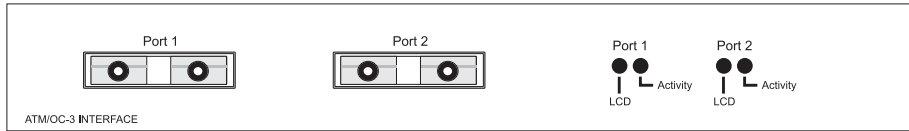

Agilent J3919A



Agilent J3972A

Figure 3-9: Close-up of the OC-3 Interfaces

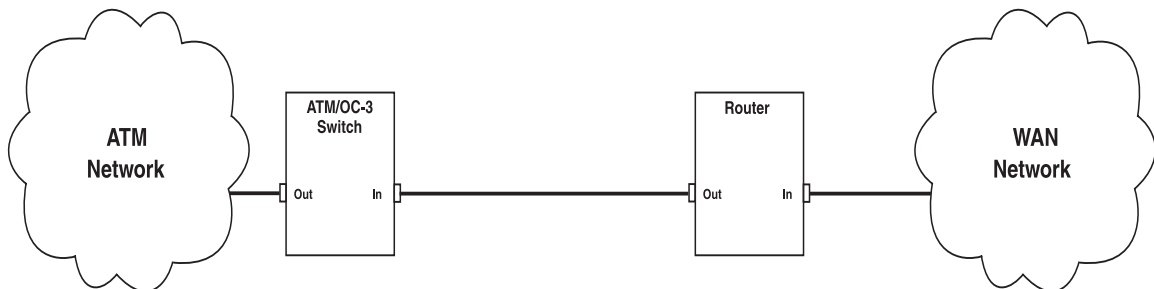

Figure 3-10: OC-3 System

Reference Figure 3-10 and use the following procedure to connect the OC-3 ATProbe to an OC-3 ATM network with a momentary interruption to service:

NOTE

If the output of the probe's OC-3 ATM Interface is transmitted into a multi-mode fiber without using a 10db attenuator, it can saturate the receiver's photodiode and cause bit errors, but no damage can occur. You can order a set of 2 10dB attenuators from Agilent (Agilent J2928A).

1. Disconnect the cable between the ATM/OC-3 switch and router.
2. Connect the OC-3 ATMProbe's Port 1 to the ATM/OC-3 Switch port that was just disconnected in Step 1. Figure 3-11 shows how to connect the probe to an OC-3 ATM network.
3. Connect the OC-3 ATMProbe's Port 2 to the router port that was just disconnected in Step 1.

In this connection scheme, the probe monitors network traffic as if the signal between the switch and Router is sent straight-through the probe.

NOTE

Port 1 of the probe's OC-3 ATM Interface is for connecting to an ATM/OC-3 switch and Port 2 is for connecting to a router. It might be necessary to swap cables.

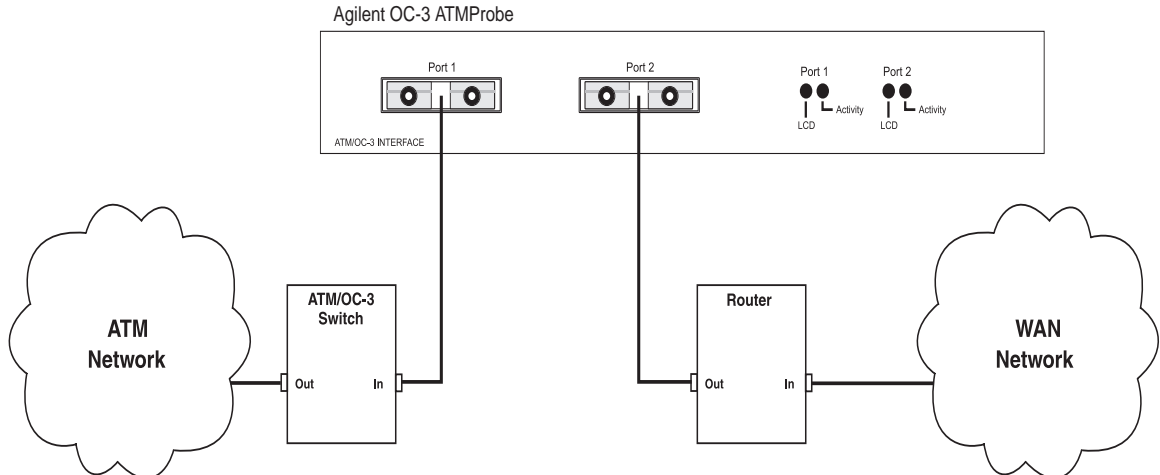

Figure 3-11: Connecting the Probe to an OC-3 ATM Network

Installation

Connecting the Probe

Depending on what type of testing you want to do with the probe's OC-3 ATM Interface, you may need some of the following equipment:

- You may need to put an Attenuator on the output of the probe's OC-3 ATM Interface or the output of the laser source when you are connecting to a network. You can order a set of 2 10dB attenuators (Agilent J2928A).
- Optical Splitters are used when you want to passively monitor network traffic. You can order a multi-mode SC-to-SC Optical Power Splitter (Agilent J2929A).

Bypass Mode

The probe has a 6-pin mini-DIN connector that allows the probe to be connected to an external optical bypass. The optical bypass is optional and only functional when using the fiber SC connectors. The probe's optical bypass is used to maintain the network link even if the probe experiences a power interruption.

Optical Bypass Switches (optional equipment) are required to create a fault tolerant application with fiber networks.

For the Fiber connections, the Bypass Mode is accomplished by using the probe's optical bypass connector. This 6-pin mini-DIN connector is located on the back of the probe, refer to Figure 3-3 on page 51. The optical bypass connector provides power to an external, optical-bypass switch that bypasses the probe when it experiences a power interruption. The result is no interruption to the network. The external, optical-bypass switch must be ordered separately. Refer to the instructions that come with the optical-bypass switch to connect it to the probe.

Connecting to the Serial Port (Out-of-Band)

Out-of-Band communications with the probe are conducted through the serial port, not over the network. This mode of communications is optional.

The following methods are available for Out-of-Band connections:

- “Direct Connection” below
- “Modem Connection” on page 61
- “Data Switch Connection” on page 66

Direct Connection

To make a direct connection to the probe, connect the NetMetrix management station’s serial port to the probe’s RS-232C port using a null modem cable (Agilent part number 24542G—9-to-25 pin, or equivalent). Figure 3-12 shows the direct connection to the probe.

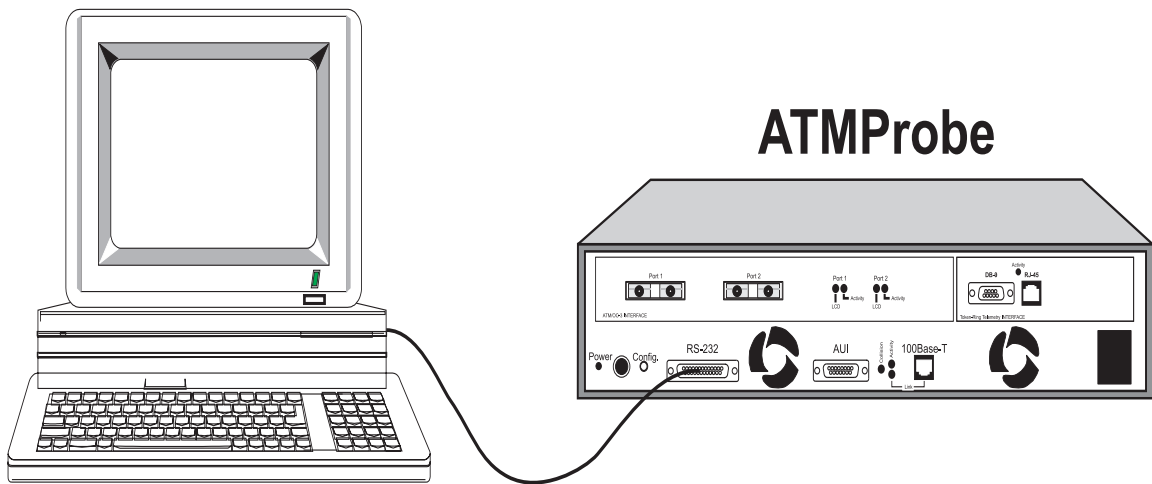

Figure 3-12: The Probe’s Direct Connection

Modem Connection

You can use a modem connection to increase the distance between the probe and the NetMetrix management station. Perform the following tasks to make a modem connection between a NetMetrix management station and the probe. Figure 3-13 shows the modem connection to the probe.

Installation

Connecting the Probe

- “Install the Management Station Modem” below
- “Install the Probe’s Modem” on page 63
- “Configure the Management Station and the Probe” on page 63

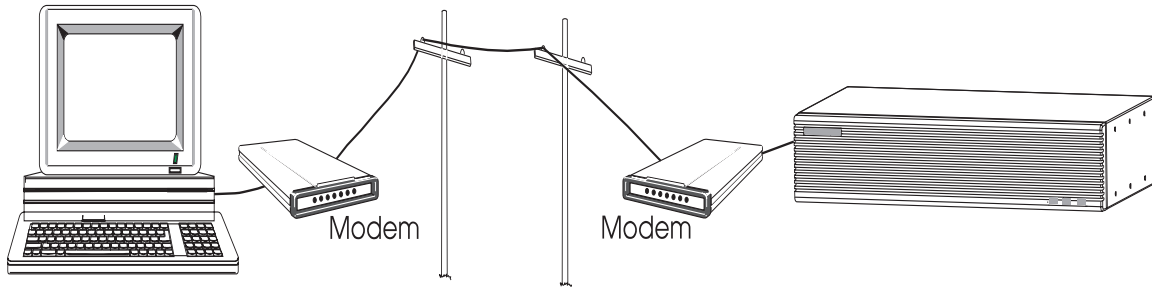

Figure 3-13: The Probe’s Modem Connection

Install the Management Station Modem

You need the following list of equipment to install the management station’s modem:

- Hayes-compatible 300 to 38.4 K baud modem
- RS-232C (straight through) modem cable
- Modular phone cable with RJ-11 connectors or equivalent

Use the following procedure to install the management station’s modem:

CAUTION

Turn off all equipment prior to making cable connections.

1. Place the modem close enough to the management station to not violate the 50-foot RS-232C distance limitation.
2. Connect the RS-232C cable from the modem’s RS-232C port to the management station’s serial port. Take care in selecting the appropriate serial port on the management station (COM1 or COM2, for example).
3. Connect the RJ-11 modular phone cable from the modem **To Line** port to the telephone jack.

4. Connect power to the modem and turn on the modem power switch (not required for a PC internal modem).
5. Perform any other instructions as required by the modem manufacturer. If you have any problems with the modem, contact the modem manufacturer for assistance.

Install the Probe's Modem

You need the following list of equipment to install the probe's modem:

- Hayes-compatible 300 to 38.4 K baud modem
- RS-232C (straight through) modem cable
- Modular phone cable with RJ-11 connectors or equivalent

Use the following procedure to install the probe's modem:

1. Place the modem close enough to the probe to not violate the 50-foot RS-232C distance limitation.
2. Connect an RS-232C cable from the modem's RS-232C port to the probe's RS-232 port. A null modem cable **cannot** be used for this connection.
3. Connect the RJ-11 modular phone cable from the modem **To Line** port to the telephone jack.
4. Connect power to the modem and place the modem power switch to on.
5. Perform any other instructions as required by the modem manufacturer. If you have any problems with the modem, contact the modem manufacturer for assistance.

Configure the Management Station and the Probe

Refer to your NetMetrix documentation for information on configuring the management station for use with a modem. Verify that the packet retransmission timeout is set appropriately. For example, a 1500-byte SNMP packet requires about one second to transmit over a 9600 baud connection, with another one second for the reply. A packet retransmission timeout of three to five seconds is appropriate for this example.

Installation

Connecting the Probe

The probe can be configured for Serial Line Internet Protocol (SLIP) link communications either by using a local terminal through the serial port or by using a NetMetrix management station over the network.

If you use the network to configure the probe, make the network connection (refer to “Connecting to the Network (Out-of-Band)” on page 50) and then refer to your NetMetrix documentation to configure the following probe parameters:

- Serial Port IP Address
- Serial Port Subnet Mask
- Serial Port Speed
- Hardware Flow Control (if unsure, consult your modem’s documentation)
- Modem Init String

If you use an ASCII terminal to configure the probe as described in Chapter 2 “Local Terminal Configuration”, attach the terminal and configure the following probe parameters:

- Serial Port IP Address
- Serial Port Subnet Mask
- Serial Port Speed
- Hardware Flow Control (if unsure, ask your local network administrator)
- Modem Init String

The **Serial Port IP Address** must be on the same IP subnet as the management station’s serial IP address.

Normally, each company has one subnet mask that is used for all machines on their network. Enter this subnet mask value into the **Serial Port Subnet Mask** field. The Serial Subnet Mask used for the probe should match the subnet mask used for the SLIP port on the management station.

Set the **Serial Port Speed** to a value that is less than or equal to the maximum speed at which your modem can operate.

Set the **Hardware Flow Control** to Off (On is the default), unless you are using high speed modems (14.4K baud or faster) with advanced features, such as error correction and data compression. If the Hardware Flow Control is set to On, you can set it to Off by using the probe’s menu or over the network from a NetMetrix management station (refer to your NetMetrix documentation for details).

Verify that the **Modem Init String** is properly initialized for the attached modem by referencing the modem's documentation. The probe's default modem initialization string is configured to work with low-speed and medium-speed Hayes compatible modems. The following modem settings are recommended for low-speed to medium-speed modem connections:

Modem Flow Control:	Off
Data Compression (if applicable):	Off
Error Correction (if applicable):	Off

Not all Hayes commands are the same for all Hayes-compatible modems. Refer to your modem's documentation to determine the commands required for each of the above settings and append these commands to the end of the default **Modem Init String**.

NOTE

Your modem's documentation discusses the features that are relevant to your modem. If your modem does not support a feature (data compression, for example), you do not need to turn it off in the **Modem Init String**.

Some modems require you to set register values explicitly, rather than sending Hayes style commands. In this case, follow your modem's documentation to set these registers.

If you are using a high-speed modem, you probably need to modify the default modem initialization string. The following modem settings are recommended for high-speed modem connections:

Modem Flow Control:	Hardware Flow Control (RTS/CTS signaling)
Carrier Detect:	Always On
Data Compression:	Enabled
Error Correction:	Enabled

After appending the appropriate commands to the modem initialization string, warm start your probe.

Refer to your NetMetrix documentation for information on how to establish communications with the probe over the SLIP link.

Data Switch Connection

Use the data switch connection to provide the flexibility of using more than one management station to communicate with more than one probe.

To make a data switch connection to the probe, connect a NetMetrix management station to the probe's RS-232C port through a data switch. Set the Serial Port Mode to Direct, if your probe is directly connected to the data switch, or set it to Modem, if your probe must dial through a modem to another modem that is attached to the data switch.

To allow traps to be sent from the probe to your management station, specify a Serial Trap Destination of type Switch or Modem Switch, using NetMetrix.

Refer to your data switch documentation for information on setting up your data switch. There are many variations available for this connection method. Figure 3-14 on page 67 shows a possible data switch connection scheme.

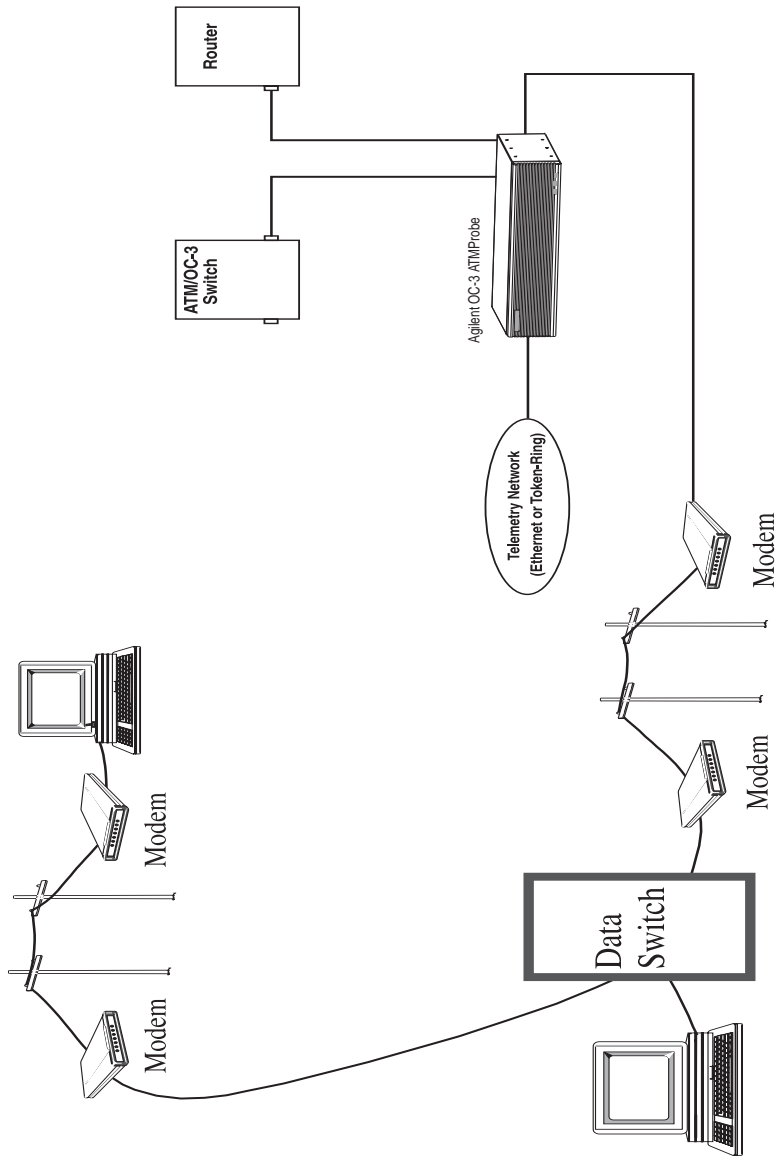

Figure 3-14: The Probe's Data Switch Connection

Starting the Probe

NOTE

If you are using the Bootp server method of configuration, do not attach the power cord to the probe until told to do so in Chapter 4 “Bootp Server Configuration”.

If you used the local terminal method of configuration, attach the power cord to the probe. The probe does not have a power switch, but is powered on when power is attached. When powered on or reset, the probe runs self-tests and transmits ICMP echo frames to the default gateway for the purpose of allowing the probe to be discovered by the routers (ARP cache). The probe transmits four ICMP echo request packets about 10 seconds after booting and again every autodiscovery echo interval. Refer to Chapter 5 “Probe Operation” for more information on resetting the probe.

Verifying the Installation

You can verify the probe's installation by looking at the status LEDs on the front or back of the probe. LEDs on the back of the probe show the status of each port and the LEDs on the front of the probe indicate the status of the 10Base-T/100Base-TX telemetry interface. After the probe restarts (boots), it runs a power-on self-test (POST) and then starts normal operations.

The Fault LED is briefly turned on (about three seconds) during the POST. After the probe passes the POST, the Fault LED turns off. The Activity LED flashes during network activity. The ~Line On or Power LED should be on to indicate that power is applied to the probe.

After the probe has passed its self-tests, look at the status LEDs to verify your installation. The status LEDs should be in the following states:

LED	State
Activity	Flashing, if connected to a network with traffic, or may appear to stay on solid during periods of steady traffic.
~ Line On or Power	On solid
Fault	Off

You can use NetMetrix to verify that the probe can be reached (refer to your NetMetrix documentation).

Out-of-Band Troubleshooting

For the Ethernet or Token-Ring telemetry interface, if the Activity LED is off, verify that the probe is properly connected to the telemetry network and that there is traffic on the network. Also, verify that you have the correct Physical Connector selected from the Modify/View Interface Values menu.

If the ~ Line On or Power LED is off, verify that power is properly connected to the probe and to the correct power source.

If the Fault LED is on, the probe failed the self-test. Repeat the installation procedures and verification of installation. If you have an option installed, you can look at each port's Fault LED to see which port is generating the fault condition.

For the Token-Ring telemetry interface, if you are still having difficulty, call your local Agilent service representative. For the Ethernet telemetry interface, continue with the following "Ethernet Telemetry Interface" section.

Ethernet Telemetry Interface

If you selected **Auto Negotiate** for the Link Speed parameter, verify that the connected Hub or switch supports this mode of operation. If you are not sure, configure the link speed and full-duplex or half-duplex manually.

CAUTION

If you manually selected the Link Speed, be careful to configure it correctly. If you configure the Link Speed for 100 MB/s and you connect the probe to a 10MB/s network, the probe will generate 100% utilization for that segment.

If you manually selected the link speed, verify that you are using the correct speed. Also, if you manually selected the link speed, verify that you are using the correct mode of operation (full-duplex or half-duplex). 10MB/s Ethernet is always half-duplex.

If you are still having difficulty, call your local Agilent service representative.

OC-3 ATM Troubleshooting

There should be a cable connected to both connectors.

Both Activity LEDs (from network and from equipment) should turn on when there are cells present on the network and the Cell Sync LED should be off.

If both the Cell Sync LED and the Activity LED are turned on, the ATMProbe is sensing traffic on the network but is not able to synchronize on the cell stream. Verify the configuration of the probe's OC-3 interface as described in See "OC-3 ATM Interface Configuration" on page 33.

If the Cell Sync LED is turned on and the activity LED is turned off, and you know that there is data on the network, try switching the connectors as they are attached to the ATMProbe. Each connector has a specific purpose. If the cables are attached to the wrong connectors, the probe will not receive data.

Installation
Verifying the Installation

4

Bootp Server Configuration

Bootp Server Configuration

This chapter describes how to use the Bootp server method to configure the Agilent J3919A or J3972A OC-3 ATMProbe so that it can communicate over the network. This chapter assumes that you have already installed the probe, but have not attached the power cord. If you plan to use the local terminal method of configuration, skip this chapter and refer to Chapter 2 “Local Terminal Configuration”.

The following sections are covered in this chapter:

- “Probe Configuration Using a Bootp Server” on page 75
- “Bootp Server Setup on an HP or Sun System” on page 77
- “Bootp Server Setup on a PC” on page 81
- “Configuring the Bootptab File” on page 87

Probe Configuration Using a Bootp Server

You can use a Bootstrap Protocol (Bootp*) server to load the probe's IP configuration. This method requires that a Bootp server maintains a file containing client configuration information, maps from MAC addresses to IP addresses, and responds to requests from clients. You can configure the probe from an HP-UX, Solaris, or MS-DOS system acting as a Bootp server. The system that is operating as the Bootp server must be connected to your network. Table 4-1 on page 76 shows the minimum requirements for a Bootp server operating on HP 9000, Sun SPARC, and PC systems.

Before you can use the Bootp server, you must edit the bootptab file to configure the required probe parameters. Refer to "Configuring the Bootptab File" on page 87 for more information.

The probe's MAC address is twelve characters long and is printed on a tag on the back of the probe. You must determine the IP Address, Default Gateway IP Address, and Subnet Mask from the network.

To allow the probe to use a Bootp server that is not on the same subnet, the router involved must support Bootp Relay (the transfer of a Bootp request). For example, if you have multiple probes that you want to configure from a single Bootp server, be sure that the routers in the path between your Bootp server and the probes support Bootp Relay. Otherwise, you will need to operate the Bootp server on the same subnet as your probes. You can configure multiple probes on one subnet and then place them on their respective segments.

*BOOTP, RFC 951, RFC 1084 phase I only

Bootp Server Configuration
Probe Configuration Using a Bootp Server

Table 4-1: Minimum Requirements for a Bootp Server

Item	Bootp Server type		
	HP	Sun	PC
Model or Processor	HP 9000 Model 700 or 800	Sun SPARC Model 1, 1+, 2, IPC, 5, 10, 20	286 or above
Operating System	HP-UX 9.x or later*	Solaris 2.1 or later*	DOS 3.0 or later
Network Operating System/Subsystem	ARPA Berkeley Services	Sun Networking Services (Ethernet and TCP/IP)	Microsoft LAN Manager 1.0 or later <i>-or-</i> Novell NetWare environment, including LSL.COM v1.2, IPXODI.COM v1.2, NETX.COM v3.1 or later
Floppy Drive	Not Applicable	Not Applicable	3.5-inch Floppy Disk Drive
System Memory	Not Applicable	Not Applicable	10KB of free memory to run the installation process. 100 KB of free memory to run BOOTPD.

- * Although bootp is supported on many versions of HP-UX and Solaris, the NetMetrix application is only supported on specific operating system releases. Refer to your NetMetrix documentation for the list of supported operating system releases.

Bootp Server Setup on an HP or Sun System

If your Bootp server is an HP-UX or Solaris system, use the following instructions to configure the probe:

1. Determine the IP address to be used for the probe.
2. Determine the name to be used as the probe's Domain Name Services (refer to the HP ARPA Services manual) or configure an IP address and name for the probe in your local `/etc/hosts` file.
3. Make sure that the Bootp server can communicate with the probe (if they are separated by a router, the router must support Bootp Relay).
4. From the Bootp server, edit the client configuration file and enter the following parameters to be used for the probe (do not specify any other parameters):
 - MAC Address
 - IP Address
 - Default Gateway IP Address (if available)
 - Subnet Mask

NOTE

The Bootp server must support the vendor specific subnet mask field and the default gateway field.

5. Start the Bootp daemon as described in "Starting the Bootp Server on an HP or Sun System" on page 79.
6. Connect the power cord to the probe and to a power source (either 100-120/VAC or 220-240/VAC). The probe does not have a power switch but becomes operational when power is attached.

Bootp Server Configuration

Bootp Server Setup on an HP or Sun System

The probe automatically broadcasts Bootp requests when its IP address is 0.0.0.0 (the default). The probe broadcasts Bootp requests to signal its need to be configured.

7. For HP-UX systems: Log in as root, then use SAM to follow the instructions presented on the screen.

For HP-UX 9.x, choose:

Networking/Communications -> Service:Enable/Disable

For HP-UX 10.x and 11.x, choose:

Networking and Communications -> Network Services

NOTE

If the last screen presented in Step 7 displays `bootp server enabled`, (for either HP-UX 9.x, HP-UX 10.x, or HP-UX 11.x) then your machine is already set up as a bootp server.

8. Edit the `/etc/bootptab` file to configure the probe and add descriptive comments to the file for reference. Refer to “Configuring the Bootptab File” on page 87, the `bootpd(1M)` man page or the HP ARPA Services manual for more information on configuring the `/etc/bootptab` file.
9. Use `tail -f` to check the system log file to ensure that the Bootp server responded correctly to the Bootp request. The log file is `/var/adm/messages` (Solaris), `/usr/adm/syslog` (HP-UX 9.x), or `/usr/adm/syslog/syslog.log` (HP-UX 10.x and 11.x).
10. If you are using HP OpenView, you can verify that the probe has been assigned the correct IP address and shows up on the management station map as a network analyzer. The discovery process that places the probe in the management station map can take several minutes to complete.

NOTE

You may be able to decrease the required time for discovery of the probe by pinging it continuously from your HP NetMetrix management station. You can also ping the probe to verify that it responds to the new IP address.

Starting the Bootp Server on an HP or Sun System

You can start the Bootp server on an HP or Sun system in one of the following ways. Refer to “Configuring the Bootptab File” on page 87 if you need to configure the bootptab file.

Bootp for Solaris is shipped on the NetMetrix CD-ROM but it is not part of the operating system.

standalone. Become superuser and give one of the following commands:

- `/etc/bootpd -s` for HP-UX v. 9.x
- `/usr/lbin/bootpd -s` for HP-UX v. 10.x & 11.x
- `/usr/netm/sun4s/bootpd -s` for Solaris

inetd. Become superuser and use the following procedure:

1. Edit the file `/etc/inetd.conf`. Search for a line like the following and ensure that the line is uncommented (does not contain a # character). If necessary, add the line to the file.

```
bootps dgram udp wait root path/bootpd bootpd
```

Where path is one of the following:

```
/etc          for HP-UX v. 9.x  
/usr/lbin     for HP-UX v. 10.x & 11.x  
/usr/netm/sun4s for Solaris
```

2. **For HP-UX**, give one of the following commands to force inetd to re-read the `inetd.conf` file that you modified in Step 1:

```
/etc/inetd -c          for HP-UX v. 9.x  
/usr/sbin/inetd -c     for HP-UX v. 10.x & 11.x
```

Bootp Server Configuration

Bootp Server Setup on an HP or Sun System

3. **For Solaris**, determine the process ID for `inetd` by entering the following command:

```
ps -ef | grep inetd
```

Then force `inetd` to re-read the `inetd.conf` file that you modified in Step 1 on page 79 by giving the following command:

```
kill -HUP process_id
```

For additional information, refer to the man pages for `bootpd(1M)`, `inetd(1M)`, `inetd.conf(4M)`, `ps(1M)` and `kill`.

Bootp Server Setup on a PC

Bootp software for a PC is included (on a 3.5-inch floppy disk) with your probe. Bootp software implements an internet Bootstrap Protocol (Bootp) server as defined in RFC 951 and RFC 1048. It is run from the DOS prompt either as a standalone executable or as a terminate-and-stay-resident (TSR) program and communicates to a network interface card using the Microsoft NDIS (LAN Manager), or Novell ODI (NetWare), network stack. Bootp software does not support Microsoft Windows.

Refer to “Configuring the Bootptab File” on page 87 if you need to configure the bootptab configuration file.

Use the following procedure to setup the Bootp server software on a PC:

1. Insert the 3.5-inch floppy disk into your disk drive.
2. Change the prompt to indicate your floppy disk drive volume and enter setup. The following screen is displayed:

```
Bootp Setup
=====
Setup helps you install the Bootp server software for
use with either Microsoft LAN Manager or Novell ODI
version 3.1 software by:
- copying to your setup drive software for interfacing
  the Bootp program to your networking software.
- modifying your CONFIG.SYS, AUTOEXEC.BAT, and
  PROTOCOL.INI or NET.CFG files. (A copy of these files
  are saved in CONFIG.BTP, AUTOEXEC.BTP, PROTOCOL.BTP
  and NET.BTP, respectively.)
- copying the Bootp software to BOOTPD directory on your
  startup drive.
- providing a README file that contains more information.

(Press return to continue or press 'E' to exit.)
```

Bootp Server Configuration Bootp Server Setup on a PC

3. Press Return to continue. The following screen is then displayed:

```
Please specify startup drive to install Bootp on [C:\]:
```

4. Specify the drive where you want to install the Bootp software and press Return. The default is to install the Bootp software in C:\. The following screen is then displayed:

```
Install Bootp Software for use with:  
  0: Microsoft LAN Manager 1.0 or later  
  1: Novell NetWare v3.1 or later  
  2: Exit this setup program  
Enter choice [0 - 2]:
```

5. Specify the Network Operating System that you are using and then refer to either “Using Microsoft LAN Manager” below or “Using Novell NetWare” on page 84.

There will be different setup screens displayed depending on the Network Operating System that you are using (Microsoft LAN Manager or Novell NetWare).

Using Microsoft LAN Manager

If you have selected **Novell NetWare v3.1 or later**, skip to “Using Novell NetWare” on page 84.

If you have selected **Microsoft LAN Manager 1.0 or later** from the setup menu, use the following procedure to setup your Bootp installation.

1. Skip this step if you only have one LAN interface in your system (the following screen will not be displayed.) Specify the driver that will be used for the Bootp server. This is an example; your driver may be different.

```
Bootp Installation for Microsoft LAN Manager:
=====
Setup has found multiple drivers that it can bind the
bootp software to.
Choose one of the following:
    0:  AgilentLAN
    1:  AgilentLANB
    2:  Exit this setup program
Enter number [0 - 2]:
```

2. The final screen looks like the following:

```
The following file has been copied to the directory
C:\LANMAN.DOS\:
- DISPKT10.DOS

The CONFIG.SYS and the PROTOCOL.INI files have been
modified. Unmodified backups have been saved as
C:\CONFIG.BTP and C:\LANMAN.DOS\PROTOCOL.BTP.

The following files have been copied to the directory
C:\BOOTPD:
- BOOTPD.EXE
- BOOTPTAB
- README.TXT
BOOTPTAB is a sample configuration file which you must
modify before executing BOOTPD.EXE.

Bootp Setup is complete.
Please read the README.TXT file for additional
information. You will need to restart your computer
before running the Bootp software.
```

3. Modify the sample bootptab configuration file and restart your computer before running the Bootp software.

Using Novell NetWare

If you have selected **Microsoft LAN Manager 1.0 or later**, go back to “Using Microsoft LAN Manager” on page 82.

If you have selected **Novell NetWare v3.1 or later** from the setup menu, use the following procedure to setup your Bootp installation.

1. Press return to continue from the following screen.

```
Bootp Installation for Novell networks:
=====
In order to use this product using the NetWare protocols,
you need to be running client versions of NetWare that
include:
- LSL.COM          v1.20 or later

Your NET.CFG file must specify a FRAME type of
ETHERNET_II. For example, your NET.CFG should include
something like:
        LINK DRIVER AgilentWDSA8
                FRAME ETHERNET_II

Bootp also requires that you do not have Novell TCP/IP
software (LAN Workplace for DOS) installed.

(Press return to continue or 'E' to Exit.)
```

2. Specify the location of the NET.CFG file. The default is for the NET.CFG file to be located at C:\NOVELL\NET.CFG.

```
Setup could not find the NET.CFG file.
Please specify a full path and filename
(e.g. C:\NOVELL\NET.CFG):
```

3. The final screen looks like the following:

```
The following file has been copied to the directory C:\:  
- ODIPKT13.COM  
  
The AUTOEXEC.BAT and the NET.CFG files have been modified.  
A copy of the original files have been saved as  
C:\AUTOEXEC.BTP and C:\NETWARE\NET.BTP.  
  
The following files have been copied to the directory  
C:\BOOTPD:  
- BOOTPD.EXE  
- BOOTPTAB  
- README.TXT  
  
BOOTPTAB is a sample configuration file which you must  
modify before executing BOOTP.EXE  
  
Bootp Setup is complete.  
Please read the README.TXT file for additional  
information. You will need to restart your computer before  
running the Bootp software.
```

Starting the PC Bootp Server

You can start the PC Bootp server in one of the following ways:

- As a standalone executable program by entering the following:

```
bootpd -a IP address -s
```

- As a TSR (terminate-and-stay-resident) program by entering the following:

```
bootpd -a IP address
```

Bootp Server Configuration Bootp Server Setup on a PC

Where:

-a IP address is required and specifies the IP address of the PC where you are running bootpd.

-s specifies that you are running bootpd as a standalone executable (not as a TSR). You may want to use the **-s** option if you do not need the Bootp daemon to continually service bootp requests. This is preferable, since the Bootpd TSR may consume a large amount of memory (depending on the size of your bootptab file).

Upon startup, Bootpd reads the bootptab file and then listens for bootp request packets from the network. Bootpd re-reads the bootptab file when it receives a bootp request packet and detects that the file has been updated. If hosts are added, deleted, or modified, their entries in Bootpd's internal database are also updated when the bootptab file is re-read. All Bootp status messages are logged to the BOOTPD.LOG file.

You can now attach the power cord to the probe and to a power source (either 100-120/VAC or 220-240/VAC). The probe does not have a power switch but becomes operational when power is attached. When powered on and when its IP address is 0 . 0 . 0 . 0 (the default), the probe automatically broadcasts Bootp requests that trigger the Bootp server to provide its configuration parameters.

Configuring the Bootptab File

Configure the bootptab file by using the following procedure and any ASCII text editor to edit one of the files from Table 4-2.

Table 4-2: Bootp Server bootptab Files

Bootp Server:	Bootptab File Location
HP 9000 System	/etc/bootptab
Sun SPARC system	/usr/netm/config/bootptab
PC	C:\bootpd\bootptab

1. Enter your IP parameters into the bootptab file for each probe that you want to configure.

Use this format.

```
nodename : \
          tag=value:\
          tag=value:\
          ...
          tag=value
```

The **nodename** is the host name of the probe. The nodename can be up to 40 characters long using alpha-numeric, dashes, and dots. *Do not use spaces or underscores in the nodename.*

Each **tag** and its associated value is an IP parameter configured for a probe. Valid tags are listed in Table 4-3 on page 88. You *must* provide a set of these tags for each probe that you want to configure (some tags are optional).

Bootp Server Configuration Configuring the Bootptab File

Blank lines and lines beginning with # in the bootptab file are ignored. You must include a colon and a backslash to continue a line. The **ht** tag must precede the **ha** tag.

An example bootptab file is shown at the end of this procedure.

Table 4-3: Bootptab File Tags

Tag	Description
hn	send nodename (Boolean flag, no “=value” is needed)
ht	hardware type (ether); must precede ha tag
vm	vendor magic cookie selector (must comply with RFC 1048)
ha	hardware address (link-level or MAC address expressed in hexadecimal); the probe’s hardware address is printed on a label located on the Probe’s back panel.
ip	Internet Protocol (IP) address for the Probe
sm	subnet mask; this is required only if subnetting is being used
gw	IP address of the gateway used when sending packets off the local subnet; one default gateway may be configured

2. Save the bootptab file after you have entered parameters for all of your probes.
3. Verify the bootp process by performing one of the items in Table 4-4 on page 89.

Table 4-4: Bootp Process Verification

Server	Verification Process
HP-UX Bootp Server	Test the Bootp process by entering one of the following: For HP-UX 9.x: <i>/etc/bootpquery <hardware address></i> For HP-UX 10.x and 11.x: <i>/usr/sbin/bootpquery <hardware address></i> Where <i><hardware address></i> is the MAC address of the HP-UX workstation's LAN interface.
Solaris Bootp Server	If available, test the Bootp process by entering: <i>/etc/bootpquery <hardware address></i> where <i><hardware address></i> is the MAC address of the Solaris workstation's LAN interface.
PC Bootp Server	Check the C:\bootpd\bootpd.log file for the entry "Starting bootpd..."

NOTE

Only bootpquery with bootptab entries include the **ba** tag.

Bootp Server Configuration Configuring the Bootptab File

Example Bootptab File

The following is an example of the C:\bootpd\bootptab file provided with the PC Bootp software. At the end of this bootptab file, there are example IP configuration entries for a probe.

```
# Example bootptab: database for bootp server.
#
# Format:
# nodename: tag=value: ... : tag=value
#
# first field - nodename (hostname) of terminal followed by colon
# (should be full domain name)
#
# Blank lines and lines beginning with '#' are ignored.
# Make sure you include a colon and a backslash to continue a line.
# Don't put any spaces in the tag=value string.
# The ht tag MUST precede the ha tag.
#
# The options listed below are useful for Agilent LanProbes.
# They are specified as tag=value and delimited by colons.
# For a list of all possible options, see the
# C:\BOOTPD\README.TXT file.
#
# ba - broadcast bootp reply for testing with bootpquery
# hn - send nodename (Boolean flag, no "=value" needed)
# ht - hardware type (ether) (must precede the ha tag)
# ha - hardware address (link level address) (hex)
# vm - vendor magic cookie selector (should be rfc1048)
# ip - LanProbe IP address
# sm - network subnet mask
# gw - gateway IP address
#
# LanProbe example
#
# lanprobel:\
# ba:\
# hn:\
# ht=ether:\
# vm=rfc1048:\
# ha=080009123456:\
# ip=15.6.72.210:\
# sm=255.255.248.0:\
# gw=15.6.72.1
```

Probe Operation

Probe Operation

The Agilent J3919A and J3972A OC-3 ATMProbes are designed to operate unattended once it has been installed and configured and it successfully completes its self-tests. This chapter describes how to reset the probe and the effect that different restarts have on probe data and measurement configuration settings.

Restarting the Probe

The probe can be restarted by performing a *warm start* or a *cold start*. In either case, the probe executes self-tests and re-initializes. There are differences in the effects of each type of restart.

- A warm start resets the probe's measurement data only.
- A cold start resets all of the probe's measurement data, filters, alarms, and user-defined statistics studies (excluding communications configuration parameters) back to default values.

Warm Start

A warm start resets the probe's measurement data only. You can warm start the probe by doing one of the following:

- Cycling power (or a power outage).
- Selecting the menu item **Warm start and Exit** from the probe's Main Menu when you have a local terminal connected to the probe, as described in Step 3 on page 96.
- Using NetMetrix to execute a probe warm start. Refer to your NetMetrix documentation for details.

Table 5-1 on page 94 shows which data and parameters are reset during a warm start and during a cold start of a probe.

Probe Operation
Restarting the Probe

Table 5-1: Probe Data and Parameters Reset by a Cold or Warm Start

Category	Probe Memory Contents	Warm Start Status	Cold Start Status
Measurement Data	Current ATM signaling statistics Historical ATM signaling statistics Current AAL-5 protocol statistics Historical AAL-5 protocol statistics Current AAL-5 per-PVC statistics Historical AAL-5 per-PVC statistics Current AAL-5 SVC aggregate statistics Historical AAL-5 SVC aggregate statistics Logs	Reset Reset Reset Reset Reset Reset Reset Reset Reset	Reset Reset Reset Reset Reset Reset Reset Reset Reset
Measurement Configuration Parameters	Alarm table Filter table Channel table Buffer control table Event table Community access table Client tables Historical study configuration PCV configuration table	Saved Saved Saved Saved Saved Saved Saved Saved Saved	Reset Reset Reset Reset Reset Reset Reset Reset Reset
Probe Configuration Parameters	Trap destination table Serial connection table Serial configuration information for outgoing connections, such as: dial strings Time period for utilization calculations Other Serial configuration information, such as: SLIP address and subnet mask serial port speed modem initialization strings Flow Control Probe configuration information, such as: IP address default gateway subnet mask TFTP server address Download filename Time zone Security Settings Interface Status Crash data (used by Agilent support)	Saved Saved Saved Saved Saved Saved Saved Saved Saved Saved Saved Saved Saved Saved Saved	Reset Reset Reset Saved Saved Saved Saved Saved Saved Saved Saved Saved Saved

Cycling Power

A power outage or cycling power to the probe causes a warm start. The probe does not have a power switch; therefore, cycling the power consists of disconnecting and reconnecting the power cord.

Selecting the Warm Start Menu Item

Use the following procedure to warm start the probe using the probe's Main Menu:

1. Connect a local terminal (or a PC emulating a terminal) to the probe. Refer to Chapter 2 "Local Terminal Configuration" for information on connecting a local terminal.
2. Press the CONFIG button once (on the back of the probe) to place the probe into the configuration mode. Use a narrow, pointed object (like a pen) to press the recessed CONFIG button. The probe then displays its Main Menu on the terminal. Figure 5-1 shows the probe's Main Menu.

```
Main Menu - Revision
1. Modify/View configuration values ->
2. Modify/View security values ->
3. Modify/View interface values ->
4. Display interface summary
5. TFTP Download new firmware ->
6. XMODEM Download new firmware ->
7. Warm start and Exit
8. Cold start and Exit
```

Figure 5-1: The Probe's Main Menu

Probe Operation

Restarting the Probe

3. Press **7** to execute a warm start and exit the probe's Main Menu. The warm start occurs immediately. The Activity and Fault LEDs are turned on during a warm start. When the warm start completes, the Activity LED flashes to indicate traffic (if present), the Fault LED turns off, and the ~Line On (or Power) LED is on.

Cold Start

A cold start resets all of the probe's measurement data as well as all alarm, event, filter, and user-defined statistics configuration to their default values. Basic communications configuration parameters (IP address, default gateway IP address, and subnet mask) are not reset.

You can cold start the probe by doing one of the following:

- Pressing the CONFIG Button twice within one second.
- Selecting the menu item **Cold start and Exit** from the probe's Main Menu when you have a local terminal connected to the probe, as described on page 97.
- Using NetMetrix to execute a probe cold start. Refer to your NetMetrix documentation for details.

Table 5-1 on page 94 shows which data and parameters are reset during a cold start or warm start of the probe.

Pressing the CONFIG Button Twice

Pressing the CONFIG button twice within one second causes the probe to cold start.

Selecting the Cold Start Menu Item

Use the following procedure to cold start the probe using the probe's Main Menu:

1. Connect a local terminal (or a PC emulation a terminal) to the probe. Refer to "Probe Operation" on page 91 for information on connecting a local terminal.
2. Press the CONFIG button once (on the back of the probe) to place the probe into the configuration mode. Use a narrow, pointed object (like a pen) to press the recessed CONFIG button. The probe then displays its Main Menu on the terminal. Figure 5-1 on page 95 shows the probe's Main Menu.
3. Press **8** to execute a cold start and to exit the probe's Main Menu. The cold start occurs immediately. The Activity and Fault LEDs are turned on during a cold start. When the cold start completes, the Activity LED flashes to indicate traffic (if present), the Fault LED turns off, and the ~Line On (or Power) LED is on.

Probe Operation
Restarting the Probe

6

Download New Firmware

Download New Firmware

The instructions in this chapter describe how to download new firmware to the Agilent J3919A and J3972A OC-3 ATMProbes.

This download procedure is only necessary to upgrade your probe firmware to a new firmware release.

New firmware for the probe comes in the form of a binary file. This binary file can be received in the following ways:

- Sent to you by an Agilent Support Representative, on 3.5-inch floppy disk.
- Sent to you by an Agilent Support Representative via electronic means.
- Included with NetMetrix.
- Obtained via anonymous ftp from col.hp.com (15.255.240.16). The `/dist/netmetrix/lpfirmware` directory contains the latest firmware versions for Agilent probes. A README file in this directory provides more details about the files contained in the `lpfirmware` directory.

CAUTION

Downloading new probe firmware resets stored probe data and some probe configuration information (like filters, traps, and channels). It can affect the IP address, subnet mask, or default gateway IP address in some situations. Refer to the README file on the new firmware media for more information.

The available procedures for downloading new firmware to the probe are documented in this chapter. You should first select a procedure and then go to that section in this chapter and execute that procedure.

The following download procedures are covered in this chapter:

- “Downloading Firmware using an HP-UX Workstation and a Terminal” on page 102
- “Downloading Firmware using a Networked PC and a Terminal” on page 106
- “Xmodem Download of Firmware” on page 111

You can also download firmware using NetMetrix. Refer to your NetMetrix documentation for details.

Downloading Firmware using an HP-UX Workstation and a Terminal

The following instructions assume you are using HP-UX 9.0, or later. Before upgrading firmware, you must first establish an IP connection between your HP-UX workstation and the probe.

NOTE

The download workstation can be an HP-UX 9.x or later, but the NetMetrix/UX application is only supported on HP-UX 10.20 and 11.0, or later.

The following steps are required to download firmware to your probe:

1. “Install New Download Firmware on an HP-UX Workstation” below
2. “Download Firmware to the Probe” on page 103

Install New Download Firmware on an HP-UX Workstation

To download a new firmware file to the probe using an HP-UX workstation and a terminal, the new firmware file must be copied into the `~tftp` directory on your HP-UX workstation, and the file must be readable by `tftp`. Typically, the `~tftp` directory is `/home/tftpd`.

For more information on configuration and usage of `tftp`, refer to your HP-UX `tftp` documentation (typically found in an ARPA Services manual).

Download Firmware to the Probe

Once the new firmware is installed on the HP-UX workstation, you can download it to the probe.

Verify the following before you start the download procedure:

- The probe is connected to the network.
- The IP address, subnet mask, and default gateway of the probe are configured correctly.
- A terminal (or a PC running terminal emulator software) is attached to the probe's RS-232 port (using a null modem cable). Configure the communication link for 8 bits per character, 1 stop bit, no parity, Xon/Xoff handshaking, and a baud rate of 9600.
- You will also need the IP address of the HP-UX workstation.

Use the following procedure to download firmware to your probe from the HP-UX workstation using a terminal:

CAUTION

The probe executes a cold start if you press the CONFIG button twice within one second. If this happens, wait for the cold start to be completed (about 45 seconds) and then press the CONFIG button again to enter the configuration mode.

1. Press the CONFIG button on the back of the probe once. The probe's Main Menu, as shown in Figure 6-1 on page 104, is displayed on the console.

NOTE

The probe's CONFIG button is recessed. This requires the use of a narrow, pointed object (like a pen) to press the CONFIG button.

A warm start or cold start is completed when the Fault LED goes off. If traffic is present, the Activity LED flashes to show traffic.

Download New Firmware Downloading Firmware using an HP-UX Workstation and a Terminal

```
Main Menu - Revision
1. Modify/View configuration values ->
2. Modify/View security values ->
3. Modify/View interface values ->
4. Display interface summary
5. TFTP Download new firmware ->
6. XMODEM Download new firmware ->
7. Warm start and Exit
8. Cold start and Exit
```

Figure 6-1: Probe Main Menu (HP-UX Workstation)

NOTE

Item 5 in Figure 6-1 is not displayed if the **Allow TFTP firmware downloads** menu item is disabled. Refer to “Modify/View Security Values” on page 24 for more information on enabling this menu item.

If item 5 (TFTP Download new firmware) is not displayed, the number used to access items 6, 7, and 8 will be different.

2. Press **5** to display the Download Menu as shown in Figure 6-2.

```
TFTP Download Menu -- Firmware Rev.

1. Filename to download           firmware
2. tftp server IP address        X.X.X.X
3. Download firmware

0. Return to previous menu

Probe IP address:                 0.0.0.0
Subnet mask:                      0.0.0.0
Default gateway IP address:      0.0.0.0
```

Figure 6-2: Probe TFTP Download Menu (HP-UX Workstation)

3. Verify that the probe's IP address, subnet mask, and default gateway address, as displayed at the bottom of the Download Menu screen, are correct. If you need to change the configuration information, press **0** to return to the main menu and then press **1** to modify configuration options.
4. Press **1** from the Download Menu screen, and enter the filename to download.
5. Press **2** and enter the IP address of the HP-UX workstation which is acting as the tftp server.
6. Press **3** to download new probe firmware and wait for the probe to reboot automatically. It should take about 90 seconds to transfer the firmware to the probe and for the automatic reboot to take place. The probe relays will click at the end of the reboot process.

CAUTION

Do not reset, power-cycle, or reboot the probe immediately after the download process. Doing this may cause your probe to be damaged. After the firmware file has been downloaded to the probe, there will be a brief period (approximately 1 minute) while the probe is copying the firmware to the flash EPROM.

After the download process is complete, the probe reboots and starts running the new firmware.

If an error occurs during the download process, the probe returns to the Main Menu without storing the new firmware to memory.

Downloading Firmware using a Networked PC and a Terminal

You can download new firmware to your probe using a networked personal computer (PC) and a dumb terminal. Before upgrading firmware, you must first establish an IP connection between your networked PC and the probe.

The following steps are required to download firmware to the probe:

1. “Setup TFTP Server for Downloading” below
2. “Download Firmware to the Probe” below

Setup TFTP Server for Downloading

Refer to your TFTP application manuals for information on how to setup your server for downloading a file.

Download Firmware to the Probe

Once your TFTP server is setup for downloading a file, you can download the new firmware file to the probe.

Verify the following before you start the download procedure.

- The probe is connected to the network.
- The IP address, subnet mask, and default gateway of the probe are configured correctly.
- A terminal (or a PC running terminal emulator software) is attached to the probe's RS-232 port (using a null modem cable). Configure the communication link for 8 bits per character, 1 stop bit, no parity, Xon/Xoff handshaking, and a baud rate of 9600.
- You will also need the IP address of the networked PC.

Use the following procedure to download firmware to the probe from the networked PC using a terminal:

CAUTION

The probe executes a cold start if you press the CONFIG button twice within one second. If this happens, wait for the cold start to be completed (about 45 seconds) and then press the CONFIG button again to enter the configuration mode.

1. Press the CONFIG button on the back of the probe once. The probe's Main Menu, as shown in Figure 6-3 on page 108, is displayed on the console.

NOTE

The probe's CONFIG button is recessed. This requires the use of a narrow, pointed object (like a pen) to press the CONFIG button.

A warm start or cold start is completed when the Fault LED goes off. If traffic is present, the Activity LED flashes to show traffic.

Download New Firmware Downloading Firmware using a Networked PC and a Terminal

```
Main Menu - Revision
1. Modify/View configuration values ->
2. Modify/View security values ->
3. Modify/View interface values ->
4. Display interface summary
5. TFTP Download new firmware ->
6. XMODEM Download new firmware ->
7. Warm start and Exit
8. Cold start and Exit
```

Figure 6-3: Probe Main Menu (Networked PC)

NOTE

Item 5 in Figure 6-3 is not displayed if the **Allow TFTP firmware downloads** menu item is not enabled. Refer to “Modify/View Security Values” on page 24 for more information on enabling this menu item.

If item 5 (TFTP Download new firmware) is not displayed, the number used to access items 6, 7, and 8 will be different.

2. Press **5** to display the Download menu as shown in Figure 6-4 on page 109.

```
TFTP Download Menu -- Firmware Rev.  
  
1. Filename to download           firmware  
2. tftp server IP address        X.X.X.X  
3. Download firmware  
  
0. Return to previous menu  
  
Probe IP address:                 0.0.0.0  
Subnet mask:                     0.0.0.0  
Default gateway IP address:      0.0.0.0
```

Figure 6-4: Probe TFTP Download Menu (Networked PC)

3. Verify that the probe's IP address, subnet mask, and default gateway address, as displayed at the bottom of the Download Menu screen, are correct. If you need to change the configuration information, press **0** to return to the main menu and then press **1** to modify configuration options.
4. Press **1**, from the Download Menu screen, and enter the filename to download.
5. Press **2** and enter the IP address of the networked PC which is acting as the tftp server.
6. Press **3** to download new probe firmware and wait for the probe to reboot automatically. It should take about 90 seconds to transfer the firmware to the probe and for the automatic reboot to take place. The probe relays will click at the end of the reboot process.

CAUTION

Do not reset, power-cycle, or reboot the probe immediately after the download process. Doing this may cause your probe to be damaged. After the firmware file has been downloaded to the probe, there will be a brief period (approximately 1 minute) while the probe is copying the firmware to the flash EPROM.

Download New Firmware

Downloading Firmware using a Networked PC and a Terminal

After the download process is complete, the probe reboots and starts running the new firmware.

If an error occurs during the download process, the probe returns to the Main Menu without storing the new firmware to memory.

Xmodem Download of Firmware

You can download firmware from your PC to the probe via Xmodem by using the following procedure:

1. Access the HyperTerminal Windows 95 application or a similar communications program which supports Xmodem file transfer.
2. Connect your PC to the probe's RS-232 connector using a null modem cable. Refer to Appendix A "Cables and Connectors" for more information on cables.
3. Configure the terminal emulator for 8 bits/character, 1 stop bit, no parity, no flow control, and a baud rate of 9600.
4. Connect the power cord to the probe and to a power source (either 100-120/VAC or 220-240/VAC). The probe does not have a power switch, but is turned on by connecting power.
5. Start the configuration by quickly pressing the CONFIG button on the back of the probe one time only. After about 10 seconds, the probe displays its Main Menu on the terminal, as shown in Figure 6-5.

```
Main Menu - Revision
1. Modify/View configuration values ->
2. Modify/View security values ->
3. Modify/View interface values ->
4. Display interface summary
5. TFTP Download new firmware ->
6. XMODEM Download new firmware ->
7. Warm start and Exit
8. Cold start and Exit
```

Figure 6-5: Probe Main Menu (XMODEM)

Download New Firmware Xmodem Download of Firmware

6. Press **6** to display the XMODEM download menu shown in Figure 6-6.

```
XMODEM Download Menu -- Firmware Rev.  
  
1. Download at 38400 baud  
2. Download at 19200 baud  
3. Download at 9600 baud  
  
0. Return to previous menu
```

Figure 6-6: Probe XMODEM Download Menu

7. Press **1**, **2**, or **3** to select the download baud rate. You receive the following message on your PC:

Downloading to Flash: Receiving File. . .

This and all of the messages are transmitted at 9600 baud. If you selected a different baud rate, the messages will not be displayed correctly. However, the download will work correctly.

8. If you select a baud rate other than 9600, you will need to change the baud rate of your terminal emulator to match the download speed that you selected. If you are using the HyperTerminal application, select File -> Properties -> Configure. You must select the **Disconnect** icon followed by the **Connect** icon to get the baud rate changes to take effect.
9. Select **Transfer** and then **Send File** menu items from your PC's Windows application. You will be prompted to select the file to download.

The HyperTerminal application is configured for Zmodem by default. You need to make sure that you select Xmodem from the **Send File** dialog box.

CAUTION

If you selected a baud rate other than 9600, the message following the successful download will not be displayed correctly. In this case, wait approximately 2 minutes before power cycling the probe to ensure that the new firmware is written to FLASH memory correctly.

If your download was not successful, it is recommended that you repeat the process using 9600 baud so that all error message will be displayed correctly.

After the download process is complete, the probe reboots and starts running the new firmware.

If an error occurs during the download process, the probe returns to the Main Menu without storing the new firmware to memory.

If you are using an HP workstation and the probe takes more than 90 seconds to download new firmware and to restart (boot), verify that the workstation is setup correctly, and restart `inetd` by entering and running the following commands at the workstation:

```
ps -ef | grep inetd
/etc/inetd -k
/etc/inetd
```

NOTE

If you are experiencing tftp transfer timeouts or read errors, use the following procedure to verify that tftp is configured correctly on your workstation.

1. Verify tftpd functionality by copying the firmware file to another directory using the tftp command.

```
# cd /tmp
tftp 127.0.0.1
get firmware
quit
```

2. If the previous step fails, the problem is due to the tftpd configuration on the workstation.
-

Download New Firmware
Xmodem Download of Firmware

A

Cables and Connectors

Cables and Connectors

This appendix lists cables for use with the Agilent J3919A and J3972A OC-3 ATMProbes. The minimum connector pin-out are shown if you wish to use an unlisted cable. Note that each connector pin-out does not necessarily match the pin-out for the corresponding Agilent cable, but cables manufactured using at least the minimum pin-out will function correctly.

This appendix covers the following sections:

- “OC-3 ATM Interface Cables” on page 117
- “Token-Ring Cables” on page 118
- “Serial Port Interface Cables” on page 119
- “Cable Connector Pin-Outs” on page 120

OC-3 ATM Interface Cables

The OC-3 ATM circuit connection is made using two fiber SC connectors that support 155.52 Mbps ATM traffic. Optional transceivers support multimode and single-mode.

Fiber-optic cables come in many different configurations depending on the equipment you are connecting and the power levels of the network you are monitoring.

Table A-1 lists some OC-3 ATM cables and their part numbers. The OC-3 ATMProbe connectors are type SC. The 1 at the end of each AMP part number indicates that the length of the cable is one meter and a 2 at the end of the part number indicates a cable length of two meters, and so on.

Table A-1: OC-3 ATM Cable Types

Cable Type	Mode	AMP Part Number
FC ---> SC	Multi-mode	503780-1
FC ---> SC	Single mode	502792-1
ST ---> SC	Multi-mode	503773-1
ST ---> SC	Single mode	502793-1
SC ---> SC	Single mode	503166-1
SC ---> SC	Multi-mode	503165-1

The following is the industry standard for the color coding of fiber-optic cable:

- Yellow for Single Mode
- Orange for Multi-mode (AMP cables can be black or tan)

Token-Ring Cables

The following table shows the most commonly used Token-Ring cable. Use this table to verify that you are using compatible Token-Ring cabling throughout your network. The cable designation is generally stamped on the cable jacket.

NOTE

Make sure that all of your cables have the same Velocity of Propagation (Vp).

Table A-2: Token-Ring Cable Type, Vp, and Impedance

Cable Type	VP	Impedance
Type 1 (STP)	78	150
Type 3 (UTP) level 3	60	100
Type 3 (UTP) level 4	69	100
Type 3 (UTP) level 5	78	100

Serial Port Interface Cables

The following table shows the recommended cables for connecting the probe's serial port interface to a terminal or modem.

Table A-3: Serial Port Interface Cable

Cable Function	Cable Type	Connectors	Agilent Product Number
Connect a terminal or PC to the probe port for configuring the probe.	RS-232 “Crossover” or “null modem” cable	25-pin male to 25-pin male	13242G
		25-pin male to 25-pin female	13242H
		9-pin female to 25-pin male	24542G
Connect a modem to the probe port for SLIP communications.	“Straight-through” RS-232 modem cable	25-pin male to 25-pin male	13242M, 13242N, or 17355M
		25-pin male to 25-pin female	31391A

Cable Connector Pin-Outs

The Probe's RS-232 Port Pin-Out

The following table shows the pin-out for the Probe's 25-Pin RS-232 port (connector), which is used to connect to a terminal or modem using the appropriate cable.

Table A-4: Probe's RS-232 Port Pin-Out

PIN	US	CCITT	DIN
1	CHS GND	101	
2	Tx	103	D1
3	Rx	104	D2
4	RTS	105	S2
5	CTS	106	M2
6	DSR	107	M1
7	SIG GND	102	
8	DCD	109	M5
20	DTR	108	S1

NOTE

The probe asserts pins 20 and 4, pins 13, 14, 16, and 19 are reserved, and all other pins are not connected.

The Probe's RS-232 Modem Cable Connectors

The following table shows the minimum pin-out for connecting the Probe's RS-232 port to a modem using a 25-pin male to 25-pin male cable.

Table A-5: Probe to Modem Cable Min. Pin-Out (25-Pin to 25-Pin)

Modem End 25-pin Male		Probe End 25-pin Male
2	<--	2
3	-->	3
4	<--	4
5	-->	5
6	-->	6
7	---	7
8	-->	8
20	<--	20

25-pin Terminal/PC Cable Connectors

The following table shows the minimum pin-out for connecting the Probe's RS-232 port to a 25-pin terminal (or PC) connector (also known as an RS-232 "Crossover" cable).

Table A-6: Probe to 25-Pin Terminal Cable Min. Pin-Out

Terminal/PC		Probe
2	-->	3
3	<--	2
7	---	7

9-pin Terminal/PC Cable Connectors

The following table shows the minimum pin-out for connecting the probe's RS-232 port to a 9-pin terminal (or PC) connector (also known as an RS-232 "Crossover" cable).

Table A-7: Probe to 9-Pin Terminal Cable Min. Pin-Out

Terminal/PC		Probe
2	<--	2
3	-->	3
5	---	7

UTP Network Connector Pin-Out

The following table shows the RJ-45 (UTP) to RJ-45 connector pin-outs.

Table A-8: UTP (Type 3) Network Connector Pin-Outs

MsAU End RJ-45		Probe End RJ-45
3	<--	3
4	-->	4
5	-->	5
6	<--	6

STP Network Connector Pin-Out

The following table shows the DB-9 (STP) to data connector pin-out. Refer to Figure A-1 for the color coded connection points.

Table A-9: STP (Type 1) Network Connector Pin-Outs

MsAU End Data Connector		Probe End DB-9
Red	-->	1
Black	<--	5
Green	-->	6
Orange	<--	9

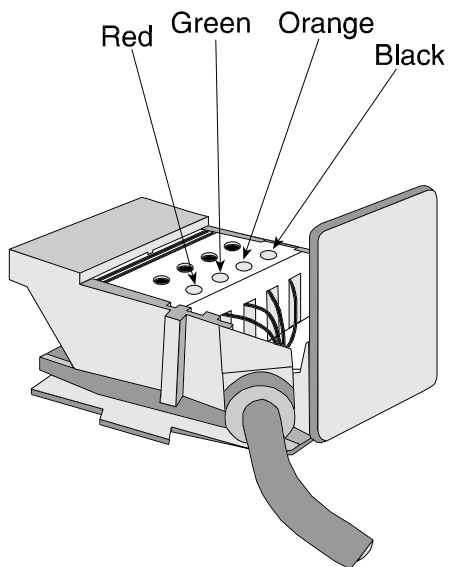

Figure A-1: Data Connector Color Coded Connection Points

B

Specifications

Specifications

This appendix lists the specifications for the Agilent J3919A and J3972A OC-3 ATMProbes.

Network Compatibility

Agilent J3919A and J3972A

Base

Hardware: 10Base-T/100Base-TX RJ-45 and AUI, Telemetry Interface.

Option 125 1 6-pin DIN connector is used for an Optical Bypass Switch (optional)

Option 210 1 OC-3 Single Mode Interface

Option 211 1 OC-3 Single Mode Interface and 1 Token-Ring Telemetry Interface

Option 212 1 OC-3 Multimode Interface

Option 213 1 OC-3 Multimode Interface and 1 Token-Ring Telemetry Interface

The probe can use either a Fast Ethernet network connection, an optional Token-Ring network connection, or the SLIP link to communicate with a management station.

Network Connection

The network connection is made using the standard AUI for 10 MB/s Ethernet. 10Base-T or 100Base-TX half-duplex connections are made using the standard RJ-45 connector.

The OC-3 ATM circuit connection is made using two fiber SC connectors that support 155.52 Mbps ATM traffic. Optional transceivers support multimode and single-mode.

The 6-pin DIN connector is used for an Optical Bypass Switch (optional).

You can use the optional Token-Ring telemetry interface to connect to the network Media Station Access Unit interface (MsAU) by using the DB-9 connector and STP (shielded twisted pair) cable, or by using the RJ-45 connector and UTP (unshielded twisted pair) cable. The Token-Ring telemetry interface configuration defaults to 16Mbps networks. Simultaneous network connections on both the DB-9 and RJ-45 connectors will result in a fault condition without damage to the Token-Ring interface.

Software Standards

Remote Network Monitoring Management Information Base (RFC 1757), SNMP MIB-II (RFC 1213 and 2233), SNMP (RFC 1157), and Agilent Probe Private MIBs.

Modem

Supports external Hayes-compatible modems from 300 to 38.4 K baud.

Dimensions

H x W x D: 8.9 x 42.5 x 23.5 cm (3.5 x 16.8 x 9.3 in)

Weight

4.9 kg (10.8 lbs) without options

Power Requirements

120 VAC, 50/60 Hz, 0.5 Amp; 240 VAC, 50/60 Hz, 0.25 Amps
Range: 100 VAC to 240 VAC +/- 10%

Specifications

Environment

	Operating	Non-Operating
Temperature	0°C to 55°C (32°F to 131°F)	-40°C to 70°C (-40°F to 158°F)
Relative Humidity (non-condensing)	15% to 95% at 40°C (104°F)	15% to 90% at 65°C (149°F)
Maximum Altitude	4.6 km (15,000 ft)	4.6 km (15,000 ft)

Storage Temperature

-40°C to 70°C (-40°F to 158°F)

Protocol Encapsulation

Figure B-1 shows various encapsulations over AAL-5.

Table B-1: Protocols Over AAL-5

aal5Bridged8023(16)	encapsulated IEEE 802.3
aal5Bridged8025(17)	encapsulated IEEE 802.5
aal5Bridged8026(18)	encapsulated IEEE 802.6
aal5Llc(19)	encapsulated LLC
aal5Mpoa(20)	multi-protocol over ATM (MPOA)
aal5FrMulti(21)	encapsulated frMulti
aal5FrEthertype(22)	encapsulated frEthertype
aal5FrEthernet(23)	encapsulated frBridgedEther
aal5FrTr(24)	encapsulated frBridgedTr
aal5FrIp(25)	encapsulated frIp
aal5FrSna(26)	encapsulated frSna
aal5FrAppleTalk(27)	encapsulated frAppleTalk
aal5FrVines(28)	encapsulated frVines
aal5FrDecNet(29)	encapsulated frDecNet
aal5Rfc1577(30)	classic IP and ARP (CLIP)

Probe Memory Allocation

The memory allocated to each parameter depends on how much memory is installed in the probe. The memory parameter values relate to the various items in the RMON or the Agilent private MIBs. These parameters were valid at the time of publication.

Table B-2 on page 131 shows the memory allocated to each parameter for the available probe memory configurations. The memory allocation shown for each memory amount column assumes that all of the available memory within the probe is allocated to the identified parameter.

NOTE

The parameter values shown in Table B-2 on page 131 are approximate and subject to change without notice.

Network Statistics and Trace buffers (packet capture buffers) are allocated dynamically from the same memory allocation. The values shown for Network Statistics assume that no Trace buffers are configured. If Trace buffers are configured, the number of Network Statistics are reduced.

Table B-2: Probe Memory Allocation

Parameter	32MB	64MB	128MB
Total number of history buckets for all studies (AAL-5)	125,000	255,000	516,000
Total number of history buckets for all studies (PVC)	119,000	244,000	494,000
Total number of history buckets for all studies (ATM)	68,000	139,000	282,000
Maximum number of alarms	24,000	50,000	102,000
Maximum number of events	155,000	317,000	641,000
Log table entries	1,024	1,024	1,024
Maximum number of filters	32*	32*	32*
Maximum number of channels	32*	32*	32*
Maximum number of packet capture buffers	32*	32*	32*
Trace buffer packet capacity	N/A	N/A	N/A
Trace buffer octet capacity	8-30MB	16-62MB	32-126MB
Maximum number of community names in Community Access Table	20*	20*	20*
Maximum number of IP address entries in Client Table	20*	20*	20*
Maximum number of trap destination entries (Agilent private MIB)	30*	30*	30*
Maximum SLIP connection entries	20*	20*	20*

* These numbers indicate that the probe will reserve memory for the minimum number shown in the table. If memory available, these numbers can be higher.

Specifications

Glossary

Glossary

This glossary contains definitions of terms, abbreviations, and acronyms that are used in this manual. The terms are not necessarily Agilent specific, but are for data communications in general.

10Base-T

10 Mbps, BASEband operation, unshielded Twisted-pair wiring used for Ethernet networks.

100Base-FX

100Base-FX uses multimode fiber-optic cable to carry traffic ten times faster than 10Base-T. It is used primarily to connect Hubs and switches together on Fast Ethernet networks.

100Base-TX

100 Mbps, BASEband operation, unshielded Twisted-pair wiring used for Fast Ethernet networks. 100Base-TX is ten times faster than 10Base-T.

ACTLU

Activate Logical Unit

ACTPU

Activate Physical Unit

Adaptation Layer

The adaptation layer maps services from their original format (such as variable length frames) into fixed-size cells. Different adaptation layers are needed for different services.

Address Resolution Protocol (ARP)

The Address Resolution Protocol is at the Network Layer in the OSI model. ARP provides a mechanism for finding the physical address (Internet Address) of a target host on the same physical network, given only the target's Internet address.

Admin Tool

A Sun Solaris system administration program with a graphical user interface.

Agent

A node (or software/hardware on a node) that supplies network management information.

Alarm Indication Signal (AIS)

An Alarm Indication Signal (AIS) is transmitted downstream when a major alarm condition such as LOS, LOF, or LOP is detected. Different AIS signals are sent depending on the level of the maintenance hierarchy.

ANSI (American National Standards Institute)

The United States coordinating organization for voluntary standards.

ASCII (American Standard Code for Information Interchange)

Seven bit code providing a total of 128 upper and lower case letters, numerals, punctuation marks, and control characters. Also referred to as CCITT Alphabet Number 5.

Asynchronous

A transmission process such that there is always an integer number of units between any two significant instances in the same signal but there is not always an integer number of units between significant instances in two independent signals.

Asynchronous Transfer Mode (ATM)

Asynchronous Transfer Mode (ATM) is a fast packet-switched technology based on fixed length cells. Data is divided into individual units and routed across an ATM network in a constant stream. Unused packets are filled with idle cells. Flexible bandwidth is possible with ATM - a service can use as many ATM cells as it needs. Voice, video, and data can be sent in a consistent manner over an ATM network, making ATM a valuable solution for many different services.

ATM Adaptation Layer (AAL)

The ATM Adaptation Layer isolates the higher layers from the specific characteristics of the ATM Layer and provides a way to map data from variable length frames into the fixed size of ATM cells. Different Adaptation layers are used (AAL-1, AAL-3/4, and AAL-5) to implement different types of service.

ATM Adaptation Layer 0 (AAL-0)

ATM Adaptation Layer 0 (AAL-0) supports raw cell transport. It has an SAR-PDU header or trailer.

ATM Adaptation Layer 1 (AAL-1)

ATM Adaptation Layer 1 (AAL-1) supports constant bit rate data such as voice, video, or other continuous user data. AAL-1 transfers data at a fixed speed. AAL-1 contains a 47-byte payload and a 1-byte header.

ATM Adaptation Layer 3/4 (AAL-3/4)

ATM Adaptation Layer 3/4 (AAL-3/4) supports variable bit rate data with connection oriented (type 3) or connectionless (type 4) data services. AAL-3/4 supports two modes of operation - Message Mode which is used for framed data, and Stream Mode which is used for low-speed continuous data. AAL-3/4 contains a 44-byte payload with a 2-byte header and a 2-byte trailer.

ATM Adaptation Layer 5 (AAL-5)

ATM Adaptation Layer 5 (AAL-5) supports variable bit rate data with connection oriented or connectionless data services. AAL-5 was designed as a simple protocol that assumes some of the functions such as error detection, timing and other overhead information is accomplished by the next level protocol. AAL-5 contains a 48-byte payload with control information in the normal ATM 5-byte header.

ATM Cell

An ATM Cell is a 53-byte protocol data unit made up of a 5-byte cell header and a 48-byte payload (information field).

ATM Layer

The layer in ATM that switches cells to their correct destinations within the network.

ATMProbe

See probe.

Auto-Negotiation

The process by which a probe determines the network speed and automatically sets its own configuration to match that speed.

Bandwidth

The range of frequencies within which transmission equipment (such as electric cable or fibre-optic waveguide) can transmit data.

Battery-backed RAM

The probe's memory that contains a copy of the probe configuration. If power is removed from the probe (either by unplugging the power cord or from a power outage), this memory is preserved by power provided by the probe's internal battery.

BIP-8

Bit Interleaved Parity 8 bits wide

Bit Interleaved Parity (BIP)

Bit Interleaved Parity (BIP) is a data integrity checking method. If even parity is used, an N-bit code is generated by the transmitting equipment over a specified portion of the signal in such a manner that the first bit of the code provides even parity over the first bit of all N-bit sequences in the covered portion of the signal, the second bit provides even parity over the second bit of all N-bit sequences and so on. Even parity is generated by setting the BIP-N bits so that there are an even number of 1s in each of the N-bit sequences including the BIP-N.

Bit Interleaved Parity 8 bits wide (BIP-8)

Bit Interleaved Parity 8 bits wide (BIP-8) provides for 8 separate even parity codes covering the corresponding bit of each octet.

Bit Rate

The speed at which bits are transmitted, usually expressed in bits per second (bps).

bps

Bits per second.

Bridge

A device providing an intelligent connection between two otherwise independent LANs. Bridges operate at layer 2 of the ISO OSI reference model. A bridge inspects every packet originating on either LAN and creates a table of nodes and

their locations. It isolates the LANs from each other, allowing both sides to pass traffic internally. If a transmission from one LAN is addressed to a node on the other LAN, the bridge transmits it onto the other LAN for the destination node.

Broadcast address

The station address FFFFFFFF-FFFFFF. Packets intended for all nodes on a LAN use this address as the destination address.

Broadcast packet

A packet sent to all nodes on a LAN.

Cell

A cell is a fixed-length packet of bytes.

Cell Delineation

Cell delineation is the process of identifying the beginning of cells. This can be based on the HEC byte of individual ATM cells.

Cell Layer

A cell layer is the layer where cell level management, routing, traffic control and multiplexing happen.

Cell Loss Priority (CLP)

CLP is a 1-bit field in the fourth byte in the header of an ATM cell. It is used to set priorities for cell discarding. A CLP value of 0 gives the cell a 'higher priority' telling the network this cell should not be discarded. A CLP value of 1 assigns the cell a 'lower' priority informing the network that this cell can be discarded depending on traffic conditions.

Cell Payload

A field of 44, 47, or 48 bytes in an ATM cell that carries service data.

Cell Segmentation

The process of mapping a service into an ATM cell stream.

Cell Stream

A continuous signal of ATM cells. Also known as stream.

CLIP (Classical IP)

IP over ATM conforming to RFC 1577.

CLP

Cell Loss Priority

Collision

The result of two or more nodes on a LAN transmitting at the same time, producing a garbled transmission.

Common Part Convergence Sublayer (CPCS)

The Common Part Convergence Sublayer (CPCS) is a part of the ATM Adaptation layer and provides message identification and error detection depending on the AAL type being used.

Concentrator

An FDDI or Token-Ring network device that connects as a Dual Attachment Station and has connections for additional devices (such as; stations, concentrators, or bridges).

Connectionless-mode Network Protocol (CLNP)

The Connectionless-mode Network Protocol is a Network layer protocol which has been defined by the International Organization for Standardization (ISO). A complete description of the protocol is contained in ISO 8473, Information processing systems - Data communications - Protocol for providing the connectionless-mode network service.

Console

The ASCII terminal, or PC emulating an ASCII terminal that is connected to the probe and used to configure, monitor, and troubleshoot the probe.

Convergence Layer

The Convergence Layer maps ATM cells into the transmission medium being used. It is responsible for identifying the beginning of cells (cell delineation), and for some simple management functions corresponding to the cell mapping. It also decouples the rate of cell transmissions from the physical media by inserting and removing idle cells.

Convergence Sublayer

The AAL is divided into two sublayers: the convergence sublayer and the segmentation and reassembly sublayer (SAR). These two sublayers convert whatever user data is to be transmitted into 48-byte cell payloads while maintaining the integrity and a certain amount of identity of the data involved. The result of each sublayer process is a Protocol Data Unit (PDU). The CS-PDU is variable in length and is determined by the particular AAL and the length of the higher layer data block passed to it. The SAR-PDU is always 48 bytes long to fit in the payload of an ATM cell.

Convergence Sublayer Indicator (CSI)

The Convergence Sublayer Indicator (CSI) is a 1-bit field in the AAL-1 cell format that handles clock recovery.

Convergence Sublayer Protocol Data Unit (CS-PDU)

A Convergence Sublayer Protocol Data Unit (CS-PDU) is a sublayer of the AAL. See also Convergence Sublayer.

CRC (Cyclic Redundancy Check)

A mathematical algorithm to derive the frame check sequence (FCS) in bit-oriented link protocols or the block check characters in character-oriented protocols.

Cross Cell PRBS

A PRBS pattern inserted in successive cell payloads, crossing payload boundaries.

CSMA/CD (Carrier Sense Multiple Access/Collision Detection)

The network access-control mechanism that is based on collisions and utilized by Ethernet networks. On contention-based networks, like Ethernet networks, each station must detect an idle network prior to transmitting. If more than one station transmits simultaneously, a collision occurs, all stations are notified, and the colliding stations try retransmitting after waiting a random amount of time.

Customer Premises Equipment (CPE)

Customer owned equipment used to terminate or process information from the public network. For example, a T1 multiplexer or a PBX.

Cycle/Stuff Counter (C1)

The Cycle/Stuff Counter (C1) is a 1-byte field in a PLCP frame that controls bit stuffing and length indication. The C1 byte occurs in the P0 (12th) cell of a PLCP frame. The value of C1 and its corresponding Trailer length is:

C1	Frame Cycle	Trailer Length (in nibbles)
11111111	1	13
00000000	2	14
01100110	3 (no stuff)	13
10011001	3 (stuff)	14

DACTLU

Deactivate Logical Unit

DACTPU

Deactivate Physical Unit

Data Link Layer

Level 2 of the seven level OSI reference model defined by ISO. This layer provides the link access control and reliability to networks.

Default Gateway Address

The address of the gateway which is closest to the probe.

DRAM

Dynamic Random Access Memory, which is the main memory of a probe.

ELAN (Emulated Local Area Network)

A logical network defined and controlled by a LAN Emulation (LANE) mechanism. See also LANE.

Encapsulation

The processing of wrapping data with a new protocol header for transmission over the network.

Ethernet

A LAN developed by Xerox Corp., Digital Equipment Corp., and Intel Corp. It uses the CSMA/CD method of access and transmits at 10 Mbit/s on a bus topology. The IEEE 802.3 standard evolved from Ethernet, but they are not

exactly the same. Network devices based on both standards can co-exist on the same medium, but they cannot exchange data directly without special, bilingual software that can decode packets of both types.

EtherTwist

The Agilent Company's version of 10Base-T.

Extended LAN

A network consisting of two or more LANs that are connected by bridges, routers, or other similar devices. Resources on the LANs can be accessed by users on any of the LANs. See also LAN.

Far End Alarm and Control (FEAC)

The Far End Alarm and Control signal is used to send an alarm or status information from the far end terminal to the near end terminal and to initiate loopbacks from the far end terminal to the near end terminal. When there are no status or alarm conditions, the FEAC has a value of all ones.

Far End Block Error (FEBE)

The Far End Block Error (FEBE) is a 4-bit field in the Path Status octet (G1) of a PLCP frame. The value in the FEBE field is the count of BIP-8 errors received in the previous frame (0000 through 1000). If FEBE checking is not implemented, the field is set to all 1s (1111).

FEAC Signal

See Far End Alarm and Control

FID2

FID2 is a 6-byte Transmission Header (TH) used for communication between subarea nodes and peripheral nodes (PDU2).

FID4

FID4 is a 26-byte Transmission Header (TH) used for communication between SNA subarea nodes, provided both support Explicit and Virtual Route protocols (FID0 and FID1 are used if either node does not support Explicit and Virtual Route protocols, where FID0 is for non-SNA traffic). FID4 supports all SNA decodes.

FIDF

FIDF is a 26-byte Transmission Header (TH) used for communication between adjacent SNA subarea nodes, provided both support Explicit and Virtual Route protocols, that use message sequencing.

Fill Cell

An empty or null ATM cell. This type of cell is a placeholder inserted into the signal stream to occupy bandwidth not allocated to a service. Fill cells are in either the Idle format (ITU-T) or Unassigned format (ATM Forum).

Flow Control

A method used to assure that the source does not overwhelm the destination by sending data faster than it can be processed and absorbed.

Flash EPROM

EPROM that can be erased and reprogrammed while installed in a circuit.

Frame

A frame is a unit of information transferred on a network which contains control and data information.

Full-duplex

A form of communication between two devices where packets flow in both directions simultaneously. See also Half-duplex.

Gateway

A dedicated computer that is used to route frames from one dissimilar network to another.

Generic Flow Control (GFC)

The Generic Flow Control is a 4-bit field in the first byte in the header of an ATM UNI cell. The GFC field is used for flow control in various ATM applications. Two modes of operation have been designed for the GFC field - Controlled and Uncontrolled. A GFC field set to all zeros denotes no flow control or uncontrolled transmission. A GFC field set to some non-zero value indicates a flow control condition or controlled transmission.

Half-duplex

A form of communication where information can only travel one direction at a time. See also Full-duplex.

Header

Information at the beginning of a cell, frame or packet normally used for alignment, routing, operations or similar purposes.

Header Error Control (HEC)

The Header Error Control (HEC) is an 8-bit field and the fifth byte in the header of an ATM cell. The HEC value is calculated from the first four bytes of the cell header. If an error occurs in an ATM Cell header, it will be detected in the HEC field. Cells with HEC errors that cannot be corrected are discarded by the receiving node. The HEC field can also be used to determine the boundaries of a packet for cell delineation.

Idle Cell

An empty or null ATM cell. This type of cell is a placeholder inserted into the signal stream to occupy bandwidth not allocated to a service. Fill cells are in either the Idle format (ITU-T) or Unassigned format (ATM Forum).

IEEE 802.3 standard

Part of the Institute of Electrical and Electronics Engineers 802 family of LAN standards. The 802.3 standard defines the physical layer (layer 1) and part of the data link layer (layer 2) of the ISO OSI reference model for a CSMA/CD LAN. The IEEE 802.3 standard evolved from Ethernet, but the two networks are not fully compatible with each other.

IEEE 802.5 Standard

Part of the Institute of Electrical and Electronics Engineers 802 family of LAN standards. The 802.5 standard defines the physical layer (layer 1) and part of the data link layer (layer 2) of the ISO OSI reference model for a Token-Ring LAN.

Information Field

A field of 44, 47, or 48 bytes in an ATM cell that carries service data.

Integration Period

Period used for statistics measurements.

Interarrival Time

A measurement based on the difference between the timestamps of successive cells.

IP Address (Internet Protocol Address)

A 32-bit address that is divided into network-identifier and host-identifier fields, which are used to identify a particular physical network or a particular device attached to that physical network (respectively).

ITU

International Telecommunications Union (formerly CCITT)

ITU-T

Telecommunications Standardization Sector of the International Telecommunications Union (formerly CCITT).

LAN (Local Area Network)

A general-purpose communications network that interconnects a variety of devices within a limited geographical area. Two common LANs, IEEE 802.3 and Ethernet, have compatible cabling requirements, and can co-exist on a common installation, but have different protocols. A LAN might connect computers on adjacent desks, within a building, or within several buildings of a campus. See also extended LAN.

LANE (LAN Emulation)

An emulation program on the local host that controls the execution of LAN Emulation Servers (LES), Broadcast/Unknown Servers (BUS), and LAN Emulation Configuration Servers (LECS).

LAN cable

A short distance network (up to a few thousand meters) used to connect many network devices using a communication standard. LAN cables come in many types. For example, thick (10 mm) coaxial cable, thin (5 mm) coaxial cable, fiber-optic cable, and twisted-pair cable.

LAT

Local Area Transport

Layer

A level in the hierarchy of telecommunications protocols. Protocols in the higher layers inter-operate with those in the lower layers.

LOCS

Loss Of Cell Synchronization

LOSS

Loss Of Scrambler Synchronization

M23 Parity

A DS3 framing format. See also C-Bit Parity.

MAC address

A 12-digit (48 bit) hexadecimal number that identifies a specific network station and allows messages to be directed to that station only. Because the IEEE has assigned identifiers for each hardware manufacturer, no two pieces of equipment have the same address. The address assigned according to the IEEE plan is referred to as a device's globally-administered station address. Some devices provide an option for the user to assign a different station address that will override the original. This type of address is referred to as a locally-administered station address. The station address is also commonly called a MAC address, Ethernet address, Token-Ring address, or physical address.

Manager

A node that collects network management information from agents.

Management station

A station that collects network management information from probes.

MAU (Medium Attachment Unit)

The assembly used to provide the physical connection and access to a LAN. It is the device on the LAN that detects collisions. (A transceiver is also called a MAU in the IEEE 802.3 standard.)

Mbps

Megabits per second.

Media Filter

A device used to convert Token-Ring adapter board output signal to function with a particular type of wiring. Media Filters are required for 16 Mbps networks and recommended for 4 Mbps networks using Type 3 (UTP) cable.

Metropolitan Area Network (MAN)

A network linking together LANs and other networks at many sites within a city area.

MIB (Management Information Base)

A data structure used for communication and control of the probe.

MPOA (Multiprotocol over ATM)

A standardization of protocols for running multiple network layer protocols over ATM.

MsAU (Media station Access Unit)

The attachment unit used to provide the physical connection and access to a Token-Ring network.

Multiplexer

A network element (NE) that performs multiplexing of several signals into one, or separates out the individual signals at the receiving end. An add-drop multiplexer can insert a tributary signal into a signal stream at a node, or extract a tributary signal from a stream at a node.

Multiplexing

Merging several different signals into one at the source, and separating them at the destination, for example, the sound and video of a television signal are multiplexed (modulated) onto a single carrier. In ATM telecommunications, multiplexing refers to the merging of several service signals consisting of ATM cells with different VPI and VCI values into a single cell stream modulated onto an optical carrier at a particular line rate (for example, 155.52 Mb/s).

NetMetrix

NetMetrix refers to the HP OpenView NetMetrix/UX software suite for HP-UX and Solaris.

Network Element (NE)

A hardware device for handling signals. See also Multiplexer.

Network Equipment

A collection of bridges, routers and switches which comprise the network infrastructure.

Network to Network Interface (NNI)

The Network to Network interface (or Network to Node Interface) is similar to the UNI but there is no 4-bit GFC field. The 4 extra bits are used as part of the VPI.

Nibble

A nibble is four bits.

NNI

Network to Network interface (or Network to Node Interface)

Node

A computer or other addressable device on a network, including PCs, terminals, probes, routers, and mainframes. Usually, a node has a station address.

Object

Any device that can be monitored or controlled by use of the SNMP protocol.

OC-3 (Optical Carrier level-3)

The optical derivation of STS-3. The SONET standard for OC-1 or STS-1 has a basic rate of 51.84 Mbps. See also STS.

Open Systems Interconnection (OSI)

Open Systems Interconnection is the internationally accepted standard for communications between different systems by different manufacturers. Most commonly known as the OSI Model - the 7-layer network architecture.

Operations, Administration and Maintenance (OAM)

OAM is a cell type dedicated to carrying administrative information for the network.

Optical Bypass

An optical bypass switch that works in conjunction with a probe's Bypass Power connector to maintain the network link even when a probe has an interruption in power.

OSI

Open Systems Interconnect. The 7 level communications structure promoted by ISO.

Packet

A bit stream consisting of predefined fields that contain data, addresses, and control information. In the IEEE 802.3 environment, this structure is often referred to as the **MAC frame**. Packet is used in the Ethernet environment and is used in this guide because it is the more commonly understood term. Different protocols have different packet and frame specifications.

PAIS

Path Alarm Indication Signal

Pass-Through

The method of connecting Agilent Probes so that additional hub ports or an additional hub is not required to monitor a connection. Some probe options are designed to support the pass-through mode and allow the probe to be connected between a server and a switch or between two switches without requiring an extra hub.

Path

A logical connection between the point at which a standard frame format for the signal at the given rate is assembled, and the point at which the standard frame format for the signal is disassembled.

Path AIS

Path Alarm Indication Signal

Path FEBE

Path Far End Block Error

Path Overhead

The Path Overhead (POH) is a 1 byte field in a DS3 PLCP frame that provides specific functions. The Z bytes (Z1-Z6) are reserved for future functions. The B1 byte is used for Bit Interleaved Parity (BIP-8) which checks for errors and performance conditions. The G1 byte is used for the PLCP Path Status which controls error conditions. The C1 byte provides for bit stuffing.

Path Overhead Identifier (POI)

The Path Overhead Identifier (POI) is the label for the function of each Path Overhead byte in a PLCP frame.

POI - POI Value (8 bit)	POH
P11- 00101100	Z6
P10- 00101001	Z5
P9 - 00100101	Z4
P8 - 01000000	Z3
P7 - 00011100	Z2
P6 - 00011001	Z1
P5 - 00010101	X
P4 - 00010000	B1
P3 - 00001101	G1
P2 - 00001000	X
P1 - 00000100	X
P0 - 00000001	C1

Payload

The payload of an ATM cell is the 48 bytes available for data. This field is also called the Cell Payload or Data Payload.

Payload Type (PT)

A field in the header of an ATM cell used to identify the type of information being transported that may require different handling by the network or terminating equipment.

Payload Type Indicator (PTI)

The Payload Type Indicator (PTI) is a 3-bit field that defines the contents of an ATM cell. The first bit determines if the cell is user data (0) or network signaling information (1). The second bit determines if there is no congestion (0) or congestion (1). The third bit identifies the SDU type (if it is a user cell) or the OAM type (if it is a control cell).

PTI - Explanation

000 - User data cell - no congestion - SDU Type 0
001 - User data cell - no congestion - SDU Type 1
010 - User data cell - congestion - SDU Type 0
011 - User data cell - congestion - SDU Type 1
100 - Segmented OAM F5 flow related cell
101 - End-to-End OAM F5 flow related cell
110 - reserved for future use
111 - reserved for future use

PDH

Plesiochronous Digital Hierarchy

PFEBE

Path Far End Block Error

Physical Layer (PL)

Level 1 of the seven level OSI reference model defined by ISO. The physical layer provides for the physical transportation of cells across the network. It consists of physical medium dependent (PMD) and transmission convergence (TC) sublayers. Important categories are PDH, SDH and the physical media used on local premises for LANs.

Physical Layer Convergence Protocol (PLCP)

The Physical Layer Convergence Protocol (PLCP) is used to map cells into the DS3 bit stream. There are 12 cells in a PLCP frame. Each cell is preceded by a 2-byte framing pattern (A1,A2) to enable the receiver to synchronize to the cells. After the framing pattern is an indicator consisting of one of 12 fixed bit patterns used to identify the cell location within the frame (POI). This is followed by a

byte of overhead information used for path management. The entire frame is padded with either 13 or 14 nibbles of trailer to bring the transmission up to the exact bit rate used.

DS3 was intended to accommodate clock slips so PLCP frames have to be padded with variable amounts to accommodate the extra “stuff” bits DS3 needs inserted for this clock slip feature. The C1 overhead byte indicates the length of the padding.

The payload and the overhead functions are checked by a Bit Interleaved Parity (BIP) function to measure errors and performance degradation. This performance information is transmitted in the overhead.

Physical Medium Dependent (PMD)

This sublayer of the physical layer is concerned with bit timing, line coding and electrical or optical transmission functions.

PL-OAM

Physical Layer Operations and Maintenance

PLCP BIP

Physical Layer Convergence Protocol Bit Interleaved Parity

PLCP FEBE

Physical Layer Convergence Protocol Far End Block Error

PRBS Errors

Errors in a selected PRBS pattern.

Private MIB

A proprietary MIB that has variables which are used for probe configuration and control options.

Probe

A device on the LAN that monitors all frames and produces network management information including current and historical traffic statistics and snapshots of selected frames. Probes are also known as monitors.

Protocol

A set of rules that governs data transfer among devices on a network. A protocol identifies the handshake type, frame size and format, timing, error recovery scheme, word size or other characteristics of each transfer, depending on the system.

Protocol Data Unit (PDU)

A segment of data generated by a specific layer of a protocol stack; usually contains information from the next higher layer encapsulated with header and trailer data generated by the later in question.

Pseudo-Random Bit Sequence (PRBS)

These are sequences of bits used for BERT testing. To simplify testing, certain lengths are standardized to particular sequences. For high-speed ATM, the standard supported lengths are 2^{15} , 2^{20} and 2^{23} . The length is the number of bits which will be transmitted before the sequence repeats.

Remote Alarm Indication (RAI)

The Remote Alarm Indication (RAI (Yellow)) is a 1-bit field in the Path Status octet (G1) of a PLCP frame. An RAI value in a PLCP frame is set to 1 after an error condition has been detected. The RAI is cleared (0) after the error condition has not occurred for a certain period of time.

Ring

See Token-Ring.

RMON MIB (Remote Network Monitoring MIB)

The collection of objects defined by the Internet Engineering Task Force in RFC 1757, RFC 1213, RFC 1157, RFC 2021, RFC 2074, Token-Ring RMON Extensions, and Agilent probe private MIB that are used for network monitoring.

RS-232 port

A serial interface connector on a computer or peripheral that adheres to the current RS-232 standard. The probe's RS-232 port adheres to this standard.

SAM (System Administration Manager)

A configuration tool provided by HP-UX for managing system resources and changing configuration parameters.

SAR-PDU

Segmentation and Reassembly Protocol Data Unit

Scrambling

An algorithm applied to a digital signal to eliminate long runs of all zeros or and ones which would make it difficult to recover the clock. The signal is unscrambled at the receiver to restore the original. Scrambling also eliminates the possibility of payload bit patterns accidentally mimicking an alignment or synchronization pattern at the start of a frame. Scrambling is only applied to the payload of ATM cells.

SDU

Service Data Unit

Segmentation

The process of partitioning a network message so that it fits within an integral number of ATM cells consisting of a header and a payload containing a part of the original network message.

Segmentation and Reassembly (SAR)

Segmentation and Reassembly (SAR) is the process used to map user data to and from ATM cells. At the transmitting end, information is segmented and sent out in separate cells (adding padding if necessary). At the receiving end, the AAL takes the information from the individual cells and reassembles it into its original form.

Sequence number (SN)

A number located in byte 6 of an AAL-1 ATM cell with a value in the range 1 through 7. This sequence number is used to identify the relative position of cells in a cell stream.

Server

A device on the network that is dedicated to specific functions.

Service

A single call or transmission, such as a telephone conversation, a computer-data transmission, or a television signal. A multimedia service is a single call carrying different types of information such as text, graphics, sound and video.

Service Specific Convergence Sublayer (SSCS)

The Service Specific Convergence Sublayer (SSCS) is a part of the ATM Adaptation layer and handles timing and message identification depending on the AAL type being used.

Services Layer

The layer immediately above the adaptation layer in the hierarchy of telecommunications protocols. It is occupied by a particular client information service which is to be mapped into the cell layer by the adaptation layer. Different adaptation layers are needed for different services.

Session Control

The function of the Data Flow Control (DFC) layer is to control the responses between FMDS pairs within sessions. The chief control block of the DFC is the Session Control Block (SCB).

Setup

Setting up the bandwidth and permissible cell delay times at the beginning of a call.

SIMM (Single Inline Memory Module)

DRAM that is mounted on a small printed circuit board that can be installed in an Agilent probe. Also see DRAM.

Simple Network Management Protocol (SNMP)

The Simple Network Management Protocol provides requests and responses between SNMP managers and SNMP agents. These transactions work with network management information from Management Information Bases (MIBs)

SLIP (Serial Line Internet Protocol)

A protocol used for serial communications.

Slot

A position in the ATM cell stream. Vacant slots are padded with idle (or fill) cells.

SMB

Server Message Block

Station

A computer or other addressable device on a network, including PCs, terminals, probes, routers, and mainframes. A station must have an IP address.

STM-1 (Synchronous Transfer Mode)

Information being transported or switched in regular and fixed patterns with respect to a frame pattern reference (or some other reference).

STP (Shielded Twisted Pair)

LAN cable that is both twisted, in pairs, and shielded. Pair twisting and shielding reduces crosstalk to a greater degree than UTP cable, especially at high transmission rates.

STS (Synchronous Transport Signal)

The electrical signal rate defined by SONET. See also OC-3.

Subnet Mask

Identifies the subnet field of a network address and is a 32-bit Internet address written in dotted-decimal notation. A subnet mask is used to divide a network into sub networks.

SVC (Switched Virtual Circuit)

A virtual circuit which is dynamically created and torn down when no longer active.

Switch

A network element (NE) that reroutes incoming cells into an outgoing cell stream based on each cell's VPI and VCI.

Synchronous

Signals that are sourced from the same timing reference and hence are identical in frequency.

TC

Transmission Convergence Sublayer

TE

Terminal Equipment.

Telemetry Port

The Telemetry port only receives packets destined for the port's IP address, can transmit packets onto the network, and is used for SNMP communications to the probe. It requires the IP Address, Subnet Mask, and Default Gateway IP Address fields. The following apply to Monitor/Transmit ports:

- HP OpenView can discover the interface
- The interface is IP addressable
- The interface responds to RMON groups 1 through 9 queries
- The interface will transmit all traps from the probe
- The interface will transmit all extended RMON packet samples from Monitor-only ports, Monitor/Transmit ports, and itself.

Terminal

An input/output device that permits interaction with a probe or computer. The device can be a display and keyboard, or a personal computer. An ASCII terminal, or PC emulating an ASCII terminal, can be connected to the probe for configuration, monitoring, and troubleshooting the probe.

ThickLAN

A local area network (LAN) operating over 10-mm diameter coaxial LAN cable. HP ThickLAN networks are compatible with the IEEE 802.3 Type 10Base5 standard.

Token

A short frame that circulates over the ring until captured by a station that wants to transmit a message. Tokens have a specific format as defined by the Token-Ring standard.

Token-Ring

A LAN developed by IBM Corporation. Token-Ring transmits at 4 Mbit or 16 Mbit per second.

Token-Ring Cable

The MsAU cable used to connect devices to the Token-Ring network. This cable connects a MsAU network port to either the RJ-45 or DB-9 probe port.

Topology

The organization of network devices in a network. FDDI uses a ring topology, Ethernet uses a bus Topology, and Token-Ring uses a ring topology.

Trailer

The last few octets or nibbles of a frame that fall outside the column and row view of the frame structure.

Transmission Convergence Sublayer (TC)

This sublayer of the physical layer maps ATM cells to and from the physical transmission medium with three key processes: cell delineation, cell synchronization, and cell rate decoupling.

Unassigned Cell

A cell used to fill unused bandwidth. Unassigned cells are similar to Idle or Fill cells. See also Idle Cell or Fill Cell.

User Network Interface (UNI)

The physical and electrical demarcation point between the user and the public network service provider.

UTP (Unshielded Twisted Pair)

A cable that is twisted in pairs. Pair twisting reduces crosstalk by canceling the magnetic fields generated in each of the twisted wires.

Virtual Channel (VC)

A communications path between two nodes identified by label rather than a fixed physical path.

Virtual Channel Identifier (VCI)

A Virtual Channel Identifier is a 16-bit field in the ATM header. The VPI and VCI are used together to determine the destination address of the ATM cell.

Virtual Path (VP)

A collection of virtual channels grouped together for routing purposes sharing a common VPI.

Virtual Path Identifier (VPI)

The Virtual Path Identifier is an 8-bit field in the ATM header. The VPI and VCI are used together to determine the destination address of the ATM cell.

Vp (nominal Velocity of Propagation)

The speed that a pulse travels along a given cable. Vp is expressed as a percentage of the speed of light in a vacuum.

WAN (Wide Area Network)

A data network engineered for relatively lower speed data transfers over unlimited distances. Often the links in a WAN are provided by a third party.

Wide Area Network (WAN)

A communications network that uses public and/or private telecommunications facilities to link computing devices that are spread over a wide geographic area.

Yellow Alarm

The Remote Alarm Indication (RAI (Yellow)) is a 1-bit field in the Path Status octet (G1) of a PLCP frame. An RAI value in a PLCP frame is set to 1 after an error condition has been detected. The RAI is cleared (0) after the error condition has not occurred for a certain period of time.

Index

Symbols

- ~ Line On LED 10, 70
 - Verifying the Installation 69

Numerics

- 100Base-TX Networks 53
- 10Base-2
 - MAU 52
- 10Base-T Networks 53
- 10Base-T/100Base-TX Networks
 - Connecting 52
- 10MB/s Ethernet Networks
 - Connecting 51
- 9000 System, Minimum Bootp Server Requirements 75

A

- AAL-5
 - Historical Protocol Statistics MIB 7
 - Protocol Statistics MIB 7
- Access Security 8
- Accessories, Optional 14
- Activity LED
 - Ethernet 10
 - OC-3 ATM Interface 13
 - Telemetry Port 70
 - Token-Ring 12
 - Verifying the Installation 69
- Agilent Private MIB 7
- Alarms
 - RMON-1 MIB 7
- Assistance Phone Number xi
- ATM Interface

- Cell Scrambling
 - Initial Configuration 18
- Cell Synchronization
 - Initial Configuration 18
- Network Type
 - Initial Configuration 18
- Autodiscovery Echo Interval 22
- Ethernet Interface
 - Initial Configuration 17

B

- Back Panel LEDs 12
 - Back Panel, Probe 54
 - Bootp
 - Daemon 77
 - Process Verification 89
 - Relay 75
 - Server
 - Configuration and Installation 4
 - Minimum Requirements 76
 - Probe Configuration 75
 - Setup on a PC 81
 - Setup on HP or Sun System 77
 - Starting on a PC System 85
 - Starting on HP or Sun System 79
 - Bootptab File
 - Configuring 87
 - Example 90
 - Tags 88
 - Button
 - CONFIG 13, 21, 103, 107
 - Button, CONFIG 96
 - Bypass Power Connector 49
- ## C
- Cable
 - Media Filter 56
 - Type 1 (STP) 55
 - Cables
 - Connector Pin-Outs 120

- Serial Port Interface 119
- Token-Ring 118
- Cables and Connectors 115, 116
- Cell Scrambling
 - ATM Interface
 - Initial Configuration 18
 - OC-3 ATM Interface 34
- Cell Synchronization
 - ATM Interface
 - Initial Configuration 18
 - OC-3 ATM Interface 34
- Cell Sync LED
 - OC-3 ATM Interface 13
- Cold Start 96
 - Information Reset 93, 96
 - Menu Item 97
- Collision LED
 - Ethernet 11
- CONFIG Button 13, 21, 96, 103, 107
- Configuration
 - and Installation Overview 4
 - Bootptab File 87
 - Management Station and Probe, for Modem 63
 - Modify/View Menu 22
 - Options, Probe 2
 - Probe, Bootp Server 75
 - PVC 7
 - SVC 7
 - Using a Local Terminal 17
- Connection
 - Data Switch 66
 - Local/Direct, Probe 61
 - Modem 61
 - OC3 ATM Network, In-Band 57
 - Out-of-Band, Serial 49
 - Probe to the Network
 - 10Base-T/100Base-TX Networks 52
 - 10MB/s Ethernet Networks 51
 - Token-Ring Networks 54
 - Probe to the Network (Out-of-Band) 50
 - Ring-in (RI) 56
 - Ring-out (RO) 56

- Serial, Out-of-Band 60
- Connector
 - Bypass Power 49
 - Cable Pin-Outs 120
 - DB-9 54
 - DB-9 to Data Connector Pin-Out 124
 - RJ-11 62, 63
 - RJ-45 54
 - RJ-45 to RJ-45 Connector Pin-Outs 123
 - RS-232 Modem Pin-Out, 25 to 25-Pin 121
 - RS-232 Pin-Out, 25-Pin 120
 - RS-232, Terminal Connection 19
 - STP Network Connector Pin-Outs 124
 - Terminal Cable Pin-Out, 25-Pin 122
 - Terminal Cable Pin-Out, 9-Pin 122
 - Token-Ring Data 56
 - UTP Network Connector Pin-Outs 123
- Connectors and Cables 115, 116
- Cycling Power, Probe Warm Start 95

D

- Data Connector 124
- Data Connector, Token-Ring 56
- Data Switch Connection 66
- Date 23
 - 2000 23
 - Probe
 - Initial Configuration 17
- DB-9 54
 - to Data Connector Cable Pin-Outs 124
- Default Gateway IP Address 77
 - Ethernet Interface 28
 - Initial Configuration 17
 - Token-Ring Interface 31
- Direct Connection, Probe 61
- Display Interface Summary
 - Menu 36

- Download
 - Firmware
 - Using a Networked PC and a Terminal 106
 - Using Networked HP-UX Workstation and Terminal 102
 - Using XMODEM 111
 - New Probe Firmware 100

E

- Encapsulation
 - Protocol 129
- Ethernet Interface
 - Autodiscovery Echo Interval
 - Initial Configuration 17
 - Default Gateway IP Address 28
 - Initial Configuration 17
 - Full/Half Duplex 29
 - IP Address 28
 - Initial Configuration 17
 - Link Speed 28
 - Physical Connector 28
 - Port Number 26
 - Port Type 27
 - Subnet Mask 28
 - Initial Configuration 17
 - Telemetry Port 27, 31

- Events
 - RMON-1 MIB 7
- Exit
 - and Save Changes Menu 23, 29, 32
- Expansion Modules, Token-Ring 55

F

- Fast Ethernet Interface
 - Telemetry Port 27
- Fault LED
 - Agilent J3972A Probe 13
 - Ethernet 11
 - Telemetry Port 70
 - Verifying the Installation 69

- Fiber-Optic
 - MAU 52
- Filter, Media 56
- Filters
 - RMON-1 MIB 7
- Firmware Download
 - Allow (Enable) 24
 - TFTP, Enable 8
- Full/Half Duplex
 - Ethernet Interface 29

H

- Hardware Kit, Probe 14
- Hayes-Compatible Modems 127
- Help
 - Assistance Phone Number xi
- HP 9000 System, Minimum Bootp Server Requirements 75
- HP OpenView NetMatrix/UX (for HP-UX or Solaris) 2
- HP-UX Workstation, Using to Download new Firmware 102

I

- Impedance, Token-Ring Cable 118
- In-Band
 - and Out-of-Band Probe Connection 49
 - OC3 ATM Network Connection 57
 - Troubleshooting the OC-3 ATM Installation 71
- Included Parts, Probe 14
- Installation 44
 - and Bootp Server Configuration 4
 - and Configuration 4
 - Probe 2, 42, 44
 - Rack or Cabinet 45
 - Table 45
 - Probe, Wall 47
 - Selecting a Location 43

- Verifying Probe 69
- Verifying the
 - ~ Line On 69
 - Activity LED 69
 - Fault LED 69
 - Power On 69
- Interface Cables, Serial Port 119
- Interface Summary
 - Display, Menu 36
- Interface Values
 - Modify/View Menu 25, 29
 - OC-3 ATM Interface 33, 34, 35
- Introduction 2
- IP Address 77
 - Ethernet Interface 28
 - Initial Configuration 17
 - Token-Ring Interface 31

L

- LAN Manager
 - Using 82
- LanProbe
 - Warm Start Menu Item 95
- LED
 - ~ Line On 10, 70
 - ~ Line On, Verifying the Installation 69
 - Activity 70
 - Activity, Ethernet 10
 - Activity, OC-3 ATM Interface 13
 - Activity, Telemetry Port 70
 - Activity, Token-Ring 12
 - Activity, Verifying the Installation 69
 - Back Panel 12
 - Cell Sync, OC-3 ATM Interface 13
 - Collision, Ethernet 11
 - Fault, Agilent J3972A Probe 13
 - Fault, Ethernet 11
 - Fault, Telemetry Port 70
 - Fault, Verifying the Installation 69
 - Link, Ethernet 10
 - Power On 10, 70

- Power On, Verifying the Installation 69
- Status 10
- Status, Verifying the Installation 69
- Line On LED 70
- Link LED
 - Ethernet 10
- Link Speed
 - Ethernet Interface 28
- Local Ringhub 55
- Local Terminal
 - Configuration 13
 - and Installation Overview 4
- Local Terminal Configuration 16
- Log
 - RMON-1 MIB 7

M

- MAC Address 77
- Main Menu
 - Probe 19
- Management Station 8
 - Modem Installation 62
- MAU
 - 10Base-2 52
 - Fiber-Optic 52
- Media Filter 56
- Media Station Access Unit (MsAU) 55
- Memory Allocation, Probe 130
- MIB
 - AAL-5 Historical Protocol Statistics 7
 - AAL-5 Protocol Statistics 7
 - Agilent Private 7
 - Per PVC AAL-5 Historical Protocol Statistics 7
 - Per PVC AAL-5 Protocol Statistics 7
 - PVC Configuration 7
 - Signaling Layer Historical Statistics 7
 - Signaling Layer Statistics 7
 - Supported 7
 - SVC Configuration 7
- MIB-II
 - Supported 7

- Microsoft LAN Manager
 - Using 82
- Modem
 - Carrier Detect 65
 - Connect Responses 39
 - Connection 61
 - Control String
 - Initial Configuration 17
 - Data Compression 65
 - Error Correction 65
 - Hang-Up String 39
 - Hardware Flow Control 64
 - Initialization String 39, 65
 - Management Station Installation 62
 - No-Connect Responses 40
 - Probe Installation 63
 - RS-232 Connector Pin-Out, 25 to 25-Pin 121
 - Serial Port
 - IP Address 64
 - Speed 64
 - Subnet Mask 64
- Modify/View Configuration Values Menu 22
- Modify/View Interface Values Menu 25, 29
 - OC-3 ATM Interface 33, 34, 35
- Modify/View Security Values Menu 24
- MsAU (Media Station Access Unit) 55

N

- NetMetrix/UX (for UNIX)
 - HP OpenView 2
- Network Type
 - ATM Interface
 - Initial Configuration 18
 - OC-3 ATM Interface 35
- Novell NetWare
 - Using 84

O

- OC-3 ATM
 - Troubleshooting the Installation 71
- OC-3 ATM Interface
 - Cell Scrambling 34
 - Cell Synchronization 34
 - Network Type 35
 - Port Number 33, 34
 - Port Type 33, 35
- OC3 ATM Network
 - Connection 57
- OC-3 ATM Networks 57
 - on 69
- OpenView NetMetrix/UX 2
- Operation, Probe 92
- Optical Bypass
 - Option 125 (Accessory) 14
- Option 125
 - Optical Bypass (Accessory) 14
- Optional Accessories 14
- Out-of-Band
 - Probe to the Network Connection 50
 - Serial Connection 49, 60
 - Trouble-shooting the Installation 70
- Overview
 - Installation and Configuration 4
 - Probe 5
 - System 5

P

- Packet Capture
 - Enable 8
 - RMON-1 MIB 7
- Packet Capture, Allow (Enable) 24
- Parts Included, Probe 14
- PC Station, Using to Download new Firmware 106
- PC System, Minimum Bootp Server Requirements 75
- PC, Emulating a Terminal 13

- Per PVC AAL-5
 - Historical Protocol Statistics
 - MIB 7
 - Protocol Statistics
 - MIB 7
 - Physical Connector
 - Ethernet Interface 28
 - Port Number
 - Ethernet Interface 26
 - OC-3 ATM Interface 33, 34
 - Token-Ring Interface 30
 - Port Type
 - Ethernet Interface 27
 - OC-3 ATM Interface 33, 35
 - Token-Ring Interface 31
 - POST
 - Power-On Self-Tests 69
 - Power
 - Cord 14
 - Switch 68
 - Power On LED 10, 70
 - Verifying the Installation 69
 - Private MIB, Agilent 7
 - Probe 44
 - Back Panel 54
 - Cold Start 96
 - Menu Item 97
 - CONFIG Button 96
 - Configuration, Bootp Server 75
 - Connecting In-Band and Out-of-Band 49
 - Cycling Power, Warm Start 95
 - Date
 - Initial Configuration 17
 - Download New Firmware 100
 - Hardware Kit 14
 - Included Parts 14
 - Installation 42
 - Introduction 2
 - Main Menu 19
 - Memory Allocation 130
 - Modem Installation 63
 - Operation 92
 - Optional Accessories 14
 - Overview 5
 - Power Cord 14
 - Rack or Cabinet Installation 45
 - Rear Panel 20, 54
 - Restarting 93
 - Self-Tests 69
 - Specifications 126
 - Starting 68
 - Table Installation 45
 - Time
 - Initial Configuration 17
 - Time Zone
 - Initial Configuration 17
 - Wall Installation 47
 - Protocol
 - Encapsulation 129
 - Protocol Statistics, AAL-5 7
 - Protocol Statistics, AAL-5 Historical 7
 - Protocol Statistics, Per PVC AAL-5 7
 - Protocol Statistics, Per PVC AAL-5 Historical 7
 - PVC Configuration
 - MIB 7
-
- ## R
- Rack or Cabinet Installation, Probe 45
 - Rear Panel, Probe 54
 - Restarting Probe 93
 - Ring Number
 - Token-Ring Interface 32
 - Initial Configuration 17
 - Ring Speed
 - Token-Ring Interface
 - Initial Configuration 17
 - Ring-in (RI) 56
 - Ring-out (RO) 56
 - RJ-11 Connector 62, 63
 - RJ-45 54
 - to RJ-45 Connector Pin-Outs 123
 - RMON MIB 7
 - RMON-1 MIB

- Alarms 7
- Events 7
- Filters 7
- Log 7
- Packet Capture 7
- Trap 7
- RS-232 Connector
 - (Port) Pin-Out, 25-Pin 120
 - Terminal Connection 19

S

- SAM 78
- Save Changes and Exit Menu 23, 29, 32
- Security
 - Access 8
 - Firmware Download 8
 - Configure 24
 - Modify/View Security Values Menu 24
 - Packet Capture 8
 - Configure 24
- Selecting a Location
 - for Probe 43
- Self-Tests, Probe 69
- Serial Communications
 - SLIP Link 3, 64
- Serial Connection 60
- Serial Port
 - Hardware Flow Control 39
 - Interface Cables 119
 - IP Address 38
 - Initial Configuration 17
 - Mode 39
 - Initial Configuration 17
 - Modem Control String 17
 - Modify/View Settings 37
 - Speed 39
 - Initial Configuration 17
 - Subnet Mask 38
 - Initial Configuration 17

- Server
 - Bootp
 - Minimum Requirements 76
 - Starting the HP or Sun 79
 - Starting the PC 85
- Setup
 - Bootp Server
 - on a PC 81
 - on HP or Sun System 77
- Signaling Layer Historical Statistics
 - MIB 7
- Signaling Layer Statistics
 - MIB 7
- SLIP
 - Link Communications 3, 64
- SNMP
 - Supported 7
- Specifications, Probe 126
- Start
 - Cold 96
 - Warm 93
- Starting
 - Bootp Server, on a PC System 85
 - Bootp Server, on HP or Sun System 79
 - Probe 68
- Station
 - Management 8
- Status LEDs 10
 - Verifying the Installation 69
- Subnet Mask 77
 - Ethernet Interface 28
 - Initial Configuration 17
 - Serial Port 38
 - Token-Ring Interface 31
- Summary
 - Display Interface Summary Menu 36
- SUN SPARC System, Minimum Bootp Server
 - Requirements 75
- Supported MIBs 7
- SVC Configuration
 - MIB 7

System
 HP 9000, Minimum Bootp Server Requirements 75
 PC, Minimum Bootp Server Requirements 75
 Sun SPARC, Minimum Bootp Server Requirements 75
System Overview 5

T

Table Installation, Probe 45
Telemetry Port
 Activity LED 70
 Fast Ethernet Interface 27
 Fault LED 70
 Token-Ring Interface 31
Terminal
 Local, Configuration 13
 PC, Emulating a 13
 Probe Configuration (Local) 17
 Using a Local for Configuration 19
Terminal Cable Connector Pin-Out
 25-Pin 122
 9-Pin 122
Time 23
 Probe
 Initial Configuration 17
Time Zone 23
 Probe
 Initial Configuration 17
Token-Ring
 Cable
 Impedance 118
 Velocity of Propagation 118
 Cables 118
 Data Connector 56
Token-Ring Interface
 Default Gateway IP Address 31
 IP Address 31
 Port Number 30
 Port Type 31
 Ring Number 32

 Initial Configuration 17
 Ring Speed
 Initial Configuration 17
 Subnet Mask 31
 Token-Ring Speed 31
Token-Ring Networks
 Connecting 54
Token-Ring Speed
 Token-Ring Interface 31
Trap
 RMON-1 MIB 7
Trouble-shooting
 Out-of-Band Installation 70
Troubleshooting
 OC-3 ATM Installation 71
Type 1 (STP) cable 55
Type 3 (UTP) cable 55

V

Velocity of Propagation, Token-Ring cable 118
Verifying the Probe's Installation 69

W

Wall Installation, Probe 47
Warm Start 93
 Cycling Power 95
 Information Reset 93, 96
 Menu Item 95

X

XMODEM Download of Firmware 111

Agilent Technologies, Inc. Offices

Asia-Pacific

Agilent Technologies, Inc.
24/F, Cityplaza One, 1111 King's Road,
Taikoo Shing, Hong Kong, SAR
Tel: (852) 3197-7777
Fax: (852) 2506-9284

Australia/New Zealand

Agilent Technologies Australia Pty. Ltd.
347 Burwood Highway
Forest Hill, Victoria 3131
Tel: 1 800 629 485 (Australia)
Fax: (61 3) 9272 0749
Tel: 0 800 738 378 (New Zealand)
Fax: (64 4) 802 6881

Canada

Agilent Technologies Canada Inc.
5150 Spectrum Way
Mississauga, Ontario L4W 5G1
Tel: 1 877 894 4414

Europe

Agilent Technologies, Inc.
Test and Measurement
European Marketing Organisation
P.O. Box 999
1180 AZ Amstelveen
The Netherlands
(31 20) 547 9999

Japan

Agilent Technologies Japan Ltd.
Measurement Assistance Center
9-1, Takakura-Cho, Hachioji-Shi,
Tokyo 192-8510, Japan
Tel: (81) 426 56 7832
Fax: (81) 426 56 7840

Latin America

Agilent Technologies, Inc.
Latin American Region Headquarters
5200 Blue Lagoon Drive, Suite #950
Miami, Florida, USA 33126
Tel: (305) 267-4245
Fax: (305) 267-4286

United States

Agilent Technologies, Inc.
Test and Measurement Call Center
P.O. Box 4026
Englewood, CO 80155-4026
1 800 452 4844

Free Manuals Download Website

<http://myh66.com>

<http://usermanuals.us>

<http://www.somanuals.com>

<http://www.4manuals.cc>

<http://www.manual-lib.com>

<http://www.404manual.com>

<http://www.luxmanual.com>

<http://aubethermostatmanual.com>

Golf course search by state

<http://golfingnear.com>

Email search by domain

<http://emailbydomain.com>

Auto manuals search

<http://auto.somanuals.com>

TV manuals search

<http://tv.somanuals.com>