

Errata

Title & Document Type: 3311A Function Generator Operating and Service Manual

Manual Part Number: 03311-90001

Revision Date: April 1974

HP References in this Manual

This manual may contain references to HP or Hewlett-Packard. Please note that Hewlett-Packard's former test and measurement, semiconductor products and chemical analysis businesses are now part of Agilent Technologies. We have made no changes to this manual copy. The HP XXXX referred to in this document is now the Agilent XXXX. For example, model number HP8648A is now model number Agilent 8648A.

About this Manual

We've added this manual to the Agilent website in an effort to help you support your product. This manual provides the best information we could find. It may be incomplete or contain dated information, and the scan quality may not be ideal. If we find a better copy in the future, we will add it to the Agilent website.

Support for Your Product

Agilent no longer sells or supports this product. You will find any other available product information on the Agilent Test & Measurement website:

www.tm.agilent.com

Search for the model number of this product, and the resulting product page will guide you to any available information. Our service centers may be able to perform calibration if no repair parts are needed, but no other support from Agilent is available.



OPERATING AND SERVICE MANUAL

-hp-3311A

FUNCTION GENERATOR

3311A

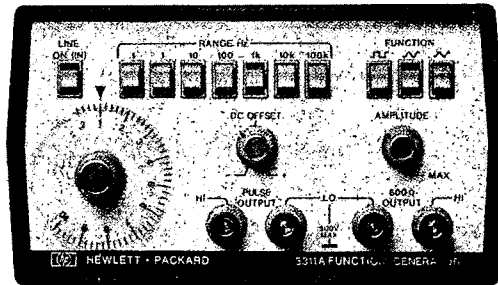

HEWLETT  PACKARD

-hp-3311A



OPERATING AND SERVICE MANUAL

Manual Part No. 03311-90001

Microfiche Part No. 03311-90051

MODEL 3311A FUNCTION GENERATOR

Serial Number Prefixed: 1244A

IMPORTANT NOTICE

This instruction manual requires no change sheet. Any change information has already been integrated into the manual by page revisions. Revised pages have a letter which can be found on the lower corner of the page. Reference is also made to Section VIII where backdating information for earlier instruments can be found.

Copyright Hewlett-Packard Company 1972
P.O. Box 301, Loveland, Colorado, 80537 U.S.A.

Printed: APRIL 1974

TABLE OF CONTENTS

Section	Page	Section	Page
I. GENERAL INFORMATION	1-1	V. MAINTENANCE	5-1
1-1. Introduction	1-1	5-1. Introduction	5-1
1-3. Specifications	1-1	5-3. Recommended Test Equipment	5-1
1-5. Description	1-1	5-5. Test Record	5-1
1-8. Instrument and Manual Identification	1-1	5-7. Performance Tests	5-2
		5-9. Sine Wave Amplitude Flatness Test	5-2
		5-10. Square Wave Time Axis	
Section	Page	Symmetry Error Test	5-2
II. INSTALLATION	2-1	5-11. Pulse Duty Cycle Test	5-3
2-1. Introduction	2-1	5-12. Dial Accuracy Test	5-3
2-3. Initial Inspection	2-1	5-13. Sine Wave Distortion Test	5-4
2-5. Power Requirements	2-1	5-14. Square Wave and Pulse Response Test	5-4
2-7. Grounding Requirements	2-1	5-15. Output Impedance Test	5-6
2-9. Instrument Mounting	2-1	5-16. Maximum Signal Output and	
2-10. Bench Use	2-1	Amplitude Range Test	5-6
2-12. Rack Mounting	2-1	5-17. Pulse Output Amplitude Test	5-6
2-14. Repackaging for Shipment	2-1	5-18. DC Offset Test	5-6
2-18. Power Cords and Receptacles	2-2	5-19. VCO Test	5-7
		5-20. Triangle Linearity Test	5-7
		Adjustment Procedures	
Section	Page	5-21. Adjustment Procedures	5-9
III. OPERATING INSTRUCTIONS	3-1	5-23. Triangle Amplifier Offset Adjustment	5-10
3-1. Introduction	3-1	5-24. Square Wave Time Axis	
3-3. Panel Features	3-1	Symmetry Adjustment	5-10
3-5. General Operating Information	3-1	5-25. Frequency Dial Calibration	5-11
3-7. Selecting the Desired Output	3-1	5-26. Sine Wave Distortion Adjustment	5-11
3-9. Using the VCO Input	3-1		
3-11. Operating Considerations	3-1	Section	Page
3-12. Using Internal DC OFFSET	3-1	VI. REPLACEABLE PARTS	6-1
3-14. Floating Using External Sources	3-1	6-1. Introduction	6-1
3-17. Using the Pulse Output	3-2	6-4. Ordering Information	6-1
		6-6. Non-Listed Parts	6-1
Section	Page	6-8. Parts Changes	6-1
IV. THEORY OF OPERATION	4-1	6-10. Proprietary Parts	6-1
4-1. General Description	4-1		
4-6. Detailed Theory of Operation	4-1	Section	Page
4-7. Triangle Generator (See Figure 7-1)	4-1	VII. CIRCUIT DIAGRAMS	7-1
4-9. VCO Input	4-1	7-1. Introduction	7-1
4-11. Triangle Amplifier	4-2	7-3. Troubleshooting	7-1
4-13. Sine Shaper (See Figure 4-2)	4-2	7-6. Troubleshooting Trees	7-1
4-15. Square Wave Generator		7-8. Localizing the Malfunction	
(See Figure 4-3)	4-2	Using Front Panel Checks	7-1
4-17. Pulse Generator (See Figure 7-2)	4-2		
4-19. Output Amplifier (See Figure 7-2)	4-2		

LIST OF ILLUSTRATIONS

Figure	Page	Figure	Page
2-1. Rack Mount Kits	2-1	5-5. Transition Time Tests	5-5
2-2. Power Receptacles	2-2	5-6. Triangle Linearity Check	5-8
3-1. 3311A Front and Rear Panel Features	3-2	5-7. Adjustment Locator	5-10
4-1. Basic Block Diagram	4-1	5-8. Symmetry Adjustment	5-11
4-2. Sine Shaper	4-2	7-1. Sine, Square or Triangle Function Defective	7-3/7-4
4-3. Square Wave Generator	4-3	7-2. Power Supplies Defective	7-5/7-6
5-1. Amplitude Flatness	5-2	7-3. Pulse Defective	7-7/7-8
5-2. Dial Accuracy/Time Axis Symmetry Check	5-3	7-4. Functional Circuit Diagram	7-9
5-3. Distortion Test	5-4	7-5. Function Generator Circuit Diagram	
5-4. 1 MHz Distortion Test	5-5	(p/o A1)	7-11/7-12
		7-6. Power Supply Circuit Diagram (p/o A1)	7-13/7-14

LIST OF TABLES

Table	Page	Table	Page
1-1. Specifications	1-1	5-3b. Triangle Linearity (Negative Slope)	5-9
1-2. General Information	1-1	5-4. Dial Linearity	5-11
5-1. Recommended Test Equipment	5-1	6-1. Replaceable Parts	6-2
5-2. Dial Accuracy Check	5-4	7-1. Troubleshooting Trees	7-1
5-3a. Triangle Linearity (Positive Slope)	5-9		

SECTION I

GENERAL INFORMATION

1-1. INTRODUCTION.

1-2. This section contains general information about the -hp- Model 3311A. Included is a paragraph regarding specifications, a description of the instrument and instrument identification information. Throughout this manual the instrument will be referred to as the "Model 3311A" or the "3311A".

1-3. SPECIFICATIONS.

1-4. Table 1-1 contains specifications for the Model 3311A. Table 1-2 contains general operating characteristics of the instrument. The information in Table 1-2 is provided for your convenience. It indicates how the instrument operates under typical operating conditions and should not be considered specifications.

1-5. DESCRIPTION.

1-6. The -hp- 3311A is a versatile Function Generator having sine, triangle, square and pulse outputs. The pulse output is a 0 to +5 V transition with a 10 to 20% duty cycle and is compatible with TTL circuits. The sine, square

and triangle functions have a maximum output voltage of 10 V peak open circuit or 5 V peak into 600 ohms. The signal may be offset by +10 V dc into open circuit or ± 5 V dc into 600 ohms.

1-7. The frequency range of the Model 3311A is .1 Hz to 1 MHz in 7 ranges. The frequency may be externally controlled in a 10:1 range by application of an external voltage to the VCO terminals.

1-8. INSTRUMENT AND MANUAL IDENTIFICATION.

1-9. Hewlett-Packard uses a two-section serial number. The first section (prefix) identifies a series of instruments. The last section (suffix) identifies a particular instrument within the series. If a letter is included with the serial number, it identifies the country where the instrument was manufactured. This manual is kept up-to-date with the instrument at all times with revised pages. If the serial prefix of your instrument differs from the one on the title page of this manual, refer to Section VIII for backdating information that will adapt this manual to your instrument. All correspondence with Hewlett-Packard should include the complete serial number.

Table 1-1. Specifications.

<p>600 OHM OUTPUT</p> <p>Dial Accuracy: ± 5% of full scale.</p> <p>Maximum Output Amplitude: 20 V p-p open circuit; 10 V p-p into 600 Ω.</p> <p>Amplitude Control: continuously variable, > 30 dB range.</p> <p>D.C. Offset: Continuously adjustable over a range from ≥ +10 V to ≤ -10 V open circuit (range from ≥ +5 V to ≤ -5 V into 600 Ω, and independent of amplitude control).</p> <p>Output Impedance: 600 Ω ± 10%.</p> <p>Sine Wave Amplitude Flatness: within ± 3% of 10 kHz reference (maximum output amplitude) to 100 kHz, ± 6% to 1 MHz.</p> <p>Triangle Linearity: < 1% deviation from best straight line at 100 Hz (10 V peak).</p> <p>Sine Wave Total Harmonic Distortion: < 3% at maximum output amplitude, 10 Hz to 1 MHz.</p>	<p>Square Wave Time Axis Symmetry: Error ± 2% error maximum to 100 kHz.</p> <p>Square Wave Transition Time: < 100 nsec (10 to 90% points)</p> <p>PULSE OUTPUT</p> <p>Output Amplitude: > 3 V positive (open circuit) TTL compatible.</p> <p>Duty Cycle: 10.0% to 20.0% of the total period.</p> <p>Transition Times: < 25 nsec (10 and 90% points).</p> <p>EXTERNAL FREQUENCY CONTROL</p> <p>VCO Range: > 10:1 on any frequency range.</p> <p>Input Requirement: With frequency dial set to 1.0, a linear ramp of 0 V to -10 V ± 2 V will linearly increase frequency > 10:1.</p>
--	---

Table 1-2. General Information.

<p>Waveforms: Sinusoid, square, triangle, positive pulse.</p> <p>Frequency Range: 0.1 Hz to 1 MHz in seven decade ranges.</p> <p>Isolation: using an external supply, the outputs may be floated as much as ± 500 V relative to the instrument case (outer chassis ground).</p> <p>Recommended Calibration Interval: 6 months.</p>	<p>VCO Input Impedance: 10 kΩ ± 10% shunted by < 60 pF.</p> <p>Power: 100/120/220/240 V -10% +5%, switchable, 48 to 440 Hz, ≤ 12 VA.</p> <p>Operating Temperature Range: 0°C to 55°C. Specifications apply from +15°C to +35°C.</p> <p>Storage Temperature Range: -40°C to 75°C.</p>
--	---

SECTION II INSTALLATION

2-1. INTRODUCTION.

2-2. This section contains installation and shipping information for the Model 3311A.

2-3. INITIAL INSPECTION.

2-4. Each 3311A has been carefully inspected prior to shipment and should be in perfect electrical order and free of marks or scratches. To confirm this, the instrument should be inspected upon receipt for damage that might have occurred in transit, or for other deficiencies. If there is damage due to shipping, file a claim with the carrier; if there are electrical or mechanical deficiencies not attributable to shipping, then refer to the statement of Warranty on the back of the title page. Use the procedures of Section V to check the instrument's performance.

2-5. POWER REQUIREMENTS.

2-6. The Model 3311A may be operated from the four line voltages 100 V, 120 V, 220 V and 240 V rms + 5% - 10%, of 48 Hz to 440 Hz frequency. The two switches on the rear panel are positioned to select one of the four voltages. The power requirement is 12 VA maximum.



TO AVOID INSTRUMENT DAMAGE, THE REAR PANEL LINE VOLTAGE SWITCHES MUST BE IN THE CORRECT POSITION BEFORE THE POWER CORD IS PLUGGED IN.

2-7. GROUNDING REQUIREMENTS.

2-8. For the safety of operating personnel, a provision for grounding the instrument case has been provided as recommended by the National Electrical Manufacturer's Association (NEMA). The offset pin of the power cable grounds the instrument when plugged into the appropriate receptacle. If only a two-contact receptacle is available, then use a three-prong-to-two-prong adapter and connect the adapter ground lead to earth ground.

2-9. INSTRUMENT MOUNTING.

2-10. Bench Use.

2-11. The front of the 3311A may be elevated for operating convenience by lowering the tilt stand on the bottom shell of the instrument.

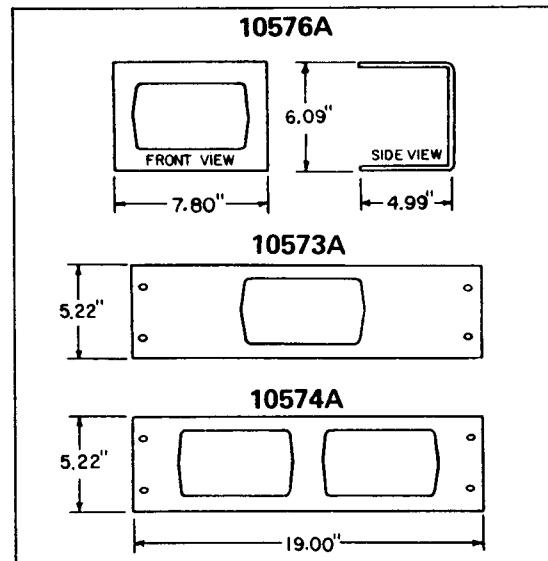

Figure 2-1. Rack Mount Kits.

2-12. Rack Mounting.

2-13. Figure 2-1 shows the available kits for rack mounting the 3311A.

2-14. REPACKAGING FOR SHIPMENT.

2-15. If the instrument is to be shipped to Hewlett-Packard for service or repair, attach a tag to the instrument describing the work to be accomplished and identifying the owner and instrument. Identify the instrument by serial number, model number, and name in any correspondence. If you have any questions, contact your local Hewlett-Packard Sales and Service Office. See Appendix B for office locations.

2-16. If the original shipping container is to be used, place the instrument in the container with appropriate packing material and seal the container well with strong tape or metal bands.

2-17. If an -hp- container is not to be used, then use a heavy carton or wooden box with an inner container. Wrap the instrument with heavy paper or plastic and place cardboard strips across the face for protection before placing the instrument in the inner container. Use packing material around all sides of the inner container, and seal the outer container well with strong tape or metal bands. Mark the container with "DELICATE INSTRUMENT", or "FRAGILE".

2-18. POWER CORDS AND RECEPTACLES.

2-19. Figure 2-2 illustrates the power receptacle configurations that are used in many countries. The -hp- part number shown directly above each receptacle drawing is the part number for a 3311A power cord equipped with the appropriate mating plug for that receptacle. If the appropriate power cord is not included with the instrument, notify the nearest -hp- Sales and Service Office and a replacement cord will be provided.

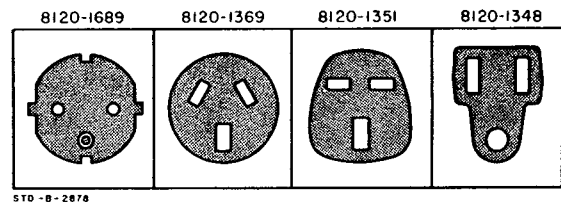

Figure 2-2. Power Receptacles.

SECTION III

OPERATING INSTRUCTIONS

3-1. INTRODUCTION.

3-2. This section contains information necessary for proper operation of the Model 3311A Function Generator. Identification of controls, indicators, and connectors (i.e., panel features), turn-on procedures, and general operating information are included in this section. Information pertaining to operating considerations is also provided.

3-3. PANEL FEATURES.

3-4. Panel features for the Model 3311A are described in Figure 3-1. Each operating control, indicator and connector is identified by an associated number and described by a paragraph with the corresponding number.

3-5. GENERAL OPERATING INFORMATION.



Before connecting the Model 3311A to primary power ensure that the proper line voltage and fuse have been selected. The switches and fuse holder are located on the rear panel.

3-6. Apply primary power to the instrument by pressing the LINE switch.

3-7. Selecting the Desired Output

NOTE

When using a cable on the 600 Ω OUTPUT terminals which has a characteristic impedance other than 600 ohms, the output signal will be distorted. The output cable should always be terminated in its characteristic impedance.

3-8. Select the function desired (⑥ of Figure 3-1). Set the RANGE switch (⑦) and the frequency dial (①) to the desired settings. The output frequency of the 3311A equals the RANGE setting times the dial setting. Turn the AMPLITUDE control (④) to minimum and connect the load to the OUTPUT terminals (③). Connect an oscilloscope to the OUTPUT terminals (③), and adjust the AMPLITUDE control for the desired output level. If DC OFFSET is desired set the offset (⑤) to the desired level using a dc coupled oscilloscope. DC offset can be obtained on sine, square or triangle functions. The pulse cannot be dc offset.

NOTE

At frequencies below 1 Hz it may be desirable to use an X - Y plotter or similar device in place of the oscilloscope.

To use the PULSE OUTPUT connect the desired load across the pulse terminals.

3-9. Using the VCO Input.

3-10. Connect a negative voltage source to the VCO INPUT terminals. A 0 V to - 10 V waveform applied to the VCO INPUT will sweep the 3311A over a 10:1 frequency range when the frequency dial is set to "1". This waveform can be obtained from another 3311A by adjusting its DC OFFSET and AMPLITUDE controls. A smaller VCO drive voltage may be used to obtain smaller frequency deviations. When the frequency dial is set above "1" a smaller VCO drive voltage is required. The VCO drive voltage should always be negative. Frequency can be swept up from the dial setting; it cannot be swept below the dial setting.

3-11. OPERATING CONSIDERATIONS.

3-12. Using Internal DC OFFSET.

3-13. The \pm DC OFFSET may be used to provide an output signal superimposed on a dc level. A maximum open circuit offset voltage of \pm 10 V can be obtained. The peak voltage of the signal, including any dc offset, cannot exceed \pm 10 V into an open circuit. Voltages in excess of this will be clipped. When operating into a 600 ohm load the above mentioned voltages are halved. This means that the peak voltage, including dc offset, is \pm 5 V.



DO NOT APPLY AN EXTERNAL VOLTAGE SOURCE > 30 V PEAK TO THE 600 Ω OUTPUT. TO DO SO MAY DAMAGE THE INSTRUMENT.

3-14. Floating Using External Sources.

3-15. The low terminal of the 3311A output can be referenced up to \pm 500 V dc above chassis (outer frame) ground.

3-16. If an external source is connected to the 3311A output it will add to the current flowing in the output. This will ordinarily not damage the instrument unless the source is connected directly across the output terminals. The maximum current which can be obtained from the 3311A output without clipping is 16.67 mA peak. This includes any current which may be contributed as a result of a source being connected in series with the output.

3-17. Using the Pulse Output.

3-18. When using the pulse output it is recommended that the interconnecting cable, between the source and the load, be terminated at the load in its characteristic impedance; i.e., if 50 ohm cable is used it should be terminated in

50 ohms. This is necessary since the pulse output is designed to be TTL compatible and has a very low output impedance. *Reflection from a load not matched to the interconnecting cable will result in ringing.* Leads of any measuring instrument connected to the pulse output should be as short as possible to prevent rounding of the pulse.

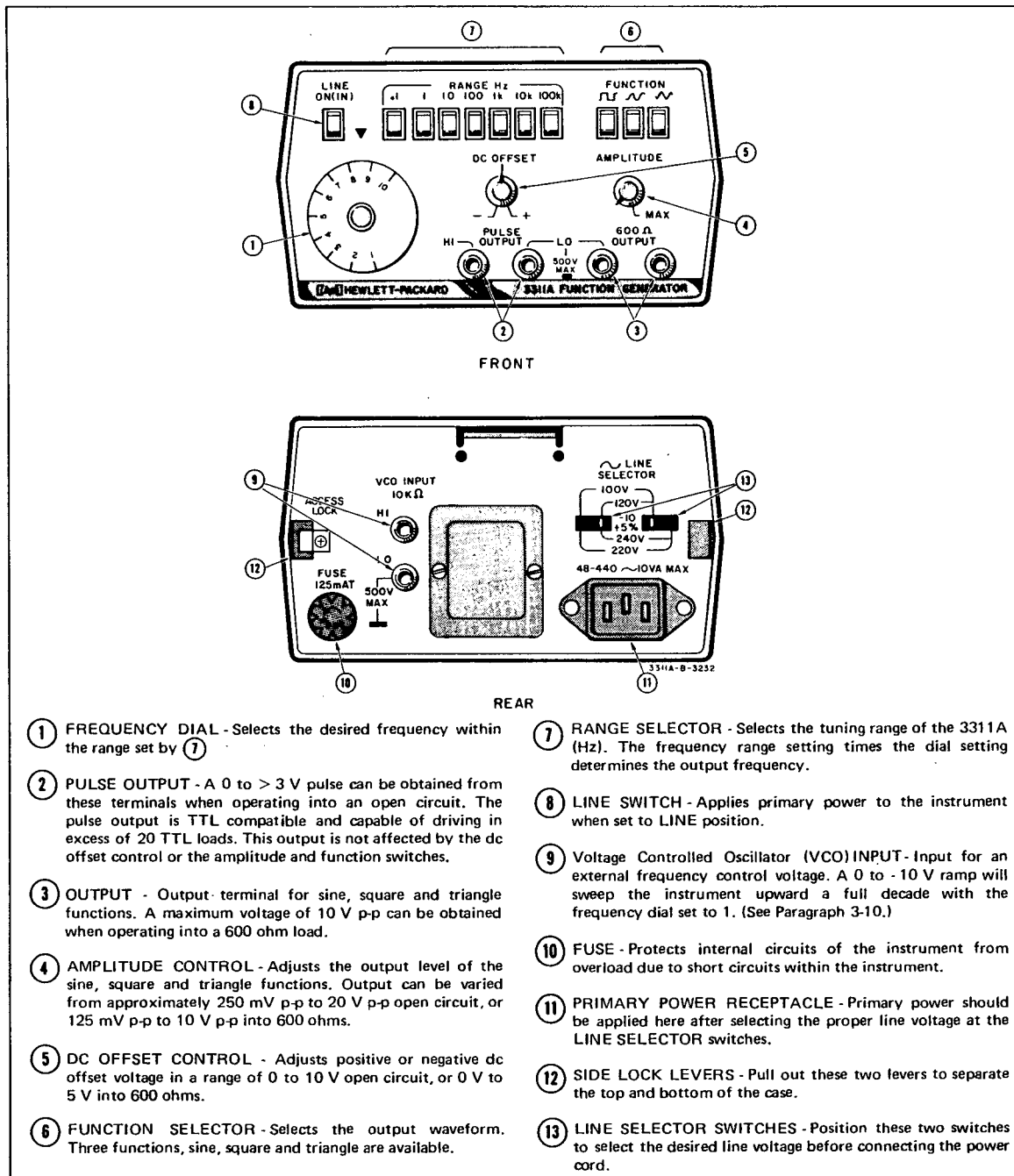

Figure 3-1. 3311A Front and Rear Panel Features.

SECTION IV

THEORY OF OPERATION

4.1. GENERAL DESCRIPTION.

NOTE

The discussion in Paragraph 4-2 through 4-5 refers to Figure 4-1.

4-2. The Model 3311A generates a linear ramp by charging a capacitor from a constant current source. The capacitor is then discharged through another constant current source to generate a triangle waveform. The output frequency is determined by the charge time plus the discharge time of the integrator capacitor (C_i).

4-3. Output level of the Tuning Amplifier is controlled by the frequency dial setting. The Tuning Amplifier and the Range Multiplier control the magnitude of current from the current sources. The charge/discharge rate of C_i is directly proportional to the magnitude of this current. The diode gates are controlled by the Square Wave Generator and determine when C_i is charging and when it is discharging.

4-4. The Triangle Amplifier output is the signal source for the Sine Shaper, the Square Wave Generator, and the Pulse Generator. The Square Wave Generator and the Pulse Generator employ a level comparison technique similar to that of a Schmitt Trigger, to create the square wave and pulse outputs.

4-5. The Function Selector selects sine, square, or triangle function and connects the selected function to the Output Amplifier.

4.6. DETAILED THEORY OF OPERATION.

4.7. Triangle Generator (See Figure 7-1).

4-8. Feedback from the emitter of current source Q11 causes the voltage at TP8 to equal the voltage at the + input of the tuning amplifier. Transistor Q9 biases Q5 and Q11 so that they have equal collector currents (R_a is always equal to R_b). Current I_1 flows through CR9 and into C_i and C6 during time interval T1 of the Square Wave Generator output. This causes the voltage of TP13 to rise. Also during T1 current I_2 flows through CR1 from the output of the Square Wave Generator. When the level of the voltage at TP13 becomes +2 V, the output of the Square Wave Generator switches to -7 V initiating time interval T2. Current I_2 is supplied by C_i and C6 through CR5 during T2. This causes the voltage at TP2 to decrease. During T2 current I_1 flows through CR3 to the output of the Square Wave Generator. When the voltage at TP13 reaches -2 V, the output of the Square Wave Generator switches back to +7 V.

4.9. VCO Input.

4-10. The voltage at the input to the Tuning Amplifier is determined by the setting of the frequency dial (R_2), and any negative voltage applied to the VCO INPUT. To sweep

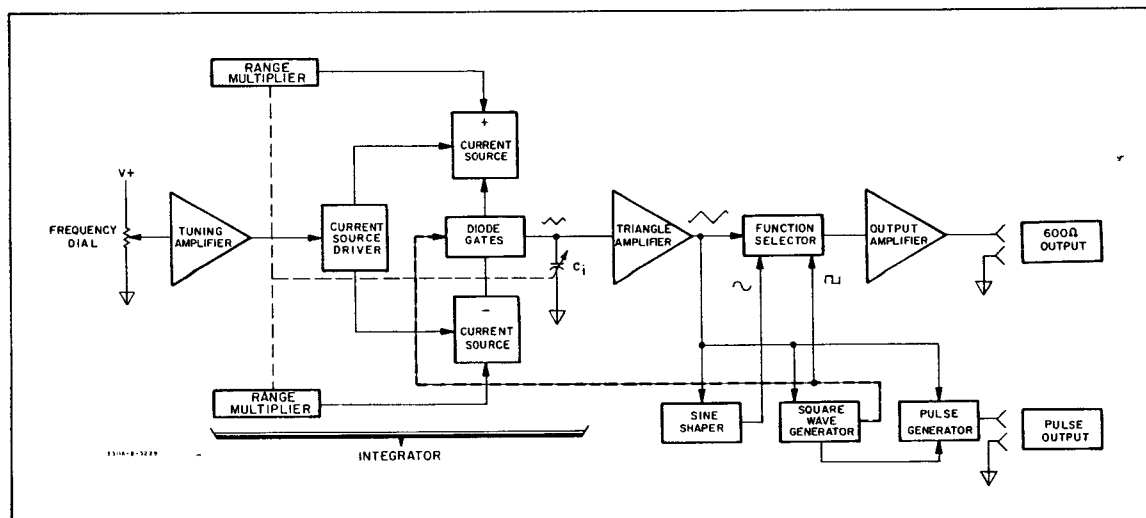

Figure 4-1. Basic Block Diagram.

the 3311A upward one full decade (10:1), the voltage at the + input of Tuning Amplifier must vary from approximately +18 V to +7 V. With no voltage applied to the VCO INPUT this voltage is controlled only by the frequency dial. When the frequency dial is set to 1 (full CW), a 0 to -10 V ramp applied to the VCO INPUT will sweep the 3311A upward in a 10:1 range.

4-11. Triangle Amplifier.

4-12. The Triangle Amplifier provides a voltage gain of 2. Current flowing into the amplifier input is minimized by its FET input stage. This prevents non-linearity of the ramp at low frequencies.

4-13. Sine Shaper (See Figure 4-2).

4-14. The Sine Shaper is composed of two sections. The first section shapes the waveform near its crest. This is accomplished by diodes CR59 and CR61 which alternately conduct, providing a low dynamic impedance to ground. The point on the waveform at which the diodes conduct is set by R165 for the positive half of the waveform and by R163 for the negative half. The signal is then coupled through R149 to the second section of the Sine Shaper. The diodes in this section are selected to ensure a smooth sine shaped curve. This accounts for the good distortion characteristics of the Model 3311A.

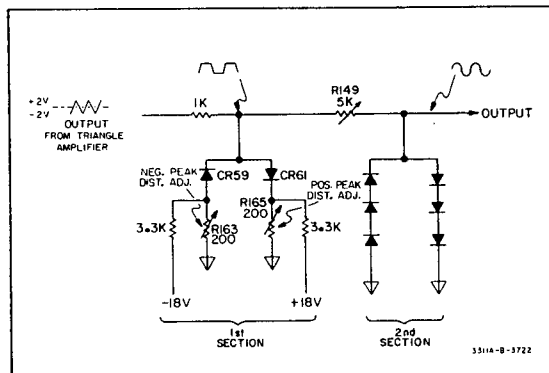

Figure 4-2. Sine Shaper.

4-15. Square Wave Generator (See Figure 4-3).

4-16. The Square Wave Generator output is switched between +7 V and -7 V. Operation of this circuit will be explained by following the circuit through one complete cycle of operation:

At t_0 the voltage at ① is -1 V and increasing with time. The voltage at ② is +7 V, and the voltage at ③ is +1 V. The output of U7 is +2 V which causes Q31 and Q21 to be turned off and Q33 and Q19 to be active. Current flows through Q33 to ground. Current also flows through CR27, CR17, and Q19 to the +18 V supply causing the voltage at point ② to be +7 V.

At T_1 the voltage at ① has increased and is slightly larger than the voltage at ③. This causes the output of U7 to change from +2 V to -0.5 V which turns off Q33 and Q19 and allows Q31 and Q21 to become active. Current flows through Q31 to ground. Current also flows through CR29, CR19, and Q21 to the -18 V supply causing the voltage at point ② to be -7 V. The voltage at point ③ now becomes -1 V. The change in output level at point ② switches the current sources in the integrator. This causes the triangle waveform to start in the negative direction.

At T_2 the voltage at ① becomes slightly more negative than the voltage at ③. This causes the output of U7 to switch, changing the states of Q33, Q31, Q21, and Q19. Accordingly, the integrator waveform changes directions becoming more positive with time.

4-17. Pulse Generator (See Figure 7-5).

4-18. The Pulse Generator compares the outputs of the Triangle Amplifier ② and the Square Wave Generator ①. When the proper comparison level is reached, a 0 to +5 V pulse is generated. Diodes CR2, CR4, and CR6 protect the Pulse Generator against external voltages which may be applied to the output.

CAUTION

This circuit will not protect against continuous application of currents exceeding 1 ampere.

4-19. Output Amplifier (See Figure 7-5).

4-20. The Output Amplifier provides a gain of 20 for the signals from the Function Selector. Diodes CR31, CR33, CR35, and CR37 are output protection diodes which conduct if excessive voltage is applied to the output.

CAUTION

Do not apply an external source of > 30 V peak to the output. To do so may damage the instrument.

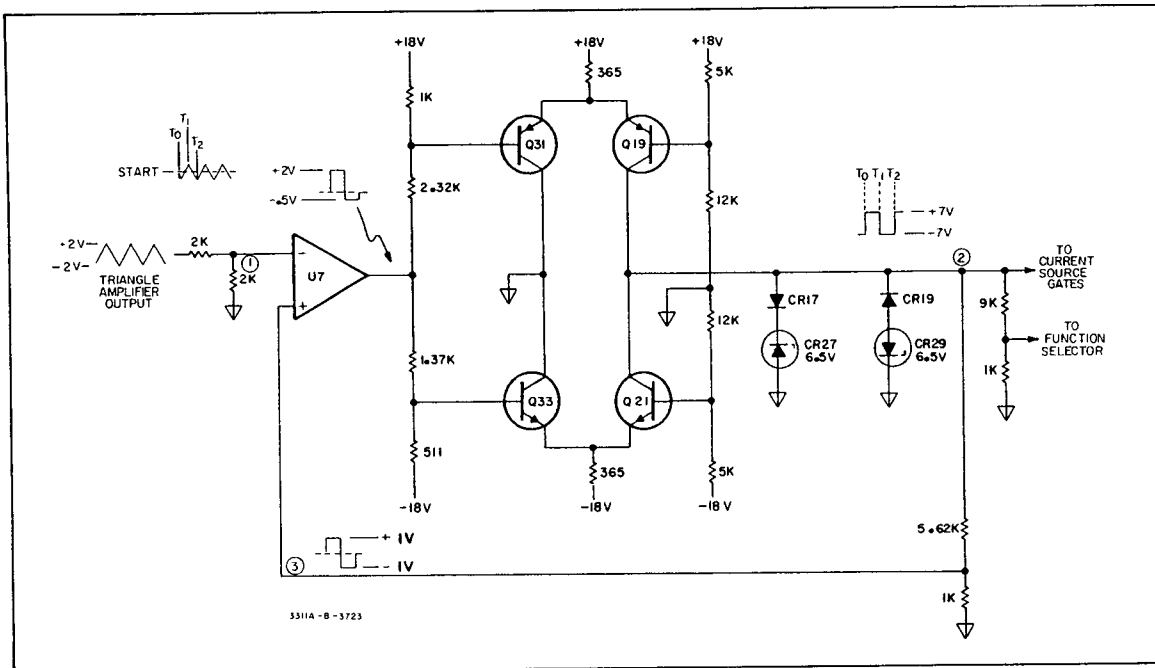

Figure 4-3. Square Wave Generator.

SECTION V MAINTENANCE

5-1. INTRODUCTION.

5-2. This section contains information necessary for proper maintenance of the Model 3311A. Included are Performance Tests and Adjustment Procedures. The Performance Tests may be used for incoming inspection and prior to using the Adjustment Procedures. Specifications are given in Table 1-1. If your instrument does not meet its required specifications, refer to the Adjustment Procedures.

5-3. RECOMMENDED TEST EQUIPMENT.

5-4. The test equipment that is recommended for main-

taining the Model 3311A is listed in Table 5-1. If the recommended Model is not available, use an instrument that has specifications equal to or exceeding those listed.

5-5. TEST RECORD.

5-6. A Performance Test Record form is provided at the end of this section to record the results of the Performance Tests and their acceptable limits. The form may be removed from your manual and retained as a permanent record of the incoming inspection or routine maintenance performed on the instrument. It may be reproduced without written permission from Hewlett-Packard.

Table 5-1. Recommended Test Equipment.

Instrument Type	Required Specifications	Recommended Model
Electronic Counter	.1 Hz to 1 MHz with time interval capability	-hp- Model 5245L with a Model 5262A Time Interval Plug-In
Oscilloscope	1 MHz bandwidth with dual channel (-hp- Model 1805A) and delay (-hp- Model 1821A) plug-ins	-hp- Model 180C/1805A/1821A with 10004A oscilloscope probe (an -hp- Model 1801A vertical amplifier may be used if a Model 1805A is not available.)
Divider Probe	10 M Ω , 10:1 divider \leq 10 pF shunt cap.	-hp- 10004B
Distortion Analyzer	Distortion measurement range: 5 Hz to 600 kHz \pm 0.1%	-hp- Model 333A/334A
Power Supply	Voltage Regulation: \pm 4 mV Voltage Adjustment Range: 0 to - 12 V	-hp- Model 6215A
Resistors	R: fxd, 604 Ω \pm 1% R: fxd, 51 Ω \pm 1% R: fxd, 10 k Ω \pm 1%	-hp- Part No. 0757-0161 -hp- Part No. 0683-5105 -hp- Part No. 0757-0442
Feedthru Terminating Resistance	Resistance: 50 Ω \pm 1% Frequency Range: dc to 10 MHz	-hp- Model 11048C
Feedthru Terminating Resistance	Resistance: 600 Ω \pm 1% Frequency Range: dc to 1 MHz	-hp- Model 11095A
Notch Filter (1 MHz)	C: fxd, 820 pF, 1 ea C: fxd, 300 pF, 2 ea L: fxd, 22 μ H, 1 ea R: fxd, 1200 Ω \pm 10% R: var, 1 k Ω \pm 10%	0160-2009 0140-0225 9140-0179 0684-1221 2100-2291
AC Voltmeter	Frequency Range: 20 Hz to 4 MHz Voltage Range: 100 μ V to 10 V	-hp- Model 400F/FL
Digital Voltmeter	10 mV sensitivity, 3 digits resolution, with sample-and-hold option, and dc measuring capability	-hp- Model 3480C/D/3484A with option 001 (sample-and-hold)
Function Generator	Output Frequency: 20 kHz Function: Square Wave, with triggering capability	-hp- Model 3300A/3302A
Function Generator	\pm 7 V peak square wave output 50 Ω output impedance	-hp- Model 3310A (recommended for troubleshooting)

5-7. PERFORMANCE TESTS.

5-8. The following tests verify that the Model 3311A is operating properly and meets the specifications listed in Table 1-1 of this manual. These tests should be completed before attempting to adjust the instrument.

5-9. Sine Wave Amplitude Flatness Test.**DESCRIPTION:**

This test verifies the ability of the Model 3311A to maintain constant output amplitude within $\pm 3\%$ from 0.1 Hz to 100 kHz, and $\pm 6\%$ from 100 kHz to 1 MHz.

SPECIFICATION:

Sine Wave Frequency Response: $\pm 3\%$, 0.1 Hz to 100 kHz; $\pm 6\%$, 100 kHz to 1 MHz; 10 kHz reference (600 Ω termination).

NOTE

In the following procedure all interconnecting wires should be as short as possible.

RECOMMENDED TEST EQUIPMENT:

Oscilloscope, -hp- Model 180C with 1805A/1821A plug-ins
604 Ω resistor, -hp- Part Number 0757-0161

TEST PROCEDURE:

- Connect the equipment as shown in Figure 5-1.
- Set the Model 3311A controls for a 10 kHz sine wave. Set the AMPLITUDE control to the fully clockwise position. DC OFFSET should be set to minimum (control centered).
- Using the oscilloscope, measure the peak to peak amplitude of the 3311A output. Multiply this value by 0.015 to determine maximum permissible deviation (Vdev) in volts.

- Set the oscilloscope vertical sensitivity to .2 V/div. Set the sweep time to .2 ms/Div.

NOTE

The following procedure requires the oscilloscope display to be offset in order to view the top of the displayed waveform. This is accomplished with the vertical position and DC OFFSET controls of the Model 1805A Vertical Amplifier. If you have a Model 1801A Vertical Amplifier the DC Bal Control can be used to offset the waveform. The Model 1801A should be readjusted after this test is completed.

- Using the vertical position and DC Offset controls of the oscilloscope, position the display so that the positive peaks of the signal just touch the horizontal center line of the graticule.

- Check several frequencies from 0.1 Hz to 100 kHz. The positive peaks of the oscilloscope display should vary no more than the value of Vdev calculated in step c.

- Check several frequencies between 100 kHz and 1 MHz. Maximum allowable deviation for these frequencies is twice Vdev.

5-10. Square Wave Time Axis Symmetry Error Test.**DESCRIPTION:**

This test verifies that the positive and negative halves of the 3311A square wave output have equal periods within $\pm 2\%$ of each other.

SPECIFICATION:

Square Wave Time Axis Symmetry Error: $< 2\%$ to 100 kHz.

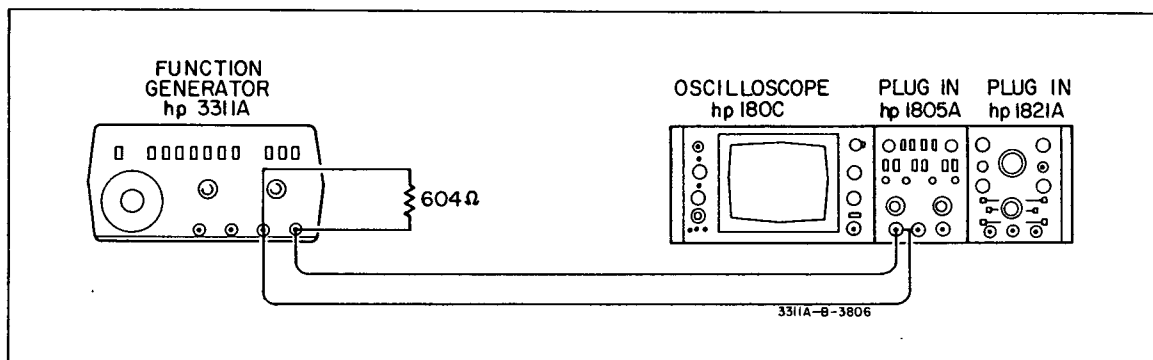

Figure 5-1. Amplitude Flatness.

RECOMMENDED TEST EQUIPMENT:

Electronic counter, -hp- Model 5245L with 5262A Plug-In

a. Set the 3311A to square wave function and connect the output to the time interval input of an electronic counter as shown in Figure 5-2 (symmetry).

b. Set the 3311A frequency to 100 kHz and adjust the AMPLITUDE control to maximum.

c. Measure the period of the positive portion of the square wave and then the period of the negative portion.

d. Calculate symmetry error using the following formula:

$$E_s (\%) = \frac{T_1 - T_2}{T_1 + T_2} \times 100$$

Where:

T_1 = Period of the positive portion of the waveform.

T_2 = Period of the negative portion of the waveform.

The value of E_s should not exceed 2%.

e. Measure the period of the positive and negative portion of the square wave at several other frequencies between 0.1 Hz and 100 kHz. Symmetry error should not exceed 2% for any frequency.

5-11. Pulse Duty Cycle Test.

DESCRIPTION:

This test verifies that the width of the pulse generated by Model 3311A is between 10 and 20% of the total period of one cycle.

SPECIFICATION:

Duty Cycle: 10.0% to 20.0% of the total period.

RECOMMENDED TEST EQUIPMENT:

Electronic counter, -hp- Model 5245L/5262A Plug-In

TEST PROCEDURE:

a. Connect the equipment as shown in Figure 5-2 for the symmetry test except connect the counter to the 3311A PULSE OUTPUT.

b. Set the 3311A frequency to 10 kHz and adjust the amplitude control to maximum.

c. Measure the period of the pulse and then the period of one cycle.

d. Divide the period of the pulse by the period measured for one cycle. This value should be between 0.1 and 0.2, i.e. 10% to 20%.

5-12. Dial Accuracy Test.

DESCRIPTION:

This test verifies that the dial setting of the Model 3311A coincides with the output frequency to within $\pm 5\%$ of maximum dial setting.

SPECIFICATION:

Dial Accuracy: $\pm 5\%$ of full scale

RECOMMENDED TEST EQUIPMENT:

Electronic counter, -hp- Model 5245L/5262A
Feed-Thru Termination (600 Ω), -hp- 11095A

TEST PROCEDURE:

a. Connect the equipment as shown in Figure 5-2 for the dial accuracy check.

b. Set the 3311A FUNCTION to square wave. Set the AMPLITUDE control Maximum.

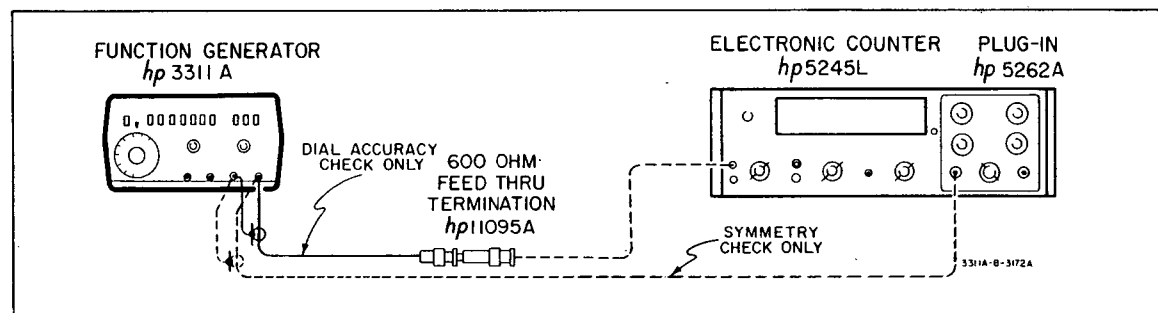

Figure 5-2. Dial Accuracy/Time Axis Symmetry Check.

See Change 1

c. Check the dial accuracy at the settings listed in Table 5-2. All readings should fall within the limits listed under "Counter Indication" in the Table.

Table 5-2. Dial Accuracy Check.

3311A Control Settings		
Dial	Range	Counter Indication
1	.1	6670 ms to 20000 ms
5	.1	1820 ms to 2220 ms
10	.1	950 ms to 1050 ms
1	1	667 ms to 2000 ms
5	1	182 ms to 222 ms
10	1	96 ms to 105 ms
1	10	66.7 ms to 200 ms
5	10	18.2 ms to 22.2 ms
10	10	9.5 ms to 10.5 ms
1	100	50 Hz to 150 Hz
5	100	450 Hz to 550 Hz
10	100	950 Hz to 1050 Hz
1	1 K	500 Hz to 1500 Hz
5	1 K	4500 Hz to 5500 Hz
10	1 K	9500 Hz to 10.5 kHz
1	10 K	5 kHz to 15 kHz
5	10 K	45 kHz to 55 kHz
10	10 K	95 kHz to 105 kHz
1	100 K	50 kHz to 150 kHz
5	100 K	450 kHz to 550 kHz
10	100 K	950 kHz to 1050 kHz

RECOMMENDED TEST EQUIPMENT:

- Resistor (50Ω), -hp- Part Number 0683-5105
- Distortion Analyzer, -hp- Model 333A or 334A
- Notch Filter, 1 MHz (See Table 5-1 for a list of components)

TEST PROCEDURE:

- Connect the equipment as shown in Figure 5-3.
- Set the 3311A FUNCTION to sine at a frequency of 10 Hz and measure the distortion. It should be more than 30 dB below the fundamental.
- Measure distortion at several other frequencies from 10 Hz through 600 kHz. Distortion should be more than 30 dB below the fundamental for each frequency checked. *Adjust the 3311A sine out for 400 mV RMS*
- Connect the equipment as shown in Figure 5-4. The components for the 1 MHz notch filter are listed in Table 5-1.
- Set the 3311A frequency dial to the fully clockwise position on the 100 K RANGE. Adjust the AMPLITUDE control for a 0 dB indication on the voltmeter. This is the reference level.
- Readjust the 3311A frequency to 1 MHz.

5-13. Sine Wave Distortion Test.

DESCRIPTION:

This test verifies that the sine wave distortion of the Model 3311A is less than 3%; i.e. greater than 30 dB below the fundamental.

SPECIFICATION:

Distortion: <3% at maximum output amplitude, 10 Hz to 1 MHz.

5-14. Square Wave and Pulse Response Test.

DESCRIPTION:

This test verifies that the square wave and pulse transition times (10 and 90% points) meet the specifications listed below.

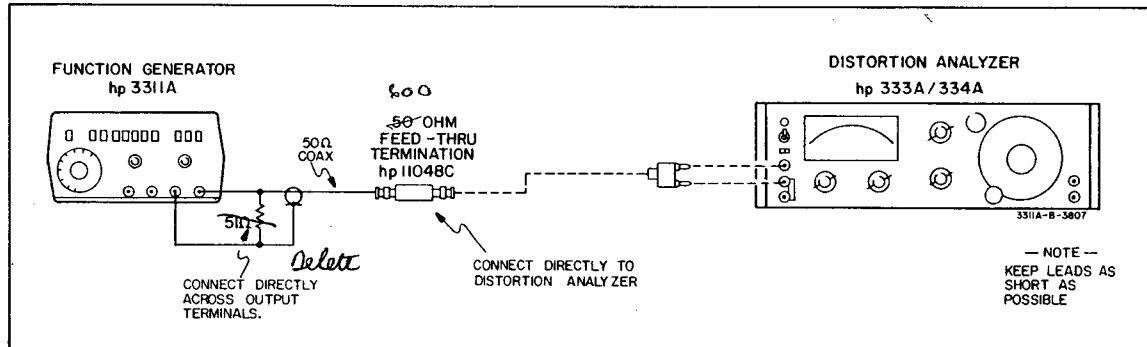

Figure 5-3. Distortion Test.

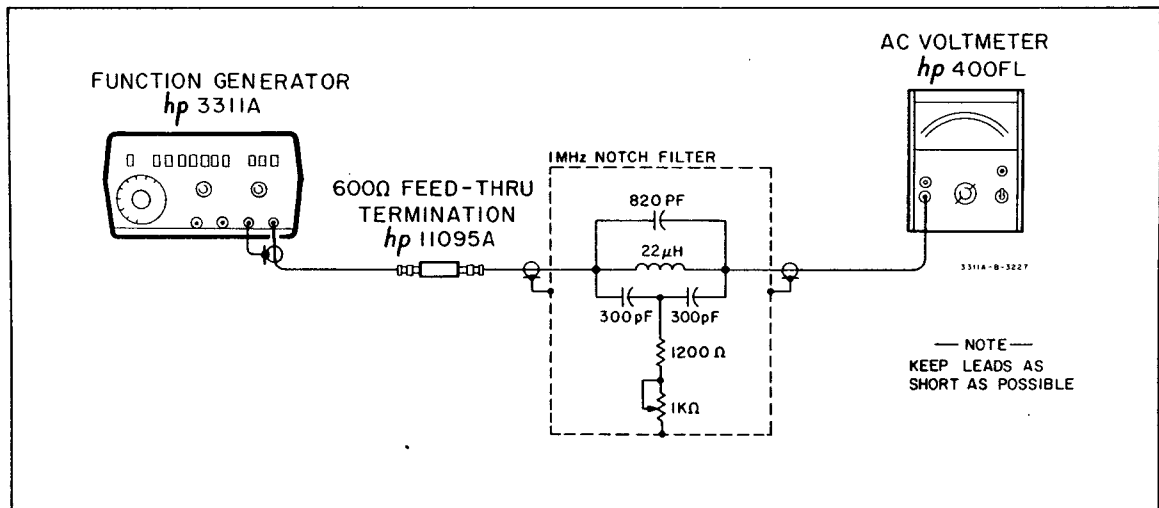

Figure 5-4. 1 MHz Distortion Test.

SPECIFICATION:

Square Wave Transition Time: < 100 ns
 Pulse Transition Time: < 25 ns

RECOMMENDED TEST EQUIPMENT:

Oscilloscope, -hp- Model 180C/1805A/1821A
 Resistor (51 Ω), -hp- Part Number 0683-5105
 Feed-Thru Termination (600 Ω), -hp- 11095A

TEST PROCEDURE:

NOTE

Keep all interconnecting leads as short as possible.

a. Connect the 3311A as shown in Figure 5-5.

b. Set **AMPLITUDE** to maximum and the **FUNCTION** switch to square wave.

c. Set the 3311A frequency to 1 kHz and check the rise and fall times of the square wave. The time required for the transition between 10% and 90% of the square wave amplitude should be less than 100 ns.

d. Repeat step c for several other frequencies. The rise and fall times in each case should be less than 100 ns.

e. Disconnect the oscilloscope from the 600 Ω **OUTPUT** of the 3311A and connect it to the **PULSE OUTPUT**.

f. Measure the rise and fall times of the pulse at several frequencies. Time required for the transition between 10% and 90% of the pulse amplitude should be less than 25 ns.

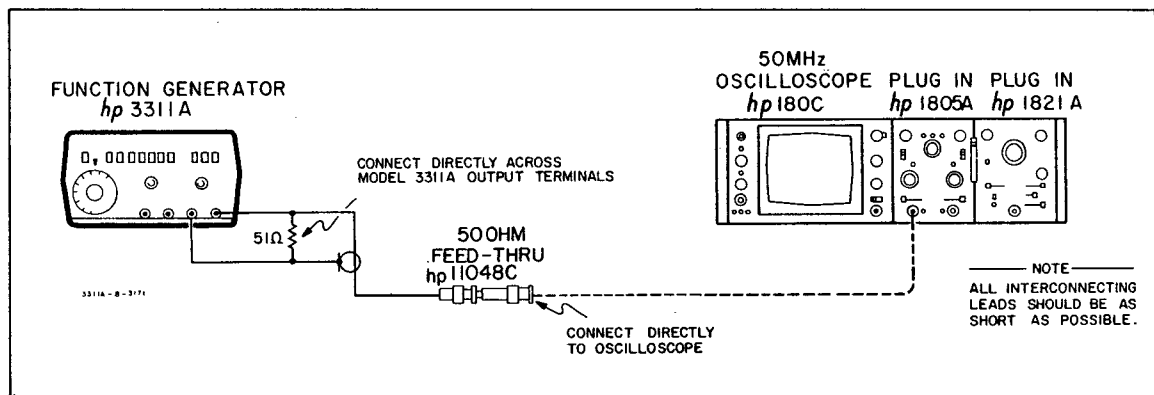

Figure 5-5. Transition Time Tests.

5-15. Output Impedance Test.**DESCRIPTION:**

This test verifies that the output impedance of the Model 3311A is $600\ \Omega \pm 10\%$ at the $600\ \Omega$ OUTPUT terminals.

SPECIFICATION:

Output Impedance: $600\ \Omega \pm 10\%$

RECOMMENDED TEST EQUIPMENT:

AC Voltmeter, -hp- Model 3480C/D/3484A
Feed-Thru Termination ($600\ \Omega$), -hp- 11095A

TEST PROCEDURE:

- a. Set the Model 3311A for a 1 kHz sine wave.
- b. Connect a true rms voltmeter to the $600\ \Omega$ OUTPUT. Adjust the Model 3311A for 6.00 V rms as observed on the voltmeter.
- c. Remove the voltmeter and connect a $600\ \Omega$ terminating resistor (-hp- 11095A or equivalent) to the output.
- d. Reconnect the voltmeter to the terminated output and note the voltmeter indication. It should indicate between 2.84 V and 3.16 V.
- e. Repeat steps b through d for several other frequencies between 1 Hz and 1 MHz.

5-16. Maximum Signal Output and Amplitude Range Test.**DESCRIPTION:**

This test measures the maximum output voltage from the 3311A for both open circuit and terminated conditions. The range of adjustment of the AMPLITUDE control is also checked.

SPECIFICATION:

Maximum Output Amplitude: 10 V p-p into $600\ \Omega$, 20 V p-p into open circuit.
Amplitude Control: Continuously variable, > 30 dB range.

RECOMMENDED TEST EQUIPMENT:

AC Voltmeter, -hp- Model 3480C/D/3484A
Feed-Thru Termination ($600\ \Omega$), -hp- 11095A

TEST PROCEDURE:

- a. Terminate the $600\ \Omega$ OUTPUT of the Model 3311A with $600\ \Omega$ and connect it to an ac voltmeter.

- b. Set the 3311A to sine function at a frequency of 1 MHz. Set the DC OFFSET to minimum and the AMPLITUDE control to the fully clockwise position.

- c. The voltmeter should indicate more than 3.53 V rms (10 V p-p).

- d. Remove the $600\ \Omega$ load and connect the Model 3311A directly to the voltmeter. The voltmeter should indicate greater than 7 V rms (20 V p-p). Note this value.

- e. Turn the AMPLITUDE control to the fully ccw position and observe the meter. The indication should be less than 0.0316 times the voltage measured in step d. This verifies an amplitude control range of > 30 dB.

5-17. Pulse Output Amplitude Test.**DESCRIPTION:**

This test verifies that the PULSE OUTPUT amplitude is greater than 3 V into open circuit.

SPECIFICATION:

Pulse Output: > 3 V positive (open circuit), TTL Compatible.

RECOMMENDED TEST EQUIPMENT:

Oscilloscope, -hp- Model 180C/1805A/1821A
Divider Probe, -hp- Model 10004B

TEST PROCEDURE:

- a. Connect an oscilloscope with a 10:1 divider probe to the 3311A PULSE OUTPUT. *The PULSE OUTPUT should have no load attached to it.*

- b. Set the frequency of the Model 3311A to approximately 1 MHz.

- c. Observe the oscilloscope and measure the peak-to-peak amplitude of the pulse. It should be > 3 V. This verifies pulse output amplitude. Check pulse amplitude at several other frequencies.

5-18. DC Offset Test.**DESCRIPTION:**

This test verifies the maximum plus and minus dc offset obtainable from the 3311A.

SPECIFICATION:

DC OFFSET: Continuously adjustable over a range from $\geq +10$ V to ≤ -10 V open circuit (range from $\geq +5$ V to ≤ -5 V into $600\ \Omega$), and independent of amplitude control.

RECOMMENDED TEST EQUIPMENT:

DC Voltmeter, -hp- Model 3480C/D/3484A
 Feed-Thru Termination (600 Ω), -hp- 11095A

TEST PROCEDURE:

- Set the Model 3311A AMPLITUDE control to minimum.
- Terminate the signal output in 600 ohms and connect it to a dc voltmeter.
- Turn the DC OFFSET control to the fully counter-clockwise position. A voltage of ± 5 V should be observed on the dc voltmeter.
- Turn the DC OFFSET control to the fully counter-clockwise position. A voltage of ± 5 V should be observed on the dc voltmeter.
- Remove the 600 ohm termination and repeat steps c and d except check for dc offset $\geq \pm 10$ V. This verifies the DC OFFSET specification.

5-19. VCO Test

DESCRIPTION:

This test verifies the frequency range and voltage input requirement VCO INPUT.

SPECIFICATION:

VCO range: $> 10:1$ on any frequency range.
 Input Requirement: With frequency dial set to 1, a linear ramp of 0 V to -10 V ± 2 V will linearly increase frequency $> 10:1$.

RECOMMENDED TEST EQUIPMENT:

Oscilloscope, -hp- Model 180C/1805A/1821A
 DC Voltmeter, -hp- Model 3480A/3484A
 Power Supply, -hp- Model 6215A
 Electronic Counter, -hp- Model 5245L/5262A
 Resistor (10 k Ω $\pm 1\%$), -hp- Part Number 0757-0442

TEST PROCEDURE:

- Select the 100 K RANGE of the Model 3311A and set the frequency dial to 1.
- Connect the 600 Ω OUTPUT of the Model 3311A to the input of a frequency counter. Note the reading of the counter.
- Apply a negative voltage of less than 10 V from the power supply to the VCO INPUT terminals of the Model 3311A.

d. Observe the frequency counter and adjust the power supply so that the indication is ten times that noted in step b.

e. Check the power supply voltage with a dc voltmeter. It should indicate -10 V ± 2 V.

f. Increase the power supply voltage slightly and note the counter indication. It should be more than 10 times the frequency observed in step b.

g. Repeat steps b through f for the 10 K and 1 K ranges.

h. Set the electronic counter to measure period.

i. Set the frequency dial of the 3311A to 1 and the RANGE to 100. Connect the 600 Ω OUTPUT to the counter and note its indication.

j. Apply a negative voltage of less than 10 V to the VCO INPUT terminals of the 3311A.

k. Observe the frequency counter and adjust the power supply so that the indication is 1/10 of that noted in step i.

l. Check the power supply voltage with a dc voltmeter. It should indicate -10 V ± 2 V.

m. Increase the power supply voltage slightly and note the counter indication. It should be less than 1/10 of the period observed in step i. This verifies the VCO range and input requirement.

n. Repeat steps i through m except check the X.1 through X10 RANGES.

5-20. Triangle Linearity Test

DESCRIPTION:

This test verifies that the linearity of the sloping sides of the triangle waveform generated by the Model 3311A does not deviate more than 1% from a mathematically determined "best straight line."

SPECIFICATION:

Linearity: Deviation $< 1\%$ from best straight line at 100 Hz (10 V peak output amplitude).

RECOMMENDED TEST EQUIPMENT:

Sampling Voltmeter, -hp- Model 3480C/D/3484A
 Function Generator, -hp- Model 3300A/3302A
 Oscilloscope, -hp- Model 180C/1805A/1821A
 Electronic Counter, -hp- Model 5245L/5262A

TEST PROCEDURE:

a. Set the 3311A frequency dial to 10 and select the X10 frequency RANGE. Using an electronic counter to monitor the 3311A output adjust the frequency dial for a period of 10.0 msec.

b. Set the 3480C/D/3484A Voltmeter to measure ac voltage. Connect the voltmeter to the 3311A 600 Ω OUTPUT and adjust the AMPLITUDE control for 5.78 V rms as indicated on the voltmeter.

c. Connect the equipment as shown in Figure 5-6.

d. Set the controls of the 3480C/D/3484A Voltmeter as follows:

FUNCTION	V dc
SAMPLE RATE	HOLD
FILTER	OUT
TERMINAL	FRONT
RANGE	10

e. Set the MODE switch at the rear of the 3480C/D to the "ON" position and the DELAY switch to the "OFF" position.

f. Set the 5262A Time Interval unit to trigger on a +.3 V negative going transition in the START channel, and on a +.6 V negative going transition in the STOP channel. Set the 5245L FUNCTION switch to "REMOTE OR TIME INT." and use the 1 μ s TIME BASE.

g. Set the 3300A for a 20 kHz square wave triggered by the Model 180C DELAYED GATE OUTPUT. Set the channel B AMPLITUDE control of the 3300A to the fully clockwise position. Set the Model 3302A MODE to MULTIPLE, INPUT PHASE to -, and START/STOP PHASE to EXTERNAL.

h. Set the oscilloscope to trigger externally on the PULSE OUTPUT of the Model 3311A. The oscilloscope input should be dc coupled. Adjust the controls of the oscilloscope so that one cycle of the triangle wave occupies approximately the full length and height of the display area.

i. Set the oscilloscope delay time control to 5 μ s/div.

j. Note the bright dot which appears on the trace and adjust the delay control on the oscilloscope so that the dot is precisely on the negative peak of the triangle wave. Adjust the 3311A DC OFFSET for a reading of -10 V as indicated on the voltmeter.

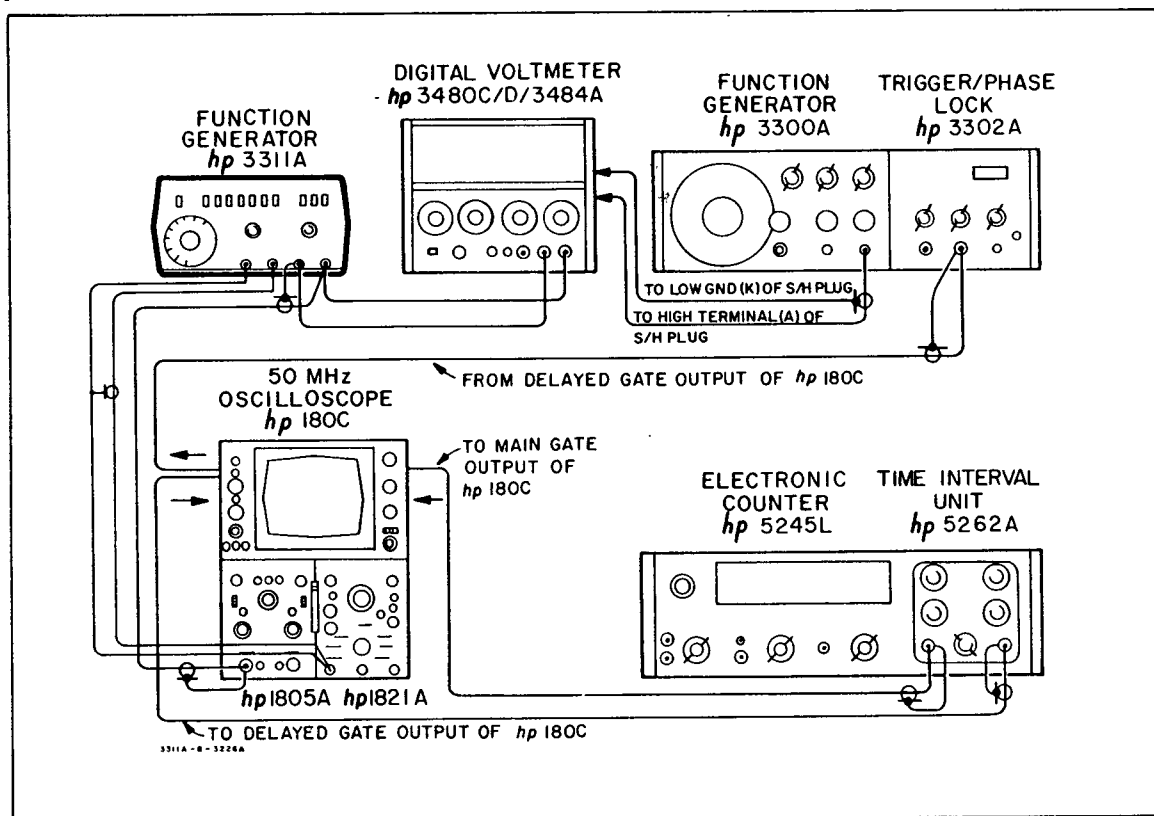

Figure 5-6. Triangle Linearity Check.

k. Readjust the oscilloscope delay control so that the bright dot appears on the positive peak of the triangle wave. Note the indication of the voltmeter; it should be + 10.0 V. If it is not, readjust the 3311A DC OFFSET and repeat steps j and k until the voltages are equal to ± 10 V.

NOTE

When checking linearity on the positive slope of the triangle waveform set the oscilloscope time/div to .5 ms. When checking the negative slope set the oscilloscope to 1 ms.

l. Adjust the oscilloscope delay control until the 3480C/D/3484A Voltmeter reads - 9.00 V. Note the indication of the electronic counter. This reading is the "relative zero" and must be subtracted from subsequent indications to obtain the values listed in Table 5-3(a). The relative zero for Table 5(b) is measured at + 9.00 V.

m. Verify linearity by checking the instrument at each point indicated in Table 5-3. Each reading should be within the limits given. Be sure to subtract the relative zero from each measurement to obtain the adjusted minimum and maximum indications.

Table 5-3(a). Triangle Linearity (Positive Slope).

3480C/D/3484A Voltage Reading (V)	Adjusted Minimum 5245L Indication	Adjusted Maximum 5245L Indication
- 9.00	Relative Zero (noted in step 1)	Relative Zero (noted in step 1)
- 7.00	.495	.505
- 5.00	.989	1.009
- 3.00	1.484	1.514
- 1.00	1.979	2.019
+ 1.00	2.473	2.523
+ 3.00	2.968	3.028
+ 5.00	3.462	3.532
+ 7.00	3.957	4.037
+ 9.00	4.452	4.542

Table 5-3(b). Triangle Linearity (Negative Slope).

3480C/D/3484A Voltage Reading (V)	Adjusted Minimum 5245L Indication	Adjusted Maximum 5245L Indication
+ 9.00	Relative Zero (noted in step 1)	Relative Zero (noted in step 1)
+ 7.00	.493	.503
+ 5.00	.986	1.006
+ 3.00	1.479	1.509
+ 1.00	1.197	2.011
- 1.00	2.464	2.514
- 3.00	2.957	3.017
- 5.00	3.450	3.520
- 7.00	3.943	4.023
- 9.00	4.436	4.526

*IF use 3437A + Delay so readings start at -10 and go to +10
 start at -9 value (say -9.02) and since this is relative zero
 add complement (+9.02) to get zero value. use this offset
 to each actual voltage reading. Then divide the result
 by 4 to get value for table. (ie -10 to +10
 becomes 0 to +20
 to scale 20 down to 5.0; ÷ by 4)*

ADJUSTMENT PROCEDURES

5-21. ADJUSTMENT PROCEDURES.

5-22. Access to the 3311A adjustments is obtained as follows:

- a. Remove the safety bracket which is over the left side lock lever.
- b. Pull the two side lock levers at the back of the instrument to the rear and remove the bottom cover of the instrument.

This will expose the component side of the A1 assembly. Figure 5-7 shows the location of internal adjustments.

WARNING

SOME OF THE MAINTENANCE AND SERVICING OPERATIONS DESCRIBED HEREIN ARE PERFORMED WITH POWER SUPPLIED TO THE INSTRUMENT WHILE PROTECTIVE COVERS ARE REMOVED. BE CAREFUL WHEN PERFORMING THESE OPERATIONS. LINE VOLTAGE IS ALWAYS PRESENT ON TERMINALS INCLUDING THE POWER INPUT CONNECTOR, FUSE-HOLDER AND POWER SWITCH.

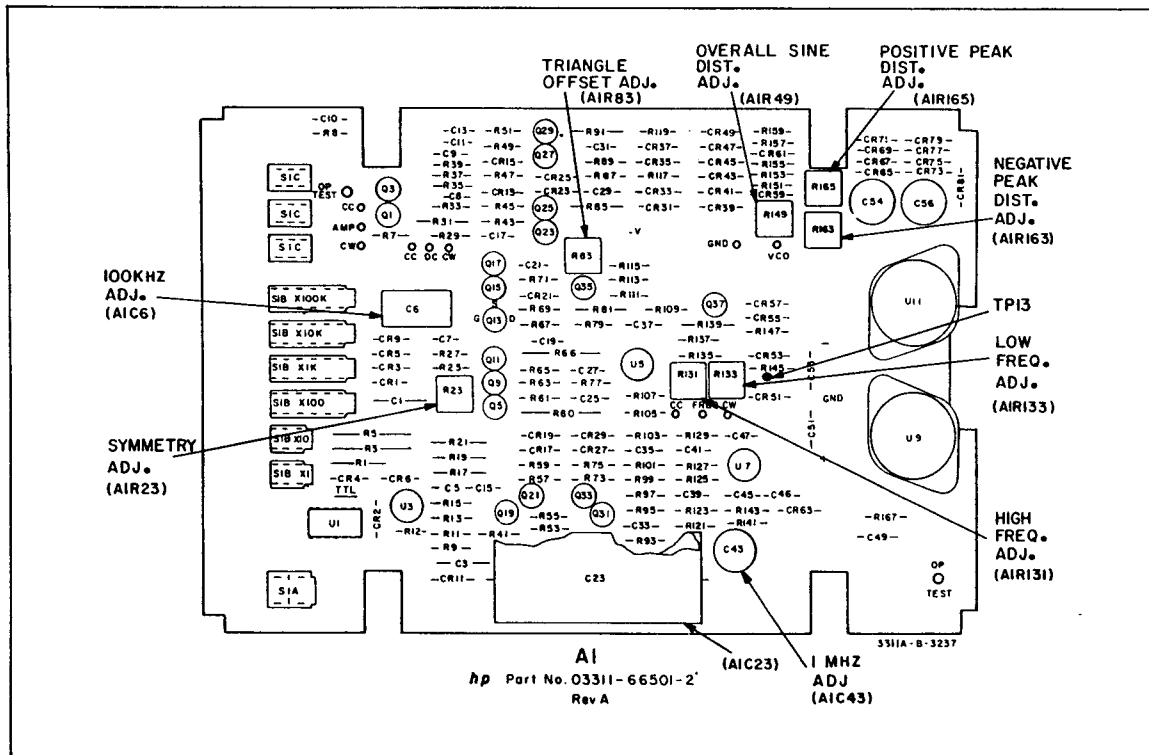

Figure 5-7. Adjustment Locator.

NOTE

Before proceeding set the DC OFFSET control for minimum offset. Also turn the AMPLITUDE control to the fully clockwise position.

5-23. Triangle Amplifier Offset Adjustment.**DESCRIPTION:**

This adjustment minimizes the dc offset of the triangle amplifier.

RECOMMENDED TEST EQUIPMENT:

DC Voltmeter, -hp- Model 3480C/D/3484A

PROCEDURE:

- Connect a jumper in shunt with A1C23 (5 μ F).
- Select the .1 Hz RANGE.
- Connect a dc voltmeter to the output of the Triangle Amplifier (A1TP13). Adjust A1R83 for 0 V \pm 200 mV.
- Remove the jumper on A1C23.

5-24. Square Wave Time Axis Symmetry Adjustment.**DESCRIPTION:**

This adjustment minimizes time axis symmetry error of the Model 3311A output.

RECOMMENDED TEST EQUIPMENT:

Electronic Counter, -hp- Model 5245L/5262A
600 Ω Termination, -hp- 11095A

PROCEDURE:

- Select the square wave FUNCTION of the Model 3311A and set the RANGE to 10 kHz. The frequency dial should be set to 1.
- Terminate the 600 Ω output of the 3311A in 600 Ω .
- Connect an electronic counter to the terminated output of the Model 3311A as shown in Figure 5-8. Alternately measure the periods of the positive and negative portions of the waveform and adjust A1R23 until these periods are equal.

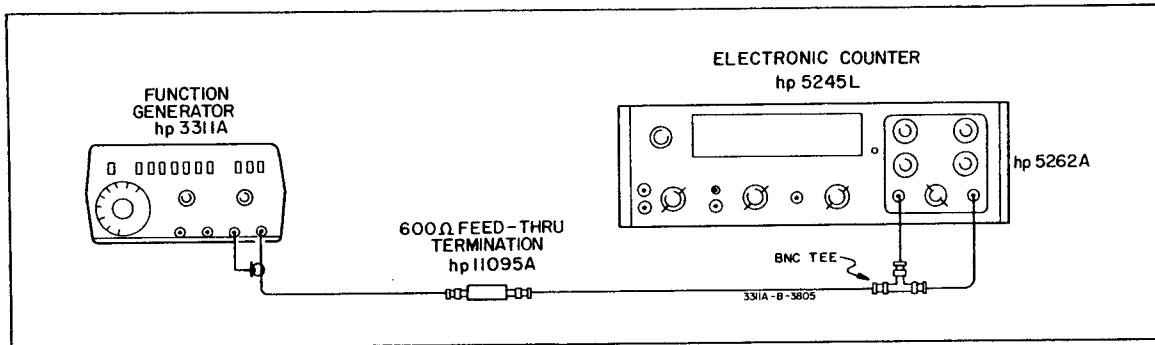

Figure 5-8. Symmetry Adjustment.

d. Calculate the symmetry error: It should not exceed 2% as determined by the following formula.

$$E_s (\%) = \frac{T_1 - T_2}{T_1 + T_2} \times 100$$

Where:

T_1 = period of positive portion of waveform.
 T_2 = period of negative portion of waveform.

5-25. Frequency Dial Calibration.

DESCRIPTION:

This adjustment sets the frequency dial accuracy of the Model 3311A.

RECOMMENDED TEST EQUIPMENT:

Electronic Counter, -hp- Model 5245L/5262L

PROCEDURE:

- a. High End Accuracy (10 Hz RANGE).
 1. Select the 10 Hz RANGE, and sine FUNCTION on the Model 3311A.
 2. Connect an electronic counter to the 3311A output and set its controls to measure period.
 3. Set the frequency dial to 10 and adjust A1R133 for a period of 10.00 msec.
- b. Low End Accuracy (10 Hz RANGE).
 1. Set the frequency dial to 1 (10 Hz RANGE) and adjust A1R131 for a period of 100.00 msec.
 2. Repeat steps a and b until both extremes are as accurate as possible. The accuracy at both ends of the dial must be 5% of full scale, i.e. 10 ms \pm .5 ms (high end), 100 ms \pm 5 ms (low end).

c. Dial Linearity

Check frequency accuracy at the dial settings shown in Table 5-4. If the periods measured at these settings are not within tolerance repeat steps a through c. Adjust the tolerances in steps a and b to the high or low end as required to get the settings within the limits listed in Table 5-4.

Table 5-4. Dial Linearity.

Dial Setting	3	5	8
Measured Period(ms)	28.6 to 40.0	18.2 to 22.2	11.75 to 13.30

d. Low End Accuracy (100 kHz RANGE).

1. Set the electronic counter to measure frequency and select the 100 kHz RANGE of the Model 3311A.
2. Set the frequency dial to 1 and adjust A1C6 to 100 kHz. *The frequency must be within \pm 5 kHz of 100 kHz.*

e. High End Accuracy (100 kHz RANGE).

1. With the Model 3311A on the 100 kHz RANGE set the dial to 10.
2. Adjust A1C43 to 1 MHz as indicated on the counter. *The frequency must be within \pm 50 kHz of 1 MHz.*

5-26. Sine Wave Distortion Adjustment.

DESCRIPTION:

This adjustment minimizes the distortion associated with the sine wave generated by the Model 3311A.

RECOMMENDED TEST EQUIPMENT:

Distortion Analyzer, -hp- Model 333A/334A
Feed-Thru Termination (600 Ω), -hp- 11095A

PROCEDURE:

- a. Select the 1 kHz RANGE of the Model 3311A and set the frequency dial to 10.
- b. Terminate the 3311A output in 600 Ω and select sine FUNCTION.
- c. Set the 3311A AMPLITUDE to maximum.

- d. Connect a distortion analyzer to the terminated output of the 3311A and tune it to the output frequency.

NOTE

The output voltage of the 3311A should be monitored while making the adjustments in step e. Resistor A1R149 can cause the voltage to fall below 10 V p-p. The resistors must be adjusted in such a way as to prevent the output from falling below 10 V p-p (3.53 V rms).

- e. Set the distortion analyzer to measure distortion and adjust A1R149, A1R163, and A1R165 for minimum distortion. Reset each adjustment as necessary to obtain absolute minimum distortion. Maximum allowable distortion is > 30.0 dB below the fundamental.

PERFORMANCE TEST CARD

Hewlett-Packard Model 3311A
FUNCTION GENERATOR

Tests performed by _____

Serial Number _____

Date _____

Paragraph Number	Test	Reading			
		Minimum	Actual	Maximum	
5-9	Sine Wave Amplitude Flatness	.1 Hz to 100 kHz	_____	$V_{dev} \times .015$	
		100 kHz to 1 MHz	_____	$V_{dev} \times .030$	
5-10	Square Wave Time Axis Symmetry Error	-2%	_____	+2%	
5-11	Pulse Duty Cycle	.135	_____	.165	
5-12	Dial Accuracy	X.1 RANGE { 1 5 10	6670 ms 1820 ms 950 ms	_____ _____ _____	20000 ms 2220 ms 1050 ms
		X 1 RANGE { 1 5 10	667 ms 182 ms 96 ms	_____ _____ _____	2000 ms 222 ms 105 ms
		X10 RANGE { 1 5 10	66.7 ms 18.2 ms 9.5 ms	_____ _____ _____	200 ms 22.2 ms 10.5 ms
		X100 RANGE { 1 5 10	50 Hz 450 Hz 950 Hz	_____ _____ _____	150 Hz 550 Hz 1050 Hz
		X1K RANGE { 1 5 10	500 Hz 4500 Hz 9500 Hz	_____ _____ _____	1500 Hz 5500 Hz 10.5 kHz
		X10K RANGE { 1 5 10	5 kHz 45 kHz 95 kHz	_____ _____ _____	15 kHz 55 kHz 105 kHz
		X100K RANGE { 1 5 10	50 kHz 450 kHz 950 kHz	_____ _____ _____	150 kHz 550 kHz 1050 kHz
5-13	Sine Wave Distortion	≥ 30 dB Below Fundamental	_____		
5-14	Square Wave and Pulse Response	{ sq. wave pulse	_____ _____	100 ns 25 ns	
5-15	Output Impedance	2.84 V	_____	3.16 V	

5-12

Paragraph Number	Test	Reading		
		Minimum	Actual	Maximum
5-16	Maximum Signal Output and Amplitude Range } terminated open circuit	3.53 V rms 7 V rms .0316 X maximum voltage	_____ _____ _____	
5-17	Pulse Output Amplitude	3 V	_____	
5-18	DC Offset } terminated open circuit	≤ 5 V ≤ 10 V	_____ _____	≥ + 5 V ≥ + 10 V
5-19	VCO Requirement: Range Input Requirement	> 10:1	_____ _____	- 10 V ± 2 V
5-20	Triangle Linearity			
		Voltage		
	Positive Slope	- 9.00	Relative zero	Relative zero
		- 7.00	.495	.505
		- 5.00	.989	1.009
		- 3.00	1.484	1.514
		- 1.00	1.979	2.019
		+ 1.00	2.473	2.523
		+ 3.00	2.968	3.028
		+ 5.00	3.462	3.532
		+ 7.00	3.957	4.037
		+ 9.00	4.452	4.542
		Voltage		
	Negative Slope	+ 9.00	Relative zero	Relative zero
		+ 7.00	.493	.503
		+ 5.00	.986	1.006
		+ 3.00	1.479	1.509
		+ 1.00	1.197	2.011
		- 1.00	2.464	2.514
		- 3.00	2.957	3.017
		- 5.00	3.450	3.520
		- 7.00	3.943	4.023
		- 9.00	4.436	4.526

SECTION VI REPLACEABLE PARTS

6-1. INTRODUCTION.

6-2. This section contains information for ordering replaceable parts. Table 6-1 lists parts in alphabetic order of their reference designators and indicates the description, -hp- Part Number of each part, together with any applicable notes, and provides the following:

- a. Total quantity used in the instrument (Qty column). The total quantity of a part is given the first time the part number appears.
- b. Description of the part. (See list of abbreviations below.)
- c. Typical manufacturer of the part in a five-digit code. (See Appendix A for list of manufacturers.)
- d. Manufacturers part number.

6-3. Miscellaneous parts are listed at the end of Table 6-1.

6-4. ORDERING INFORMATION.

6-5. To obtain replacement parts, address order or inquiry to your local Hewlett-Packard Field Office. (See Appendix B for list of office locations.) Identify parts by their Hewlett-Packard part numbers. Include instrument model and serial numbers.

6-6. NON-LISTED PARTS.

- 6-7. To obtain a part that is not listed, include:
- a. Instrument model number.
 - b. Instrument serial number.
 - c. Description of the part.
 - d. Function and location of the part.

6-8. PARTS CHANGES.

6-9. Components which have been changed are so marked by one of three symbols; i.e. Δ , Δ with a letter subscript, e.g. Δ_a , or Δ with a number subscript e.g. Δ_{10} . A Δ with no subscript indicates the component listed is the preferred replacement for an earlier component. A Δ with a letter subscript indicates a change which is explained in a note at the bottom of the page. A Δ with a number subscript indicates the related change is discussed in backdating (Section 8). The number of the subscript indicates the number of the change in backdating which should be referred to.

6-10. PROPRIETARY PARTS.

6-11. Items marked by a dagger (\dagger) in the reference designator column are available only for repair and service of Hewlett-Packard instruments.

ABBREVIATIONS					
Ag	silver	Hz	hertz (cycles per second)	NPO	negative positive zero (zero temperature coefficient)
Al	aluminum	ID	inside diameter	ns	nanosecond(s) = 10 ⁻⁹ seconds
A	ampere(s)	imp	impregnated	ns†	not separately replaceable
Au	gold	ins	incandescent		
C	capacitor	ins	insulation(ect)	Ω	ohm(s)
cer	ceramic	k Ω	kilohm(s) = 10 ³ ohms	obd	order by description
coef	coefficient	kHz	kilohertz = 10 ³ hertz	OD	outside diameter
com	common			p	peak
comp	composition	L	inductor	pA	picoampere(s)
conn	connection	lin	linear taper	pc	printed circuit
dep	deposited	log	logarithmic taper	pF	picofarad(s) 10 ⁻¹² farads
DPDT	double-pole double-throw	mA	milliampere(s) = 10 ⁻³ amperes	pV	peak inverse voltage
DPT	double-pole single-throw	MHz	megahertz = 10 ⁶ hertz	p/o	part of
elec	electrolytic	M Ω	megohm(s) = 10 ⁶ ohms	pos	position(s)
encap	encapsulated	met film	metal film	poly	polystyrene
F	farad(s)	mfr	manufacturer	pot	potentiometer
FET	field effect transistor	ms	millisecond	p-p	peak-to-peak
fxd	fixed	mtg	mounting	p/pm	parts per million
		mV	millivolt(s) = 10 ⁻³ volts	prec	precision (temperature coefficient, long term stability and/or tolerance)
		μ F	microfarad(s)	R	resistor
GAAs	gallium arsenide	μ s	microsecond(s)	Rh	rhodium
GHz	gigahertz = 10 ⁹ hertz	μ V	microvolt(s) = 10 ⁻⁶ volts	rms	root-mean-square
gd	guard(ect)	mv	Mylar [®]	rot	rotary
Gnd	germanium	nA	nanoampere(s) = 10 ⁻⁹ amperes	Se	selenium
grd	ground(ed)	NC	normally closed	sect	section(s)
H	henry(ies)	Ne	neon	Sl	silicon
Hg	mercury	NO	normally open		

DECIMAL MULTIPLIERS					
Prefix	Symbols	Multiplier	Prefix	Symbols	Multiplier
tera	T	10 ¹²	centi	c	10 ⁻²
giga	G	10 ⁹	milli	m	10 ⁻³
mega	M or Meg	10 ⁶	micro	μ	10 ⁻⁶
kilo	K or k	10 ³	nano	n	10 ⁻⁹
hecto	h	10 ²	pico	p	10 ⁻¹²
deka	da	10	fermi	f	10 ⁻¹⁵
deci	d	10 ⁻¹	atto	a	10 ⁻¹⁸

DESIGNATORS			
A	assembly	FL	filter
B	motor	HR	heater
BT	battery	IC	integrated circuit
C	capacitor	J	jack
CR	diode	K	relay
DL	delay line	L	inductor
DS	lamp	M	meter
E	misc electronic part	MP	mechanical part
F	fuss	P	plug
Q	transistor	QCR	transistor-diode
R	resistor	R	resistor
RT	thermistor	S	switch
T	transformer	T	transformer
TB	terminal board	TC	thermocouple
TP	test point	TS	terminal strip
U	microcircuit	U	microcircuit
V	vacuum tube, neon bulb, photocell, etc.	V	vacuum tube, neon bulb, photocell, etc.
W	cable	W	cable
X	socket	X	socket
XDS	lampholder	XDS	lampholder
XF	fuseholder	XF	fuseholder
Y	crystal	Y	crystal
Z	network	Z	network

STD-B-2734

Table 6-1. Replaceable Parts

Reference Designation	HP Part Number	Qty	Description	Mfr Code	Mfr Part Number
A1	03311-66501	1	PC ASSY:MAIN	28480	03311-66501
A1C1	0160-0554	2	CAPACITOR (5 UF PART OF C1 AND C23 MATCHED SET)	28480	0160-0554
A1C3	0160-0174	1	C:FXD CER 0.47 UF +80% -20% 25 VDCW	56289	5C1187S-CML
A1C5	0150-0093	15	C:FXD CER 0.01 UF +80-20% 100VDCW	72982	801-K800011
A1C6	0121-0481	1	C:VAR 16-150 PF	28480	0121-0481
A1C7	0140-0200	1	C:FXD MICA 390 PF 5%	72136	RD15F391-J3C
A1C8	0150-0093	1	C:FXD CER 0.01 UF +80-20% 100VDCW	72982	801-K800011
A1C9	0150-0022	1	C:FXD TI 3.3 PF 10% 500VDCW	78488	GA
A1C10	0160-3333	4	C:FXD CER 5000 PF 20% 250MVAC	28480	0160-3333
A1C11	0150-0093	1	C:FXD CER 0.01 UF +80-20% 100VDCW	72982	801-K800011
A1C13	0150-0093	1	C:FXD CER 0.01 UF +80-20% 100VDCW	72982	801-K800011
A1C15	0150-0093	1	C:FXD CER 0.01 UF +80-20% 100VDCW	72982	801-K800011
A1C17	0150-0093	1	C:FXD CER 0.01 UF +80-20% 100VDCW	72982	801-K800011
A1C19	0160-2202	1	C:FXD MICA 75 PF 5%	28480	0160-2202
A1C21	0150-0093	1	C:FXD CER 0.01 UF +80-20% 100VDCW	72982	801-K800011
A1C23	0160-0554	1	CAPACITOR SET (0.0045 UF P/O C1 & C23 MATCHED SET)	28480	0160-0554
A1C25	0140-0204	1	C:FXD MICA 47 PF 5% NPO 500VDCW	14655	RD15E470J5C
A1C27	0150-0093	1	C:FXD CER 0.01 UF +80-20% 100VDCW	72982	801-K800011
A1C29	0150-0093	1	C:FXD CER 0.01 UF +80-20% 100VDCW	72982	801-K800011
A1C31	0150-0093	1	C:FXD CER 0.01 UF +80-20% 100VDCW	72982	801-K800011
A1C33	0150-0093	1	C:FXD CER 0.01 UF +80-20% 100VDCW	72982	801-K800011
A1C35	0150-0093	1	C:FXD CER 0.01 UF +80-20% 100VDCW	72982	801-K800011
A1C37	0150-0093	1	C:FXD CER 0.01 UF +80-20% 100VDCW	72982	801-K800011
A1C39	0160-2204	2	C:FXD MICA 100PF 5%	72136	RD15F101J3C
A1C41	0160-2204	1	C:FXD MICA 100PF 5%	72136	RD15F101J3C
A1C43	0121-0046	4	C:VARI CER 9-35 PF	28480	0121-0046
A1C45	0150-0093	1	C:FXD CER 0.01 UF +80-20% 100VDCW	72982	801-K800011
A1C46	0140-0145	1	C:FXD MICA 22 PF 5%	28480	0140-0145
A1C47	0150-0093	1	C:FXD CER 0.01 UF +80-20% 100VDCW	72982	801-K800011
A1C49	0160-3333	1	C:FXD CER 5000 PF 20% 250MVAC	28480	0160-3333
A1C51	0150-0096	2	C:FXD CER 0.05 UF +80-20% 100VDCW	91418	TA
A1C53	0150-0096	2	C:FXD CER 0.05 UF +80-20% 100VDCW	91418	TA
A1C54 Δa	0180-0547	2	C:FXD ELECT 200 UF 50VDCW	28480	0180-0547
A1C56 Δa	0180-0547	15	C:FXD ELECT 200 UF 50VDCW	28480	0180-0547
A1CR1 Δ b	1901-0518	1	DIODE:HOT CARRIER	28480	1901-0518
A1CR2	1901-0040	1	DIODE:SILICON 50 MA 30 MV	07263	FDG1088
A1CR3 Δ b	1901-0518	1	DIODE:HOT CARRIER	28480	1901-0518
A1CR4	1901-0040	1	DIODE:SILICON 50 MA 30 MV	07263	FDG1088
A1CR5 Δ b	1901-0518	1	DIODE:HOT CARRIER	28480	1901-0518
A1CR6 Δ	1902-0049	2	DIODE:BREAKDOWN 6.19V 5%	04713	SZ10939-122
A1CR9 Δ b	1901-0518	1	DIODE:HOT CARRIER	28480	1901-0518
A1CR11	1902-3183	1	DIODE:BREAKDOWN 12.1V 2% 400MW	28480	1902-3183
A1CR13	1901-0040	1	DIODE:SILICON 50 MA 30 MV	07263	FDG1088
A1CR15	1901-0040	1	DIODE:SILICON 50 MA 30 MV	07263	FDG1088
A1CR17	1901-0040	1	DIODE:SILICON 50 MA 30 MV	07263	FDG1088
A1CR19	1901-0040	1	DIODE:SILICON 50 MA 30 MV	07263	FDG1088
A1CR21	1901-0040	1	DIODE:SILICON 50 MA 30 MV	07263	FDG1088
A1CR23	1901-0040	1	DIODE:SILICON 50 MA 30 MV	07263	FDG1088
A1CR25	1901-0040	1	DIODE:SILICON 50 MA 30 MV	07263	FDG1088
A1CR27	1902-0057	2	DIODE BREAKDOWN:6.49V	28480	1902-0057
A1CR29	1902-0057	2	DIODE BREAKDOWN:6.49V	28480	1902-0057
A1CR31	1901-0045	10	DIODE:SILICON 0.75A 100PIV	04713	SR1358-7
A1CR33	1902-0594	2	DIODE BREAKDOWN:18.2V 5% 1W	04713	SZ11213-215
A1CR35	1901-0045	1	DIODE:SILICON 0.75A 100PIV	04713	SR1358-7
A1CR37	1902-0594	1	DIODE BREAKDOWN:18.2V 5% 1W	04713	SZ11213-215
A1CR39	1910-0016	6	DIODE:GE 60 MIV	28480	1910-0016
A1CR41	1910-0016	6	DIODE:GE 60 MIV	28480	1910-0016
A1CR43	1910-0016	6	DIODE:GE 60 MIV	28480	1910-0016
A1CR45	1910-0016	6	DIODE:GE 60 MIV	28480	1910-0016
A1CR47	1910-0016	6	DIODE:GE 60 MIV	28480	1910-0016
A1CR49	1910-0016	6	DIODE:GE 60 MIV	28480	1910-0016
A1CR51	1902-3190	1	DIODE BREAKDOWN:13.0V 5% 400 MW	28480	1902-3190
A1CR53	1902-3062	1	DIODE BREAKDOWN:3.92V 5% 400 MW	28480	1902-3062
A1CR55	1901-0025	2	DIODE:SILICON 100MA/1V	07263	FD 2387
A1CR57	1901-0025	2	DIODE:SILICON 100MA/1V	07263	FD 2387
A1CR59	1901-0040	1	DIODE:SILICON 50 MA 30 MV	07263	FDG1088
A1CR61	1901-0040	1	DIODE:SILICON 50 MA 30 MV	07263	FDG1088
A1CR63	1902-0049	1	DIODE:BREAKDOWN 6.19V 5%	04713	SZ10939-122
A1CR65	1901-0045	1	DIODE:SILICON 0.75A 100PIV	04713	SR1358-7
A1CR67	1901-0045	1	DIODE:SILICON 0.75A 100PIV	04713	SR1358-7
A1CR69	1901-0045	1	DIODE:SILICON 0.75A 100PIV	04713	SR1358-7
A1CR71	1901-0045	1	DIODE:SILICON 0.75A 100PIV	04713	SR1358-7
A1CR73	1901-0045	1	DIODE:SILICON 0.75A 100PIV	04713	SR1358-7

Δa The value of this capacitor may be either 200 μF or 220 μF

Δ Use for all replacement.

6-2

Δ Use for all replacement. Replace CR1, 3, 5 & 9 together

See introduction to this section for ordering information

Table 6-1. Replaceable Parts(Cont'd)

Reference Designation	HP Part Number	Qty	Description	Mfr Code	Mfr Part Number
A1CR75	1901-0045		DIODE:SILICON 0.75A 100PIV	04713	SR1358-7
A1CR77	1901-0045		DIODE:SILICON 0.75A 100PIV	04713	SR1358-7
A1CR79	1901-0045		DIODE:SILICON 0.75A 100PIV	04713	SR1358-7
A1CR81	1901-0033	1	DIODE:SILICON 100MA 180WV	07263	FD3369
A1Q1	1854-0071	3	TSTR:SI NPN(SELECTED FROM 2N3704)	28480	1854-0071
A1Q3	1854-0071		TSTR:SI NPN(SELECTED FROM 2N3704)	28480	1854-0071
A1Q5	1854-0409	1	TSTR:SI NPN	80131	2N5210
A1Q9	1853-0086	2	TSTR:SI PNP	80131	2N5087
A1Q11	1853-0086		TSTR:SI PNP	80131	2N5087
A1Q13	1855-0081	1	TSTR:SI FET	80131	2N5245
A1Q15	1853-0020	6	TSTR:SI PNP(SELECTED FROM 2N3702)	28480	1853-0020
A1Q17	1853-0020		TSTR:SI PNP(SELECTED FROM 2N3702)	28480	1853-0020
A1Q19	1853-0020		TSTR:SI PNP(SELECTED FROM 2N3702)	28480	1853-0020
A1Q21	1854-0215	5	TSTR:SI NPN	80131	2N3904
A1Q23	1853-0020		TSTR:SI PNP(SELECTED FROM 2N3702)	28480	1853-0020
A1Q25	1854-0215		TSTR:SI NPN	80131	2N3904
A1Q27	1854-0215		TSTR:SI NPN	80131	2N3904
A1Q29	1853-0020		TSTR:SI PNP(SELECTED FROM 2N3702)	28480	1853-0020
A1Q31	1853-0020		TSTR:SI PNP(SELECTED FROM 2N3702)	28480	1853-0020
A1Q33	1854-0215		TSTR:SI NPN	80131	2N3904
A1Q35	1854-0215		TSTR:SI NPN	80131	2N3904
A1Q37	1854-0071		TSTR:SI NPN(SELECTED FROM 2N3704)	28480	1854-0071
A1R1	0698-8395	2	R:FXD FLM 50K OHM 0.1% 1/4W	28480	0698-8395
A1R3	0698-8394	2	R:FXD FLM 5K OHM 0.1% 1/2W	28480	0698-8394
A1R5	0698-8394		R:FXD FLM 5K OHM 0.1% 1/2W	28480	0698-8394
A1P7	0684-1011	5	R:FXD COMP 100 OHM 10% 1/4W	01121	CB 1011
A1R8	0684-1001	2	R:FXD COMP 10 OHM 10% 1/4W	01121	CB 1001
A1R9	0684-1821	2	R:FXD COMP 1800 OHM 10% 1/4W	01121	CB 1821
A1R11	0757-0283	5	R:FXD MET FLM 2.00K OHM 1% 1/8W	28480	0757-0283
A1R12	0757-0472	1	R:FXD MET FLM 45.3 K OHM 1% 1/8W	28480	0757-0472
A1R13	0698-4495	1	R:FXD MET FLM 200 K OHM 1% 1/8W	28480	0698-4495
A1R15	0698-4434	2	R:FXD FLM 2.32K OHM 1% 1/8W	28480	0698-4434
A1R17	0698-8396	2	R:FXD FLM 500K OHM 0.1% 1/4W	28480	0698-8396
A1R19	0698-8396		R:FXD FLM 500K OHM 0.1% 1/4W	28480	0698-8396
A1R21	0698-8395		R:FXD FLM 50K OHM 0.1% 1/4W	28480	0698-8395
A1R23	2100-3210	2	R:VAR CER 10K OHM 10% LIN 1/2W	28480	2100-3210
A1R25	0684-0271	1	R:FXD COMP 2.7 OHM 10% 1/4W	01121	CB 27G1
A1R27	0698-8062	1	R:FXD COMP 4.7 OHM 10% 1/4W	01121	CB47G1
A1R29	0698-5102	1	R:FXD COMP 1.2 MEGOHM 10% 1/4W	01121	CB 1251
A1R31 Δ	0686-1525	1	R:FXD COMP 1500 OHM 5% 1/2W	01121	EB 1525
A1R33	0698-4480	1	R:FXD MET FLM 15.8K OHM 1% 1/8W	28480	0698-4480
A1R35	0698-7514	3	R:FXD COMP 15 OHM 10% 1/4W	01121	CB 15G1
A1R37	0757-0415	1	R:FXD MET FLM 475 OHM 1% 1/8W	28480	0757-0415
A1R39	0757-0442	1	R:FXD MET FLM 10.0K OHM 1% 1/8W	28480	0757-0442
A1R41	0684-1011		R:FXD COMP 100 OHM 10% 1/4W	01121	CB 1011
A1R43	0757-0401	2	R:FXD MET FLM 100 OHM 1% 1/8W	28480	0757-0401
A1R45	0757-0410	2	R:FXD MET FLM 301 OHM 1% 1/8W	28480	0757-0410
A1R47	0698-3136	2	R:FXD MET FLM 17.8K OHM 1% 1/8W	28480	0698-3136
A1R49	0757-0410		R:FXD MET FLM 301 OHM 1% 1/8W	28480	0757-0410
A1R51	0757-0277	1	R:FXD MET FLM 49.9 OHM 1% 1/8W	28480	0757-0277
A1R53	0684-1011		R:FXD COMP 100 OHM 10% 1/4W	01121	CB 1011
A1R55	0684-1011		R:FXD COMP 100 OHM 10% 1/4W	01121	CB 1011
A1R57	0757-0200	1	R:FXD MET FLM 5.62K OHM 1% 1/8W	28480	0757-0200
A1R59	0757-0288	2	R:FXD MET FLM 9.09K OHM 1% 1/8W	28480	0757-0288
A1R60	0698-8063	2	R:FXD FLM 1K OHM 0.1% 1/2W	28480	0698-8063
A1R61	0757-0465	2	R:FXD MET FLM 100K OHM 1% 1/8W	28480	0757-0465
A1R63	0757-0465		R:FXD MET FLM 100K OHM 1% 1/8W	28480	0757-0465
A1R65	0684-3341	1	R:FXD COMP 330K OHM 10% 1/4W	01121	CB 33G1
A1R66	0698-8063		R:FXD FLM 1K OHM 0.1% 1/2W	28480	0698-8063
A1R67	0757-0283		R:FXD MET FLM 2.00K OHM 1% 1/8W	28480	0757-0283
A1R69	0684-8221	1	R:FXD COMP 8200 OHM 10% 1/4W	01121	CB 8221
A1R71	0684-3311	1	R:FXD COMP 330 OHM 10% 1/4W	01121	CB 3311
A1R73	0757-0280	5	R:FXD MET FLM 1K OHM 1% 1/8W	28480	0757-0280
A1R75	0757-0280		R:FXD MET FLM 1K OHM 1% 1/8W	28480	0757-0280
A1R77	0684-1521	1	R:FXD COMP 1500 OHM 10% 1/4W	01121	CB 1521
A1R79	0757-0283		R:FXD MET FLM 2.00K OHM 1% 1/8W	28480	0757-0283
A1R81	0687-2221	1	R:FXD COMP 2200 OHM 10% 1/2W	01121	EB 2221
A1R83	2100-3211	2	R:VAR CER 1K OHM 10% LIN 1/2W	28480	2100-3211
A1R85	0684-5115	2	R:FXD COMP 510 OHM 5% 1/2W	01121	EB 5115
A1R87	0684-2201	2	R:FXD COMP 22 OHM 10% 1/4W	01121	CB 2201
A1R89	0684-2201		R:FXD COMP 22 OHM 10% 1/4W	01121	CB 2201
A1R91	0686-5115		R:FXD COMP 510 OHM 5% 1/2W	01121	EB 5115
A1R93	0684-1011		R:FXD COMP 100 OHM 10% 1/4W	01121	CB 1011
A1R95	0698-3264	2	R:FXD FLM 11.8K OHM 1% 1/8W	28480	0698-3264
A1R97	0698-3279	2	R:FXD MET FLM 4990 OHM 1% 1/8W	28480	0698-3279
A1R99	0698-3279		R:FXD MET FLM 4990 OHM 1% 1/8W	28480	0698-3279

Δ Use for all replacement

See introduction to this section for ordering information

Table 6-1. Replaceable Parts(Cont'd)

Reference Designation	HP Part Number	Qty	Description	Mfr Code	Mfr Part Number
A1R101	0757-0412	2	R:FXD MET FLM 365 OHM 1% 1/8W	28480	0757-0412
A1R103	0698-3264		R:FXD FLM 11.8K OHM 1% 1/8W	28480	0698-3264
A1R105	0684-1221	1	R:FXD COMP 1.2K OHM 10% 1/4W	01121	CB 1221
A1R107	0698-4307	1	R:FXD FLM 14.3K OHM 1% 1/8W	28480	0698-4307
A1R109	0757-0280		R:FXD MET FLM 1K OHM 1% 1/8W	28480	0757-0280
A1R111	0687-6811	1	R:FXD COMP 680 OHM 10% 1/2W	01121	EB 6811
A1R113	0684-1821		R:FXD COMP 1800 OHM 10% 1/4W	01121	CB 1821
A1R115	0757-0401		R:FXD MET FLM 100 OHM 1% 1/8W	28480	0757-0401
A1R117	0684-2731	2	R:FXD COMP 27K OHM 10% 1/4W	01121	CB 2731
A1R119	0684-2731		R:FXD COMP 27K OHM 10% 1/4W	01121	CB 2731
A1R121	0757-0280		R:FXD MET FLM 1K OHM 1% 1/8W	28480	0757-0280
A1R123	0757-0412		R:FXD MET FLM 365 OHM 1% 1/8W	28480	0757-0412
A1R125	0698-4434		R:FXD FLM 2.32K OHM 1% 1/8W	28480	0698-4434
A1R127	0698-4423	1	R:FXD FLM 1.37K OHM 1% 1/8W	28480	0698-4423
A1R129	0757-0416	1	R:FXD MET FLM 511 OHM 1% 1/8W	28480	0757-0416
A1R131	2100-3211		R:VAR CER 1K OHM 10% LIN 1/2W	28480	2100-3211
A1R133	2100-3210		R:VAR CER 10K OHM 10% LIN 1/2W	28480	2100-3210
A1R135	0757-0288		R:FXD MET FLM 9.09K OHM 1% 1/8W	28480	0757-0288
A1R137	0757-0430	1	R:FXD MET FLM 2.21K OHM 1% 1/8W	28480	0757-0430
A1R139	0687-1521	1	R:FXD COMP 1500 OHM 10% 1/2W	01121	EB 1521
A1R141	0757-0283		R:FXD MET FLM 2.00K OHM 1% 1/8W	28480	0757-0283
A1R143	0757-0283		R:FXD MET FLM 2.00K OHM 1% 1/8W	28480	0757-0283
A1R145	0687-2211	1	R:FXD COMP 220 OHM 10% 1/2W	01121	EB 2211
A1R147	0698-3136		R:FXD MET FLM 17.8K OHM 1% 1/8W	28480	0698-3136
A1R149	2100-3252	1	R:VAR CERMET 5K OHM 10% TYPE H 1/2W	28480	2100-3252
A1R151	0698-7514		R:FXD COMP 15 OHM 10% 1/4W	01121	CB 1561
A1R153	0684-3321	2	R:FXD COMP 3300 OHM 10% 1/4W	01121	CB 3321
A1R155	0757-0280		R:FXD MET FLM 1K OHM 1% 1/8W	28480	0757-0280
A1R157	0698-7514		R:FXD COMP 15 OHM 10% 1/4W	01121	CB 1561
A1R159	0684-3321		R:FXD COMP 3300 OHM 10% 1/4W	01121	CB 3321
A1R163	2100-3212	2	R:VAR CER 200 OHM 10% LIN 1/2W	28480	2100-3212
A1R165	2100-3212		R:VAR CER 200 OHM 10% LIN 1/2W	28480	2100-3212
A1R167	0684-1001		R:FXD COMP 10 OHM 10% 1/4W	01121	CB 1001
A1S1	3101-1814	1	SWITCH: PUSHBUTTON ASSY	28480	3101-1814
			INCLUDES:		
	3101-1720	1	SWITCH: LINE PUSH-PUSH	28480	3101-1720
	3101-0600	1	SWITCH: X1 RANGE 2-POLE	28480	3101-0600
	3101-0600	1	SWITCH: X10 RANGE 2-POLE	28480	3101-0600
	3101-0611	1	SWITCH: X100 RANGE 4-POLE	28480	3101-0611
	3101-0611	1	SWITCH: X1K RANGE 4-POLE	28480	3101-0611
	3101-0611	1	SWITCH: X10K RANGE 4-POLE	28480	3101-0611
	3101-0611	1	SWITCH: X100K RANGE 4-POLE	28480	3101-0611
	3101-0600	1	SWITCH: FUNCTION 2-POLE	28480	3101-0600
	3101-0600	1	SWITCH: FUNCTION 2-POLE	28480	3101-0600
	3101-0600	1	SWITCH: FUNCTION 2-POLE	28480	3101-0600
A1U1	1820-0054	1	IC: TTL QUAD 2-INPUT NAND GATE	01295	SN7400N
A1U3	1820-0321	2	IC: HI-SPEED COMPARATOR	01295	SN72 710L
A1U5	1826-0066	1	IC: LIN. OP. AMPL. 25K OHM	07263	U58777312
A1U7	1820-0321		IC: HI-SPEED COMPARATOR	01295	SN72 710L
A1U9	1826-0126	2	IC: VOLTAGE REGULATOR	01295	LM309
A1U11	1826-0126		IC: VOLTAGE REGULATOR	01295	LM309
A1XA1	1200-0424	1	SOCKET: IC BLK 14 CONTACT	23880	CSA2800-148

See introduction to this section for ordering information

Table 6-1. Replaceable Parts(Cont'd)

Reference Designation	HP Part Number	Qty	Description	Mfr Code	Mfr Part Number
CHASSIS MOUNTED COMPONENTS					
C1	0160-3333		C:FXD CER 5000 PF 20% 250WVAC	28480	0160-3333
C2	0160-3333		C:FXD CER 5000 PF 20% 250WVAC	28480	0160-3333
F1	2110-0318	1	FUSE:0.125 AMP SLOW-BLOW	71400	MDL 108
J4	1251-2357	1	SOCKET:3-PIN MALE POWER RECEPTACLE	82389	EAC-301
R2	2100- 0350 3400	1	R:VAR 10K OHM 10%	28480	2100-3348
R4	0686-1035	1	R:FXD COMP 10K OHM 5% 1/2W	01121	EB 1035
R6	2100-0546	1	R:VAR COMP 2K OHM 10% 10 CW LOG	01121	WA4G040S202AA
RB	2100-2488	1	R:VAR COMP 10K OHM 20% LIN 1/2W	28480	2100-2488
R10	0698-8434	1	R:FXD FLM 600 OHM 1.0% 1/2W	28480	0698-8434
S2	3101-1609	1	SWITCH:SLIDE 2-DPDT	82389	11E-1036
T1	9100-3300	1	TRANSFORMER, POWER	28480	9100-3300
W1	8120-1348	1	CABLE ASSY: POWER, DETACHABLE	70803	KHS-7041
XF1	2110-0359	1	FUSEHOLDER: EXTRACTOR POST TYPE	28480	2110-0359
MISCELLANEOUS PARTS					
	03311-00201	1	PANEL:FRONT	28480	03311-00201
	03311-02001	1	CASE:TOP	28480	03311-02001
	03311-60202	1	PANEL ASSY:REAR	28480	03311-60202
	03311-90001	1	MANUAL (LOOSE LEAF PAGES ONLY)	28480	03311-90001
	0340-0732	12	INSULATOR:BINDING POST, JADE GRAY	28480	0340-0732
	0340-0782	2	INSULATOR:TRANSISTOR (FOR U9 AND U11)	28480	0340-0782
	0370-0914	11	BEZEL:PUSHBUTTON KNOB, JADE GREY	28480	0370-0914
	0370-1005	2	KNOB:JADE GREY	28480	0370-1005
	0370-2488	11	KNOB:PUSHBUTTON, JADE GRAY	28480	
	03311-67401	1	KNOB	28480	03311-67401
	5020-8315	1	CASE	28480	5020-8315
	05300-40004	8	GUIDE:SLIDE	28480	05300-40004
	05301-40001	1	FOOT	28480	05301-40001
	1460-1357	1	STAND:TILT	28480	1460-1357
	1510-0084	6	BINDING POST	28480	1510-0084
	2950-0131	1	NUT:HEX NYLON, BLACK	00000	0BD
	5040-6000	1	CATCH:LEFT SIDE	28480	5040-6000
	5040-7001	1	CATCH:RIGHT SIDE	28480	5040-7001
	5040-7032	1	FOOT	28480	5040-7032
	7122-0058	1	PLATE:SERIAL	28480	7122-0058
	03311-00202	1	PANEL:REAR	28480	03311-00202
	1460-1311	1	SPRING:GROUND	00000	0BD
	1800-0429	1	SLIDE LOCK SAFETY BRACKET	28480	1800-0429
	0590-0025	1	BRACKET LOCK NUT	28480	0590-0025
	2360-0119	1	BRACKET SCREW	00000	0BD

See introduction to this section for ordering information

REFERENCE DESIGNATIONS

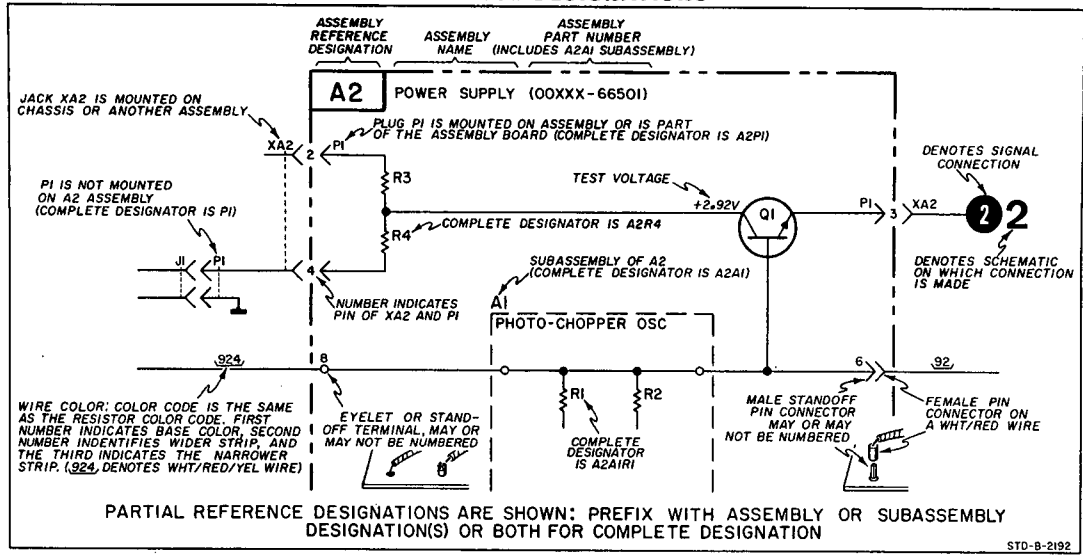

SECTION VII

CIRCUIT DIAGRAMS

7-1. INTRODUCTION.

7-2. This section of the Operating and Service Manual contains troubleshooting information and circuit diagrams for the Model 3311A Function Generator.

7-3. TROUBLESHOOTING.

7-4. This troubleshooting procedure contains: (1) a method of localizing the malfunction to a particular section of the Model 3311A and (2) troubleshooting trees which pinpoint the specific circuit or source of the trouble.

7-5. To localize the trouble to a particular section of the instrument select the symptom (a-e listed in Paragraph 7-9) which defines how your instrument is operating. Then, using the waveforms and voltages given in the schematic diagram for that section, localize the trouble. If more specific help is required, use the troubleshooting trees.

7-6. Troubleshooting Trees.

7-7. Table 7-1 lists the troubleshooting trees for the Model 3311A.

Table 7-1. Troubleshooting Trees.

Figure	Troubleshooting Tree
7-1	No. 1, Sine, Square, or Triangle Function Defective
7-2	No. 2, Pulse Defective
7-3	No. 3, Power Supplies Defective

7-8. Localizing the Malfunction Using Front Panel Checks.

7-9. While monitoring the 600 Ω OUTPUT, check each function and frequency range. Also check the PULSE

OUTPUT. Note the defective functions and/or frequency ranges. From the list below (steps a through e) select the symptoms your instrument exhibits. Go to the schematic indicated and isolate the trouble using waveforms and voltages shown there.

a. 600 Ω OUTPUT sine, square, and triangle functions defective but pulse output is correct—troubleshoot the output amplifier (Schematic No. 1).

b. 600 Ω OUTPUT sine function defective but triangle, square and pulse outputs correct—troubleshoot the sine shaper (Schematic No. 1).

c. PULSE OUTPUT function defective but 600 Ω OUTPUT square wave correct—troubleshoot the pulse generator (Schematic No. 1).











d. If outputs are present on all functions but frequency is incorrect—troubleshoot the tuning amplifier and integrator (Schematic No. 1).

e. If no output exists check the power supply voltage (Schematic No. 2). If the power supply voltages are good the malfunction could exist in the tuning amplifier, integrator, triangle amplifier or square wave generator. It may be necessary to use the troubleshooting trees to localize this type of problem.

NOTE

After the bottom cover of the instrument has been removed check for burned or loose components or any other condition which might be the source of trouble.

GENERAL SCHEMATIC NOTES

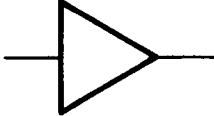
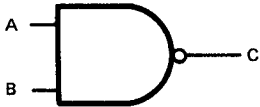
1. PARTIAL REFERENCE DESIGNATIONS ARE SHOWN. PREFIX WITH ASSEMBLY OR SUBASSEMBLY DESIGNATION(S) OR BOTH FOR COMPLETE DESIGNATION.
2. COMPONENT VALUES ARE SHOWN AS FOLLOWS UNLESS OTHERWISE NOTED:
 RESISTANCE IN OHMS
 CAPACITANCE IN MICROFARADS
 INDUCTANCE IN MILLIHENRYS
3.  DENOTES EARTH GROUND. USED FOR TERMINALS WITH NO LESS THAN A NO. 18 GAUGE WIRE CONNECTED BETWEEN TERMINAL AND EARTH GROUND TERMINAL OR AC POWER RECEPTACLE.
4.  DENOTES FRAME GROUND. USED FOR TERMINALS WHICH ARE PERMANENTLY CONNECTED WITHIN APPROXIMATELY 0.1 OHM OF EARTH GROUND.
5.  DENOTES GROUND ON PRINTED CIRCUIT ASSEMBLY.
6.  ANY LETTER OR NUMBER NEAR TRIANGLE IS A SPECIAL GROUND.
7.  DENOTES ASSEMBLY.
8.  DENOTES MAIN SIGNAL PATH.
9.  DENOTES FEEDBACK PATH.
10.  DENOTES FRONT PANEL MARKING.
11.  DENOTES REAR PANEL MARKING.
12.  DENOTES SCREWDRIVER ADJUST.
13. * AVERAGE VALUE SHOWN, OPTIMUM VALUE SELECTED AT FACTORY. THE VALUE OF THESE COMPONENTS MAY VARY FROM ONE INSTRUMENT TO ANOTHER. THE METHOD OF SELECTING THESE COMPONENTS IS DESCRIBED IN SECTION V OF THIS MANUAL.
14.  DENOTES SECOND APPEARANCE OF A CONNECTOR PIN.
15. 924 DENOTES WIRE COLOR: COLOR CODE SAME AS RESISTOR COLOR CODE. FIRST NUMBER IDENTIFIES BASE COLOR, SECOND NUMBER IDENTIFIES WIDER STRIP, THIRD NUMBER IDENTIFIES NARROWER STRIP. (e.g. 924 = WHITE, RED, YELLOW.)
16. WAVEFORMS AND AC VOLTAGE MEASUREMENTS WERE MADE WITH RESPECT TO CHASSIS GROUND USING AN OSCILLOSCOPE WITH A 10:1 DIVIDER PROBE (10 MEGOHM, 10 pF). THE VOLTAGE LEVELS SHOWN ON THE WAVEFORMS ARE ACTUAL VOLTAGE LEVELS AND ARE NOT TO BE CONFUSED WITH OSCILLOSCOPE SETTING. THE VOLTAGE LEVELS SHOWN ARE NOMINAL AND MAY VARY FROM ONE INSTRUMENT TO ANOTHER. A VARIATION OF ± 10% IN MEASUREMENTS SHOULD BE ALLOWED.
17. DC VOLTAGE LEVELS WERE MEASURED WITH RESPECT TO CIRCUIT GROUND USING A VTVM WITH 10 MEGOHM INPUT IMPEDANCE. THE VOLTAGE LEVELS SHOWN ARE NOMINAL AND MAY VARY FROM ONE INSTRUMENT TO ANOTHER DUE TO CHANGE IN TRANSISTOR CHARACTERISTICS. A VARIATION OF ± 10% SHOULD BE ALLOWED.
18. DENOTES AMPLIFIER

19. DENOTES NAND GATE

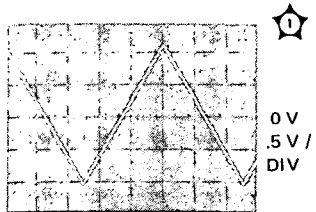
A	B	C
0	0	1
0	1	1
1	0	1
1	1	0

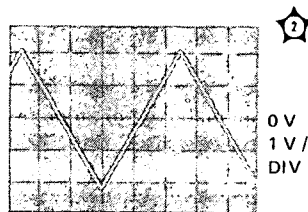

2 ms/DIV



2 ms/DIV

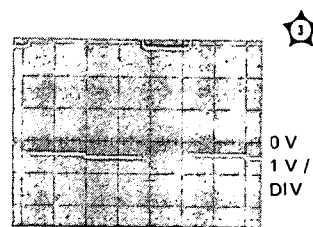

2 ms/DIV

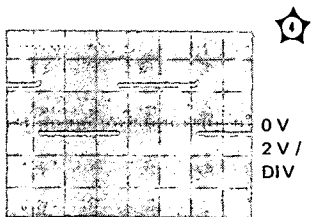

2 ms/DIV

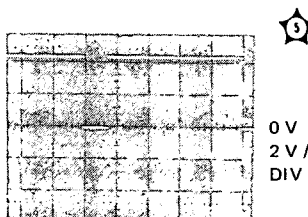

2 ms/DIV

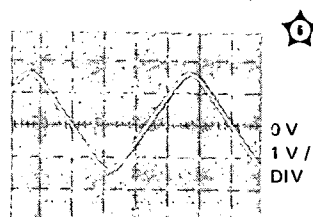

2 ms/DIV

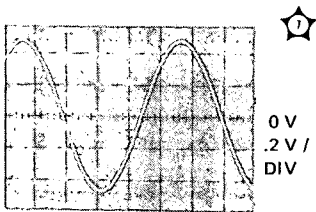

2 ms/DIV

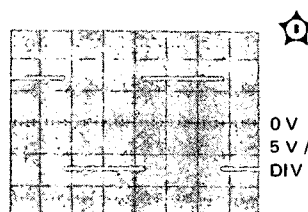

2 ms/DIV

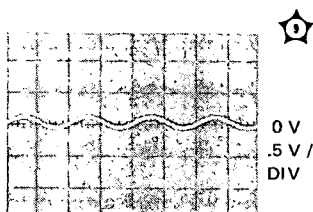

.05 V/DIV
AC COUPLED

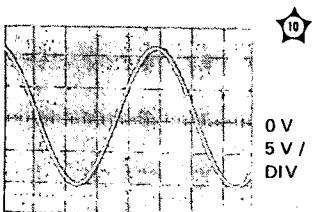

2 ms/DIV

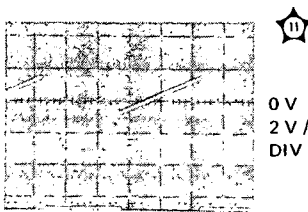

2 ms/DIV

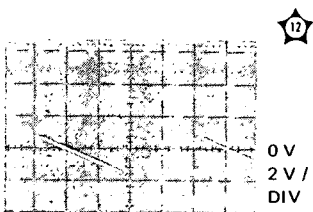

2 ms/DIV

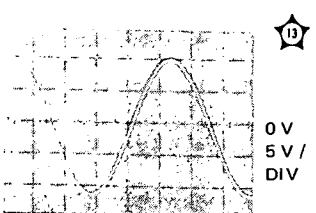

2 ms/DIV

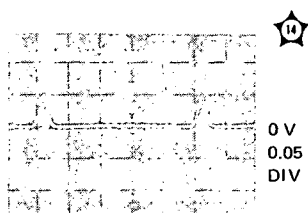

2 ms/DIV
AC COUPLED

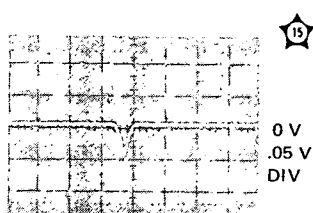

2 ms/DIV
AC COUPLED

3311A-A-3233

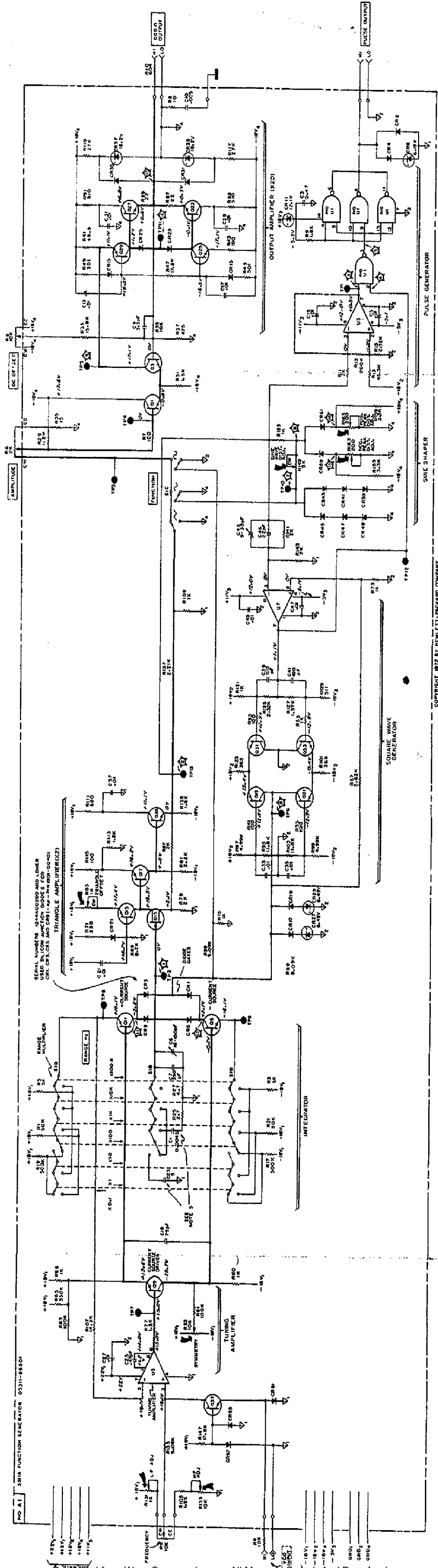

COPYRIGHT © 1972 BY HUNTLEIGH-INGRAM COMPANY

NOTES

1. DC VOLTAGES AND WAVEFORMS WERE OBSERVED WITH THE MODEL 331A CONTROLS SET AS FOLLOWS:
 FREQUENCY DIAL 1
 RANGE MULTIPLIER X100
 FUNCTION P.W. CW
 AMPLITUDE UNTERMINATED
 DC OFFSET 0
2. A MODEL JAGA DIGITAL VOLTMETER WAS USED FOR ALL AC AND DC VOLTAGE MEASUREMENTS.
3. AN AN MODEL 18A OSCILLOSCOPE WITH A 10:1 DIVIDER PROBE WAS USED FOR WAVEFORM MEASUREMENTS. THE WAVEFORMS SHOWN ADJACENT TO EACH WAVEFORM INDICATE THE ACTUAL VALUE OF THE WAVEFORM AS MEASURED BY THE OSCILLOSCOPE. THE 10:1 PROBE USED WITH THE OSCILLOSCOPE HAS ALREADY BEEN TAKEN INTO CONSIDERATION.
4. ALL AC AND DC VOLTAGES SHOWN ON THE SCHEMATIC ARE ± 1% UNLESS OTHERWISE NOTED.

Figure 7-5. Function Generator Circuit Diagram (p/o A1). 7-11/7-12

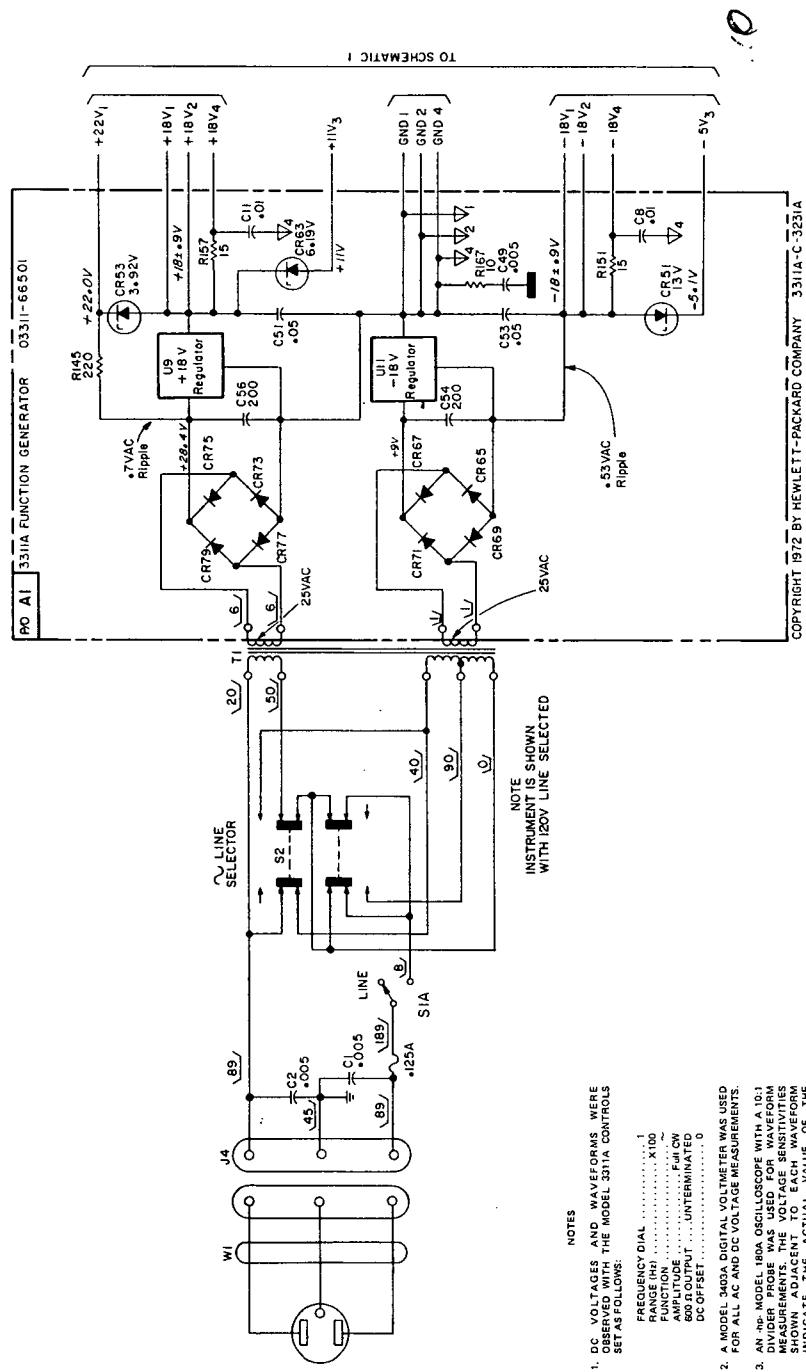

Figure 7-6. Power Supply Circuit Diagram (p/o A1).

Free Manuals Download Website

<http://myh66.com>

<http://usermanuals.us>

<http://www.somanuals.com>

<http://www.4manuals.cc>

<http://www.manual-lib.com>

<http://www.404manual.com>

<http://www.luxmanual.com>

<http://aubethermostatmanual.com>

Golf course search by state

<http://golfingnear.com>

Email search by domain

<http://emailbydomain.com>

Auto manuals search

<http://auto.somanuals.com>

TV manuals search

<http://tv.somanuals.com>