

Operating and Service Guide

Agilent Technologies E-Series E9300 Power Sensors



Agilent Technologies

**Agilent Technologies Part no. E9300-90016
January 1999**

© Copyright 1999 Agilent Technologies

All rights reserved. Reproduction, adaptation, or translation without prior written permission is prohibited, except as allowed under the copyright laws.

Printed in the USA.

Legal Information

Notice

The information contained in this document is subject to change without notice. Agilent Technologies makes no warranty of any kind with regard to this material, including but not limited to, the implied warranties of merchantability and fitness for a particular purpose. Agilent Technologies shall not be liable for errors contained herein or for incidental or consequential damages in connection with the furnishing, performance, or use of this material.

Certification

Agilent Technologies certifies that this product met its published specifications at the time of shipment from the factory. Agilent Technologies further certifies that its calibration measurements are traceable to the United States National Institute of Standards and Technology, to the extent allowed by the Institute's calibration facility, and to the calibration facilities of other International Standards Organization members.

Warranty

This Agilent Technologies instrument product is warranted against defects in material and workmanship for a period of one year from date of shipment. During the warranty period, Agilent Technologies will at its option, either repair or replace products which prove to be defective. For warranty service or repair, this product must be returned to a service facility designated by Agilent Technologies. Buyer shall prepay shipping charges to Agilent Technologies and Agilent Technologies shall pay shipping charges, duties, and taxes for products returned to Agilent Technologies from another country. Agilent Technologies warrants that its software and firmware designated by Agilent Technologies for use with an instrument will execute its programming instructions when properly installed on that instrument. Agilent Technologies does not warrant that the operation of the instrument, or firmware will be uninterrupted or error free.

Legal Information

Limitation of Warranty

The foregoing warranty shall not apply to defects resulting from improper or inadequate maintenance by Buyer, Buyer-supplied software or interfacing, unauthorized modification or misuse, operation outside of the environmental specifications for the product, or improper site preparation or maintenance. NO OTHER WARRANTY IS EXPRESSED OR IMPLIED. AGILENT TECHNOLOGIES SPECIFICALLY DISCLAIMS THE IMPLIED WARRANTIES OF MERCHANTABILITY AND FITNESS FOR A PARTICULAR PURPOSE.

Exclusive Remedies

THE REMEDIES PROVIDED HEREIN ARE BUYER'S SOLE AND EXCLUSIVE REMEDIES. AGILENT TECHNOLOGIES SHALL NOT BE LIABLE FOR ANY DIRECT, INDIRECT, SPECIAL, INCIDENTAL, OR CONSEQUENTIAL DAMAGES, WHETHER BASED ON CONTRACT, TORT, OR ANY OTHER LEGAL THEORY.

General Safety Information

The following general safety precautions must be observed during all phases of operation, service and repair of this sensor. Failure to comply with these precautions or specific warnings elsewhere in this manual violates safety standards of design manufacture and intended use of the sensor. Agilent Technologies assumes no liability for the customer's failure to comply with these requirements.



The Instruction Documentation Symbol. The product is marked with this symbol when it is necessary for the user to refer to the instructions in the supplied documentation.

WARNING

BEFORE CONNECTING THE POWER SENSOR TO OTHER INSTRUMENTS ensure that all instruments are connected to the protective (earth) ground. Any interruption of the protective earth grounding will cause a potential shock hazard that could result in personal injury.

Sound Emission

Herstellerbescheinigung

Diese Information steht im Zusammenhang mit den Anforderungen der Maschinenlarminformationsverordnung vom 18 Januar 1991.

- Sound Pressure LpA < 70 dB.
- Am Arbeitsplatz.
- Normaler Betrieb.
- Nach DIN 45635 T. 19 (Typprüfung).

Manufacturers Declaration

This statement is provided to comply with the requirements of the German Sound DIN 45635 T. 19 (Typprüfung).

- Sound Pressure LpA < 70 dB.
- At operator position.
- Normal operation.
- According to ISO 7779 (Type Test).

General Safety Information

Conventions

The following text and format conventions are used to highlight items of safety and the operation of the associated power meter.

Safety

This guide uses cautions and warnings to denote hazards.

Caution

Caution denotes a hazard. It calls attention to a procedure that, if not correctly performed or adhered to, would result in damage to or destruction of the instrument. Do not proceed beyond a caution sign until the indicated conditions are fully understood and met.

WARNING

Warning denotes a hazard. It calls attention to a procedure which, if not correctly performed or adhered to, could result in injury or loss of life. Do not proceed beyond a warning note until the indicated conditions are fully understood and met.

Power Meter Front Panel Operation

This guide uses the following symbols to denote power meter front panel keys and display legends.

Front Panel Key

A function name in a keycap symbol indicates the use of a key physically located on the power meter's front panel.

Softkey Label

A function name in display-font indicates the use of a key down the right side of the power meter's display adjacent to the displayed text

Display Text

Text shown in this font indicates message text displayed by the power meter.

Documentation

Sensors Covered by Manual

These sensors have a two-part serial number: the prefix (two letters and the first four numbers), and the suffix (the last four numbers). The two letters identify the country in which the unit was manufactured. The four numbers of the prefix are a code identifying the date of the last major design change incorporated in your sensor. The four-digit suffix is a sequential number and, coupled with the prefix, provides a unique identification for each unit produced. The contents of this manual apply directly to all serial numbers unless otherwise indicated.

Related Publications

The *Agilent E-Series E9300 Power Sensors Operating and Service Guide* is also available in the following languages:

- English Language *Operating and Service Guide* - Standard
- German Language *Operating and Service Guide* - Option ABD
- Spanish Language *Operating and Service Guide* - Option ABE
- French Language *Operating and Service Guide* - Option ABF
- Japanese Language *Operating and Service Guide* - Option ABJ
- Italian Language *Operating and Service Guide* - Option ABZ
- Korean Language *Operating and Service Guide* - Option AB1

Further useful information can be found in:

- *Application Note 64-1B, Fundamentals of RF and Microwave Power Measurements*, available by ordering through your local Agilent Technologies Sales Office.
- The Agilent EPM Series Power Meter *User's Guide* and *Programming Guide*.

Documentation

Table of Contents

	Page
Legal Information.....	3
Notice	3
Certification.....	3
Warranty	3
Limitation of Warranty.....	4
Exclusive Remedies	4
General Safety Information	5
Sound Emission	5
Conventions.....	6
Safety.....	6
Power Meter Front Panel Operation.....	6
Documentation.....	7
Sensors Covered by Manual	7
Related Publications.....	7
Introduction	11
General Information	13
Power Meter Requirements.....	13
The Agilent E-Series E9300 Power Sensors in Detail.....	14
Getting Started	16
Initial Inspection.....	16
Checking Power Meter Firmware and DSP Revision	16
Interconnections and Calibration.....	17
Specifications.....	18
Making Measurements	19
Power Meter Configuration Changes	21
Measuring Spread Spectrum and Multitone Signals.....	22
CDMA Signal Measurements.....	23
Multitone Signal Measurements.....	24
Measuring TDMA Signals.....	25
Power Meter and Sensor Operation	25
Achieving Stable Results with TDMA Signals.....	25
Achieving Stable Results with GSM Signals.....	26

Electromagnetic Compatibility (EMC) Measurements	27
Measurement Accuracy and Speed	28
Setting the Range	28
Measurement Considerations	29
Accuracy	29
Speed and Averaging	30
Summary	30
Specifications and Characteristics	31
Introduction	32
E9300/1/4/A Power Sensor Specifications.....	33
Switching Point	39
Calibration Factor and Reflection Coefficient	41
E9300/1B and H Power Sensor Specifications	44
Switching Point	51
Service	59
General Information.....	60
Cleaning.....	60
Connector Cleaning	60
Performance Test	61
Standing Wave Ratio (SWR) and Reflection Coefficient (Rho) Per- formance Test.....	61
Replaceable Parts.....	63
Service	67
Principles of Operation	67
Troubleshooting	68
Repair of Defective Sensor	68
Disassembly Procedure	68
Reassembly Procedure	69
Sales and Service Offices	70

Introduction

What You'll Find In This Chapter

This Chapter introduces you to the HP E-series E9300 power sensors, some detail on their operation, the minimum power meter requirements and connecting to your power meter. It contains the following sections:

- “General Information” on page 13
- “The Agilent E-Series E9300 Power Sensors in Detail” on page 14
- “Getting Started” on page 16



Figure 1 Typical HP E-series E9300 power sensors.

General Information

Welcome to the HP E-series E9300 power sensors *Operating and Service Guide!* This guide contains information about the initial inspection, operation, specifications and repair of the HP E-series E9300 power sensors. Use this guide as a supplement to the Agilent EPM series power meters *User's Guides*. It is 3-hole drilled to allow you to retain it in the power meter's binder.

All power meter functions are detailed in the Agilent EPM series power meters *User's Guide* and *Programming Guide*, however, this guide contains information specific to the operation of Agilent E-series E9300 power sensor.

Power Meter Requirements

The HP E-series E9300 power sensors are NOT compatible with the earlier HP 430-Series, HP E1416A, or HP 70100A power meters. They are compatible ONLY with the Agilent EPM series power meters. Also, not all Agilent EPM series power meters are immediately compatible - your power meter must use firmware and Digital Signal Processing (DSP) code from a specific release onwards. see Checking Power Meter Firmware and DSP Revision on page 16 tells you how to check your power meter and have it upgraded if required.

The Agilent E-Series E9300 Power Sensors in Detail

Most power sensors used for measuring average power employ either thermocouple or diode technologies. Diode based sensors frequently rely on the application of correction factors to extend their dynamic range beyond their square law response region, typically -70 dBm to -20 dBm. However, while this technique achieves wide dynamic range capability, it is limited to continuous wave (CW) signals outside the square law region. Modulated signals must be padded down or at low levels, with their average and peak power levels within the diode square law region, to be measured accurately. Accurate, average power measurement of high level signals carrying modulation cannot be obtained using a CW correction factor technique. Specialized modulation sensors provide accurate measurements but are bandwidth limited.

The HP E-series E9300 power sensors are true average, wide dynamic range RF microwave power sensors. They are based on a dual sensor diode pair/attenuator/diode pair proposed by Szente et. al. in 1990¹. Figure 2 shows a block diagram of this technique.

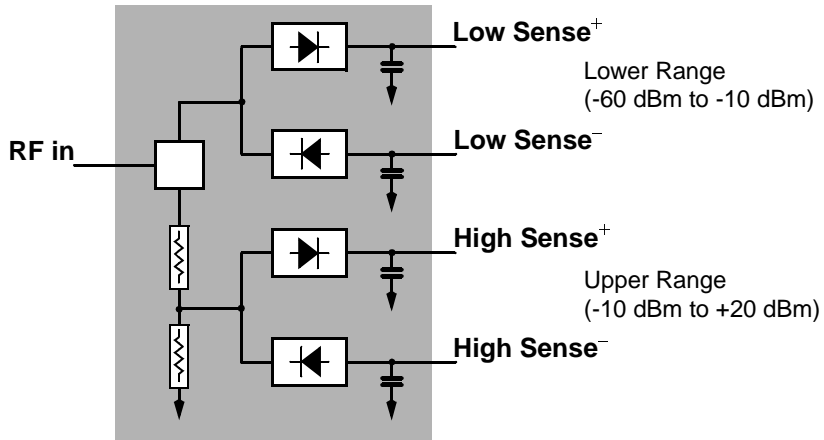

Figure 2 Simplified Block Diagram of Diode Pair/Attenuator/Diode Pair

This technique ensures the diodes in the selected signal path are kept in their square law region, thus the output current (and voltage) is proportional to the input power. The diode pair/attenuator/diode pair assembly can yield the

1. US Patent #4943764, assigned to Agilent Technologies

average of complex modulation formats across a wide dynamic range, irrespective of signal bandwidth. The dual range Modified Barrier Integrated Diode (MBID)¹ package includes further refinements to improve power handling allowing accurate measurement of high level signals with high crest factors without incurring damage² to the sensor.

These sensors measure average RF power on a wide variety of modulated signals and are independent of the modulation bandwidth. They are ideally suited to the average power measurement of multi-tone and spread spectrum signals such as CDMA, W-CDMA and digital television formats. Also, pulsed, TDMA signals can be measured within the constraints detailed in “Measuring TDMA Signals” on page 25.

The results are displayed on a compatible³ power meter in logarithmic (dBm or dB) or linear (Watts or %) measurement units.

1. November 1986 Hewlett-Packard Journal pages 14-2, “Diode Integrated Circuits for Millimeter-Wave Applications.

2. Refer “Maximum Power” on page 35 and page -47 to for maximum power handling specifications

3. An Agilent EPM-Series power meter is required as specified in the section see Checking Power Meter Firmware and DSP Revision on page 16.

Getting Started

Initial Inspection

Inspect the shipping container for damage. If the shipping container or packaging material is damaged, it should be kept until the contents of the shipment have been checked mechanically and electrically. If there is mechanical damage, notify the nearest Agilent Technologies office. Keep the damaged shipping materials (if any) for inspection by the carrier and a Agilent Technologies representative. If required, you can find a list of Agilent Technologies Sales and Service offices on page -70.

Checking Power Meter Firmware and DSP Revision

Before proceeding, first ensure your Agilent EPM series power meter has both the required firmware and DSP revisions for the correct operation of your Agilent EPM series power meters.

On the power meter press **System Inputs**, **More**, **Service**, **Version**.

LCL		Version
Model Number:	E4419B	Edit Serial Number
Serial Number:	GB0123456789	
Main F/W Rev:	A2.04.00	Firmware Revision Code (dual channel)
Main F/W Date:	Dec 11 1998 14:48	
Bootrom Rev:	A.02.00	
Proc. Bd. Version:	C	
System Version:	2	Done
	ChA ChB	
DSP Revision:	A.01.11 A.01.11	
Gate Array Rev:	A.01.03 A.01.03	

DSP Revision Code

Figure 3 Power Meter Firmware Version Screen

First check the section labelled **DSP Revision:**. Release A.01.11 or later is required. If your power meter has an earlier release, please contact your nearest Service Office (listed on page -70) to arrange an upgrade.

Next check the section labelled **Main F/W Rev.:** Release A1.04.00 or later is required for single channel meters; release A2.04.00 or later is required for dual channel meters. For E9300 power sensors with suffix 'B' or 'H', firmware revision A1.06.00 or later is required for single channel meters; revision A2.06.00 or later is required for dual channel meters. If your power meter has an earlier release, please contact your nearest Agilent Service Office (listed on page -70) to arrange an upgrade.

Note	You can carry out the firmware upgrade yourself if your power meter has the required. Access http://www.agilent.com/find/powermeters and click on the link: “EPM Series E4418B Single-Channel Power Meter” or “EPM Series E4419B Dual-Channel Power Meter” . Click the “Software, Firmware and Drivers” link and follow the downloading instructions.
-------------	--

Interconnections and Calibration

Connect one end of an Agilent 11730 series sensor cable to the Agilent E-series E9300 power sensor and connect the other end of the cable to the power meter's channel input. Allow a few seconds for the power meter to download the power sensor's calibration table.

Caution	The Agilent 9304A Sensor is DC coupled. DC voltages in excess of the maximum value (5 Vdc) can damage the sensing diode.
----------------	--

Note	Ensure power sensors and cables are attached and removed in an indoor environment.
-------------	--

To carry out a zero and calibration cycle as requested by the power meter proceed as follows:

- Ensure the Agilent E-series E9300 power sensor is disconnected from any signal source.
- When calibrating Agilent E-series E9300B or E9301B sensors, first remove the attenuator.

Getting Started

- On the power meter, press $\left(\begin{smallmatrix} \text{Zero} \\ \text{Cal} \end{smallmatrix}\right)$, **Zero** (or **Zero A** / **Zero B**). During zeroing the wait symbol is displayed.
- When the wait period is complete connect the Agilent E-series power sensor to the power meter's POWER REF output.
- Press **Cal** (or **Cal**, **Cal A** / **Cal B**). The wait symbol is again displayed during calibration.

On completion the power meter and sensor are ready to connect to the device under test (DUT). Ensure the attenuator is re-connected to the Agilent E-series E9300B or E9301B sensors prior to making measurements.

Caution

The Agilent E-series E9300B or E9301B sensors should not be operated without the attenuator connected at any time other than for calibration. You must ensure the attenuator is reconnected following calibration.

WARNING

BEFORE CONNECTING THE POWER SENSOR TO OTHER INSTRUMENTS ensure that all instruments are connected to the protective (earth) ground. Any interruption of the protective earth grounding will cause a potential shock hazard that could result in personal injury.

The measurement connector (for connection to DUT) is Type-N (male) for all the HP E-series E9300 power sensors. A torque wrench should be used to tighten these connectors. Use a 3/4-inch open-end wrench and torque to 12 in-lb (135 Ncm) for the Type-N connector.

Specifications

The specifications listed in Chapter 3, Specifications and Characteristics, are the performance standards or limits against which the power sensor may be tested. These specifications are valid **ONLY** after proper calibration of the power meter. Refer to the “*Calibration Procedure Using Agilent E-Series Power Sensors*” in your Agilent EPM series power meter *User's Guide*.

Making Measurements

What You'll Find In This Chapter

This Chapter shows you how to use the HP E-series E9300 power sensors to make power measurements on signals with different modulation formats. For all other operations please refer to your Agilent EPM series power meter *User's Guide*.

This chapter contains the following sections:

- “Power Meter Configuration Changes” on page 21
- “Measuring Spread Spectrum and Multitone Signals” on page 22
- “Measuring TDMA Signals” on page 25
- “Electromagnetic Compatibility (EMC) Measurements” on page 27
- “Measurement Accuracy and Speed” on page 28

Power Meter Configuration Changes

The Agilent EPM series power meter recognizes when an Agilent E-series E9300 power sensor is connected. The sensor calibration data is automatically read by the power meter. In addition, the HP E-series E9300 power sensors change the auto-averaging settings used by the power meter. These are also automatically configured.

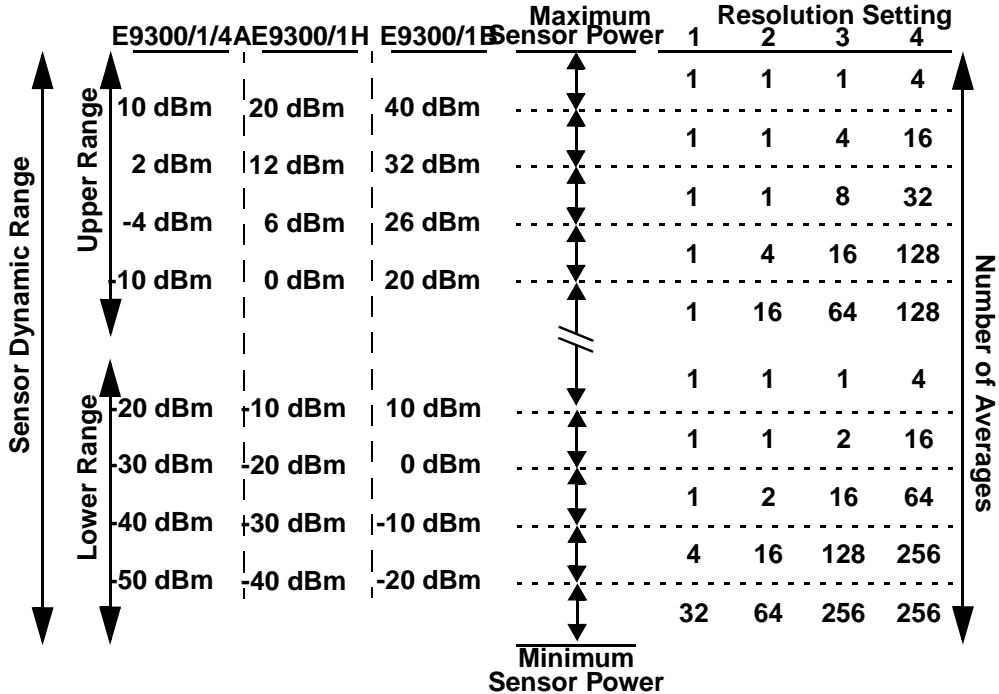

Figure 4 Auto-averaging Settings

Note

These values are valid only for the power meter channel connected to the Agilent E-series E9300 power sensor and only while the sensor is connected. Averaging settings can also be manually configured. Refer to “Achieving Stable Results with TDMA Signals” on page 25 if required.

Measuring Spread Spectrum and Multitone Signals

To achieve high data transfer rates within a given bandwidth, many transmission schemes are based around phase and amplitude (I and Q) modulation. These include CDMA, W-CDMA and digital television. These signals are characterized by their appearance on a spectrum analyzer display — a high amplitude noise-like signal of bandwidths up to 20 MHz. An 8 MHz bandwidth digital television signal is shown in Figure 5.

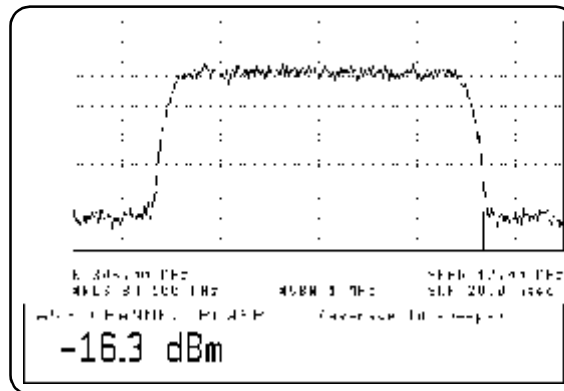

Figure 5 Spread Spectrum Signal

Prior to the HP E-series E9300 power sensors, average power measurement over a wide dynamic range of these signals required either tuned/swept signal analyzer methods or a dual channel power meter connected to power sensors, pads and a power splitter.

The diode pair/attenuator/diode pair architecture of the HP E-series E9300 power sensors is ideally suited to the average power measurement of these signals. The sensors have wide dynamic range (80 dB max, sensor dependent) and are bandwidth independent.

Some signal modulation formats such as orthogonal-frequency-division multiplexing (OFDM) and CDMA have large crest factors. The Agilent E-series E9300/1/4A power sensors can measure +20 dBm average power even in the presence of +13 dB peaks as long as the peak pulse duration is less than 10 microseconds. For high power applications, such as base-station testing the E9300/1B and E9300/1H are recommended.

CDMA Signal Measurements

Figure 6 and Figure 7 show typical results obtained when measuring a CDMA signal. In these examples, the error is determined by measuring the source at the amplitude of interest, with and without CDMA modulation, adding attenuation until the difference between the two values stops changing. The CW sensor in Figure 6 uses correction factors to correct for power levels beyond its square law operating region.

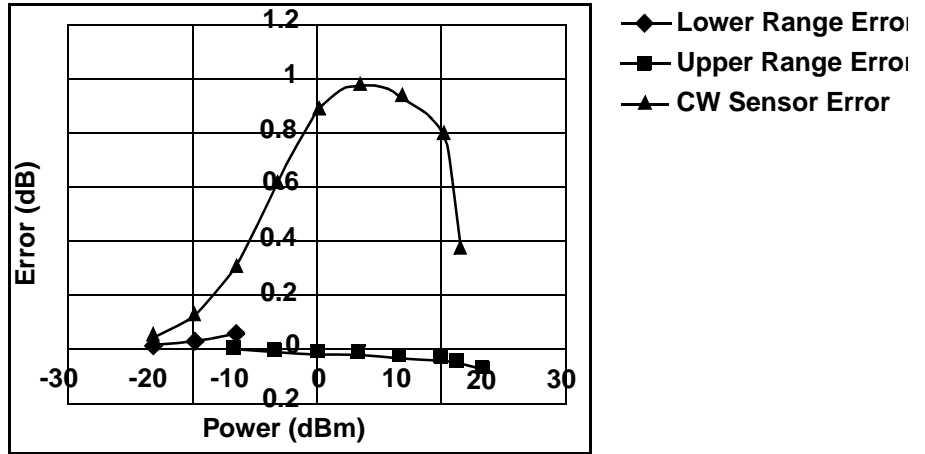

Figure 6 Wideband CDMA Error of Agilent E-series E9300 power sensor versus corrected CW sensor

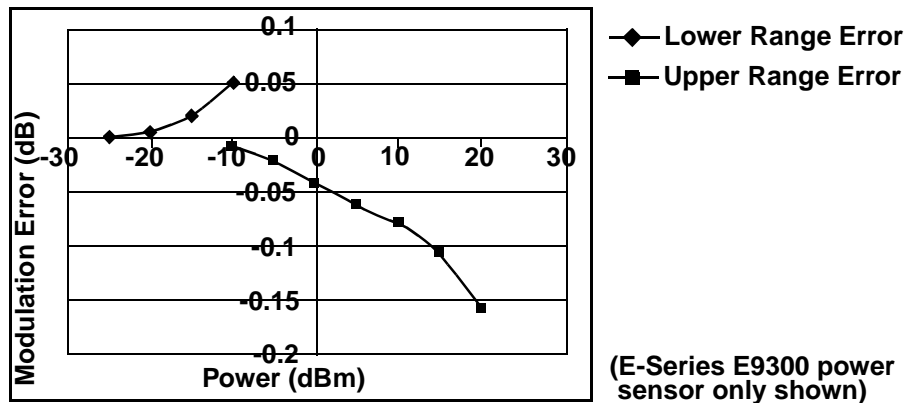

Figure 7 CDMA (IS-95A): 9Ch Fwd

Multitone Signal Measurements

In addition to wide dynamic range, the HP E-series E9300 power sensors also have an exceptionally flat calibration factor versus frequency response across the entire frequency range as shown in Figure 8. This is ideal for amplifier intermodulation distortion measurements where the components of the two-tone or multitone test signal can be separated by hundreds of MHz.

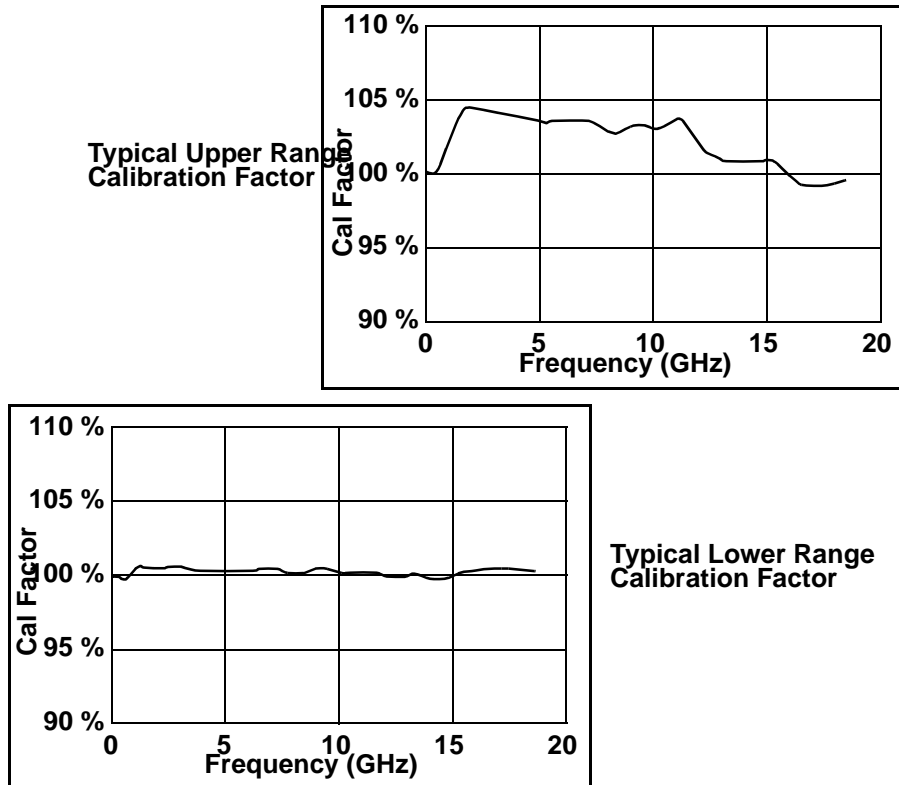
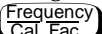

Figure 8 Calibration Factors versus Frequency

Simply select an suitable single calibration factor frequency for your measurement using the  key on the power meter.

Measuring TDMA Signals

Power Meter and Sensor Operation

The voltages generated by the diode detectors in the power sensor can be very small. Gain and signal conditioning are required to allow accurate measurement. This is achieved using a 220 Hz (440 Hz in fast mode) square wave output from the power meter to drive a chopper-amplifier in the power sensor. Digital Signal Processing (DSP) of the generated square wave is used by the power meter to recover the power sensor output and accurately calculate the power level.

The chopper-amplifier technique provides noise immunity and allows large physical distances between power sensor and power meter (Agilent 11730 series cables available up to 61 metres). Additional averaging helps reduce noise susceptibility.

Achieving Stable Results with TDMA Signals

The averaging settings in the power meter are designed to reduce noise when measuring continuous wave (CW) signals. Initial measurement of a pulsed signal may appear unstable with jitter on the less significant displayed digits. With pulsed signals the averaging period must be increased to allow measurement over many cycles of the pulsed signal.

To set the averaging proceed as follows:

Note

The example shows the key labels for a single channel power meter. Dual channel meter are similar, adding only channel identification to the softkey labels.

1. Press **System Inputs**, **Input Settings**, **More**. Press the **Filter** softkey to access the filter menu.
2. The filter setting is displayed under the **Length** softkey label. To change this setting first set manual mode by pressing the **Mode Man Auto** softkey to highlight **Man**.
3. Press **Length** and use the **↑**, **↓**, **←** or **→** to set the averaging you require. Confirm your entry by pressing **Enter**.

Measuring TDMA Signals

Note

You should also ensure the filter is not reset when a step increase or decrease in power is detected by switching the step detection off.

Switch off step detection as follows:

1. Press **System Inputs**, **Input Settings**, **More**.
2. Press the **Filter** softkey to access the filter menu.
3. Press **Step Det Off On** to highlight **Off**.

The section “Setting the Range, Resolution and Accuracy” in the Agilent EPM series power meters *Programming Guide* shows you how to configure these parameters using the remote interface

Achieving Stable Results with GSM Signals

Signals with a pulse repetition frequency (PRF) close to a multiple or sub-multiple of the 220 Hz chopper-amplifier signal generate a beat note at a frequency between the PRF and 220 Hz. Control over the filter settings is again required to obtain stable results.

The PRF of a GSM signal is approximately 217 Hz and thus requires more averaging than most other TDMA signals. To achieve a stable measurement use the filter setting procedures to set the **Length**. Experimentally, a **Length** setting of 148 gives optimum results although settings in the order of 31 or 32 give acceptable results if a faster measurement is required.

Electromagnetic Compatibility (EMC) Measurements

The low frequency range of the Agilent 9304A make it the ideal choice for making EMC measurements to CISPR (Comite International Special Perturbations Radioelectriques) requirements, and electromagnetic interference (EMI) test applications such as the radiated immunity test (IEC61000-4-3).

DC coupling of the Agilent 9304A input allows excellent low frequency coverage. However, the presence of any dc voltages mixed with the signal will have an adverse effect on the accuracy of the power measurement - see Figure 11 on Page 36.

Caution

The Agilent 9304A sensor is DC coupled. DC voltages in excess of the maximum value (5 Vdc) can damage the sensing diode.

Measurement Accuracy and Speed

The power meter has no internal ranges. The only ranges you can set are those of the HP E-series E9300 power sensors (and other HP E-series power sensors). With an Agilent E-series E9300 power sensor the range can be set either automatically or manually. Use autoranging when you are not sure of the power level you are about to measure.

Caution

To prevent damage to your sensor do not exceed the power levels specified in the section “Maximum Power” on page 35.
The Agilent 9304A sensor is DC coupled. DC voltages in excess of the maximum value (5 Vdc) can damage the sensing diode.

Setting the Range

There are two manual settings, “LOWER” and “UPPER”. The LOWER range uses the more sensitive path and the UPPER range uses the attenuated path in the HP E-series E9300 power sensors (see Table 1).

Table 1 Sensor Ranges

Sensor	LOWER range	UPPER range
E9300/1/4A	-60 dBm to -10 dBm	-10 dBm to +20 dBm
E9300/1B	-30 dBm to +20 dBm	+20 dBm to +44 dBm
E9300/1H	-50 dBm to 0 dBm	0 dBm to +30 dBm

The default is “AUTO”. In AUTO the range crossover value depends on the sensor model being used (see Table 2).

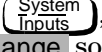

Table 2 Range Crossover Values

E9300/1/4A	E9300/1B	E9300/1H
-10 dBm \pm 0.5 dBm	+20 dBm \pm 0.5 dBm	0 dBm \pm 0.5 dBm

Configure the power meter as follows:

Note

The example shows the key labels for a single channel power meter. Dual channel meters are similar, adding channel identification to the softkey labels.

1. Press , **Input Settings**. The current setting is displayed under the **Range** softkey.
2. To change this press **Range**. A pop up window appears. Use  or  to highlight your choice.

To confirm your choice press **Enter**.

The section “Setting the Range, Resolution and Accuracy” in the Agilent EPM series power meters *Programming Guide* shows you how to configure these parameters using the remote interface

Measurement Considerations

While autoranging is a good starting point, it is not ideal for all measurements. Signal conditions such as crest factor or duty cycle may cause the power meter to select a range which is not the optimum configuration for your specific measurement needs. Signals with average power levels close to the range switch point require you to consider your needs for measurement accuracy and speed. For example, using an Agilent E9300/1/4A sensor, where the range switch point is -10 ± 0.5 dBm in a pulsed signal configured as follows:

Characteristic	Value
Peak Amplitude	-6 dBm
Duty Cycle	25 %

the calculated average power is -12 dBm.

Accuracy

The value of -12 dBm lies in the lower range of the Agilent E-series E9300 power sensor. In autoranging mode (“AUTO”) the Agilent EPM series power meter determines the average power level is below -10 dBm and selects the low power path. However, the peak amplitude of -6 dBm is beyond the specified, square law response range of the low power path diodes. The high

Measurement Accuracy and Speed

power path (-10 dBm to +20 dBm) should be used to ensure a more accurate measurement of this signal. However, range holding in “UPPER” (the high power path), for a more accurate measurement, results in considerably more filtering.

Speed and Averaging

The same signal also requires that consideration is given to measurement speed. As shown above, in autoranging mode the Agilent EPM series power meter selects the low power path in the Agilent E-series E9300 power sensor. With auto-averaging also configured, minimal filtering is applied. Values of 1 to 4 for average power levels above -20 dBm are used in the low power path. (Refer to “Auto-averaging Settings” on page 21.)

If the range is held in “UPPER” for more accuracy, the measurement is slower. More filtering is applied due to the increase in noise susceptibility at the less sensitive area of the high power path. Values of 1 to 128 for average power levels less than -10 dBm are used. (Again, refer to “Auto-averaging Settings” on page 21.) Manually lowering the filter settings speeds up the measurement but can result in an unwanted level of jitter.

Summary

Attention must be paid to signals whose average power levels are in the low power path range whilst their peaks are in the high power path range. You can achieve best accuracy by selecting the high power path or best speed by selecting the low power path.

**Specifications and
Characteristics**

Introduction

The Agilent E-series E9300 power sensors are average, wide dynamic range power sensors designed for use with the Agilent EPM series power meters.

These specifications are valid ONLY after proper calibration of the power meter and apply for continuous wave (CW) signals unless otherwise stated. Specifications apply over the temperature range 0°C to +55°C unless otherwise stated.

Specifications quoted over the temperature range 25°C ±10°C apply over 15% to 75% relative humidity and conform to the standard environmental test conditions as defined in TIA/EIA/IS-97-A and TIA/EIA/IS-98-A¹.

The Agilent E-series E9300 power sensors have two independent measurement paths (high and low power paths):

Sensor	Low Power Path	High Power Path
E9300/1/4A	-60 dBm to -10 dBm	-10 dBm to +20 dBm
E9300/1B	-30 dBm to +20 dBm	+20 dBm to +44 dBm
E9300/1H	-50 dBm to 0 dBm	0 dBm to +30 dBm

Some specifications are detailed for individual measurement path, with the automatic switching point at -10 dBm for the E9300/1/4A, 20 dBm for the E9300/1B and 0 dBm for the E9300/1H.

Supplemental characteristics, which are shown in italics, are intended to provide information useful in applying the power sensors by giving typical, but nonwarranted performance parameters. These characteristics are shown in *italics* or denoted as “*typical*”, “*nominal*” or “*approximate*”.

1. TIA is the Telecommunications Industry Association; EIA is the Electronic Industries Association.

TIA/EIA/IS-97-A is the recommended Minimum Performance Standard for Base Stations Supporting Dual-Mode Wideband Spread Spectrum Cellular Mobile Stations.

TIA/EIA/IS-98-A is the recommended Minimum Performance Standard for Dual-Mode Wideband Spread Spectrum Cellular Mobile Stations.

E9300/1/4/A Power Sensor Specifications

Frequency Range

	Frequency Range
E9300A	10 MHz to 18.0 GHz
E9301A	10 MHz to 6.0 GHz
E9304A	9 kHz to 6.0 GHz

Connector Type

Type - N (Male) 50 ohm

Maximum SWR (25°C±10°C)

	Frequency	SWR
E9300A	10 MHz to 30 MHz	1.15
	30 MHz to 2 GHz	1.13
	2 GHz to 14 GHz	1.19
	14 GHz to 16 GHz	1.22
	16 GHz to 18 GHz	1.26
E9301A	10 MHz to 30 MHz	1.15
	30 MHz to 2 GHz	1.13
	2 GHz to 6 GHz	1.19
E9304A	9 kHz to 2 GHz	1.13
	2 GHz to 6 GHz	1.19

Maximum SWR
(0°C to +55°C)

	Frequency	SWR
E9300A	10 MHz to 30 MHz	1.21
	30 MHz to 2 GHz	1.15
	2 GHz to 14 GHz	1.20
	14 GHz to 16 GHz	1.23
	16 GHz to 18 GHz	1.27
E9301A	10 MHz to 30 MHz	1.21
	30 MHz to 2 GHz	1.15
	2 GHz to 6 GHz	1.20
E9304A	9 kHz to 2 GHz	1.15
	2 GHz to 6 GHz	1.20

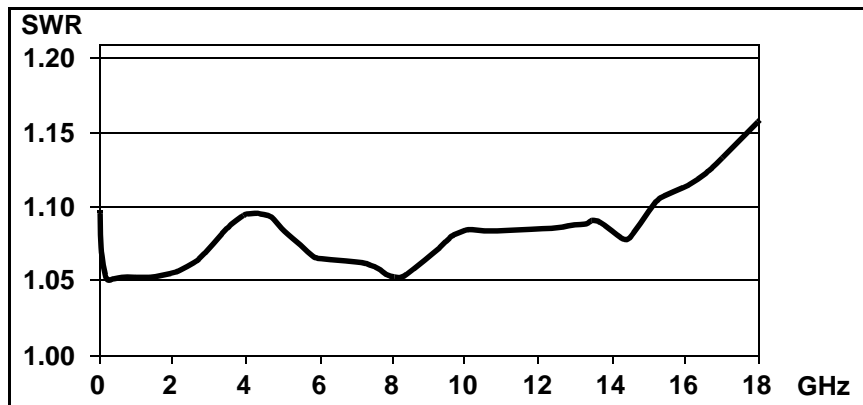

Figure 9 Typical SWR 10 MHz to 18 GHz (25°C ±10°C)

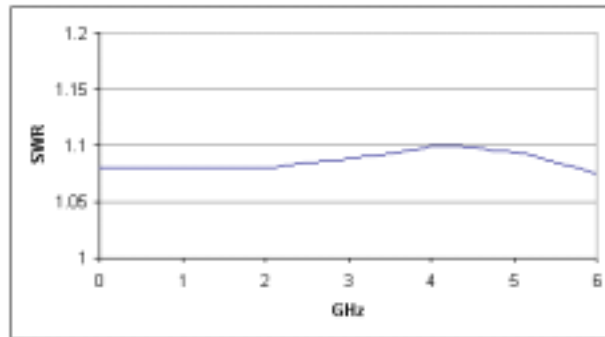

Figure 10 Typical SWR 9 kHz to 6 GHz ($25^{\circ}\text{C} \pm 10^{\circ}\text{C}$) E9304A

Maximum Power

+25 dBm (320 mW) average
 +33 dBm peak (2 W) <10 μ s

Maximum DC Voltage

The Agilent E9304A sensor is dc coupled. DC coupling of the input allows excellent low frequency coverage. However, the presence of dc voltages mixed with the signal will have an effect on the accuracy of the power measurement (see graph below).

Caution

DC voltages in excess of the maximum value (5 V) can damage the sensing diode.

Maximum dc voltage: 5 Vdc (E9304A only)

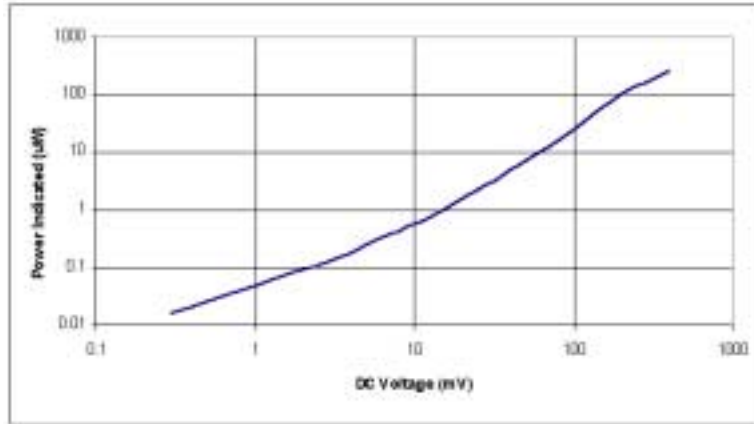

Figure 11 Typical Power Error Introduced in an Agilent E9304A power sensor by DC Voltage

Power Linearity

After Zero and Calibration at ambient environmental conditions.

Power Level	Linearity		Linearity
	25°C	10°C	0°C to 55°C
-60 dBm to -10 dBm	±3.0%		±3.5%
-10 dBm to 0 dBm	±2.5%		±3.0%
0 dBm to +20 dBm	±2.0%		±2.5%

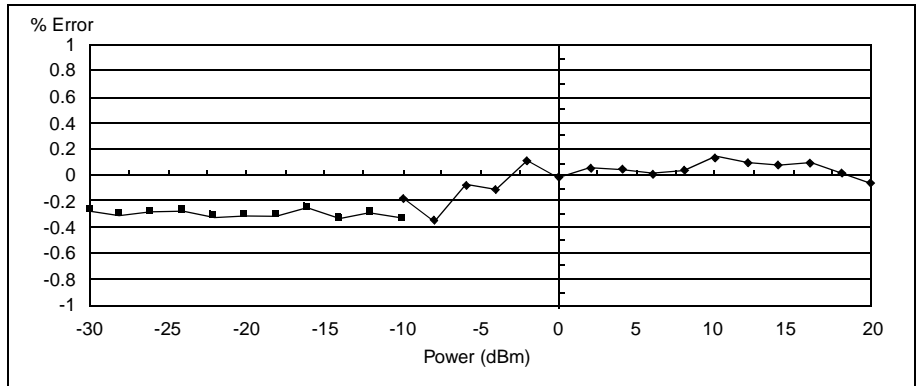

Figure 12 Typical Power Linearity at 25°C, after zero and calibration, with associated Measurement Uncertainty

	-30 to -20 dBm	-20 to -10 dBm	-10 to 0 dBm	0 to 10 dBm	10 to 20 dBm
Measurement Uncertainty	±0.9%	±0.8%	±0.65%	±0.55%	±0.45%

Note

If the temperature changes after calibration and you choose not to re-calibrate the sensor, Additional Power Linearity Error (next table) should be added to the Power Linearity specifications shown above. The typical maximum Additional Power Linearity error due to temperature change after calibration at 25°C, for small changes in temperature, is ±0.15%/°C (valid after zeroing the sensor). For larger changes refer to the following table.

**Additional Power
Linearity Error Due to Change in Temperature**

Power Level	Additional Power Linearity Error		Additional Power Linearity Error 0°C to 55°C
	25°C	10°C	
-60 dBm to -10 dBm	±1.5%		±2.0%
-10 dBm to +10 dBm	±1.5%		±2.5%
+10 dBm to +20 dBm	±1.5%		±2.0%

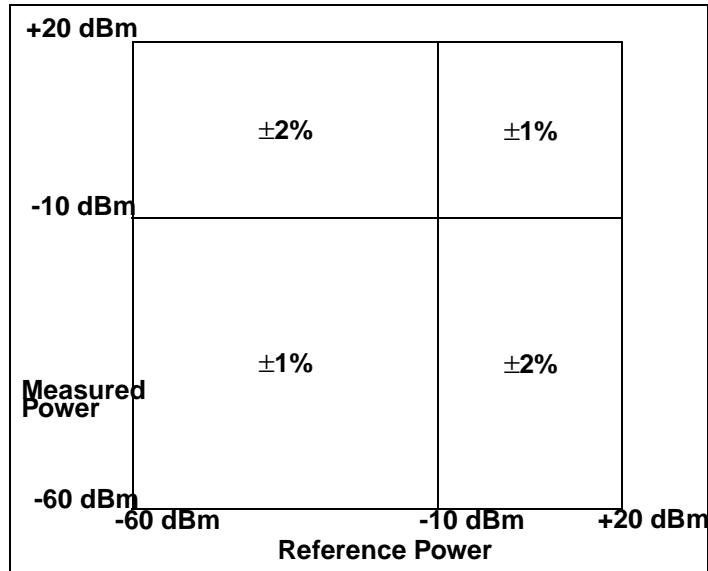

Figure 13 *Relative Mode Power Measurement Linearity with Agilent EPM power meter at 25°C ±10°C (typical)*

Figure 13 shows the typical uncertainty in making a relative power measurement, using the same power meter channel and same power sensor to obtain the reference and the measured values. It assumes that negligible changes in frequency and mismatch error occur when transitioning from the power level used as the reference to the power level being measured.

Switching Point

The Agilent E-series E9300 power sensors have two paths, a low power path covering -60 dBm to -10 dBm, and a high power path covering -10 dBm to +20 dBm. The power meter automatically selects the proper power level path. To avoid unnecessary switching when the power level is near the -10 dBm point, **Switching Point Hysteresis** has been added. This hysteresis causes the low power path to remain selected until approximately -9.5 dBm as the power level is increased, above this power the high power path is selected. The high power path remains selected until approximately -10.5 dBm as the signal level decreases, below this power the low power path is selected.

Error	
Offset at Switch Point	$\leq \pm 0.5\%$ ($\leq \pm 0.02$ dB) typical
Switching Point Hysteresis	0.5 dB typical

Zero Set, Zero Drift and Measurement Noise

	Conditions (RH) ¹	Zero Set	Zero Drift ²	Measurement Noise ³
Lower Range (-60 to -10 dBm)	15% to 75%	500 pW	150 pW	700 pW
	75% to 95%	500 pW	4,000 pW	700 pW
Upper Range (-10 to +20 dBm)	15% to 75%	500 nW	150 nW	500 nW
	75% to 95%	500 nW	3,000 nW	500 nW

1. RH is the abbreviation for Relative Humidity.

2. Within 1 hour after zero set, at a constant temperature, after a 24 hour warm-up of the power meter with sensor connected.

3. The number of averages at 16 for **Normal** mode and 32 for **x2** mode, at a constant temperature, measured over a one minute interval and two standard deviations.

Settling Time

In **FAST** mode (using Free Run trigger), for a 10 dB decreasing power step, the settling time is:

Time	
E4418B	20 ms ^a
E4419B	

1. When a power step crosses the auto-range switch point of the sensor, add 25 ms.

Number of Averages	1	2	4	8	16	32	64	128	256	512	1,024
Settling Time ¹ (s) (Normal Mode)	0.07	0.12	0.21	0.4	1.0	1.8	3.5	6.5	13	27	57
Settling Time ^a (s) (x2 Mode)	0.04	0.07	0.12	0.21	0.4	1.0	1.8	3.5	6.5	14	32

1. Manual filter, 10 dB decreasing power step (not across the switching point)

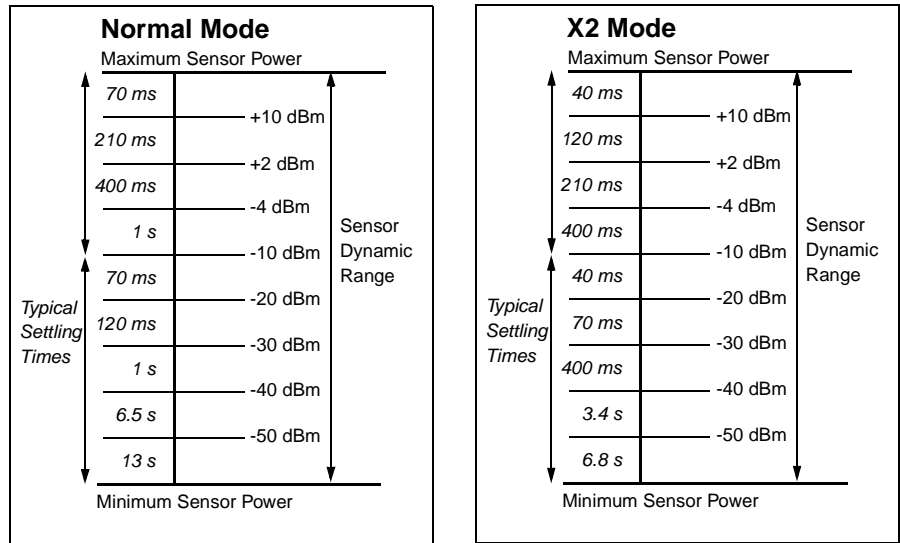

Figure 14 *Autofilter, default resolution, 10 dB decreasing power step (not across the switching point)*

Calibration Factor and Reflection Coefficient

Calibration Factor (CF) and Reflection Coefficient (Rho) data are provided on a data sheet included with the power sensor. This data is unique to each sensor. If you have more than one sensor, match the serial number on the data sheet with the serial number on the power sensor you are using. The CF corrects for the frequency response of the sensor. Agilent EPM series power meters automatically read the CF data stored in the sensor and use it to make the corrections.

Reflection Coefficient (Rho, or ρ) relates to the SWR according to the following formula:

$$SWR = \frac{1 + \rho}{1 - \rho}$$

Maximum uncertainties of the CF data are listed in the following tables. As the Agilent E-series E9300 power sensors have two independent measurement paths (high and low power paths), there are two calibration factor uncertainty tables for each sensor. The uncertainty analysis for the calibration of the sensors was done in accordance with ISO Guide. The uncertainty data reported on the calibration certificate is the expanded uncertainty with a 95% confidence level and a coverage factor of 2.

E9300/1/4/A Power Sensor Specifications

Cal Factor Uncertainty

(Low Power Path,-60 to -10 dBm)

Frequency	Uncertainty (25°C 10°C)			Uncertainty (0°C to 55°C)		
	E9300A	E9301A	E9304A	E9300A	E9301A	E9304A
9 kHz to 10 MHz	-	-	±1.7%	-	-	±2.0%
10 MHz to 30 MHz	±1.8%	±1.8%	±1.7%	±2.2%	±2.2%	±2.0%
30 MHz to 500 MHz	±1.6%	±1.6%	±1.7%	±2.0%	±2.0%	±2.0%
500 MHz to 1.2GHz	±1.8%	±1.8%	±1.7%	±2.5%	±2.5%	±2.0%
1.2 GHz to 6 GHz	±1.7%	±1.7%	±1.7%	±2.0%	±2.0%	±2.0%
6 GHz to 14 GHz	±1.8%	-	-	±2.0%	-	-
14 GHz to 18 GHz	±2.0%	-	-	±2.2%	-	-

Cal Factor Uncertainty

(High Power Path,-10 to +20 dBm)

Frequency	Uncertainty (25°C 10°C)			Uncertainty (0°C to 55°C)		
	E9300A	E9301A	E9304A	E9300A	E9301A	E9304A
9 kHz to 10 MHz	-	-	±2.0%	-	-	±3.4%
10 MHz to 30 MHz	±2.1%	±2.1%	±2.0%	±4.0%	±4.0%	±3.4%
30 MHz to 500 MHz	±1.8%	±1.8%	±2.0%	±3.0%	±3.0%	±3.4%
500 MHz to 1.2GHz	±2.3%	±2.3%	±2.2%	±4.0%	±4.0%	±3.4%
1.2 GHz to 6 GHz	±1.8%	±1.8%	±1.8%	±2.1%	±2.1%	±2.1%
6 GHz to 14 GHz	±1.9%	-	-	±2.3%	-	-
14 GHz to 18 GHz	±2.2%	-	-	±3.3%	-	-

General

Physical Characteristics	
Net Weight	0.18 kg (0.4 lb)
Dimensions	Length: 130 mm (5.1 in) Width: 38 mm (1.5 in) Height: 30 mm (1.2 in)

Storage and Shipment	
Environment	The sensor should be stored in a clean, dry environment
Temperature	-55°C to +75°C
Relative Humidity	<95% at 40°C
Altitude	<15,240 metres (50,000 feet)

E9300/1B and H Power Sensor Specifications

Frequency Range

	Frequency Range
E9300B/H	10 MHz to 18.0 GHz
E9301B/H	10 MHz to 6.0 GHz

Connector Type

Type - N (Male) 50 ohm

Maximum SWR (25°C±10°C)

	Frequency	SWR
E9300B	10 MHz to 2 GHz	1.12
	2 GHz to 12.4 GHz	1.17
	12.4 GHz to 18 GHz	1.24
E9301B	10 MHz to 6 GHz	1.12
E9300H	10 MHz to 8 GHz	1.15
	8 GHz to 12.4 GHz	1.25
	12.4 GHz to 18 GHz	1.28
E9301H	10 MHz to 6 GHz	1.15

Maximum SWR

(0°C to +55°C)

	Frequency	SWR
E9300B	10 MHz to 2 GHz	1.14
	2 GHz to 12.4 GHz	1.18
	12.4 GHz to 18 GHz	1.25
E9301B	10 MHz to 6 GHz	1.14
E9300H	10 MHz to 8 GHz	1.17
	8 GHz to 12.4 GHz	1.26
	12.4 GHz to 18 GHz	1.29
E9301H	10 MHz to 6 GHz	1.17

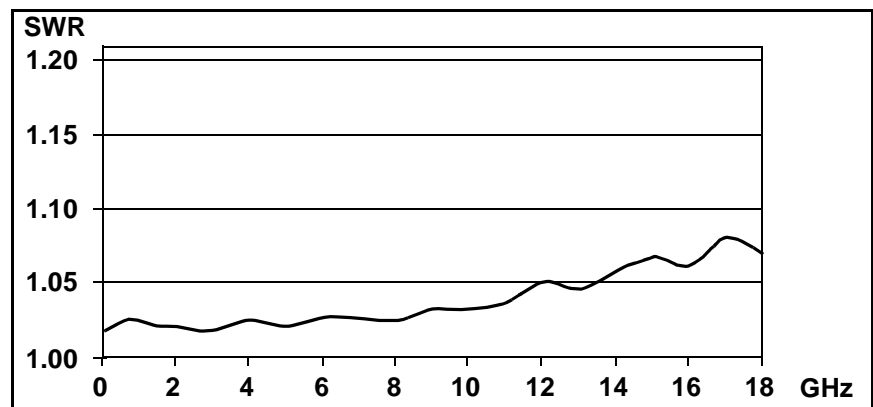
**Figure 15** *E9300B Typical SWR (25°C ±10°C)*

E9300/1B and H Power Sensor Specifications

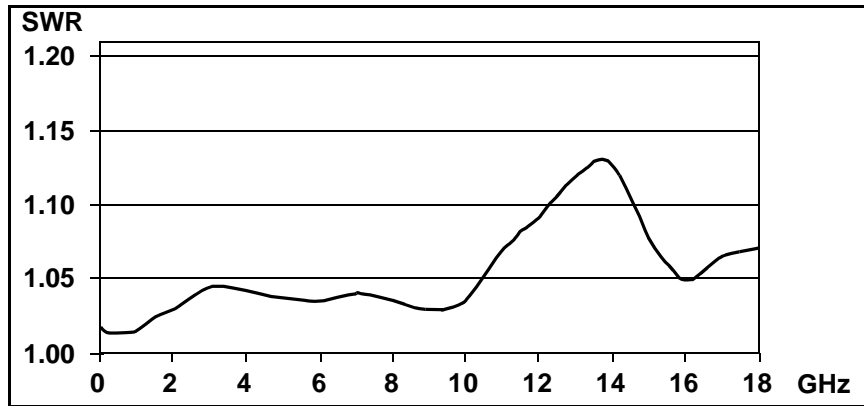

Figure 16 *E9300H Typical SWR 10 MHz to 18 GHz (25°C ±10°C)*

Maximum Power

Maximum Power				
Sensor	0°C to 35°C	35°C to 55°C	<6.0 GHz	>6.0 GHz
E9300/1B	30 W average	25 W average	500 W Peak	125 W Peak
	500 Wμs per pulse	500 Wμs per pulse	500 Wμs per pulse	500 Wμs per pulse
E9300/1H	3.16 W average	3.16 W average	100 W Peak	100 W Peak
	100 Wμs per pulse	100 Wμs per pulse	100 Wμs per pulse	100 Wμs per pulse

Power Linearity

After Zero and Calibration at ambient environmental conditions.

Sensor	Power Level	Linearity	
		25°C 10°C	0°C to 55°C
E9300/1B		±3.5%	±4.0%
		±3.0%	±3.5%
	+30 dBm to +44 dBm	±2.5%	±3.0%
E9300/1H	-50 dBm to 0 dBm	±4.0%	±5.0%
	0 dBm to +10 dBm	±3.5%	±4.0%
	+10 dBm to +30 dBm	±3.0%	±3.5%

E9300/1B and H Power Sensor Specifications

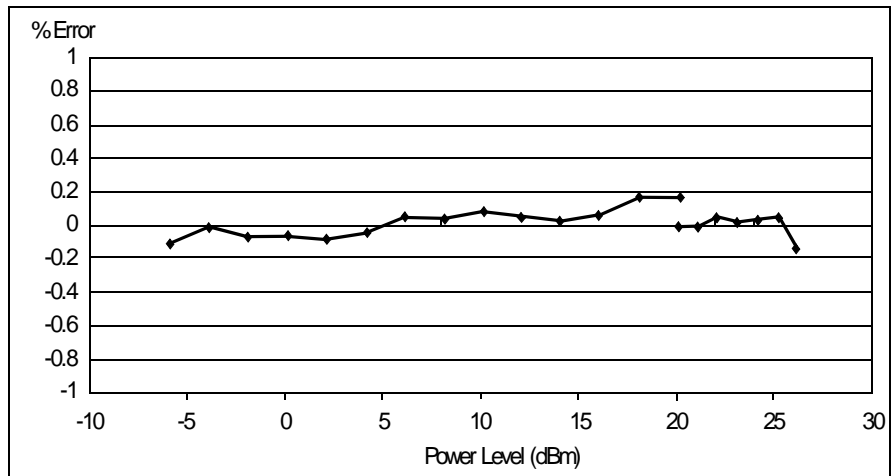

Figure 17 *E9300B Typical Power Linearity at 25°C, after zero and calibration with associated Measurement Uncertainty*

E9300/1B	-6 to 0 dBm	0 to 10 dBm	10 to 20 dBm	20 to 26 dBm
Measurement Uncertainty	±0.65%	±0.55%	±0.45%	±0.31%

See Note on page -49.

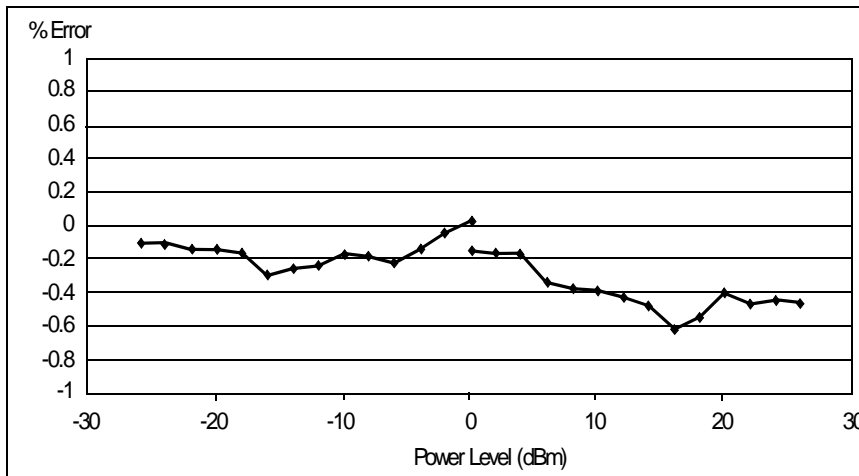

Figure 18 *E9300H Typical Power Linearity at 25°C, after zero and calibration with associated Measurement Uncertainty*

E9300/1H	-26 to -20 dBm	-20 to -10 dBm	-10 to 0 dBm	0 to 10 dBm	10 to 20 dBm	20 to 26 dBm
Measurement Uncertainty	±0.9%	±0.8%	±0.65%	±0.55%	±0.45%	±0.31%

Note

If the temperature changes after calibration and you choose not to re-calibrate the sensor, Additional Power Linearity Error (next table) should be added to the Power Linearity specification shown above. The typical maximum Additional Power Linearity error due to temperature change after calibration at 25°C, for small changes in temperature, is ±0.2%/°C (valid after zeroing the sensor). For larger changes refer to the following table.

Additional Power Linearity Error due to Change in Temperature

Sensor	Power Level	Additional Power Linearity Error	
		25°C	10°C
E9300/1B	-30 dBm to +20 dBm	±1.5%	±2.0%
	+20 dBm to +30 dBm	±1.5%	±2.5%
	+30 dBm to +44 dBm	±1.5%	±2.0%
E9300/1H	-50 dBm to 0 dBm	±1.5%	±2.0%
	0 dBm to +10 dBm	±1.5%	±2.5%
	+10 dBm to +30 dBm	±1.5%	±2.0%

Figure 19 shows the typical uncertainty in making a relative power measurement, using the same power meter channel and same power sensor to obtain the reference and measured values. It assumes that negligible changes in frequencies and mismatch error occur when transitioning from the power level used as the reference to the power level being measured.

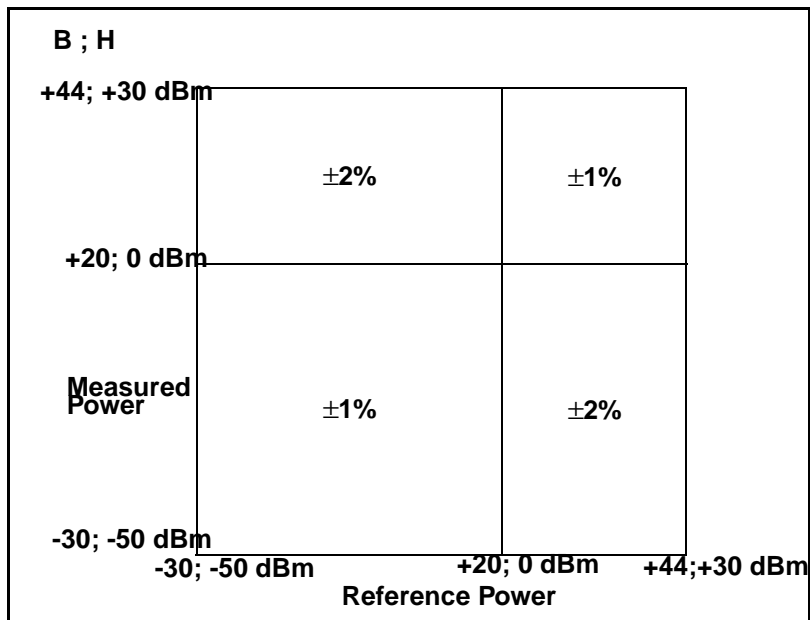

Figure 19 Relative Mode Power Measurement Linearity with Agilent EPM power meter at 25°C ±10°C (typical)

Switching Point

The Agilent E-series E9300 power sensors have two paths, a lower path and a higher path. The power meter automatically selects the proper power level path. To avoid unnecessary switching when the power level is near the switch point, **Switching Point Hysteresis** has been added. This hysteresis causes the low power path to remain selected until approximately 0.5 dB above the switch point as the power level is increased. Above this power, the high power path is selected. The high power path remains selected until approximately 0.5 dB below the switch point as the signal level decreases. Below this power, the lower path is selected. 0 dBm is the switch point for the E9300/01B sensors while the E9300/01H sensors switch at 20 dBm.

E9300/1B and H Power Sensor Specifications

Error	
Offset at Switch Point	$\leq \pm 0.5\%$ ($\leq \pm 0.02$ dB) <i>typical</i>
Switching Point Hysteresis	0.5 dB <i>typical</i>

E9300/1B	Conditions (RH) ¹	Zero Set	Zero Drift ²	Measurement Noise ³
Lower Range (-30 to +20 dBm)	15% to 75%	500 nW	150 nW	700 nW
	75% to 95%	500 nW	4 μ W	700 nW
Upper Range (+20 to +44 dBm)	15% to 75%	500 μ W	150 μ W	500 μ W
	75% to 95%	500 μ W	3 mW	500 μ W
E9300/1H				
Lower Range (-50 to 0 dBm)	15% to 75%	5 nW	1.5 nW	7 nW
	75% to 95%	5 nW	40 nW	7 nW
Upper Range (0 to +30 dBm)	15% to 75%	5 μ W	1.5 μ W	5 μ W
	75% to 95%	5 μ W	30 μ W	5 μ W

1. RH is the abbreviation for Relative Humidity.
2. Within 1 hour after zero set, at a constant temperature, after a 24 hour warm-up of the power meter with sensor connected.
3. The number of averages at 16 for **Normal** mode and 32 for **x2** mode, at a constant temperature, measured over a one minute interval and two standard deviations.

Settling Time

In **FAST** mode (using Free Run trigger), for a 10 dB decreasing power step, the settling time is:

Time	
E4418B	
E4419B	20 ms ^a

1. When a power step crosses the auto-range switch point of the sensor, add 25 ms.

Number of Averages	1	2	4	8	16	32	64	128	256	512	1,024
Settling Time ¹ (s) (Normal Mode)	0.07	0.12	0.21	0.4	1.0	1.8	3.3	6.5	13	27	57
Settling Time ^a (s) (x2 Mode)	0.04	0.07	0.12	0.21	0.4	1.0	1.8	3.3	6.5	14	32

1. Manual filter, 10 dB decreasing power step (not across the switching point)

E9300/1B and H Power Sensor Specifications

		X2 Normal Mode		Maximum Sensor Power		E9300/1B	E9300/1H	
High Power Path		40 ms	70 ms			+40 dBm	+20 dBm	
		120 ms	210 ms			+32 dBm	+12 dBm	
		210 ms	400 ms			+26 dBm	+6 dBm	
Typical Settling Times		400 ms	1 s			+20 dBm	0 dBm	
		40 ms	70 ms			+10 dBm	-10 dBm	
		70 ms	120 ms			0 dBm	-20 dBm	
		400 ms	1 s			-10 dBm	-30 dBm	
	Low Power Path		3.4 s	6.5 s			-20 dBm	-40 dBm
			6.8 s	13 s				
				Minimum Sensor Power				

Sensor Dynamic Range

Figure 20 E9300/1B & H Autofilter, default resolution, 10 dB decreasing power step (not across the switching point)

Calibration Factor and Reflection Coefficient

Calibration Factor (CF) and Reflection Coefficient (Rho) data are provided on a data sheet included with the power sensor. This data is unique to each sensor. If you have more than one sensor, match the serial number on the data sheet with the serial number on the power sensor you are using. The CF corrects for the frequency response of the sensor. The Agilent EPM series power meters automatically read the CF data stored in the sensor and use it to make the corrections.

Reflection Coefficient (Rho, or ρ) relates to the SWR according to the following formula:

$$\text{SWR} = \frac{1 + \rho}{1 - \rho}$$

Maximum uncertainties of the CF data are listed in the following tables. As the Agilent E-series E9300 power sensors have two independent measurement paths (high and low power paths), there are two calibration factor uncertainty tables for each sensor. The uncertainty analysis for the calibration of the sensors was done in accordance with ISO Guide. The uncertainty data reported on the calibration certificate is the expanded uncertainty with a 95% confidence level and coverage factor of two.

Cal Factor Uncertainty (Low Power Path)

Frequency	Uncertainty (25°C 10°C)				Uncertainty (0°C to 55°C)			
	E9300B	E9301B	E9300H	E9301H	E9300B	E9301B	E9300H	E9301H
	±1.8%	±1.8%	±1.8%	±1.8%	±2.2%	±2.2%	±2.2%	±2.2%
	±1.6%	±1.6%	±1.6%	±1.6%	±2.0%	±2.0%	±2.0%	±2.0%
	±1.8%	±1.8%	±1.8%	±1.8%	±2.5%	±2.5%	±2.5%	±2.5%
	±1.7%	±1.7%	±1.7%	±1.7%	±2.0%	±2.0%	±2.0%	±2.0%
	±1.8%	-	±1.8%		±2.0%	-	±2.0	-
	±2.0%	-	±2.0%		±2.2%	-	±2.2	-

E9300/1B and H Power Sensor Specifications

Cal Factor Uncertainty (High Power Path)

Frequency	Uncertainty (25°C 10°C)				Uncertainty (0°C to 55°C)			
	E9300B	E9301B	E9300H	E9301H	E9300B	E9301B	E9300H	E9301H
	±2.1%	±2.1%	±2.6%	±2.6%	±4.0%	±4.0%	±5.0%	±5.0%
	±1.8%	±1.8%	±2.3%	±2.3%	±3.0%	±2.0%	±3.5%	±3.5%
	±2.3%	±2.3%	±2.8%	±2.8%	±4.0%	±4.0%	±4.5%	±4.5%
	±1.8%	±1.8%	±2.3%	±2.3%	±2.1%	±2.1%	±2.6%	±2.6%
	±1.9%	-	±2.4%		±2.3%	-	±2.8	-
	±2.2%	-	±2.7%		±3.3%	-	±3.8	-

General

Physical Characteristics		
	E9300/1B	E9300/1H
Net Weight	0.8 kg (1.74 lb)	0.2 kg (0.5 lb)
Dimensions	Length: 275 mm (10.8 in) Width: 115 mm (4.5 in) Height: 82 mm (3.2 in)	Length: 172 mm (6.8 in) Width: 38 mm (1.5 in) Height: 30 mm (1.2 in)

Storage and Shipment	
Environment	The sensor should be stored in a clean, dry environment
Temperature	-55°C to +75°C
Relative Humidity	<95% at 40°C
Altitude	<15,240 metres (50,000 feet)

References

TIA is the Telecommunications Industry Association; EIA is the Electronic Industries Association.

TIA/EIA/IS-97-A is the Recommended Minimum Performance Standards for Base Stations Supporting Dual-Mode Wideband Spread Spectrum Cellular Mobile Stations.

TIA/EIA/IS-98-A is the Recommended Minimum Performance Standards for Dual-Mode Wideband Spread Spectrum Cellular Mobile Stations.

E9300/1B and H Power Sensor Specifications

Service

General Information

This chapter contains information about general maintenance, performance tests, troubleshooting and repair of Agilent E-series E9300 power sensors.

Cleaning

Use a clean, damp cloth to clean the body of the Agilent E-series E9300 power sensor.

Connector Cleaning

Caution	The RF connector beads deteriorate when contacted by hydrocarbon compounds such as acetone, trichloroethylene, carbon tetrachloride, and benzene.
----------------	---

Caution	Clean the connector only at a static free workstation. Electrostatic discharge to the center pin of the connector will render the power sensor inoperative.
----------------	---

Keeping in mind its flammable nature; a solution of pure isopropyl or ethyl alcohol can be used to clean the connector.

Clean the connector face using a cotton swab dipped in isopropyl alcohol. If the swab is too big use a round wooden toothpick wrapped in a lint free cotton cloth dipped in isopropyl alcohol. Refer to Agilent Application Note 326, Principles of Microwave Connector Care (5954-1566) or Microwave Connector Care (08510-90064) for proper cleaning methods.

Performance Test

Standing Wave Ratio (SWR) and Reflection Coefficient (Rho) Performance Test

This section does not establish preset SWR test procedures since there are several test methods and different equipment available for testing the SWR or reflection coefficient. Therefore, the actual accuracy of the test equipment must be accounted for when measuring against instrument specifications to determine a pass or fail condition. The test system used must not exceed the system Rho uncertainties shown in the following tables when testing the Agilent E-series E9300 power sensors.

Table 3: Power Sensor SWR and Reflection Coefficient for the E9300A

Frequency	System Rho Uncertainty	Actual Measurement	Maximum Rho
10 MHz to 30 MHz	± 0.010		0.070
30 MHz to 2 GHz	± 0.010		0.061
2 GHz to 14 GHz	± 0.010		0.087
14 GHz to 16 GHz	± 0.010		0.099
16 GHz to 18 GHz	± 0.010		0.115

Table 4: Power Sensor SWR and Reflection Coefficient for the E9301A

Frequency	System Rho Uncertainty	Actual Measurement	Maximum Rho
10 MHz to 30 MHz	± 0.010		0.070
30 MHz to 2 GHz	± 0.010		0.061
2 GHz to 6 GHz	± 0.010		0.087

Caution

DC voltages in excess of the maximum value (5 Vdc) can damage the sensing diode.

Performance Test

Table 5: Power Sensor SWR and Reflection Coefficient for the Agilent 9304A

Frequency	System Rho Uncertainty	Actual Measurement	Maximum Rho
9 kHz to 2 GHz	± 0.010		0.061
2 GHz to 6 GHz	± 0.010		0.087

Table 21

Power Sensor SWR and Reflection Coefficient for the Agilent E9300B

Frequency	System Rho Uncertainty	Actual Measurement	Maximum Rho
10 MHz to 8 GHz	± 0.010		0.057
8 GHz to 12.4GHz	± 0.010		0.078
12.4 GHz to 18 GHz	± 0.010		0.107

Table 22

Power Sensor SWR and Reflection Coefficient for the Agilent E9301B

Frequency	System Rho Uncertainty	Actual Measurement	Maximum Rho
10 MHz to 6 GHz	± 0.010		0.057

Table 23

Power Sensor SWR and Reflection Coefficient for the Agilent E9300H

Frequency	System Rho Uncertainty	Actual Measurement	Maximum Rho
10 MHz to 8 GHz	± 0.010		0.070
8 GHz to 12.4GHz	± 0.010		0.111
12.4 GHz to 18 GHz	± 0.010		0.123

Table 24

Power Sensor SWR and Reflection Coefficient for the Agilent E9301H

Frequency	System Rho Uncertainty	Actual Measurement	Maximum Rho
10 MHz to 6 GHz	± 0.010		0.070

Replaceable Parts

Figure 25 is the illustrated parts breakdown (IPB) that identifies all of the replaceable parts. To order a part, quote the Agilent part number, specify the quantity required, and address the order to the nearest Agilent office.

Note

Within the USA, it is better to order directly from the Agilent Parts Center in Roseville, California. Ask your nearest Agilent office for information and forms for the “Direct Mail Order System.” Also your nearest Agilent office can supply toll free telephone numbers for ordering parts and supplies.

Replaceable Parts

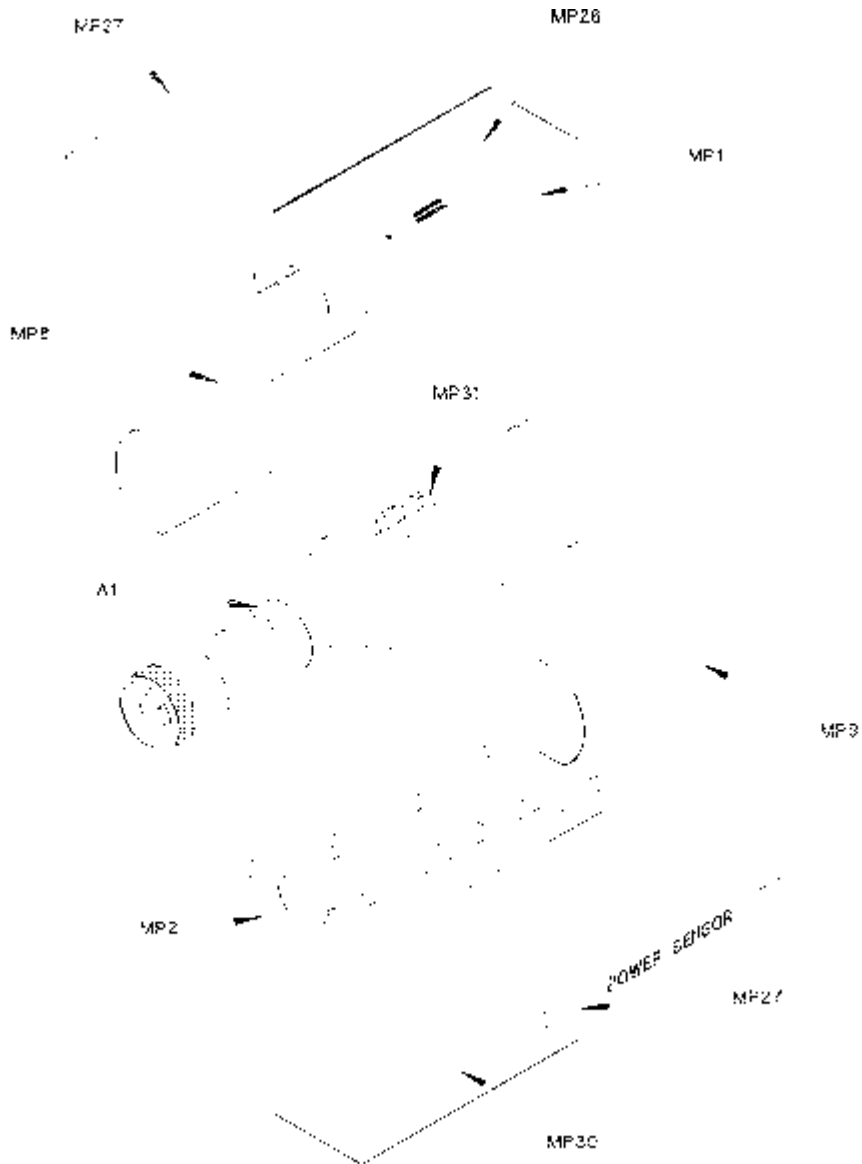

Figure 25 Illustrated Parts Break down

Reference Designation	Agilent Part Number	Qty	Description
A1/A2			
E9300A	E9300-60006	1	SENSOR MODULE
E9300B	E9300-60017	1	SENSOR MODULE
E9300H	E9300-60018	1	SENSOR MODULE
E9301A	E9301-60007	1	SENSOR MODULE
E9301B	E9301-60001	1	SENSOR MODULE
E9301H	E9301-60002	1	SENSOR MODULE
E9304A	E9304-60003	1	SENSOR MODULE
A1/A2			
E9300A	E9300-69006	1	RESTORED SENSOR MODULE
E9300B	E9300-69017	1	RESTORED SENSOR MODULE ¹
E9300H	E9300-69018	1	RESTORED SENSOR MODULE
E9301A	E9301-69007	1	RESTORED SENSOR MODULE
E9301B	E9301-68001	1	RESTORED SENSOR MODULE ¹
E9301H	E9301-69002	1	RESTORED SENSOR MODULE
E9304A	E9304-69003	1	RESTORED SENSOR MODULE
CHASSIS PARTS			
MP1	5041-9160	2	SHELL-PLASTIC
MP2	5041-9160		SHELL-PLASTIC
MP3	08481-20011	2	CHASSIS
MP4	08481-20011		CHASSIS
MP8	08481-00002	2	SHIELD
MP9	08481-00002		SHIELD
MP26	E9300-80001	1	LABEL, ID E9300A
MP26	E9300-80002	1	LABEL, ID E9300B
MP26	E9300-80003	1	LABEL, ID E9300H
MP26	E9301-80001	1	LABEL, ID E9301A

Replaceable Parts

Reference Designation	Agilent Part Number	Qty	Description
MP26	E9301-80003	1	LABEL, ID E9301B
MP26	E9301-80002	1	LABEL, ID E9301H
MP26	E9304-80001	1	LABEL, ID E9304A
MP27	7121-7389	2	LABEL, POWER SENSOR
MP30	7121-7388	1	LABEL, CAL/ESD
MP30	E9304-80002	1	LABEL, CAUTION E9304A
MP31	00346-80011	1	LABEL, CAUTION

¹ Includes attenuator assembly

Service

Service instructions consist of principles of operation, troubleshooting, and repairs.

Principles of Operation

The A1 Bulkhead assembly on the Agilent E-series E9300 power sensors provides a 50 ohm load to the RF signal applied to the power sensor. The A1 Bulkhead assembly on the E9300/1B sensors includes a 30 dB attenuator that can be disconnected by means of a Type-N connector. The A1 Bulkhead assembly on the E9300/1H sensors includes a 10 dB attenuator in the front end. A dual range GaAs diode pair/attenuator/diode pair assembly in the bulkhead rectifies the applied RF to produce dc voltages (high and low ranges) which vary with the RF power across the 50 ohm load. Thus the voltage varies with the RF power dissipated in the load.

The low-level dc voltages from the bulkhead assembly are amplified before they are transferred on standard cables to the power meter. The amplification is provided by an input amplifier assembly which consists of a chopper (sampling gate) and an input amplifier. The chopper circuit converts the dc voltages to ac voltages. The chopper is controlled by a 220 Hz square wave generated by the power meter. The amplitude of the sampling gate output is a 220 Hz square wave which varies with the RF power input. The 220 Hz ac output is applied to an amplifier which provides the input to the power meter.

The Agilent EPM series power meter automatically detects when an Agilent E-series E9300 power sensor is connected and downloads the correction data from the sensor's EEPROM. In the E9300/1B/H the EEPROM contains an offset value for the measured attenuation value of the attenuator used in the bulkhead assembly. Thus, the attenuator is matched to a particular sensor. The auto-averaging settings are also configured automatically for use with Agilent E-series E9300 power sensors. This configures the power meter to operate over the range with that particular sensor's unique correction data applied.

Service

Troubleshooting

Troubleshooting information is intended to first isolate the power sensor, the cable, or the power meter as the defective component. When the power sensor is isolated, an appropriate Sensor Module must be used for repair.

If error message 241 or 310 is indicated on the power meter, suspect a failed power sensor. If no error message is displayed, but a problem occurs when making a measurement, try replacing the cable from the power meter to the power sensor. If the problem still exists, try using a different power sensor to determine if the problem is in the power meter or in the power sensor.

Caution

Electrostatic discharge will render the power sensor inoperative. Do not, under any circumstances, open the power sensor unless you and the power sensor are in a static free environment.

Repair of Defective Sensor

There are no serviceable parts inside the Agilent E-series E9300 power sensors. If the sensor is defective, replace the entire “module” with the appropriate “Restored Sensor Module.”

Disassembly Procedure

Disassemble the power sensor by performing the following steps:

Caution

Disassemble the power sensor only in a static free workstation. Electrostatic discharge renders the power sensor inoperative.

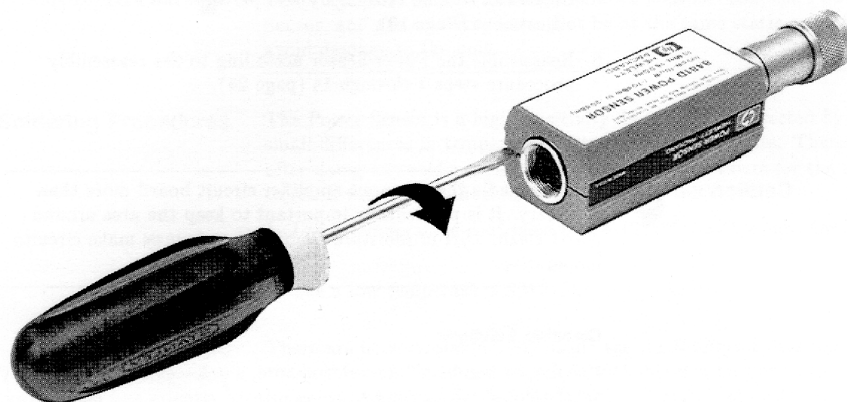

Figure 26 Removing Power Sensor Shell

1. At the rear of the power sensor, insert the blade of a screwdriver between the plastic shells (See Figure 26). To prevent damage to the plastic shells use a screwdriver blade as wide as the slot between the two shells.
2. Pry alternately at both sides of the connector J1 until the plastic shells are apart. Remove the shells and the magnetic shields.

Reassembly Procedure

1. Replace the magnetic shields and the plastic shells as shown in Figure 25. Snap the plastic shells together.

Sales and Service Offices

For more information about Agilent Technologies test and measurement products, applications, services, and for a current sales office listing, visit our web site:<http://www.agilent.com>

You can also contact one of the following centers and ask for a test and measurement sales representative.

Asia Pacific:

Agilent Technologies
19/F, Cityplaza One, 1111 King's Road,
Taikoo Shing, Hong Kong, SAR
(tel) (852) 2599 7889
(fax) (852) 2506 9233

Japan:

Agilent Technologies Japan Ltd.
Measurement Assistance Center
9-1, Takakura-Cho, Hachioji-Shi
Yokyo, 192-8510
(tel) (81) 426 56 7832
(fax) (81) 426 56 7840

Australia/New Zealand:

Agilent Technologies Australia Pty Ltd
347 Burwood Highway
Forest Hill, Victoria 3131
(tel) 1-800 629 485 (Australia)
(fax) (61 3) 9272 0749
(tel) 0 800 738 378 (New Zealand)
(fax) (64 4) 802 6881

Canada:

Agilent Technologies Canada Inc.
5150 Spectrum Way,
Mississauga, Ontario
L4W 5G1
(tel) 1 877 894 4414

Europe:

Agilent Technologies
Test & Measurement
European Marketing Organisation
P.O. Box 999
1180 AZ Amstelveen
The Netherlands
(tel) (31 20) 547 9999

Latin America:

Agilent Technologies
Latin American Region Headquarters
5200 Blue Lagoon Drive, Suite #950
Miami, Florida 33126
U.S.A.
(tel) (305) 267 4245
(fax) (305) 267 4286

United States:

Agilent Technologies
Test and Measurement Call Center
P.O. Box 4026
Englewood, CO 80155-4026
(tel) 1 800 452 488

In any correspondence or telephone conversations, refer to the power sensor by its model number and full serial number. With this information, the Agilent Technologies representative can quickly determine whether your unit is still within its warranty period.

Free Manuals Download Website

<http://myh66.com>

<http://usermanuals.us>

<http://www.somanuals.com>

<http://www.4manuals.cc>

<http://www.manual-lib.com>

<http://www.404manual.com>

<http://www.luxmanual.com>

<http://aubethermostatmanual.com>

Golf course search by state

<http://golfingnear.com>

Email search by domain

<http://emailbydomain.com>

Auto manuals search

<http://auto.somanuals.com>

TV manuals search

<http://tv.somanuals.com>