

DIGITAL NAME SCROLLING APARTMENT INTERCOM SYSTEM

GF-NS

OPERATION MANUAL

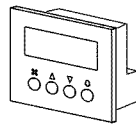

GF-NS

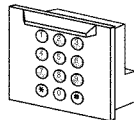

GF-10K

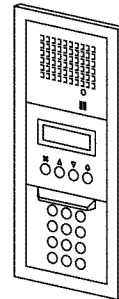
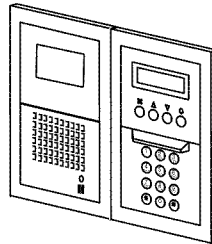

PRECAUTIONS

⚠ WARNING (Negligence could result in death or serious injury to people.)

1. This device is electrical. Wiring must be done by qualified personnel.
2. Do not modify or alter the equipment.
3. Do not open GF-NS/GF-10K case.



⚠ CAUTION (Negligence could result in injury to people or damage to property.)

1. GF-NS/GF-10K are weather resistant. However, do not spray high pressure water directly onto it by hose, etc.



GENERAL PRECAUTIONS

1. GF system is not operable during a power failure.
2. In areas where broadcasting station antennas are close by, intercom system may be affected by radio frequency interference.



General Prohibitions



Prohibitions to dismantle the unit



Prohibitions to subject the unit to water

1 NAMES & FUNCTIONS

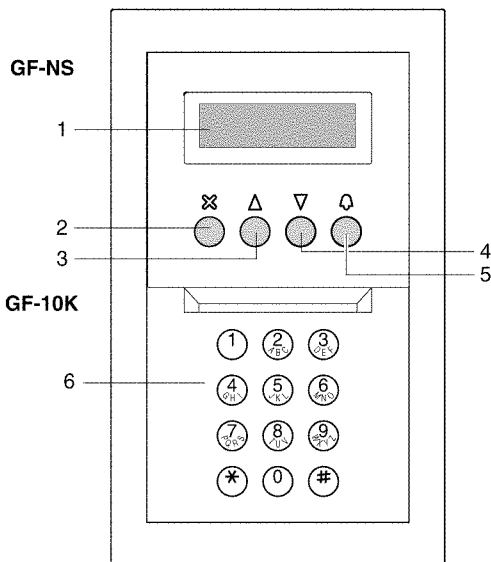

GF-NS, Name scroll module

1. LCD display
2. ⌘ **CANCEL** (or decide & back)
3. ▲ **SCROLL backward** or move cursor to left
4. ▼ **SCROLL forward** or move cursor to right
5. ☎ **CALL** (or decide & next)

GF-10K, Digital keypad module

6. Digital keypad (1 ~ 0, *, #)
When entering letters; A ~ Z, 0 = [,] [-] [.] [/] []
- Functions:
- Dialing Room #
 - Door release by entering Access code
 - Name search with (*)key and calling

2 PROGRAMMING

Programming by PC

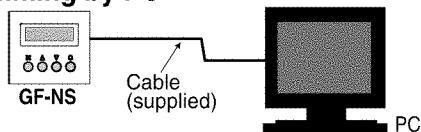

- It is possible to write or change resident names from your PC, making data input.
- Download Programming & Alteration Method from Aiphone's Web Site: <http://www.aiphone.com/>
- Connect your PC with GF-NS in conjunction with the connecting cable supplied with GF-NS.

Programming by GF-NS & GF-10K

- On LCD display, see a message "WELCOME" to confirm system is in standby.
- Prior to programming, it is suggested to have your own ID code newly registered, so that any other person cannot get into the system. → Go to P.2
- Firstly, enter program mode.
- In case your programmed ID code is forgotten, → Go to P.4

Enter Program Mode

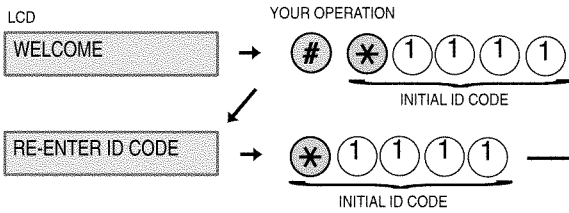

* ID CODE = 4 digit

Select Menu & Quit

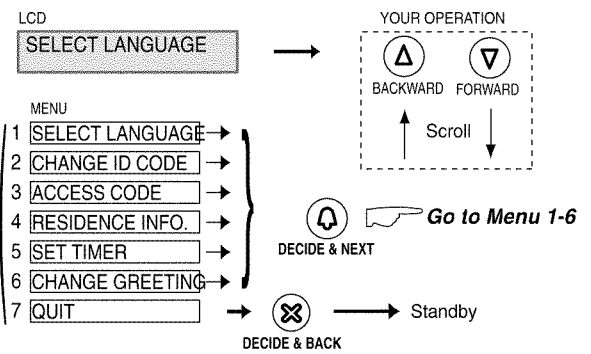

Menu 1: Select language

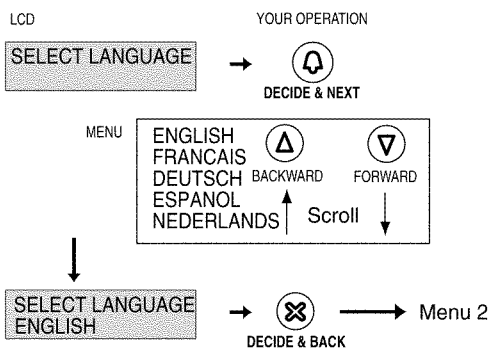

Menu 2: Change ID code

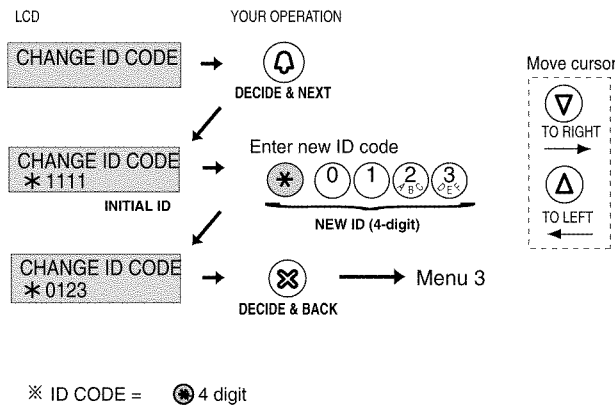

Menu 3: Program Access Code

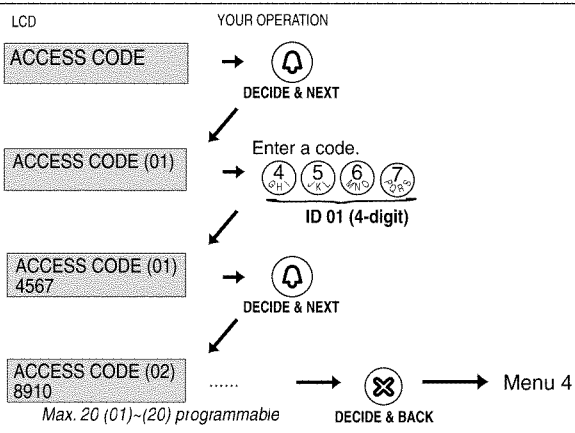

Menu 4: Write Residence Info.

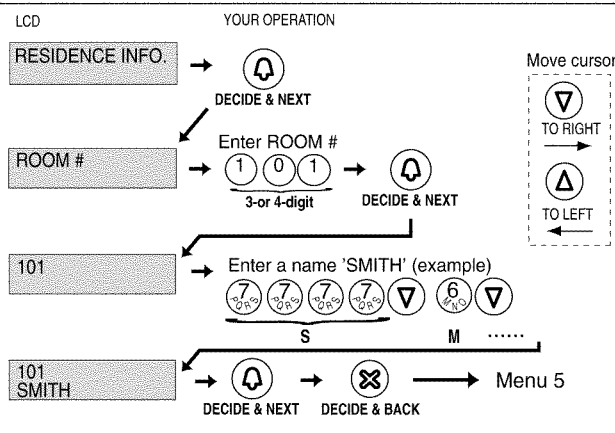

Menu 5: Set input timeout timer

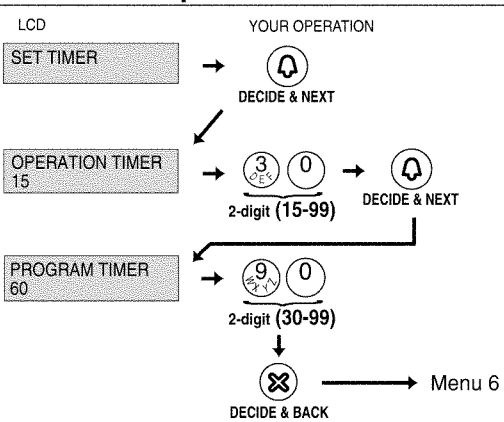

Menu 6: Change Greeting

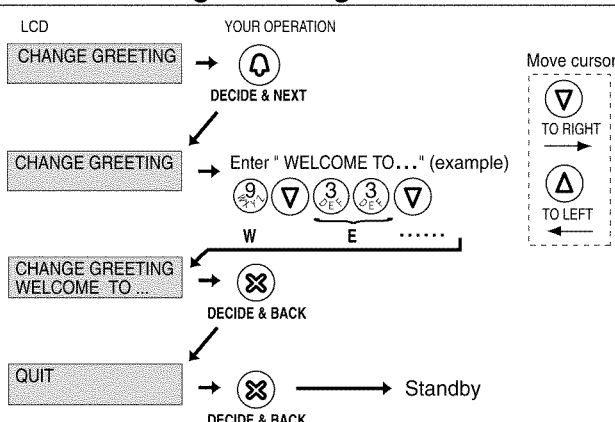

3 SETTING

Setting Up GF System

GF system must be programmed as follows;

Steps

1. To enter program mode, press PROGRAM switch on Audio Module (GF-DA/A).
2. Lift handset at a new Station to set up. Talk channel is established instantly.
3. Select a new resident name and press a CALL button at the entrance.
4. Repeat process Steps 2 ~ 3 for next residence.
5. To finish, press PROGRAM switch on Audio Module (GF-DA/A).

For details, please refer to the Manual packed with GF-BC.

4 OPERATIONS

1. Calling

(1) By scrolling names

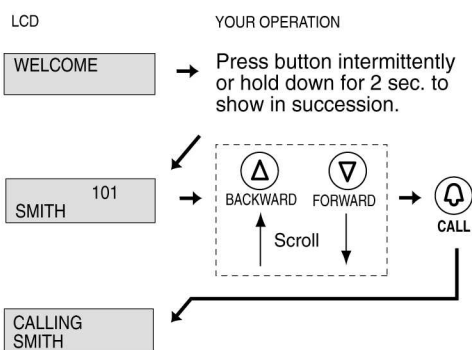

(2) By dialing Room

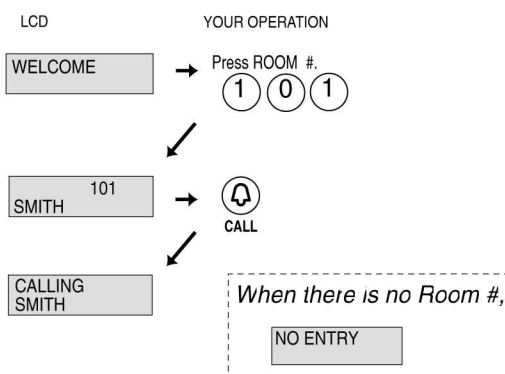

(3) By selecting name entering alphabets

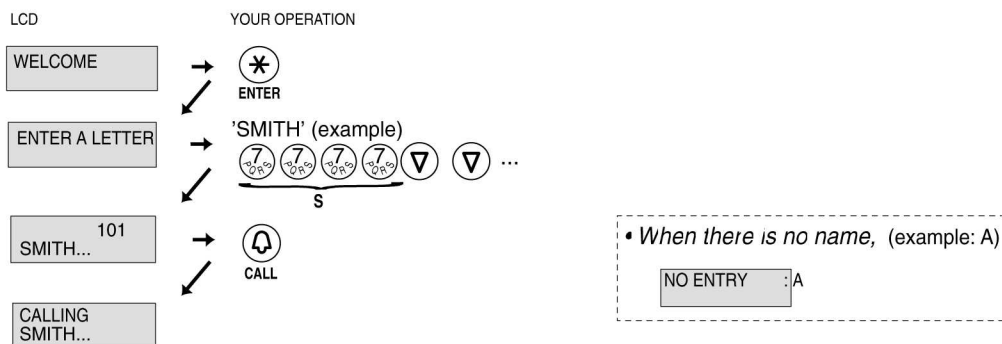

2. Communication (common operation)

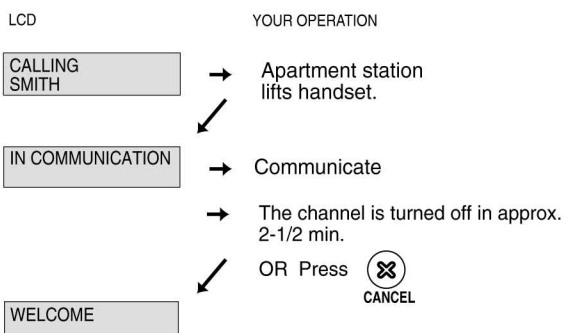

3. Activating Door Release

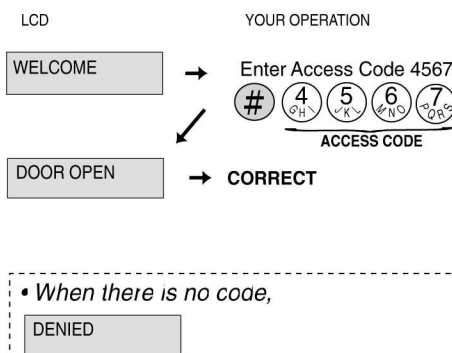

5 TECHNICAL PRECAUTIONS

(1)

The GF-NS, if programmed by PC, can place a call without using GF-10K. But it can not operate door opening by Access code.

(3)

• **Ambient temperature:**

-10°C ~ +60°C (14°F ~ 140°F)

• **Asking for repairs:**

In case the equipment does not operate properly, ask qualified technician to correct it.

• **Cleaning:**

Clean the equipment with a soft cloth dampened with household neutral cleanser. Never use any abrasive cleaner or cloth.

(2)

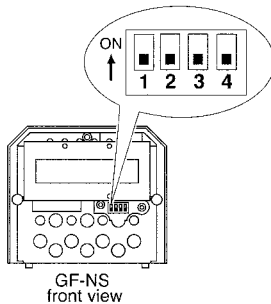

• **When you forgot your ID code**



Turn the switch on for approx. 2 sec.



The ID code returns to initial (*1111).

• **To have Room # not displayed when a call has been placed**



Put the switch 2 to ON position.

6 SPECIFICATIONS (GF-NS/GF-10K)

- Power source: DC24V, supplied by a power supply as specified
- Current consumption: 0.07A
- LCD display: Max.16 letters for names
Max.160 letters for greeting, displayed by scrolling

WARRANTY

Aiphone warrants its products to be free from defects of material and workmanship under normal use and service for a period of one year after delivery to the ultimate user and will repair free of charge or replace at no charge, should it become defective upon which examination shall disclose to be defective and under warranty. Aiphone reserves unto itself the sole right to make the final decision whether there is a defect in materials and/or workmanship; and whether or not the product is within the warranty.

This warranty shall not apply to any Aiphone product which has been subject to misuse, neglect, accident, or to use in violation of instructions furnished, nor extended to units which have been repaired or altered outside of the factory. This warranty does not cover batteries or damage caused by batteries used in connection with the product.

This warranty covers bench repairs only, and any repairs must be made at the shop or place designated in writing by Aiphone.

Aiphone will not be responsible for any costs incurred involving on site service calls.

AIPHONE CO., LTD., NAGOYA, JAPAN
AIPHONE CORPORATION, BELLEVUE, WA, USA
AIPHONE EUROPE N.V., ANTWERP, BELGIUM

AIPHONE[®]
Providing Peace of Mind
<http://www.aiphone.com/>

Free Manuals Download Website

<http://myh66.com>

<http://usermanuals.us>

<http://www.somanuals.com>

<http://www.4manuals.cc>

<http://www.manual-lib.com>

<http://www.404manual.com>

<http://www.luxmanual.com>

<http://aubethermostatmanual.com>

Golf course search by state

<http://golfingnear.com>

Email search by domain

<http://emailbydomain.com>

Auto manuals search

<http://auto.somanuals.com>

TV manuals search

<http://tv.somanuals.com>