

JKW-IP

IP Video Entry System

QuikStart Guide

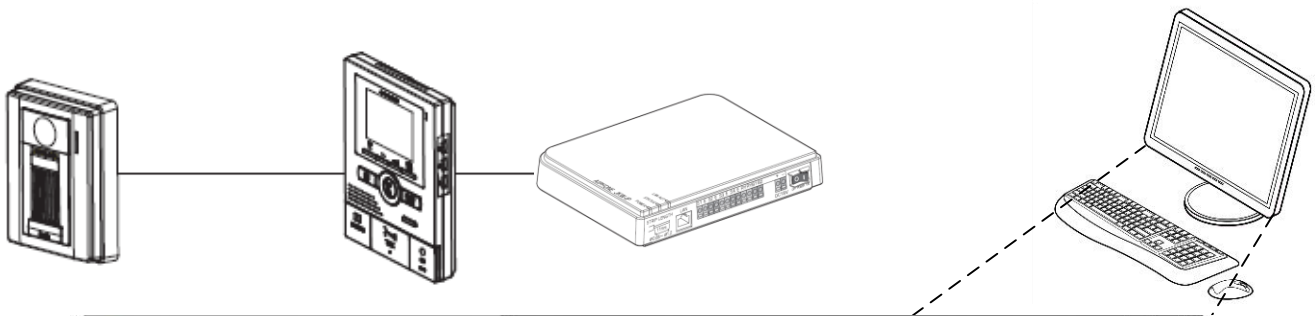

The screenshot shows the AIPHONE JKW-IP software interface. The left panel features a video feed area (currently black) labeled 'Front_Door'. Below the video are several control buttons: 'OPTION', 'CALL', 'MONITOR', 'TALK', 'OFF', 'ADJUST', and 'PC SETTING'. The right panel displays a table of sensor status.

No	Adaptor	Status	Sensor
1	Front_Door	<input checked="" type="checkbox"/>	1 2 3 4 M
2		<input type="checkbox"/>	1 2 3 4 M
3		<input type="checkbox"/>	1 2 3 4 M
4		<input type="checkbox"/>	1 2 3 4 M
5		<input type="checkbox"/>	1 2 3 4 M
6		<input type="checkbox"/>	1 2 3 4 M
7		<input type="checkbox"/>	1 2 3 4 M
8		<input type="checkbox"/>	1 2 3 4 M
9		<input type="checkbox"/>	1 2 3 4 M
10		<input type="checkbox"/>	1 2 3 4 M
11		<input type="checkbox"/>	1 2 3 4 M
12		<input type="checkbox"/>	1 2 3 4 M
13		<input type="checkbox"/>	1 2 3 4 M
14		<input type="checkbox"/>	1 2 3 4 M
15		<input type="checkbox"/>	1 2 3 4 M
16		<input type="checkbox"/>	1 2 3 4 M
17		<input type="checkbox"/>	1 2 3 4 M
18		<input type="checkbox"/>	1 2 3 4 M
19		<input type="checkbox"/>	1 2 3 4 M
20		<input type="checkbox"/>	1 2 3 4 M

1 GENERAL OVERVIEW AND WIRING

The following steps will be outlined in this QuikStart guide for setting up your PC and each JKW-IP adaptor. Please ensure that you follow these steps in order.

- Step 1:** Configure your PC's IP address (pg. 3)
- Step 2:** Configure the JKW-IP adaptor(s) IP address (pg. 4)
- Step 3:** Install the JKW-IP software (pg. 5)
- Step 4:** Register each adaptor (pg. 5)
- Optional:** Optional features (pgs. 6-8)

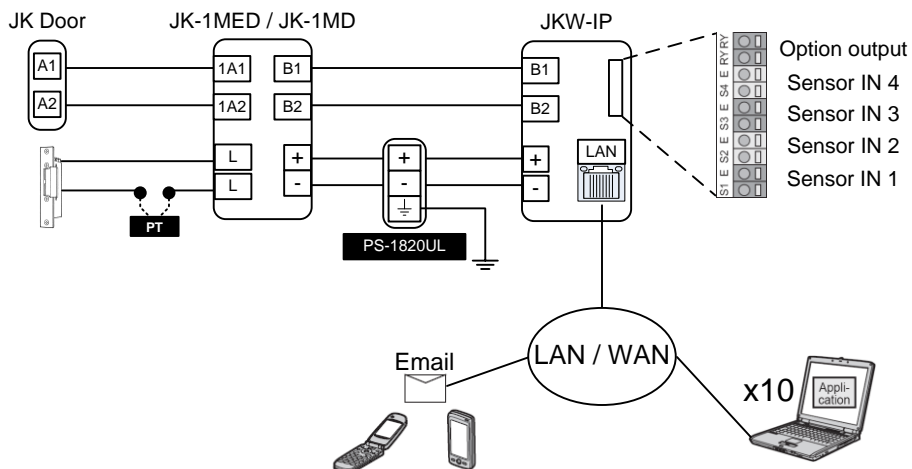

2 SOFTWARE SYSTEM REQUIREMENTS

The computer must meet the following system requirements to use the PC Application. For a complete list of precautions, notes on usage, and notices, please see the JKW-IP Operation Manual. Please refer to the JK-1MD or the JK-1MED instructions for other specification requirements, such as cabling method and conductor requirements.

OS	Software v 1.0.0	32-bit Microsoft Windows® XP (SP3), 32-bit Windows® Vista (SP1)
	Software v 1.2.0	32-bit and 64-bit Windows® XP (SP3), Vista (SP1), and Windows® 7
PC system Requirements	Processor: 2 GHz or faster System memory (RAM): 1 GB RAM or more Hard disk: 10 MB or more (additional space is needed for recording) Sound card: 8-bit full duplex, Direct Sound compatible Display: 1024 x 768 or greater Run-time: Microsoft(R).NET Framework 2.0 or later Network: 10BASE-T/100BASE-TX Ethernet	
Protocol	TCP/IPv4, UDP/IPv4, SIP, SMTP, Others	
Network bandwidth	320 k to 8 Mbps (per IP Video Intercom Adaptor)	
Language	English, French, Spanish, German, Dutch, Italian, Japanese	
Browser	Internet Explorer 6.0 or later (with Internet Options SSL 3.0 enabled)	

Note: Windows is the registered trademark of Microsoft Corporation in the United States and other countries.

3 SPECIFICATIONS

Power	18VDC, Shares power with the JK master monitor
Current consumption	Standby 110 mA, Maximum 200 mA
Communication	Hands-free / Priority transmission
Image Format	JPEG
Image Resolution	320x240 (QVGA)
Network Interface	10BASE-T/100BASE-TX Ethernet
Network Protocol	TCP/IP, UDP/IP, SIP
Email Authentication	SSL, CRAM-MD5 hash, or CLEAR (unencrypted).
Network Bandwidth	320 K to 8 Mbps (per IP Video Intercom Adaptor)
Operating Temperature	0°C to 40°C (+32°F to +104°F)
Dimensions	200 (H)×150 (W)×35.5 (D) mm 7-7/8 (H) x 5-15/16(W) x 1-7/16 (inches)
Weight	Main Unit: Approx. 370 g (0.82 lbs)
Color	White

Note: The PC Application is protected by intellectual property rights owned by International Systems Research Co.

Figure A: Network Connections in Control Panel

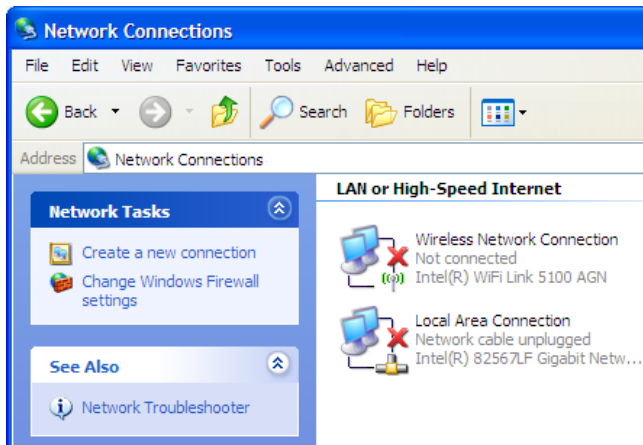

Figure B: Connection Status window

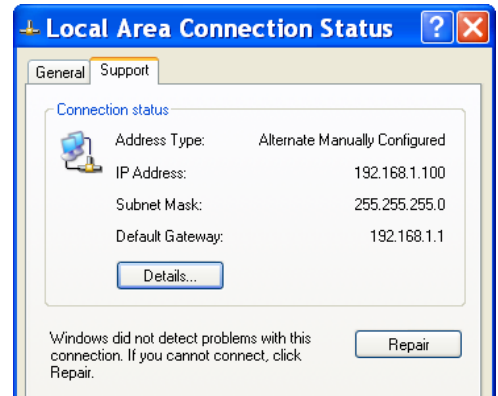

Figure C: Connection Properties

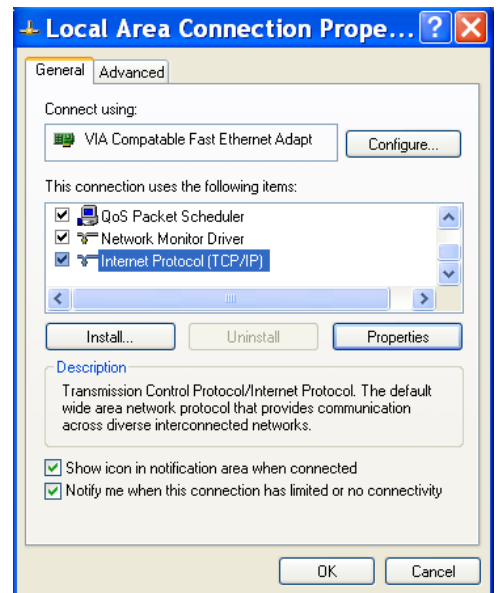
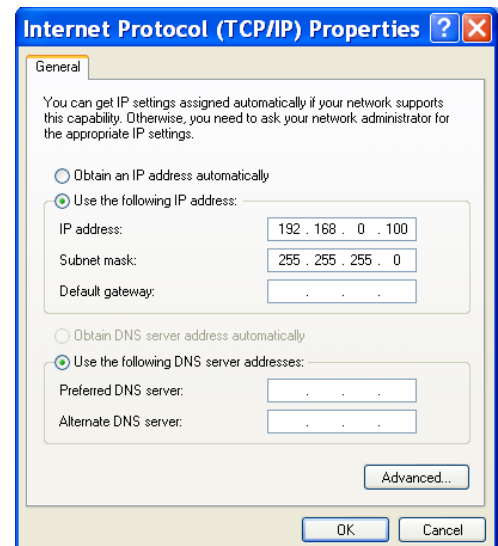

Figure D: TCP IP Properties



Step 1: Connect a PC to a hub, switch, or router and verify the computer's IP address.

- Open Control Panel and then open **Network Connections**, (see Figure A above "Network Connections") double click the **Local Area Connection** (or Wireless Connection if using one) to open the "Connection Status" window (see Figure B to the right "Connection Status")
- Left click the Support tab and check the IP address for this connection. **If the IP address starts with 192.168.0 and the subnet mask is 255.255.255.0 then skip to Step 2, otherwise continue to step "c" following:**
- In the Connection Status window, left click the General tab and then click the Properties button to open the "Connection Properties" window (see Figure C to the right "Connection Properties")
- Scroll down and left click the "Internet Protocol (TCP/IP)" line and click the **Properties** button to open the Internet Protocol TCP/IP Properties window (see Figure D to the right "Internet Protocol TCP/IP Properties")
- Select the radial button 'Use the following IP address' and then type in the **IP address 192.168.0.100** (the last number can be any valid host address except 30) and change the **subnet mask to 255.255.255.0, then click OK** in the Internet Properties (TCP/IP) Properties window
- Click OK in the Connection Properties window to accept these changes. Verify the new settings have been applied by viewing the Connection Status window's Support tab

The computer is now ready to setup each JKW-IP from the factory default settings.

5 HARDWARE CONFIGURATION

Step 2: Configure the adaptor by connecting it to the hub, switch, or router and doing the following:

- Open a web browser and point the address bar to <https://192.168.0.30> and hit Enter
- Click [OK] or [YES] for the any Security Alert messages (the wording will vary *see Figure 1 to the right "Certificate Error"*), then use the default Admin ID "aiphone" and Password "aiphone" at the login prompt
- Click the Admin tab and click on the [Setting] button next to Network (see Figure 2 to the right "Web Interface, Admin tab")
- Change the IP address, subnet mask, and default gateway. Turn OFF UPnP and specify the WAN / Global IP address to be the same as the IP address field above (this is considered the 'Public' IP Address for the adaptor, in most networks it will be the same as the adaptor's 'Local' IP address).
- Optional changes:

- Add a Primary DNS Server if using the email feature.
- When using network masquerading (or IP masquerading), specify the WAN / Global IP Address to be the Public IP Address for the adaptor and change the Connection, Web, Audio or Video ports as directed by the network administrator.
- Change Adaptor Name and note that the " _ " character can be used to create a space in the software's adaptor list.

- Click the [Save] button and then the [OK] button to restart the adaptor. The adaptor will power on with the new settings.

Repeat these steps with the next adaptor until every adaptor has a unique IP address and valid subnet mask.

Note: Changes to the adaptor in Step 2 a-f can be made as long as the LAN ACT light is lit solid.

Intercom functions will not work until system is wired per the diagram on page 2.

Status lights on JKW-IP









	Lit	Normal
	Blinking	Acquiring IP
	Off	Bad physical network connection
	Lit	Normal
	Blinking	Starting up, seeking JK Master
	Lit	On
	Blinking	No JK Master detected
	Off	Off

Figure 1: Certificate Error

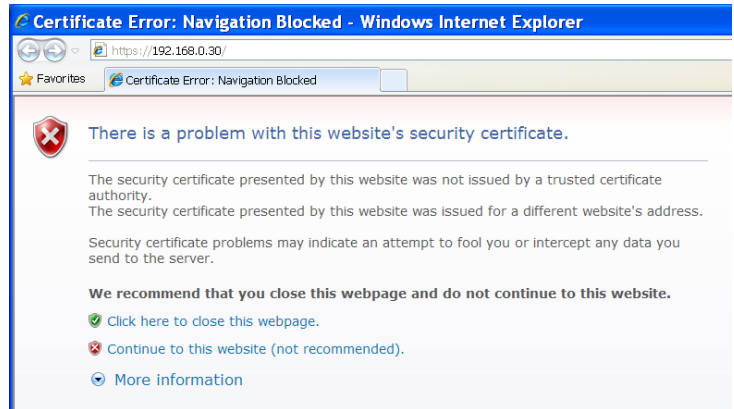

Figure 2: Web Interface Admin tab

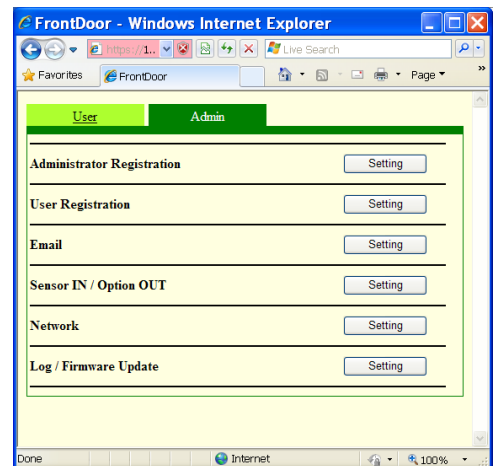
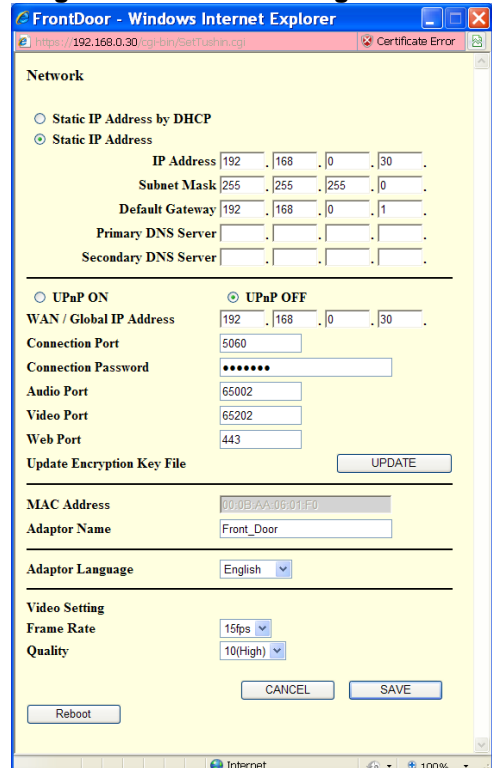

Figure 3: Network settings



6 SOFTWARE CONFIGURATION

Step 3: Install JKW-IP software on an Admin or User PC, using the supplied CD or download it from <http://www.aiphone.com>

Follow the prompts during installation. The exact prompts will vary depending on the existing software on the PC. When you see the “Browse for Folder” window, specify a valid folder to save recorded files to, such as Shared Documents (see *Figure 4 to the right “Saved Recordings”*).

After installation is complete, launch the program.

Step 4: Register each adaptor with the JKW-IP software. **Right-click** an empty slot in the Adaptor display and choose **Connect** from the drop down menu (see *Figure 5 to the right “Right click drop down menu”*).

This will open the Adaptor Registration window (see *Figure 6, to the right “Adaptor Registration”*).

- a. In the **Adaptor** box, enter:
 - **IP address of the adaptor** (or WAN IP address if one was specified in step 2)
 - **Connection Port** (if changed in step 2)
 - **Connection Password** (default is “aiphone”)
 - **Web Port** (if changed in step 2)
- b. In the **Admin User** box, enter Admin or User ID and password (defaults for Admin ID are both “aiphone”).
- c. In the **Network Interface Card: NIC** box, select the wired or wireless network interface card that connects the PC to the network containing this JKW-IP adaptor.
- d. In the **PC Application** box, **leave UPnP ON** unless using a network with NAT or IP Masquerading. If UPnP is turned off, enter the following for incoming data to use:
 - PC Local (LAN) IP address and any 3 ports not blocked by any firewall and not used by any other adaptor registered to this PC.
 - PC Public (WAN) IP Address and ports should be **the same as the above** unless the network admin says otherwise.

Click [OK] and repeat step 3 for each computer and 4 for each adaptor. Each adaptor’s name should appear on the list for the slot registered, and a status icon indicates the adaptor is ready to use.

Figure 7: Status Icon

No	Adaptor	Status
1	Front Door	
2		

Figure 4: Saved Recordings

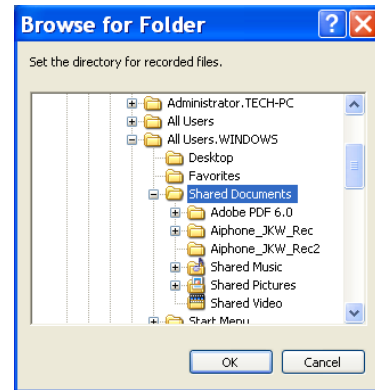

Figure 5: Right click drop down menu

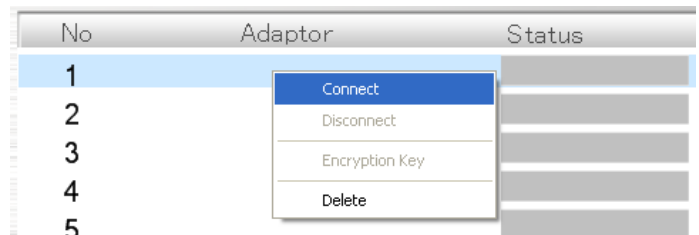

Figure 6: Adaptor Registration

7 OPTIONAL FEATURES

Optional Feature: Door Release. Select an adaptor from the Adaptor display list and do the following:

- Click the  button and accept any security warnings.
- In the User tab, next to **Encryption Key Down Load** click the [Download] button (see *Figure 8 to the right, "Web Interface, User tab"*).
- Click the [SAVE] button in the File Download window that opens (see *Figure 9 to the right "File Download window"*). Choose a memorable destination location on the user's hard drive and click [SAVE] and then close the browser.
- In the JKW-IP program's window, right click the adaptor in the Adaptor display and choose the **Encryption Key** option from the drop down menu (see *Figure 5 on page 5 "Right click drop down menu"*).
- Click the [.....] button and navigate to the location saved in step "c" and choose the file and click [SAVE] button (see *Figure 10 to the right "Encryption Key dialog"*).

Figure 8: Web Interface, User tab

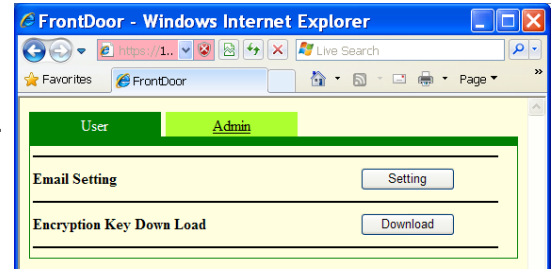

Figure 9: File Download window

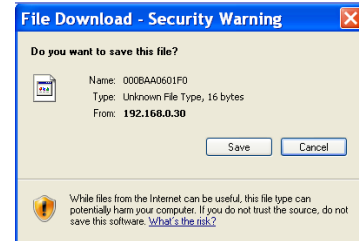

Figure 10: Encryption Key dialog

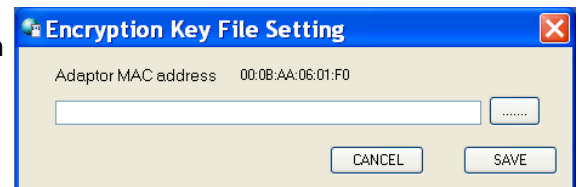
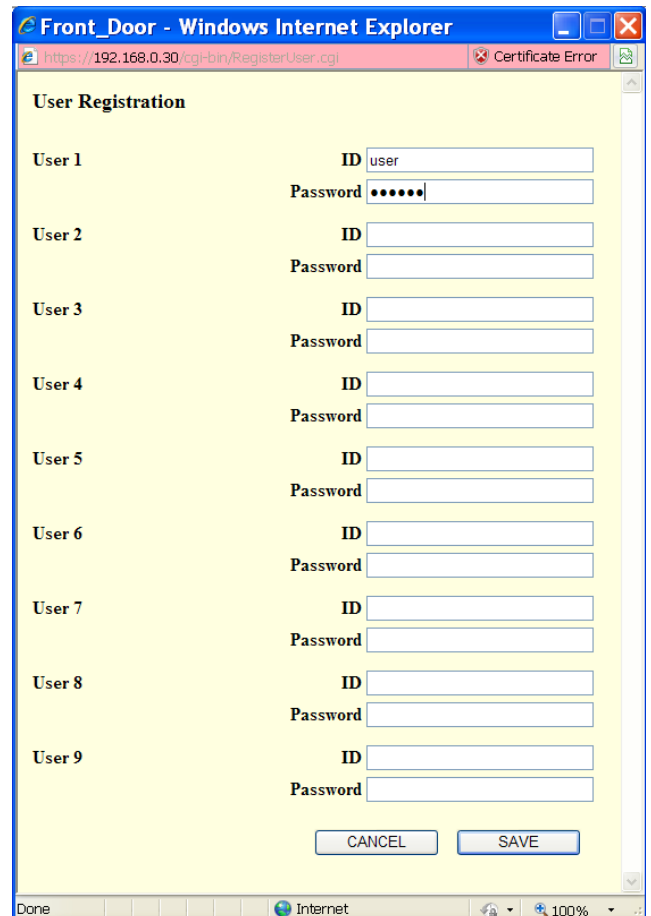

Figure 11: User Registration window



Optional Feature: User IDs. Configure user PC's to have limited access to adaptor's configuration via Admin tab of web interface. Select an adaptor from the Adaptor list and do the following:

- Click the [Settings] button and accept any security warnings (see *Figure 1 on page 4 "Certificate Error"*)
- Click the Admin tab, next to **User Registration** click the [Setting] button (see *Figure 11 to the right "User Registration window"*).
- Add (or modify) a User ID and a Password. Click the [SAVE] button to save and close this window.
- Close the web browser and go back to the JKW-IP Program, right click the adaptor's name and click **Disconnect** from the drop down menu (see *Figure 5 on page 5 "Right click drop down menu"*).
- Wait a few seconds and right click the adaptor's name and click **Connect** from the drop down menu
- Change the Admin User ID field to the new User ID and password added or modified in step "c", and click [OKAY] button to finish (see *figure 6 on page 5 "Adaptor Registration"*).

7 OPTIONAL FEATURES (continued)

Optional Feature: Email. Select an adaptor from the Adaptor display list and do the following:

- Click the **SETTINGS** button and accept any security warnings.
- In the Admin tab, next to **Email** click the [Setting] button (see Figure 2 on page 4, “Web Interface, Admin tab”).
- When the Email settings window opens (see Figure 12 to the right “Admin tab, Email window”), enter:
 - Adaptor Email Address** (sender address)
 - SMTP Server** (Fully Qualified Domain Name, see Step 2 “e” on page 4 for DNS servers)
 - Email login ID** and **SMTP Password**
 - SMTP Server Port** (default 25 when SSL is OFF; or use 465 when SSL is ON).
 - SSL** (turn ON only when SMTP authenticates using SSL, turn OFF when SMTP uses STARTTLS or is unencrypted).
- Click [SAVE] and then click the User tab.
- Press the [Setting] button next to **Email Setting**
- When the Email Setting window opens (see Figure 13 to the right “Email Setting window”), enter:
 - Email Address** (the destination address)
 - Next to **Door Call** click the radial button for **ON**
 - The other two events are optional
- Click [SAVE] and then close the browser.

Optional Feature: Auto Recording. Click the **PC SETTING** button, click the Preferences tab (see Figure 14 to the right “PC Settings window”) and do the following:

- Click the radial button for Video next to Picture Recording Mode
- Change the Max Recording Space field to 10GB (or less)
- Click the radial button for ON next to Auto Recording
(Optional) Click the radial button for ON next to Audio Recording to record audio during a manual recording
(Optional) Click the check box next to Maximize Application, Balloon Notification, Sensor Detection Tone and Call Tone
- Click [SAVE] to save settings and close the window.

NOTE: Press the [?] button for help and operating instructions.

Figure 12: Admin tab, Email window



Figure 13: User tab, Email Setting window

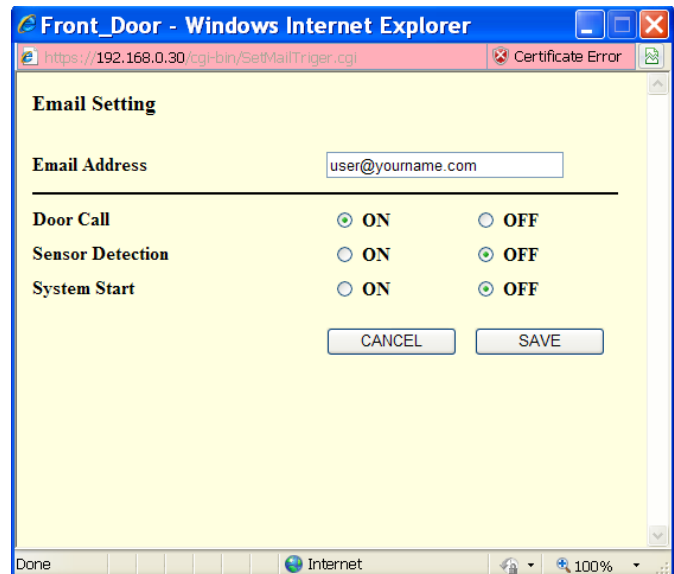

Figure 14: PC Settings window



7 OPTIONAL FEATURES (continued)

Figure 15: Sensor Event



Figure 16: Sensor Detection

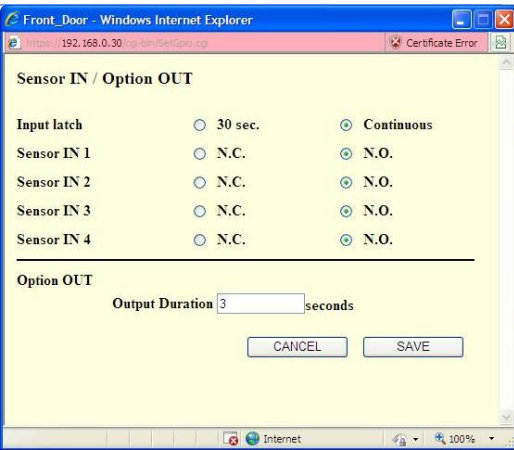

The four programmable Sensor inputs of a JKW-IP adaptor can receive a trigger from an external device such as an alarm. An admin can enable this feature in the web interface and change the Input latch notification duration from Continuous to 30 seconds.

- If enabled the Sensor Detection Tone will sound. To enable this feature click the  button and in the Preference tab put a check box next to Sensor Detection Tone.
- The status icon for the input will turn blue.
- The Message display will read **Adaptor Name** EXTERNAL INPUT No.
- An email will be sent, if this feature is on (*see page 7 Email*).
- Investigate the cause of the sensor notification (there may be an external alarm system), and then highlight the adaptor in the display and press the Off button to end the sensor notification.

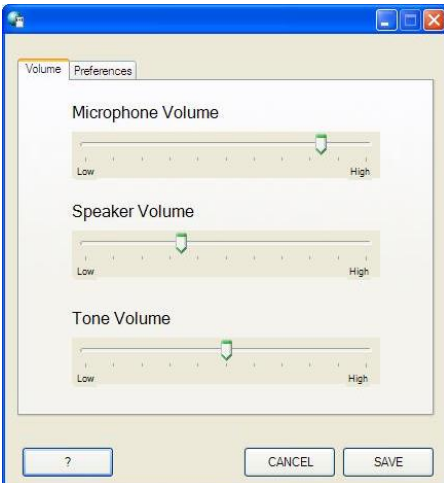

8 BASIC OPERATIONS

Figure 17: PC Settings, Volume tab



Press the [?] button for help and for additional operating instructions.

Press the call button on the JK door station. When you see the video of the guest, the following controls are available:

- To answer the call click the [Talk] button momentarily and you can speak hands free. The JK master station and any other computers will go back to standby, indicating the call has been answered.
- Display Adjustments - The Zoom/Wide, Adjust, and Pan and Tilt arrows can change the view as desired.
- Door Release – Release the door by clicking the  (Key) button. If the key turns , it worked.
NOTE: If door release does not work, follow *Steps a - e on page 6* to download and match a new Encryption Key.
- Off - When the conversation is complete, click [OFF] to return the door station back to Standby so it is ready for the next guest.

Press the  button to adjust the volumes for the Chime Tone, the Microphone for the PC and the Speaker for your PC.

WARRANTY

Aiphone warrants its products to be free from defects in material and workmanship under normal use and service for a period of one year after delivery to the ultimate user. We will repair free of charge or replace at no charge Aiphone product, that upon examination by an Aiphone Repair Technician is proven defective and under warranty. Aiphone reserves the right to make the final decision whether there is a defect in materials and/or workmanship; and whether or not the product is within the warranty.

This warranty covers bench repairs by the Aiphone Service Department only, and does not extend to units that have been repaired or altered outside of the factory. Aiphone is not responsible for any costs incurred involving on-site service calls. This warranty shall not apply to any Aiphone product that has been subjected to misuse, neglect, accident, power surge, or used in violation of instructions furnished.

Aiphone Communication Systems
1700 130th Ave. N.E.
Bellevue, WA 98005
(425) 455-0510
FAX (425) 455-0071

TOLL FREE TECHNICAL SUPPORT:
PHONE: (800) 692-0200
E-MAIL: tech@aiphone.com
www.aiphone.com

Pg. 8
JKW-IP QuikStart Guide
1210DM

Free Manuals Download Website

<http://myh66.com>

<http://usermanuals.us>

<http://www.somanuals.com>

<http://www.4manuals.cc>

<http://www.manual-lib.com>

<http://www.404manual.com>

<http://www.luxmanual.com>

<http://aubethermostatmanual.com>

Golf course search by state

<http://golfingnear.com>

Email search by domain

<http://emailbydomain.com>

Auto manuals search

<http://auto.somanuals.com>

TV manuals search

<http://tv.somanuals.com>