



# *Raven CDMA/1x*



## *User Guide*



**AirLink Communications, Inc.**

version 2.23

May 2006

---

Information in this document is subject to change without notice

©Copyright AirLink Communications, Inc., 1993-2006. All rights reserved.

### **WARNING**

The antenna(s) used for this transmitter must be installed to provide a separation distance of at least 20 cm from all persons and must not be co-located or operating in conjunction with any other antenna or transmitter.

### **Important Notice**

Because of the nature of wireless communications, transmission and reception of data can never be guaranteed. Data may be delayed, corrupted (i.e., have errors) or be totally lost. Although significant delays or losses of data are rare when wireless devices such as the AirLink Communications modem are used in a normal manner with a well-constructed network, the AirLink modem should not be used in situations where failure to transmit or receive data could result in damage of any kind to the user or any other party, including but not limited to personal injury, death, or loss of property. AirLink Communications, Inc., accepts no responsibility for damages of any kind resulting from delays or errors in data transmitted or received using the AirLink Communications modem, or for failure of the AirLink Communications modem to transmit or receive such data.

### **Safety and Hazards**

Do not operate the AirLink Communications modem in areas where blasting is in progress, where explosive atmospheres may be present, near medical equipment, near life support equipment, or any equipment which may be susceptible to any form of radio interference. In such areas, the AirLink Communications modem **MUST BE POWERED OFF**. The AirLink Communications modem can transmit signals that could interfere with this equipment. Do not operate the AirLink Communications modem in any aircraft, whether the aircraft is on the ground or in flight. In aircraft, the AirLink Communications modem **MUST BE POWERED OFF**. When operating, the AirLink Communications modem can transmit signals that could interfere with various on board systems. The driver or operator of any vehicle should not operate the AirLink Communications modem while in control of a vehicle. Doing so will detract from the driver or operator's control and operation of that vehicle. In some states and provinces, operating such communications devices while in control of a vehicle is an offence.

### **Limitation of Liability**

The information in this manual is subject to change without notice and does not represent a commitment on the part of AirLink Communications, Inc. AIRLINK COMMUNICATIONS, INC. SPECIFICALLY DISCLAIMS LIABILITY FOR ANY AND ALL DIRECT, INDIRECT, SPECIAL, GENERAL, INCIDENTAL, CONSEQUENTIAL, PUNITIVE OR EXEMPLARY DAMAGES INCLUDING, BUT NOT LIMITED TO, LOSS OF PROFITS OR REVENUE OR ANTICIPATED PROFITS OR REVENUE ARISING OUT OF THE USE OR INABILITY TO USE ANY AIRLINK COMMUNICATIONS, INC. PRODUCT, EVEN IF AIRLINK COMMUNICATIONS, INC. HAS BEEN ADVISED OF THE POSSIBILITY OF SUCH DAMAGES OR THEY ARE FORESEEABLE OR FOR CLAIMS BY ANY THIRD PARTY.

---

# Contents

---

<b>CHAPTER 1</b>	<b><i>Introduction to Raven CDMA</i></b>	<b>1</b>
	CDMA Overview	2
	Establishing a Internet Connection	2
	Using CDMA to Communicate with Your Equipment	3
	Common Uses for the Raven	4
<b>CHAPTER 2</b>	<b><i>Activation of the Raven CDMA</i></b>	<b>6</b>
	Connecting the Raven to your computer	6
	Quick Start Guide and Setup Wizard	6
	Activating the Raven using AT Commands	8
	Raven Indicator Lights	8
<b>CHAPTER 3</b>	<b><i>Utilities for the Raven</i></b>	<b>10</b>
	AirLink Configuration Executive (ACE)	11
	Wireless ACE 3G	11
	AceNet	12
	AceView	12
	Modem Doctor	14

<b>CHAPTER 4</b>	<b><i>IP Manager</i></b>	<b>15</b>
	Fully Qualified Domain Name	16
	Dynamic Name Resolution	16
	Configuring the Raven for Dynamic IP	17
	<i>Restrictions for Modem Name</i>	18
	DNS: Using Names Instead of IP addresses	19
	<i>Configuring DNS</i>	19
	<i>PPP-Peer</i>	20
<b>CHAPTER 5</b>	<b><i>Keepalive</i></b>	<b>21</b>
	Configuring Keepalive	21
	Data usage using Keepalive	22
<b>CHAPTER 6</b>	<b><i>Host Modes</i></b>	<b>23</b>
	AT Mode	24
	PassThru Mode	25
	PPP Mode	26
	Slip Mode	26
	UDP Pad Mode	27
	<i>UDP Auto Answer</i>	27
	<i>Reliable UDP</i>	28
	<i>Multicast UDP</i>	29
	TCP PAD Mode	29
	<i>TCP Auto Answer</i>	30
	Hybrid Modes	30
<b>CHAPTER 7</b>	<b><i>Modbus/BSAP Configuration</i></b>	<b>32</b>
	Modbus Overview	32
	<i>Telemetry</i>	33
	<i>Remote Terminal Unit (RTU)</i>	33
	<i>Supervisory Control and Data Acquisition (SCADA)</i>	33
	<i>Programmable Logic Controller (PLC)</i>	33
	<i>Modbus TCP/IP</i>	34
	<i>Raven Modbus on UDP</i>	34
	Configuring the Raven at the Polling Host for Modbus on UDP	35
	<i>Port</i>	35
	<i>Default Power-up Mode</i>	35

<i>IDs to IPs</i> .....	36
<i>Dynamic IP</i> .....	36
Configuring the Remote Ravens for Modbus with UDP .....	37
<i>Port</i> .....	37
<i>Default Power-up Mode</i> .....	38
<i>Host Raven IP</i> .....	38
<i>Dynamic IPs</i> .....	38
<i>RTU settings</i> .....	39
<b>CHAPTER 8 <i>Simple Network Management Protocol (SNMP)</i></b> .....	<b>41</b>
SNMP Overview .....	41
<i>Management Information Base (MIB)</i> .....	42
<i>SNMP Traps</i> .....	42
Raven SNMP Configuration .....	42
<i>Listening Port</i> .....	42
<i>Security Level</i> .....	43
<i>User Name and Password</i> .....	43
<i>Trap Destination</i> .....	45
<b>CHAPTER 9 <i>Hardware Installation</i></b> .....	<b>46</b>
Connecting the Antenna .....	46
Connecting power .....	47
Connecting the Raven to a computer or other device .....	47
<b>APPENDIX 1 <i>Specifications for the Raven CDMA</i></b> .....	<b>48</b>
<i>Physical Characteristics:</i> .....	48
<i>Data Services &amp; RF Features: CDMA</i> .....	48
<i>Environmental:</i> .....	48
<i>Power Management:</i> .....	49
<i>Power consumption</i> .....	49
<b>APPENDIX 2 <i>Mounting Kit</i></b> .....	<b>51</b>
<b>APPENDIX 3 <i>AT Commands</i></b> .....	<b>53</b>
Using Wireless Ace .....	53
Using Telnet Terminal Emulation .....	54
Direct Serial Connection .....	56
AT Command Tables .....	57
<i>Information Commands</i> .....	58

<i>Basic Commands</i> .....	61
<i>Activation</i> .....	62
<i>Cellular Network</i> .....	64
<i>Local Network and Host Modes</i> .....	65
<i>PassThru</i> .....	65
<i>Direct Communication</i> .....	72
<i>Telnet</i> .....	73
<i>Time/Date</i> .....	76
<i>Friends Mode</i> .....	77
<i>DNS</i> .....	77
<i>Keepalive</i> .....	78
<i>IP Manager</i> .....	79
<i>Logging</i> .....	82
<i>Modbus</i> .....	82
<i>SNMP (Simple Network Management Protocol)</i> .....	85
<i>SMTP/SMS</i> .....	86
<i>Other</i> .....	89
<b>APPENDIX 4 <i>Example of the MIB trap</i></b> .....	<b>91</b>
<b><i>Troubleshooting</i></b> .....	<b>100</b>
Frequently Asked Questions (FAQ) and Solutions .....	100
<i>What is RSSI? Why is the RSSI for my Raven negative?</i> .....	100
<i>What is the Proper RF Coverage for my Raven?</i> .....	101
<i>What Type of Antenna is Best for my Raven?</i> .....	101
<i>What do I need to power my Raven ?</i> .....	102
<i>Can I use a portable battery to power my Raven ?</i> .....	102
<i>I'm Having Problems getting my Raven registered (activated or provisioned) with Verizon, what could be the problem?</i> .....	103
<i>Why Can't I reach my Raven from the Internet? What is a Restricted or Private IP?</i> <b>103</b>	
<i>What is the difference between Private Mode and Public Mode?</i> .....	103
<i>How do I set up Private Mode? How do I connect to my Raven to my router or to Linux?</i> .....	104
<i>What is the COM1000?</i> .....	105
<i>How can I update the PRL (Preferred Roaming List) for my CDMA modem? I have activated my Raven but now cannot connect to Verizon, what can be wrong?</i> ..	106
Support web site .....	109
Contacting Technical Support .....	109

# *Introduction to Raven CDMA*

---

The Raven's rugged form factor is ideal for industrial and commercial applications that require real-time communications. The Raven provides cellular data communications for a variety of applications, such as telemetry, public safety, SCADA, traffic control, traffic metering, transit arrival systems and more.

**FIGURE 1. Raven front and back**



## *CDMA Overview*

Code Division Multiple Access (CDMA) provides a digital cellular telephony system provides wireless Internet access at speeds between 60 and 80 kbps, with bursts up to 144 kbps.

## *Establishing a Internet Connection*

The Internet Service Provider (ISP) from you to the Internet is Verizon with your Raven as the connection to Verizon.

When your Raven is powered on, it automatically searches for cellular service using CDMA and establishes a PPP (Point to Point Protocol or “dial” up connection) link to Verizon’s network. As soon as the Raven receives its IP, it’s ready to create a network between your computer or device and Verizon’s network so you can use Verizon to communicate on the Internet.

To use your Raven to connect to the Internet from your computer, you need to connect the computer directly to the Raven’s serial port and use Dial-Up Networking (DUN).

**FIGURE 2. Using the Raven to connect to the Internet**

---

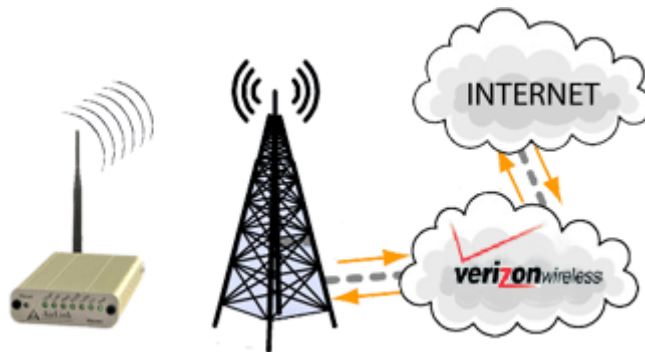





**Note:** Private network connections are unique for each configuration and not covered as part of the standard installation.

---

## *Using CDMA to Communicate with Your Equipment*

There are two types of addresses in TCP/IP, dynamic and static.

- Dynamic addresses are assigned on a “need to have” basis. Your Raven might not always receive the same address each time it connects with Verizon.
- Static addresses are permanently assigned to a particular account and will always be used whenever your Raven connects to the Internet. The IP address will not be given to anyone else.

If you need to contact the Raven, a device connected to the modem, or a host system using the modem, you need to have a known IP (such as one which is static) or domain name (an IP address which is converted by a DNS server into a word based name).

Most ISPs (cellular included) use dynamic IP addresses rather than static IP addresses. A dynamic IP address is suitable for many common Internet uses, such as web browsing, looking up data on another computer system, or other client function (such as data only being sent out or only being received after an initial request).



**Note:** If you have a dynamic IP address for your Raven, you can use a Dynamic DNS service (such as IP Manager coupled with a Dynamic DNS Server, covered later in this User Guide) to translate a dynamic IP address to a fully qualified domain name so you can contact the Raven as if it had a static IP.



**Caution:** The IP address given to your Raven by Verizon must also be Internet routable if the computer you need to connect to the Raven is not connected directly to Verizon's IP network. Please check with Verizon to confirm you IP is scheme is correct for your application and needs.

### *Common Uses for the Raven*

The Raven's rugged construction and cellular connection make it ideal for use in remote and/or industrial locations.

The Raven can be used for telemetry and for more advanced communication to the device or devices behind it.

**FIGURE 3. Financial Point of Sale and Kiosk**



**FIGURE 4. Automation and Telemetry**

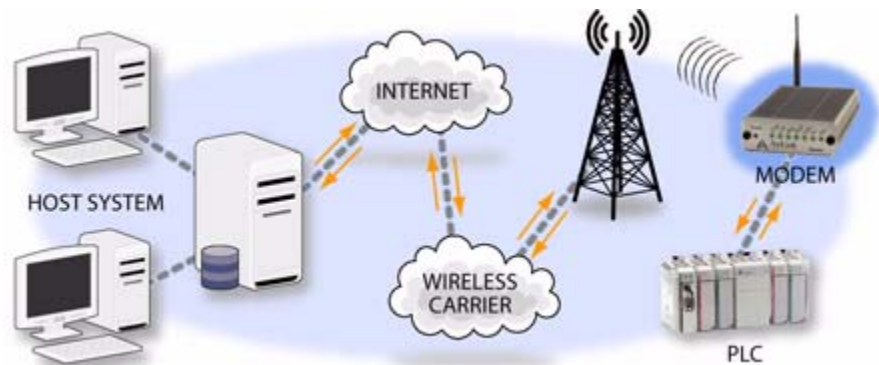

**FIGURE 5. Backup connection to the Internet**

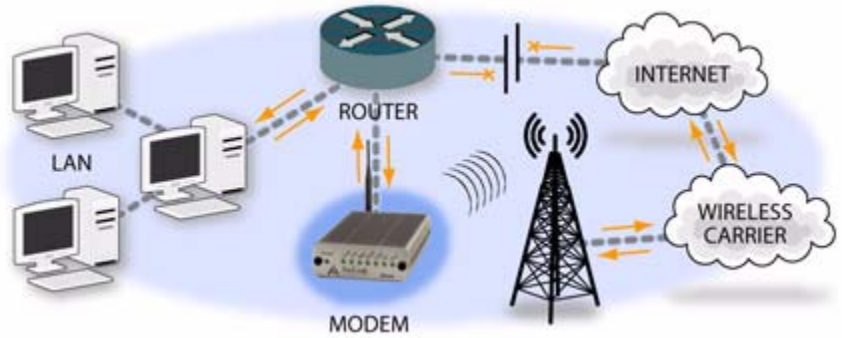

# *Activation of the Raven CDMA*

---

Your Raven needs specific parameters before it can operate on the CDMA network. Generally Verizon will provide you with the necessary parameters to get the Raven configured.

---

## *Connecting the Raven to your computer*

Your Raven's serial port can be connected directly to most computers or devices using a standard straight through serial cable.

---

## *Quick Start Guide and Setup Wizard*

The preferred way to configure and activate your Raven is via the AirLink Setup Wizard for Verizon and CDMA. The Quick Start Guide will lead you through the using the Setup Wizard.

- The Raven Setup Wizard for CDMA and Verizon is available from the AirLink web site, <http://www.airlink.com/support>.
- The Quick Start Guide is also available at the AirLink web site.



**Note:** The web site may have a more recent Setup Wizard and Quick Start Guide than those included with your Raven. It is recommended that you check with the web site for the latest version before installing your Raven. You will need to look for Verizon, CDMA, and the Raven. Other Setup Wizards may not work to connect you to Verizon.

To run the Setup Wizard, you will need the Microsoft .NET framework and Microsoft Windows 98, Microsoft Windows 2000, Microsoft Windows XP, or later.

1. Select **Start**.
2. Select **All Programs**.
3. Select **AirLink Communications**.
4. Select **Setup Wizard**.
5. Select **Setup Wizard**.

**FIGURE 1. Setup Wizard**



The Quick Start Guide specifies the information you need and will lead you through the steps.

## *Activating the Raven using AT Commands*

An alternate method to configure and activate your Raven is by AT commands (full listing beginning on page 53) sent directly to the modem via a terminal application. This method is recommended only in situations where the Setup Wizard is not available and/or the configuration for the Raven is unusual.



**Caution:** While you can configure your Raven using Wireless ACE (page 10) or AceNet (page 11), it is not recommended to activate the Raven using either Wireless ACE or AceNet.

---

## *Raven Indicator Lights*

When your Raven is connected to power and an antenna, there is a specific pattern to the lights to indicate its operation mode.

**FIGURE 2. Raven indicator lights**



**Tx** (transmit) and **Rx** (receive) - Lights will flash as data is transferred to and from the Raven on the remote network.

**RSSI** - Light shows the strength of the signal and may be nearly solid (strong signal) or flashing (weaker signal). A slow flash indicates a very weak signal.

**Reg** - Indicates the Raven has acquired an IP from Verizon.

**Chan** - Indicates the modem has acquired a network channel.

**Link** - Indicate a successful connection to the cellular network.

**Pwr** - Indicates the power adapter is connected and there is power getting to the modem.

The **Reset** button performs the same function as unplugging power from the modem and plugging it back in. Reset will not alter any saved configuration settings.

---

AirLink offers a suite of utilities to optimize your Raven's performance, allowing you to remotely view status and make changes to the configuration as needed.

- AceView
- Wireless ACE 3G
- AceNet
- Modem Doctor

This section of the Raven User Guide covers basic information about these utilities. For additional information on a specific utility, please refer to the user guide for that utility.

These utilities, except AceNet, are free of charge to those who own AirLink modems. You can download the utilities and their user guides from the AirLink web site: <http://www.airlink.com/support>. Contact your dealer or AirLink representative for information on AceNet.



**Note:** AceView, Wireless ACE 3G, and AceNet require the Microsoft .NET Framework and Microsoft Windows 98, Windows 2000, Windows XP, or later.





You can obtain the Microsoft .Net Framework, Microsoft Internet Explorer, and/or the latest ActiveX updates for Internet Explorer from Microsoft at: <http://www.microsoft.com/>.

## AirLink Configuration Executive (ACE)

The AirLink Configuration Executive provides a user friendly interaction with ALEOS, the brains of your Raven.



### Wireless ACE 3G

Wireless ACE 3G allow you to monitor your Raven either remotely or locally with a direct connection to the modem.



**Note:** Most configuration screen shots in this guide are using Wireless ACE 3G.

FIGURE 1. Wireless ACE 3G

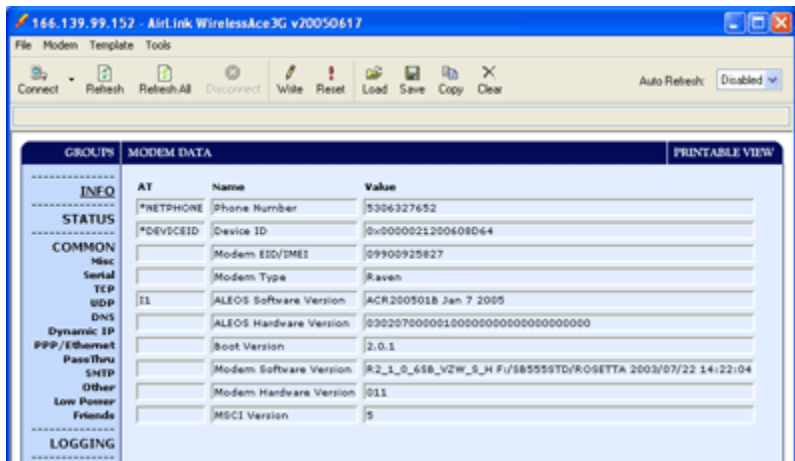



### AceNet

With AceNet you can monitor several AirLink modems at the same time. The modems can be connected locally or remote. Several features can be displayed and logged. AceNet is a separate product which can be purchased from AirLink.

**FIGURE 2. AceNet**

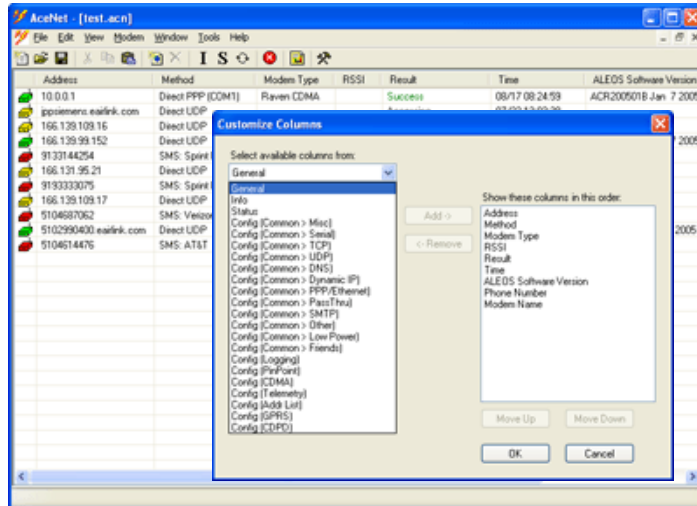

Using a template from Wireless ACE, you can change the configuration in several modems at the same time and can check and update their firmware as well. AceNet also features logging to a database and charting for the monitored modems.

With AceNet, you can connect to modems locally or remotely with TCP/IP or SMS.



### AceView

AceView is a low-profile monitoring tool to view the status of your AirLink Raven and display network status, IP address, RSSI strength, firmware version, and other basic information.

**FIGURE 3. AceView**

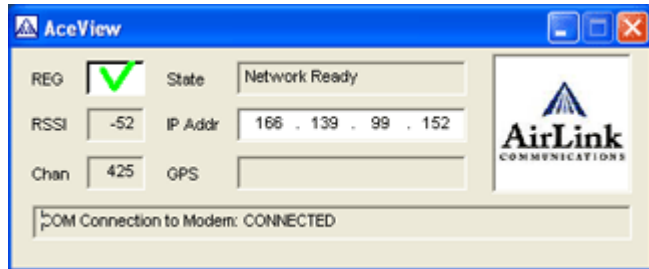

You can connect to your Raven locally or remotely using a known IP address or a fully qualified domain name. The display is updated periodically as AceView polls the Raven at a specified interval. *GPS is available only for PinPoint and PinPoint-E modems.*

**FIGURE 4. AceView: About Modem**





## Modem Doctor

Modem Doctor is a troubleshooting utility. This utility will allow you to get a log file of the Raven activity which you can then send to AirLink support, erase the current configuration completely, and temporarily set the Raven to a known serial configuration to aid in trouble shooting.

FIGURE 5. Modem Doctor

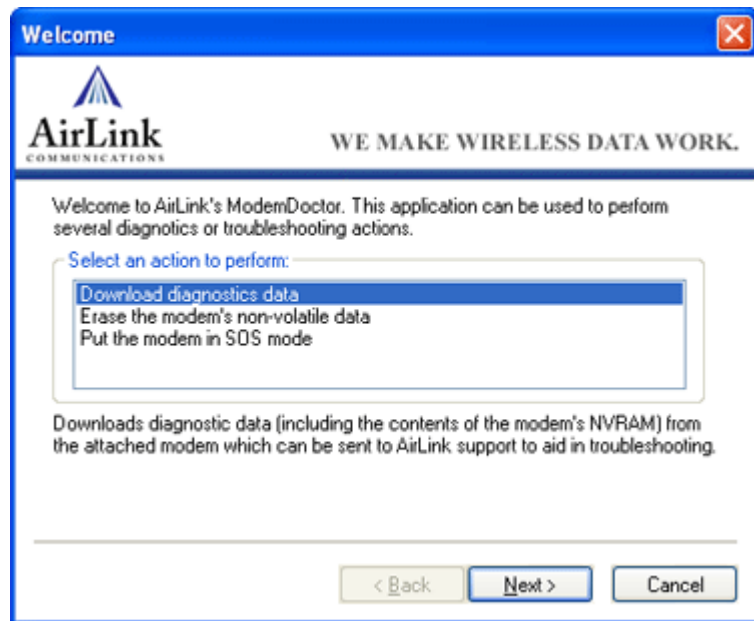

---

IP Manager translates a dynamic IP address to a fully qualified domain name so you can contact your Raven by name as if it had a static IP.

Since Wireless Service Providers frequently do not offer static IP addresses, IP Manager is a free service provided by AirLink for your Raven to translate a dynamic IP address into a fully qualified domain name so it can be contacted directly on the Internet.

- Dynamic IP addresses are granted only when a modem or other device is connected and can change each time the modem or device reconnects to the network.
- Static IP addresses are granted the same address every time the modem or device is connected and are not in use when the associated device is not connected.

A dynamic IP address is suitable for many Internet activities such as web browsing, looking up data on another computer system, data only being sent out, or data only being received after an initial request. However, if you need to contact the Raven directly, a device connected to the modem, or a host system using the Raven, a dynamic IP won't give you a reliable address to contact (since it may have changed since the last time it was assigned).

---

## *Fully Qualified Domain Name*

A fully qualified domain name (FQDN) generally has several parts.

- **Top Level Domain (TLD):** The TLD is the ending suffix for a domain name (.com, .net, .org, etc.)
- **Country Code Top Level Domain (ccTLD):** This suffix is often used after the TLD for most countries *except the US* (.ca, .uk, .au, etc.)
- **Domain name:** This is the name registered with ICANN (Internet Corporation for Assigned Names and Numbers) or the registry for a the country of the ccTLD (i.e. if a domain is part of the .ca TLD, it would be registered with the Canadian domain registry). It is necessary to have a name registered before it can be used.
- **Sub-domain or server name:** A domain name can have many sub-domain or server names associated with it. Sub-domains need to be registered with the domain, but do not need to be registered with ICANN or any other registry. It is the responsibility of a domain to keep track of its own subs.

A URL (Universal Resource Locator) is different from a domain name in that it also indicates information on the protocol used by a web browser to contact that address, such as `http://www.airlink.com`.

- **.com** is the TLD
- **airlink** is the domain (usually noted as `airlink.com` since the domain is specific to the TLD)
- **www** is the server registered with `AirLink.com`
- **http://** is the protocol (html or web) used to access the webpage for `AirLink`

---

## *Dynamic Name Resolution*

When an IP address is not expected to change, the DNS server can indicate to all queries that the address can be cached and not looked up for a long period of time. Dynamic DNS servers, conversely, have a short caching period for the domain information to prevent other Internet sites or queries from using the old information.

If the Raven is configured for Dynamic IP, when the Raven first connects to the Internet, it sends a IP change notification to IP Manager. IP Manger will acknowledge the change and update the DNS record. The changed IP address will then be the address for the Raven's configured name.

Once the Raven's IP has been updated in IP Manager, it can be contacted via name. If the IP address is needed, you can use the domain name to determine the IP address.



**Note:** The fully qualified domain name of the Raven will be a subdomain of the domain used by the IP Manager server.



As a free service, Airlink maintains an IP Manager server which can be used for any AirLink modem. The domain is [earlink.com](http://earlink.com) and is used in all the samples below.

---

### *Configuring the Raven for Dynamic IP*

To configure the Dynamic IP settings in your Raven so that it will use IP Manager, you can use AT commands (page 53), using direct serial communication or Telnet, Wireless ACE (page 10), and ACE Net (page 11) using a template built from Wireless ACE.

To configure your AirLink modem to be addressed by name, the modem needs to have 4 elements configured.

In Wireless ACE, select **Dynamic IP** to configure your modem to use IP Manager.

**FIGURE 1. Wireless ACE: Dynamic IP (IP Manager configuration)**

*MODEMNAME	Modem Name	dogwatcher1	dogwatcher1
*DOMAIN	Domain	eairlink.com	eairlink.com
*IPMANAGER1	IP Manager Server 1 (IP Adrs)	eairlink.com	eairlink.com
*IPMGRUPDATE1	IPMServer1 Update (Minutes)	0	0
*IPMANAGER2	IP Manager Server 2 (IP Adrs)		
*IPMGRUPDATE2	IPMServer2 Update (Minutes)	0	

1. **Modem name:** The name you want for the modem.
2. **Domain:** The domain name to be used by the modem.
3. **IP Manager IP Address:** The IP or domain name of the dynamic DNS server which is running IP Manager.



**Note:** To use the name here instead of the IP, you need to have DNS set up in your Raven (page 19).

4. **IP Manager update interval:** How often you want the address sent to IP Manager. If this is set to zero, the modem will only send an update if the IP changes (i.e. if the modem is reset or is assigned a different IP).

You can configure a second dynamic server as a backup, secondary, or alternate server.



**Note:** For the Modem Name, you should use something which is unique but also easy to remember. Your company name or the intended function of the modem are recommended. If you have more than one modem, you can append a number for each.

### Restrictions for Modem Name

- Must begin with a letter or number
- Can include a hyphen (-)
- Cannot contain spaces
- Must be no longer than 20 characters total



---

## *DNS: Using Names Instead of IP addresses*

A domain name is a name of a server or device on the Internet which is associated, generally, with an IP address. In a way, a domain name is like the street address of your house with the phone number being like the IP address. You can contact the house either by going to the address (name) or by calling the phone number (IP address).

Domain Name Service (DNS) is a network service which translates, or redirects, the IP address, allowing someone to contact that address via the name. A DNS server is registered to handle all addresses of a particular domain (much like the post office for a particular town or city is known to the post offices of all other towns and cities and is authorized to give the addresses of locations in its own location).

### **Configuring DNS**

The Raven has an internal DNS resolver with which it can query DNS servers in order to translate names into IP addresses which it can then use internally. Generally, when your Raven receives its IP address from Verizon, it will also be configured to use Verizon's DNS servers to use for resolving (or translating) names to IP addresses. In that case, the only one which is not overwritten is the alternate DNS.

You can use AT commands (page 53), Wireless ACE (page 10), and ACE Net (page 11) using a template built from Wireless ACE to configure DNS in your Raven.

**FIGURE 2. Wireless ACE: DNS**

---

*DNS1	Modem DNS Server 1	0.0.0.0	66.174.6.7
*DNS2	Modem DNS Server 2	0.0.0.0	66.174.3.7
*DNSUSER	Use Alternate DNS	0.0.0.0	0.0.0.0
*DNSUPDATE	DNS Updates	0	0-Disable

**\*DNS1** and **\*DNS2** - Set these to your primary and secondary DNS servers. These may be overwritten by Verizon when your Raven gets its IP address.

**\*DNSUSER** - Set this, if desired, to an additional DNS server to query first before the primary or secondary (just as a hosts file is queried first on a computer). If **\*DNSUSER** is set to 0.0.0.0, it will be ignored.

**\*DNSUPDATE** - This command sets how often you want DNS Updates to be forced. Otherwise the Raven will only send updates when it is reset, powered up, or the IP address granted by the network changes.



**Note:** If you will be using your Raven to communicate with another AirLink modem and both are using IP Manager to translate dynamic IP addresses to domain names, it is recommended that you set **\*DNSUSER** to the IP address for IP Manager. IP Manager's updates occur more frequently than Verizon's DNS servers decreasing the time between IP address change and address resolution.

### **PPP-Peer**

The Raven uses the unqualified domain name of "ppp-peer" when it is PPP or SLIP address mode to resolve the address of the device or computer connected via PPP or SLIP address. If the Raven is not in PPP or SLIP address mode, "ppp-peer" will resolve to 0.0.0.0.

---

It is not uncommon for your Raven to be disconnected from Verizon after an extended period of inactivity. This is generally a feature intended to reduce your charges for inactive use.

Keepalive is used to test and maintain the Raven's connection to Verizon by pinging an IP address after a specified period of inactivity. Keepalive is recommended for users who have a remote terminated modem that infrequently communicates to the network. Keepalive is also recommended if you have experienced issues where the modem can no longer be reached remotely.

When Keepalive pings the IP address, an acknowledgement indicates there is an active connection to the network. If the modem does not receive a response from the IP address, it will retry 5 times in 5 second intervals. The Raven will then reset the radio module after 5 failed attempts and reconnect to Verizon.

---

### *Configuring Keepalive*

As with all other aspects of the Raven's configuration, you can use Wireless Ace (page 10), AceNet (page 11), direct serial communication (page 53), or Telnet (page 53) to configure Keepalive.

To set the Keepalive using Wireless ACE, select **Other** from the menu on the left.

**FIGURE 1. Wireless ACE: Keepalive Configuration**

---

AT	Name	Value	New Value
*IPPING	Keepalive Ping Time	0	60
*IPPINGADDR	Keepalive Ping Address		192.168.0.222

**\*IPPING** sets the interval, in minutes, you want Keepalive to test the network connection. To disable Keepalive, set \*IPPING to 0 (default setting).



**Note:** 15 minutes is the minimum time which can be set for Keepalive.

**\*IPPINGADDR** sets the IP address you want to use for the test. If \*IPPINGADDR is left blank or is set to an invalid IP address (i.e. an IP which is unreachable or one which is not a valid IP address), the modem will reset itself on a regular interval.

---

### *Data usage using Keepalive*

When using Keepalive, be aware that a ping moves approximately 66 bytes of data over the network and is billable by the carrier. The following \*IPPING settings will incur approximate monthly data usage in addition to any other data usage:

15 minutes	400k / month
30 minutes	200k / month
60 minutes	100k / month
120 minutes	50k / month

---

The Raven plays the part of a host when its serial port is connected to a computer or another device. As the host, the Raven can be in one of six communication modes.

**AT:** The Raven accepts and responds to standard, Hayes-style AT commands.

**PassThru:** Direct connection to internal hardware (OEM Module) of the Raven.

**PPP:** The Raven uses PPP to communicate.

**SLIP:** The Raven uses SLIP to communicate.

**UDP PAD:** Any data received on the serial port is assembled into UDP packets and sent to the session's associated IP and Port (described later). Any responses received from the associated IP and port destined for the modem's Device Port are unwrapped and sent out the serial port.

**TCP PAD:** Any data received on the serial port is packaged into TCP messages and sent to the associated connection's IP and Port (described later). Any data received from the TCP peer is unwrapped and sent out the serial port.

By default, the Raven is in AT Mode and allows AT Commands to be entered via Telnet (through the serial port connection) or remotely (through the cellular network).

The Raven can be programmed to enter any of the modes, except PassThru, automatically on power up. This is done setting the Startup Mode Default (refer to **MD**

in the AT Command listing, page 66) to the desired mode. If this setting is non-zero, the modem will enter the specified mode after 5 seconds. If you want to cancel this behavior, the **ATMD0** command can be used before the 5-second time-out expires.

If the modem is in any mode other than AT or PassThru, the AT command mode can be re-entered by:

- Deactivating DTR (if &D2 or Ignore DTR, S211, is not set).
- Issuing the +++ escape sequence (if Disable AT Escape, DAE, is not set).
- Resetting or Power cycling the modem.

PassThru Mode can only be exited by resetting the modem.



**Note:** DTR needs to be asserted (S211=1 or &D0) by the host before PPP Mode, SLIP Mode, UDP PAD Mode, or TCP PAD Mode can be entered.

---

## *AT Mode*

AT commands are used to configure the modem, command it to do something, or query a setting. For a full listing of the AT commands, refer to page 53.

AT commands must always be terminated by <CR> (ASCII character 0x0D).

If **E=1** (Echo On), the AT command (including the terminating <CR>) will be displayed (output) before any responses.

Two settings affect the format of AT command output: V (Verbose) and Q (Quiet).

If **Q=1** (Quiet On), no result codes are output whatsoever, so there is no response generated by a (non query) command.

If **Q=0** (Quiet Off), result codes are output. The format of this output is then affected by the Verbose setting.

If Quiet mode is off, the result code is affected as follows:

For **V=1** (Verbose mode), the textual result code is surrounded by <CR><LF> and any AT query response is also surrounded by <CR><LF>.

For **V=0** (Terse mode), a numeric result code is output with a single trailing <CR> (no <LF> is output), while any AT query response is followed by <CR><LF> (there is no preceding output).

For example, possible output to the AT command "AT<CR>" (assuming quiet mode is not on) is:

<CR> - if V=0

<CR><LF>OK<CR><LF> - if V=1

---

## *PassThru Mode*

In PassThru mode, the Raven does not behave normally, all serial port communication is passed directly between the internal hardware and the computer connected directly to the modem. This mode can be used to configure hardware-specific settings (e.g., for provisioning, etc.).

Issuing the "AT\APASSTHRU" enters this mode. The modem responds with **OK**, at which point a direct connection to the internal hardware is established.

Some internal hardware requires upwards of 20 seconds before AT commands can be entered, so be patient if there seems to be no response to AT commands.



**Caution:** PassThru can only be exited by resetting or power-cycling the modem. This mode cannot be entered via a Telnet session.

PassThru Mode allows only specific AT commands. Those commands which are used with ALEOS only will be unavailable. The commands usable also depend heavily on the modem model number (found on the label on the top of the modem).



**Caution:** ALEOS is disabled in PassThru Mode. You cannot use most ALEOS specific commands while the modem is in PassThru Mode.

---

### *PPP Mode*

In PPP mode, the Raven acts as a PPP server, providing an IP address, and DNS servers (if available) to the Host.

PPP mode is entered from the AT mode by using any of the following commands:

```
AT\APPP<CR>
ATDT10.0.0.1<CR>
ATDT10001<CR>
ATD#19788<CR>
CLIENT<CR>
```

In response to any of the preceding commands, the modem will respond with **CONNECT**<CR><lf> and is ready for the host to begin PPP negotiations.

The IP received by the host in the resulting negotiation will either be a private (non-routable) IP or a public (network-routable) IP provided by the network, depending on the settings of **\*HOSTPRIVMODE**. If **\*HOSTPRIVMODE=1**, the value of the private IP can be determined beforehand by querying **S110**. The private IP to be used can be defined with the command **AT\*HOSTPRIVIP=192.168.100.33** substituting the desired IP address.

**AT\*HOSTPRIVIP=192.168.100.33** Using a private IP insulates the PPP client from changes in IP addresses of the underlying network. The Raven will perform basic NAT-like address translation on all packets.

If a public IP address is being used, any changes in the IP (as determined by the wireless network) will result in the PPP link to the host being disconnected, requiring the host to reinitiate it. The public IP is passed to the host in the PPP negotiations, so when the network forces a change, the modem has to force the host to renegotiate the PPP link to make this happen.

---

### *Slip Mode*

SLIP mode is entered by using the "**AT\ASLIP**" command. As in PPP Mode, the IP address that the host assumes is affected by the setting of **\*HOSTPRIVMODE**.



SLIP does not negotiate the IP with the host, so before making a SLIP connection, the host SLIP driver must be configured to use the IP specified by querying **S110**.

---

### *UDP Pad Mode*

When the modem is in UDP PAD (Packet Assembly and Disassembly) Mode, all characters received on the serial port are assembled into UDP packets and sent to the Raven's remote IP address/port, and any packets received from the same IP/port--destined for the Raven's Device Port (see \*DPORT)--are disassembled and dumped onto the serial line.

A UDP session is initiated by one of the following events:

- Using the Dial UDP (DP) AT command (ex. **ATDP192.168.3.23/3456**)
- Setting the Startup Mode Default (**MD**) to 3 (UDP) so that a UDP session is entered automatically when the modem powers up. Serial data will be sent to the IP/port specified in **S53**.
- An incoming UDP packet is received and
  - UDP auto answer is enabled (**S82=2**);
  - The destination IP address matches that in **S53**;
  - Or allow any IP is set (**AIP=1**);
  - The modem is in AT mode (not in a current UDP or TCP session).
- UDP packet assembly is affected by the values of **S50** (PAD Forwarding Time-out) and **S51** (PAD Forwarding Character). Data received in the serial buffer will be transmitted when the idle inter-character time-out specified in **S50** (in tenths of seconds) occurs or when a character is received that matches **S51** (if non-zero).

### **UDP Auto Answer**

UDP auto answer (previously called UDP half-open) is set with **S82=2**. When set, the Raven will automatically establish a UDP session to the source IP address and port of the UDP packet received. The Raven will remain "locked" to this one remote IP/port until no data is sent or received for the time interval defined in the UDP auto answer time-out (**S83**). During this session, packets from other IP/port addresses will be rejected, unless \*UALL is set. Whether or not an incoming packet will cause the modem to enter a UDP session is always dependent on the **S53** and **AIP** settings.

When idle, after the time-out has occurred, the Raven is in AT command mode on the serial port, and any valid AT command may be entered during this time.

The Normal UDP Mode (**MD3**) can be combined with UDP auto answer to cause the incoming serial data to be sent in UDP packets (instead of being treated as AT commands), while allowing sessions to be established from different UDP sources. A UDP session will be initiated either by incoming serial data or by an incoming UDP packet. The session, started by either method, will be terminated when no data has been sent or received for the **S82** period. Once the session terminates, another may be initiated by either means.

When the session is initiated by serial data, the new session will be established using the destination address specified in **S53**. The **S53** setting can be changed if the connect to last UDP setting (**\*UDPLAST=1**) is set. The address in **S53** will be updated to reflect the address of the last session initiated by an incoming UDP packet. So that when new data is received over the host serial port while in the idle state, a session will be re-established with the last address. (This behavior is the same as the previous Hybrid2 (**MD6**) mode).



**Note:** TCP auto answer (**S0**) may also be set simultaneously with UDP auto answer. Then, when in the idle state, the modem will accept either a TCP or UDP incoming packet, and enter a TCP or UDP session as appropriate.

## Reliable UDP

Reliable UDP adds a simple protocol on top of UDP to provide reliable delivery of data. When data is received from the host serial port, a 2 byte header is added to the data, containing a message type and a sequence number. The Raven will continue to send this data (buffering any received data in the meantime) until it receives an acknowledgement with this sequence number. If an acknowledgement is not received within the time-out period (specified in **S7**), the data will be retransmitted. This will continue until an acknowledgement is received or the modem is reset. Likewise any UDP packets received by the Raven are expected to have this simple header. The Raven will issue an acknowledgement for any valid packets which are received.

Configure the Raven as for a normal UDP session. Set the Startup Mode Default to 3, and the UDP Mode Default to 7 (**ATMD73**). If using two modems, configure the Destination IP and Port in each to point to each other. Serial data will then be sent reliably between the two



**Note:** Although it adds reliability, the simple implementation of the Reliable UDP mode in the Raven does not check for duplicate packets.

### **Multicast UDP**

Multicast UDP results in any data received from the host serial port being sent to all the clients in the Modbus list. The remote port number is taken from **S53**. To avoid flooding the network, the packets are sent to each client with a 20ms pause in between. The receipt of UDP packets works as in normal UDP mode (i.e. bound by the value **S53** and/or **AIP**). Since it may take a while to transmit the data to all hosts (especially if all 20 Modbus entries are used and name resolutions are required), new data received from the host port is buffered until current transmissions to all hosts are finished.

Enter the list of target IPs in the Modbus IP list. The index numbers in the IP list aren't used. Configure the Raven as for a normal UDP session. Set the Startup Mode Default to 3, and the UDP Mode Default to 8 (**ATMD83**). Configure the Destination port to match the device port of the remote modems.

---

### *TCP PAD Mode*

When the Raven is in a TCP session, all characters received on the serial port are assembled into TCP packets and sent to the mode's remote IP address/port, and any packets received from the remote end of the TCP connection are disassembled and dumped onto the serial line.

- A TCP connection is established by one of the following methods:
- Using the Dial TCP (**DT**) AT command (for example, **ATDT192.168.3.23/3456**)
- TCP auto answer is enabled (**S0**), a TCP connection request is received, and the modem is not in a data session.
- Data is received on the serial port and
  - The Startup Mode Default (**MD**) is **4** (auto TCP)
  - The remote TCP destination, as defined in **S53**, successfully responds to the TCP connection request.

The value of **S7** (TCP Connection Time-out) specifies the number of seconds to wait, after initiating a TCP connection attempt, for a successful connection to be established. If the connection has not been successfully established before the time-out occurs, **ERROR/BUSY** is returned.

TCP packet assembly is affected by the values of **S50** (PAD Forwarding Time-out) and **S51** (PAD Forwarding Character). Data received in the serial buffer will be transmitted when the idle inter-character time-out specified in **S50** (in tenths of seconds) occurs or when a character is received that matches **S51** (if non-zero).

The TCP session will be terminated if no data is transmitted or received for the time interval specified in **TCPT** and **TCPS**. **TCPT** is the number of minutes (**TCPS=0**) or seconds (**TCPS=1**) used for this idle time-out.



**Caution:** **TCPT** should never be 0 when using the TCP mode. A broken TCP session can result in the modem being left with a TCP half-open connection that can only be terminated with a reset.

### TCP Auto Answer

TCP auto answer (**S0=1|2**) also allows a TCP connection request to be "answered" when the modem is idle, not in a data session. The TCP connection request's destination port has to match the modem's device port.



**Note:** UDP auto answer may also be set simultaneously with TCP auto answer. Then, when in the idle state, the modem will accept either a TCP connection request or UDP incoming packet, and enter a TCP or UDP session as appropriate.

---

## Hybrid Modes

Some previous hybrid modes (**MD=5, 6**) are no longer implemented as special, unique modes. Now that UDP auto answer (UDP Half-open, **S82=2**) can be **enabled in conjunction with UDP PAD mode (MD3), effectively this is the same**

as **MD5** and **MD6** previously accomplished. Setting **MD5** and **MD6** are still supported, but not recommended.

**TABLE 1. Hybrid Mode Settings**

<b>AT</b>	<b>Hybrid (MD5)</b>	<b>Hybrid2 (MD6)</b>
MD	3	3
S82	2	2
S0	1	1
*UDPLAST	0	1

# *Modbus/BSAP Configuration*

---

The Raven supports Modbus ASCII, Modbus RTU, BSAP, and can also emulate other protocols like DF1 or others using its Modbus Variable feature.

---

## *Modbus Overview*

The Modbus Protocol, developed by Modicon in 1979, provides for client-server (also referred to as master-slave) communications between intelligent devices. As a de facto standard, it is the most widely used network protocol in the industrial manufacturing environment to transfer discrete/analog I/O and register data between control devices.

Modbus, BSAP, and other Modbus variations are often used in conjunction with telemetry devices.



This section is just a brief overview of Modbus. For more information, refer to your Modbus equipment distributor or manufacturer or <http://www.modbus.org>.

## **Telemetry**

Telemetry is an automated communications process by which data is collected from instruments located at remote or inaccessible points and transmitted to receiving equipment for measurement, monitoring, display, and recording. Transmission of the information may be over physical pairs of wires, telecommunication circuits, radios or satellite.

## **Remote Terminal Unit (RTU)**

Modbus was originally designed to be used in a radio environment where packets are broadcast from a central station (also called master or host) to a group of remote units. Each remote unit, Remote Terminal Unit (RTU), has a hexadecimal identification number (ID). The first part of the broadcast packet contains an RTU ID which corresponds to the ID of one of the remote units. The Modbus host looks for the ID and sends to only the unit with the matching ID. The RTU would then reply back to the central station.

The RTU connects to physical equipment such as switches, pumps, and other devices and monitors and controls these devices. The RTU can be part of a network set up for Supervisory Control and Data Acquisition.

## **Supervisory Control and Data Acquisition (SCADA)**

Supervisory Control and Data Acquisition (SCADA) describes solutions across a large variety of industries and is used in industrial and engineering applications to monitor and control distributed systems from a master location. SCADA encompasses multiple RTUs, a central control room with a host computer (or network), and some sort of communication infrastructure.

SCADA allows for “supervisory” control of remote devices as well as acquiring data from the remote locations. Programmable Logic Controllers allow for a higher degree of automated SCADA.

## **Programmable Logic Controller (PLC)**

A Programmable Logic Controller (PLC) is a small industrial computer which generally monitors several connected sensor inputs and controls attached devices (motor starters, solenoids, pilot lights/displays, speed drives, valves, etc.) according to a user-created program stored in its memory. Containing inputs and outputs similar to an RTU, PLCs are frequently used for typical relay control, sophisticated

motion control, process control, Distributed Control System and complex networking.

### **Modbus TCP/IP**

Modbus TCP/IP simply takes the Modbus instruction set and wraps TCP/IP around it. Since TCP/IP is the communications standard for the Internet and most networked computers, this provides a simpler installation. Modbus TCP/IP uses standard Ethernet equipment.

### **Raven Modbus on UDP**

When Ravens are used in place of radios, a Raven is connected to the central station (host) and a Raven is connected to each remote unit. When the Raven is configured for Modbus with UDP, the Raven connected to the host can store a list of IP addresses or names with matching IDs. When the host at the central station sends serial data as a poll request, the Raven at the host matches the RTU ID to a corresponding IP of a Raven at a remote unit. A UDP packet is assembled encapsulating the RTU ID and serial data transmitted from the host. The UDP packet is then transmitted to the specific Raven at the remote unit matching the RTU ID. The remote Raven then disassembles the packet before transmitting the RTU ID and serial data to the remote unit. The remote units operate in normal UDP mode and their data is sent to the host via the remote Raven and host Raven.

**FIGURE 1. Automation and Telemetry**

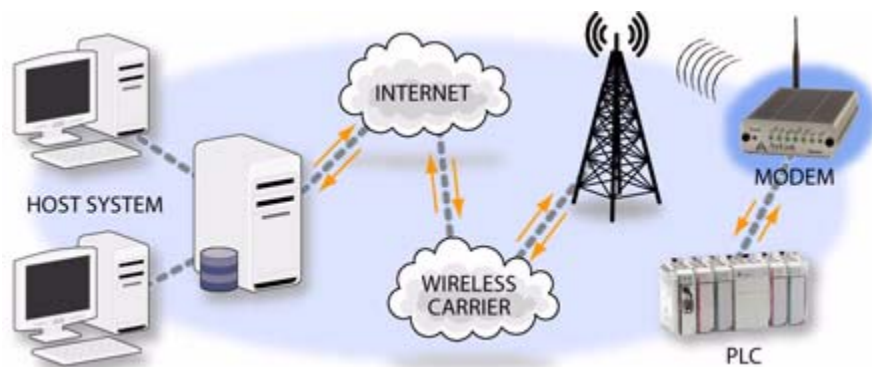



## *Configuring the Raven at the Polling Host for Modbus on UDP*

You can use either Wireless ACE (page 10) or direct serial communication or Telnet (page 53) to configure the modem using AT commands (page 53). This section covers standard Modbus, variations may need additional commands.

### **Port**

The destination port for the Raven at the host needs to match the device port in use on all the Ravens at the remote sites. For example, if the remote Raven's device port (*see below*) is "12345", then the Modbus host Raven's **S53** destination port should be set to "12345".

In Wireless ACE, select **Misc** in the side menu.

**FIGURE 2. Wireless ACE: Destination Port**

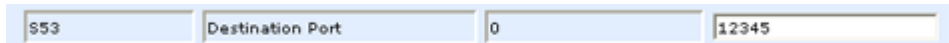

Take note of (or set) the Device Port setting in **\*DPORT** to configure the remote Ravens.

Relevez ou réglez (le cas échéant) le numéro du port Device des modèles Raven distants à l'aide de la commande **\*DPORT**.

**FIGURE 3. Wireless ACE: Device Port**



### **Default Power-up Mode**

The default power-up mode will need to be set. In Wireless ACE, select **UDP** in the side menu. Select the appropriate **MD** (AT commands: page 66) mode from the drop down menu.

FIGURE 4. Wireless ACE: MD Configuration

The screenshot shows a configuration interface with three main input areas: a text box containing 'MD', a text box containing 'Startup Mode Default', and a dropdown menu currently displaying '13-Modbus ASCII'.

- **ATMD13:** Modbus ASCII
- **ATMD23:** Modbus RTU (Binary)
- **ATMD33:** BSAP
- **ATMD63:** Variable Modbus (individual parameters are set up manually)

### IDs to IPs

The last step of configuring the Raven at the host is setting the IDs to their specific IPs. In Wireless ACE, select the menu option **Addr List**.

FIGURE 5. Wireless ACE: Addr List

Decimal[0xHex]=...	Address Entry		
	22=	123.123.123.124	22=123.123.123.124
	47=	123.123.123.125	0x2F=123.123.123.125
	0=		

Addresses can be entered in decimal or hex. Wireless ACE will translate hex entries into decimal. The number before the “=” is ID, the number after is the IP address. There can be a total of 100 remote ID/Local addresses entered into the Raven.

When using AT commands via telnet or direct serial connection, use **ATMLIST** for decimal IDs and **ATMLISTX** for hexadecimal, ex. if the ID is 27 and the IP is 123.123.123.124, you would enter it as **ATMLIST27=123.123.123.124** or **ATMLISTX1B=123.123.123.124**.

### Dynamic IP

If you do not have a static IP, the host Raven should be configured to report its current IP to a Dynamic DNS (DDNS) server (IP Manager: page 15).

In the Host Raven's configuration, instead of IP address for the Addr List (ATM-LIST or ATMLISTX), substitute a single unique name for each modem, i.e. remote1, remote2, etc.

When you configure IPManager for the host Raven, make note of your modem name and domain setting in Wireless ACE in the menu selection **Dynamic IP** to be used with the remote modems.

Lors de la configuration de IPManager pour le modèle Raven raccordé à l'hôte, dans Wireless ACE, relevez le nom du modem ainsi que le nom de domaine correspondant à l'aide de l'option de menu **Dynamic IP**.

**FIGURE 6. Wireless ACE: Modem Name and Domain**

*MODEMNAME	Modem Name	dogwatcher1
*DOMAIN	Domain	eairlink.com

With names instead of IPs for the Address List, the host Raven will query the DNS server for the current IP assigned to the specific name of a remote Raven to send a message corresponding to the ID.

---

### *Configuring the Remote Ravens for Modbus with UDP*

You can use either Wireless ACE (page 10), direct serial communication or Telnet (page 53) to configure the modem using AT commands (page 53). This section covers standard Modbus, variations may need additional commands.

#### **Port**

The destination port for the Raven at the host needs to match the device port in use on all the Ravens at the remote sites. For example, if the remote Raven's device port (*see below*) is "12345", then the Modbus host Raven's **S53** destination port should be set to "12345".

In Wireless ACE, select **Misc** in the side menu. Set the destination port (**S53**) to match the device port of the host Raven (**\*DPORT**, *above*). Make sure the device port of the remote Raven (**\*DPORT**) matches the destination port of the host Raven (**S53**, *above*).

### Default Power-up Mode

Each Raven at the remote locations will need to be configured to communicate with the Raven at the host. In Wireless ACE, select **UDP** in the side menu. Select **03-UDP (normal UDP operation)** as the value for **MD**.

**FIGURE 7. Wireless ACE: UDP Power-up Mode**



### Host Raven IP

If the Host Raven has a static IP, enter it in the Destination Address for **S53**. In Wireless ACE, select **Misc** in the side menu.

**FIGURE 8. Wireless ACE: Destination IP**



### Dynamic IPs

If you do not have static IPs, the remote Ravens need to be configured to report their current IPs to a Dynamic DNS (DDNS) server (IP Manager: page 15). You will need to match the name of the Raven to the names specified in the host Raven's **MLIST** or **MLISTX** for the connected RTU.

Instead of an IP, for **S53**, specify the name of the host Raven (**\*MODEMNAME**). If the remote Ravens are using a different DDNS than the host Raven, you will need to specify the fully qualified domain name (**\*MODEMNAME+\*DOMAIN**).

With a name instead of IPs for the host Raven, the remote Ravens will query the DNS server for the current IP assigned to the host Raven before sending data back to the host.

### RTU settings

Other parameters may need to be changed, but this is dependent on the RTU type being used. As a minimum, this typically involves setting the proper serial settings to match your RTU.

**FIGURE 9. Raven mounted in an enclosure with an RTU**

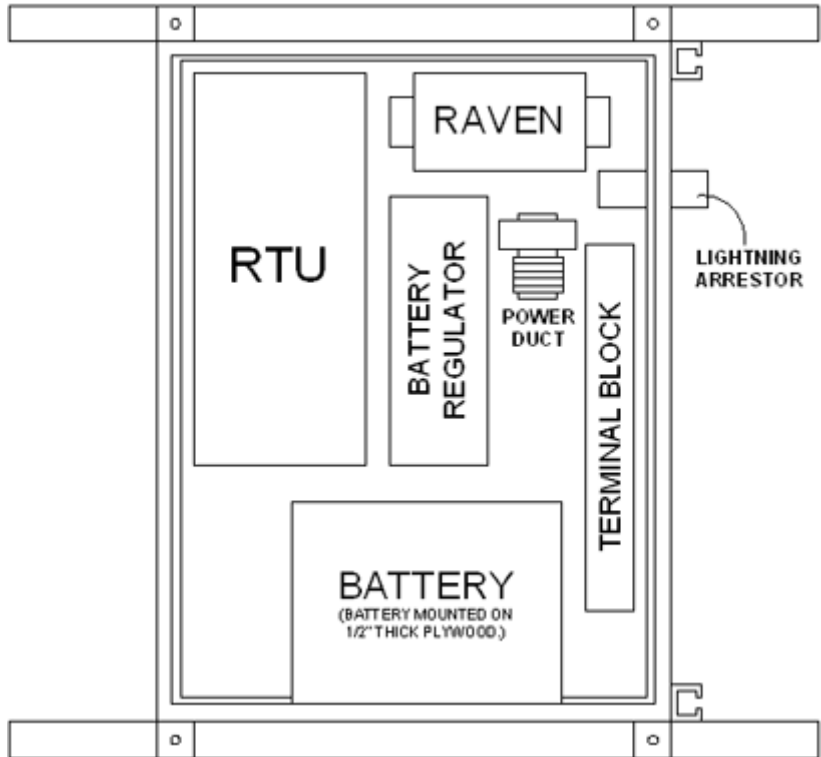

FIGURE 10. RTU to Raven setup

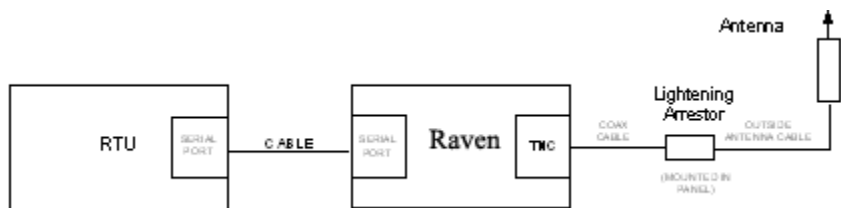
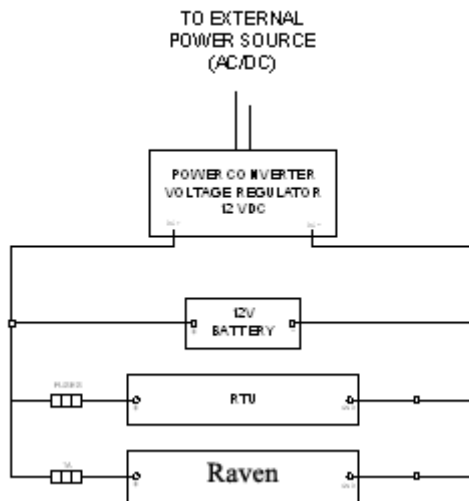

FIGURE 11. Power Connections



# *Simple Network Management Protocol (SNMP)*

---

The Raven can be configured as an SNMP agent and supports SNMPv2c and SNMPv3.

---

## *SNMP Overview*

The Simple Network Management Protocol (SNMP) was designed to allow remote management and monitoring of a variety of devices from a central location. The SNMP management system is generally composed of agents (such as your Raven, a router, a UPS, a web server, a file server, or other computer equipment) and a Network Management Station (NMS) which monitors all the agents on a specific network. Using the management information base (MIB), an NMS can include reporting, network topology mapping, tools to allow traffic monitoring and trend analysis, and device monitoring.

Authentication ensures SNMP messages coming from the agent, such as the Raven, have not been modified and the agent may not be queried by unauthorized users. SNMPv3 uses a User-Based Security Model (USM) to authenticate and, if desired or supported, message encryption. USM uses a user name and password specific to each device.

## Management Information Base (MIB)

The management information base (MIB) is a type of database used to compile the information from the various SNMP agents. Reports from various agents, such as the Raven, are sent as data in form designed to be parsed by the NMS into its MIB. The data is hierarchical with entries addressed through object identifiers.

## SNMP Traps

The trap is a “snap-shot” of the settings and status of the Agent’s device which is sent as a report to the NMS in a form that can be parsed and stored in the MIB. For an example of the trap from an AirLink modem refer to the Appendix, page 91.

---

## *Raven SNMP Configuration*

To configure your Raven to work as an SNMP agent, you can use either Wireless ACE, direct serial communication or Telnet to configure the modem using AT commands (page 53). In Wireless ACE, the SNMP commands are all on the **Other** menu option.

There are only three commands to set for SNMP in the Raven: the listening port, the security level, and the trap destination.

## Listening Port

\*SNMPPORT sets the port for the SNMP agent to listen on. If set to zero, default, SNMP is disabled.

**FIGURE 1. Wireless ACE: \*SNMPPORT**



The screenshot shows a configuration window with a light blue border. On the left, there is a label '\*SNMPPORT'. To its right is a text input field containing the value '0'. Further right is another label 'SNMP Port' followed by an empty text input field.



**Note:** SNMP generally uses port 161, however most Internet providers (including cellular) block all ports below 1024 as a security measure. You should be able to use a higher numbered port such as 10161.



## Security Level

\*SNMPSECLVL sets the security level and which version of SNMP communications are used.

**FIGURE 2. Wireless ACE: \*SNMPSECLVL**



*SNMPSECLVL	SNMP Security Level	0	
-------------	---------------------	---	--

**0** - No security required. SNMPv2c and SMNPv3 communications are allowed.

**1** - Authentication required. SNMPv3 is required to do authentication and SNMPv2c transmissions will be silently discarded. Authentication is equivalent to the authNoPriv setting in SNMPv3.

**2** - Authentication required and messages are encrypted. SNMPv3 is required to do authentication. SNMPv2c and SNMPv3 authNoPriv transmissions will be silently discarded. Authentication and encryption is equivalent to the authPriv setting in SNMPv3.

## User Name and Password

The user name is '*user*'. The user name cannot be changed.

The Raven's password is used as the SNMP password (default is '*12345*').



**Note:** The eight-character password requirement for SMNPv3 is not enforced by the Raven's Agent to allow the default password to function. Your SNMP administrator or MIS may require you to change to a more secure and/or longer password.

To change the password in the Raven, select **Modem** from the top menu line in Wireless ACE.

**FIGURE 3. Wireless ACE: Changing the Raven Password - Menu Option**

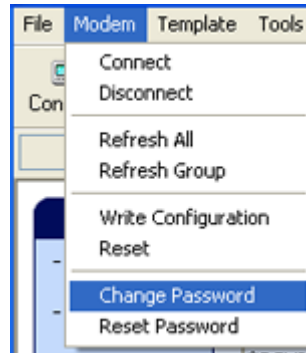

The current password will be pre-entered. As you type the new password and confirm it, the characters you type will be obscured by “x”.

**FIGURE 4. Wireless ACE: Changing the Raven Password**

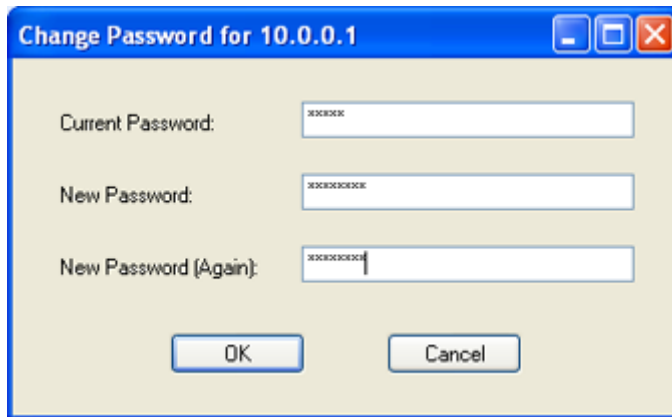

For the password, you can use numbers, letters, and/or punctuation.



**Caution:** The password is case sensitive. “drowssaP” is not the same as “drowssap”.

### Trap Destination

\*SNMPTRAPDEST needs to be set with the destination IP and port. If either are set to zero or empty, SNMP traps are disabled.

**FIGURE 5. Wireless ACE: \*SNMPPORT**

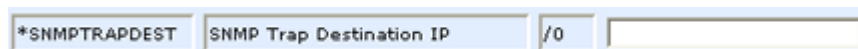

The screenshot shows a configuration field for \*SNMPTRAPDEST. The field is split into two parts: the first part is labeled "SNMP Trap Destination IP" and contains the value "/0"; the second part is an empty text box.



**Note:** Traps are sent out according to the SNMP security level (i.e. if the security level is 2, traps will be authenticated and encrypted). Currently, the only trap supported is *LinkUp*.

---

Your AirLink Raven should be mounted in a position that allows easy access for the cables so they are not bent or constricted. The LEDs on the front panel should be visible for ease of operational verification. You should ensure that there is adequate airflow around the modem but that it is kept free from direct exposure to the elements (sun, rain, etc.). The exterior of the case should also be grounded.

An optional accessory for your modem is a mounting kit. The bracket is designed to snugly cradle the modem and hold it in place where you need it. See “Mounting Kit” on page 51.

---

### *Connecting the Antenna*

Your Raven will work with most standard cellular antennas with a TNC connector and rated to work with CDMA technology. Connect the antenna or RF cable directly to the TNC connector on the back of the Raven.

---

**FIGURE 1. Raven connectors**

---



---

### *Connecting power*

Your Raven can be used with either DC (available in most automobiles) or 110 AC (standard US wall power) with the appropriate power adapter (available from Air-Link).

The power cable positive lead should be connected to the battery or power source positive terminal. The power cable negative lead should be connected to the battery or power source negative terminal. The Raven has an internal polysilicon circuit breaker that opens at 0.5 to 1.0 amps of current.

---

### *Connecting the Raven to a computer or other device*

Your Raven's serial port can be connected directly to most computers or other devices using a standard straight through cable. If you have a DCE device, you will need a null modem or null modem cable. Raven

Your Raven can also be connected to a USB to serial device connected to a computer or other device which does not have an available serial port but does have USB.

# *Specifications for the Raven CDMA*

---

## **Physical Characteristics:**

- Weight: < 1 lb.
- Size: 3" x 1.1" x 5.1"
- RF Antenna Connector: 50 Ohm TNC
- Serial Interface: RS232 DB-9F with 1200-115200 bps
- Status LEDs

## **Data Services & RF Features: CDMA**

- Full duplex transceiver
- Dual-band support for both 800 MHz cellular and 1.9 GHz PCS bands
- Dual band Receive Diversity
- Adheres to CDMA authentication as specified in CDMA2000 1X
- 224 mW RF output (+23.5 dBm)
- Data rates up to 153.6 kbps (forward channel) and 76.8 kbps (reverse channel)

## **Environmental:**

- Operating ranges: -30°C to +70°C

- Humidity: 5%-95% Non-condensing

### Power Management:

- Low power consumption
- Dormant connection (idle for 10-20 seconds): at 12 VDC
- Input Voltage: 10 VDC to 28 VDC
- Input Current: 20 mA to 350 mA
- Low power mode: at 12 VDC

### Power consumption

Modem	Idle	Transmitting
Raven C3211	50 mAh	200-300 mAh
Raven C3210	50 mAh	250-300 mAh

### Serial Port Pin-outs

The cable between the modem and a computer or other serial device needs to be wired straight-through (pin 1 goes to pin 1, pin 2 to pin 2, etc).

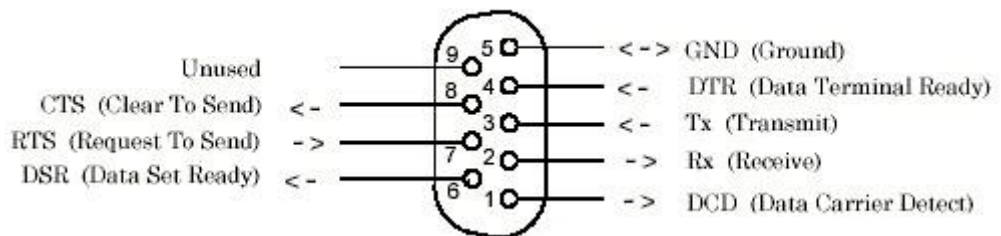





## *Mounting Kit*

---

An optional accessory for your modem is a mounting kit. The bracket is designed to snugly cradle the modem and hold it in place where you need it.

The Raven “snaps” into place in the bracket locking into the grooves on the Raven case. The bracket can be further secured with a twist-tie set into the grooves on the top for situations where the modem may be subjected to violent movement, such as in the back of an automobile. In most stationary installations, such as in a field or pipe, the Raven and bracket shouldn’t require a twist-tie.

The bracket can be attached to the location using #6 screws (mounting hole diameter approximately 0.150”).

**FIGURE 1. Raven Mounting Bracket, part number 100-170-1009 A**

---

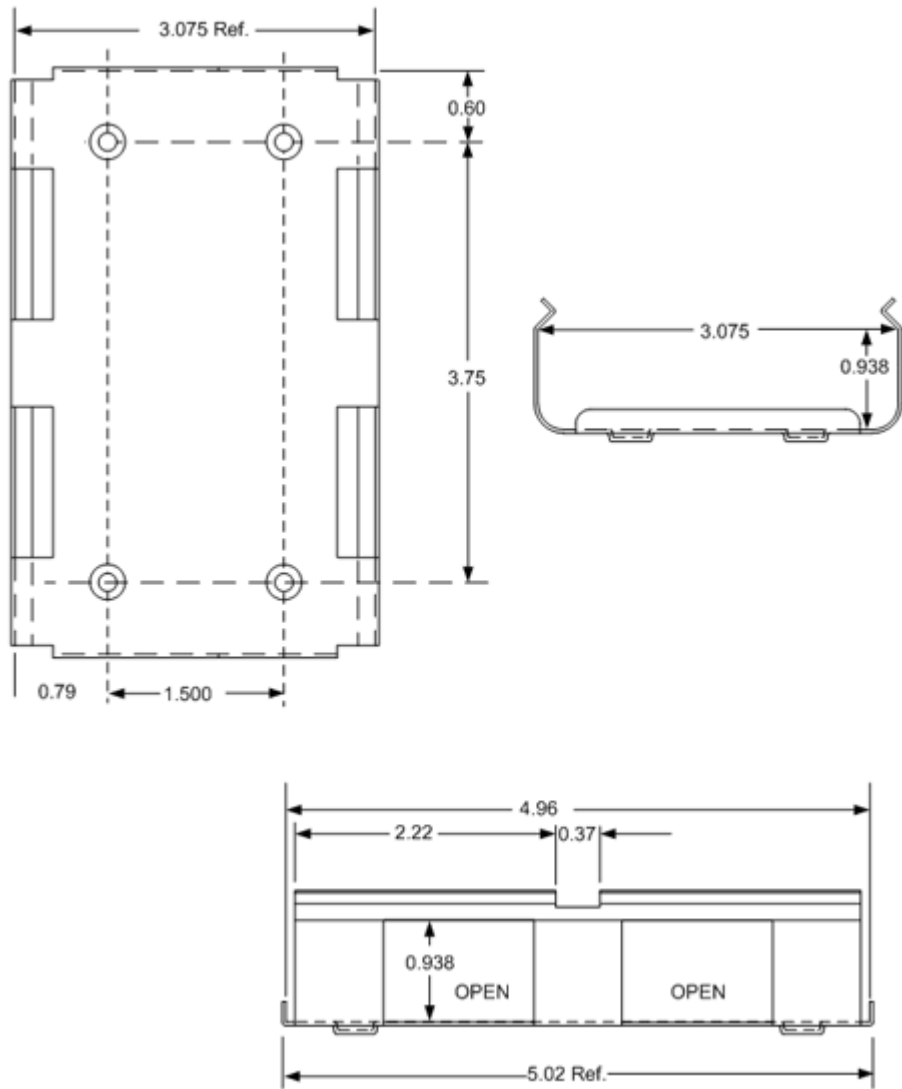

# *AT Commands*

---

Just as with a Hayes compatible analog modem, the Raven parameters can all be configured with AT commands.



---

## *Using Wireless Ace*

Wireless ACE is a graphical interface for the AT commands and it is highly recommended that you use this utility to modify any parameters, however a terminal emulation application, such as Telnet, see below, can be used instead.

With Wireless ACE, you only need to find the command listed and then enter the new value in the space provided. For those commands which have specific parameters, the choices will be in a drop down menu.



**Note:** Nearly all examples of entering commands in this User Guide are using Wireless ACE.

**FIGURE 1. Wireless ACE: Using AT Commands**

AT	Name	Value	New Value
*HOSTPRIVMODE	Use Private IP	0	<input type="text"/>
*HOSTPRIVIP	Host Private IP	0.0.0.0	<input type="text"/>

To set or commit the changes in the modem, use the **Write** button at the top of Wireless ACE interface.

**FIGURE 2. Wireless ACE: Toolbar**

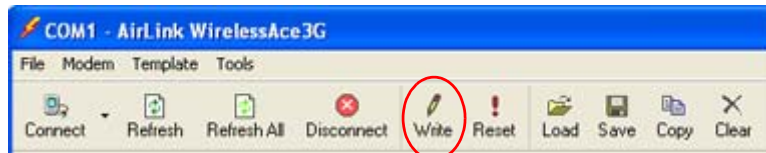

For more information on using Wireless ACE 3G or Wireless ACE Web, please refer to the **Wireless ACE 3G User Guide**.



**Note:** Some of the AT Commands are not able to be configured in Wireless ACE 3G.



With Wireless ACE, you can create a template from one modem and then use that template to configure other modems in the exact same way. You can use a in AceNet, too, to configure several modems the same all at once.



## *Using Telnet Terminal Emulation*

It is possible to communicate with the Raven across a TCP/IP network. Telnet provides a terminal style connection to the Raven.

Most installations of Microsoft Windows come with a version of HyperTerminal (used here for specific directions), but you can use any other Telnet application, such as Putty.

---

*Start>All Programs>Accessories>Communications>HyperTerminal*

1. Choose a name for your connection, such as **Raven** or **AirLink**. The name and icon are only for your own reference so you can find the connection at a later date (if you want to have a connection saved for both local and remote, it is recommended the connection name reflect the connection type, i.e. Raven Remote).

**FIGURE 3. HyperTerminal: Connection Name**

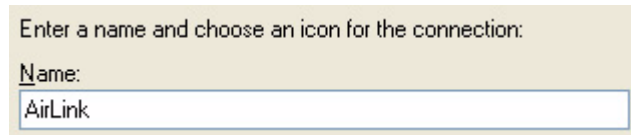

Enter a name and choose an icon for the connection:

Name:

2. Select TCP/IP (Winsock) for **Connect Using**. Then, if the modem is connected directly to your computer's Ethernet port, put in the **host address** of **192.168.13.31** or the \*HOSTIP. If the modem is remote, the **host address** will be the current Internet IP of the Raven. Change the **port number** to **2332** (default telnet port for the Raven).

**FIGURE 4. HyperTerminal: TCP/IP Settings**

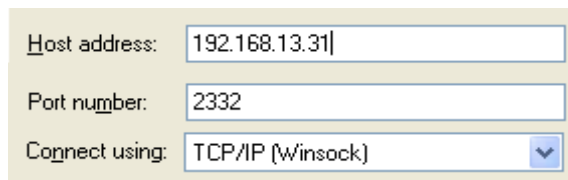

Host address:

Port number:

Connect using:  ▼

3. When HyperTerminal connects to the Raven, you may be prompted for a password. The default password is **12345**. When you press **Enter**, you should get back a reply of "OK".

---

**FIGURE 5. HyperTerminal: AT mode via Telnet**

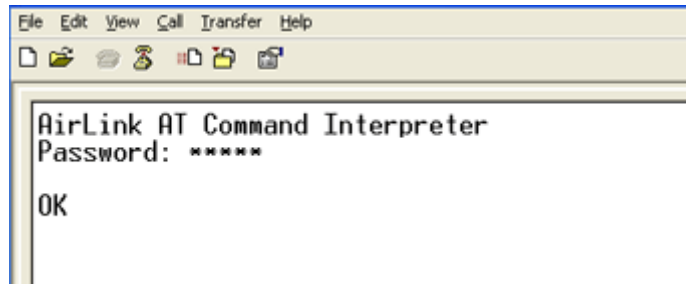

4. Type **AT** and press *Enter*. You should get a reply of “OK” or “0”.
5. To see what you are typing as you type it, you will need to turn on the echo and verbose mode. Type **ATE1V1** and press *Enter*.

If you get a reply of “OK”, then you entered the command successfully. If you get a reply of “0” or “ERROR”, try entering the command again.



## *Direct Serial Connection*

Using HyperTerminal included with most installations of Microsoft Windows:

*Start>All Programs>Accessories>Communications>HyperTerminal*

1. Choose a name for your connection, such as **Raven** or **AirLink** (if you want to have a connection saved for both local and remote, it is recommended the connection name reflect the connection type, i.e. Raven local). The name and icon are only for your own reference so you can find the connection at a later date.

---

**FIGURE 6. HyperTerminal: Connection Name**

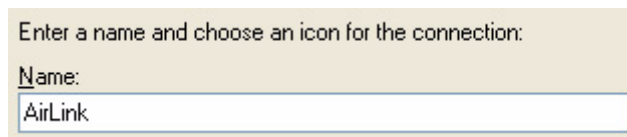

2. Select COM1 for the **Connect Using**.

**FIGURE 7. HyperTerminal: Comport Setting**



3. Change the **Bits per Second** to 115200 (default), **Data Bits** to 8, **Parity** to None, **Stop Bits** to 1, and **Flow Control** to Hardware.

**FIGURE 8. HyperTerminal: Comport Settings**

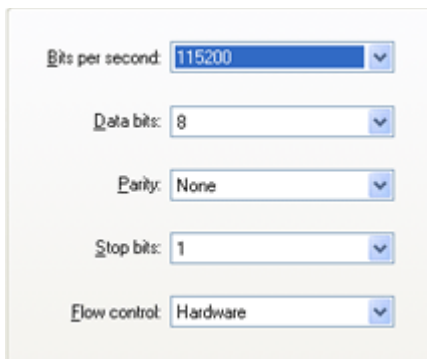

4. Type **AT** and press **Enter**. You should get a reply of “OK” or “0”.
5. To see what you are typing as you type it, you will need to turn on the echo and verbose mode. Type **ATE1V1** and press **Enter**.
6. If you get a reply of “OK”, then you entered the command successfully. If you get a reply of “0” or “ERROR”, try entering the command again.

## *AT Command Tables*

The tables below list the AT commands, their parameters, and explain what they do.

- For most commands, you need to preface the command with **AT** (exceptions are noted), i.e. **ATA** which listed as **A**

- 
- 
- Some commands have specific parameters while other commands will take whatever your type.
  - Acceptable parameters and/or specific formats are in the parameters column.
  - Required variable parameters are denoted with italicized text, ex. *Dn*. The *n* is variable and noted in the parameters column.
  - Optional parameters are denoted with square brackets [ ].
  - Most commands with parameters can be entered with ? to read the current value (for example, **AT&D?** will respond with “2” if the default has not been changed).
  - AT Commands are not case sensitive. A capital “E” is the same as a lower-case “e”.
  - If you enter a command which is recognized by the Raven, it will respond with “OK”. If the command is not recognized, the response will be “ERROR”.
  - Those commands applicable only to certain model numbers of the Raven will be noted in the command column.



**Caution:** Symbols listed with commands, such as \*, /, &, or ?, are part of the command and must be included. Commands with symbols other than \* may require PassThru mode.



**Note:** Some commands may be presented on more than one table.

## Information Commands

Most of the Commands in the “Information and Status” table, only, do not have any parameters. They only provide information. These commands are repeated elsewhere in their respective categories as well.



**TABLE 1. Information and Status**

<b>Command</b>	<b>Details</b>
I[n]	<i>n</i> =0 Product name (for example, Raven). <i>n</i> =1 The Raven's firmware (ALEOS) version, hardware ID, and copyright. <i>n</i> =2 The internal hardware's firmware version and relevant hardware ID. <i>n</i> =3 The hardware module's unique ID (ESN). <i>n</i> =5 View active profile (the contents of the active registers).
&V	View active profile (the contents of the active registers).
*HOSTMODE?	The current host mode (AT, PPP, UDP, etc.). If the Raven is not in AT mode, telnet into the modem to execute this command.
*NETCHAN?	The current active CDMA channel number.
*NETERR?	The EVDO or CDMA network frame error rate.
*NETIP?	The current IP address of the modem reported by the embedded OEM module (generally obtained from Carrier). This is the address to which packets can be sent in order to contact the Raven from the Internet. <b>Note:</b> If there is no current network IP, 0.0.0.0 may be displayed. Use <b>*NETALLOWZEROIP</b> if you need to allow the display of an IP ending in a zero .
*NETOK	Checks the CDMA network connection. <b>OK</b> if connected. <b>ERROR</b> if not connected.
*NETPHONE?	The modem's phone number (if applicable or obtainable).
*NETRSSI?	The current RSSI (Receive Signal Strength Indicator) of the Raven as a negative dBm value. The same information is displayed with the command <b>S202?</b> .

**TABLE 1. Information and Status**

<b>Command</b>	<b>Details</b>
*NETSTATE?	<p>The current network state:</p> <p><b>Connecting To Network</b> = The Raven is in the process of trying to connect to the CDMA network.</p> <p><b>Network Authentication Fail</b> = Authentication to the CDMA network has failed. Verify settings to activate the Raven.</p> <p><b>Network Negotiation Fail</b> = Network connection negotiation failed. This is usually temporary and often clears up during a subsequent attempt.</p> <p><b>Network Ready</b> = Raven is connected to the CDMA network and ready to send data.</p> <p><b>Network Dormant</b> = Raven is connected to the CDMA network, but the link is dormant. It will be woken up when data is sent or received.</p> <p><b>No Service</b> = There is no CDMA network detected.</p> <p><b>Hardware Reset</b> = The hardware module is being reset. This is a temporary state.</p>
*SMTPSTATUS?	<p>The status of the last issued SMTP message (*SMTPSEND). If no status is available 0 is returned. Once read, the status is cleared.</p> <p>The status codes are received from the SMTP server the modem attempted to send the request. Example: 354 = send in progress, 250 = sent ok.</p>
*SNTPQUERY?	The current SNTP (Simple Network Time Protocol) time and date.
+ECIO?	The EC/IO value.
+PRL?	Preferred Roaming List (PRL) version. Version de la PRL (Preferred Roaming List, liste des partenaires d'itinérance).

**TABLE 2.**

For most of the commands in the rest of the tables, you can query the current status of the associated register by substituting a “?” for any parameters, omitting the “=” if there is one, i.e. for the command \*DPORT=*n*, you would enter **AT\*DPORT?**.

## Basic Commands

These commands are common to most communication devices using AT Commands.

**TABLE 3. Basic Commands (common AT commands)**

Command	Parameters	Details
+++ The "+" is ASCII 0x2B.	<i>none</i>	AT Escape sequence. <b>Not proceeded by AT.</b> If the Raven is in a data mode (any mode other than PassThru), this command causes the modem to re-enter AT command mode. There must be an idle time (set by S50) on the serial port before and after this command. The detection of +++ is disabled if DAE=1.
A/	<i>none</i>	Re-execute last command. <b>Not proceeded by AT.</b>
A	<i>none</i>	Answer - manual
DAE= <i>n</i>	<i>n</i> =0 or 1	Disable AT Escape Sequence detection. <b>0</b> : Enable +++ AT escape sequence detection. <b>1</b> : Disable +++ AT escape sequence detection.
E <i>n</i>	<i>n</i> =0 or 1	Toggle AT command echo mode. <b>0</b> : Echo Off <b>1</b> : Echo On
H <i>n</i>	<i>n</i> =1	Hang-Up Command. <b>1</b> : Hang-up <b>Note:</b> With an AT telnet connection, this command will terminate the host data mode and return the Raven to an AT mode.
O	<i>none</i>	Online (Remote): Causes the Raven to go from Command State to data state.

**TABLE 3. Basic Commands (common AT commands)**

<b>Command</b>	<b>Parameters</b>	<b>Details</b>
$Qn$	$n=0$ or $1$	The AT quiet-mode setting. If quiet mode is set, there will be no responses to AT commands except for data queried. <b>0</b> : Off (Default) <b>1</b> : Quiet-mode on
$Vn$	$n=0$ or $1$	Command Response Mode. <b>0</b> : Terse (numeric) command responses <b>1</b> : Verbose command responses (Default).
$Xn$	$n=0$ or $1$	Extended Call Progress Result mode. <b>0</b> : Turn off extended result codes (Default). <b>1</b> : Turn on result codes. This adds the text 19200 to the CONNECT response.
$Z$	<i>none</i>	Reset the Raven. <b>Note:</b> This command does nothing if *DATZ=1.
&F	<i>none</i>	Restore Factory Setting.
&W	<i>none</i>	Writes all changed modem settings. If this command is not issued, any modified values will revert back to their previous values at modem reset.
*DATZ= $n$	$n=0$ or $1$	Enables or disables reset on ATZ. <b>0</b> : Normal Reset (Default) <b>1</b> : Disable Reset on ATZ

### Activation

The preferred method of activating (provisioning) the modem is using the Setup Wizard. However, there are special circumstances when commands may be used instead.



**Caution:** You may need go into PassThru mode to use some of the commmands in this section to activate the Raven.

**TABLE 4. Activation (Provisioning)**

Command	Parameters	Details
OPRG= <i>n</i>	<i>n</i> =0 or 1	Enables/disables over-the-air firmware upgrading of the Raven. <b>0</b> : Disables over-the-air programming. <b>1</b> : Enables over-the-air programming.
*DEVICEID= <i>n</i>	<i>n</i> =number string	Sets or queries the 64-bit Device ID that is used by the modem to identify itself to the server. The default is a value that depends on the underlying communications technology being used.
*NETPHONE?	<i>none</i> <i>Aucun</i>	The modem's phone number, if applicable or obtainable.
*NETPW= <i>pw</i>	<i>pw</i> =password	The password that is used to login to Verizon's cellular network, when required.
*NETUID= <i>uid</i>	<i>uid</i> =user id (up to 64 bytes)	The login that is used to login to the Verizon's cellular network, when required.
*NETROAMPREF= <i>n</i>	<i>n</i> =0 or 1	Allow configuration of the roaming preference. <b>0</b> : Restrict to home network only. <b>1</b> : Allow roaming to affiliated networks.
*PROVISION=[ <i>MSL</i> ],[ <i>MDN/MIN</i> ],[ <i>SID</i> ],[ <i>NID</i> ]	<i>MSL</i> =master lockcode <i>MDN/MIN</i> =phone number <i>SID</i> =network ID* <i>NID</i> =system ID*	Provision the modem with the lock code and phone number. <b>Note:</b> It is recommended to use the Verizon Setup Wizard for Verizon to provision the modem. <b>*Note: Verizon may not support this function.</b>
*PROVISION2=[ <i>MSL</i> ],[ <i>MDN</i> ],[ <i>MIN</i> ],[ <i>SID</i> ],[ <i>NID</i> ]	<i>Same as above but with MDN and MIN "split"</i>	A second set of modem provision parameters, when the MDN and MIN (MSID) are different or "split". <b>Note:</b> SID and NID are optional, however if you include SID you must include NID.
*STATICIP= <i>d.d.d.d</i>	<i>d.d.d.d</i> =IP	Set the static IP required to be received from the network. If the modem does not get this IP address from the network, it will reset the module and try again. The default is 0.0.0.0, which allows any IP address from the network. Example: <b>AT*STATICIP=192.168.1.23</b>

## Cellular Network

The Raven's cellular network is the connection to CDMA and remote devices or computers.

**TABLE 5. Cellular Network (Verizon's CDMA)**

Command	Parameters	Details
*NETALLOWZEROIP= <i>n</i>	<i>n</i> =0 or 1	Allows the displayed IP address in *NETIP to end in zero (ex. 192.168.1.0). <b>0</b> : Do not allow <b>1</b> : Allow
*NETCHAN?	<i>none</i>	The current active CDMA channel number.
*NETERR?	<i>none</i>	The EVDO or CDMA network frame error rate.
*NETIP?	<i>none</i>	The current IP address of the modem reported by the embedded hardware module (generally obtained from Carrier). This is the address to which packets can be sent in order to contact the Raven from the Internet. <b>Note:</b> If there is no current network IP, 0.0.0.0 may be displayed. Refer to *NETALLOWZEROIP if you need to allow the display of an IP ending in a zero.
*NETOK?	<i>none</i>	Checks the CDMA connection. <b>OK</b> if connected. <b>ERROR</b> if not connected.
*NETRSSI?	<i>none</i>	The current RSSI (Receive Signal Strength Indicator) of the Raven as a negative dBm value. The same information is displayed with the command <b>S202?</b> .
*NETSTATE?	<i>none</i>	See *NETSTATE?.
*NETWDOG= <i>n</i>	<i>n</i> =minutes	Network connection watchdog: The number of minutes to wait for a network connection. If no connection is established within the set number of minutes, the Raven resets. Default = 20 min. 0 = Disable.

**TABLE 5. Cellular Network (Verizon's CDMA)**

<b>Command</b>	<b>Parameters</b>	<b>Details</b>
!STATUS  <i>C3210</i>	<i>none</i>	Displays the current modem status. Format of response: Current band: <band> Current channel: <chan> SID:<sid> NID:<nid> Roaming:<n> Temp:<temp> Pilot [NOT] acquired Modem has [NOT] registered
!RSSI <i>C3210</i>	<i>none</i>	Received Signal Strength Indicator Puissance du signal reçu.
+CBIP?	<i>none</i>	Mobile Station IP Address.
+CGSN	<i>none</i>	ESN (Electronic Serial Number).
+CICB <i>C3211</i>	<i>n=0   2   3</i>	The mode for answering data/fax calls with A (Answer) or autoanswer via S0=1. <b>0</b> : Answer as voice (Default) <b>2</b> : Voice <b>3</b> : Async data for next call, then revert to Voice.

### Local Network and Host Modes

The Local network for the Raven is the one to which it is connected physically via the serial port to your computer, device, hub, or switch. The Raven has the ability to provide some NAT (network address translation) to pass communication from the CDMA network and the Internet to the local device(s) and network. On the local network, the Raven acts as a Host.

### PassThru

PassThru Mode is used to communicate directly to the Raven's internal hardware (OEM module).





**TABLE 6. Local Network and Host Modes**

Command	Parameters	Details
S0= <i>n</i>	<i>n</i> =0   1   2   3	<p>This register determines how the Raven responds to an incoming TCP connection request. The Raven remains in AT Command mode until a connection request is received. DTR must be asserted (<b>S211=1</b> or <b>&amp;D0</b>) and the Raven must be set for a successful TCP connection. The modem will send a "RING" string to the host. A "CONNECT" sent to the host indicates acknowledgement of the connection request and the TCP session is established.</p> <p><b>0</b> : Off (Default)  <b>1</b> : On  <b>2</b> : Use Telnet server mode on TCP connections.  <b>3</b> : With a Telnet connection, overrides the client's default echo, allowing the server on the host port to perform the echo. CRLF sequences from the telnet client will also be edited to simply pass CRs to the server on the host port.</p>
S7= <i>n</i>	<i>n</i> = seconds	Specifies the number of seconds to wait for a TCP connection to be established when dialing out.
S23=[ <i>speed</i> ],[ <i>databits</i> ] [ <i>parity</i> ][ <i>stop bits</i> ]	<p><i>speed</i> =  300   1200    2400   4800    9600   19200    38400   57600    115200   230400</p> <p><i>databits</i> = 7 or 8</p> <p><i>parity</i> =  O   E   N   M</p> <p><i>stopbits</i> =  1   1.5   2</p>	<p>Serial line parameters. The settings take affect after reset.</p> <p>Ex. <b>ATS23=19200,8N1</b> (sets modem to 19200, etc.)</p> <p><b>Note:</b> Databits MUST be 8 data bits for PPP mode.</p> <p>Can also be set using <b>&amp;L=[<i>speed</i>],[<i>databits</i>] [<i>parity</i>][<i>stop bits</i>]</b></p> <p>O=Odd E=Even N=None M=Mark</p>
S50= <i>n</i>	<i>n</i> = tenths of seconds	<p>Data forwarding idle time-out. If set to 0, a forwarding time-out of 10ms is used.</p> <p>(Used in UDP or TCP PAD mode)</p>

**TABLE 6. Local Network and Host Modes**

Command	Parameters	Details
S51= <i>n</i>	<i>n</i> =0   ASCII code	PAD data forwarding character. <b>0</b> : No forwarding character. ASCII code of character that will cause data to be forwarded. (Used in UDP or TCP PAD mode.)
S82= <i>n</i>	<i>n</i> =0 or 2	Enables UDP auto answer (half-open) mode. <b>0</b> : Normal mode <b>2</b> : Enable UDP auto answer mode.
S83= <i>n</i>	<i>n</i> =0-255	Set or query UDP auto answer idle time-out. If no data is sent or received before the time-out occurs, the current UDP session will be terminated. While a session is active, packets from other IPs will be discarded (unless *UALL is set). Time-out in seconds. <b>0</b> : No idle time-out (Default).
S211= <i>n</i>	<i>n</i> =0   1   3	For applications or situations where hardware control of the DTR signal is not possible, the modem can be configured to ignore DTR. When Ignore DTR is enabled, the modem operates as if the DTR signal is always asserted. <b>0</b> : Use hardware DTR. (default). <b>1</b> : Ignore DTR. <b>3</b> : Ignore DTR and assert DSR. This value is deprecated, and it is recommended to use &S to control the DSR instead. When this value is set to 3, &S will automatically be set to 0. <b>See also:</b> &D and &S.
S221= <i>n</i>	<i>n</i> = 0 - 255	Connect Delay Number of seconds to delay the "CONNECT" response upon establishing a TCP connection. <i>OR</i> Number of tenths of seconds to delay before outputting ENQ on the serial port after the CONNECT when the ENQ feature is enabled (see *ENQ).

**TABLE 6. Local Network and Host Modes**

<b>Command</b>	<b>Parameters</b>	<b>Details</b>
TCPS= <i>n</i>	<i>n</i> = minutes (TCPS=0) or seconds (TCPS=1)	TCP connection time-out (TCPS) units. Specifies a time interval upon which if there is no in or outbound traffic through a TCP connection, the connection will be terminated.
TCPT= <i>n</i>	<i>n</i> = minutes (TCPT=0) or seconds (TCPT=1)	TCP connection time-out (TCPT) units. Specifies a time interval upon which if there is no in or outbound traffic through a TCP connection, the connection will be terminated.  This value only affects the TCP connection in TCP PAD mode.
&C <i>n</i>	<i>n</i> =0   1   2	Set DCD mode.  <b>0</b> : Always assert DCD. <b>1</b> : Assert DCD when in a data mode (UDP, TCP, PPP, or SLIP) (Default). <b>2</b> : Assert DCD when the modem has network coverage.
&D <i>n</i>	<i>n</i> =0 or 2	Set DTR mode.  <b>0</b> : Ignore DTR, same effect as HW DTR always asserted (same as S211=1). <b>2</b> : Use hardware DTR (same as S211=0).
&S <i>n</i>	<i>n</i> =0   1 / 2	Set DSR mode.  <b>0</b> : Always assert DSR. <b>1</b> : Assert DSR when in a data mode (UDP, TCP, PPP, or SLIP) (Default). <b>2</b> : Assert DSR when the modem has network coverage.  <b>Note:</b> S211 can also be used to request that DSR is always asserted. If S211 is set to 3 and &S is changed to a non-zero value, S211 will be changed to 1.

**TABLE 6. Local Network and Host Modes**

Command	Parameters	Details
*CTSE= <i>n</i>	<i>n</i> =0 or 1	<p>Clear To Send Enable</p> <p>This feature asserts CTS when there is a network connection.</p> <p><b>0</b> : Disabled (Default).</p> <p><b>1</b> : Enable assertion of CTS when there is network coverage.</p> <p><b>Note:</b> Flow control (<b>AT\Q</b>) will override this indication, so if you want to use CTS to indicate network coverage, flow control has to be off (<b>AT\Q0</b>).</p> <p>RS232 voltage levels:</p> <p>Positive = Network coverage.</p> <p>Negative = No coverage.</p>
*DU= <i>n</i>	<i>n</i> =0 or 1	<p>The dial command always uses UDP, even when using ATDT.</p> <p><b>0</b> : Dial using the means specified (default).</p> <p><b>1</b> : Dial UDP always, even when using ATDT.</p> <p><b>Note:</b> When this parameter is set you cannot establish a TCP PAD connection.</p>
*ENQ= <i>n</i>	<i>n</i> =0 or 1	<p>Outputs an ENQ [0x05] after the TCP CONNECT delayed by the Delay Connect Response time (<b>S221</b>).</p> <p><b>0</b> : Disabled (Default).</p> <p><b>1</b> : Enables ENQ on CONNECT.</p>
*HOSTCOMLVL	<i>none</i>	Displays the current signal levels of the host serial port.
*HOSTMODE?	<i>none</i>	The current host mode (AT, PPP, UDP, etc.) which the modem is in. If the modem is not in AT mode, telnet into the modem to execute this command.
*HOSTNETMASK= <i>n.n.n.n</i>	<i>n.n.n.n</i> = subnet mask, example 255.255.255.0	Netmask for the host interface. Allows communication with a subnet behind the host interface.
*HOSTPAP= <i>n</i>	<i>n</i> =0 or 1	<p>Use PAP to request the user login and password during PPP negotiation on the host connection.</p> <p><b>0</b> : Disable PAP request (Default).</p> <p><b>1</b> : Takes user login and password from Windows DUN connection and copies to *NETUID and *NETPW.</p>

**TABLE 6. Local Network and Host Modes**

<b>Command</b>	<b>Parameters</b>	<b>Details</b>
*HOSTPEERIP = <i>d.d.d.d</i>	<i>d.d.d.d</i> =local or peer IP of modem	Set or query the IP address that can be used to directly contact the Raven once a PPP connection is established. If this value is not specified, 192.168.13.31 will be used. <b>Note:</b> This is not normally used nor needed by user applications. PPP
*HOSTPRIVIP = <i>d.d.d.d</i>	<i>d.d.d.d</i> =IP	Set or query the private IP address that is to be negotiated by the PPP connection if *HOSTPRIVMODE =1. PPP
*HOSTPRIVMODE = <i>n</i>	<i>n</i> =0 or 1	Set or query whether a private or public (network) IP is to be used when the Host initiates a PPP connection to the modem. PPP  <b>0</b> : Public (network) IP Mode: When the Host initiates a PPP connection, the host will be given the public IP that was obtained from the OEM module. If the network issues a new IP, the PPP connection will be closed (since the IP has changed) and has to be re-initiated. (default). PPPPPP  <b>1</b> : Private IP Mode: When the Host initiates a PPP connection, the host will be given the IP address specified in *HOSTPRIVIP. The modem will then perform NAT-like address translation, which shields the Host from network IP changes. PPP
*MODEMHISPEED= <i>n</i>	<i>n</i> =0 or 1	Set the internal serial link speed to the radio (modem) module.  <b>0</b> : 115200 (default) <b>1</b> : 230400
*UALL= <i>n</i>	<i>n</i> =0 or 1	Accepts UDP packets from any IP address when a UDP session is active. If there is no UDP session active, an incoming UDP packet will be treated according to the UDP auto answer and AIP settings.  <b>0</b> : No effect (Default). <b>1</b> : Accept UDP data from all IP addresses when in a UDP session.

**TABLE 6. Local Network and Host Modes**

Command	Parameters	Details
*UDPLAST= <i>n</i>	<i>n</i> =0 or 1	<p>If enabled, sets <b>S53</b> to the last accepted IP address through UDP auto answer. This can be used in conjunction with <b>MD3</b> so that when there is no UDP session, new ethernet host data will cause a connection to be restored to the last IP accepted through UDP auto answer. .</p> <p><b>0</b> : Does not change <b>S53</b> setting. (Default).  <b>1</b> : Set <b>S53</b> to the last accepted IP.</p> <p><b>Note:</b> This does not change the <b>S53</b> setting in NVRAM. If the modem is reset, the original <b>S53</b> setting will be restored from NVRAM.</p>
*USD= <i>n</i>	<i>n</i> =1-255	<p>Waits the specified delay before sending the first UDP packet and the subsequent UDP packets out to the serial port.</p> <p><b>0</b> : No UDP packet delay (Default).  Delay in 100ms units, from 100 ms to 25.5 sec.</p>
\Q <i>n</i>	<i>n</i> =0   2   4	<p>Set or query the serial port flow control setting.</p> <p><b>0</b> : No flow control is being used.  <b>1</b> : RTS/CTS hardware flow control is being used.  <b>4</b>: Transparent software flow control. Uses escaped XON and XOFF for flow control. XON and XOFF characters in data stream are escaped with the @ character (0x40). @ in data is sent as @@.</p>
\APPP	<i>none</i>	Set modem operation to PPP mode.
\ASLIP	<i>none</i>	Set modem operation to SLIP mode. DTR must be asserted ( <b>&amp;D0</b> or <b>S211=1</b> ).



**Caution:** Not all AT Commands can be used while in PassThru mode.

### Direct Communication

Direct Communication can be used with the Raven to contact other Internet devices to pass information or other tasks.

**TABLE 7. PassThru Mode**

<b>Command</b>	<b>Parameters</b>	<b>Details</b>
\APASSTHRU  <b>Note:</b> This mode is not available through the remote AT telnet server.	<i>none</i>	Set modem operation to pass through mode. This will pass any characters received on the serial port directly to the internal hardware module and output any characters from the internal hardware module out the serial port. This allows direct access/configuration of the hardware module. Once this mode is entered, the unit must be physically reset to return to normal operation.  <b>Note:</b> It may take up to 30 seconds for the hardware module to respond after CONNECT is output.
*CSX1= <i>n</i>	<i>n</i> =0 or 1	<b>0</b> : Data will be passed to the host.  <b>1</b> : PASSTHRU mode will echo all host received data and will not pass the data to the modem while the modem is not asserting DCD.  <b>Note:</b> If the modem is asserting DCD, data will be passed from the host to the modem as it normally is when *CSX1=0.
*PTINIT= <i>n</i>	<i>n</i> =AT command	Any AT Command string to be passed to the OEM module before entering PASSTHRU mode, e.g. AT&S1V1, etc.
*PTREFRESH= <i>n</i>	<i>n</i> =0-255 minutes	Number of minutes of inactivity in PASSTHRU mode to resend the *PTINIT string to the hardware module.  <b>0</b> : Disabled
*RESETPERIOD= <i>n</i>	<i>n</i> =0-255 hours	In PASSTHRU mode, modem will be reset after this period if no data has been sent or received. . Value is in hours.  <b>0</b> : Disabled

### Telnet

It is possible to communicate with the Raven across a TCP/IP network. Telnet provides a terminal style connection to the Raven.

**TABLE 8. Direct Communication**

Command	Parameters	Details
D[method][d.d.d.d[/ppppp]] or D[method][@name][[/ppppp]]	method = P, T, N d.d.d.d = IP address to contact name = domain name to contact ppppp = IP port to contact	Dial a connection to a remote IP and Port using <i>method</i> . P - Establish a UDP connection T - Establish a TCP connection N - Establish a Telnet connection <b>ATD</b> - Dial (establish) default connection. <b>ATDP192.168.13.31/2332</b> - Dial (establish) UDP session to 192.168.13.31, at port 2332. To end the connection, issue the +++ escape sequence or drop the DTR line (if Ignore DTR <b>S211=0</b> or <b>&amp;D2</b> ).
D <i>continued</i>	<i>see above</i>	The default connection is set in <b>S53</b> . If a domain name is specified, the '@' symbol can be used to explicitly indicate the start of the name. For example, if <b>ATDPHONY</b> is issued, this will be interpreted as dial a UDP connection to "HONY". To dial using the default method to host "PHONY", one would issue <b>ATD@PHONY</b> . If the method, IP address, or port is omitted, the values from <b>S53</b> are used. If a telnet connection is requested (N) and the port is not supplied, port 23 will be used instead of the value from <b>S53</b> . Several special dialing numbers exist to make it easy to establish a PPP or SLIP connection with the modem. <b>ATD#19788</b> or <b>ATDT#19788</b> will establish a PPP connection (see \APPP) and <b>ATDT#7547</b> will establish a SLIP connection (see \ASLIP). <b>Note:</b> The source port of the session is the Device Port (set by <b>S110</b> or <b>*DPORT</b> ).
PINGd.d.d.d[,n] or PING domain_name[,n]	d.d.d.d = IP address to contact n = amount of data to send	Ping the specified IP address. Sends a single ping, returns either OK or ERROR depending on result. Times out in 10 seconds. If <i>n</i> is provided, it specifies the amount of data to send with the ping. If <i>n</i> is not provided, the default, 50 bytes is used.



**TABLE 8. Direct Communication**

Command	Parameters	Details
S53=[method][d.d.d.d[/ppppp]	<i>method</i> = P - UDP T - TCP N - Telnet <i>d.d.d.d</i> = IP address or name <i>ppppp</i> = the port address	Destination IP address, port, and method. These are used as defaults for the D (Dial) AT command.  Examples: ATSS53=T192.168.100.23/12345 ATSS53=foo.earlink.com Telnet to the specified IP at port 12345. ATSS53=192.168.100.23/12345 Query the specified IP at port 12345. ATSS53=/12345 Query port 12345.
*DPORT= <i>n</i>	<i>n</i> =1-65535	The modem's Device Port. Can also be set with the command <b>S110</b> .
*MSCIUPDADDR= <i>name</i> [/ <i>port</i> ]	<i>name</i> = domain name <i>port</i> =port	Modem Status Update Address - where Name/Port is the domain name and port of the machine where the modem status updates will be sent. The Raven's status parameters are sent in an XML format.
*MSCIUPDPERIOD= <i>n</i>	<i>n</i> =0-255	Modem Status Update Period - where <i>n</i> defines the update period in seconds.  <b>0</b> : Disabled.



**Caution:** Telnet is not a secure communications protocol.

**TABLE 9. Telnet**

Command	Parameters	Details
S60= <i>n</i>	<i>n</i> =0   1  2	Telnet Client Echo Mode.  <b>0</b> : No Echo <b>1</b> : Local Echo (Default) <b>2</b> : Remote Echo

**TABLE 9. Telnet**

Command	Parameters	Details
*TELNETTIMEOUT= <i>n</i>	<i>n</i> =minutes	Telnet port inactivity time out. By default, this value is set to close the AT telnet connection if no data is received for 2 minutes.
*TPORT= <i>p</i>	<i>p</i> =0-65535	Sets or queries the port used for the AT Telnet server. If 0 is specified, the AT Telnet server will be disabled. The default value is <b>2332</b> .

## Time/Date

Time and Date in the Raven is set to UTC (Coordinated Universal Time). Time is expressed in 24-hour format, i.e. 13:23:57 would be 1:23pm. You can set time and date manually or you can have it set automatically with a regular query to an Internet time server (such as time.nist.gov) using SNTP (Simple Network Time Protocol).

**TABLE 10. Time and Date**

Command	Parameters	Details
*DATE=[ <i>mm/dd/yyyy</i> ],[ <i>hh:mm:ss</i> ]	<i>mm/dd/yyyy</i> = month, day, year <i>hh:mm:ss</i> = time in 24-hour notation	Sets and queries the clock in the unit. Either the date and time can be specified, or simply one of the two can be specified in which case the unspecified value will remain unchanged. The date and time are always specified 24-hour notation.
*SNTP= <i>n</i>	<i>n</i> =0 or 1	Enables daily SNTP update of the system time. <b>0</b> : Off <b>1</b> : On
*SNTPADDR=[ <i>d.d.d.d</i> ][ <i>name</i> ]	<i>d.d.d.d</i> =IP <i>name</i> =domain name	SNTP Server IP address, or fully-qualified domain name, to use if *SNTP=1. <b>Note:</b> If blank, <b>time.nist.gov</b> is used.
*SNTPQUERY?	<i>none</i>	The current SNTP time and date.

---

---

## Friends Mode

Friends Mode can limit access to the Raven from the Carrier network and the Internet. Friends Mode is a limited form of security.

**TABLE 11. Friends Mode**

Command	Parameters	Details
FM=[ <i>n</i> ]	<i>n</i> =0 or 1	Friends Mode - Only allow specified IPs to access the Raven. <b>0</b> : Disable Friends mode <b>1</b> : Enable Friends mode - Only packets from friends will be accepted (see below); packets from other IP addresses are ignored.
F <sub><i>n</i></sub> =[ <i>d.d.d.d</i> ]	<i>n</i> = Friends list index [0 - 9] <i>d.d.d.d</i> = IP address	Friends mode IP address. 255 = allow any number 0-255 Example: 166.129.2.255 allows access by all IPs in the range 166.129.2.0-166.129.2.255. <b>Note: ATF?</b> will return a list of all the current F <sub><i>n</i></sub> settings.

## DNS

DNS settings in the Raven allow the modem to use domain names instead of IPs to contact other Internet hosts.

**TABLE 12. DNS**

Command	Parameters	Details
*DNS <sub><i>n</i></sub> = <i>d.d.d.d</i>	<i>n</i> =1 or 2 <i>d.d.d.d</i> = IP of domain server	Sets the DNS addresses to be returned during PPP negotiation. If the underlying communications network provides DNS addresses, they replace those specified by this command. You can only set *DNS1 and *DNS2.

**TABLE 12. DNS**

<b>Command</b>	<b>Parameters</b>	<b>Details</b>
*DNSUPDATE= <i>n</i>	<i>n</i> =0 or 1	Indicates whether the modem should send DNS updates to the DNS server specified by *DNSUSER. These updates are as per RFC2136. They are not secure and are recommended only for a private network. In a public network, the IP Logger services should be used instead.  <b>0</b> : DNS updates disabled (Default). <b>1</b> : DNS updates enabled.
*DNSUSER= <i>d.d.d.d</i>	<i>d.d.d.d</i> = IP of domain server	Sets a user-provided DNS to query first when performing name resolutions in the modem.

### Keepalive

Keepalive (page 21) allows the Raven to stay connected to the cellular network even when there are periods of inactivity.

**TABLE 13. Keepalive**

<b>Command</b>	<b>Parameters</b>	<b>Details</b>
*IPPING= <i>n</i>	<i>n</i> =0, 15-255	Set the period to ping (if no valid packets have been received) a specified address (*IPPINGADDR) to keep the modem alive (online). 15 minutes is the minimum interval which can be set for Keepalive.  <b>0</b> : Disable ping (default) See also *MINXMIT which can override this value.
*IPPINGADDR=[ <i>d.d.d.d</i> ][ <i>name</i> ]	<i>d.d.d.d</i> = IP <i>name</i> = domain name	Set the IP address or valid internet domain name for the Raven to ping to keep itself alive (online). *IPPING must be set to a value other than 0 to enable ping.

**TABLE 13. Keepalive**

Command	Parameters	Details
*MINXMIT= <i>n</i>	<i>n</i> =seconds	<p>Minimum transmit period enforcement. When set to <i>n</i> seconds, will not let the *IPPING, *PPMINTIME, and the *MSCIUPDPERIOD timers to be set less than <i>n</i> seconds.</p> <p>Note that the *PPTIME can still be set to less than *MINXMIT, but the packets will still be transmitted no more often than the *PPMINTIME.</p> <p><b>Warning:</b> The *MINXMIT value is can only be set one time and AirLink must be contacted to reset it.</p>

## IP Manager

IP Manager (page 15) is a service from AirLink which allows a Raven with a dynamic IP to be contacted as if it had a static IP by using a Fully Qualified Domain Name.

**TABLE 14. IP Manager**

Command	Parameters	Details
*DOMAIN=[ <i>name</i> ]	<i>name</i> = domain name (i.e. eairlink.com)	<p>Domain (or domain zone) of which the Raven is a part. This value is used during name resolutions if a fully qualified name is not provided and also for DNS updates. This value can be up to 20 characters long.</p> <p>If *DOMAIN=eairlink.com, then when ATDT@remote1 is entered, the fully qualified name remote1.eairlink.com will be used to perform a DNS query to resolve the name to an IP address.</p> <p><b>Note:</b> Only letters, numbers, hyphens, and periods can be used.</p>
*IPMANAGER <i>n</i> =[ <i>name</i> ]	<i>n</i> = 1 or 2 <i>name</i> = domain name	<p>Sets a domain name or IP address to send IP change notifications to. Up to two independent IP Manager servers can be set, using either AT*IPMANAGER1 or AT*IPMANAGER2. Updates to a server can be disabled by setting that entry to nothing (i.e. "AT*IPMANAGER1=").</p>

**TABLE 14. IP Manager**

Command	Parameters	Details
*IPMGRKEY $n$ =[ <i>key</i> ]	$n = 1$ or $2$  <i>key</i> = 128-bit key in hexadecimal [32 hex characters]	Sets the 128-bit key to use to authenticate the IP update notifications. If the key's value is all zeros, a default key will be used. If all the bytes in the key are set to FF, then no key will be used (i.e. the IP change notifications will not be authenticated). AT*IPMGRKEY1 is used to set the key to use with AT*IPMANAGER1, while AT*IPMGRKEY2 is used to the key with AT*IPMANAGER2.
*IPMGRUPDATE $n$ = $m$	$n = 1$ or $2$  $m = 5$ -255	Sets the number of minutes to periodically send an IP update notification to the corresponding server. This will occur even if the IP address of the Raven doesn't change. *IPMGRUPDATE1 is used to set the refresh rate to *IPMANAGER1, while *IPMGRUPDATE2 is used with *IPMANAGER2.  If the value is set to 0, then periodic updates will not be issued (i.e. IP change notifications will only be sent when the IP actually changes).
*MODEMNAME=[ <i>name</i> ]	<i>name</i> = domain name (i.e. eairlink.com)	Name of the Raven (up to 20 characters long) to use when performing IP change notifications to IPManager. The value in *DOMAIN provides the domain zone to add to this name.  Example: if *MODEMNAME= <b>mymodem</b> and *DOMAIN= <b>eairlink.com</b> , then the modem's fully qualified domain name is <b>mymodem.eairlink.com</b> .  <b>Note:</b> Each modem using IPManager needs a unique name. Two modems cannot be called "mymodem". One could be "mymodem1" with the other as "mymodem".  Automatically Generated Names:  <b>#I3</b> - The ESN/IMEI will be used as the name.  <b>#NETPHONE</b> - The phone number be used as the name.  <b>Note:</b> Only letters, numbers, hyphens, and periods can be used.



---

---

## Logging

The Raven allows several different levels of logging.

**TABLE 15. Logging**

Command	Parameters	Details
*DBGCOM1000= <i>n</i>	<i>n</i> =0 or 1	Turn on debugging for COM1000. <b>0</b> : No logging <b>1</b> : Logging
*DBGCOMLVL= <i>n</i>	<i>n</i> =0   1   2	Set the logging level for the host or module COM port. <b>0</b> : No logging <b>1</b> : Host COM <b>2</b> : Module COM
*DBGEVTLOGCLEAR	<i>none</i>	Clears the content of the logs in the modem.
*DBGIPLVL= <i>n</i>	<i>n</i> =0   1   2	Sets the logging level for the IP subsystem. <b>0</b> : No logging <b>1</b> : Log errors (i.e. invalid/corrupt packets, etc.). <b>2</b> : Log the header of all received packets. Note that this can quickly exhaust the event log.
*DBGPPPLVL= <i>n</i>	<i>n</i> =0-3	Sets the logging level for the PPP stack. Enables logging at different levels of detail. (default = 1). <b>0</b> : No logging

## Modbus

Modbus, commonly used with telemetry devices, allows a connection via serial port to the modem (page 32).



**TABLE 16. Modbus Settings**

<b>Command</b>	<b>Parameters</b>	<b>Details</b>
IPL= <i>n</i>	<i>n</i> =0 or 1	<p>IP List Dial</p> <p>This allows access the Modbus IP list using the first two digits of the dial string. Example: ATDT1234567 would go to ID "12" on the Modbus list and use the associated IP as the destination.</p> <p><b>0</b> : Disabled  <b>1</b> : Enabled</p> <p><i>Cannot be configured in Wireless ACE.</i></p>
MD <i>hh</i>	<p><i>hh</i> (hex byte) =</p> <p>00 - normal mode</p> <p>01 - SLIP mode</p> <p>02 - PPP mode</p> <p>03 - UDP mode</p> <p>04 - TCP mode</p> <p>07 - PassThru mode</p>	<p>Default power-up mode.</p> <p>When the PinPoint is power-cycled, it may enter the mode specified by this command after 5 seconds. On startup, typing ATMD0 within 5 seconds changes the mode to normal (AT command) mode.</p> <p>See also <b>S53</b> to set the port for UDP or TCP.</p>
MLIST <i>id=d.d.d.d</i>	<p><i>id</i>=ID</p> <p><i>d.d.d.d</i>=IP or name adresse</p>	<p>Enters an ID and IP address into the Modbus List. ID is a decimal value (1 to 100).</p> <p><b>Note:</b> In Wireless ACE, this command (and MLISTX) is the <b>Addr List</b> menu option.</p>
MLISTX <i>hexid=d.d.d.d</i>	<p><i>hexid</i>=ID</p> <p><i>d.d.d.d</i>=IP or name adresse</p>	<p>Enters an ID and IP address into the Modbus List. ID is a hexadecimal value (0 to 64).</p> <p><b>Note:</b> This value is entered via Wireless ACE as 0xHex.</p>
MVLEN= <i>n</i>	<i>n</i> = 1 or 2	<p>Modbus Variant ID Length.</p> <p>Length of the RTU ID in a modbus-variant protocol, in bytes. This parameter is used to define the length of the RTU ID in Modbus-like protocol data packets. This parameter is used when the when the <b>MD</b> is set to hex 63.</p> <p><i>Cannot be configured in Wireless ACE.</i></p>

**TABLE 16. Modbus Settings**

Command	Parameters	Details
MVMSK= <i>hh</i>	<i>hh</i> =hex value 00 - no mask, all 8 bits (default) 0F - only the low order 4 bits	Modbus Variant ID Mask. Byte hex mask to use when extracting the ID. Specify which bits in the ID field to use. This parameter is used when the when the Mode Default (MD) is set to hex 63. <i>Cannot be configured in Wireless ACE.</i>
MVOFF= <i>n</i>	<i>n</i> = 0 - 255	Modbus (variable mode) Offset. Indicates the offset in the data of where the Modbus ID starts. <i>Cannot be configured in Wireless ACE.</i>
MVOPT= <i>n</i>	<i>n</i> = 0 or	Modbus Variant Option. Sets various behavioral options when dealing with a Modbus-variant protocol. This parameter is used when the when <b>MD</b> is set to hex 63. <b>0</b> : No special action (Default). <b>1</b> : Skip leading zeroes in Modbus packets. <i>Cannot be configured in Wireless ACE.</i>
MVTYP= <i>n</i>	<i>n</i> =0   1   2	Modbus Variant Type. The data-type of the RTU ID in a modbus-variant protocol. This parameter is used to define the data-type of the RTU ID in Modbus-like protocol data packets. This parameter is used when <b>MD</b> is set to 63. <b>0</b> : Binary (Default) <b>1</b> : ASCII Hex <b>2</b> : ASCII Decimal <i>Cannot be configured in Wireless ACE.</i>

**TABLE 16. Modbus Settings**

Command	Parameters	Details
RKEY= <i>n</i>	<i>n</i> = 0 or	Radio Transceiver Keying. <b>0</b> : Off (Default) <b>1</b> : On Enable/disable MDS Radio transceiver keying. Radio keying is designed to assert CTS when a packet is received, delay the time as specified, send the data out the serial port, wait the same amount time, drop CTS. This way, the CTS signal can be used to key a transmitter on and give it time to reach its power level before data is sent to it. Delay interval is specified in <b>S221</b> . <i>Cannot be configured in Wireless ACE.</i>
S53=[ <i>method</i> ][[ <i>d.d.d.d</i> ]/ <i>ppppp</i> ]	<i>method</i> = P - UDP T - TCP N - Telnet <i>d.d.d.d</i> = IP or name adresse <i>ppppp</i> = the port address	Destination IP address, port, and method. These are used as defaults for the D (Dial) AT command. Examples: ATS53=T192.168.100.23/12345 ATS53=foo.earlink.com Telnet to the specified IP at port 12345 ATS53=192.168.100.23/12345 Query the specified IP at port 12345 ATS53=/12345 Query port 12345
*DPORT= <i>n</i>	<i>n</i> =1-65535	The modem's Device Port. Can also be set with the command <b>S110</b> .

### SNMP (Simple Network Management Protocol)

Simple Network Management Protocol (SNMP) can be used to monitor devices connected to a network for any conditions which warrant administration attention. By default, SNMP uses port 161, however most Internet providers (including cellular) block all ports below 1024 as a security measure.

**TABLE 17. SNMP**

<b>Command</b>	<b>Parameters</b>	<b>Details</b>
<code>\ACEPW=<i>pw</i></code>	<i>pw</i> =password	Change the ACE password to a new value. Password is case-sensitive. Default password is 12345. Example: <b>AT\ACEPAW=new123</b>
<code>*SNMPPORT=<i>n</i></code>	<i>n</i> =0-65535	This controls which port the SNMP Agent listens on. <b>0</b> : SNMP is disabled. Port for SNMP agent to listen on.
<code>*SNMPSECLVL=<i>n</i></code>	<i>n</i> =0   1   2	Selects the security level requirements for SNMP communications as follows: <b>0</b> : No security required. SNMPv2c and SNMPv3 communications are allowed. <b>1</b> : Authentication equivalent to 'authNoPriv' setting in SNMPv3. SNMPv3 is required to do authentication, SNMPv2c transmissions will be silently discarded. <b>2</b> : Authentication and encryption, equivalent to 'authPriv' setting in SNMPv3. SNMPv3 is required to do authentication and encryption, SNMPv2c and SNMPv3 authNoPriv transmissions will be silently discarded. Messages are both authenticated and encrypted to prevent a hacker from viewing its contents.
<code>*SNMPTRAPDEST=<i>host</i>/ [<i>port</i>]</code>	<i>host</i> =IP address <i>port</i> =TCP port	Controls destination for SNMP Trap messages. If port is 0 or host is empty, traps are disabled. Traps are sent out according to the SNMP security level (i.e. if the security level is 2, traps will be authenticated and encrypted). Currently, the only trap that can be generated is linkup.

### SMTP/SMS

SMTP (Simple Mail Transfer Protocol) is the de facto standard for email transmission across the Internet. The Raven can send messages using SMTP if it has been configured to use a mail server.

SMS (Simple Message Service) is another way to send messages via your Wireless Service Provider's cellular network.



**Caution:** Your account with Verizon may not support message sending. For most SMS commands (those not preceded by \*), you will need to have the modem in PassThru mode.

**TABLE 18. SMTP (email) and SMS (messaging)**

Command	Parameters	Details
*NETSMS2EMAIL= [ <i>number</i> ]	<i>number</i> = SMS/ E-mail server	Specify the SMS/E-mail server number. This is necessary to send an SMS message to an email address (+CMGS).
*SMTPADDR= [ <i>d.d.d.d</i> ][ <i>name</i> ]Maximum: 40 characters	<i>d.d.d.d</i> =IP <i>name</i> = domain name	Specify the IP address or Fully Qualified Domain Name (FQDN) of the SMTP server to use.
*SMTPFROM=[ <i>email</i> ]Max- imum: 30 characters	<i>email</i> = email address	Sets the email address from which the SMTP message is being sent.
*SMTPPW=[ <i>pass</i> ]	<i>pass</i> = password	Sets the password to use when authenticating the email account (*SMTPFROM) with the server (*SMTPADDR). <b>Note:</b> Not required to use SMTP settings but may be required by carrier.
*SMTPSEND=[ <i>email</i> ][ <i>body</i> ]	<i>email</i> = email address <i>body</i> = message body	Sends an email to the address specified, followed by the body of the email message. The email message is terminated and sent by entering a . or <b>Ctrl-Z</b> on an empty line. See also *SMTPSUBJ, *SMYFROM, and *SMTPADDR.
*SMTPSTATUS?	<i>none</i>	Returns the status of the last issued SMTP message (*SMTPSEND). If no status is available 0 is returned. Once read, the status is cleared out. The status codes are received from the SMTP server the modem attempted to send the request. Example: 354 = send in progress, 250 = sent ok.
*SMTPSUBJ=[ <i>subject</i> ]	<i>subject</i> = SMTP message subject	Allows configuration of the default Subject to use if one isn't specified in the message by providing a "Subject: xxx" line as the initial message line.

**TABLE 18. SMTP (email) and SMS (messaging)**

<b>Command</b>	<b>Parameters</b>	<b>Details</b>
*SMTPUSER=[ <i>user</i> ]Maximum: 40 characters	<i>user</i> = username	The email account username to authenticate with the SMTP server (*SMTPADDR) for sending email. <b>Note:</b> not required to use SMTP settings but may be required by carrier.
+CMGD= <i>index</i> [ <i>flag</i> ] <i>C3211</i>	<i>index</i> =0-9  <i>flag</i> =0 <i>flag</i> =1 <i>flag</i> =2 <i>flag</i> =3 <i>flag</i> =4	This command is used to delete one or several messages. Delete message at location. Delete All READ messages. Delete All READ and SENT messages. Delete All READ, SENT and UNSENT messages. Delete All messages. <b>Note:</b> There is no confirmation required.
+CMGR= <i>index</i> <i>C3211</i>	<i>index</i> =0-9	Read a message.
+CMGS=[ <i>email</i> ][ <i>body</i> ] <i>C3211</i>	<i>email</i> = email address or phone number <i>body</i> = message body	Sends an email using SMS. The phone number or email address is specified first. Then the body of the message is entered. E-mail is only available if *NETSMS2EMAIL has been configured correctly. The message is terminated and sent by entering <b>Ctrl-Z</b> on an empty line.
!CNTSMS <i>C3210</i>	<i>none</i>	Reports the number of messages stored: New Urgent Msg {Index = 1}: <n> New Regular Msg {Index = 2}: <r> Voice Messages {Index = 3}: <v>  The Index number corresponds to the SMS list index used to retrieve messages. The counters n, r, and v indicate the number of messages in each list.  When retrieving (!GSMS) or deleting (!DSMS), the message number is base 0, so the highest message number in any list is the reported count minus one.
!DASMS <i>C3210</i>	<i>none</i>	Deletes all SMS messages from all three index lists. <b>Note:</b> There is no confirmation required. Use this with caution.

**TABLE 18. SMTP (email) and SMS (messaging)**

<b>Command</b>	<b>Parameters</b>	<b>Details</b>
!DSMS = <i>index</i> [ <i>message</i> ]  <i>C3210</i>	<i>index</i> = index list (0, 1, 2)  <i>message</i> =mes- sage number	Deletes one or all messages from one of the index lists.  The message number is a base 0 index into the list, where 0 is the oldest message, and the number reported by !CNTSMS minus one, is the most recent message.  If the message number parameter is omitted, then all messages in the index list are deleted.  <b>Note:</b> There is no confirmation required.
!GSMS? <i>index,message</i>  <i>C3210</i>	<i>index</i> = index list (0, 1, 2)  <i>message</i> = mes- sage number	Read an SMS message from the modem. The message read is determined by the parameters:  The message number is a base 0 index into the list, where 0 is the oldest message, and the number reported by !CNTSMS minus one, is the most recent message.
!SSMS= <i>priority,destina- tion,[cb],”text”</i>  <i>C3210</i>	<i>priority</i> =0, 1, 2)  <i>destination</i> = phone number of destination  <i>cb</i> = call back number  <i>text</i> = text of message enclosed in quotes	Send an SMS message.  <b>Note:</b> The text is enclosed in quotations. The quote character cannot appear in the body text. Messages with over 160 bytes of body text will be truncated and sent anyway.
!SSMS?  <i>C3210</i>	<i>none</i>	The progress of the last message sent. Possible responses are:  Pending message has not left the modem  Sent successfully  Sent to the network  Delivered successfully  Delivered by the network  Failed sending  Failed and should be retried

**Other**

**TABLE 19. Other Settings**

<b>Command</b>	<b>Parameters</b>	<b>Details</b>
*NUMTOIP= <i>n</i>	<i>n</i> =0 or 1	Convert 12 digit number to IP. <b>0</b> : Use as name. <b>1</b> : Use as IP.
+CTA= <i>n</i>	<i>n</i> =seconds	Inactivity timer, in seconds. Typical network settings cause a link to go dormant after 10 to 20 seconds of inactivity, no packets transmitted or received. This time can be shortened to release the physical RF link sooner when the application only transmits short bursts.



## *Example of the MIB trap*

---

```
AIRLINK-MIB DEFINITIONS ::= BEGIN

IMPORTS
    ObjectNameFROM SNMPv2-SMI
    MODULE-COMPLIANCEFROM SNMPv2-CONF;

org OBJECT IDENTIFIER ::= { iso 3 }
dod OBJECT IDENTIFIER ::= { org 6 }
internet OBJECT IDENTIFIER ::= { dod 1 }
private OBJECT IDENTIFIER ::= { internet 4 }
enterprises OBJECT IDENTIFIER ::= { private 1 }

airlink OBJECT IDENTIFIER ::= { enterprises 20542 }
general OBJECT IDENTIFIER ::= { airlink 1 }
common OBJECT IDENTIFIER ::= { airlink 2 }
```

---

status OBJECT IDENTIFIER ::= { airlink 3 }

gps OBJECT IDENTIFIER ::= { airlink 4 }

-- GENERAL --

phoneNumber OBJECT-TYPE

SYNTAX DisplayString (SIZE (10))

MAX-ACCESS read-only

STATUS current

::= { general 1 }

deviceID OBJECT-TYPE

SYNTAX DisplayString

MAX-ACCESS read-only

STATUS current

::= { general 2 }

electronicID OBJECT-TYPE

SYNTAX DisplayString

MAX-ACCESS read-only

STATUS current

::= { general 3 }

modemType OBJECT-TYPE

SYNTAX DisplayString

MAX-ACCESS read-only

STATUS current

::= { general 4 }

---

aleosSWVer OBJECT-TYPE

SYNTAX DisplayString

MAX-ACCESS read-only

STATUS current

::= { general 5 }

aleosHWVer OBJECT-TYPE

SYNTAX DisplayString

MAX-ACCESS read-only

STATUS current

::= { general 6 }

modemSWVer OBJECT-TYPE

SYNTAX DisplayString

MAX-ACCESS read-only

STATUS current

::= { general 7 }

modemHWVer OBJECT-TYPE

SYNTAX DisplayString

MAX-ACCESS read-only

STATUS current

::= { general 8 }

-- COMMON --

date OBJECT-TYPE

SYNTAX DisplayString

MAX-ACCESS read-only

---

STATUS current  
 ::= { common 1 }

otaProgrammingEnable OBJECT-TYPE  
SYNTAX INTEGER {  
disabled(0),  
enabled(1) }  
MAX-ACCESS read-only  
STATUS current  
 ::= { common 2 }

devicePort OBJECT-TYPE  
SYNTAX INTEGER(0..65535)  
MAX-ACCESS read-only  
STATUS current  
 ::= { common 3 }

netUID OBJECT-TYPE  
SYNTAX DisplayString  
MAX-ACCESS read-only  
STATUS current  
 ::= { common 4 }

netPW OBJECT-TYPE  
SYNTAX DisplayString  
MAX-ACCESS read-only  
STATUS current  
 ::= { common 5 }

---

requestPAP OBJECT-TYPE

SYNTAX INTEGER {

no(0),

yes(1) }

MAX-ACCESS read-only

STATUS current

::= { common 6 }

destinationAddress OBJECT-TYPE

SYNTAX DisplayString

MAX-ACCESS read-only

STATUS current

::= { common 7 }

destinationPort OBJECT-TYPE

SYNTAX INTEGER(0..65535)

MAX-ACCESS read-only

STATUS current

::= { common 8 }

serialPortSettings OBJECT-TYPE

SYNTAX DisplayString

MAX-ACCESS read-only

STATUS current

::= { common 9 }

serialPortFlowControl OBJECT-TYPE

---

---

```
SYNTAX INTEGER {  
  none(0),  
  hardware(2),  
  software(4) }  
MAX-ACCESS read-only  
STATUS current  
 ::= { common 10 }
```

```
-- STATUS --  
ipAddress OBJECT-TYPE  
SYNTAX IpAddress  
MAX-ACCESS read-only  
STATUS current  
 ::= { status 1 }
```

```
netState OBJECT-TYPE  
SYNTAX DisplayString  
MAX-ACCESS read-only  
STATUS current  
 ::= { status 2 }
```

```
netChannel OBJECT-TYPE  
SYNTAX INTEGER  
MAX-ACCESS read-only  
STATUS current  
 ::= { status 3 }
```

```
rssI OBJECT-TYPE
```

---

SYNTAX INTEGER(-125...-50)

MAX-ACCESS read-only

STATUS current

::= { status 4 }

serialSent OBJECT-TYPE

SYNTAX INTEGER

MAX-ACCESS read-only

STATUS current

::= { status 5 }

serialReceived OBJECT-TYPE

SYNTAX INTEGER

MAX-ACCESS read-only

STATUS current

::= { status 6 }

hostMode OBJECT-TYPE

SYNTAX DisplayString

MAX-ACCESS read-only

STATUS current

::= { status 7 }

powerMode OBJECT-TYPE

SYNTAX DisplayString

MAX-ACCESS read-only

STATUS current

::= { status 8 }

---

fixObtained OBJECT-TYPE

SYNTAX INTEGER {

no(0),

yes(1) }

MAX-ACCESS read-only

STATUS current

::= { gps 1 }

satelliteCount OBJECT-TYPE

SYNTAX INTEGER

MAX-ACCESS read-only

STATUS current

::= { gps 2 }

latitude OBJECT-TYPE

SYNTAX DisplayString

MAX-ACCESS read-only

STATUS current

::= { gps 3 }

longitude OBJECT-TYPE

SYNTAX DisplayString

MAX-ACCESS read-only

STATUS current

::= { gps 4 }

END





---

# Troubleshooting

---

## *Frequently Asked Questions (FAQ) and Solutions*

Many of these questions and solutions come from AirLink Support.



**Caution:** Solutions should only be performed if you are experiencing the specific problem indicated and have the specific modem model number indicated. Some solutions are very specific to model numbers due to differing internal hardware.



### **What is RSSI? Why is the RSSI for my Raven negative?**

RSSI (Received Signal Strength Indication) is a measurement of the strength, not necessarily the quality, of the received signal strength in a wireless environment. RSSI is used to determine when the signal is below a certain threshold at which point the modem is clear to send (CTS) or to determine the Roaming Threshold (the distance from the access point).

The RSSI is measured in dBm which is the power ratio in decibel (dB) of the measured power referenced to one milliwatt (mW). One milliwatt is zero, therefore less than a milliwatt, common and ideal for cellular communication, is expressed as a negative interger.

---

---

AirLink modems optimally have an RSSI value of -60 to -95.



### **What is the Proper RF Coverage for my Raven?**

Optimal RF coverage (RSSI) for your Raven is between -60 to -95 DBm. RF coverage between -95 to -105 DBm will generally still register, however functionality at this range can be impeded and registration can become temperamental. Any devices with an RSSI below -105 DBm will likely fail to register on a regular basis.



**Caution:** Low RSSI will have a direct affect on the ability to activate (or provision) your Raven if it relies on over the air activation such as the the C3211 and C32 modems.

When addressing RF coverage ensure the antenna choice is appropriate for the device and frequencies required.



### **What Type of Antenna is Best for my Raven?**

Antennas for cellular communication are generally omni-directional and either dual-band or multi-band. They come in a variety of shapes and mounting configurations to suit several different types of needs.

While AirLink does sell a limited selection of antennas and antenna accessories, these are by no means all that are available or usable with your Raven. There are several suppliers of cellular accessories with a much wider selection of antennas designed to cater to a broader variety of situations.

#### **Dual-band**

For cellular communication, the Raven requires a dual band antenna supporting both 800 MHz and 1900 MHz (1.9 Ghz) bands.



**Caution:** Single band antennas, such as those formerly used with a CDPD device, generally only support 800 MHz. Using a single band antenna can greatly impede your ability to activate or use your Raven with Verizon.

#### **Dipole**

Dipole is a common antenna type connecting directly to the Raven and extending out in a single straight wire.

---

---

The short dipole antenna (also known as a “rubber duck”) is a good desktop, portable antenna for use in areas with good signal strength and low electrical interference.

### **Mounts**

Antennas can be mounted in a variety of ways (magnet, permanent, suction to a window, sticky tape, etc) which can allow you to move the antenna away from the Raven with a coax cable between the modem and the antenna allowing the antenna to be placed in a more suitable location for proper cellular reception: outside of a metal cabinet, the trunk lid of a car, a window, etc. A mounted antenna can be placed in locations where the simple, short dipole antenna connected directly to the Raven may not perform at all.



### **What do I need to power my Raven ?**

Your Raven is designed to work either on DC current (generally for use in vehicles) or with an AC adapter (standard wall outlet in the US, Canada, and most other countries). The optimal input voltage is 9VDC to 28VDC with an input current from 90mA to 350 mA.

If the modem is provided an inadequate power supply the following symptoms might be experienced:

- Modem will constantly power cycle while attempting to register
- Modem will register but will power cycle when data is transmitted/received

If these symptoms occur, verify the power supply meets the above mentioned criteria. If an AC adapter is being used; verify it is intended for the AirLink product in question.



**Caution:** If you previously used AirLink CPDP modems, you may have older power supplies that provide inadequate power and will cause the above mentioned symptoms.



### **Can I use a portable battery to power my Raven ?**

It is possible to use a portable battery for your AirLink modem, however, you most likely need to make the connector from the battery to the modem yourself. The battery also needs to have enough power to be able to handle the power consumption of

---

---

the modem. You can contact AirLink Support for a Guide on how to use your Air-Link modem with a portable battery.



### **I'm Having Problems getting my Raven registered (activated or provisioned) with Verizon, what could be the problem?**

There are several error messages that might appear during the registration process:

- No Service
- Network Negotiation Failed
- Network Authentication Failed

These problems are frequently caused by account related issues. The problems potentially involve an incorrectly configured account or incorrectly input/provisioned account information. The best troubleshooting step is to re-provision the Raven, confirming the account is configured for the proper data plan and modem or simply work with Verizon to create a new account.



### **Why Can't I reach my Raven from the Internet? What is a Restricted or Private IP?**

On Verizon's network, for security reasons, there are some accounts set up to be restricted to communication only from other devices on their network, called a Restricted IP or a Private IP. If you had two modems on Verizon's network, they could communicate, but your computer, not using Verizon as an ISP can't. You could generally still access the Internet using your Raven's restricted or private IP because the modem would use a proxy or gateway on Verizon's network.

However, if you need to be able to contact your Raven (or the devices behind it) directly, instead of a **Restricted IP** (also called **Private IP** or **Non-Routable IP**), you will need to contact Verizon to get your account changed to an **Unrestricted IP** (also called **Public IP**).



### **What is the difference between Private Mode and Public Mode?**

When your Raven is powered on, ALEOS, acting as a PPP client, negotiates a PPP session with Verizon's network at the conclusion of which it is assigned an IP address by Verizon. How this address is further acted upon by the modem is determined by Private or Public Mode.

---

---

### Public Mode (\*HOSTPRIVMODE=0) :

The IP address assigned by Verizon is passed on to the devices connected to the modem.

If there is a computer or device connected to the serial port of your modem, there are actually two PPP sessions taking place. After your AirLink modem receives the cellular provider's assigned IP address, a second PPP session established between your computer or device and the modem ultimately assigns that IP address to that computer or device connected to the serial port.

### Private Mode (\*HOSTPRIVMODE=1) :

The IP address assigned by Verizon is not the address that is assigned to the computer or device connected to the Raven's serial port during the PPP negotiation . Instead, the computer or device connected to the Raven on the serial port is assigned the IP address configured in \*HOSTPRIVIP and uses the IP address configured in \*HOSTPEERIP to communicate to the modem.



### How do I set up Private Mode? How do I connect to my Raven to my router or to Linux?

Private Mode is at times preferred or required to provide network connectivity to a Linux device, routers, or other devices. Private mode will generally also work with any PC in an environment where there is a need for the Raven to be configured to work with an internal network.

There are four AT commands you will need to set in the modem. You can set them using Wireless ACE (page 10) or Telnet (page 53). The examples shown are from Wireless ACE 3G.

**FIGURE 1. Wireless ACE: Private Mode settings**

AT	Name	Value	New Value
*HOSTPRIVMODE	Use Private IP	0	1-Use Private IP
*HOSTPRIVIP	Host Private IP	0.0.0.0	192.168.1.8
*HOSTPEERIP	Modem Local IP	192.168.13.31	192.168.1.9
*HOSTNETMASK	Host network mask	0.0.0.0	255.255.255.0

---

**\*HOSTPRIVMODE=1** - Private Mode turned on.

**\*HOSTPRIVIP=[IP address]** - IP address assigned to computer or other device connected directly to the modem (example, *192.168.1.8*).

**\*HOSTPEERIP=[IP address]** - IP address assigned to modem for local, not cellular, communication (example, *192.168.1.9*).

**\*HOSTNETMASK=[subnet mask]** - Subnet Mask setting (example, *255.255.255.0*).

The IP addresses configured need to be appropriate for your network. For most internal networks, using the IP range of 192.168.x.x is generally preferred. The first 3 octets need to be the same for all devices on the network (such as 192.168.1.x), but you can use any number from 0 to 254 for the last octet. The last octet for each IP on the network needs to be different. Unless you are instructed to use a different IP range by your Network Administrator, using the 192.168.1.x or 192.168.0.x is recommended.

The **\*HOSTPRIVIP** and the **\*HOSTPEERIP** need to exist on same subnet, the easiest subnet to configure is 255.255.255.0 which allows for 255 IPs on the same subnet. Unless you understand the complexities of subnetting or you are instructed to use a different subnet by your Network Administrator, it is generally safe to use 255.255.255.0. For this subnet, the first 3 sets of numbers (octets) need to be the same with the final number different (such as 192.168.1.x).



**Caution:** If the IP address of the device or computer connected to the modem is different from the one configured in the modem as the **\*HOSTPEERIP**, communications will fail. If the Subnet Mask is configured differently in the modem than on the computer or device to which it is connected, you may not be able to communicate between them.



### **What is the COM1000?**

The COM1000 is a stand-alone device not made by AirLink but that can be used with your Raven. There are AT commands for your Raven AirLink modem which take advantage of some of the properties of the COM1000. The COM1000 is made by SimpleComTools: <http://www.simplecomtools.com/com1000.html> and used in conjunction with AirLink modems: <http://www.simplecomtools.com/wireless.html>.

From SimpleComTools description of the COM1000:

---

---

“The COM1000 provides you with a single device that can be seamlessly integrated into LAN, WAN, and WIRELESS projects. Its embedded applications provide quick and easy means of connecting serial devices to IP networks, Internet enabling legacy devices, or integrating remote devices with today's advanced 3G wireless data networks. Its unique blend of Serial and TCP/IP communications, digital and analog inputs, relays, and embedded applications combine to help simplify application integration and eliminate many of today's Machine-to-machine deployment challenges.”

 **How can I update the PRL (Preferred Roaming List) for my CDMA modem? I have activated my Raven but now cannot connect to Verizon, what can be wrong?**

If you are experiencing difficulties connecting your Raven with Verizon after it is activated with the Setup Wizard, the PRL may be out of date.

#### Wireless ACE



**Caution:** The modem's version of ALEOS will need to be 200512A or later.

1. Connect to your Raven AirLink modem using Wireless ACE 3G version 20051201 or later (page 10).
2. On the top Configuration Panel, click the icon for **Update PRL**.

**FIGURE 2. Wireless ACE: Update PRL**



When you start the Update PRL feature, PRL specific information will be displayed: the Carrier, the current PRL in the modem, the PRL version for the update, and the detected Master Subsidiary Lock (MSL).



---

**FIGURE 3. Wireless ACE: Update PRL interface**

---

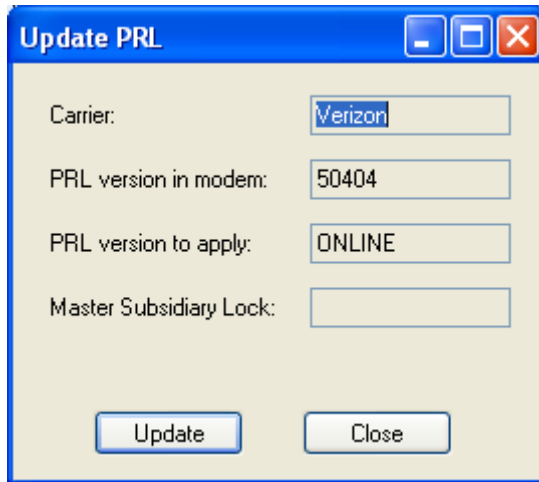

Generally the PRL will be updated to the one present in the “PRL” folder of the Wireless ACE installed folder (i.e. C:\Program Files\AirLink\Wireless Ace 3G\PRL). If the PRL version to apply is displayed as **ONLINE**, then the PRL will be updated Over-the-Air (OTA) directly from Verizon.



**Attention :** If you are using ONLINE updating, your Raven Air-Link modem needs to be able to contact Verizon’s your cellular provider’s network for the over-the-air process to be successful. You may need to move the modem or connect a different antenna to get a clear strong signal. [If you are connected to your modem remotely, you may incur data charges for the update.](#)

### AT Commands

You can use AT commands to manually trigger an Over-the-Air PRL update.

1. Connect to the Raven direct serial communication (page 53).
2. Type `AT\APASSTHRU` and press Enter to put modem into Pass Thru Mode.
3. Wait at least 30 seconds to initialize the modem.
4. Type `AT!STATUS` and press Enter to check the network status:

---

**Modem has not registered:** This can be a transitory state. Wait 30 to 60 seconds and attempt the command again.

**Modem is registering:** Generally, this indicates the Raven is attempting to contact Verizon's your cellular provider's network. Wait 30 to 60 seconds and attempt again.

**Modem has registered:** When you see this message, the Raven is registered on Verizon's network . Continue on to the next step. .

**FIGURE 4. Pass Thru Mode: Modem Status**

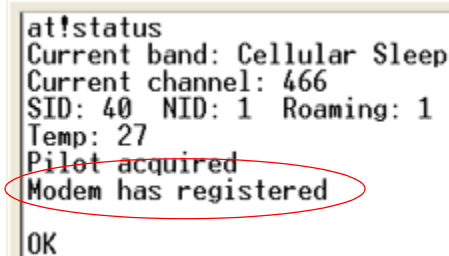

```
at!status
Current band: Cellular Sleep
Current channel: 466
SID: 40 NID: 1 Roaming: 1
Temp: 27
Pilot acquired
Modem has registered
OK
```

5. Type **AT+GMR** and press Enter. You should get a long output response. Near the end of the output, will be the current five-digit PRL version.

**FIGURE 5. Pass Thru Mode: +GMR example**

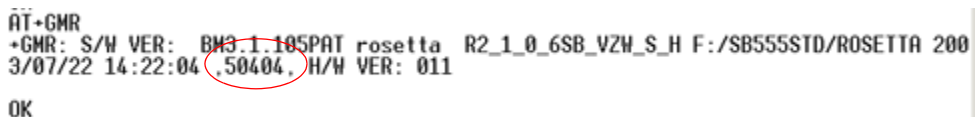

```
AT+GMR
+GMR: S/W VER: BM3.1.185PAT rosetta R2_1_0_6SB_VZW_S_H F:/SB555STD/ROSETTA 200
3/07/22 14:22:04 .50404. H/W VER: 011
OK
```

6. Issue **AT+CDV\*22899** and Press Enter. You should get “**OK**” as a response. Wait 2 to 3 minutes for the PRL to download and install.
7. Enter **AT+GMR** again to verify the PRL version change.

---

---

### *Support web site*

The Airlink web site is updated frequently with Setup Wizards, Utilities, FAQs, and other documentation:

<http://www.airlink.com/support>

---

### *Contacting Technical Support*

For support assistance please email [support@airlink.com](mailto:support@airlink.com) or call **510-781-9760** Monday through Friday 5 AM to 5 PM Pacific Time (8 AM to 8 PM Eastern Time). Support is not available weekends or holidays.

## Free Manuals Download Website

<http://myh66.com>

<http://usermanuals.us>

<http://www.somanuals.com>

<http://www.4manuals.cc>

<http://www.manual-lib.com>

<http://www.404manual.com>

<http://www.luxmanual.com>

<http://aubethermostatmanual.com>

Golf course search by state

<http://golfingnear.com>

Email search by domain

<http://emailbydomain.com>

Auto manuals search

<http://auto.somanuals.com>

TV manuals search

<http://tv.somanuals.com>