



Raven and PinPoint CDMA

User Guide

Version 1.12

AirLink Communications, Inc.

March 24, 2004

Information in this document is subject to change without notice.
© Copyright AirLink Communications, Inc, 1993-2004. All rights reserved.

Please send comments to:

email: pubs@AirLink.com

Fax: 510-264-5422

Phone: 510-264-5400

Post: AirLink Communications, Inc.
 Attention: Technical Publications Dept.
 3159 Corporate Place
 Hayward, CA 94545

Important Notice

Because of the nature of wireless communications, transmission and reception of data can never be guaranteed. Data may be delayed, corrupted (i.e., have errors) or be totally lost. Although significant delays or losses of data are rare when wireless devices such as the AirLink Communications modem are used in a normal manner with a well-constructed network, the AirLink modem should not be used in situations where failure to transmit or receive data could result in damage of any kind to the user or any other party, including but not limited to personal injury, death, or loss of property. AirLink Communications, Inc., accepts no responsibility for damages of any kind resulting from delays or errors in data transmitted or received using the AirLink Communications modem, or for failure of the AirLink Communications modem to transmit or receive such data.

Safety and Hazards

Do not operate the AirLink Communications modem in areas where blasting is in progress, where explosive atmospheres may be present, near medical equipment, near life support equipment, or any equipment which may be susceptible to any form of radio interference. In such areas, the AirLink Communications modem **MUST BE POWERED OFF**. The AirLink Communications modem can transmit signals that could interfere with this equipment. Do not operate the AirLink Communications modem in any aircraft, whether the aircraft is on the ground or in flight. In aircraft, the AirLink Communications modem **MUST BE POWERED OFF**. When operating, the AirLink Communications modem can transmit signals that could interfere with various onboard systems. The driver or operator of any vehicle should not operate the AirLink Communications modem while in control of a vehicle. Doing so will detract from the driver or operator's control and operation of that vehicle. In some states and provinces, operating such communications devices while in control of a vehicle is an offence.

Limitation of Liability

The information in this manual is subject to change without notice and does not represent a commitment on the part of AirLink Communications, Inc. AIRLINK COMMUNICATIONS, INC. SPECIFICALLY DISCLAIMS LIABILITY FOR ANY AND ALL DIRECT, INDIRECT, SPECIAL, GENERAL, INCIDENTAL, CONSEQUENTIAL, PUNITIVE OR EXEMPLARY DAMAGES INCLUDING, BUT NOT LIMITED TO, LOSS OF PROFITS OR REVENUE OR ANTICIPATED PROFITS OR REVENUE ARISING OUT OF THE USE OR INABILITY TO USE ANY AIRLINK COMMUNICATIONS, INC. PRODUCT, EVEN IF AIRLINK COMMUNICATIONS, INC. HAS BEEN ADVISED OF THE POSSIBILITY OF SUCH DAMAGES OR THEY ARE FORESEEABLE OR FOR CLAIMS BY ANY THIRD PARTY.

Raven and PinPoint CDMA User Guide

Table of Contents

1	Introduction	1
1.1	CDMA2000 1X	1
1.2	Raven Product Overview	2
1.3	PinPoint Product Overview	2
2	Network Connection.....	3
2.1	Internet (TCP/IP) Connections via 1xRTT	3
2.2	Data Connections.....	3
3	Modem Configuration.....	5
3.1	Local Configuration	5
3.2	Modem Activation.....	7
3.3	Remote Configuration.....	9
4	Windows Dial-Up Networking Setup	12
4.1	Add Windows Modem Driver	12
4.1.1	Setup Modem	12
4.1.2	Add Modem Driver	12
4.2	Windows Dial-Up Networking (PPP) Configuration	15
4.3	Making a 1xRTT Data Connection	23
5	Dynamic IP Addresses.....	25
5.1	IPManager and Dynamic DNS Updates.....	26
5.2	Using Names in the Modem, Domain Name Resolving.....	26
6	Serial Communication Modes.....	28
6.1	AT Mode	29
6.2	PPP Mode	29
6.3	PassThru Mode	30
6.4	UDP PAD Mode	30
6.4.1	UDP Auto Answer	31
6.4.2	Reliable UDP	31
6.4.3	Multicast UDP [Raven Only Feature]	32
6.5	TCP PAD Mode	32
6.6	TCP Auto Answer	33
6.7	Hybrid Modes.....	33
6.8	SLIP Mode.....	34
6.9	Modbus/BSAP Configuration [Raven Only Feature]	34

6.10	Configuring the Polling Host Application Raven	34
	Configuring the Remote Ravens	35
7	PinPoint Notes	36
7.1	Low-power Mode	36
	7.1.1 Effect on Modem State	36
7.2	Real-Time Clock Sync	36
7.3	Different Local and Remote Report types	36
7.4	RAP Poll Command	37
7.5	TAIP Emulation	37
7.6	NMEA Reports	38
8	PinPoint Specific AT Commands	39
9	Using AT Commands	43
9.1	CDMA Specific AT Commands	43
9.2	Raven and PinPoint AT Command Reference	44
10	Raven Installation	55
	Mounting the Raven	55
	10.1.1 Connecting the antenna	57
	10.1.2 Connecting the serial cable	57
	10.1.3 Grounding the Raven Case	57
	10.1.4 Connecting the power cable	57
11	PinPoint Vehicle Installation	60
11.1	Overview	60
11.2	Mounting the PinPoint	61
11.3	Installing the Antennas	62
12	Raven CDMA Technical Specifications	63
12.1	Quick Look	63
12.2	Physical Characteristics	63
12.3	Power Specifications	63
12.4	Environmental	63
12.5	Status LED Display	64
12.6	RF Features	64
12.7	Application Interface Features	64
12.8	CDMA and Cellular Standards	65
13	PinPoint CDMA Technical Specifications	66
13.1	Physical Characteristics:	66

13.2	Power Specifications:.....	66
13.3	Environmental:	66
13.4	Status LED Display:.....	67
13.5	RF Features:	67
13.6	Application Interface Features:	67
13.7	CDMA and Cellular Standards:.....	68
13.8	GPS Module	68

Raven and PinPoint CDMA User Guide

WARNING

The antenna(s) used for this transmitter must be installed to provide a separation distance of at least 20 cm from all persons and must not be co-located or operating in conjunction with any other antenna or transmitter and must not have a gain exceeding 2 dBi.

1 Introduction

This manual covers information for first-time setup and configuration of your AirLink CDMA modems, as well as technical details on this modem. The modem may be remotely configured. The AirLink modems are also capable of having their firmware upgraded wirelessly, rendering it unnecessary to physically connect to the modem to upgrade it.

The AirLink CDMA modem is designed to operate in CDMA networks. Two services are available in the CDMA networks: 1xRTT, a packet switched connection, and IS-95B, a circuit switched connection. The Raven CDMA can be provisioned to transmit and receive data using either service.

1.1 CDMA2000 1X

The AirLink CDMA modem provides data capability into the packet service offered with CDMA2000 1X (1xRTT) technology. CDMA2000 1X offers higher speed data operations than are available with IS-95 service. IS-95 is limited to 14.4 kbps. 1X service uses a fundamental channel at 9600 bps and can add supplemental channels when needed to boost speed to as high as 153.6 kbps on the downlink (network to modem) and 76.8 kbps on the uplink (modem to network).

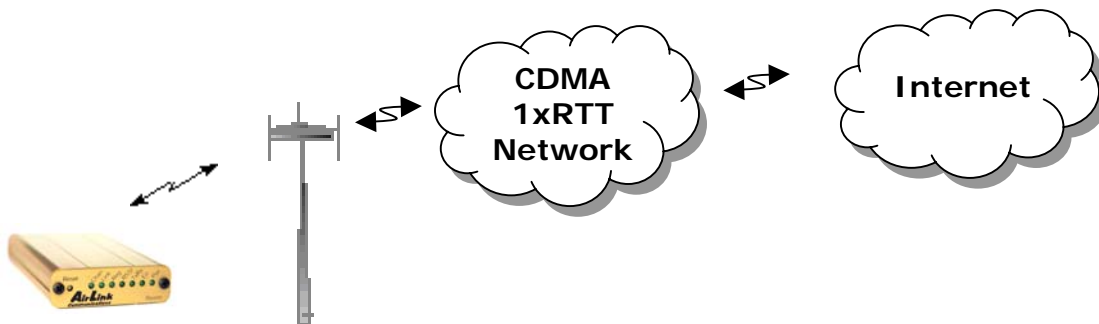

1.2 Raven Product Overview

The AirLink Raven CDMA is a rugged, full duplex 1xRTT CDMA modem that provides wireless transport capabilities for fixed and mobile applications. CDMA is an efficient and secure wireless technology that works well for fixed or mobile applications.

The Raven's rugged form factor is ideal for industrial and commercial applications that require real-time communications. The Raven provides wireless data communications for a variety of applications, such as telemetry, public safety, SCADA, traffic control, traffic metering, transit arrival systems and more.



Front of Raven CDMA



Back of Raven CDMA

1.3 PinPoint Product Overview

The AirLink PinPoint CDMA is a rugged, full duplex 1xRTT CDMA modem that provides wireless transport capabilities for fixed and mobile applications. CDMA is an efficient and secure wireless technology that works well for fixed or mobile applications.

The PinPoint's rugged form factor is ideal for industrial and commercial applications that require real-time communications. The PinPoint provides wireless data communications for a variety of applications, such as fleet management, public safety, ambulance, traffic control, home delivery, transit arrival systems and more.



Front of PinPoint CDMA



Back of PinPoint CDMA

2 Network Connection

The AirLink Raven and PinPoint CDMA modems are capable of providing network connections for 1xRTT, Circuit Switched and SMS data.

2.1 Internet (TCP/IP) Connections via 1xRTT

When using the AirLink CDMA modems, remote access is done via a PPP (TCP/IP) connection to the CDMA network. The CDMA carrier actually provides Internet connectivity, and, therefore, it becomes the ISP for that session. Applications such as web browsing, email, FTP, etc., should work as they would normally.

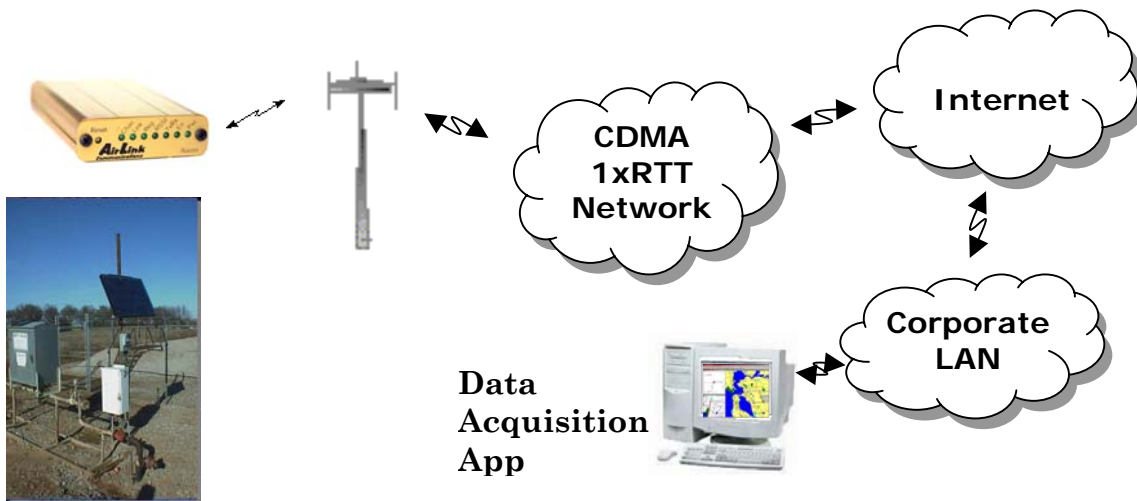

NOTE: Connections to Internet are provided by carrier.

Corporate network connections are unique and not provided as part of service.

2.2 Data Connections

When a Raven or PinPoint is powered on, it automatically searches for 1x service and establishes a PPP link between it and the network. The AirLink modem obtains its IP and is ready to communicate.



If the host establishes a PPP link to the AirLink modem, a second PPP link is created between the modem and the host. IP packets can then be sent to and received from the 1xRTT network.

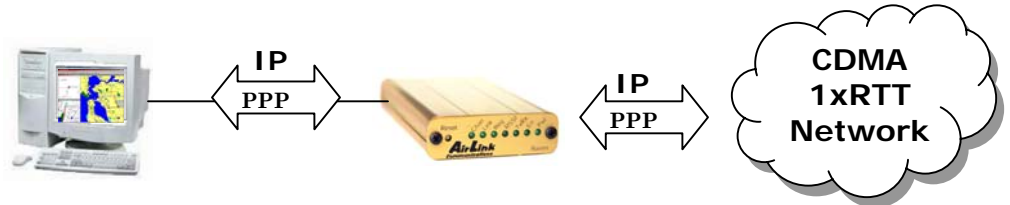

If the host device is to send and receive data via the Raven, then the Raven can be configured to use either one of the UDP or TCP packet assembly/disassembly modes.

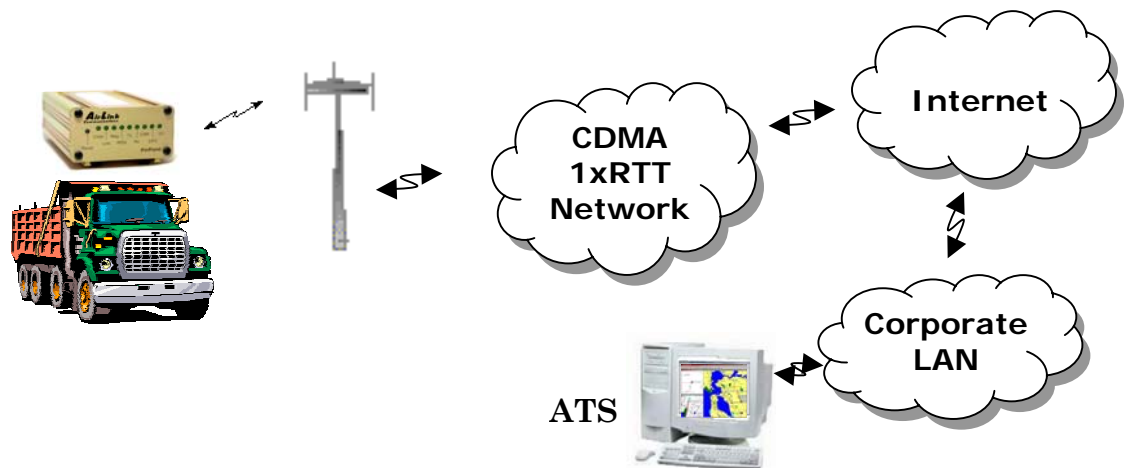
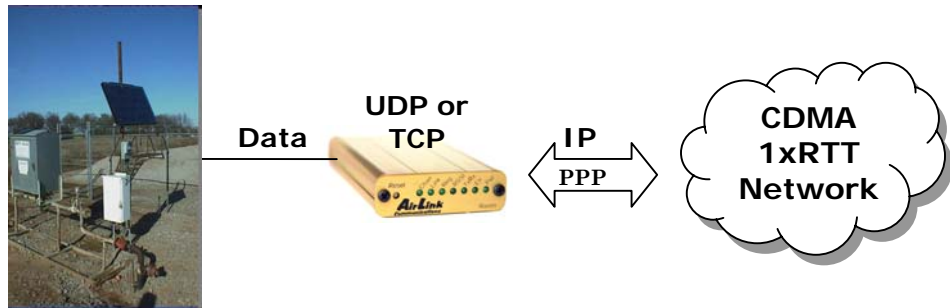

3 Modem Configuration

Modem configuration of the AirLink CDMA modems can be performed using the Wireless Ace application, or a terminal emulation program like HyperTerminal in Windows, or using a telnet application.

3.1 Local Configuration

1. Attach the antennas, DB-9 cable and power to the back of the modem.
2. Power on the modem, and ensure the **On** light is lit.
3. Attach the modem to the back of the PC with the provided DB-9 cable.

(Note, if you did not order a cable with your modem, you need a straight-thru RS-232 cable to attach to the modem.)

4. Select **Start**→ **Programs**→ **Accessories**→ **Communications**→ **HyperTerminal**.

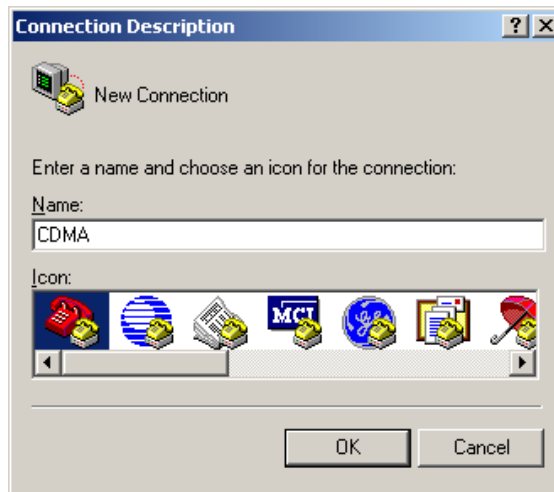

5. Enter the name of the connection and select **OK**.

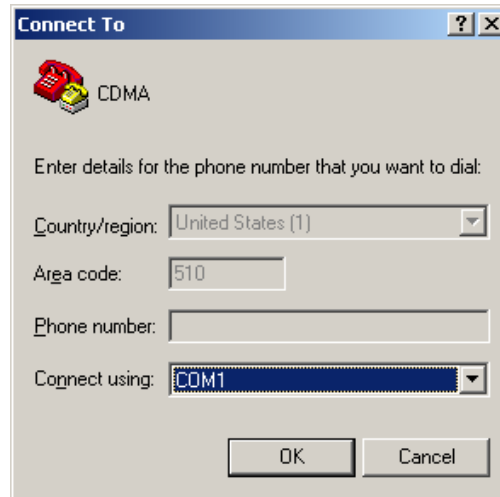

6. For "Connect using" select the COM port that the modem is on (do *not* select a modem driver), then select **OK**.

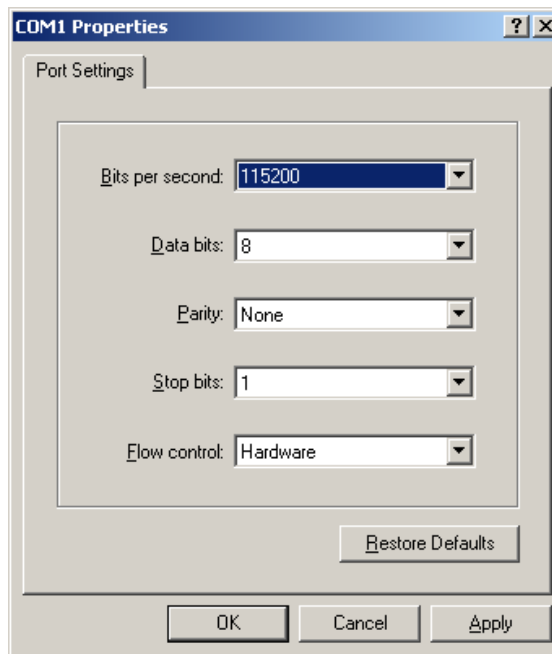

7. Select **115200** for the "Bits per second." Ensure Data Bits: **8**, Parity: **None**, Stop bits: **1** and Flow control: **Hardware**. Then select **OK**.

(These are the factory default settings for a Raven CDMA modem. If you get garbled characters when typing AT commands, change these settings and reconnect to the modem. For example, change the baud rate to 57,600 bits per second and connect again, etc.)

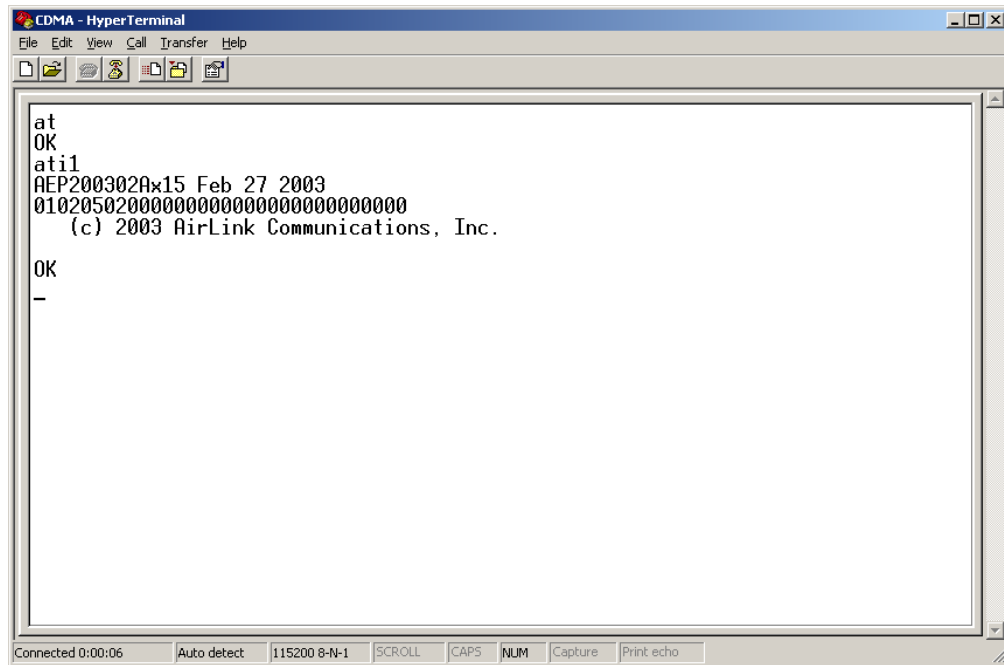

8. Type **AT** followed by **[Enter]**. You should receive an "OK" in response.
9. Type **ATI1** followed by **[Enter]**. This displays the modem firmware version and you should also see "AirLink Communications, Inc." in it which ensures you are talking to the Raven CDMA modem. (If not, try changing COM ports.)

Other AT commands may now be issued to the modem. See Section 5 for a list of AT commands

3.2 Modem Activation

The Raven CDMA modem is usually already set up to register online with a phone number, etc. pre-configured into it (by AirLink Communications, Inc.). When a modem is registered on the network and working, the lights will look like the following:



Note that the **RSSI** light may be flashing or solid, showing the strength of the signal. Also the **Tx** (transmit) and **Rx** (receive) lights will flash as data is transferred to and from the modem on the network.

If your modem lights look like the above when the modem is powered on, you do **NOT** need to configure the phone number, etc. into the phone and may *skip* this section.

If however the **Reg** light is not lit, your modem may need to be configured with a phone number and other parameters. Or if you have service ordered and a phone number for your modem, you may add these parameters yourself for some carrier accounts by doing the following:

- Connect up to configure the modem as in Section 3.1.
- If you are unfamiliar with using AT commands, please review Section 5 first.
- Use the following command to go into PassThru mode: **AT\APASSTHRU** (see section PassThru Mode). Note that this command may take up to 20 seconds to initially complete.
- Enter the Lock code from your provider using **AT~NAMLCK** (as described below).
- Enter the phone number, System ID and Network ID with the **AT~NAMVAL** command (described below). The parameters are *saved automatically* once entered.
- The modem must be physically power-cycled to exit this mode. (This is also the *only* way to exit PassThru mode.) Press the Reset button on the front of the modem.
- It may be necessary to enter the username and password provided by your service provider in the ***NETUID** and ***NETPW** fields. (See Section **Error! Reference source not found.**) Use **AT&W** to save these settings.
(PassThru mode is not needed for those two parameters.)

The modem should now come online registered.

Note that the activation process is unique for each type of service provided by each carrier. The specific activation process required for your service and carrier is provided in a separate document available on www.airlink.com.

3.2.1.1 Syntax for ~NAMLCK and ~NAMVAL

~NAMLCK	<p>NAMLCK = “NAM Lock”- The NAM is the “Number Assignment Module”. The NAMLCK command unlocks the ability to set the NAM parameters (to provision a an account).</p> <p>The NAMLCK is the modem’s 6-digit OTSL (One Time Subsidy Lock), MSL (Master Subsidy Lock), or SPC (Service Provisioning Code). The carrier provides this number to you at time of service activation. If the number is accepted by the modem, the OK result code is returned. If the number is rejected, the ERROR result is returned. If three successive Errors are returned, the modem must be reset to allow any further attempts.</p> <p>Note: The modem permits 99 failures of this command during its lifetime. After that, the modem becomes permanently disabled.</p> <p>AT Command Format: AT~NAMLCK=nnnnnn {Input} (nnnnnn = Lock Code from carrier) OK {Response}</p>
----------------	---

~NAMVAL	<p>NAMVAL = “NAM Value” The NAMVAL command has (3) functions:</p> <p>Setting the Active Account index The modem supports two accounts. One is always the ‘active’ account. Using the <nam> parameter followed by a 0 or 1 will set the active account to be used.</p> <p>AT~NAMVAL=0 - Sets NAM 0 as the active account OK {Response}</p> <p>Reading the current account information The query form of the command will report the details of the active account:</p> <p>AT~NAMVAL?0 - Queries the active account NAM0 NAM: 0 NUM: 8135551212 (10 digit phone number) SID: 0 (System ID) NID: 65535 (Network ID) OK {Response}</p> <p>Write account activation data Following successful unlocking by ~NAMLCK, this command can be used with all parameters to write the account data to the modem. If ~NAMLCK has not been successfully executed, the modem returns ERROR. The carrier will tell you what numbers to enter for NUM, SID, and NID. Following writing the values, the modem must be reset.</p> <p>AT~NAMVAL=<nam>,<num>,<sid>,<nid> AT~NAMVAL=0,5105551212,0,65535 OK (Response)</p>
----------------	--

3.3 Remote Configuration with Telnet

Once the Raven CDMA modem is online and registered, it can be contacted from a remote location by a computer with an internet connection. Using a telnet application (e.g. HyperTerminal), a connection can be made to the modem and then AT commands can be issued to configure the modem, just as if a local connection were being made to the modem.

To connect to the modem remotely using HyperTerminal in Windows, do the following:

1. Select **Start**→ **Programs**→ **Accessories**→ **Communications**→ **HyperTerminal**.

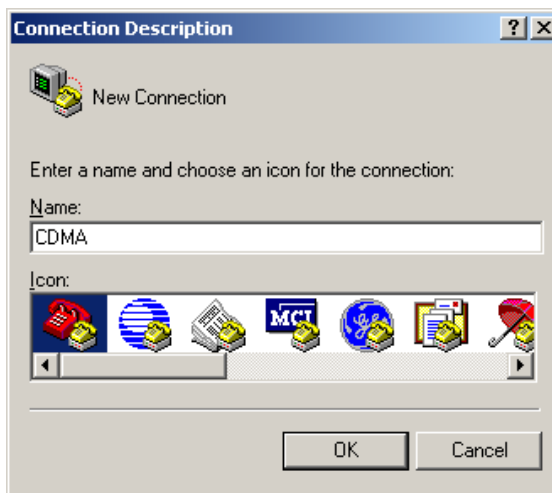

2. Enter the name of the connection and select **OK**.

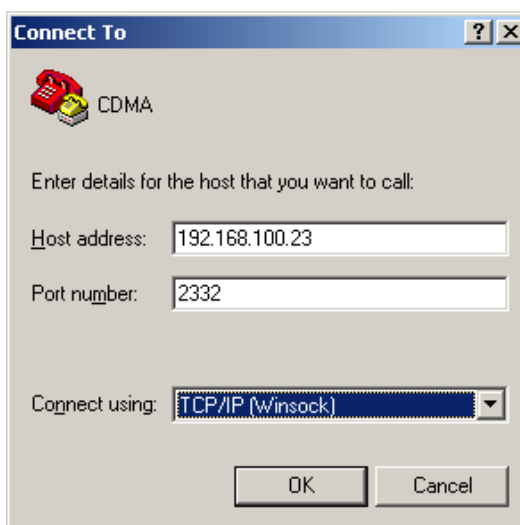

3. Select **TCP/IP (Winsock)** for "Connect using."
(Note: Early versions of Windows do *not* have this option in HyperTerminal. The Command Prompt application **telnet.exe** can be used or any other telnet application.)
4. For the "Host address" enter the IP address of the modem. (**AT*NETIP?** will reveal the current device IP address.)
5. For the "Port Number" use **2332**. This is the *default* telnet port number for the Raven CDMA modem.
6. Select **OK**.

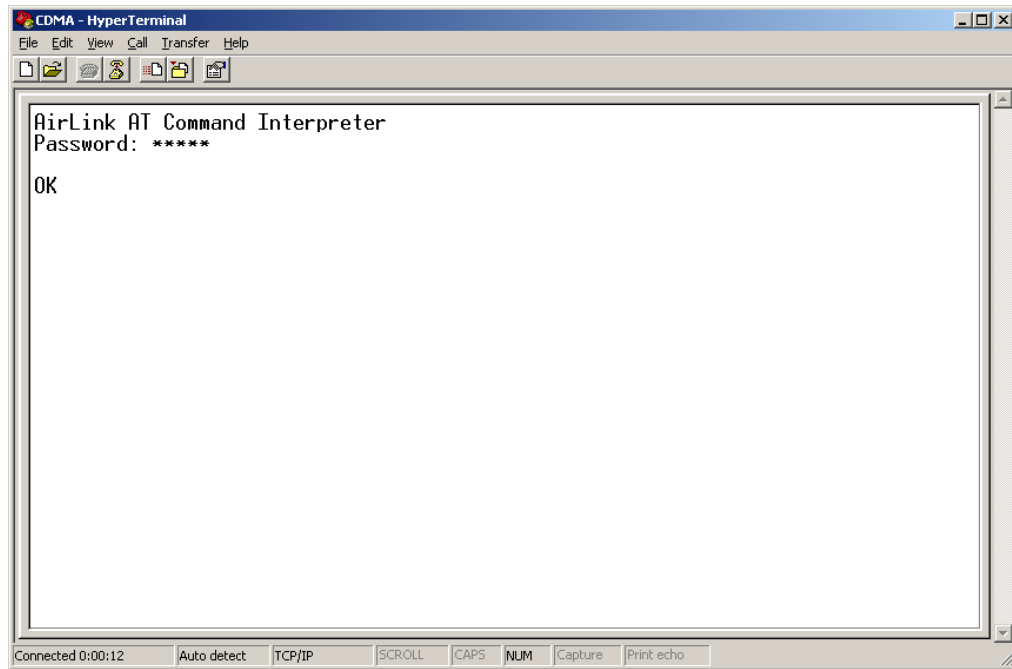

7. If the correct parameters have been entered, and the modem is currently online, you will get a "Password" prompt as shown above.
8. Enter **12345** (default password) and press **[Enter]**. You will receive an **OK**.

Now you may enter any AT commands to the modem as you would if you were doing a local connection to the modem. See Section 5 for AT commands and their options.

You may want to set local echo in your terminal emulator to see what you type as you type. There is no remote echo function in the modem.

4 Windows Dial-Up Networking Setup

This section describes the setup of Windows to enable communications over the CDMA 1xRTT network. Windows 2000 is used as the example because it the one Windows OS revision that carries the most similarity to both Windows 98 as well as Windows XP.

4.1 Add Windows Modem Driver

4.1.1 Setup Modem

- Connect the modem to the computer with the DB-9 cable.
- Plug in the AC adapter, connect the antenna(s) and power on the modem.
- Obtain administrator privileges on your system.
If you do not know how, check with your system administrator.

4.1.2 Add Modem Driver

1. Select **Start**→ **Settings**→ **Control Panel**→ **Phone and Modems Options**.
2. You should see be in the Phone And Modem Options dialog box. Select the "Modems" tab.

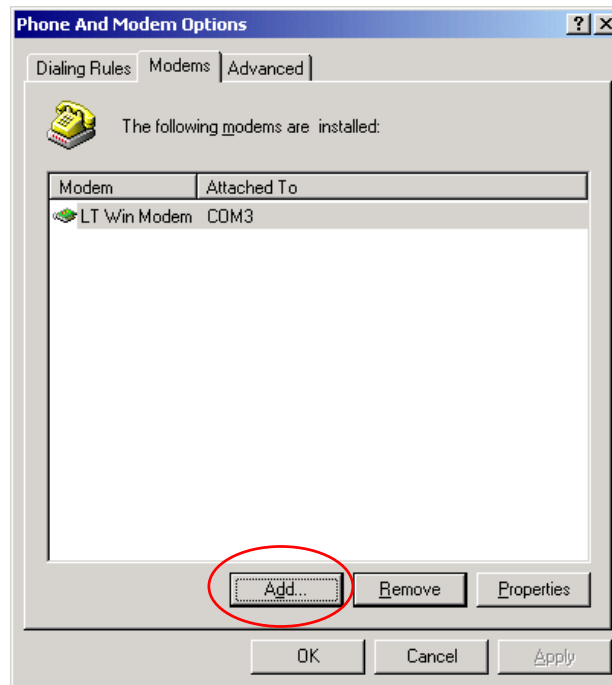

3. Select **Add**.

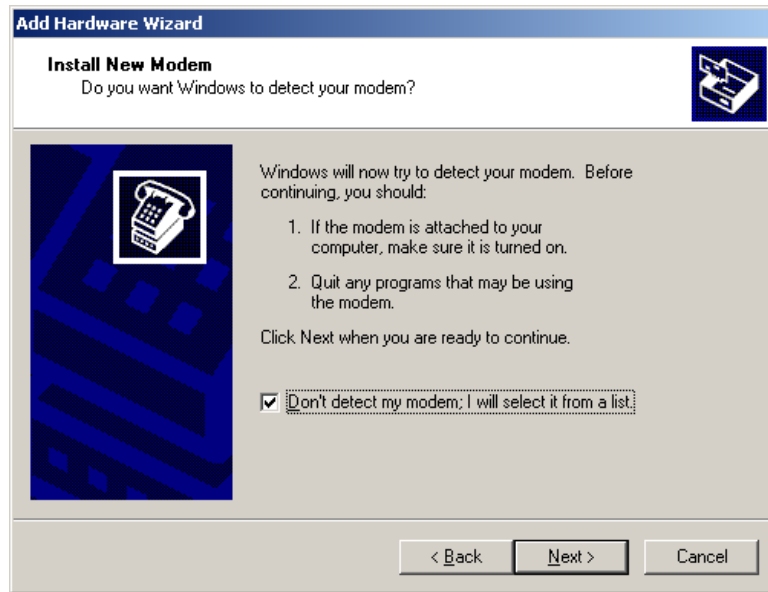

4. Check "Don't detect my modem..." and select **Next**.

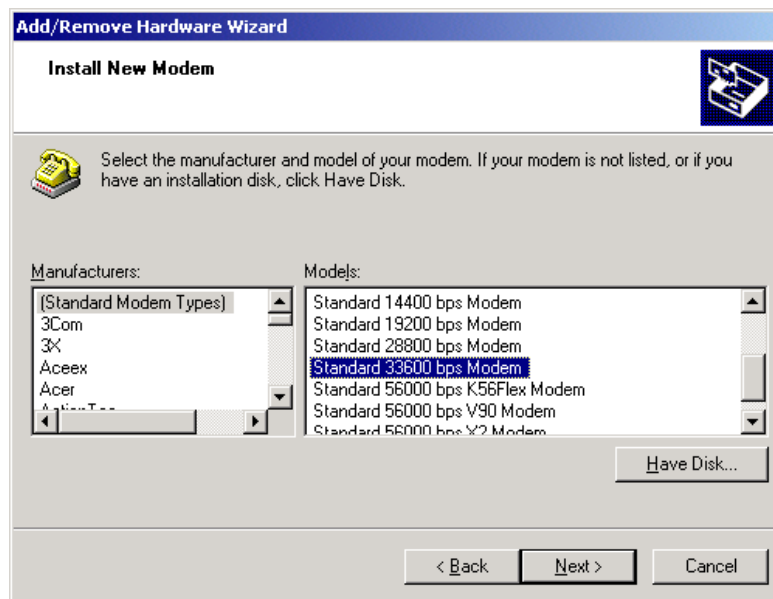

5. Select "(Standard Modem Types)" from the Manufacturers and then select "Standard 33600 bps Modem" under Models.
6. Select **Next**.

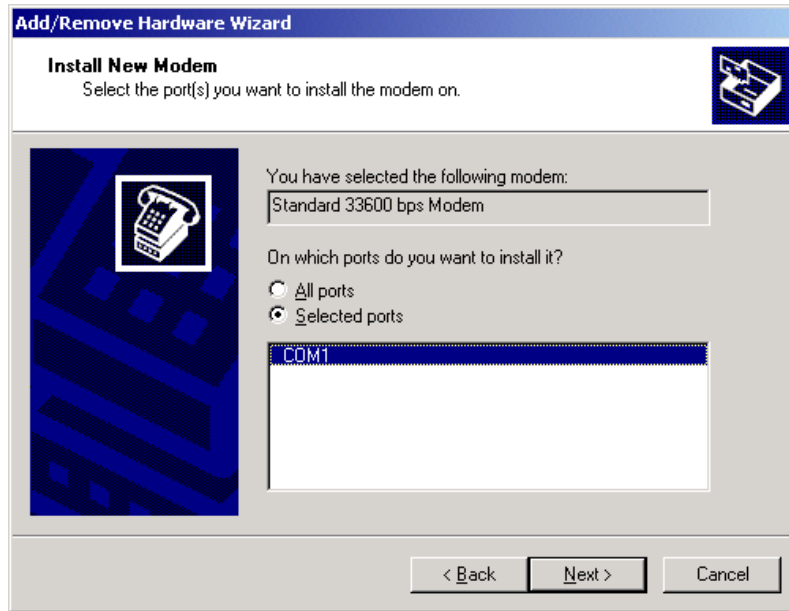

7. Check Selected Ports, then select the COM port the modem is connected to and select **Next**.
8. Select **Finish** to exit the "Install New Modem" wizard.

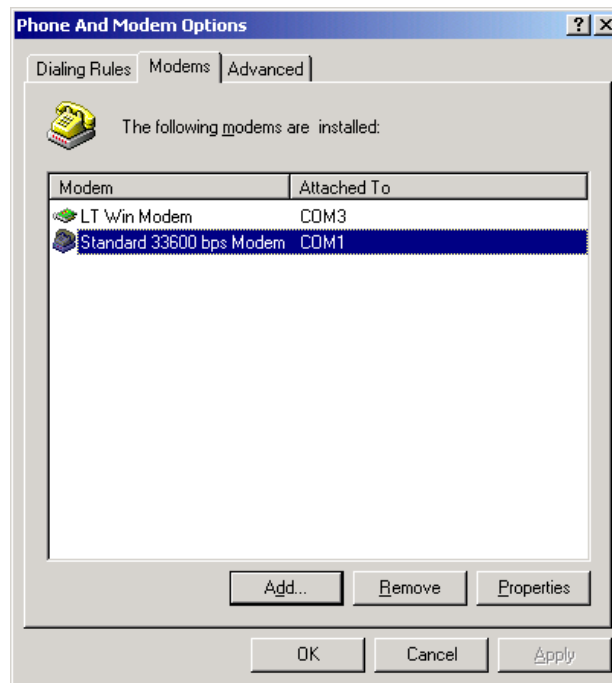

9. You should see the modem added to the correct COM port.
10. To set the modem speed on the driver, highlight the modem driver and select **Properties**.
11. Ensure the "Maximum Port Speed" is set to **115200**, which is the default value of the Raven CDMA.
12. Select **OK** to exit.

4.2 Windows Dial-Up Networking (PPP) Configuration

This section describes how to setup a Windows Dial-up Networking connection using an AirLink CDMA Modem. Windows 2000 Professional was used in this example. The connection uses PPP to communicate to the modem and gain access the Internet.

Before you start, you need the following:

Administrator privileges to the computer you are configuring or access granted by an administrator on the network to add/remove devices to your computer. (Not necessary on Windows 98/ME.)

A 1xRTT user account, password, and access number (obtained from your CDMA Service Provider).

Windows COM Port and modem set up for a Standard 33600 Modem (see Section 4.1).

No other program is to be running that is using the serial (COM) port that your modem is attached to.

NOTE: *If you have an existing LAN connection, then this dial-up connection to your CDMA modem may **interfere** with your existing connection. Once the connection is initiated it will take over as the "default route" for the majority of your LAN traffic, specifically Internet access. It's recommended to disconnect your LAN connection before using a PPP connection with your AirLink modem.*

*If however you want the two connections to co-exist, you can de-select "Use default gateway on remote network" (described later) and you can use the **route** command to setup routing through the modem properly. Go to a Command Prompt and type **route /?** to find out more, or talk to your administrator.*

Now that the modem has been added, the Dial-up connection must be created.

1. Select **Start**→ **Settings**→ **Control Panel**→ **Network and Dial-Up Connections**.

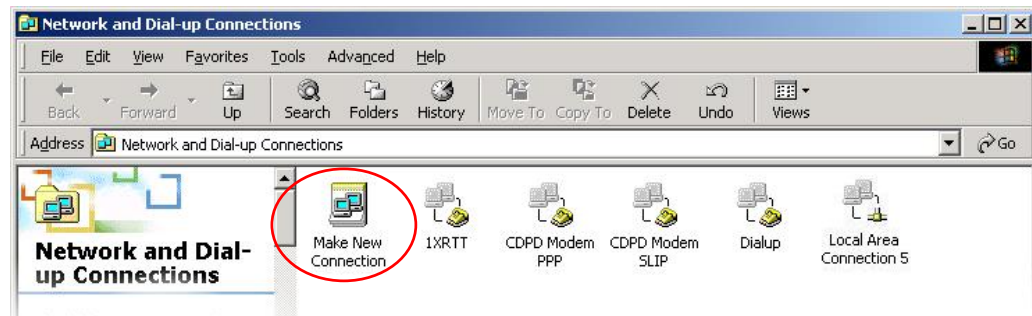

2. Double-click on the "Make New Connection" icon.



3. When the Connection Wizard starts, select **Next**.

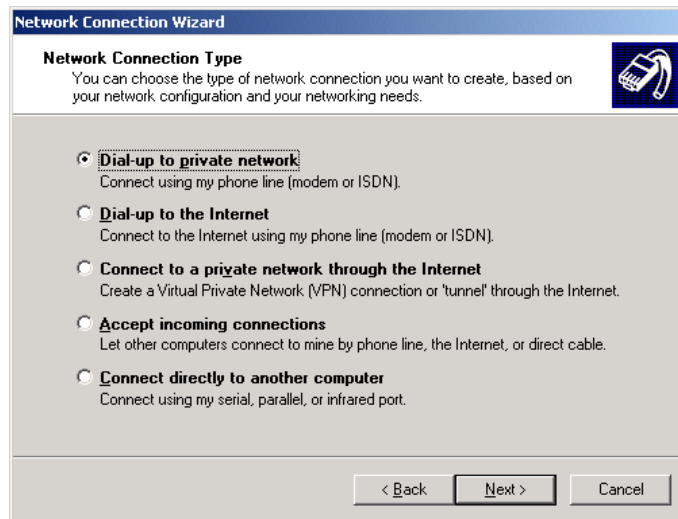

4. Select "Dial-up to private network" and select **Next**.

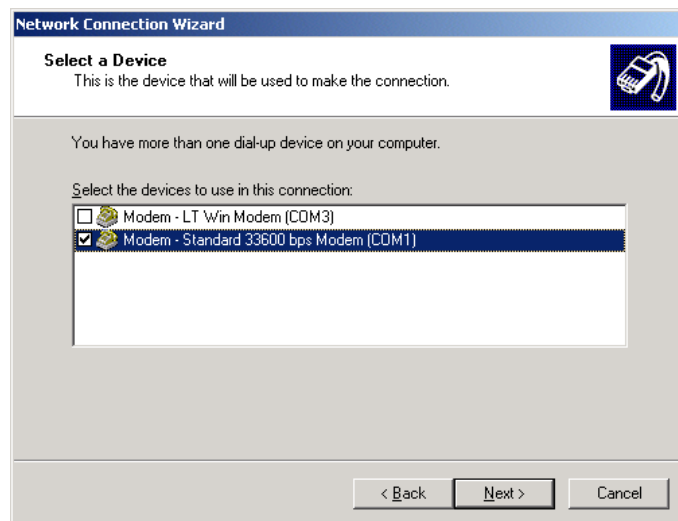

5. Check the box next to "Modem – Standard 33600bps" and select **Next**.

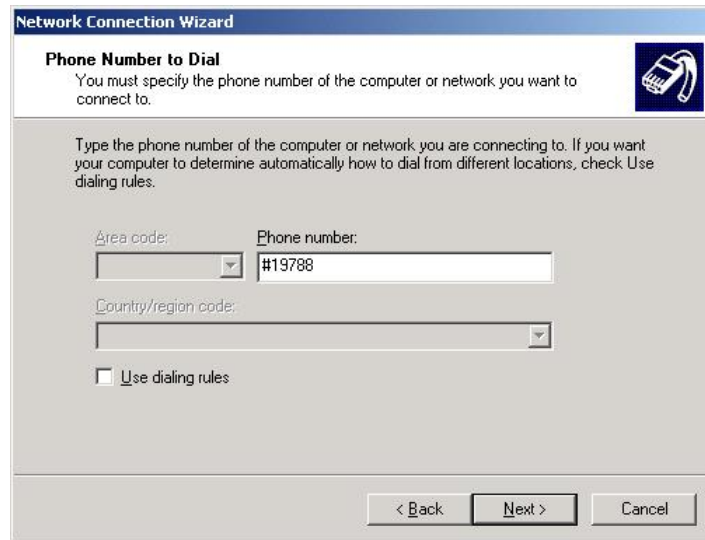

6. Enter the 1xRTT Access number: **#19788** and then select **Next**.
(Note: the Phone Number may vary, depending on your carrier.)
7. Select whether you want **all users** or just yourself to have access to this connection, and select **Next**.
8. Enter **1xRTT** for the name of the connection. If you want to add an icon for this connection on the desktop, check "**Add a shortcut to my desktop**."
9. Select **Finish** to exit the "Network Connection Wizard."

Note: Now some manual configuration changes need to be made to the connection before it can be used.

10. The "**Connect 1xRTT**" dialog box should come up next.
11. Select **Properties**.

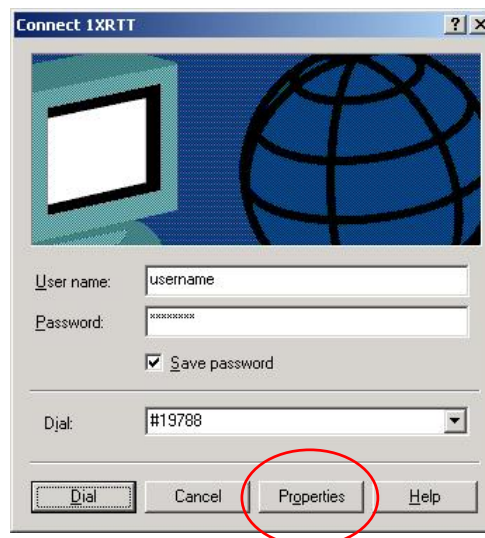

12. Examine the **General** tab settings.

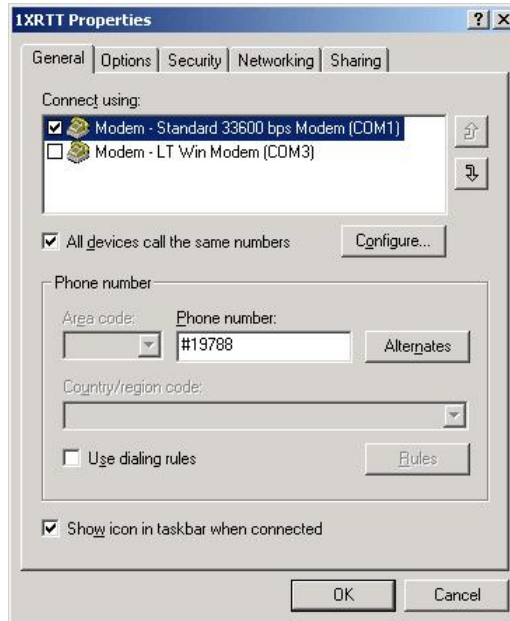

13. “**Connect using**” should have a check next to “**Modem – Standard 33600bps Modem (COMx)**.”
14. “**Phone number**” should equal the 1xRTT Access Number provided by the carrier.
15. Uncheck “**Use dialing rules**” and check “**Show icon in taskbar when connected.**”
16. Select the **Configure** button.

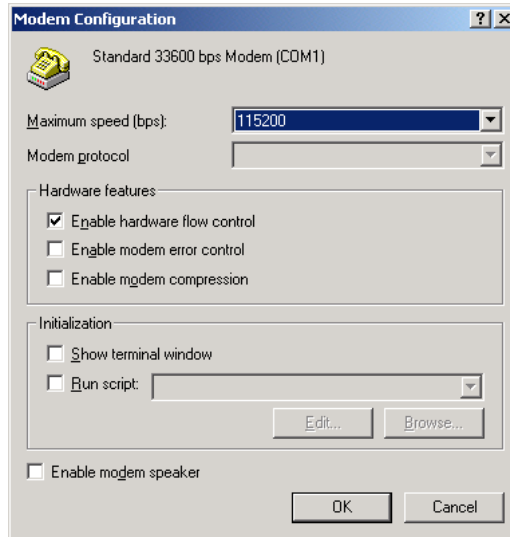

17. Maximum Speed: **115200**.
18. Check **Enable hardware flow control**.
19. Uncheck all other options.
20. Select **OK**.
21. Select the **Options** tab.

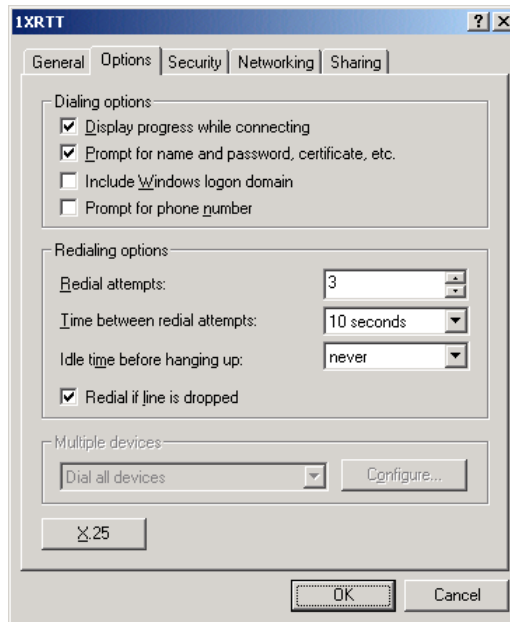

22. Check or Uncheck options as your application requires.

23. Set the "Redialing options" that will meet your needs.

Note: The options shown here should work for most applications. Consult your Network Administrator for more help on connection options.

24. Select the **Security** tab.

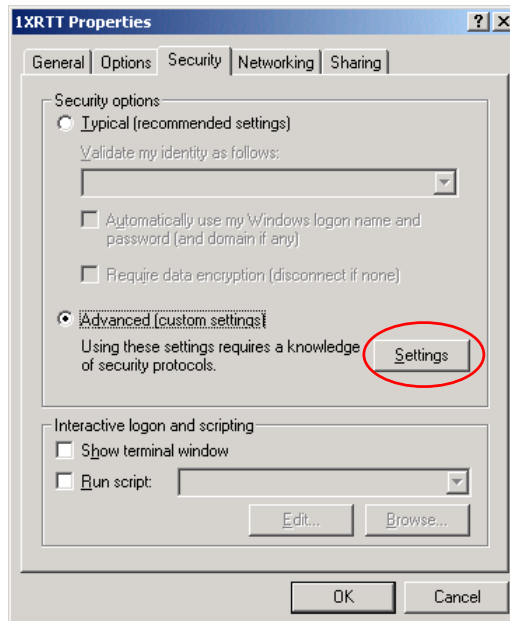

25. Select "Advanced (custom settings)."

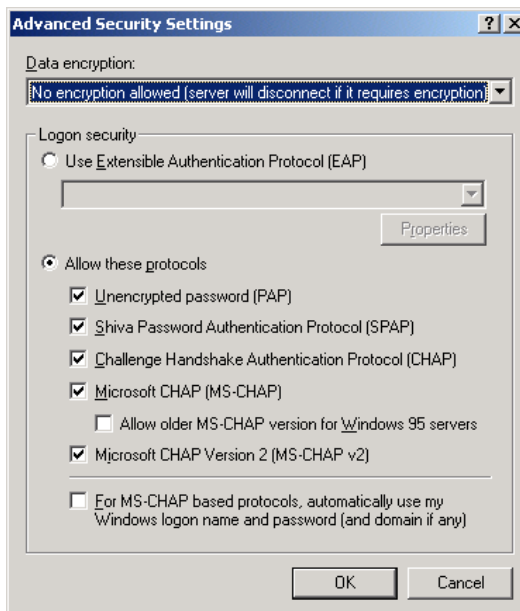

26. Set "Data encryption" to "No encryption (server will disconnect if it requires encryption)."
27. For "Logon security" check "Allow these protocols."
28. Check the following options:
 - Unencrypted password (PAP)
 - Shiva Password Authentication Protocol (SPAP)
 - Challenge Handshake Authentication Protocol (CHAP)
 - Microsoft CHAP (MS-CHAP) (*Do not check "Allow older MS-CHAP for W95 servers."*)
 - Microsoft CHAP Version 2 (MS-CHAP v2)
29. Select **OK**.
30. Select the **Networking** tab.

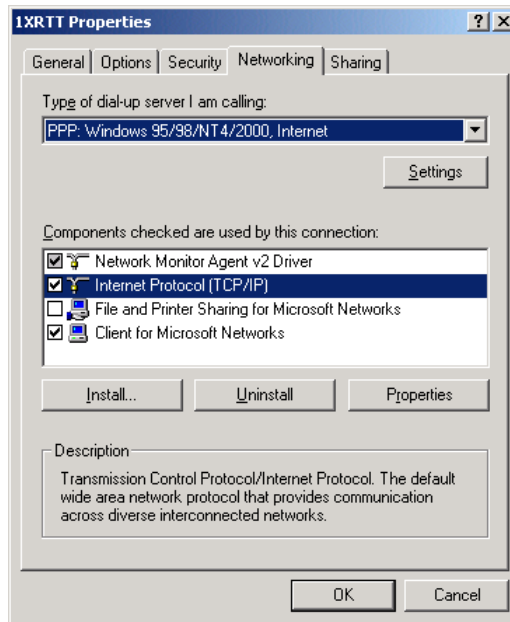

31. Type of dial-up server should show “**PPP: Windows 95/98/NT 4/2000, Internet.**”
32. Select the **Settings** button.

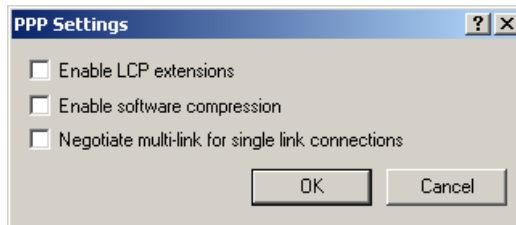

33. Uncheck all three of the PPP Settings options.
34. Select **OK**.
35. In the Components section of the Networking tab, **Internet Protocol (TCP/IP)** should be checked.
36. Select (highlight) **Internet Protocol (TCP/IP)** and then select **Properties**.

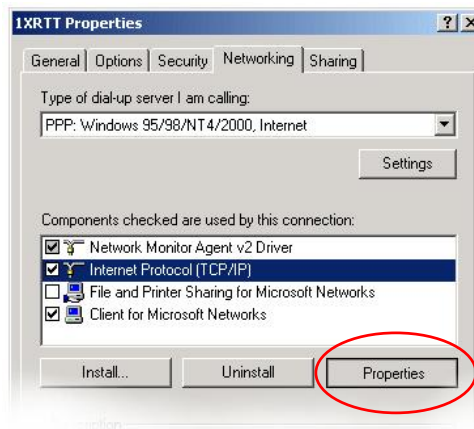

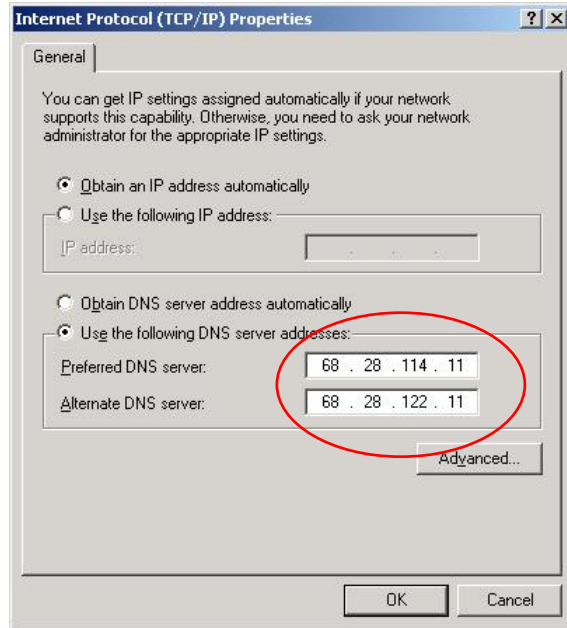
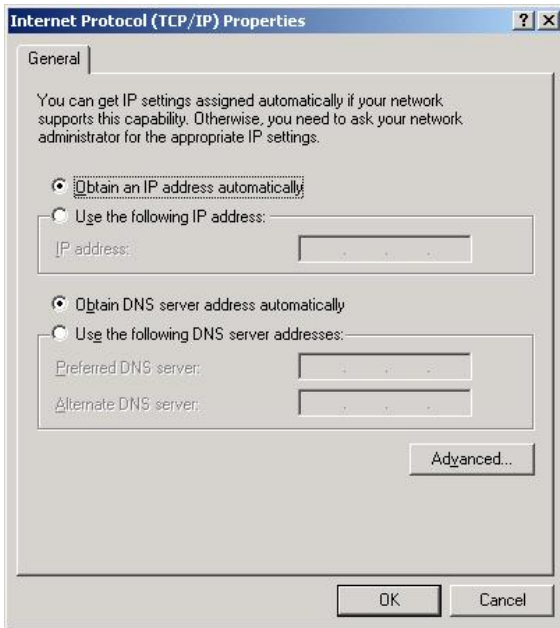

37. "Obtain an IP address automatically" should be checked.

38. Normally, DNS server addresses are provided during PPP negotiations. If it is necessary for you to enter DNS entries, check/enable "Use the following DNS server addresses" and put in the proper addresses. (See your carrier or Network Admin for details.)

39. Select the **Advanced** button.

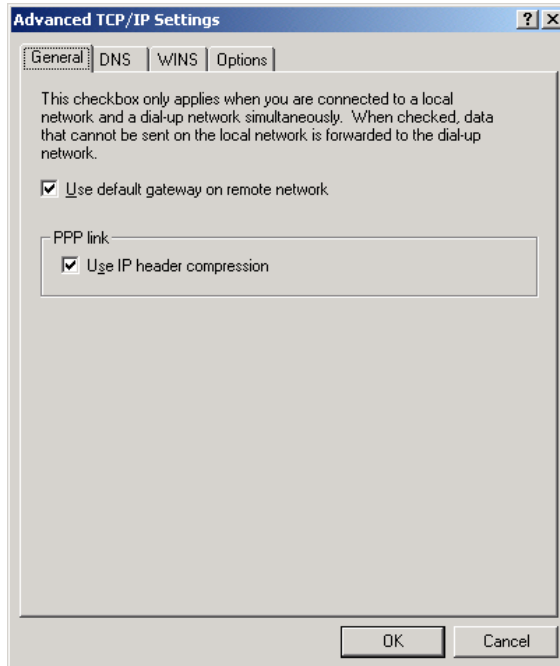

40. Check **Use default gateway on remote network** and **Use IP header compression**.

41. Select **OK**.
42. Leave the options under the **Sharing** tab unchecked.
43. Select **OK**.

4.3 Making a 1xRTT Data Connection

This section shows what to expect when dialing a 1xRTT data connection.

1. Go to Network and Dial-Up Connections and double-click on the 1xRTT icon.

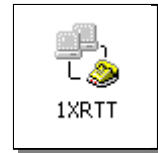

2. For non-Sprint service, enter the User name and Password provided by the carrier for the account.

Note: You can also enter these parameters beforehand using the ***NETUID** and ***NETPW** parameters. (See Section **Error! Reference source not found.**) If those parameters are already configured, leave the User name and Password fields blank.

3. Click on **Dial**.

If you have enabled the connection progress display, you will see the connection being made:





Once connected, you will see the connection status displayed in the System Tray on the Task Bar.

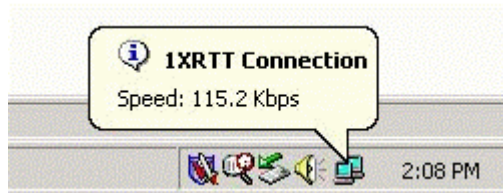

5 Dynamic IP Addresses

Many modern wireless data technologies use dynamic IP addresses rather than static IP addresses. This poses a problem for AirLink customers since they cannot contact their modems unless their addresses are known. AirLink offers a family of solutions designed for the different situations existing with our customers. One of the solutions, an IPManager System that implements a wireless Dynamic Domain Name Server, DDNS.

IPManager is a system which tracks the current IP address which a modem has been assigned. The DDNS system consists of three main components. One component is a task in the modem firmware which issues an update notification to the IPManager server when the modem is assigned a new IP address. The second component is the IPManager server which receives IP change notifications from all modems and updates a DNS server, the third component. It may, optionally, log the latest known IP address in a database, which may be accessed to see a history of the IP updates.

Customers may then use the wireless Dynamic DNS server to obtain the current IP of an AirLink modem. The following diagram shows the IPManager system elements.

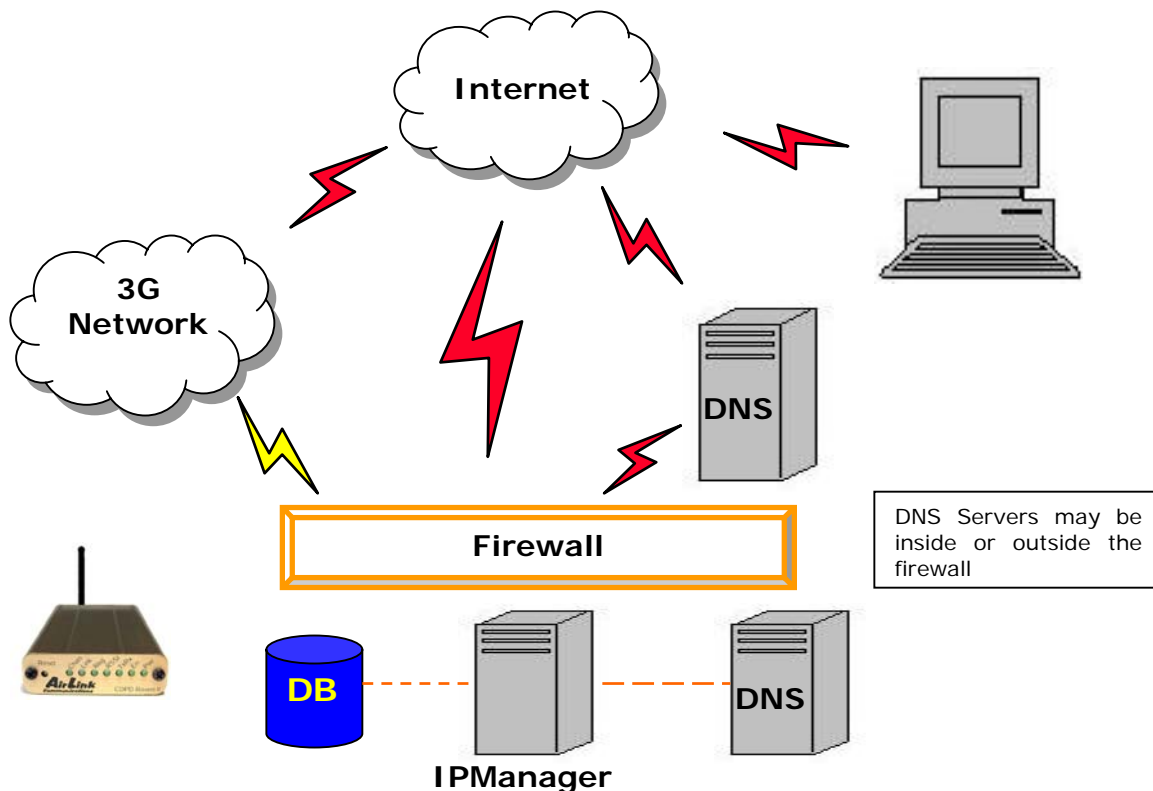

5.1 IPManager and Dynamic DNS Updates

The IPManager system provides a mechanism to implement a wireless Dynamic DNS service. If the IPManager settings are configured, the modem will send IP change notification messages to AirLink IPManager servers. These servers will then acknowledge the notifications and dynamically update a DNS server, thus allowing users to access a modem by domain name. The ***IPMANAGER1** and ***IPMANAGER2** settings can be set to either the domain name or IP address of a server to notify. The ***MODEMNAME** setting should be set to the name to prefix to the domain zone for which the IP Manager server is responsible. For example, if ***MODEMNAME=mymodem** and ***IPMANAGER1** points to a server responsible for the **airlink.com** domain zone, then the modem's fully qualified domain name will be: **mymodem.airlink.com**.

To configure your AirLink modem to be addressed by name, the modem needs to have 4 elements configured:

1. Modem name
2. Domain
3. IPManager IP Address
4. IPManager update interval

The following illustrates a way to configure an AirLink modem to be addressed by name:

at*modemname=mymodem

at*domain=airlink.com

at*ipmanager1=airlink.com

at*ipmgrupdate=60 [to update the DNS server at least hourly]

5.2 Using Names in the Modem, Domain Name Resolving

The AirLink modems have an integrated DNS resolver, which uses the DNS entries specified by the ***DNS1**, ***DNS2**, and ***DNSUSER** settings. This allows the use of names in the AirLink modems instead of IP addresses.

Both regular and reverse DNS lookups are supported. **ATNSLOOKUP** command will allow the lookup of an address or domain name. (e.g. **atnslookup=www.microsoft.com** will return the IP address for **www.microsoft.com**, while **atnslookup=64.163.70.10** should return **airlink.com**). If a name resolution is performed on a name which is not fully qualified (i.e. contains no dotted portions), the value from ***DOMAIN** will be concatenated to the end.

Typically the ***DNS1** and ***DNS2** values will be automatically filled in when a connection is negotiated with the carrier. The ***DNSUSER** value is provided to allow the user to specify a DNS server to check with before resorting to the carrier provided servers. If ***DNSUSER** is set to 0.0.0.0, it will be ignored and only the carrier DNS's will be consulted. If it is set, the name server at the provided address will be queried first. If it doesn't respond (within the timeout period, 10s) or can't find the requested entry, the carrier DNS's will then be queried.

The special domain name "**ppp-peer**" will always resolve to the address to use to communicate with the PPP (or SLIP) host peer connected to the host port. If there is no PPP (or SLIP) peer (i.e. modem is not in PPP or SLIP mode), then "**ppp-peer**" will resolve to 0.0.0.0. If, for example, you wanted to report IP address changes to the

host connected via the serial link, you could set **AT*IPMANAGER2=ppp-peer** to cause updates to be sent to the serial host.

6 Serial Communication Modes

In this section the following terminology is used:

Host:	This is the computer or terminal that is attached to the serial port of the Raven. Also known as the DTE.
Modem:	The Raven. The DCE to the host.
OEM Modem:	The embedded communications transceiver module.
Server:	A computer to which a Raven is communicating wirelessly.

An AirLink modem can be in one of six serial communication modes with the attached Host:

AT:	The modem accepts and responds to standard, Hayes-style AT commands. This is the default.
PPP:	Modem is using PPP to communicate with the Host.
PassThru:	Direct connection to internal OEM Module.
UDP PAD:	Any data received on the serial port is assembled into UDP packets and send to the session's associated IP and Port (described later). Any responses received from the associated IP and port destined for the modem's Device Port are unwrapped and sent out the serial port.
TCP PAD:	Any data received on the serial port is packaged into TCP messages and sent to the associated connection's IP and Port (described later). Any data received from the TCP peer is unwrapped and sent out the serial port.
SLIP:	Modem is using SLIP to communicate with the Host.

The default mode is AT command. If the modem is in any of the other modes, the AT command mode can be re-entered by:

- Deactivating DTR (if **&D2** or **Ignore DTR, S211**, is not set)
- Issuing the **+++** escape sequence (if **Disable AT Escape, DAE**, is not set)
- Resetting or Power cycling the modem.

The **PassThru** mode can only be exited by resetting the modem

The modem can be programmed to enter one of the other modes automatically on power up. This is done setting the **Startup Mode Default (MD)** to the desired mode. If this setting is non-zero, the modem will enter the specified mode after 5 seconds. If you want to cancel this behavior, the **ATMD0** command can be used before the 5-second timeout expires.

The modes are described in more detail in the following sections.

6.1 AT Mode

AT commands are used to configure the modem, command it to do something, or query a setting.

AT commands must always be terminated by **<CR>** (ASCII character 0x0D).

If **E=1** (Echo On), the AT command (including the terminating **<CR>**) will be output before any responses defined in the next section.

Response Framing

Two settings affect the format of AT command output: **V (Verbose)** and **Q (Quiet)**.

If **Q=1** (Quiet On), no result codes are output whatsoever, so there is no response generated by a (non query) command. If **Q=0** (Quiet Off), result codes are output. The format of this output is then affected by the **Verbose** setting.

If Quiet mode is off, the result code is affected as follows: For **V=1** (Verbose mode), the textual result code is surrounded by **<CR><LF>** and any AT query response is also surrounded by **<CR><LF>**; for **V=0**, (Terse mode), a numeric result code is output with a single trailing **<CR>** (no **<LF>** is output), while any AT query response is followed by **<CR><LF>** (there is no preceding output).

For example, possible output to the AT command "**AT<CR>**" (assuming quiet mode is not on) is:

0**<CR>** - if V=0

<CR><LF>OK<CR><LF> - if V=1

6.2 PPP Mode

In PPP mode, the modem acts as a PPP server, providing an IP address, and DNS servers (if available) to the Host.

PPP mode is entered from the AT mode by using any of the following commands:

- **AT\APPP<CR>**
- **ATDT10.0.0.1<CR>**
- **ATDT10001<CR>**
- **ATD#19788<CR>**
- **CLIENT<CR>**

In response to any of the preceding commands, the modem will respond with

CONNECT<CR><lf>

and is ready for the host to begin PPP negotiations.

The IP received by the host in the resulting negotiation will either be a private (non-routable) IP or a public (network-routable) IP provided by the network, depending on the settings of ***USEPRIVATEIP [S300]**. If ***USEPRIVATEIP =1**, the value of the private IP can be determined beforehand by querying **S110**. The private IP to be used can be defined with the command **AT*PRIVATEIP=192.168.100.33** substituting the desired IP address.

Using a private IP insulates the PPP client from changes in IP addresses of the underlying network, as the AirLink modem will perform basic NAT-like address translation on all packets.

If a public IP address is being used, any changes in the IP (as determined by the wireless network) will result in the PPP link to the host being disconnected, requiring the host to reinitiate it. The public IP is passed to the host in the PPP negotiations, so when the network forces a change, the modem has to force the host to renegotiate the PPP link to make this happen.

The host can exit PPP mode by deactivating DTR (if **S211=0** or **&D2**) or issuing the **+++** escape sequence.

Note that DTR needs to be asserted (or **S211=1** or **&D0**) by the host before PPP mode can be entered.

6.3 PassThru Mode

In PassThru mode, all serial traffic is sent directly between the internal OEM Module and the host. In this mode, the modem does not behave normally. This mode can be used to configure OEM Module-specific settings (e.g., for provisioning, etc.)

Issuing the **"AT\APASSTHRU"** enters this mode. The modem responds with **CONNECT**, at which point a direct connection to the OEM Module is established.

Note that some OEM Modules requires upwards of 20 seconds before AT commands can be entered, so be patient if there seems to be no response to AT commands.

This mode can only be exited by resetting or power-cycling the modem. This mode cannot be entered via a telnet session.

6.4 UDP PAD Mode

When the modem is in UDP PAD (Packet Assembly and Disassembly) Mode, all characters received on the serial port are assembled into UDP packets and sent to the mode's remote IP address/port, and any packets received from the same IP/port--destined for the modem's Device Port (see ***DPORT**)--are disassembled and dumped onto the serial line. Note that DTR needs to be asserted (or **S211=1** or **&D0**) by the host before a UDP session can be entered.

A UDP session is initiated by one of the following events:

- Using the Dial UDP (**DP**) AT command (as in **ATDP192.168.3.23/3456**)
- Setting the Startup Mode Default (**MD**) to **3** (UDP) so that a UDP session is entered automatically when the modem powers up. Serial data will be sent to the **IP/port** specified in **S53**.
- An incoming UDP packet is received and
 - UDP auto answer is enabled (**S82=2**)
 - The destination IP address matches that in **S53**
 - Or **allow any IP** is set (**AIP=1**)
 - The modem is in AT mode [not in a current UDP or TCP session]

UDP packet assembly is affected by the values of **S50** (PAD Forwarding Timeout) and **S51** (PAD Forwarding Character). Data received in the serial buffer will be transmitted when the idle inter-character timeout specified in **S50** (in tenths of seconds) occurs or when a character is received that matches **S51** (if non-zero).

The host can exit UDP mode by deactivating DTR (if **S211=0** or **&D2**) or by issuing the **+++** escape sequence.

6.4.1 UDP Auto Answer

UDP auto answer (previously called UDP half-open) is set with **S82=2**. When set, the modem will automatically establish a UDP session to the source IP address and port of the UDP packet received. The modem will remain “locked” to this one remote IP/port until no data is sent or received for the time interval defined in the UDP auto answer timeout (**S83**). During this session, packets from other IP/port addresses will be rejected, unless ***UALL** is set. Whether or not an incoming packet will cause the modem to enter a UDP session is always dependent on the **S53** and **AIP** settings.

When idle, after the timeout has occurred, the modem is in AT command mode on the serial port, and any valid AT command may be entered during this time.

The **Normal UDP Mode (MD3)** can be combined with **UDP auto answer** to cause the incoming serial data to be sent in UDP packets (instead of being treated as AT commands), while allowing sessions to be established from different UDP sources. A UDP session will be initiated either by incoming serial data or by an incoming UDP packet. The session, started by either method, will be terminated when no data has been sent or received for the **S82** period. Once the session terminates, another may be initiated by either means.

When the session is initiated by serial data, the new session will be established using the destination address specified in **S53**. The **S53** setting can be changed if the **connect to last UDP** setting (***UDPLAST=1**) is set. The address in **S53** will be updated to reflect the address of the last session initiated by an incoming UDP packet. So that when new data is received over the host serial port while in the idle state, a session will be re-established with the last address. (This behavior is the same as the previous Hybrid2 (**MD6**) mode).

Note that **TCP auto answer (S0=[1|2])** may also be set simultaneously with **UDP auto answer**. Then, when in the idle state, the modem will accept either a **TCP** or **UDP** incoming packet, and enter a **TCP** or **UDP** session as appropriate.

6.4.2 Reliable UDP

Reliable UDP adds a simple protocol on top of UDP to provide reliable deliver of data. When data is received from the host serial port, a 2 byte header is added to the data, containing a message type and a sequence number. The modem will continue to send this data (buffering any received data in the meantime) until it receives an acknowledgement with this sequence number. If an acknowledgement is not received within the timeout period (specified in **S7**), the data will be retransmitted. This will continue until an acknowledgement is received or the modem is reset. Likewise any UDP packets received by the modem are expected to have this simple header. The modem will issue an acknowledgement for any valid packets which are received.

Configure the modem as for a normal UDP session. Set the **Startup Mode Default** to **3**, and the **UDP Mode Default** to **7 [ATMD73]**. If using two modems, configure the Destination IP and Port in each to point to each other. Serial data will then be sent reliably between the two

Although it adds reliability, the simple implementation of the Reliable UDP mode in the modem does not check for duplicate packets.

6.4.3 Multicast UDP [Raven Only Feature]

Multicast UDP results in any data received from the host serial port being sent to all the clients in the Modbus list. The remote port number is taken from **S53**. To avoid flooding the network, the packets are sent to each client with a 20ms pause in between. The receipt of UDP packets works as in normal UDP mode (i.e. bound by the value **S53** and/or **AIP**). Since it may take a while to transmit the data to all hosts (especially if all 20 Modbus entries are used and name resolutions are required), new data received from the host port is buffered until current transmissions to all hosts are finished.

Enter the list of target IPs in the Modbus IP list. The index numbers in the IP list aren't used. Configure the Raven as for a normal UDP session. Set the **Startup Mode Default** to **3**, and the **UDP Mode Default** to **8 [ATMD83]**. Configure the Destination port to match the device port of the remote modems.

6.5 TCP PAD Mode

When the modem is in a TCP session, all characters received on the serial port are assembled into TCP packets and sent to the mode's remote IP address/port, and any packets received from the remote end of the TCP connection are disassembled and dumped onto the serial line. Note that DTR needs to be asserted (or **S211=1** or **&D0**) by the host before a TCP session can be entered.

A TCP connection is established by one of the following methods:

- Using the **Dial TCP (DT)** AT command (as in, **ATDT192.168.3.23/3456**)
- TCP auto answer is enabled (**S0=1 | 2**), a TCP connection request is received, and the modem is not in a data session.
- Data is received on the serial port and
 - The Startup Mode Default (**MD**) is **4 (auto TCP)**
 - The remote TCP destination, as defined in **S53**, successfully responds to the TCP connection request.

The value of **S7** (TCP Connection Timeout) specifies the number of seconds to wait, after initiating a TCP connection attempt, for a successful connection to be established. If the connection has not been successfully established before the timeout occurs, **ERROR/BUSY** is returned.

TCP packet assembly is affected by the values of **S50** (PAD Forwarding Timeout) and **S51** (PAD Forwarding Character). Data received in the serial buffer will be transmitted when the idle inter-character timeout specified in **S50** (in tenths of seconds) occurs or when a character is received that matches **S51** (if non-zero).

The TCP session will be terminated if no data is transmitted or received for the time interval specified in **TCPT** and **TCPS**. **TCPT** is the number of minutes [**TCPS=0**] or seconds [**TCPS=1**] used for this idle timeout.

TCPT should never be 0 when using the TCP mode. A broken TCP session can result in the modem being left with a TCP half-open connection that can only be terminated with a reset.

The host can also terminate a TCP session by deactivating **DTR** (if **S211=0** or **&D2**) or issuing the **+++** escape sequence.

Note that **DTR** needs to be asserted (or **S211=1** or **&D0**) by the host before a TCP session can be started.

6.6 TCP Auto Answer

TCP auto answer (**S0=1|2**) also allows a TCP connection request to be “answered” when the modem is idle, not in a data session. Note that **DTR** needs to be asserted (or **S211=1** or **&D0**) by the host before a TCP session can be entered. The TCP connection request’s destination port has to match the modem’s device port.

Note that **UDP auto answer** may also be set simultaneously with **TCP auto answer**. Then, when in the idle state, the modem will accept either a **TCP** connection request or **UDP** incoming packet, and enter a **TCP** or **UDP** session as appropriate.

6.7 Hybrid Modes

Some previous hybrid modes (MD=5, 6) are no longer implemented as special, unique modes. Now that UDP auto answer (UDP Half-open, S82=2) can be enabled in conjunction with UDP PAD mode (MD3), effectively this is the same as MD5 and MD6 previously accomplished. Setting MD5 and MD6 are still supported, but not recommended, since all they do is set several settings as described below.

The settings to accomplish hybrid modes:

AT Setting	Hybrid (MD5)	Hybrid2 (MD6)
MD	3	3
S82	2	2
S0	1	1
*UDPLAST	0	1

6.8 SLIP Mode

SLIP mode is entered by using the “**AT\ASLIP**” command. As in PPP Mode, the IP address that the host assumes is affected by the setting of **S300**. SLIP does not negotiate the IP with the host, so before making a SLIP connection, the host SLIP driver must be configured to use the IP specified by querying **S110**.

The host can exit SLIP mode by deactivating DTR (if **S211=0** or **&D2**) or issuing the +++ AT escape sequence.

Note that DTR needs to be asserted (or **S211=1** or **&D0**) by the host before SLIP mode can be entered.

6.9 Modbus/BSAP Configuration [Raven Only Feature]

Modbus, BSAP, and Modbus variations are communications protocols that are widely used in telemetry. They were designed to be used in a radio environment where packets are broadcast to a group of remote units. Each Modbus packet contains an ID so that only the one remote unit, whose ID matches the ID in the packet, will respond to the host. The ID is used to address a specific remote.

When Ravens are used in place of radios, there is a Raven connected to the host computer and a Raven connected to each remote unit. Packets transmitted from the host need to contain the IP address of the specific remote unit whose ID matches the ID in the packet from the host computer.

The Modbus/BSAP feature adds the capability for a list of IP addresses or names, and matching remote IDs to be entered into the host Raven. When the host computer sends a poll request, the ID is matched to the corresponding IP address and a UDP packet is assembled using this IP address. The complete packet from the host is then encapsulated in this UDP packet and transmitted to the remote unit. The remote units operate in normal UDP mode and their data is sent to the host.

6.10 Configuring the Polling Host Application Raven

Set the **S53** Port to match whatever port number is being used on all the remote modems. For example, if the remote Ravens' **S110** port number being used is "12345", then the Modbus host Raven's **S53** port should be set to "12345".

ATMD13 for Modbus ASCII
ATMD23 for Modbus RTU (Binary)
ATMD33 for BSAP
ATMD63 Variable Modbus [where you set up the individual parameters]

Enter the list of ID/Local addresses and their associated remote IP addresses or names as follows:

The ID/Local address and IP or name is entered using the **ATMLIST** or **ATMLISTX** commands. **ATMLIST** allows the ID to be entered in decimal, while **ATMLISTX** allows the ID to be entered in hex.

For example, if a remote's IP address is **123.456.133.45** or name is **remote1**, and its ID/Local address is **27**, you can enter:

ATMLIST27=123.456.133.45

If you want to enter the ID in hex:

ATMLISTX1B=123.456.133.45

Continue until all the remotes are entered. There can be a total of 20 remote ID/Local addresses entered into a Raven. Note a special build Raven Modbus Host version is available that allows up to 100 entries in the list.

Remember to save the entries with **AT&W**.

If Using Dynamic IPs

The host Raven should be configured to report its current IP to a DDNS server so the remote Ravens can use DDNS to obtain the host Raven's IP. The remote Ravens can then send their current IPs to the host Raven which will update the Modbus IP list by matching the modem names.

Enter names into the IP list as follows:

ATMLIST27=remote1

or **ATMLISTX1B=remote1**

Continue until all the remotes are entered. There can be a total of 20 remote ID/Local addresses entered into a Raven. Note a special build Raven Modbus Host version is available that allows up to 100 entries in the list.

Remember to save the entries with **AT&W**.

Configuring the Remote Ravens

The remote Ravens connected to the RTUs being polled, need to be set up for normal UDP operation.

ATMD3 for Normal UDP operation

For Static IPs

Set **ATS53= IP address/port number** of the Raven connected to the Polling Host. If the polling host Raven's IP and port are **123.456.133.11** and **12345**, set as follows:

ATS53=123.456.133.11/12345

ATS53=home1/12345

If Using Dynamic IPs

Set **ATS53= name/port number** of the host Raven. If the polling host Raven's ***MODEMNAME** and **Device Port** are **home1** and **12345**, set as follows:

ATS53=home1/12345

The remote Ravens need to be configured to update the host Raven with their current IPs. Set up ***IPMANAGER[1|2]** to point to the host Raven:

***IPMANAGER[1|2]=home1**

where **home1 = *MODEMNAME** in the host Raven.

***DOMAIN** should match the domain of the host Raven. For example, if the DDNS being used is **airlink.com**, then ***DOMAIN=airlink.com**. And the fully qualified domain name the remote Raven would query is **home1.airlink.com**.

A new IP update will be sent anytime the remote Raven detects that its IP has changed. A periodic update is a redundant process that guarantees the host Raven will be updated in the event the host Raven loses its IP list for any reason or the remote Raven's IP is changed or dropped without notification to the remote Raven. Configure the frequency the IP update will occur.

AT*IPMGRUPDATE[1|2]=n

where n = minutes [0-255]

Other parameters may need to be changed, but this is dependent on the RTU type being used.

Remember to save your configuration with **AT&W**.

7 PinPoint Notes

7.1 Low-power Mode

A PinPoint 9612 can be configured to enter a low power mode in order to conserve a vehicle's battery life. The PinPoint can power down when the voltage to the modem drops below a configured threshold (caused by the vehicle being turned off), or when DTR changes (usually a contact or voltage controlled by the key switch, signaling when the vehicle is turned off). For now see the PinPoint 9612 CDPD User Manual.

Important: the external DB9's RTS and DTR pins can be configured through ATS to be used as digital inputs. If one or both pins have been configured to be used as inputs, then low power mode cannot be keyed off of DTR.

7.1.1 Effect on Modem State

Once the transition from powered on to low-power mode starts, the modem will change state to AT mode. This results in the current mode (e.g. PPP, TCP, etc.) being gracefully terminated. For the brief period when the modem is preparing for low-power mode, the modem will remain in AT mode (i.e. won't auto-answer, ATD will fail, etc.). Once low-power mode is entered, the modem will then discard any data received on the host port.

When the modem is woken from low-power mode, the same behavior occurs as upon power on. The modem starts in AT mode, and then after 5 seconds will enter the default mode (MD).

7.2 Real-Time Clock Sync

Every hour, the modem will re-sync the internal RTC with the UTC time received from the GPS satellites;

7.3 Different Local and Remote Report types

A different report type can be specified for local reports (*PPLATSR) than that for remote reports (*PPGPSR). The type of commands (either RAP or TAIP) which the PinPoint accepts and the port it listens on depends on the value for *PPGPSR. For example if *PPGPSR is set to send RAP GPS reports w/date (AT*PPGPSR=12) and *PPLATSR is set to send TAIP reports (AT*PPLATSR=F0), the PinPoint will accept

RAP commands on port 17335 and not TAIP commands on port 21000. To accept TAIP commands, *PPGPSR would have to be set to F0.

7.4 RAP Poll Command

The RAP poll command can be issued by the local client (i.e. PPP/SLIP peer) to force a new local report to be transmitted in response. If a RAP poll command is not from the IP of the PPP/SLIP peer (i.e. IP in S110), the poll will be performed normally (i.e. the response will go to the server at *PPIP).

7.5 TAIP Emulation

The TAIP emulation functionality allows the PinPoint product to operate in a limited manner with clients which only understand the Trimble ASCII Interface Protocol (TAIP). TAIP emulation is enabled by setting the GPS report type to F0 (e.g. **AT*PPGPSR=F0** or **AT*PPLATSR=F0**). Once TAIP emulation is entered, the PinPoint will listen for TAIP messages on port 21000 and will no longer handle/generate RAP messages.

The automatic reports will be sent to the server configured with the ***PPIP** and ***PPPORT** AT commands. This behavior is different than standard TAIP since TAIP will instead simply report to the last client to request automatic reports.

The TAIP emulation will accept the following TAIP message types:

SRM – allows the client to set reporting mode configuration. The report mode configuration is not stored in non-volatile memory and such should be reset upon a unit reset. This behavior emulates that specified in TAIP spec.

QRM – reports the reporting mode configuration (returns an RRM message)

SID – allows the client to set the TAIP ID (**AT*PPTAIPID** can also be used to set the TAIP ID). The TAIP ID, when set with a SID message, will be written to non-volatile memory.

QID – reports the TAIP ID (returns an RID message).

DPV – configures automatic reporting of PV (Position/Velocity) reports based on distance traveled and a maximum time. The delta distance value specified in the message is converted to hundreds of meters and stored as ***PPDIST**. The maximum time interval is stored as ***PPTIME** and the minimum time is stored as ***PPMINTIME**. The epoch value is ignored.

FPV – configures periodic reporting of PV (Position/Velocity) reports. The time interval from the message is stored at ***PPTIME**. Currently the epoch value is ignored.

QPV – responds with a PV (Position/Velocity) report.

The TAIP emulation will generate the following reports corresponding to the appropriate event (either a query for it, echoed due to a set, or due to an automatic reporting event):

RRM – reports the reporting mode configuration.

RID – reports the TAIP ID.

RPV – Position/Velocity report.

7.6 NMEA Reports

PinPoints can be configured to output reports containing the NMEA sentences received from the GPS unit. NMEA reporting is configured by setting the reporting type (***PPGPSR** or ***PPLATSR**) to E0 or E1. Specifying the report type as E0 will output the GGA and VTG NMEA sentences, while E1 will output the GGA, RMC, and VTG NMEA sentences.

If ***PPGPSR** is set to E0 or E1, the NMEA reports will be sent instead of RAP reports to the server configured with the ***PPIP** and ***PPPORT** AT commands. If ***PPLATSR** is set to either E0 or E1, the NMEA reports will be sent to the PPP/SLIP peer (if one is connected).

If the GPS report type (***PPSGPR**) is set other NMEA reports, the PinPoint will still listen on port 17335 and respond to RAP commands received. This allows the RAP poll command to be used while in NMEA reporting mode

8 PinPoint Specific AT Commands

These AT commands are specific to the AirLink PinPoint.

Command	Description
DTRP =n [?]	Set or query the DTR power control. n = 0: Ignore DTR for power control n = 1: Enter low power mode when DTR is low n = 2: Enter low power mode when DTR is high NOTE: Also see PTMR
GPS n	Send NMEA GPS strings out serial link. ATGPS will cause the NMEA GGA, RMC, and VTG GPS strings to output to the serial port one time. ATGPS1 will cause these strings to be sent out the serial link once per second <i>forever</i> . ATGPS0 will stop the feed.
PTMR =n [?]	Number of minutes after one of the power down events (VTLG or DTRP) happens until the PinPoint enters the low power mode. n = 0-255. If DTRP and VTLG are both 0 (zero), this setting does nothing. NOTE 1: There is always a minimum of 1 minute between power down event and actual shutdown (to give the modem time to prepare); entering zero will not power down the modem immediately, but after one minute. NOTE 2: In the first 5 minutes after modem powers up, power down events are ignored to give the user time to change configurations.
VTLG =n [?]	Set or query the voltage level at which the PinPoint goes into low power mode. n = 0: Ignore voltage for power control n = low power voltage threshold in tenths of volts. Example: ATVTLG=130 would power down the modem if the voltage goes below 13.0V.
*DTRI =n	Enable monitoring the DTR signal as in input event. n = 0: Disable DTR input monitoring n = 1: Enable DTR input monitoring NOTE: If DTR is used as an input, DTR cannot be used for low-power control. (See DTRP)

Command	Description
*MF=hh [?]	Set or query GPS format, where hh is a hex value; 8E (transmit Lat/Long/Dir/Vel/Time in binary) or 8F.
*POWERMODE?	Displays the current power state/mode. Possible values returned are: INITIAL – the modem is in the initial 5 minutes since power up, so power down event will be ignored. ON – regular power on, i.e. a power down is not pending. LOW CANCELLABLE – power down is pending but still cancelable if the power down trigger goes away. LOW PENDING 1 and 2 – power down is pending, any modem tasks are gracefully preparing for the power down. LOW FINAL – power down is imminent. LOW – power is down.
*PPDEVID=0 1 [?]	Whether or not the PinPoint should include the 64-bit device ID in its GPS reports. Valid values are 0 or 1. NOTE: This setting MUST be 1 if the modem uses a Dynamic IP-based wireless technology (e.g., CDMA or GPRS)
*PPDIST=n [?]	GPS Report Distance Interval in 100 Meter Units Range n = 1-65535, 0 = Disabled
*PPGPSR=n [?]	GPS report type. n= 0x11 – Standard GPS Report n= 0x12 – Standard GPS Report + UTC Date n= 0x13 – Standard GPS Report + UTC Date + RF data n=0xE0 – GGA and VTG NMEA reports n=0xE1 – GGA, VTG and RMC NMEA reports n=0xF0 – TAIP reports
*PPIGNOREIP=[0,1] [?]	When enabled, ignore PinPoint Server IP (*PPIP) updates in RAP. 0 = Enabled. 1 = Disabled.
*PPIP=ipAddr [?]	PinPoint Server IP Address = IP address where GPS reports are sent. Example: AT*PPIP=192.100.100.100 NOTE: Also see *PPPORT
*PPLATS=n [?]	Local ATS – Causes GPS reports to also be sent out the serial link every n seconds [n=0..255], when there is a PPP connection to the serial host established. n = 0 disables this feature NOTE: Sends to the PPP peer IP [S110] with the Destination Port number [S53].
*PPLATSR=n [?]	Indicates the type of GPS report to send to the local client (PPP/SLIP peer). This value can be set to any of the valid GPS report types (see *PPGPSR).

Command	Description
*PPMINTIME=n [?]	Specifies the minimum amount of time between reports generated due to either the time interval (*PPTIME) or the distance interval (*PPDIST). This is useful to limit network traffic and make more efficient use of bandwidth. This can be used in conjunction with store and forward. n = number of seconds [0-65535] to wait between sending time or distance triggered reports. The minimum value which this setting can take depends on the policies of the carrier. 0 = Disabled.
*PPODOM=0 1[?]	Enable odometer reporting n = 0 - Odometer reporting is disabled [default] n = 1 - Odometer reporting is enabled
*PPODOMVAL=n [?]	Set or query the PinPoint's current odometer value. The value is in meters. Maximum value is approximately 4.3 billion meters (2.5 million miles).
*PPPORT=n [?]	Port where GPS reports are sent. Possible value: nnnnn = 1 – 65535 NOTE: Also see ATSIP.
*PPSNF=n [?]	Set or query the GPS report Store and Forward feature. Store and Forward will cause GPS reports to be stored up if the PinPoint goes out of network coverage. Once the vehicle is in coverage the GPS reports will be sent en masse to the server. n = 0: Disable Store and Forward n = 1: Enable Store and Forward (default)
*PPSNFB=n [?]	Store and Forward Behavior. When *PPSNF=1, the type of Store and Forward behavior is defined by: n = 0: Normal Store and Forward. Data is stored when the PinPoint is out of CDPD coverage; when the PinPoint is in coverage, data is sent to server as soon as possible. This is the default for PinPoints with RAP version 1.3 or lower. n = 1: Data sent only when polled. Data is stored until polled using the Poll command sent by a server. n = 2: Grouped Reports. Data is stored until the desired minimum number of reports (see *PPSNFM) has been stored. The data is then sent to the server in groups with at least the specified number of reports.
*PPSNFM=n [?]	Store and Forward Minimum Reports. n = 0 to 255 n specifies the minimum number of reports that must be stored before they are forwarded to the server. The data is then sent to the server in packets that contain at least this number of reports.

Command	Description
*PPSNFR=n [?]	Store and Forward Reliability GPS reports will be retransmitted if not acknowledged by the server. n = 0: SnF reliability is disabled n = 1: SnF reliability is enabled
*PPTAIPID=xxx [?]	Sets/queries the TAIP ID. This ID is returned in TAIP reports if it has been negotiated with the TAIP client. This value is only used in conjunction with TAIP emulation mode (*PPGPSR=F0). xxxx = the 4 character TAIP ID to assign this device.
*PPTIME=n [?]	GPS Report Time Interval Range n = 1 – 65535 Seconds, 0 = Disabled NOTE: A report time of less than 30 seconds in a CDMA network, can possibly keep an RF link up continuously. This will eventually cause the PinPoint to overheat and shutdown, plus annoy the CDMA carrier since an RF resource will be tied up to transfer small amounts of data. The CDMA RF channel will be released and go dormant in 10-20 seconds of no data sent or received. NOTE: Some carriers may impose a minimum transmit time. See *PPMINTIME NOTE: Also see *PPTSV NOTE: Also see +CTA [for CDMA}
*PPTSV=n [?]	Timer for Stationary Vehicles. n = [0--255]: Time interval in minutes that the PinPoint will send in reports when it is stationary. For example, if *PPTIME=10, the PinPoint will send in reports at least every 10 seconds while it is moving; however, once it stops moving, it will slow the reports down to this *PPTSV value. A zero value disables the stationary vehicle timing.
*RTSI=n	Enable monitoring the RTS signal as in input event. n = 0: Disable RTS input monitoring n = 1: Enable RST input monitoring NOTE: If RTS is used as an input, hardware flow control cannot be enabled
*UDPRGPS=n [?]	Set or query GPS stamping of UDP Reliable packets. When set, data received on the host serial port will be encapsulated with the GPS date and time. n = 0: Disable GPS stamping (default) n = 1: Enable GPS stamping
#IG=n [?]	Set or query GPS initialization timer. n = seconds. Time in seconds to wait for GPS acquisition before transmitting at high rates.
#U	Immediately issue GPS report to the PinPoint server IP and port

9 Using AT Commands

Use a terminal emulation program to connect up to the modem either locally (via the serial port of a computer) or remotely (over an existing internet connection on a PC to the modem at a remote location). Set up to connect to the modem by either method described in Section 0.

Sample AT Commands

Here is an example of entering AT commands, changing some settings, saving and resetting the modem. (Note that any command you are unsure of is explained in *The AT Commands* section.)

Type **AT** and press the Enter key. **AT<enter>**

You should get a response of "0" or "OK".

To turn on echo and verbose modes, type the following: **ATE1V1<enter>**

You should see an "OK" response if Verbose Mode was properly activated (V1)

If you should see a "0" response, your modem is in Terse Mode and the V1 command did not adhere.

Try ATV1 again by itself if that happens. You should see an "OK" response now.

To set the baud rate slower, (like 115200), type the following:
ATS23=115200,8N1<enter>

You should get an "OK" (if in Verbose Mode)

Note:

HyperTerm needs to be disconnected and reconnected after each baud rate change to have it take effect.

9.1 CDMA Specific AT Commands

These AT commands are specific to the CDMA devices and networks.

Command	Description
+CTA=n[?]	Inactivity timer, in seconds. Typical CDMA network settings cause a link to go dormant after 10 to 20 seconds of inactivity, no packets transmitted or received. This time can be shortened to release the physical RF link sooner when the application only transmits short bursts. A good example is a PinPoint that transmits its location reports periodically. A setting of +CTA=2 will release the link 2 seconds after transmitting its report.
+HWTEMP?	Displays the internal temperature of the SB555 module in degrees Centigrade

9.2 Raven and PinPoint AT Command Reference

Command	Description
+++	<p>AT Escape sequence (not preceded by AT).</p> <p>If modem is in a data mode, this sequence causes the modem to re-enter AT command mode. There must be 1 second of idle time on the serial port before and after the sequence. Note that the “+” is ASCII character 0x2B.</p> <p>NOTE: The detection of this sequence is disabled if DAE=1</p>
A/	Re-execute last command.
AIP=n [?]	<p>n = 0: Allow only the IP specified in S53 to connect when UDP auto answer is enabled (S82=2).</p> <p>n = 1: Allow any incoming IP to connect when UDP auto answer is enabled (S82=2).</p> <p>Always subject to any Friends filters that may be defined</p>
<p>D[method][d.d.d.d]/[ppppp]</p> <p>or</p> <p>D[method][[@]name]/[ppppp]</p>	<p>Dial a connection to a remote IP and Port using either UDP, TCP, or Telnet.</p> <p><i>method</i> =</p> <p>P – Establish a UDP connection</p> <p>T – Establish a TCP connection</p> <p>N – Establish a Telnet connection</p> <p><i>d.d.d.d</i> = IP address to establish connection to</p> <p><i>name</i> = domain name to establish connection to</p> <p><i>ppppp</i> = IP port to establish connection to</p> <p>Examples:</p> <p>ATD – Dial (establish) default connection per S53</p> <p>ATDPnnn.nnn.nnn.nnn/[ppppp] - Dial (establish) UDP session to the specified IP address/port.</p> <p>If the method, IP address, or port is omitted, the values from S53 are used. If a telnet connection is requested (N) and the port is not supplied, port 23 will be used instead of the value from S53.</p> <p>Several special dialing numbers exist to make it easy to establish a PPP or SLIP connection with the modem. ATD#19788 or ATDT#19788 will establish a PPP connection (see \APPP) and ATDT#7547 will establish a SLIP connection (see \ASLIP).</p> <p>If a domain name is specified, the ‘@’ symbol can be used to explicitly indicate the start of the name. For example, if “ATDPHONY” is issued, this will be interpreted as dial a UDP connection to “HONY”. To dial using the default method to host “PHONY”, one would issue “ATD@PHONY”.</p> <p>To end the connection, issue the +++ escape sequence or drop the DTR line (if Ignore DTR S211=0 or &D2)</p> <p>NOTE: The <i>source</i> port of the session is the Device Port (set by S110 or *DPORT)</p>

Command	Description
DAE =n [?]	Disable AT Escape Sequence detection n = 0: Enable +++ AT escape sequence detection. n = 1: Disable +++ AT escape sequence detection.
En	Toggle AT command echo mode. n = 0: Echo Off n = 1: Echo On.
FM =n [?]	Friends Mode – Only allow specified IPs to access the modem n = 0: Disable Friends mode n = 1: Enable Friends mode – Only packets from <i>friends</i> will be accepted (see below); packets from other IP addresses are ignored.
Fn =d.d.d.d [?]	Friends mode IP address n = Friends list index [1 – 10] d.d.d.d = IP address to be allowed to access the modem 255 = allow any number 0-255 Example: 166.129.2.255 allows access by all IPs in the range 166.129.2.0—166.129.2.255.
H	This command does nothing but does not cause an error either.
HOR =n [?]	Half-Open Response – In UDP auto answer (half-open) mode: n = 0: No response codes when UDP session is initiated n = 1: RING CONNECT response codes sent out serial link before the data from the first UDP packet. <u>Note:</u> Quiet Mode must be Off.
I [0]	Returns the product name.
I1	Returns AirLink modem's firmware version, hardware ID, and copyright.
I2	Returns the OEM Modem's firmware version and relevant hardware ID
I3	Returns the OEM Modem's unique ID
M	This command does nothing but does not cause an error either.

Command	Description
MDhh [?]	Set or query the modem's default power-up mode hh (hex byte) = When the modem is power-cycled, it may enter the mode specified by this command after 5 seconds. On startup, typing ATMD0 within 5 seconds changes the mode to normal. 00 – normal (AT command) mode 01 – SLIP mode 02 – PPP mode 03 – UDP mode (address/port is in S53) 04 – TCP mode (address/port is in S53) [Also see Modbus Modes for Ravens]
OPRG=n [?]	Enables/disables over-the-air firmware upgrading of the modem. n = 0: Disables over-the-air programming. n = 1: Enables over-the-air programming.
PING d.d.d.d[,n] PING domain_name[,n]	Ping the specified IP address. Sends a single ping, returns either OK or ERROR depending on result. Times out in 10 seconds. If n is provided, it specifies the amount of data to send with the ping. If n is not provided, the default, 50 bytes is used.
Qn [?]	Set or query the AT quiet-mode setting. If quiet mode is set, there will be no responses to AT commands except for data queried. n = 0: Off (Default) n = 1: Quiet-mode on.
S0=n [?]	This register determines how a modem responds to an incoming TCP connection request. The modem remains in AT Command mode until a connection request is received. DTR must be asserted or (or S211=1 or &D0) must be set for a successful TCP connection. The modem will send a “RING” string to the host. A “CONNECT” sent to the host indicates acknowledgement of the connection request and the TCP session is established. n = 0: Off (Default) n = 1: On n = 2: Use Telnet server mode on TCP connections
S7=n [?]	Specifies the number of seconds to wait for a TCP connection to be established when dialing out.
S23 =<speed>,<databits> <parity><stop bits> [?]	Query or set serial line parameters: <speed> = [1200 2400 4800 9600 19200 38400 57600 115200 230400] <databits> = [7 8] <parity> = [O=Odd E=Even N=None M=Mark] <stopbits> = [1 1.5 2] Example: ATS23=19200,8N1 (sets modem to 19200, etc.) The settings take affect after reset. NOTE: MUST be 8 data bits for PPP mode.

Command	Description
S50 =n [?]	Set or query data forwarding idle timeout. n = tenths of seconds. (Used in UDP or TCP PAD mode)
S51 =n [?]	Set or query PAD data forwarding character. n = 0: no forwarding character n = other: ASCII code of character that causes data to be forwarded. (Used in UDP or TCP PAD mode.)
S53 = [method]d.d.d.d[/ppppp] [?]	Set or query Destination IP address, port, and method. These are used as defaults for the D (Dial) AT command. method = P – UDP T – TCP N – Telnet d.d.d.d = IP address ppppp = the port address ATS53=T192.168.100.23/12345 ATS53=192.168.100.23/12345 ATS53=/12345
S60 =n [?]	Telnet Client Echo Mode n = 0: No Echo n = 1: Local Echo (Default) n = 2: Remote Echo
S82 =n [?]	Enables UDP auto answer (half-open) mode. n = 0: Normal mode n = 2: Enable UDP auto answer mode.
S83 =n [?]	Set or query UDP auto answer idle timeout. If no data is sent or received before the timeout occurs, the current UDP session will be terminated. While a session is active, packets from other IPs will be discarded (unless *UALL is set). n = 0: No idle timeout (Default). n = 1-255: Timeout in seconds.
S110 =d.d.d.d[/ppppp] [?]	Used to query or set IP address and port for CDPD modems, or only sets the modem's Device Port for CDMA and GPRS modems. Since the IP address is determined from the CDMA and GPRS networks, any specified address will be ignored. If S300=0 you will get the network IP when you query this value. If S300=1 you will get the private IP address. d.d.d.d = IP address ppppp = port number NOTE: See also S300,*DPORT
S202 ?	Queries the current RSSI in dBm

Command	Description
S211 =n [?]	Ignore DTR. For applications or situations where hardware control of the DTR signal is not possible, the modem can be configured to ignore DTR. When Ignore DTR is enabled, the modem operates as if the DTR signal is always asserted. n=0 [default]: Use hardware DTR. [&D2] n=1: Ignore DTR. [&D0] n=3: Ignore DTR and assert DSR. This value is deprecated, and it is recommended to use &S to control the DSR instead. When this value is set to 3, &S will automatically be set to 0.
S221 =n [?]	Connect Delay [n = 0 - 255] n = number of seconds to delay the "CONNECT" response upon establishing a TCP connection OR n = number of tenths of seconds to delay before outputting ENQ on the serial port after the CONNECT when the ENQ feature is enabled [see *ENQ]
TCPS =n [?]	TCP connection timeout (TCPT) units. n = 0: TCPT specifies minutes. n = 1: TCPT specifies seconds.
TCPT =n [?]	TCP connection timeout. Specifies a time interval upon which if there is no in or outbound traffic through a TCP connection, the connection will be terminated. This value only affects the TCP connection in TCP PAD mode. n = minutes (if TCPS=0) or seconds (if TCPS=1)
V n [?]	Set or query Command Response Mode. n = 0: Terse (numeric) command responses n = 1: Verbose command responses (Default).
X n [?]	Extended Call Progress Result mode. n = 0: turn off extended result codes (Default) n = 1: turn on result codes. This adds the text 19200 to the CONNECT response.
Z	Reset the modem. NOTE: This command does nothing if *DATZ=1 .
&C n [?]	Set DCD mode. n = 0: Always assert DCD n = 1: Assert DCD when in a data mode (UDP, TCP, PPP, or SLIP) (Default). n = 2: Assert DCD when the modem has network coverage.
&D n [?]	Set DTR mode. n = 0: Ignore DTR, same effect as HW DTR always asserted (same as S211=1) n = 2: Use hardware DTR (same as S211=0)

Command	Description
&L <speed>,<databits> <parity><stop bits>	Set serial line parameters (see S23)
&Sn [?]	Set DSR mode. n = 0: Always assert DSR n = 1: Assert DSR when in a data mode (UDP, TCP, PPP, or SLIP) (Default). n = 2: Assert DSR when the modem has network coverage. Note: Although deprecated, S211 can also be used to request that DSR is always asserted. If S211 is set to 3 and &S is changed to a non-zero value, S211 will be changed to 1.
&V	View active profile (the contents of the registers)
&W	Writes all changed modem settings. If this command is not issued, any modified values will revert back to their previous values at modem reset.
&Z	This command does nothing but does not cause an error either.
\ACEPW=new123	Change the Ace password to a new value. Password is case sensitive. Default value is 12345 Example: AT\ACEPW=new123
\APASSTHRU	Set modem operation to pass through mode. This will pass any characters received on the serial port directly to the internal OEM Modem and output any characters from the internal OEM Modem out the serial port. This allows direct access/configuration of the OEM Modem. Once this mode is entered, the unit must be physically reset to return to normal operation. NOTE: It may take up to 30 seconds for the OEM Modem to respond after CONNECT is output. NOTE: This mode is not available through the remote AT telnet server.
\APPP	Set modem operation to PPP mode. The modem expects the Host to start PPP negotiation. DTR must be asserted or (&D0 or S211=1)
\ASLIP	Set modem operation to SLIP mode. DTR must be asserted or (&D0 or S211=1)
\Qn [?]	Set or query the serial port flow control setting. n = 0: No flow control is being used n = 2: RTS/CTS hardware flow control is being used n = 4: Transparent software flow control. Uses escaped XON and XOFF for flow control. XON and XOFF characters in data stream are escaped with the @ character (0x40). @ in data is sent as @@.
*CSX1=[0 1] [?]	If set (*CSX1=1), PASSTHRU mode will echo all host received data and will not pass the data to the modem while the modem is not asserting DCD. If the modem is asserting DCD, data will be passed from the host to the modem as it normally is when *CSX1=0 .

Command	Description
*CTSE=n [?]	<p>Clear To Send Enable</p> <p>This feature asserts CTS when there is a network connection.</p> <p>Note: Flow control (AT\Q) will override this indication, so if you want to use CTS to indicate network coverage, flow control has to be off (AT\Q0).</p> <p>RS232 voltage levels: Positive = Network coverage, Negative = no coverage.</p> <p>n = 0: Disabled (Default).</p> <p>n = 1: Enable assertion of CTS when there is network coverage.</p>
*DATE=[mm/dd/yyyy],[hh:mm:ss] [?]	<p>Sets and queries the clock in the unit. Either the date and time can be specified, or simply one of the two can be specified in which case the unspecified value will remain unchanged. The date and time are always specified in UTC (Universally Coordinated Time) and, as such, the hours are specified in 24-hours format.</p> <p>Note that if the product has a GPS (i.e. PinPoints), the GPS will be used to set the time, in which case any date/time specified will be ignored.</p>
*DATZ=n [?]	<p>Enables or disables reset on ATZ</p> <p>n = 0: Normal Reset (Default).</p> <p>n = 1: Disable Reset on ATZ.</p>
*DBGIPLVL=n [?]	<p>Sets the logging level for the IP subsystem.</p> <p>n = 0: No logging</p> <p>n = 1: Log errors (i.e. invalid/corrupt packets, etc.).</p> <p>n = 2: Log the header of all received packets. Note that this can quickly exhaust the event log.</p>
*DBGPPPLVL=n [?]	<p>Sets the logging level for the PPP stack.</p> <p>n = 0: No logging</p> <p>n = 1-3: Enables logging at different levels of detail.</p>
*DEVICEID=n [?]	<p>Sets or queries the 64-bit Device ID that is used by the modem to identify itself to the server. The default is a value that depends on the underlying communications technology being used.</p>
*DEVICEIDX=n [?]	<p>Same as *DEVICEID except entry of the 64-bit Device ID is in hexadecimal.</p>
*DNSn=d.d.d.d	<p>Sets the DNS addresses to be returned during PPP negotiation. If the underlying communications network provides DNS addresses, they replace those specified by this command. *DNS1 and *DNS2 are valid.</p>

Command	Description
*DOMAIN =[name] [?] (was *DOMAINSUFFIX)	Domain (or domain zone) which the modem is in. This value is used during name resolutions if a fully qualified name is not provided and also for DNS updates. This value can be up to 20 characters long. If *DOMAIN=airlink.com , then when ATDT@remote1 is entered, the fully qualified name remote1.airlink.com will be used to perform a DNS query to resolve the name to an IP address. Note: Only letters, numbers, hyphen '-', and periods can be used in a domain name.
*DPORT =n [?]	Sets or queries the modem's Device Port. Valid values are 1-65535. [See S110]
*DU =n [?]	Dial UDP Always The dial command always uses UDP, even when using ATDT n = 0: dial using the means specified [default] n = 1: dial UDP always, even when using ATDT NOTE: When this parameter is set you <i>cannot</i> establish a TCP PAD connection.
*ENQ =n [?]	Outputs an ENQ [0x05] after the TCP CONNECT delayed by the Delay Connect Response time [S221]. n = 0: Disabled (Default). n = 1: Enables ENQ on CONNECT .
*HOSTPRIVMODE =n [?] (was S300)	Set or query whether a private or public (network) IP is to be used when the Host initiates a PPP connection to the modem. n = 0 [default]: Public (network) IP Mode: When the Host initiates a PPP connection, the host will be given the public IP that was obtained from the OEM Modem. If the network issues a new IP, the PPP connection will be closed (since the IP has changed) and has to be re-initiated. n = 1: Private IP Mode: When the Host initiates a PPP connection, the host will be given the IP address specified in *HOSTPRIVIP . The modem will then perform NAT-like address translation, which shields the Host from network IP changes.
*HOSTPRIVIP =d.d.d.d [?] (was S301)	Set or query the private IP address that is to be negotiated by the PPP connection if *HOSTPRIVMODE =1 .
*HOSTPEERIP =d.d.d.d [?] (was S302)	Set or query the IP address that can be used to directly contact the modem once a PPP connection is established. If this value is not specified, 192.168.13.31 will be used. NOTE: This is not normally used nor needed by user applications.
*IPMANAGER n=[name][?]	Sets a domain name or IP address to send IP change notifications to. Up to two independent IP Manager servers can be set, using either AT*IPMANAGER1 or AT*IPMANAGER2 . Updates to a server can be disabled by setting that entry to nothing (i.e. " AT*IPMANAGER1= ").

Command	Description
*IPMGRKEYn =[key][?]	Sets the 128-bit key to use to authenticate the IP update notifications. If the key's value is all zeros, a default key will be used. If all the bytes in the key are set to FF, then no key will be used (i.e. the IP change notifications will not be authenticated). AT*IPMGRKEY1 is used to set the key to use with AT*IPMANAGER1 , while AT*IPMGRKEY2 is used to the key with AT*IPMANAGER2 . key = 128-bit key in hexadecimal [32 hex characters]
*IPMGRUPDATEn =x [?]	Sets the number of minutes to periodically send an IP update notification to the corresponding server. This will occur even if the IP address of the modem doesn't change. *IPMGRUPDATE1 is used to set the refresh rate to *IPMANAGER1 , while *IPMGRUPDATE2 is used with *IPMANAGER2 . x = 0, 5-255 minutes. If the value is set to 0, then periodic updates will not be issued (i.e. IP change notifications will only be sent when the IP actually changes).
*IPPING =n [?]	Set the period to ping (if no valid packets have been received) a specified address (*IPPINGADDR) to keep the modem alive (online). Units are in minutes [1-255]. 0 [default] = Disable ping.
*IPPINGADDR =IP/Name [?]	Set the IP address (n.n.n.n) or valid internet domain name for the modem to ping to keep itself alive (online). *IPPING must to be set to a value other than 0 to enable ping.
*MODEMNAME =[name][?] (was *DOMAINNAME)	Name of the modem (up to 20 characters long) to use when performing IP change notifications to IPManager. This name should not be a fully qualified domain name, but simply the first portion. The value in *DOMAIN provides the domain zone to add to this name. For example if *MODEMNAME = mymodem and *DOMAIN = airlink.com , then the modem's fully qualified domain name is mymodem.airlink.com . NOTE: Only letters, numbers, hyphen '-', and periods can be used in the modem name.
*MSCIUPDADDR =Name/[Port]	Modem Status Update Address - where Name/Port is the domain name and port of the machine where the modem status updates will be sent. The modem's status parameters are sent in an XML format.
*MSCIUPDPERIOD =n [?]	Modem Status Update Period - where x defines the update period in minutes. n = 0-255. 0 = Disabled.
*NETCHAN?	Returns the current active channel number.
*NETIP?	Query the current public (network) IP address of the modem. This is the IP address that was obtained from the embedded OEM Modem, and is the address to which packets can be sent in order to contact the modem from the Internet. NOTE: This could be 0.0.0.0 if there is no current network IP
*NETOK	Checks wireless network connection Responds OK if connected Responds ERROR if not connected

Command	Description
*NETPHONE?	Query the device's phone number, if applicable or obtainable.
*NETPW=pw [?]	The password that is used to login to the wireless network, when required.
*NETRSSI?	Returns the current RSSI [Receive Signal Strength Indicator] of the modem as a negative dBm value.
*NETSTATE?	<p>Query the current network state. Will get one of the following strings:</p> <p>Connecting To Network The modem is in the process of trying to connect to the network;</p> <p>Network Authentication Fail Authentication to the network has failed. Either *NETUID and *NETPW need to be updated, or the PDP Context [GPRS network] needs to be specified, or for some reason the network refuses to allow the modem to connect;</p> <p>Network Negotiation Fail Network connection negotiation failed. This is usually temporary and often clears up during a subsequent attempt;</p> <p>Network Ready Modem is connected to the network and ready to send data;</p> <p>Network Dormant Modem is connected to the network, but the link is dormant [CDMA network]. It will be woken up when data is sent or received;</p> <p>No Service There is no network service (e.g., no CDPD, no GPRS, or no CDMA service detected);</p> <p>Hardware Reset The OEM modem is being reset. This is a temporary state.</p>
*NETUID=uid [?]	The login that is used to login to the wireless network, when required.
*NUMTOIP=n [?]	Convert 12 digit number to IP. 0 = Use as name. 1 = Use as IP.
*PTINIT=n [?]	Any AT Command string to be passed to the OEM module before entering PASSTHRU mode, e.g. AT&S1V1, etc.
*PTREFRESH=n [?]	Number of minutes of inactivity in PASSTHRU mode to resend the *PTINIT string to OEM module. n = 0-255. 0 = Disabled.
*RESETPERIOD=n [?]	In PASSTHRU mode, modem will be reset after this period if no data has been sent or received. n = 0-255. Value is in hours. 0 = Disabled.
*TPORT=ppppp [?]	Sets or queries the port used for the AT Telnet server. Valid values are 0-65535. If 0 is specified, the AT Telnet server will be disabled. The default value is 2332.

Command	Description
*UALL=n [?]	<p>Accepts UDP packets from any IP address when a UDP session is active. If there is no UDP session active, an incoming UDP packet will be treated according to the UDP auto answer and AIP settings.</p> <p>n = 0: No effect (Default).</p> <p>n = 1: Accept UDP data from all IP addresses when in a UDP session.</p>
*UDPLAST=n [?]	<p>If enabled, sets S53 to the last accepted IP address through UDP auto answer. This can be used in conjunction with MD3 so that when there is no UDP session, new serial host data will cause a connection to be restored to the last IP accepted through UDP auto answer.</p> <p>n = 0: Does not change S53 setting. (Default).</p> <p>n = 1: Set S53 to the last accepted IP.</p> <p>NOTE: This does not change the S53 setting in NVRAM. If the modem is reset, the original S53 setting will be restored from NVRAM.</p>
*USD=n [?]	<p>Inserts a delay between received UDP packets by a specified interval before sending them out to the serial port.</p> <p>n = 0: No UDP packet delay (Default).</p> <p>n = 1-255: Delay in 100ms units, from 100 ms to 25.5 sec.</p>

10 Raven Installation

This section details the hardware specs of the Raven and mounting it with other hardware, the power requirements, mounting bracket, etc.

Mounting the Raven

The Raven should be mounted in a position that allows easy routing and access for the cables. There should be no binding or sharp corners in the cable routes. The Raven should be mounted so that the LEDs on the front panel can be easily seen for ease of operational verification.

The snap-in mounting bracket (part number 100-170-1006) is installed using #8 or #10 screws. Press the Raven down firmly into the bracket and note that both sides have locked into the groove on the Raven case.



Figure 1 - Raven Mounted in Mounting Bracket

Note: The tie-wrap is if the modem needs to be really secure, as in a vehicle or in shipping. In stationary applications, as in a box that sits out in a pasture with a solar cell, etc., the tie-wrap is not necessary.

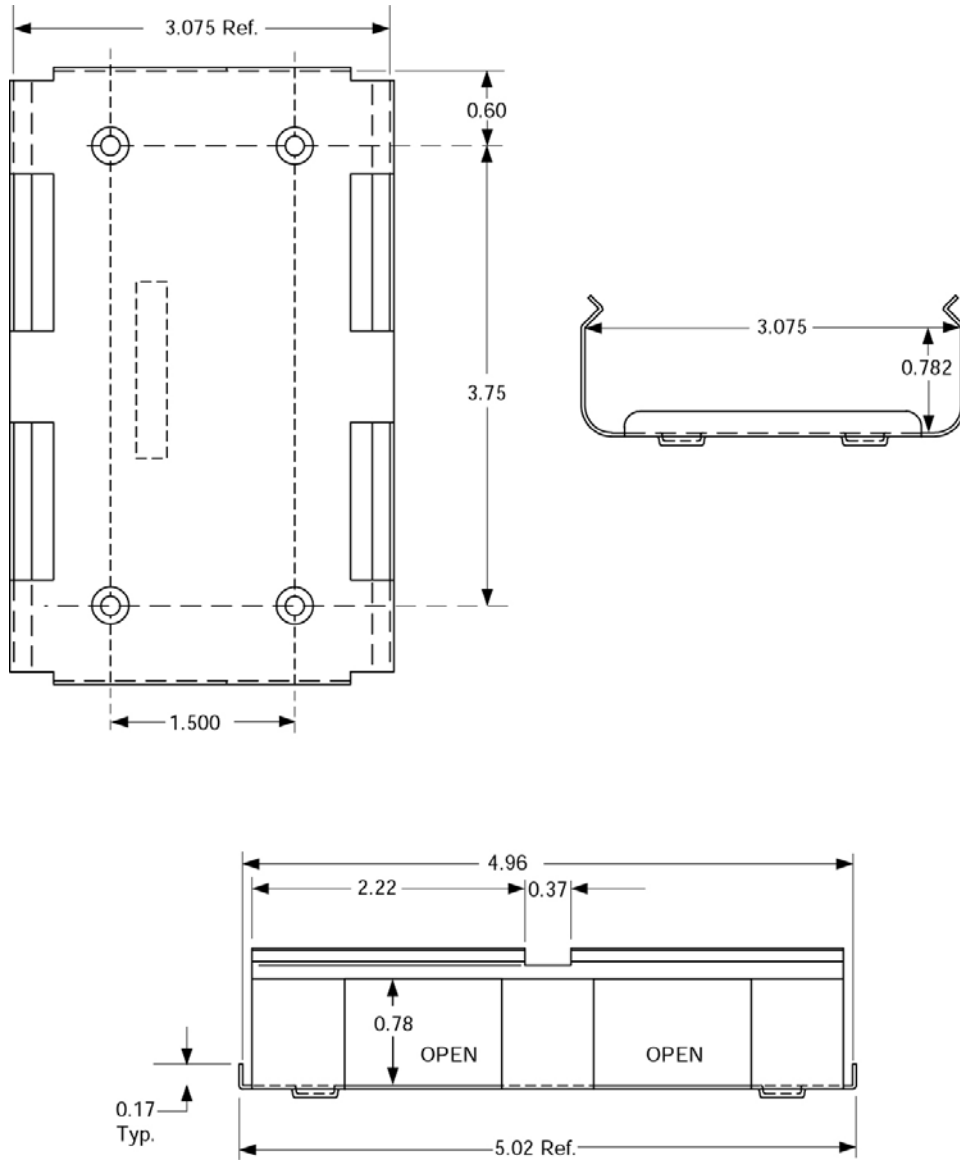

Figure 2- Snap-in Mounting Bracket

10.1.1 Connecting the antenna

Install an appropriate external cellular antenna. Connect the antenna to the external jack of the bulkhead jack adapter with an appropriate RF cable. Connect the Raven antenna jack to the interior bulkhead jack with an appropriate RF cable.

10.1.2 Connecting the serial cable

Connect the RTU/PLC meter serial port to the Raven serial port with a DB-9 male connector.

10.1.3 Grounding the Raven Case

The exterior Raven case should be connected to the enclosure ground which should be connected to the battery or power source negative terminal. This is best accomplished with a grounding strap under one of the mounting bracket screws to the enclosure grounding bar.

10.1.4 Connecting the power cable

The power cable positive lead should be connected to the battery or power source positive terminal. The power cable negative lead should be connected to the battery or power source negative terminal. The Raven has an internal polysilicon circuit breaker that opens at 0.5 to 1.0 amps of current.

Insert the power connector into the Raven power receptacle.



Figure 3 - Raven Back Panel

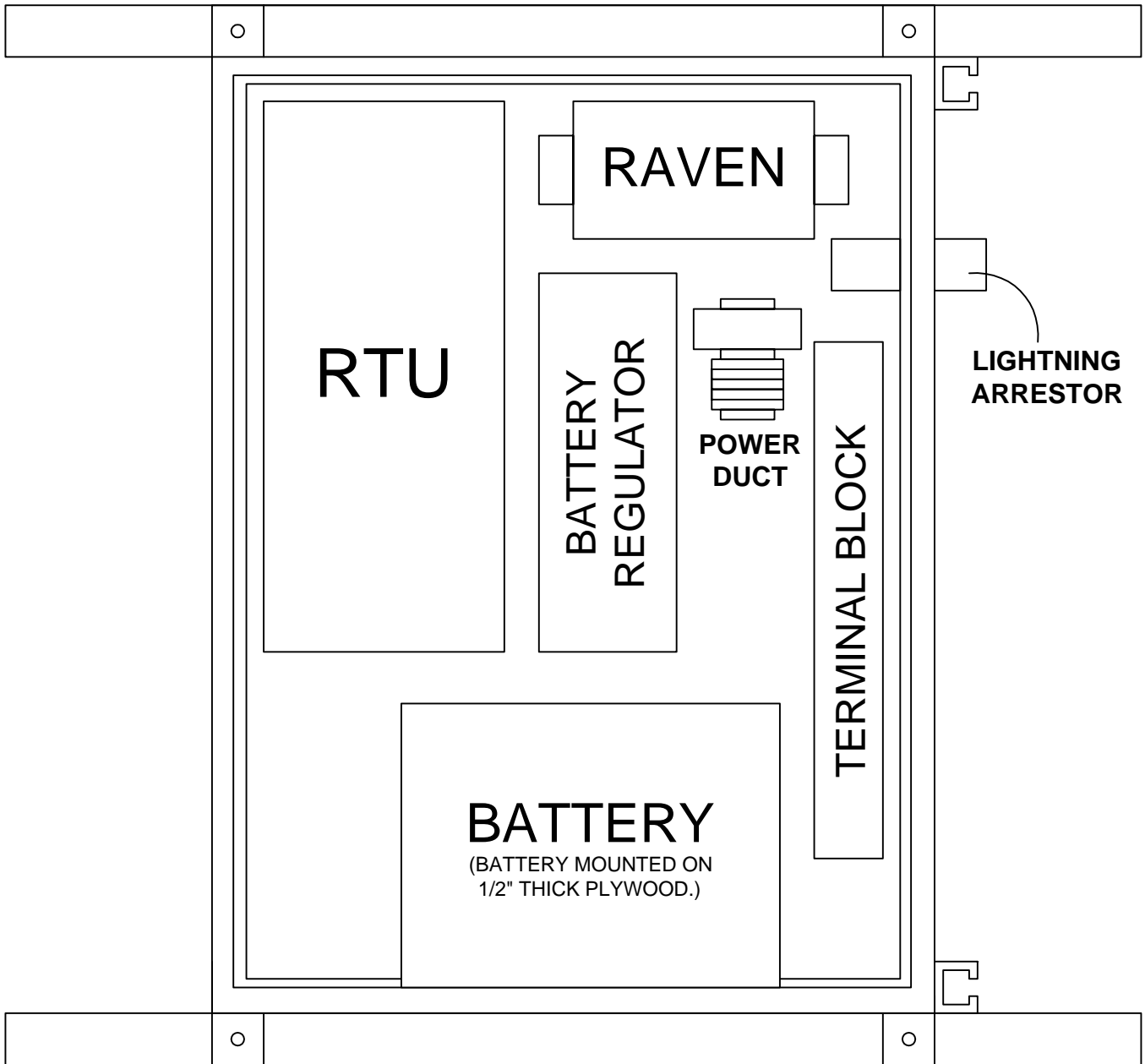

Figure 4 Raven mounted in an enclosure with RTU

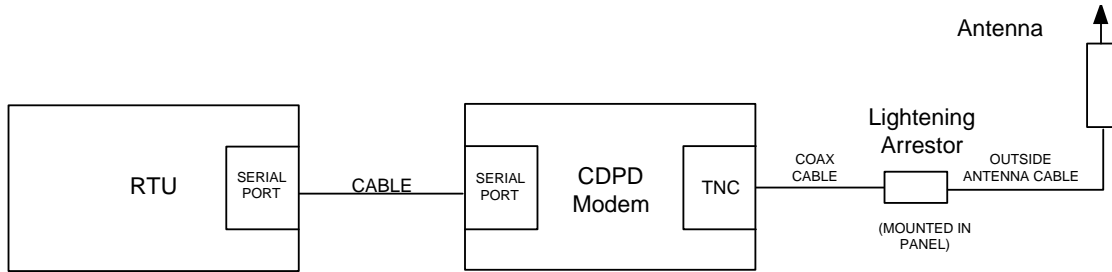

Figure 5 - RTU to Raven setup

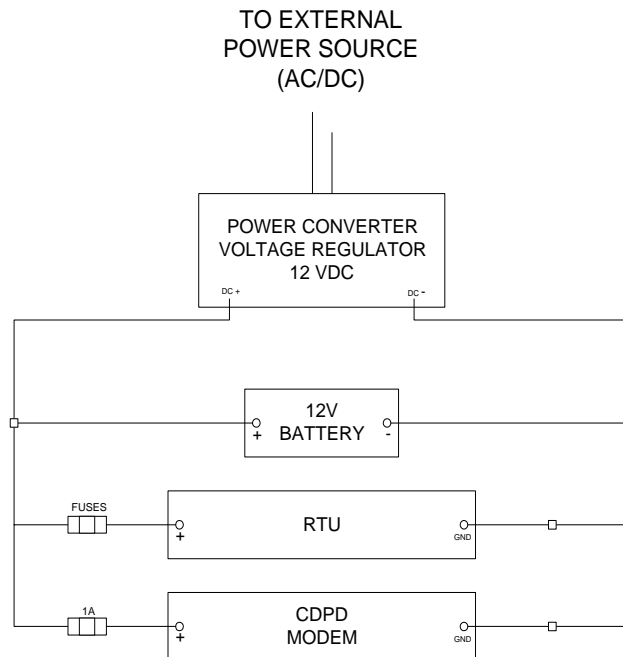

Figure 6 - Power Connections

11 PinPoint Vehicle Installation

This section covers installing a PinPoint CDMA modem into a vehicle in the most optimum way possible, ensuring no future

11.1 Overview

Installing a PinPoint in a vehicle consists of:

- Choosing a location in the vehicle for the PinPoint
- Mounting the PinPoint
- Hooking up power to the PinPoint
- Routing the cables through the vehicle
- Positioning the antennas for good reception
- Connecting and securing cables to the PinPoint

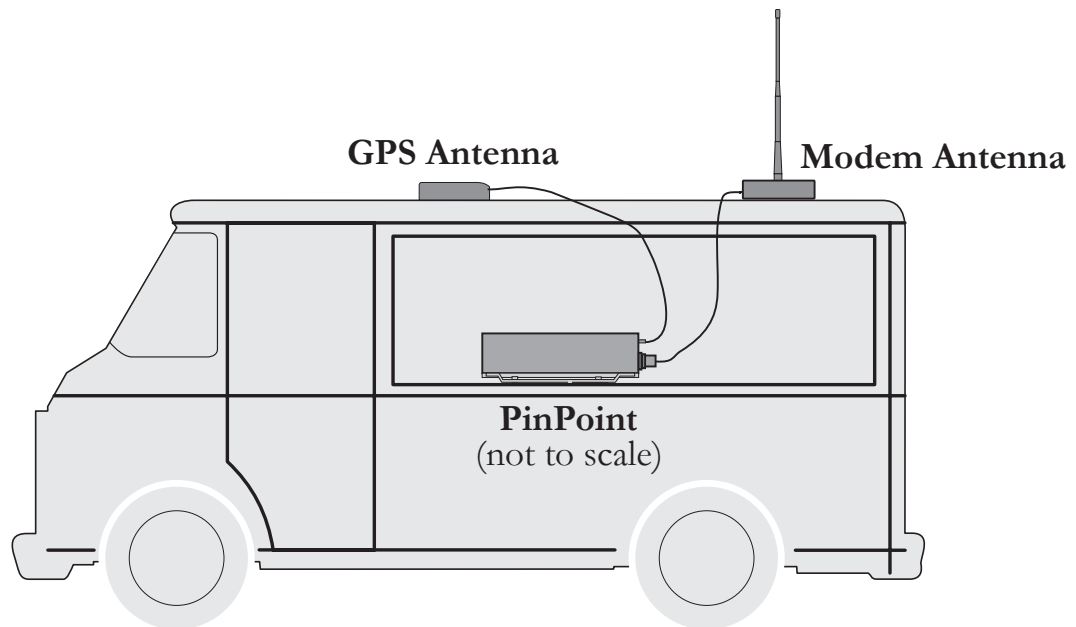

Note: Keep all cable lengths as short as possible during installation. Route the cables in such a way so they are protected and will not cause interference. Bundle and tie excess amounts if needed.

11.2 Mounting the PinPoint

First locate a place in the vehicle where the PinPoint will go. Make sure the PinPoint will be away from direct exposure to the elements (sun, rain, etc.). Possible locations are: in a trunk where luggage or other items won't hit it, in the console, or behind the seats in pickup trucks. Ensure the location is secure and will not put the PinPoint in the way of anything.

1. Mount the PinPoint on the provided bracket.

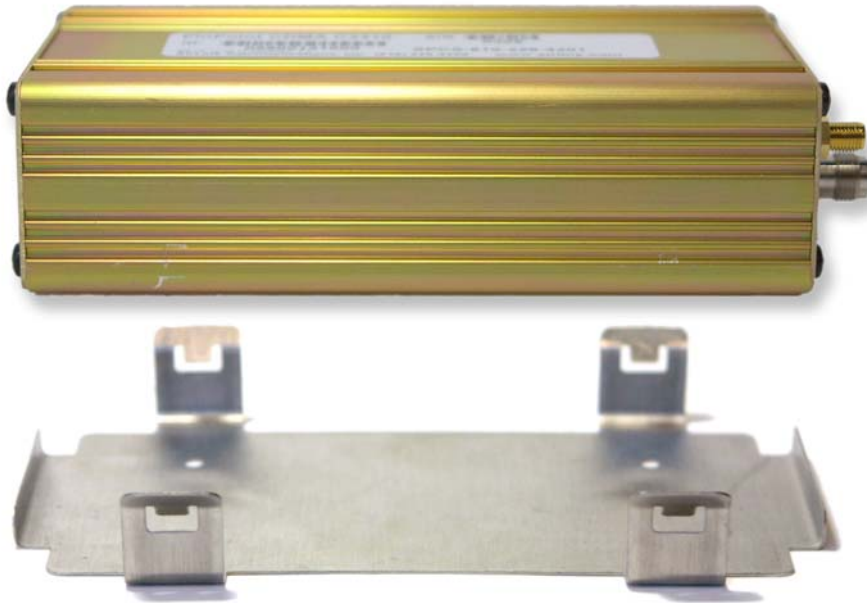

2. Connect the PinPoint's power cable to a **fused** 12 or 24 VDC power source. (*Note: PinPoint will draw less than 1/2 Amp at 12V.*)
3. Mount the CDMA Antenna and route the cable to the PinPoint location. Make sure any excess cable is tie-wrapped and not in the way of any luggage, passengers, or anything else.

11.3 Installing the Antennas

There are three options for an antenna:

- magnetic roof-mount
- through glass-mount
- permanent mount

1. Mount the GPS Antenna in the vehicle. The less the cable is wrapped and bound together, the better it will perform. Place it on the roof, or on the dash, or rear panel where it has a good view of the sky (greater than a 90° angle view of the sky -- see Figure 2).

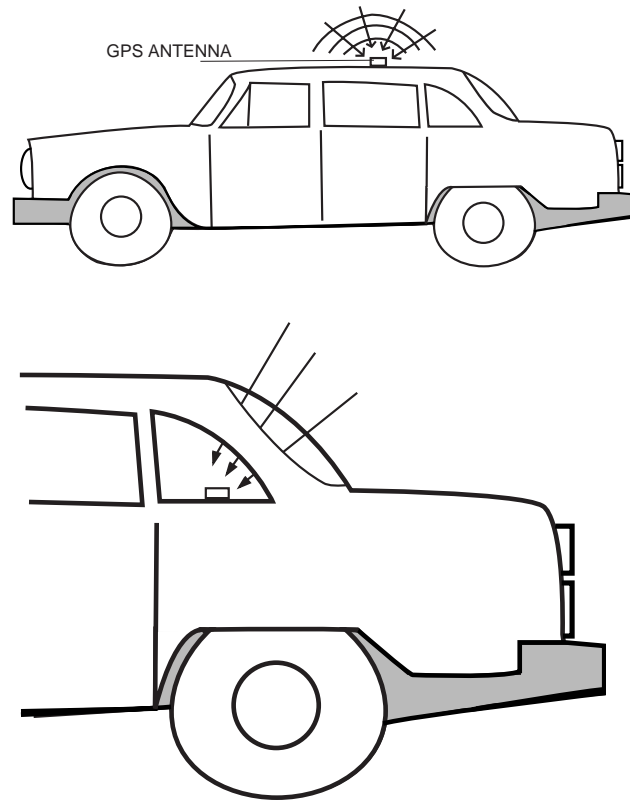

Figure 2 – Optimum GPS antenna positioning on a vehicle.

2. Connect the GPS Antenna into the PinPoint's rear panel.
3. Connect the CDMA Cellular Antenna to the PinPoint's TNC connector.
4. Plug in the power connector into the power receptacle on the PinPoint's rear panel.

Note: The green power light should be on at this point.

12 Raven CDMA Technical Specifications

12.1 Quick Look

- Supports CDMA2000 1X, IS-95 Circuit Switched CDMA and SMS
- Dual-band support for both 800 MHz cellular and 1.9 GHz PCS bands
- Rugged aluminum case

12.2 Physical Characteristics

- Weight: < 1 lb.
- Size: 3.3" wide x 2" high x 6.8" long
- RF Antenna Connector: 50 Ohm TNC
- Serial Interface: RS232 DB-9F

12.3 Power Specifications

- Advanced Power Management features
- Input Voltage: 10 VDC to 28 VDC
- Input Current: 50 mA to 250 mA at 12V
- Typical Transmit/Receive: 250ma at 12VDC
- Dormant connection [idle for 10-20 seconds] 50 ma at 12 VDC

12.4 Environmental

- Operating ranges: -30°C to +70°C*
- (<10%duty cycle limit above 60 °C)
- Humidity: 5%-95%Non-condensing

A thermistor inside the modem (monitored by the modem CPU firmware) causes flow control to be activated should the internal temperature reach 75°C (167°F) as measured at the radio. Flow control is released when the temperature falls below 75. Should the temperature of the radio reach 80°C (176°F), the modem terminates the connection in order to protect components and avoid drifting outside radio specifications.

12.5 Status LED Display

- Channel [Chan] LED
Flashing = Searching for a channel
On = Found a channel
- Link LED
Off = No 1x or CDMA service
On = 1x or CDMA service is available on this channel
- Registration (REG) LED:
Off = No PPP link on CDMA network
On = PPP link is established on CDMA network and have an IP address.
- RSSI LED
– Indicates signal strength. Signal strength is denoted as follows:
 - < -100: RSSI LED off
 - -99 to -90: Blink every 1200ms
 - -89 to -80: Blink every 600ms
 - -79 to -70: Blink every 300ms
 - >= -69: RSSI LED on solid
- Transmit (TX) LED:
Off = Not transmitting
On = Transmitting (on RF)
- Receive (RX) LED:
Off = No incoming data
On = Receive data (on host)
- ERR LED
Currently unused
- Power (PWR):
Off = Power off
On = Power on

12.6 RF Features

- 224 mW RF output (+23.5 dBm)
- Full duplex transceiver
- Dual-band support for both 800 MHz cellular and 1.9 GHz PCS bands
- Data rates up to 153.6 kbps (forward channel) and 76.8 kbps (reverse channel)

12.7 Application Interface Features

- RS232, 1200 bps to 115.2 kbps
- AT Commands, PPP, SLIP, UDP, TCP

12.8 CDMA and Cellular Standards

- Adheres to CDMA authentication as specified in CDMA2000 1X
- CDMA2000 1X Release 0 (plus ballot resolution version of addendum)
- CDG1, 2, and 3 for CDMA2000 1X
- IS-95B: Mobile Station-Base Station Compatibility
- Standard for Wideband Spread Spectrum Cellular Systems
- IS-98C and D: Recommended Minimum Performance
- Standards for Dual-Mode Spread Spectrum Mobile Stations
- Telecommunications Systems Bulletin (TSB2000): Capabilities Requirements Mapping for CDMA2000 Standards (TIA/EIA/TSB2000)

13 PinPoint CDMA Technical Specifications

13.1 Physical Characteristics:

- Weight: < 2 lb.
- Size: 3.3" wide x 2" high x 6.8" long
- RF Antenna Connector: 50 Ohm TNC
- Serial Interface: RS232 DB-9F

13.2 Power Specifications:

- Advanced Power Management features
- Input Voltage: 10 VDC to 28 VDC
- Input Current: 20 mA to 600 mA
- Typical Transmit/Receive: 300ma at 12VDC
- Dormant connection [idle for 10-20 seconds] 150 ma at 12 VDC
- Low power mode: 20 mA at 12 VDC

13.3 Environmental:

- Operating ranges: -30°C to +75°C*
- (<10%duty cycle limit above 60 °C)
- Humidity: 5%-95%Non-condensing

A thermistor inside the modem (monitored by the modem CPU firmware) causes flow control to be activated should the internal temperature reach 75°C (167°F) as measured at the radio. Flow control is released when the temperature falls below 75. Should the temperature of the radio reach 80°C (176°F), the modem terminates the connection in order to protect components and avoid drifting outside radio specifications.

13.4 Status LED Display:

- Channel [Chan] LED
Flashing = Searching for a channel
On = Found a channel
- Link LED
Off = No 1x or CDMA service
On = 1x or CDMA service is available on this channel
- Registration (REG) LED:
Off = No PPP link
On = PPP link is established and have an IP address.
- Transmit (TX) LED:
Off = Not transmitting
On = Transmitting (on RF)
- Receive (RX) LED:
Off = No incoming data
On = Receive data (on host)
- GPS LED
Off = No GPS fix
On = Have GPS fix
- Power (PWR):
Off = Power off
On = Power on

13.5 RF Features:

- 224 mW RF output (+23.5 dBm)
- Full duplex transceiver
- Dual-band support for both 800 MHz cellular and 1.9 GHz PCS bands
- Data rates up to 153.6 kbps (forward channel) and 76.8 kbps (reverse channel)

13.6 Application Interface Features:

- RS232, 1200 bps to 115.2 kbps
- AT Commands, PPP, SLIP, UDP, TCP

13.7 CDMA and Cellular Standards:

- Adheres to CDMA authentication as specified in CDMA2000 1X
- CDMA2000 1X Release 0 (plus ballot resolution version of addendum)
- CDG1, 2, and 3 for CDMA2000 1X
- IS-95B: Mobile Station-Base Station Compatibility
- Standard for Wideband Spread Spectrum Cellular Systems
- IS-98C and D: Recommended Minimum Performance
- Standards for Dual-Mode Spread Spectrum Mobile Stations
- Telecommunications Systems Bulletin (TSB2000): Capabilities Requirements Mapping for CDMA2000 Standards (TIA/EIA/TSB2000)

13.8 GPS Module

- Model: U-Blox TIM-CJ
- L1 Frequency 1575.42 MHz
- 12 Channels
- Active GPS Antenna 5V

Free Manuals Download Website

<http://myh66.com>

<http://usermanuals.us>

<http://www.somanuals.com>

<http://www.4manuals.cc>

<http://www.manual-lib.com>

<http://www.404manual.com>

<http://www.luxmanual.com>

<http://aubethermostatmanual.com>

Golf course search by state

<http://golfingnear.com>

Email search by domain

<http://emailbydomain.com>

Auto manuals search

<http://auto.somanuals.com>

TV manuals search

<http://tv.somanuals.com>