

AIRSTREAM

A TRAILERING GUIDE

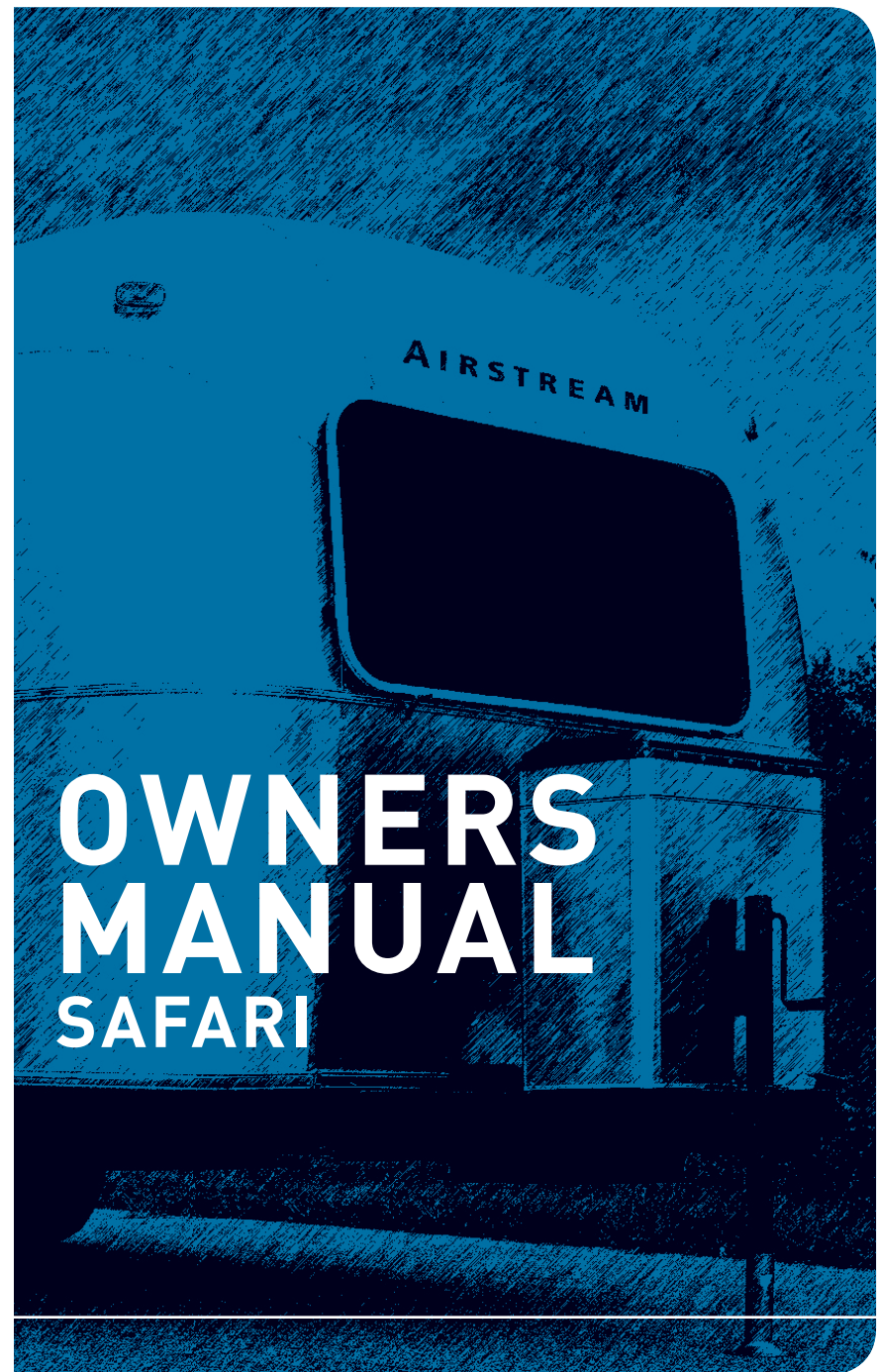



The Owners Manual for your new Airstream trailer is designed to respond to the most frequent inquiries regarding the operation, function and care of the many systems that make modern trailering a joy.

Airstream realizes our customers possess varying degrees of expertise in the area of repairing and maintaining the appliances in their trailer. For this reason, the service and trouble-shooting information found in this manual is directed toward those with average mechanical skills. We also realize you may be more familiar in one area than you are in another. Only you know your capabilities and limitations.

We want you to use this manual, and hope you will find the information contained in it useful, however, should you ever feel you may be "getting in over your head" please see your dealer to have the repairs made.

A brief explanation of the operation of the appliances such as refrigerator, furnace, water heater and others are explained in this manual. However, you will also find the manufacturer's information supplied in a packet included with this manual.

All information, illustrations and specifications contained in the literature are based on the latest product information available at the time of publication approval.

Throughout this manual **CAUTION** and  **WARNING** notations are used.

Failure to observe  **WARNING** notations can cause personal injury and/or possible fatal injury if not observed.

Failure to observe **CAUTION** notations can damage equipment and/or personal property.

TABLE OF CONTENTS

A. WARRANTY AND SERVICE

Warranty
Warranty Explanation
Service
Reporting Safety Defects
Maintenance Schedule
Maintenance Parts & Supplies

B. TOWING

Tow Vehicles
Brakes
Loading
Weighing
Hitching Up
Towing Tips
Pre-Travel Check List

C. CAMPING

Camping Safety
Overnight Stop
Extended Stay
Leveling & Stabilizing
Hook Ups
Winter Traveling

D. EXTERIOR

Cleaning
Chassis
Power Jack
Tires
Axle and Running Gear
Electric Brakes

E. INTERIOR FURNISHINGS AND ACCESSORIES

Fabric Care
Lounges & Tables
Bathroom Exhaust
Features & Fixtures
Storage Areas
Smoke Alarm
Gas Detector
Fire Extinguisher
Exterior Windows

F. PLUMBING

LP (Liquid Petroleum) Gas
Water
Winterizing
Drain and Waste
Toilet
Faucet, Moen Puretouch

G. ELECTRICAL

12-Volt Distribution Panel
Battery
Converter
12-Volt System & Components
TV Antenna
Satellite Antenna
Solar Panel
110-Volt System & Components
110-Volt Diagrams

F. APPLIANCES

Air Conditioner
Furnace
Range/Oven
Microwave
Refrigerator
Water Heater
High Volume Fan

I. SPECIFICATIONS

WARRANTY AND SERVICE

WARRANTY COVERAGE

When you buy a new Airstream Travel Trailer from an authorized Airstream dealer, Airstream, Inc., warrants the trailer from defects in material and workmanship as follows:

BASIC WARRANTY PERIOD

This warranty extends for a period of two years from the date of original retail purchase.

ITEMS COVERED

Any part of the trailer or any component equipment installed by the factory is covered by the basic warranty *except* the following items, which are *not covered*:

- Tires
- Batteries

The tire and battery warranties will be handled by their respective service points and according to their written policy. This limited warranty does not include failure caused by accident, abuse, normal wear, overload or any cause not attributable to a defect in original material or workmanship of the trailer or component equipment as installed by the factory.

LIMITATION OF IMPLIED WARRANTIES

All warranties of merchantability and fitness for a particular purpose, whether written or oral, expressed or implied, shall extend only for a period of two years from the date of original purchase. There are no other warranties, which extend beyond those described on the face hereof and which expressly excludes conditions resulting from normal wear, accident, abuse, exposure or overload. Some states do not allow limitation on how long an implied warranty lasts, so the above limitations may not apply to you.

AIRSTREAM'S RESPONSIBILITY

The basic **Airstream Limited Warranty** applies for a period of two years from the date of original purchase, and the application date of all warranties is that indicated on the owner's Limited Warranty. Defects in items covered under this Warranty will be corrected without cost upon the return, at the owner's expense, of the trailer or defective part to an authorized Airstream dealer.

CARE AND MAINTENANCE

This warranty covers only defective material and/or workmanship; adjustments are made at the factory prior to shipment, and rechecked by the dealer prior to delivery to the customer. Adjustments thereafter become a customer responsibility.

Each Airstream exterior (not including the underside) is clear coated to prevent oxidation. This application is covered by a two-year warranty against peeling. Prolonged exposure to salt air or industrial fall-out will permit penetration through the coating material, causing damage to the exterior finish. Since Airstream, Inc., has no control over these conditions, it is necessary for the owner to wash and maintain their trailer as instructed in the Owner's Manual.

The owner is also responsible for following all recommendations, instructions and precautions contained in the Airstream Trailer Owner's Manual and the individual manuals furnished by the chassis, appliance and other manufacturers.

WARRANTY AND SERVICE



INSTALLATIONS NOT COVERED

Airstream, Inc., does not accept any responsibility in connection with any of its trailers for additional equipment or accessories installed at any dealership or other place of business, or by any other party. Such installation of equipment or accessories by any other party will not be covered by the terms of this warranty.

IF REPAIRS ARE NEEDED

If your trailer needs repairs under the terms of the basic Airstream Limited Warranty, you should:

1. Take your trailer to your selling dealer or other Authorized Airstream Dealer.
2. If the dealer is incapable of making the repair, request that he contact the Service Administration Department at Airstream, Inc., for technical assistance.
3. If repairs are still not made, the customer should contact:

AIRSTREAM, INC.

419 W. Pike Street - P.O. Box 629
Jackson Center, Ohio 45334-0629

Attention: Owner Relations Department

Furnish the following information:

- The complete serial number of the trailer
- Date of original purchase
- Selling dealer
- Nature of service problem and steps or service, which have been performed.
(The owner may be directed to another dealer at the owner's expense.)

4. If, after taking the above steps, repairs are still not complete, the Airstream owner may request the trailer to be brought to the Factory Service Center at the owner's expense.

WARRANTY AND SERVICE

DEALER REPRESENTATION EXCLUDED

The full extent of the basic **Airstream Limited Warranty** is set forth in detail in the folder, and in the explanation of the basic **Airstream Limited Warranty** covered in the Airstream Trailer Owner's Manual. Airstream Inc. will not be responsible for additional representations or implied warranties made by any of its dealers to the extent those representations are not a part of, or are contrary to, the terms and conditions of the basic Airstream Limited Warranty.

CONSEQUENTIAL AND INCIDENTAL DAMAGES

Airstream, Inc., will not be responsible for any consequential or incidental expenses or damages resulting from a defect. Incidental expenses include, but are not limited to: travel expenses, gasoline, oil, lodging, meals, telephone tolls, and loss of work and loss of use of the trailer. Some examples of consequential damages would be: stained curtains due to rain leaks or delaminated floor caused by a plumbing leak. Some states do not allow the exclusion or limitation of incidental or consequential damages, so the above limitation or exclusion may not apply to you.

WARRANTY TRANSFER

The basic **Airstream Limited Warranty** is transferable to subsequent owners for the duration of the warranty period. Warranty transfer application forms are available from your dealer or the Airstream Inc. Service Administration Department.

CHANGES IN DESIGN

Airstream Inc. reserves the right to make changes in design and improvements upon its product without imposing any obligation upon itself to install the same upon its products theretofore manufactured.

This warranty gives you specific legal rights, and you may also have other rights, which vary from state to state.

EXPLANATION OF AIRSTREAM LIMITED WARRANTY

The Airstream Limited Warranty is detailed on your warranty document.. It is filled out by the dealer and presented to the owner during delivery of a new unit. The Limited Warranty must be presented to a dealer to obtain warranty service. It should be kept in the trailer during the warranty period.

EXCLUSIONS:

Normal Wear

Items such as tires, water purifier packs, curtains, upholstery, floor coverings, window, door and vent seals will show wear or may even wear out within the two year warranty period depending upon the amount of usage, weather, and atmospheric conditions.

Accident

We strongly urge our dealers and customers to inspect the trailer upon receipt of delivery for any damage caused by accident while being delivered to the dealer, or while it is on the dealer's lot. Damage of this nature becomes the dealer or customer's responsibility upon acceptance of delivery, unless Airstream is notified and the person making the delivery verifies the damage. Glass breakage, whether obviously struck or mysterious, is always accidental and covered by most insurance policies.

WARRANTY AND SERVICE

Abuse

Lack of customer care and/or improper maintenance will result in early failure for which Airstream cannot be held responsible.

Exposure

Not unlike a car, the steel parts of a trailer can and will rust if subjected to prolonged exposure to moisture, salt, air, or corrosive air-borne pollutants without repainting. Aluminum oxidizes when unprotected under similar conditions, and refinery chemicals of a sulfurous nature are harmful to finishes if not washed off periodically. Extremely hot or direct sunlight will deteriorate rubber and fade curtains and upholstery. Conditions of this nature, although they may be normal for the area, are beyond Airstream's control and become the responsibility of the owner.

It is the responsibility of the owner to take such preventative measures as are necessary to maintain the exterior caulking and sealer of your unit. It is the responsibility of the owner to use reasonable, prudent care to prevent foreseeable secondary damage from rain, plumbing leaks, and the natural accumulation of moisture in your unit, such as a delaminated floor, stained upholstery, carpeting, or drapes, mold formation and growth, furniture damage, etc. Mold is a natural growth given certain environmental conditions and is not covered by the terms of the Limited Warranty.

Overload

Damage due to loading, either beyond capacity or to cause improper towing because of improper balance, is beyond Airstream's responsibility. The Airstream trailer is engineered to properly handle the gross vehicle load rating on the certification label. Load distribution has a definite effect upon the towing characteristics and attitudes of the trailer. Level hitch installations are a necessity, and very important on a tandem axle trailer. There are limits to the amount of load that can be safely transported depending upon speed and road conditions, and reasonable cause to believe these

factors have been exceeded could void the Airstream warranty. For additional information on the loading of your trailer, consult your Owner's Manual or gross vehicle weight rating plate.

The Airstream axle is manufactured to a tolerance of 0-1½° camber and 0-1/8" toe-in. These tolerances will only change if the trailer is subjected to abuse, such as dropping off a sharp berm, striking a curb, or hitting a deep hole in the road. Such damage could be considered as resulting from an accident which risks are not covered under the warranty. Abnormal tire wear and/or wheel alignment resulting from such damage is not covered under the terms of the warranty.



WARRANTY AND SERVICE

SERVICE

Before leaving the factory, each and every vital part of the trailer is tested for performance. Each test is signed and certified by an inspector. After the trailer arrives on your dealer's lot all of these vital parts and systems are again tested. When you take delivery of your new trailer you will receive a complete check out.

At that time a specified list of performance checks on your trailer equipment will be conducted and any deficiencies you have experienced since taking delivery will be corrected.

Please contact your dealer if you need service. Major service under your Airstream Limited Warranty is available through our nationwide network of Airstream Dealer Service Centers. An up-to-date list of Dealer Service Centers has been provided with your new trailer. This list is current as of the date of this publication.

Occasionally dealerships change, or new dealers are added who may not appear on this list. For this reason, it is suggested that you contact your local dealer from time to time and bring your list up to date. He can also provide you with additional copies if you need them. An up to date list is also available on WWW.AIRSTREAM.COM. ALL CENTERS OPERATE ON AN APPOINTMENT BASIS FOR THE UTMOST EFFICIENCY.

When you require service from the Airstream Factory Service Center, or a Certified Dealer Service Center, please contact the service manager for an appointment, and kindly inform him if you are unable to keep the appointment date or wish to change it.

Service may be arranged at the Factory Service Center by contacting the Service Coordinator at

Airstream Factory Service Center

P.O. Box 629

419 W. Pike Street

Jackson Center, Ohio 45334-0629

937-596-6111

REPORTING SAFETY DEFECTS

If you believe that your vehicle has a defect, which could cause a crash or could cause injury or death, you should immediately inform the National Highway Traffic Safety Administration (NHTSA) in addition to notifying Airstream, Inc.

If NHTSA receives similar complaints, it may open an investigation, and if it finds that a safety defect exists in a group of vehicles, it may order a recall and remedy campaign. However, NHTSA cannot become involved in individual problems between you, your dealer, or Airstream, Inc.

To contact NHTSA you may either call the Auto Safety Hotline toll-free at 1-888-327-4236 (TTY 1-800-424-9153) or write to: NHTSA, 400 Seventh ST, S.W., Washington, D.C. 20590.

You can also obtain other information about motor vehicle safety from the Hotline or view the NHTSA Website: www.safercar.gov

WARRANTY AND SERVICE



MAINTENANCE SCHEDULE



WARNING: FAILURE TO MAINTAIN YOUR COACH CAN CAUSE PREMATURE AND UNEXPECTED PARTS BREAKAGE AND/OR ERRATIC OPERATION THAT MAY BE HAZARDOUS.

Note: See appliance manufacturer's literature for further information.

EVERY 1,000 MILES OR 60 DAYS

Escape Window	Check operation of latches and upper hinge.
*Battery	Check water level , lead acid only
Smoke Alarm	Test and replace battery as required
Tires	Check tire pressure (See Specifications)),
Hitch	Check for loose bolts or unusual wear.
GFI Circuit Breaker	Test and record.



WARNING: WHEEL SEPARATION CAN OCCUR

1. On first trip, tighten wheel lugs at start and at 10, 25, and 50 miles.
2. Thereafter, check wheel lugs before each trip.
3. Following winter storage, check before beginning a trip.
4. Following excessive braking, inspect wheel lugs

Torque aluminum wheels to 110-120 ft. lbs. and steel wheels to 95 ft. lbs.

EVERY 5,000 MILES OR 90 DAYS

Exterior Door locks	Lubricate with dry graphite
Exterior Hinges	Lubricate with light household oil
LPG Hold Down	Lubricate with light household oil
LPG Regulator	Check bottom vent for obstructions
Main Door Striker Pocket	Coat with paraffin.
Wheel Lug Nuts	Torque aluminum wheels to 110-120 ft. lbs and steel wheels to 95 ft. lbs.
Break Away Switch	Pull pin and lubricate with household oil
7-Way Plug	Spray with contact cleaner.
Hitch Ball Latch	Lubricate with non-detergent motor oil
Hitch Ball	Lubricate with hitch ball lube or wheel bearing grease.
Range Exhaust Hood	Clean fan blades and wash filter.
Roof Vent Elevator Screws	Lubricate with light household oil
Main Door Step	Lubricate moving parts and check.

* As a battery ages and becomes less efficient, the water level should be checked at more frequent levels. Checking water level does not apply to Glass Mat Batteries.

WARRANTY AND SERVICE



EVERY 10, 000 MILES OR 6 MONTHS

Brakes	Inspect, adjust, or replace as necessary
Wheel Bearings	Clean and repack
Tires	Inspect and rotate
Spare Tire Carrier	Lubricate moving parts.
Seals, Windows, & Door	Clean with mild detergent and coat with "Slipicone".
TV Antenna	Lubricate all moving parts with silicone lubricant.
Exterior	Wax
Escape Window	Lubricate latches with WD-40 or light household oil.

EVERY YEAR

Battery	Clean, neutralize, and coat terminals with petroleum jelly
A-Frame, Step	Wire brush and paint frame at front and rear.
LP Bottles	Have purged by LP supplier.
Seams	Check and reseal exterior seams, windows, lights, and vents as needed.
Hitch Coupler and Ball	Check for wear or damage. Assure all parts operate freely. Replace any component if worn or damaged.

WARRANTY AND SERVICE

SUGGESTED MAINTENANCE PARTS AND LUBRICANTS

BULBS, EXTERIOR

License Plate	# 53
Clearance Light	#67
Door Light	#1003
Convenience Light (Dump Valve)	# 53

Trailers have an LED tail light system that uses no bulbs.

BULBS, INTERIOR

Ceiling Light (Incandescent)	#1141
Wardrobe Light & Dinette Light	#561
Wall Light	#1076
Reading Light	#TY-67



WARNING: Always replace the light bulb on an interior or exterior light fixture with the correct bulb for that light. Failure to heed this warning could cause fire, property damage, personal injury, or death.

MISCELLANEOUS

Water Hose Gaskets

Wheel Bearing Grease

Extra Hair Pin Clips for Hitch

Grease Seals

Dry Graphite

WD-40 or Equivalent Aerosol Lubricant

Oil Can with 30 Weight Non-Detergent Oil

Silicone Lubricant

Light Household Type Oil

Spray Contact Cleaner

Hitch Ball Lube (May use wheel bearing grease.)

Exterior Sealer



WARRANTY AND SERVICE



MAINTENANCE RECORD

DATE	DEALER	SERVICE PERFORMED

DATE	DEALER	SERVICE PERFORMED

WARRANTY AND SERVICE

NOTES

A

TOWING YOUR AIRSTREAM

TOW VEHICLE EQUIPMENT

If you plan to buy a new vehicle to tow your trailer we suggest that you include in your purchase the towing options offered by most tow vehicle manufacturers. These include such things as a heavy-duty alternator and radiator, heavy-duty springs (See Note:) and shock absorbers, transmission cooler, heavy-duty fan and flasher unit and others, depending upon the make of the vehicle.

Transmissions may be manual or automatic, but an automatic transmission may prolong your tow vehicle's life and generally does a better job of controlling engine loads than the average driver using a manual shift.

Having adequate power is very important when considering the purchase of a new vehicle or the trailer towing capability of your present one. American manufacturers realize more than 30% of the vehicles they sell will be used for towing some type of trailer. The dealers are provided with guidelines to use when helping a customer decide on a tow vehicle. The guidelines are not just determined by the power output of the engine. The gear ratio of the differential is also a very important part of the guideline.

7-way Plug Diagram

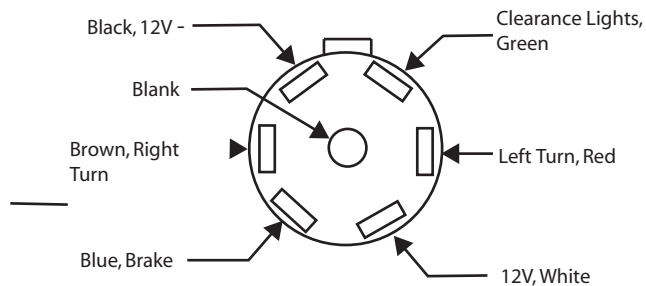

Inspect the tow vehicle's hitch regularly for loose bolts or nuts, cracked welds, loose ball mounts, worn parts, etc.

New trailerists often carry more food and other supplies than really needed. Remember that every item you take along is one more thing to stow and adds weight to the total load you must pull. Consolidate items in shelves, lockers, and in the refrigerator. It is better to have one full and one empty locker, than two half empty ones. Special care must be taken not to overload the front and rear ends of the trailer.

NOTE: Be realistic when ordering heavy duty springs. Only springs heavy enough to support your loaded vehicle (not including trailer) are necessary. Too harsh of spring rate will only shorten the life of the tow vehicle and trailer, and will make your journeys less enjoyable.

! WARNING: Too stiff of springs can hinder the action of the weight equalizing hitch and prevent the transfer of weight to the front of the vehicle.

TOWING YOUR AIRSTREAM

ELECTRIC BRAKES

The brakes are operated by 12 volt current from your tow vehicle and **MUST BE HOOKED UP SO THAT YOU HAVE AN INTEGRAL SYSTEM WITH YOUR TOW VEHICLE BRAKES.** To prevent problems and insure satisfactory braking action, install an electronic controller in line with the brakes in your tow vehicle.

An electronic controller installed in your tow vehicle will synchronize the trailer brakes with your tow vehicle brakes. It is designed to apply the trailer brakes with your tow vehicle brakes.

Your brake controller should be adjusted to provide for a slight lead of the trailer brakes over the tow vehicle brakes. Follow the directions provided with your controller and keep the information for future reference. Don't be afraid to ask questions! If you don't understand the directions, have the installer explain the procedures.

Due to normal brake lining wear, the brakes and the controller setting should be checked and readjusted, if necessary, during the trailer manufacturer's recommended inspection intervals.

Note: Brake lining adjustment should be periodically checked (fully) to be sure trailer brakes are in the same adjustment as the tow vehicles.

Properly set these adjustments will provide for safe comfortable stops. They will also help assure optimum brake and tire life for both the tow vehicle and the trailer.

In THE EVENT OF AN ACCIDENTAL SEPARATION of the tow vehicle and the trailer, the BREAK-AWAY SWITCH will set and lock the trailer brakes for a sufficient length of time to stop the trailer. The switch is activated when the wire attached to it and to the tow vehicle pulls out the small pin in the front of the unit. **THIS PIN SHOULD BE PULLED OUT, LUBRICATED WITH LIGHT HOUSEHOLD OIL, AND REPLACED EVERY 90 DAYS.**

To prevent corrosion within the breakaway switch, pull the switch's pin straight forward and spray the inside of the switch through the hole with an electric contact cleaner (such as Spra- Kleen) and reinsert pin. A drop of light household oil on the groove near the base of the pin will allow the pin to operate freely. **WHEN THE TRAILER IS CONNECTED TO THE TOW VEHICLE, THE BREAKAWAY SWITCH LOOP SHOULD BE ATTACHED TO THE PERMANENT FRAME OF YOUR HITCH.** When disconnecting the trailer from the tow vehicle remove wire loop from the frame. **DO NOT REMOVE THE PIN FROM THE SWITCH BECAUSE THIS WILL APPLY THE TRAILER BRAKES.**

CAUTION: Do not use breakaway switch for parking brake.

A large, bold, white letter 'B' is centered within a dark gray rounded rectangular background.

TOWING YOUR AIRSTREAM

LOADING

The table on this page is a sample of the weight information chart provided in all Airstream vehicles. The table lists weight and loading information specific to your trailer. This information can be found in your vehicle on the back of the first wardrobe door on the curbside of the vehicle about 60" up from the floor.

When loading heavy objects such as tools, skillets, irons, and boxes of canned goods, etc. keep them as low as possible - preferably on the floor. Try to hold additional weight behind the axle to a minimum.

B

TRAILER WEIGHT INFORMATION

VIN OR SERIAL NUMBER

GVWR (GROSS VEHICULAR WEIGHT RATING) IS THE MAXIMUM WEIGHT OF THIS TRAILER WHEN FULLY LOADED. IT INCLUDES ALL WEIGHT AT THE TRAILER AXLE(S), AND TOUGUE OR PIN.

UVW (UNLOADED VEHICLE WEIGHT), IS THE WEIGHT OF THIS TRAILER AS MANUFACTURED AT THE FACTORY. IT INCLUDES ALL WEIGHT AT THE TRAILER AXLE (S) AND TOUGUE OR PIN. IF APPLICABLE, IT ALSO INCLUDES FULL GERNERATOR FLUIDS, INCLUDING FUEL, ENGINE OIL, AND COOLANTS.

CCC (CARGO CARRYING CAPACITY) IS EQUAL TO GVWR MINUS EACH OF THE FOLLOWING: UVW, FULL FRESH (POTABLE) WATER WEIGHT, (INCLUDING WATER HEATER, FULL PROPANE WEIGHT.

CARGO CARRYING CAPACITY (CCC) COMPUTATION	POUNDS	KILOGRAMS
GVWR.....		
MINUS UVW.....		
MINUS FRESH WATER WEIGHT OF GALLONS @ 8.3 LB/GAL		
MINUS PROPANE WEIGHT OF GALLONS @ 4.2 LB/GAL		
*CCC FOR THIS TRAILER.....		

*DEALER INSTALLED EQUIPMENT WILL REDUCE CCC

CONSULT OWNER MANUAL (S) FOR SPECIFIC WEIGHING INSTRUCTIONS AND TOWING GUIDELINES

CD-133

See specification section in this manual for definition and weight pertaining to this label.

TOWING YOUR AIRSTREAM

WEIGHING YOUR TRAILER

The diagrams show how to weigh the trailer on scales.

The allowable personal cargo must be distributed in your trailer in such a manner that the Gross Axle Weight Rating is not exceeded.

To determine this, it is necessary to load all of your allowable personal cargo and variable weights. Then hitch the trailer to the tow vehicle with load equalizing hitch properly adjusted as shown on the following pages.

Place the trailer on a scale with both axles only on the scale (see illustration). If the weight on the axles exceeds the axle system G.A.W.R. then some of the personal cargo must be redistributed forward in order to place some of this weight on the tongue.

The tongue weight should be in between 10% - 15% of the trailer's total weight, and must not exceed the tow vehicle's or the hitch's maximum weight rating. To determine tongue load, unhitch tow vehicle and place the tongue hitch post on a scale. The trailer must be properly loaded as determined above, with your allowable personal cargo and variable weights.

Use a scale, such as a bathroom scale, that has a lower weight limit than your tongue load, to check the tongue weight by using the following method (see illustration).

Place a piece of wood of approximately the same thickness as the bathroom scales on the ground in line with the trailer hitch jack as shown. It should be so spaced that a short piece of pipe or other round piece will lay exactly one foot from the centerline of the jack extension.

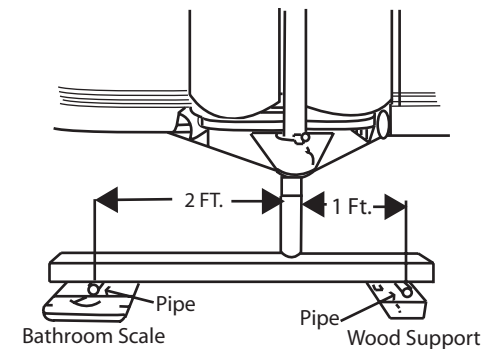

Place the scales so that another round piece can be exactly two feet from the centerline of the jack extension in the other direction. Place a 4 x 4 on the two round pieces and screw the jack extension down on the top of the 4 x 4 until the tongue of the trailer is supported by it. Multiply the scale reading by three. This will be the tongue weight of your trailer. If you exceed the capacity of the bathroom scales, increase the two-foot dimension to three or four more feet, but always multiply the scale reading by the total number of feet between the wood and scales.

CAUTION: Be sure trailer is level when you read scales.



1. Trailer's Total Weight
(cannot exceed GVWR)

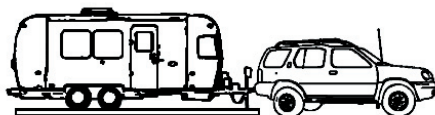

2. Trailer's Weight on Axel Assemblies
(cannot exceed GVWR)

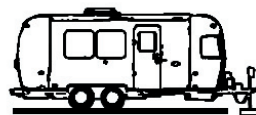

3. Weight on Trailer's Tongue

TOWING YOUR AIRSTREAM

HITCHING UP

Percentage of Tongue Load
distributed to car and or trailer wheels

Proper installation

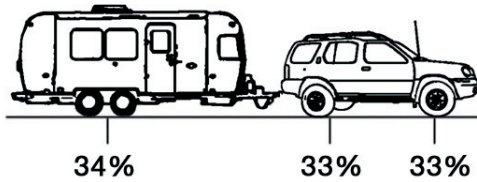

Hitch Low

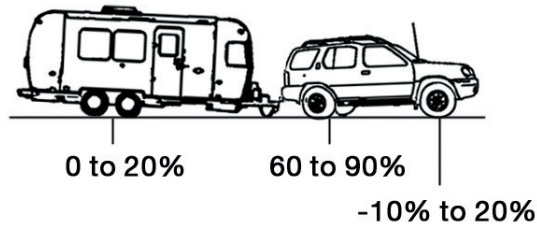

Hitch High

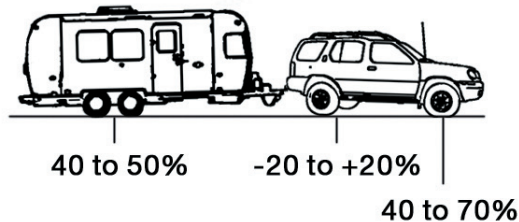

Hitching up your trailer is something that will become almost second nature with practice. The following section includes proper hitch load distribution. Proper training on connecting your trailer to a tow vehicle is essential for safety. Please see your dealer

or other qualified personnel for instruction on the proper hitching of your trailer.

Equalizing Hitch Load Distribution

When a trailer is hitched up properly to a tow vehicle with a load equalizing hitch, approximately 1/3 of the trailer's tongue weight will be on the trailer's axles and 2/3 will be transferred to the tow vehicle, 1/3 of this weight transfer will be carried by the front wheels and 1/3 by the rear wheels of the tow vehicle (See diagram), Thus, the tire load of each wheel on the tow vehicle will be increased by 1/6 of the trailer's tongue weight. The tire air pressure of the tow vehicle should be increased to compensate for this additional weight. Refer to the vehicle's owner's manual for this information.

 **WARNING:** The tongue weight should be approximately 10% of the trailer's total weight, but **MUST NOT EXCEED 1,000 lbs.** And, under no condition should it exceed the hitch rating. Your hitch installer should provide your hitch rating information.

Sway Control Device

Although Airstream has not intruded into the hitch manufacturers field of expertise and performed formal testing, we find the vast majority of Airstream owner's purchases sway-control devices.

When passed by large trucks or when exposed to sudden crosswinds the trailer will be "pushed" and this action will be felt in the tow vehicle. It's our understanding the sway control devices will reduce the amount of movement and make towing more comfortable and add some safety. Follow the directions of the sway control manufacturer when having it installed and using it.

TOWING YOUR AIRSTREAM

TOWING TIPS

We want every owner to be a safe and courteous driver. A few hours of towing practice in a large empty supermarket lot will make pulling your trailer over the road much easier. Line out two corners for left and right turns. You may also use these corners to practice backing and parking.

OBSERVE THAT THE TRACKS MADE BY THE TRAILER WHEELS ARE DISTINCTLY DIFFERENT FROM THOSE MADE BY THE TOW VEHICLE. Studying this will make it easier for you to correct mistakes. Truck or trailer type fender or door grip rear view mirrors are a must for maximum visibility and in most states the law requires them.

After thoroughly inspecting your hitch, brakes, and tires you should be ready to tow. Check traffic, signal that you are about to pull away, and start slowly. Look often in your mirrors, and observe the action of the trailer, then carefully move into the proper lane of traffic. Remember that the trailer wheels will not follow the path of the tow vehicle wheels; therefore, WIDER TURNS ARE NECESSARY WHEN TURNING TO THE LEFT OR TO THE RIGHT.

The BRAKE CONTROLLER is activated when you apply the brakes of the tow vehicle. Your tow vehicle brakes will automatically apply the trailer brakes first when properly adjusted. This will help keep your tow vehicle and trailer in a straight line and make you stop as if you were driving the tow vehicle alone. If swaying or swerving should occur, briefly operating the controller separate from the vehicle brakes may help correct the situation. Practice this maneuver on a clear highway or deserted parking lot. Don't wait for an emergency then grope for the controller.

When trailering you might encounter a temporary cooling system overload during severe conditions, such as hot days when pulling on a long grade, when slowing down after higher speed driving, or driving long idle periods in traffic jams. If the hot indicator light comes on, or the temperature gauge indicates overheating and you have your air conditioner turned on, turn it off. Pull over in a safe place and put on your emergency

brake. Don't turn off the engine. Increase the engine idle speed. Lift the engine hood and check for fluid leaks at the radiator overflow outlet. Check to see that all drive belts are intact and the radiator fan is turning. If you have a problem have it fixed at the next opportunity. If there is no problem the light should go off or temperature should come down within one minute. Proceed on the highway a little slower. Ten minutes later resume normal driving.



WARNING: Never open a radiator cap when the tow vehicle is hot. Check the coolant level when the vehicle is cool.

When going downhill in dry weather, down shift so that engine compression will slow the whole rig down. Take dips and depressions in the road slowly and do not resume normal driving speeds until you are sure that the trailer wheels are clear of the dip.



WARNING: On slippery pavement do not use engine drag to help slow down as this may cause the rear wheels of the tow vehicle to skid. On icy pavement drive slowly and if you feel the tow vehicle skidding gently apply the trailer brakes only. This will bring the tow vehicle and trailer back into a single line. Chains do not help trailer wheels.

When driving in mud and sand let the momentum carry the rig through. Apply power gently and use as little as possible. Stay in the tracks of the vehicle ahead and keep the tow vehicle in the highest possible gear. If you get stuck it is best to tow out the entire rig together without unhitching.

Despite the best hitch you will notice that whenever a large bus or truck overtakes your rig the displaced air first pushes the trailer rear slightly to the right and then affects the front. It may be necessary to steer very slightly, momentarily, toward the bus or truck to help compensate for the sway induced by the passing-vehicle. Do not apply the vehicle brakes, as this can tend to exaggerate the situation. You may find, however, that briefly

B

TOWING YOUR AIRSTREAM

applying the trailer brakes with your manual control will help eliminate sway.



WARNING: CHOCK THE TRAILER WHEELS when stopping on a hill or slope. Leaving your tow vehicle in gear is not enough for standstill safety. Do not use trailer brakes as parking brakes.

Tracking

On a two-lane road cars will be lining up behind you because you travel at a lower speed. It is both courteous and sensible to signal, pull onto the shoulder, and let them pass. Your trailer is designed to be towed easily at any legal speed, so if you are not careful you may be inclined to forget it is there.

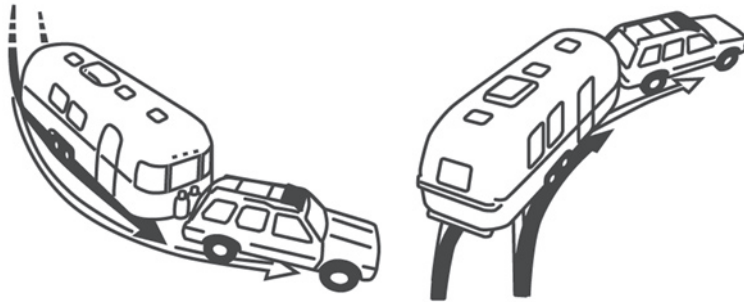

Passing

ON FREEWAYS OR EXPRESSWAYS try to pick the lane you want and stay in it. Always maintain plenty of space between you and the car ahead, at least the length of the tow vehicle plus trailer for every ten miles per hour. Remember that in order to pass another vehicle you will need longer to accelerate. You must also allow for the length of the trailer when returning to the right hand lane.

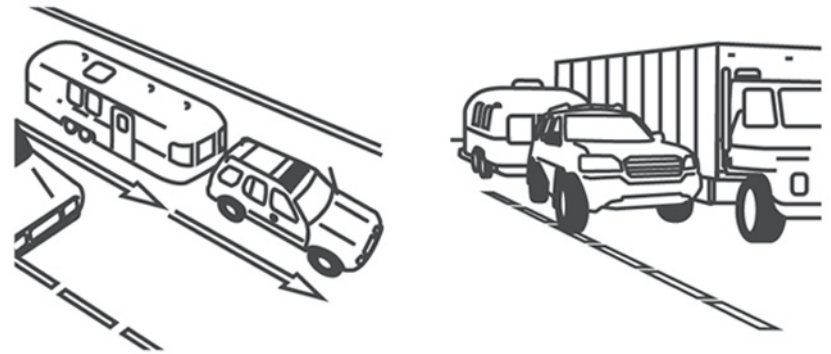

TOWING YOUR AIRSTREAM

Backing Up

In BACKING UP the important thing to remember is to DO EVERYTHING SLOWLY and to correct immediately if you see the trailer turning the wrong way. Concentrate on the rear of the trailer. With your tow vehicle and trailer in a straight line back up slowly and turn the bottom of the steering wheel in the direction you want the trailer to go. Watch out the window or in the mirror until the rear of the trailer is pointing in the desired direction. Your tow vehicle will be following the trailer in an arc. Straighten the tow vehicle and trailer by turning the steering wheel more sharply, and then when they are in line, straighten the steering wheel.

ALWAYS TRY TO BACK TO YOUR LEFT BECAUSE THE VISIBILITY IS MUCH BETTER.
(See Illustration) When you don't make it on the first try it is usually much easier to pull

forward to your original position and start over.

If your spouse or traveling companion normally directs you when backing they should position themselves forward of the tow vehicle so the driver can easily see them. Their directions should always indicate to the driver the direction the rear of the trailer should go. A little practice in a parking lot with the person giving directions can save a lot of frustration when backing into a campsite.

BACKING UP

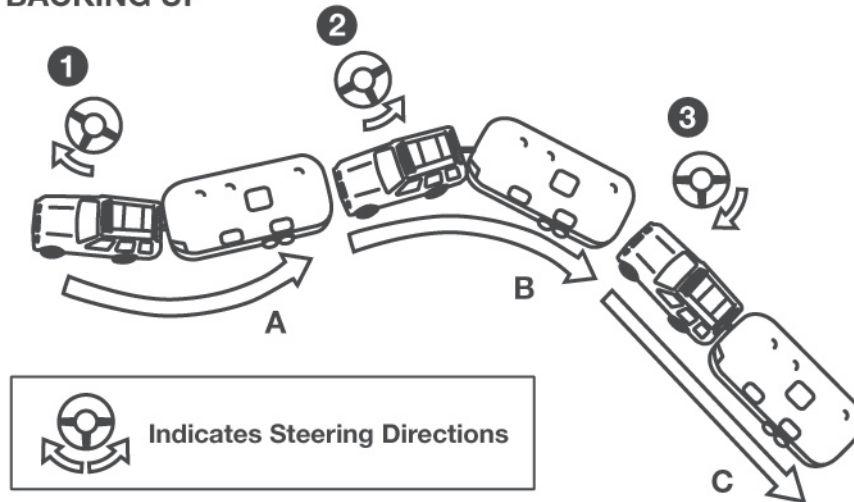

Position (A) start. Turn steering wheel as shown in (1) will put you in trailer Position (B). Turning steering wheel show in position (2) puts you in trailer position (C). Steering position (3) returns front wheels for straight backing.

TOWING YOUR AIRSTREAM

SUGGESTED PRE-TRAVEL CHECK LIST

Interior

- 
1. Turn off water pump switch
 2. Check battery water level
 3. Close windows and vents
 4. Lock all interior cabinet doors.
 5. Latch refrigerator door. (Seal containers first.)
 6. Hold down or stack securely all loose, hard and sharp objects
 7. Fasten sliding and foldette doors
 8. Drain toilet bowl,
 9. Turn off interior lights.
 10. Set table in upright position
 11. Pull up or retract step.
 12. Lower blinds.
 13. Secure and lock main door

Exterior

1. Disconnect and slow the electrical hookup cord, the sewer hookup hose (flush out), and the water hookup hose.
2. Turn off gas at LP tanks.
3. Retract stabilizing jacks.
4. Check Hitch: It must be properly attached.
5. Check safety chains and breakaway switch cable.
6. Fully retract jack. Remove and stow jack stand or wood block.
7. Check clearance and stoplights.
8. Check lug nuts.
9. Check tires for correct pressure.
10. Check that TV antenna is properly stowed.

11. Adjust tow vehicle mirrors.
12. Pull forward some 50 ft., test brakes, and check site for forgotten objects and cleanliness.

NOTICE! CHECK WHEEL LUGS

On first trip, tighten wheel lugs at start and at 10, 25, and 100 miles. Torque aluminum wheels to 110-120 ft. lbs. and steel wheels to 95 ft. lbs. There after, check wheel lugs before each trip, after excessive braking, and following winter storage.

Home

1. Leave house key with your neighbors
2. Valuables and important papers should be stored in a safe place.
3. Newspaper, milk and other deliveries should be discontinued.
4. Ask the Post Office to hold your mail for you
5. Arrange with the telephone company for discontinued or "vacation service"
6. Arrange care for your pets
7. Your lawn, garden and houseplants should be cared for.
8. Lock all windows and doors securely. Keep shades open for a lived in look
9. Cover all food to keep out mice and insects
10. Eliminate all fire hazards Place matches in a tin box or glass jar
11. Store oil, gasoline and other flammables properly.
12. Destroy all newspapers, magazines and oily rags.
13. Notify police.

TOWING YOUR AIRSTREAM

Trailer Equipment and Accessories

1. Water hose, 5/8 in. high pressure, tasteless, odorless, non-toxic, (2 -- 25 ft. sections).
2. "Y" connection -- water hose.
3. The sewer hose with clamp.
4. Drain cap with hose drain.
5. Holding tank cleaner and deodorizer.
6. Power cord adapter 30 --amp Capacity.
7. 50 ft. electric cord, 12-3 wire, 30-ampere capacity.
8. 25 ft. electric cord, 10-3, 30-ampere capacity.
9. Woodblocks for leveling.
10. Wheel chocks.
11. Hydraulic jacks.
12. Cross type lug wrench and a torque wrench.
13. Quality tire gauge.
14. Emergency road warning triangle.

Personal

1. Tow vehicle insurance to cover you and your family fully.
2. Avoiding cash. Use Travelers Checks and credit cards.
3. Confirmed reservations.
4. Have sunglasses, sun block, and insect repellent for everyone.
5. Pack camera and film.
6. Make a checklist of clothing for everyone, and toilet articles.

Motoring Essentials

1. Display the tow vehicle and trailer registration properly.
2. Carry drivers license.
3. In Canada you'll need a non-residence liability insurance card and your birth certificate.
4. In Mexico you must have special auto insurance.
5. Carry an extra set of the ignition and truck keys in a separate pocket, or in your wallet.
6. Keep an operating flashlight with fresh batteries in the glove compartment.
7. Pack the trunk so that you can reach the tools and spare tire without completely unpacking.
8. Keep sharp or hard articles securely packed wherever they may be.
9. Do not packed things in the passenger seating area. You need the maximum space for comfort.
10. WEAR easy wash, drip-dry traveling clothes.
11. Do not make your vacation trips a mileage marathon. Stop and relax frequently.
12. Carry a first-aid kit.
13. Carry your pets dish, food, leash, and health and registration papers.



TOWING YOUR AIRSTREAM

NOTES

B

SAFETY

As always, safety should be one of your top priorities. Make sure you, and everyone traveling with you, can operate the main door and exit window rapidly without light. Contemplate other means of escape in case the designated exits are blocked.

 **WARNING:** The escape windows(s) are identified by their red release handles. Lift up both latches to release the escape window. Push out on the glass and it will swing clear. The window operation should be checked each trip and the latches lubricated with WD-40 or equivalent every six months.

 **WARNING:** At each campsite make sure you have not parked in such a manner as to block the operation of the escape window by being too close to trees, fences or other impediments. Scenic views are one reason for traveling, but don't park so the beautiful lake or steep cliff is just outside your escape window.

 **WARNING:** Read the directions carefully on the fire extinguisher. If there is any doubt on the operation, you and your family should practice, then replace or recharge the extinguisher. You will find your local fire department will be happy to assist you and answer any questions.

 **WARNING:**

Don't smoke in bed.

Keep matches out of reach of small children!

Don't clean with flammable material!

Keep flammable material away from open flame!

We have all heard these warnings many times, but they are still among the leading causes of fires.

Other safety information on the LPG system of your trailer is located in the plumbing section of this manual.



CAMPING

OVERNIGHT STOP

Airstream owners have parked virtually every place imaginable from filling stations to farmlands. In time you'll develop a knack for spying wonderful little roadside locations by turning off the main highway and exploring.

There are many modern parks including State, County and Federal parks with good facilities where you might obtain hookups of electrical, water and sewer connections. Directories are published which describe in detail these parks and tell what is available in the way of services and hookups.

On overnight or weekend trips chances are you will not use up the capacity of the sewage holding tank, deplete the water supply, or rundown the batteries which supplies the 12 volt current.

On a longer trip, when you have stayed where sewer connections and utility hookups were not available, it will be necessary for you to stop from time to time to dispose of the waste in the holding tank and replenish the water supply. Many gas stations (chain and individually owned) have installed sanitary dumping stations for just this purpose. Booklets are available which list these dumping stations.

When stopping for the night, your Airstream is built to be safely parked in any spot that is relatively level and where the ground is firm. Your facilities are with you. You are self-contained. Unless the tow vehicle is needed for transportation, it is not necessary to unhitch.



WARNING: Do not park in a manner that would prevent the escape windows from opening.

Try to pick as level a parking spot as possible. Stabilizing jacks or blocks probably won't be required for an overnight stay unless you extend a slide out room. However, if you put the jack pad on the hitch jack and run the hitch jack down to take the weight

off the tow vehicle's springs it will provide some stability. If you must park on a slope, **PARK FACING DOWNHILL.** It is easier to level the trailer this way.

All you need to do to enjoy the self-contained luxury of your Airstream is to turn on the LP gas and light any appliances with pilots.

Before moving on, check your campsite both for cleanliness and also to be sure you haven't left anything behind. Turn off the gas supply and make sure everything is properly stowed. Use your PRE-TRAVEL CHECK LIST and you are ready for more travel adventure.

CAMPING

EXTENDED STAY

Making a long trip in your Airstream is not very different from making a weekend excursion. Since everything you need is right at hand, you are at home wherever you go. When packing for an extended trip, take everything you need, but only what you need.

When you plan to stay in the same place for several days, weeks or months, you will want your trailer to be as level and steady as possible. Check the attitude with a small spirit level set on the inside work counter or the trailer hitch "A-Frame". (See Diagram Below) If a correction is necessary then YOU MUST LEVEL FROM SIDE TO SIDE FIRST This can be done easily by backing the trailer up one or more 2" x 6" boards. (See Diagram) We do not recommend placing tires in a hole for leveling.

LEVEL FROM FRONT TO REAR by disconnecting the hitch from the tow vehicle, putting the jack pad under the hitch jack and adjusting the jack up or down until you are level. Block or chock the wheels to keep the trailer from rolling. Use STABILIZING JACKS at all four corners as shown in the diagram to eliminate the natural spring action of the axles.

Optional STABILIZING JACKS, whether manual or power, should only be used to stabilize trailer.

 **WARNING:** Whenever the trailer must be lifted with a jack, as when changing a tire or leveling on very rough terrain, ALWAYS PLACE THE LIFTING JACK UNDER THE MAIN FRAME RAIL. A label is provided to indicate the proper position for the jack. NEVER USE STABILIZING JACKS TO LIFT THE TRAILER.

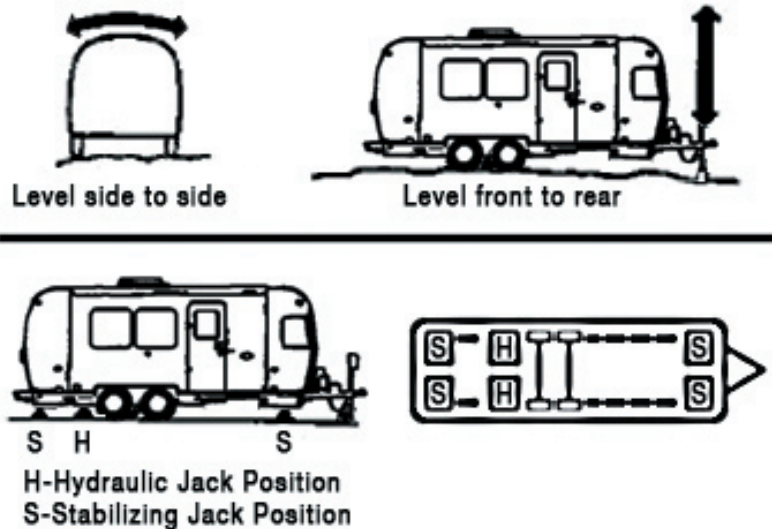

CAMPING

CITY WATER HOOK-UP

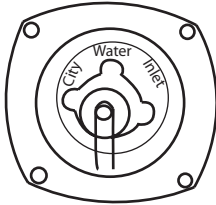

Simply connect hose to source, open the valve and you have pressurized faucets, toilet and water heater. Open faucets to purge trapped air from the water system. Allow the water heater to fill before lighting.

WASTE WATER SYSTEM

The main parts of the waste water system are the toilet, dual holding tanks, and tank dump valves. The system is designed to provide complete self-contained toilet facilities, while on the road or parked, without being connected to a sewage line. It may also be used in the stationary position while connected to a sewage hose.

Keep the dump valves closed with either method and empty the tanks when they are nearly full. The idea is to send a large volume of water through the tanks and hose at the same time to float solids away.

After the sewage tank has been emptied, close the gate valves and put approximately five gallons of water in the sewage holding tank. This will help prevent solids from building up in the sewage holding tank. The addition of a deodorizing agent like Aqua-Kem will help prevent odors.

Should you ever have a build-up of solids, close the valves fill the tanks about 3/4 full with fresh water, drive a distance to agitate the solids, and drain the tanks.

THINGS NOT TO PUT INTO TOILET OR DRAINS

1. Facial tissues (they do not dissolve like toilet paper).
2. Detergents or bleach. Use a sewage tank deodorizer, available from dealer.
3. Automotive antifreeze, ammonia, alcohols, or acetone.
4. Table scraps or other solids that may clog the drains.

SHORELINE POWER SUPPLY

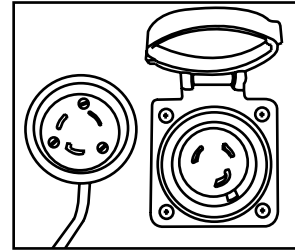

The **Power Cord** hook-up is on the side of the trailer. The cord may be stored in the rear exterior compartment. The power cord is plugged into the trailer receptacle and the City Power Service.

Many campgrounds provide less than 30 amp service. It is possible to blow their fuse or circuit breaker. If this happens, reduce the load and replace the fuse or reset the breaker.

TELEPHONE/CABLE TV

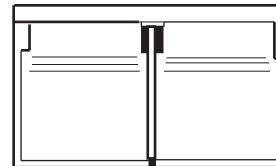

Located on the side of your trailer is a gray electrical inlet with dual covers. Lifting these covers reveals the receptacles to connect cable TV and telephone lines to your trailer.

WINTER TRAVELING

Traveling in sub-freezing temperatures will require certain precautions to protect the plumbing system and your personal belongings from being damaged by freezing.

Whenever possible the heat should be kept on at a constant temperature. It is easier for the furnace to keep a constant room temperature than for the trailer temperature to be allowed to drop to 50 degrees Fahrenheit then attempt to raise it to room temperature.

The furnace on Safari models except for the 22 ft. and 23 ft. models is ducted to provide heat to tanks and plumbing to prevent freezing.

The 22 ft. and 23 ft. models has 12-Volt heat pads installed with the fresh, gray, and black water tanks. These pads are individually switched. This feature allows the saving of battery power in a dry camping situation. To conserve battery power, RV antifreeze may be used to protect the gray and black tank. Battery power will last about 3 hours using all three heat pads.

The Bambi fresh water tank is above floor in the heated area of the trailer. The gray holding tank is below floor, insulated and a 2" duct from the furnace supplies heat to it. The black tank is insulated, however no heat is ducted to it. Use RV approved anti-freeze in the black holding tank to prevent damage to it and below floor drain plumbing if used in temperatures below the freezing point.

CAUTION: Drain and winterize all models if the water systems are not being used during winter traveling. See winterizing section in this manual for instructions.



WARNING: Always shut off the LP gas at the bottles when fueling a tow vehicle.

Some states do not allow LPG to be turned on while moving. While traveling in these

states you must use your common sense. How cold is it? How long will it be before you can turn the heat back on? Is the temperature dropping or raising? Remember, when towing at 50 MPH the wind chill factor will cause the interior of the trailer to cool much faster than a trailer that is parked.

When parked in sub-freezing temperatures make sure you keep a full supply of LP gas and plug into a 110 volt power source whenever possible. A fully charged battery will not last more than 8 to 10 hours if the furnace is running almost constantly and 110-volt power is not available.

Leave cabinet doors, wardrobes and bed doors partially open to allow warm air to circulate around plumbing lines and fixtures. Insulate and/or wrap your exterior water lines with heat tape.

EFFECTS OF PROLONGED OCCUPANCY

Your trailer was designed primarily for recreational use and short-term occupancy. If you expect to occupy the trailer for an extended period, be prepared to deal with condensation and the humid conditions that may be encountered. The relatively small volume and tight compact construction of modern recreation vehicles mean that the normal living activities of even a few occupants will lead to rapid moisture saturation of the air contained in the trailer and the appearance of visible moisture, especially in cold weather.

Just as moisture collects on the outside of a glass of cold water during humid weather, moisture can condense on the inside surfaces of the trailer during cold weather when relative humidity of the interior air is high. This condition is increased because the insulated walls of a recreation vehicle are much thinner than house walls. Estimates indicate that a family of four can vaporize up to three gallons of water daily through breathing, cooking, bathing, and washing. Unless the water vapor is carried outside by ventilation, or condensed by a dehumidifier, it will condense on the inside of the windows and walls as moisture, or in cold weather as frost or ice. It may also condense out of sight within

CAMPING

the walls or the ceiling where it will manifest itself as warped or stained panels.

Appearance of these conditions may indicate a serious 1 problem. When you recognize the signs of excessive moisture and condensation in the trailer, action should be taken to minimize their effects.

TIPS TO CONTROLLING CONDENSATION

To avoid condensation problems, try to follow these tips to help alleviate excess moisture.

Allow excess moisture to escape to the outside when bathing, washing dishes, hair drying, laundering, and using appliances and non-vented gas burners.

Always use the vent hood when cooking.

Keep the bathroom door closed and the vent or window open when bathing and for a period of time after you have finished.

Do not hang wet clothes in the trailer to dry.

In hot weather, start the air conditioner early as it removes excess humidity from the air while lowering the temperature.

Keep the temperature as reasonably cool during cold weather as possible. The warmer the vehicle, the more cold exterior temperatures and warm interior temperatures will collide on wall surfaces, thus creating condensation.

Use a fan to keep air circulating inside the vehicle so condensation and mildew cannot form in dead air spaces. Allow air to circulate inside closets and cabinets (leave doors partially open). Please keep in mind that a closed cabinet full of stored goods prevents circulation and allows the exterior temperature to cause condensation.

The natural tendency would be to close the vehicle tightly during cold weather. This will actually compound the problem. Simply put, you need to remove some of the warm air, and allow some cool outside air to get inside the vehicle, so the furnace will not recycle the humid interior air.

Note: Your trailer is not designed, nor intended, for permanent housing. Use of this product for long term or permanent occupancy may lead to premature deterioration of structure, interior finishes, fabrics, carpeting, and drapes. Damage or deterioration due to long-term occupancy may not be considered normal, and may under the terms of the warranty constitute misuse, abuse, or neglect, and may therefore reduce the warranty protection.

What are molds ?

Molds are microscopic organisms that naturally occur in virtually every environment, indoors and out. Outdoors, mold growth is important in the decomposition of plants. Indoors, mold growth is unfavorable. Left unchecked, molds break down natural materials, such as wood products and fabrics. Knowing the potential risks is important for any type of homeowner to protect their investment.

What factors contribute to mold growth?

For mold growth to occur, temperatures, indoor or outdoors, must be between 40 degrees and 100 degrees Fahrenheit and also have a source of moisture, such as humidity, standing water, damp materials, etc. Indoors, the most rapid growth occurs with warm and humid conditions.

How can mold growth be inhibited?

By controlling relative humidity, the growth of mold and mildew can be inhibited. In warm climates, use of the air conditioner will reduce the relative humidity. Vents are located in the bathing and cooking areas and constant use is advised during food preparation and bathing, even during colder weather. Additionally, opening a window during these activities will assist in ventilation. In extremely humid conditions, the use of a dehumidifier can be helpful.*

Frequent use of your RV or cleaning regularly is an important preventive measure. Further, any spills should be wiped up quickly and dried as soon as possible. Avoid leaving damp items lying about. On safe surfaces, use mold or mildew killing cleaning products. Check sealants regularly, and reseal when necessary to avoid water leaks. Proper preventive maintenance to the RV and its accessories, as described both in this manual and in accompanying literature, will provide the best protection to the RV.

For more information of controlling moisture in the RV, please read, "Tips to Controlling Condensation," located in this manual.

*If using a dehumidifier, please read and follow all manufacturer instructions and recommendations to the use and cleaning of the dehumidifier.



CAMPING

SLIDE OUT ROOM

The trailer should be level prior to extending the slide out room.

CAUTION: The stabilizing jacks **MUST** be deployed and trailer level before extending room. Failure to deploy the jacks and level the trailer may cause slide out room to lose its proper adjustment for extending, retracting, and sealing.

WARNING PLEASE READ

LEVEL AND STABILIZE UNIT USING HITCH JACK AND STABILIZER JACKS PRIOR TO OPERATING SLIDE-OUT ROOM. FAILURE TO LEVEL UNIT MAY CAUSE THE ROOM TO OPERATE IMPROPERLY OR CAUSE DAMAGE.

MAKE SURE THERE IS ADEQUATE CLEARANCE TO OUTSIDE OBJECTS BEFORE SLIDE-OUT ROOM IS EXTENDED.

TO PREVENT ACCIDENTAL INJURY, STAND CLEAR OF SLIDE-OUT ROOM WHILE ROOM IS IN MOTION.

REMOVE TRAVEL LOCKS BEFORE ATTEMPTING TO OPEN SLIDE-OUT ROOM.

NEVER ATTEMPT TO MOVE TRAILER WITH ROOM EXTENDED.

INSTALL TRAVEL LOCKS PRIOR TO TRAVEL.

TRAVEL LOCKS ARE TO BE POSITIONED AND ADJUSTED PROPERLY TO HOLD ROOM FIRMLY IN POSITION BEFORE TRAVEL.

If the front jacks aren't down when the room is extended the side to side imbalance will twist the body of the trailer if it's only supported by the front hitch jack. Please read the complete leveling and stabilizing instructions in the Extended Stay part of this section.

Once leveled and stabilized, locate the switches to operate the room. They are black

and located on the interior wall just forward of the room. The left switch, marked lock downs, must be used first. The lock downs are the large paddle latches on each end of the room. Depress the switch to the unlock position and hold. You will see the paddle latch on the forward end of the room retracting. Hold the switch down until the panels are completely retracted and you hear the operating motors just start to strain. The motors are thermal protected so you won't have to worry about damaging them. All models also have magnetic travel blocks that need to be removed from the travel latches.

Now hold the slide out switch in the out position. Hold the switch until the motor stops indicating the room is fully extended.

Retracting is the same procedures in reverse order.

CAUTION: Make sure the room is retracted and the lock down paddle latches are firmly engaged **PRIOR** to storing the stabilizing jacks.

FAILURE TO RETRACT

In the unlikely event the room won't retract, the first place to check is the lock down paddle latches. If curious fingers have hit the lock down switch and the latches aren't fully closed, power is automatically cut to the slide out switch. To correct this situation depress the unlock position on the lock down switch until you're sure they are fully retracted then try the slide out room switch again.

Check your 12-volt distribution panel for blown fuses. It is located on the right side of the cabinet under the front window.

The next option is to manually close the room. Under your trailer, where the room is located, there's a large hinged access panel attached to the underside of the trailer. It's rectangular and about a foot wide and six feet long. On the side opposite the hinge, three or four stainless steel screws hold the panel closed. Opening the access

panel reveals the motor and main drive shaft extending from the motor to the two gear driven slides.

On one end of the motor is a short lever. Swinging the lever up releases a brake that prevents the shaft from turning when the motor is shut off. With the brake released, it's now possible to turn the drive shaft with a 3/4-inch wrench. The octagon stub for emergency use of a wrench is located on the end of the drive shaft towards the back of the trailer.

Slide out Mechanism Manufacturer:

Power Gear

1-800-334-4712



CAMPING

NOTES

C

CLEANING

Exterior Skin

As a general rule of thumb we recommend the trailer be washed about every four weeks and waxed in the spring and fall. In industrial areas cleaning and waxing should be done on a more frequent schedule.

CAUTION: ABRASIVE POLISHES OR CLEANING SOLVENTS SUCH AS AUTOMATIC DISHWASHER OR ACID ETCH CLEANERS ARE TOO STRONG AND SHOULD NEVER BE USED. RINSE ALL GRIT FROM SURFACE PRIOR TO WASHING. Use soft rags or wash mitts always moving lengthwise with the trailer. NEVER rub hard on the coating. Even the softest rag will damage the coating if excessive pressure is applied.

ALWAYS CLEAN YOUR TRAILER IN THE SHADE OR ON A CLOUDY DAY WHEN THE ALUMINUM SKIN IS COOL. Oil, grease, dust and dirt may be removed by washing with any mild non-abrasive soap or detergent. Cleaning should be followed by a thorough clean water rinse. Drying the unit with a chamois or a soft cloth may prevent spots and streaks. WHEN WASHING OR POLISHING YOUR TRAILER, ALWAYS WIPE "WITH" THE GRAIN OF THE METAL.

After cleaning and drying, a good grade of nonabrasive automotive paste or liquid wax will increase the life of the finish, especially in coastal areas where the finish is exposed to salt air or in polluted industrial areas. It will also protect the shell from minor scratches and make subsequent cleaning easier.

It is important to remove sap, gum, resin, asphalt, etc. as soon as possible after they appear by washing and waxing. Sunlight and time will bake-harden these materials making them almost impossible to remove without heavy buffing. If asphalt remains on the trailer after washing, use a small amount of kerosene on a rag and wipe the spots

individually, being careful not to scratch the finish.

If a substance is found on the coating that cannot be removed by normal washing procedures, Airstream recommends using DX 330 Acryli-Clean made by PPG Industries. Follow all directions and warnings on the product container. Acryli-Clean should be used by trained personnel only, using the proper equipment under controlled conditions. Use the Acryli-Clean as sparingly as possible to remove glue, tar, and other similar substance.

To keep your trailer looking new, paint the "A" frame, LPG tanks, and rear frame periodically.

It is recommended that the caulking and sealant used in external seams and joints such as end shell segments and around window frames, light bezels, beltline and rub rail molding, etc. be checked regularly. If this material has dried out and become cracked or checked, or if a portion has fallen out, it should be replaced with fresh material to prevent possible rain leaks. Caulking and sealing material is available from your Airstream dealer.

Aluminum Wheels

The aluminum wheels and axle end cover come clear-coated. They keep their good looks simply by washing with soap and water. Do not use abrasive cleaners or polishes on coated aluminum wheels.

Exterior Shower

Certain units are equipped with an exterior shower. This shower consists of a shower hose, shower head, and water valve inside of a lockable exterior door. Water is supplied by the pump or city water hookup.

EXTERIOR

Main Door

CAUTION: When towing, the door lock and dead bolt must be secured. If it is not locked, the constant vibration of travel may cause the door to open with possible damage.

Screen Door

The screen door secures to the main door by means of a slide bolt type latch. It can be operated independently by releasing the slide bolt and swinging the screen door away from the main door.

Step

To operate the step, lift up on the front of the step and pull straight out until step locks into place. Some units will be equipped with a double step. After extending step, the second portion folds out. To store the step fold it back into position, lift the front slightly and push the step back into its storage area.



WARNING: Once the steps are lowered, press down on them to make sure they are secure in their notches.

CAUTION: Never travel with step lowered or extended

Exterior Windows

Lifting two red vertical latches up past vertical opens the escape windows of your trailer. This releases the sash from the window frame and allows it to be swung clear of the trailer.

Turning the large operating knob counter clockwise opens the standard windows.

Clean your trailer windows the same way you clean the windows in your home. Clean the seals with a damp cloth or mild detergent every three to six months, taking care not to use strong solvents, as they will damage the seals. A coat of natural silicone lubricant applied after the seal has dried will keep it flexible. Spread the lubricant evenly with a brush or finger, working it into the surface.

This is a good practice for all rubber seals in your trailer. For replacement of a damaged window contact an Airstream Service Center.

Window Stoneguard

Stone guards are provided for added protection on the front windows. To open the guard, unhook the two rubber T-handles on the bottom of the guard, raise the stone-guard to the desired height, and tighten the thumb screws on each support arm. Be sure to lower and fasten the guard when high winds may be approaching and before travel.

Wrap Protectors

The front end of the trailer is equipped with stainless steel protectors covering the lower corner wraps. The protectors provided added protection from road damage. The protector can be moved out of the way for cleaning by unbolting and swinging the protector forward on the hinge.

Awnings

Complete instructions have been provided with your awning. You should make sure your traveling companion is familiar with the operation of the awning. If a sudden wind should come up, or if high wind is forecast, the awning should be retracted and stowed.

Chassis

Hitch Ball Height

The standard RECOMMENDED HITCH BALL HEIGHT for the Airstream Safari and Bambi is 17 ¾ " except for the 22 ft. model which is 18". If you plan long trips with the trailer heavily loaded you should check your trailer, after loading, to determine the optimum height. To check, park the trailer on a level surface and crank the front jack up or down until the measurement from the frame to the ground is the same front and rear. Measure from the ground to the upper surface of the hitch ball coupler. Add one inch to this figure when setting the ball height on the tow vehicle to allow for the suspension settling under the added weight.

Coupler Operating Instructions

1. To open - slide forward and pull up to open latch before inserting ball.
2. Place coupler on ball of same diameter as coupler and of same or greater capacity.
3. When ball is completely nested in socket, push top of latch handle rearward until handle snaps into closed position. (Figure 2)
4. Extend jack to ground and lift tow vehicle/trailer combination 2-4" to insure coupler is securely attached to tow ball. Retract jack before towing.
5. Insert padlock through hole in handle for theft prevention.

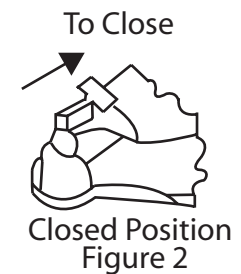
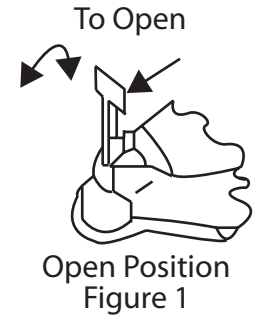

WARNING: ALWAYS OPEN LATCH HANDLE BEFORE INSERTING BALL INTO COUPLER.

EXTERIOR

TIRES

Your trailer is equipped at the factory with name brand trailer tires. Airstream dealers cannot make adjustments to tires. A dealer who handles that particular brand must do this. If you ever have tire problems check the local telephone directory for the nearest dealer.

To get the maximum performance from your tires check the air pressure often, but only when the tires are cool. Never bleed out air immediately after driving. Recommended tire pressures vary with tire type and size. For pressures refer to the SPECIFICATION TABLE.

Try to park out of the sun whenever possible when in warm climates. In desert regions use tire covers to prevent ultra-violet deterioration to tires.

To CHANGE A TIRE with a jack see the label affixed to the underbelly to the rear of the wheels. This label, says JACK with an arrow and points to a plate riveted to the mainframe rail where the jack head must be placed. A flat tire may also be changed without the aid of a jack. Drive the unit up on a ramp 8' wide, 6" high, and about 3 feet long at its base. Position the good tire on the ramp. This will raise the flat tire clear of the ground.



WARNING: The maximum speed rating on the tires installed on your trailer is 65 MPH. DO NOT EXCEED THIS RATING. Failure to heed this warning could cause catastrophic tire failure resulting in property damage, personal injury and/or death.



WARNING: Never attempt to change any tire without securely chocking remaining wheels. Never position yourself in a manner where a raised trailer can come down on you if it should become dislodged from a jack or ramp.

All tire and wheel assemblies are balanced at the factory. Be sure to rebalance the tire and wheel assemblies each time a tire is changed.



WARNING: When removing aluminum-forged wheels from spindle, it is very important to mark them to assure the wheel is placed in the same position of the drum when reinstalling. If the aluminum-forged wheel is to be mounted on a different drum it is important to sand all loose corrosion from the mating surfaces.

WARNING: WHEEL SEPARATION CAN OCCUR

1. On first trip, tighten wheel lugs at start and at 10, 25, and 50 miles.
2. Thereafter, check wheel lugs before each trip.
3. Following winter storage, check before beginning a trip.
4. Following excessive braking, inspect wheel lugs

Torque aluminum wheels to 110-120 ft. lbs. and steel wheels to 95 ft. lbs.

DO NOT over torque.

There after, check wheel lugs before each trip, after excessive braking, and following winter storage.

TIRES

In an emergency, remove the flat tire. The independent suspension of the rubber torsion axle allows four or six wheeled units to be safely towed on three or five wheels for a short distance (100 miles maximum) and only at a low speed (30 MPH).

Be especially cautious in crossing holes or dips in the road. Under these circumstances it is good practice to set your rear view mirrors so that you can observe your tires at all time.

Tips on Tire Care

Any tire, no matter how well constructed, may fail in use as a result of punctures, impact damage, improper inflation or other conditions resulting from use. Tire failures may create a risk of property damage or personal injury. To reduce the risk of tire failure we strongly recommend the following:

1. Check the pressure in your tires, including your spare, at least monthly when the tires are cool (after the vehicle has stopped three hours and then driven less than one mile.) Do not reduce pressure when tires are hot. Use a tire gauge to check pressure and maintain it at the recommended level.
2. Never overload your tires. The maximum load carrying capability of your tires is molded on the sidewall of the tire.
3. Check your tires frequently for scrapes, bulges, separations, cuts or snags resulting from use. See your tire dealer immediately if any such condition is discovered.
4. Never operate your vehicle in excess of lawful speeds or the maximum speeds justified by driving conditions, or in excess of speeds recommended for the tire you are using.

5. Make every effort to avoid running over objects that may damage the tire through impact or cutting, such as chuckholes, glass, metal, etc.
6. Never drive on smooth tires. Tires should be removed when $\frac{2}{32}$ nds inch of tread depth remains. In most states it is illegal to drive with less than $\frac{2}{32}$ nds inch remaining tread depth.



EXTERIOR

TIRE ROTATION

(10,000-mile intervals)

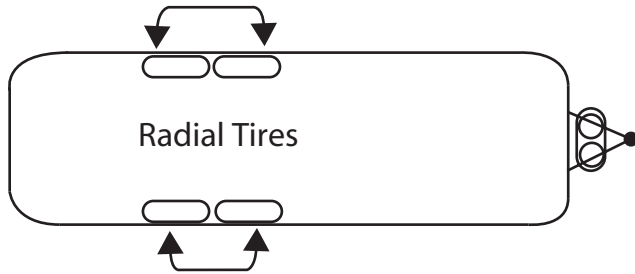

SPARE TIRE

The spare tire for Airstreams is stored under the front of the trailer. The front handle of the tire carrier is a one-inch tube protruding out from under the front A-frame on the curbside. It is secured by a bracket and bolt along the inside of the A frame rail. Removing the bolts allows the front on the tire carrier to be lowered and the spare tire removed.

Tire Inflation (PSI) Cold

ST 215-75 R14 - 50 psi

ST 225-75 R15 - 65 psi

NOTE: Torque aluminum wheels to 110-120 ft. lbs and steel wheels to 95 ft. lbs. Check at 10, 25 and rechecked at 50 miles. DO NOT over torque.

AXLE AND RUNNING GEAR ASSEMBLY

Each RUBBER TORSION axle is aligned during manufacturing, and double-checked on a random basis. Alignment after delivery is the customer's responsibility.

Hitting chuck holes or rough railroad tracks while going straight will only cause misalignment after the tire has been struck many repetitive times. Of course, a deep enough hole can affect the alignment immediately.

The worse culprit is a curb because they are normally struck at an angle. Surprisingly rear axles are occasionally damaged when people are attempting to park beside a curb and are backing up their trailer.

As you look under your trailer is it normal for the axle to be bent up in the middle. This bend is how the camber is obtained.

Toe-in is built into the axle by very slight bends in the axle tube on each end.

If tire wear ever indicate misalignment check with your dealer for the nearest location having the proper equipment.

CAUTION: Never allow heat to be applied to the axle tube since the rubber providing the spring torsion action will be severely damaged.

Rubber torsion Axle Alignment Specifications

Toe-In each side 1/16"	Tolerance 1/16" + or -
Camber each side ¾ degrees positive	Tolerance ¾ degrees + or -

Wheel Bearing Maintenance

1. Jack trailer at marked jack location pad behind axle on mainframe,
2. Remove hubcap or spindle cover, wheel and tire.
3. Remove cotter pin.
4. Remove dust cap.
5. Remove spindle nut and washer.
6. Remove bearings, hub and rotor.
7. Lay down hub and rotor with inside grease seal down. Knock out inner bearing and grease seal using wood or plastic dowel and hammer.
8. Clean all parts thoroughly with kerosene.
9. Check all bearings and races for chips or roughness of any kind. Any damaged component must be replaced.
10. Pack bearing with a good grease (No 2 grade-265 ASTM penetration or equivalent).
11. Install inner bearing.
12. Install new grease seal in hub or rotor using wooden or rawhide mallet.
13. Install hub and drum on spindle.
14. Install outer bearing.

EXTERIOR

15. Install washer and spindle nut.
16. While rotating the wheel, tighten the spindle nut with a 12" wrench until there is a slight tension. Then back off one notch and install cotter pin. There should now be from .001" to .010" end play in hub. If not, back off one notch.
17. Check the lug nuts at 10, 25 miles and recheck at 50 miles of travel. **Torque aluminum wheels to 110-120 ft. lbs and steel wheels to 95 ft. lbs.**

When greasing bearings by hand, place a glob of grease in the palm of one hand and push the large end of the bearing down into the grease (see illustration). Keep turning the bearing around and forcing it down through the grease until the grease is extruded up through the opposite end. Wipe the extra grease in your hand around the outside of the bearing. It's not necessary to fill the hub and dust cap with grease.

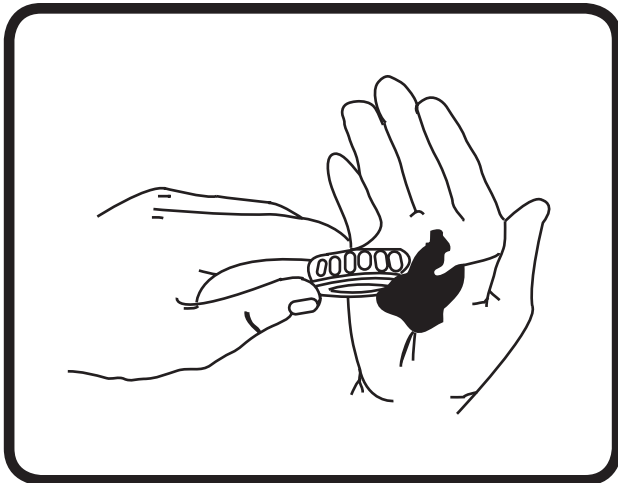

ELECTRIC BRAKES

A CONTROLLER installed in your tow vehicle will synchronize the trailer brakes with your tow vehicle brakes. It is designed to apply the trailer brakes whenever the tow vehicle brakes are applied.

TYPICAL ELECTRONIC CONTROLLER

ELECTRONIC CONTROLLERS are inertially activated. The controller senses deceleration and generates an output, which reflects the inertia sensed. When you are stationary, the controller does not apply the brakes unless the manual slide bar is activated.

NOTE: Study all material provided with your particular brake control. If you don't understand the information, have the installer explain the information to you or call the manufacturer of the controller.

In THE EVENT OF AN ACCIDENTAL SEPARATION of the tow vehicle and trailer, the BREAKAWAY SWITCH will set and lock the trailer brakes for a sufficient length of time to stop the trailer. The switch is activated when the wire attached to it and to the tow vehicle pulls out the small pin in the front of the unit. THIS PIN SHOULD BE PULLED OUT, LUBRICATED WITH LIGHT HOUSEHOLD OIL AND REPLACED EVERY 90 DAYS.

To prevent corrosion within the breakaway switch, pull the switch's pin straight forward and spray the inside of the switch through the hole with an electric contact cleaner (such as Spra-Kleen) and reinsert the pin. A drop of light household oil on the groove near the base of the pin will allow the pin to operate freely. WHEN THE TRAILER IS CONNECTED TO THE TOW VEHICLE, THE BREAKAWAY SWITCH LOOP SHOULD BE ATTACHED TO THE PERMANENT FRAME OF YOUR HITCH. When disconnecting trailer from tow vehicle remove wire loop from the frame. DO NOT REMOVE PIN FROM SWITCH BECAUSE THIS WILL APPLY THE TRAILER BRAKES.



WARNING: Do not use breakaway switch for parking brake.

HOW TO USE YOUR ELECTRIC BRAKES PROPERLY

Your trailer brakes are designed to work in synchronization with your tow vehicle brakes. Never use your tow vehicle or trailer brakes alone to stop the combined load.

Your trailer and tow vehicle will seldom have the right amperage flow to the brake magnets to give you comfortable, safe braking unless you make proper brake system adjustments. Changing trailer load and driving conditions as well as uneven alternator and battery output can mean unstable current flow to your brake magnets. It is therefore imperative that you maintain and adjust your brakes as set forth in this manual, use a properly modulated brake controller, and perform the synchronization procedure noted below

In addition to the synchronization adjustment detailed below, electric brake controllers provide a modulation function that varies the current to the electric brakes with the pressure on the brake pedal. It is important that your brake controller provide approximately 2 volts to the braking system when the brake pedal is first depressed and gradually increase the voltage to 12 volts as brake pedal pressure is increased. If the controller "jumps" immediately to a high voltage output, even during a gradual stop, then the electric brakes will always be fully energized and will result in harsh brakes and potential brake lockup.

Proper synchronization of tow vehicle to trailer braking can only be accomplished by road testing. Brake "lockup, grabbiness, or harshness" is quite often lack of synchronization between the tow vehicle and the trailer being towed, too high of a threshold voltage (over 2 volts), or under adjusted brakes.



WARNING: The braking system should be checked and serviced by qualified, certified technicians only. Failure to do so could result in loss of control of your vehicle or the trailer causing damage to property, injury, and/or death.

EXTERIOR

POWER JACK (Option)

A switch located on the bottom of the housing operates the power jack. When the jack is fully extended or retracted internal limit switches automatically shut off the motor.

Should an electrical failure occur, remove the power head by loosening the two Allen set screws. The jack post may now be operated manually by inserting the emergency handle into the coupling on top of the post.

The jack is wired directly to the battery and has an inline fuse between the battery and the power head.

Should an electrical failure occur, remove the power head by loosening the two Allen set screws. The jack post may now be operated manually by inserting the emergency handle into the coupling on top of the post.

Replacing Power Head

It is essential that the following procedure be used before the power head is replaced on the post.

1. With 12 volts connected, ground the power head to trailer "A" frame. Operate main switch in "post retracting direction" until the motor stops automatically.
2. Using emergency handle, crank post clockwise by hand until fully retracted, then turn crank one turn counterclockwise.
3. Replace head on post and make sure that drive pin is engaged with post coupler. Tighten Allen set screws.

Maintenance

1. Every two years remove screws and cover and check grease condition. Use HMP grease similar to lubricate 630AA and spread on gear teeth, Grease is not required on the nylon timing gears. No internal lubrication of the post is required, but an occasional external application of a silicone or WD-40 spray lubricant on the inner tube of the post when extended is permissible.
2. Before replacing the cover ensure that the plate and limit switch unit are located correctly.
3. Apply a little sealing compound around the mating surface of the gear cover and replace screws tightening them diagonally. Check synchronization if head has been removed from the post.
4. A little penetrating oil on the Allen setscrews occasionally will help prevent corrosion and difficult removal.

Note: Leave tow vehicle transmission in neutral when lifting both units. Dolly wheels are not recommended. Always retract stabilizing jacks before using your Super Jack under load.

TIRES

Load and Inflation Information for Your Tires

Maintaining proper tire inflation pressure is essential for both tire safety and performance.

Proper Tire Inflation

The level of air in your tires affects your vehicle's overall performance. Not even the highest quality tire will perform well if it's not inflated properly. The correct pressure varies from vehicle to vehicle and depends in part upon driver preference. Each vehicle has a maximum inflation pressure, usually found on a metal tag riveted to the outside of the vehicle as well as on the original equipment tires.

Correct tire inflation is a key component in tire care. The recommended inflation pressures for your tires are indicated on the certification label or in your owner's manual. Since RVs can be loaded with many different configurations, the load on each tire will vary. For this reason, air pressure should be checked based on the load on each individual tire. Cold Inflation Pressure should be adjusted to handle the maximum tire load, and all tires on the axle should carry the same inflation pressure. COLD TIRE INFLATION PRESSURE is the tire pressure checked in the morning before you drive more than a few miles or before rising ambient temperatures or the sun's radiant heat affects it. Check your tires' air pressures at least once a month, before each trip and each morning you drive during a trip. Tire pressure should be checked cold, as tire pressure ratings have been designed with typical running heat/pressure build-up in mind. Make sure the valves and caps are free of dirt and moisture.

Under Inflation

Under inflation brings a higher risk of damage due to road hazards, reduces casing durability, causes a loss in fuel economy, and uneven or irregular tire wear. Severe

under inflation brings about an increased risk of tread separation, handling difficulties, and possibly tires failure, caused by overheating.

IMPORTANT: Lowering tire pressure in the search for a smoother ride is not only dangerous, it's relatively ineffective, and as the difference in the ride quality is not significant. When minimum inflation pressure requirements are not met, tire durability and optimum operating conditions are compromised. Tire inflation pressure should always meet the guidelines for vehicle weight.

- It may be necessary to inflate your tires at a truck stop or truck service center in order to achieve adequate air pressure for your coach's needs
- Only permanent air seal metal valve caps should be used.
- Be safe - if a tire has been run 20% under inflated, it must be dismounted and inspected by a trained professional. It should not be aired up without a full inspection or without using a safety cage. Use a calibrated gauge. If your tire is rated for higher inflation pressures, a special gauge will be required designed for larger tires.
- Don't bleed air from warm tires to reduce pressure buildup
- Don't inflate tires to cold PSI rating beyond rim specifications

HOW OVERLOADING AFFECTS YOUR TIRES

Tire pressure is what enables your RV tire to support loads. Overloading your tires can have serious consequences for passengers and your RV. Too much weight can cause stress on your RV's suspension system, brake failure, shock absorber damage, handling and steering problems, irregular tire wear and possible tire failure. Excessive loads or under inflation can lead to an excessive amount of heat and tire failure. If you discover that your tires cannot handle the load, lighten the weight of the load on your tires. Tire pressure should never be reduced below the vehicle manufacturer's recommended levels to support load conditions in order to improve the ride quality of a vehicle. The difference in ride quality is not significant. When inflation pressure requirements are not met, tire durability and optimum operation can be affected.



EXTERIOR

WEIGHING YOUR TRAVEL TRAILER OR TOWED VEHICLE

Since a trailer or towed vehicle adds to the load on your RV's tires, it is crucial to properly weigh towed vehicles. A travel trailer should first be weighed with the tongue, while detached from the pulling vehicle. The actual weight of the trailer must be less than or equal to the GVWR for safe operation, otherwise contents must be removed until the weight is within maximum GVWR limitations. The weight of the complete, attached trailer, excluding the towing vehicle, must also be taken. Each wheel should be weighed while still attached to the towing vehicle, and the individual wheel positions on the towing vehicle should be weighed and checked for overload as well.

If you determine that the loading of your vehicle's tires are uneven, the actual weight of the trailer on each tire must be less than or equal to its maximum load capacity for safe operation, otherwise contents must be removed until the weight is within maximum load limitations.

TIRE CARE

Tires are a very precisely engineered product designed for specific applications and use. The tire functions as the sole contact between the vehicle and the road. Therefore, it must provide several different functions in order for your recreational vehicle to handle properly. Most important are traction while moving, grip when steering or stopping, and a comfortable ride for you and your passengers. The Tires on your recreational vehicle are designed for highway use and must be properly maintained in order to maximize tire life, as well to provide a safe mode of transportation. Always keep your tires clean and properly inflated.

Correct tire inflation is a key component in tire care. The recommended inflation pressures for your tires are indicated on the certification label or in your owner's manual. Since RVs can be loaded with many different configurations, the load on each tire will vary. For this reason, air pressure should be checked based on the load on each individual tire. Cold Inflation Pressure should be adjusted to handle the maximum

tire load, and all tires on the axle should carry the same inflation pressure. than a few miles or before rising ambient temperatures or the sun's radiant heat affects it.

Tips on Tire Care

Any tire, no matter how well constructed, may fail in use as a result of punctures, impact damage, improper inflation or other conditions resulting from use. Tire failures may create a risk of property damage or personal injury. To reduce the risk of tire failure we strongly recommend the following:

1. Check the pressure in your tires, including your spare, at least monthly when the tires are cool (after the vehicle has stopped three hours and then driven less than one mile.) Do not reduce pressure when tires are hot. Use a tire gauge to check pressure and maintain it at the recommended level.
2. Never overload your tires. The maximum load carrying capability of your tires is molded on the sidewall of the tire.
3. Check your tires frequently for scrapes, bulges, separations, cuts or snags resulting from use. See your tire dealer immediately if any such condition is discovered.
4. Never operate your vehicle in excess of lawful speeds or the maximum speeds justified by driving conditions, or in excess of speeds recommended for the tire you are using.
5. Make every effort to avoid running over objects that may damage the tire through impact or cutting, such as chuckholes, glass, metal, etc.
6. Never drive on smooth tires. Tires should be removed when 2/32nds inch of tread depth remains. In most states it is illegal to drive with less than 2/32nds inch remaining tread depth.

Proper Inspection and Storage of Tires

Before taking your RV on a trip or when removing from an extended storage period, make it a practice to inspect the overall condition of your tires. Check for any type of condition or damage that might result in failure. A thorough check should include both inside and outside sidewalls, tread area and the condition of hardware such as valve stems, valve caps, and wheels. The tread should be checked for any unusual wear, cracking, penetrations and/or cuts. An uneven wear pattern can indicate misalignment or worn suspension parts.

Since many RVs are used seasonally and sometimes stored for extended times, it is possible that tires will take many years to wear out. Tires, as any rubber product, will age over time. If tires show cracking in the sidewall or tread surfaces that are more than 2/32nds deep, they should be replaced before your next trip or vacation. Store your RV in a cool dry area away from major heat sources and extreme cold. An enclosed area is best with no exposure to electromagnetic sources such as generators or transformers. If you must keep your RV outside, cover your tires from direct sunlight. Take your RV to your Tire dealer for service to check or correct any of these conditions.

Replacing Your Tires

It is possible to replace your tires with a different size in some instances to increase your load capacity with a different inflation pressure. If there is a reason to replace your tires with a different size, make sure the following checks are made before the purchase.

- Does the replacement tire have the load capacity that is needed for my RV and will it fit properly inside the wheel well?
- Will the overall diameter difference affect the speedometer or antilock braking system?
- Is the increase in air pressure compatible with the maximum rated pressure stamped on the rim?
- Is there enough dual spacing offset for the rear wheel positions?

Tires used on most RVs are driven at or near maximum loads during hot weather and then are left idle for months. In normal use oils in the tire come to the surface during flexing and protect the rubber from ultraviolet light. But when left idle natural aging may cause the rubber to crack prematurely, especially in the sidewall area.

Any tire on an RV that is over five years old should be inspected by a competent tire professional for cracking and replaced, even if it has no apparent tread wear. This is because a tire on a car or truck might last 80,000 to 120,000 miles before it needs to be replaced, but an RV tire that only travels 5,000 miles per year will not approach that mileage for 20 years. It will need to be replaced much before that.

The first step is choosing a tire adequate for the load. The load rating printed on the sidewall will show the maximum load that can be carried at a defined pressure. As the inflation pressure drops, the load that can be carried is less. As speed increases, the amount of load that can be carried also drops. The load rating is also affected by how the tire is used, as a single or as a dual.

A Goodyear ST225/75 R15 tire inflated to 65 PSI has load capacity of 2540 Lbs.

A Goodyear ST215/75 R14 tire inflated to 50 PSI has load capacity of 1850 Lbs.

An ST225/75R15 tire is a special trailer tire with a section width of 225 mm, a height to width ratio of 75%, radial construction with a diameter of 15 inches. As the width to height ratio becomes smaller, the tire has a lower profile. LT stands for Light Truck and P for Passenger service.

INTERIOR

The interior of all Airstream trailers has been designed for comfort, convenience, durability and appearance. How you use it and how you take care of it naturally depends on you. However, if you learn to operate the interior components and take care of them and the trailer properly, this knowledge will add to your pleasure as well as the long life of your trailer.

Upholstery

All materials should be professionally dry cleaned to remove any overall soiled condition. However, these materials may be spot cleaned using the cleaning code instructions as listed. Sample swatches are furnished to our dealers. The dealer will be able to give you the name of the fabrics used in your particular trailer. Each swatch will show the cleaning code in parenthesis.

The following are the cleaning code instructions for the various fabrics used in the Airstream trailers:

Code WS

Fabric Care: Spot clean this fabric either with a mild solvent or water based cleaning agent. When using a solvent or dry cleaning product follow instructions carefully and clean only in a well-ventilated room. Avoid any product, which contains highly toxic carbon tetrachloride. You may also use an upholstery shampoo product or the foam from a mild detergent. With either method pretest a small area before proceeding. Use professional furniture cleaner when an overall soiled condition is reached.

Code S

Fabric Care: Spot clean, using a mild water free solvent or dry cleaning product. Carefully follow instructions on such product. Clean only in a well-ventilated room. Avoid any product containing carbon tetrachloride, which is highly toxic. Pretest small area before proceeding. Use professional furniture cleaner when an overall soiled

condition is reached.

Code W

Fabric Care: Spot clean, using the foam only from water based cleaning agent such as mild detergent or non-solvent upholstery shampoo product.

Apply foam with a soft brush in a circular motion. Vacuum when dry. Pretest small area before proceeding. Use professional furniture cleaner when an overall soiled condition is reached. The manufacturer of the fabric designed the above code.

CAUTION: Never remove cushion cover for separate dry cleaning or washing. Any tumble cleaning method can destroy the backing, shrink or otherwise damage upholstery fabric.



WARNING: Keep your furniture and family safe from fires caused by careless smoking. Do not smoke when drowsy. Remove immediately any flowing ash or a lighted cigarette, which falls on furniture. Smoldering smoking material can cause upholstered furniture fires.

Interior Skin

The interior skin on your trailer is covered with an upholstery that can be cleaned with a vacuum cleaner. For stubborn spots follow Code W instructions above.

Trailers with aluminum interior skin (Upgrade package) should follow the same cleaning instructions detailed in the Exterior section of this manual for the exterior skin.

Draperies

CAUTION: All drapery materials and mattress covers must be professionally dry-cleaned.

For Safari models remove the draperies by unsnapping them from the wall, removing a screw or pop rivet from the end of the curtain track, and sliding them out. The pop rivets are removed by drilling through the head with a 1/8" drill bit.

Carpet

The carpet can be cleaned with any good commercial carpet cleaner, or with a detergent and water. BE CAREFUL NOT TO SOAK THE CARPET WITH WATER.

Counter Area

The counter areas around the sink are of a high-pressure laminate and can be cleaned with soap and water, or you can use a common solvent on tough spots. Be sure no abrasive cleaner is used, as there is the possibility it could scratch the surface. A protective pad should always be placed under hot utensils.

Vinyl Covering

Damp wiping with mild detergent does routine cleaning. Using any of the automotive cleaners designed for vinyl car seats and dashes can perform a more thorough cleaning.

Sinks

Cleaning can be accomplished using mild liquid detergent with a soft cloth. A complete Home Owners Guide for your sinks is supplied in your Owner's Folder. Please read these instructions before use.

Shower Stall

To clean your fiberglass shower stall unit use warm water and one of the stronger liquid detergents. Do not use abrasive cleaners, they may scratch and dull the surface of your unit. Stubborn stains can be removed with solvents such as turpentine, paint thinner or acetone. Restore dulled areas by rubbing with an automotive type liquid cleaner then put the soft slow back into your unit with a light application of liquid wax.

Lounges

On certain models the sofa converts to a bed,. Lift up the front of the seat and pull out. Below the bed is a large upholstered, horizontal door that is opened by pulling straight out and hinging down. This exposes large plastic trays. This is a great place to store heavy items since it is low to the floor and in front the trailer.



WARNING: To prevent possible injury, these legs must be lowered and locked into place after the top is pulled out and before putting weight on the bed.

Dinette

The dinette is made into a bed by rising up on the front of the table and folding the table leg up against the bottom of the leaf. As the table is raised it will unhook from the upper wall brackets. Once it is unhooked it can be pulled out and the wall hinge will let it be lowered on the supports of the dinette seats. The backrests of the seats are placed over the table to complete the conversion.

BUNK BED



The bunk bed is rated at 150 lbs. Do not overload the bed.

INTERIOR

Dinette Table

To open the folding table, lift into a horizontal position and pull the table leg down toward the vertical position until it snaps into place. The leg is hinged at the front edge of the table and is held against the bottom of the table with Velcro. To extend into the double leaf position, lift the table slightly so the leg clears the carpet, and slide the leg and center support out toward the center of the trailer. The leaf then unfolds and rests against the leg support.

Airstream recommends that during travel the table be left in the upright position.

Monitor Panel

The monitor panel allows you to check the amount of fluid in your fresh water tank, black tank, and the gray tank.

The LP gas and battery status are also shown.

Water Pump Switch

The water pump switch operates the pump. Once the switch is turned on the pump will run until the water pressure reaches about 35 psi. At this point an internal pressure switch will shut it off. When a faucet is opened the water pressure will drop and the pump will start to run again.

The standard equipment Sureflo water pump should be turned off when you are on city water or when the trailer is left unattended.

Aquajet water pump (Optional Equipment)

Water pressure at some campgrounds may be low. The water pump can be turned on to assist the city water hookup pressure. Be sure there is some water in the fresh water tank. The pump will only use the water that is needed out of the tank to bring the pressure up to the usual standard. The water pump should be turned off when the trailer is left unattended.

Exhaust Fans

The Safari trailers are equipped with roof ventilators either in the center of the ceiling, in the bathroom, or both locations.

The square fans are cranked opened. Round ventilators, used in some bathrooms, are opened by pushing straight up on the crossbar handle. The round switch can then be turned to engage the fan motor.

Note: The range exhaust cover on the outside the trailer has a swinging door that can be latched during inclement weather and should be latched in travel. When operating the exhaust fan, the latches should be turned so the door swings open when the fan is on.

Telephone Shower Head

The telephone shower head is designed to give maximum flexibility in usage, and provides for water saving techniques when using your trailer on self-containment. It can be held in the hand and moved about the body. Normally the best water conservation procedure is to wet the entire body and then turn the water off. Apply soap, lather thoroughly, and then rinse the soap off. The telephone shower head is also used to fill the tub for taking a bath. When you have finished using the shower be sure to shut the water off at the faucet.

Linoleum

Clean with any standard linoleum floor cleaner

Bath Area Remote Switches

Two remote switches for appliances are located on the bathroom wall. One is for the water pump, and duplicates the pump switch on the central control panel. Either pump switch may be used to turn the pump on or off at any time.

The second remote switch, with a red indicator, is for lighting the water heater.

Ceiling Light/Directional Lighting

The ceiling light fixture has a push button switch located in on the fixture. Gently squeezing in the middle and pulling down will remove the LENS. During cold weather it is a good idea to leave the light on a few minutes prior to removing the lens. The bed and lounge area has individually switched directional lighting.

A wall switch just inside the door control ceiling, step, and patio lights. The individual ceiling lights must be on for the wall switch to work.

Information on the optional high volume roof vent may be found in the appliance section of this book.

Storage

The kitchen cabinet should have the heaviest items on the bottom and lighter items overhead. After loading you should have the skillet and can goods on the floor or bottom shelf, and the cereals and crackers in the overhead roof locker. Use the unbreakable type plates and saucers, and consider storing your dish towels around them. Better yet, use paper plates. Who wants to wash dishes when on a trip or vacation?

Clothes hung in wardrobes should be kept on hangers that snap over the clothes rods to keep them from "jumping" off on rough roads. Evening dresses should be kept in the plastic bags like dry cleaning businesses use. No matter how hard you try, if you travel a long dusty section of road the dust will work its way into the trailer and soil clothes. Try to avoid large bulky coats. Layers of lighter clothing will usually keep you warmer, are more versatile and easier to store. There are several areas in the trailer to store your belongings. Remember to distribute the load as outlined in the Loading section of this manual.



WARNING: Keep flammable material away from the furnace.

Remember, heavy items should be stored low and toward the front, lighter items in the rear and overhead cabinets.

SMOKE ALARM - FIREX MODEL B



WARNING: Alarm battery is shipped deactivated. Check your alarm for proper battery installation.

IMPORTANT INFORMATION

SMOKE ALARM SAFETY CHECKLIST

1. Test your smoke alarm every week. To test the electronics, firmly depress the button. To test that smoke reaches the sensor, blow smoke in a careful fire-safe manner into your smoke alarm.
2. Your smoke alarm will not work without power. Never shut off its power or remove the battery to quiet the alarm.

FOR BATTERY-POWERED UNITS: When your smoke alarm "beeps" about once a minute, the battery is weak. Immediately install a new battery correctly. Be sure to

INTERIOR

use only batteries specified in Owner's Manual or on unit. Test unit after installing a new battery.

3. Clean and vacuum the openings on your smoke alarm once a month.
4. Do not open the smoke alarm or try to repair it. For replacement information see the WARRANTY in the Owner's Manual.
5. Verify you have the proper number of smoke alarms in your home and the correct location for each one. A smoke alarm will not respond well in an incorrect location.
6. If your smoke alarm has one or more of these special features, please note:
 - FALSE ALARM CONTROL (Model C): Pushing test/hush button reduces sensitivity for up to 15 minutes, minimizing nuisance alarms,
 - FLASHING LIGHT (Model E): Pushing test button turns flashing safety light on. Very thick smoke may obscure light.
7. Smoke alarms have technical limitations and may not respond in all situations. **FIRE PREVENTION** is your best safeguard.
8. For a replacement Owner's Manual or Safety Checklist, please indicate your unit model, include a self-addressed stamped envelope and send to:

Maple Chase Company
2820 Thatcher Road
Downers Grove, Illinois 60515-4040

WEEKLY TESTING OF YOUR SMOKE ALARM

1. FOR A COMPLETE WEEKLY TEST OF THE ELECTRONICS AND THE SENSOR OPERATION, FIRMLY DEPRESS THE TEST BUTTON ON THE COVER OF THE SMOKE ALARM FOR A FEW SECONDS. The smoke LED (light emitting diode), which is the indicator light under the clear Push-to-Test button, will blink once per second while the button is being pushed and the alarm is sounding. The smoke alarm will stop sounding when you release the button.
2. If your smoke alarm has the False Alarm Control or Safety Light feature see "SPECIAL SMOKE ALARM FEATURES" for further testing information.
3. **IMPORTANT:** Always test your smoke alarm upon returning from vacation, or any other time when no one has been in your household or residence for several days.
4. If a smoke alarm is installed in a mobile home, test the smoke alarm after you remove the vehicle from storage and before each trip.



WARNING: If your smoke alarm does not respond as described in any of the above tests, check that a good battery is properly installed. If a good battery is properly installed, promptly remove the unit, repack it and return it for repair or replacement.

TAKING CARE OF YOUR SMOKE ALARM

Your smoke alarm has been designed and manufactured to be as maintenance-free as possible. Here are a few simple steps you must perform, in addition to the weekly tests described in the section "WEEKLY TESTING OF YOUR SMOKE ALARM," to keep your unit in good working order.

- The smoke alarm should be vacuumed monthly or more often if there is dust, dirt or kitchen grease that can accumulate. Use a soft brush or wand attachment and vacuum all slots in the cover and side. FOR YOUR SAFETY, you must properly clean and maintain your smoke alarm, since a dirty or malfunctioning unit may fail to alarm or cause unwanted nuisance alarms.
- If the unit is damaged or fails to operate properly, and you have checked that a good battery is installed correctly, follow the directions in the section "WHERE TO SEND YOUR SMOKE ALARM IF IT NEEDS SERVICE" for return. FOR YOUR SAFETY, DO NOT OPEN THE SMOKE ALARM AND TRY TO REPAIR IT YOURSELF. While smoke alarms are economical devices, they contain precision electronic components that are precisely calibrated. The manufacturer must do repairs.

REPLACING THE BATTERY

The smoke alarm will "beep" once a minute for at least 30 days when the battery is weak. The battery must **immediately** be replaced with a fresh one.

The battery should also be changed if it does not sound an alarm when tested. TO REPLACE THE BATTERY:

1. Check if the tamper resist locking pin is installed in the smoke alarm (see "USING THE TAMPER RESIST LOCKING MECHANISM" section). If so, pull the pin completely out of the smoke alarm using long-nose pliers.

2. Remove the smoke alarm from the mounting bracket by twisting counterclockwise
3. Replace old battery with a fresh one. If your smoke alarm has a safety light, the miniature lamp operates on two AA batteries. (See recommended batteries below.)
4. Check that battery connections are secure and the battery is secured in its compartment
5. Test smoke alarm for proper operation (see "WEEKLY TESTING OF YOUR SMOKE ALARM" section). The smoke alarm operates on a 9-volt battery. The normal battery operating life will be one (1) year. The life of some batteries may be less.
6. Firex smoke alarms sold with Ultralife long-life lithium batteries require replacement approximately every ten (10) years or when the low battery signal sounds.

CAUTION: You should only use the batteries specified here or on the label of the unit.

For Models A, B, C, E and PB use: Eveready 216, 522 or 1222; Mallory MN1604; Duracell MN1604; or Ultralife U9VL-J.

For Model E also use AA Heavy Duty for light power. The miniature lamp operates on two (2) AA batteries. For replacement, use heavy-duty or alkaline AA batteries: Eveready 1215, E91, or Duracell M15HD, MN1500.

CAUTION: Do not use any type of rechargeable batteries.



INTERIOR

USING THE TAMPER RESIST LOCKING MECHANISM

To make the smoke alarm somewhat tamper resistant, a “locking pin” has been provided in the base of the unit. It will help deter a child or other individual from removing the smoke alarm from the bracket. See Figure 7. The following directions can install this.

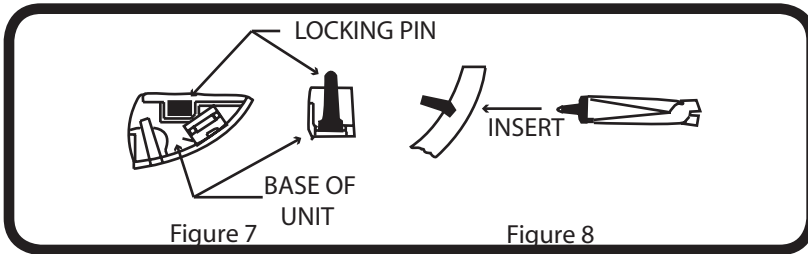

1. Remove the breakaway locking pin from the unit by rocking pin back and forth.
2. Put the smoke alarm back on the mounting bracket. (See section “HOW TO INSTALL YOUR SMOKE ALARM.”)
3. Using long-nose pliers grab the head of the locking pin and insert into hole located on the side of the smoke alarm. See Figure 8.
4. The Tamper Resist feature is now installed and complete.

To Remove:

5. Using long-nose pliers grasp the head of the locking pin and pull the pin completely out of the smoke alarm.
6. The smoke alarm can now be removed from the mounting bracket with a counter-clockwise twist.

SPECIAL SMOKE ALARM FEATURES

If your smoke alarm has one or more of these special features, read the following:

- **BLINKING LED LIGHT** (Models B, C, E and PB): The indicator light under the Push-to Test button blinks about once per minute to indicate the smoke alarm is receiving power.

 **WARNING:** Very thick smoke may obscure the light.

 **WARNING:** Detector Battery is shipped deactivated: To activate battery, new Airstream owner must install included battery to proper orientation.

LP GAS DETECTOR

In the kitchen area of your unit, approximately six inches above the floor, is the LP gas detector. LP gas is a mixture of gases produced and sold commercially as a fuel for heating and cooking appliances. LP gas is highly flammable and, as a result, can be explosive if ignited under certain circumstances. LP gas is heavier than air and, if confined in a closed space, will accumulate close to the floor. When the LP gas concentration in your unit exceeds 2000 PPM the detector will provide a visual and audible alarm by sounding a buzzer and flashing the red LED two times per second.

 **WARNING:** Activation of this detector indicates the presence of LP gas, which can cause an explosion and/or fire. This normally indicates a leak in the LP gas installation or a LP gas appliance. Extinguish all open flames, open your windows and door and evacuate the unit immediately. Do not activate any electrical switch. Turn off the LP at your gas bottle(s). **DO NOT RE-ENTER YOUR UNIT UNTIL A QUALIFIED REPAIR TECHNICIAN HAS CORRECTED THE PROBLEM.**

OPERATION

Your LP gas detector is wired directly to your vehicle batteries and incorporates a 1-amp in-line fuse. When the device is operating normally the green LED will be lit.



WARNING: It is not recommended that the detector be disconnected from the battery during periods of storage. There is a small heater on the sensor of the device, which “burns” away impurities in the air during periods of normal use. During periods when power is interrupted, impurities can build up on the sensor. When power is returned to the detector the detector alarm may activate until the impurities are “burned” off. This could take a number of hours, during which time the alarm will be constantly “on”.

DETECTOR TEST

Press the test button for 5 to 6 seconds until the alarm sounds then release the test button. The red LED should flash and the alarm sound for approximately 4 minutes. This test should be performed at least once a week during normal vehicle operation, and after periods of storage, and before each trip.

LOW VOLTAGE

Below 10 VDC the detector will continue to operate but will blink alternately green and orange. Below 8 VDC the unit will behave erratically and will eventually shut off. To ensure proper operation, do not operate the unit below 10 VDC.

COMPONENT FAILURE

The failure of any circuit component will cause the detector to display a continuous orange LED fault light and a short beep indicating failure. If this occurs, immediately contact your dealer or Airstream Customer Service for the name of the nearest detector service center.

Please read the operating instructions for your detector, which have been supplied with the paper work of your unit.



WARNING: Have a professional check your system if you have any doubts.

FIRE EXTINGUISHER

The fire extinguisher just inside your forward door should have the charge checked on a regular basis. Make sure your family, especially the cook, knows how to release the extinguisher storage bracket, and how to properly operate the extinguisher. Check with your local fire department for professional advice on its operation and use if you find the directions on the extinguisher unclear. We're sure they will be happy to assist you and your family.

SAFETY:

Many things can be construed as safety related, but the most important is your common sense. If you are careless with matches, cigarettes, flammable material or any other hazardous material, we are sure you realize your potential for accidents is greatly increased.

INTERIOR

CARBON MONOXIDE ALARM

The following information is highlights from the folder provided by the alarm manufacturer. The folder, with more detailed information, is contained in your Owners' Packet.

CAREFULLY READ AND UNDERSTAND THE COMPLETE CONTENTS OF THE INSTRUCTION MANUAL BEFORE USING THE ALARM. STORE THE MANUAL IN A SAFE PLACE FOR FUTURE REFERENCE. PAY PARTICULAR ATTENTION TO THE SAFETY WARNINGS. PASS THE MANUAL ONTO ANY SUBSEQUENT USERS OF THE ALARM



WARNING: Activation of your CO alarm's audible horn indicates the presence of carbon monoxide (CO) which can KILL YOU. LEAVE THE AREA IMMEDIATELY!



WARNING: Alarm battery is shipped deactivated. Check your alarm for proper battery installation.



WARNING: THIS PRODUCT IS INTENDED FOR USE IN ORDINARY INDOOR LOCATIONS OF FAMILY LIVING UNITS. IT IS NOT DESIGNED TO MEASURE COMPLIANCE WITH OCCUPATIONAL SAFETY AND HEALTH ADMINISTRATION (OSHA) COMMERCIAL OR INDUSTRIAL STANDARDS. INDIVIDUALS WHO ARE AT SPECIAL RISK FROM CARBON MONOXIDE EXPOSURE BY REASON OF AGE, PREGNANCY OR MEDICAL CONDITION MAY CONSIDER USING WARNING DEVICES WHICH PROVIDE AUDIBLE AND VISUAL SIGNALS FOR CARBON MONOXIDE CONCENTRATION UNDER 30 PPM. IF IN DOUBT CONSULT YOUR MEDICAL PRACTITIONER.

THIS CARBON MONOXIDE ALARM IS NOT

1. Designed to detect smoke, fire or any gas other than carbon monoxide.
2. To be seen as a substitute for the proper servicing of fuel-burning appliances.
3. To be used on an intermittent basis, or as a portable alarm for spillage of combustion products from fuel-burning appliances.

CAUTION: This carbon monoxide alarm is designed for indoor use only. Do not expose to rain or moisture. Do not knock or drop the alarm. Do not open or tamper with the alarm as this could cause malfunction. The alarm will not protect against the risk of carbon monoxide poisoning when the batteries are dead or missing. The alarm will only indicate the presence of carbon monoxide gas at the sensor. Carbon monoxide gas may be present in other areas.

IMPORTANT

1. Carbon monoxide is produced by the incomplete combustion of fuels such as wood, charcoal, coal, heating oil, paraffin, gasoline, natural gas, propane, butane, etc.
2. Ideally, it is recommended that a carbon monoxide alarm should be installed in or near every room that has a fuel burning appliance such as any room heaters, water heaters, cookers, grills, etc.
3. Ensure that the alarm horn can be heard by all those who are intended to hear it. Seek medical help if it is suspected that a user of the RV is suffering from carbon monoxide poisoning.
4. If the alarm sounds, make sure to investigate the problem. Ignoring the alarm may result in sickness, injury or death. (CO may be present even if nothing is seen or smelled by the user).
5. Room spaces should be well ventilated when household cleaning supplies are used as these may cause a false alarm.
6. Alarm should be tested once per week. If further details are required which do not appear in this manual contact BRK Brands Inc. First Alert.

Introduction

This alarm which is designed to detect the presence of carbon monoxide. This manual contains information on operation of the CO alarm. The green light flashes at approximately 60-second intervals to indicate the alarm is operating correctly. The red light will flash continuously and the horn will sound if carbon monoxide is detected. The alarm is suitable for use in areas where cooking and heating appliances burn fuels such as wood, charcoal, coal, oil, gas, etc. This carbon monoxide alarm is designed to detect carbon monoxide gas from any source of combustion.

WHAT IS CARBON MONOXIDE

Carbon monoxide (CO) is a highly poisonous gas which is released when fuels are burnt. It is invisible, has no smell and is therefore very difficult to detect with the human senses. Under normal conditions, in a room where fuel burning appliances are well maintained and correctly ventilated, the amount of carbon monoxide released into the room by appliances is not dangerous.

These fuels include: Wood, coal, charcoal, oil, natural gas, gasoline, kerosene, and propane. Common appliances are often sources of CO. If they are not properly maintained, are improperly ventilated, or malfunction, CO levels can rise quickly. CO is a real danger in "Air-tight" RVs with added insulation, sealed windows, and other weatherproofing can "trap" CO inside.

The following conditions can result in potentially dangerous CO situations.

1. Excessive spillage or reverse venting of fuel burning appliances caused by outdoor conditions, such as:
 - A. Wind direction and/or velocity: including high gusts of wind. Heavy air in the vent pipes (cold/humid air with extended periods between cycles).
 - B. Negative pressure differential resulting from use of exhaust fans.
 - C. Simultaneous operation of several fuel burning appliances competing for limited internal air.
 - D. Vent pipe connections vibrating loose from clothes dryers, furnaces or water heaters.
 - E. Obstructions in or unconventional vent pipe designs which can amplify the above situations.
2. Extended use of un-vented fuel burning devices.
3. Temperature increase that can trap exhaust gases near the ground.

SYMPTOMS OF CARBON MONOXIDE POISONING.

The following symptoms are related to CO POISONING and should be discussed with users of the RV.

Mild Exposure - Slight headache, nausea, vomiting, fatigue, ("flu-like" symptoms),

Medium Exposure - Throbbing headache, drowsiness, confusion, fast heart rate.

Extreme Exposure - Convulsions, unconsciousness, heart and lung failure,

Exposure to carbon monoxide can cause brain damage, death.



WARNING: Many causes of reported CARBON MONOXIDE POISONING indicate that while victims are aware that they are not well, they become so dis-oriented that they are unable to save themselves by either exiting the building or calling for assistance. Also young children and pets may be the first to be affected.



WARNING: Test units used in RVs after the vehicle has been in storage, before each trip and once a week while in use. Failure to test units used in RV's as described may remove your protection.

CARE AND MAINTENANCE OF ALARM

The alarm should be tested weekly by pressing and holding the test/reset button on the front of the alarm for several seconds. The alarm is pre-calibrated at the factory and requires no maintenance other than to clean the outside casing occasionally with a cloth. Ensure that the holes on the front of the alarm are not blocked with dirt and dust. **DO NOT USE CLEANING AGENTS, BLEACH OR POLISH:** The unit requires 3 x 1.5V alkaline batteries. The following are suitable replacements. Gold Peak 24A LR03, Energizer E92 LR03. Use only the batteries listed. Use of batteries not listed may affect performance of the unit.

USING THE ALARM

To activate the alarm, insert the 3 batteries which are included, fit the battery compartment cover and close the detector lid (battery compartment cover cannot be fitted unless batteries are inserted.) When inserting the batteries, ensure the polarity is correct - ie. positive end of battery (+) align with the (+) symbol in the battery housing. The green and red lights will flash briefly and the horn will sound a short chirp. Press the test/reset button and check that the red light flashes and the horn sounds. The alarm is now operating and ready for use.

PLUMBING

LIQUID PETROLEUM GAS (LPG)

FILL VALVE

Your trailer is equipped with LP tank fill valves called “RV Type I Acme” connection.

The large, green, nylon swivel nut is a right hand thread and is designed for hand operation only.

The valve features an internal spring-loaded module that will not allow gas to flow from the cylinder until a positive seal has been made at the connection. The valve outlet has 1-5/16” Acme threads on the outlet exterior and female POL, left-handed threads on its interior. This feature allows for connection of the new wrenchless, right-handed, Acme RV connection and still accommodates the standard left-handed POL fittings used for filling propane cylinders.

The mating, green swivel nut and brass nipple also incorporates new features: the green nylon nut swivels on a black bushing that is heat sensitive. Between 240 degrees F. and 300 degrees F. the bushing will yield (melt) allowing the spring-loaded module in the valve to push the brass nipple back (approximately 1/4”) closing the module and stopping the flow of gas from the cylinder. Inside the brass nipple is a flow-limiting device designed to sense excessive gas flow. If an excessive flow is sensed, the flow-limiting device shuts the flow down to a maximum of 10 SCFH (Standard Cubic Feet per Hour) or less. This is also referred to as the by-pass flow.

By-pass flow is extremely important in the proper operation of this connection. The flow-limiting device may activate if the cylinder valve is opened quickly. When all appliances are off, the by-pass flow allows the pressure downstream from the flow-limiting device to equalize. When pressure is equalized, the flow-limiting device will supply normal flow to the system. Equalization occurs in approximately 5 seconds and in most cases goes completely unnoticed. If, however, an appliance is left on or there is a leak or open flow in the system, the by-pass pressure will not be able to equalize and allow the flow-limiting device to re-open. Symptoms of this condition

would be appliances that light but have lower than normal flame or starve out from lack of gas, a substantial reduction in the flame when another appliance is operating, or pilots that are difficult to light. If this should happen, the following steps should eliminate the condition:

1. Close LP cylinder valve.
2. Extinguish all flames and smoking materials
3. Be sure all gas appliances, including their pilot lights, are off.
4. Open LP cylinder valve slowly. DO NOT SNAP OPEN.
5. Wait at least 15 seconds before lighting appliances.
6. If operational difficulties continue, there may be a leak in the system. Immediately close the LP cylinder valve and have the system inspected by a qualified RV service technician.

Again, make sure all appliances are off before opening propane cylinder valves. Exception: when reconnecting a full cylinder to an auto changeover regulator it is not necessary to shut off the appliances or close the valve of the cylinder already in service.



WARNING: LEAKING LP GAS MAY IGNITE CAUSING A FIRE OR EXPLOSION WHICH COULD RESULT IN SERIOUS BODILY INJURY, PROPERTY DAMAGE, AND/OR DEATH.

How long a full tank of gas will last is dependent on usage. In cold weather, when you are using the furnace, large amounts of hot water, and are doing extensive cooking, you will naturally use more than you will in warm weather when you may do limited cooking. On the average, with normal cooking and other appliance use you can probably count on two to three weeks of service from each tank.

AUTOMATIC GAS REGULATOR

All models are equipped with a two stage automatic change over gas regulator that offers the convenience of automatic changeover from empty to full gas cylinders. Both tanks are connected to this regulator.

Make sure there is propane in both tanks before you start. Rotate the black lever on the top front side of the regulator toward the cylinder you want to use first. This will be the “service” cylinder and the other will be the “Reserve” cylinder. Slowly open both cylinders valves. Open both cylinder valves completely, then close about 1/4 turn. This will allow you to easily check to see if valves are open or closed. The indicator on top of the regulator will turn bright green. The indicator will stay bright green as long as there is fuel coming from the service cylinder. When the service cylinder empties, the regulator will draw fuel automatically from the reserve cylinder providing an uninterrupted fuel flow to the system. When it switches over, the indicator will change from green to red. This red color indicates the service cylinder is empty and needs to be filled.



WARNING: LP gas regulators must always be installed with the diaphragm vent facing downward. Regulators that are not in compartments have been equipped with a protective cover. Make sure that regulator vent faces downward and that cover is kept in place to minimize vent blockage, which could result in excessive gas pressure causing fire or explosion.



WARNING: The LPG bottles are securely mounted on the front “A” frame of your trailer. If these bottles must be removed for service or replacement it is important that they be reinstalled correctly in order to prevent any possibility of their falling off or becoming dislodged during travel.

LPG BOTTLES

The following step-by-step procedure gives you the proper method of removing and installing these bottles:

1. Turn the knob on your automatic regulator so the arrow points to the tank opposite the one to be removed. Shut off the gas valve on the bottle to be removed.
2. Disconnect the rubber gas line at the bottle to be removed. (The green plastic fitting is a right hand thread and no tools should be used.)
3. Turn the large clamping “T” handle counterclockwise until the hold down bracket is loose enough to remove the bottle. If your trailer is equipped with a gas bottle cover the “T” handle must be removed, and then remove the cover before removing the bottle.

DO NOT REMOVE THE CENTER HOLD DOWN ROD.

To Install

1. Place the bottle in position on the “A” frame and bottle cross member so that it rests on the upper collar of both bottles with the collar rims engaged in the grooves on the underside of the bracket. If your trailer is equipped with a gas bottle cover it should be positioned over the bottles next. Make sure the hold down rod projects up through the hole in the shroud center bracket.
2. Replace the “T” handle and tighten down until the bottles are held firmly in place.
3. Turn on gas shut off valves and test all fittings with a soap suds or detergent solution and watch for bubbles.

If you have allowed both tanks to run out, air may have gotten into the lines. In this event, the air must be forced out through the lines by gas pressure before you will be able to light the pilots. Hold a match to the pilot of the appliance closest to the tanks until it lights and stays lit. Then move to the next closest, etc.



PLUMBING

 **WARNING:** Your LP tanks must be filled as directed by the tank manufacturer. Instructions are located on a decal near the fill valve. The decal must not be defaced.

 **WARNING:** Your LP tank must be, and can only be, placed in the proper position when remounting on the front of the trailer. In any other position the base of the tank will not fit into the recess.

 **WARNING:** Use only the gas bottles furnished with your trailer. If replacement is required it must be a bottle of the same size and design.

 **WARNING:** The vent at the bottom of the regulator must be kept free of any obstructions and must be pointed downward. A good habit is to check the vent each time a bottle is removed for filling. It is especially important to check the vent if the trailer has not been used regularly.

Twice a year, or after a long storage period, we suggest you take your unit in for a checkup and cleaning of the gas operated appliances.

BASIC RULES FOR SAFETY

 **WARNING:** Do not store LP containers within a vehicle. LP containers are equipped with safety devices that vent gas should the pressure become excessive.

 **WARNING:** Do not use cooking appliances for comfort heating. Cooking appliances need fresh air for safe operation. Before operation open an overhead vent or turn on an exhaust fan and open a window.

A warning label has been located in the cooking area to remind you to provide an adequate supply of fresh air for combustion. Unlike homes, the amount of oxygen supply is limited due to the size of the recreational vehicle; and, proper ventilation when using the cooking appliances will avoid dangers of asphyxiation. It is especially important that cooking appliances not be used for comfort heating as the danger of asphyxiation is greater when the appliance is used for long periods of time.

 **WARNING:** Portable fuel burning equipment, including wood and charcoal grills and stoves, shall not be used inside the recreational vehicle. The use of this equipment inside the recreational vehicle may cause fires or asphyxiation.

 **WARNING:** A warning label has been located near the LP gas container. This label reads: **DO NOT FILL CONTAINER (S) TO MORE THAN 80 PERCENT OF CAPACITY.** Overfilling the LP gas container can result in uncontrolled gas flow, which can cause fire or explosion. A properly filled container will contain approximately 80 percent of its volume as liquid LP gas.

 **WARNING:** Do not bring or store LP gas containers, gasoline or other flammable liquids inside the vehicle because a fire or explosion may result.

 **WARNING: IF YOU SMELL GAS:**

1. Extinguish any open flames, pilot lights and all smoking materials.
2. Do not touch electrical switches.
3. Shut off the gas supply at the tank valve(s) or gas supply connection
4. Open doors and other ventilating openings.
5. Leave the area until odor clears.
6. Have the gas system checked and leakage source corrected before using again.

NOTES



PLUMBING

WATER SYSTEM-SELF CONTAINED

Fill the water tank by opening the exterior access door and remove screw cap. A garden hose can now be inserted. It's a good idea to let the water run through the hose for a short time to flush it out. Experienced RVers usually fill their tanks with "home" water to avoid strange water that may be distasteful to them.

The amount of water in the tank may be checked on the Monitor Panel, or you may fill the tank until water overflows out of the fill.

Open the hot side of the galley or lavatory faucet and turn on the water pump switch located on the monitor panel. For some time the open faucet will only sputter. This is because the water heater is being filled and air is being pushed out through the lines. Once the water heater is full a steady stream of water will come from the faucet. Now open a cold faucet. It will sputter for a short time, but will soon expel a steady stream. All other faucets can now be opened until all air is expelled. Once the system is filled with water and the faucets closed, the water pump will shut off. When a faucet is opened the pump will come back on automatically. If the faucet is just barely open it is normal for the pump to cycle on and off rapidly.

SANITIZING

Potable water systems require periodic maintenance to deliver a consistent flow of fresh water. Depending on use and the environment the system is subject to, sanitizing is recommended prior to storing and before using the water system after a period of storage. Systems with new components, or ones that have been subjected to contamination, should also be disinfected as follows:

1. Use one of the following methods to determine the amount of common household bleach needed to sanitize the tank.

A) Multiply "gallons of tank capacity" by 0.13; the result is the ounces of bleach

needed to sanitize the tank.

B) Multiply "Liters of tank capacity" by 1.0; the result is the milliliters of bleach needed to sanitize the tank.

2. Mix into solution the proper amount of bleach within a container of water.
3. Pour the solution (water/bleach) into the tank and fill the tank with potable water.
4. Open all faucets (Hot & Cold) allowing the water to run until the distinct odor of chlorine is detected.
5. The standard solution must have four (4) hours of contact time to disinfect completely. If you double the solution, this concentration allows for contact time of one (1) hour.
6. When the contact time is completed, drain the tank. Refill with potable water and purge the plumbing of all sanitizing solution.

NOTE: The sanitizing procedure outlined above is in conformance with the approved procedures of RVIA ANSI A19.2 and the U.S. Public Health Service.

WATER PUMP AND FILTER

The **19 ft.** model has the water pump located under the roadside front dinette seat. Access is gained by removing the wood panel under the seat cushion.

The **20 ft.** model has the water pump located under the galley. Remove the drawer under the cook top for access.

The **23 ft.** model has the lower section of the roadside wardrobe face panel hinged to open expose the pump and filter.

The **25 ft.** double, twin, and sleep six models all have the lower section of the curbside wardrobe face panel hinged to open and expose the pump and filter.

The **25 ft. Front Bed** is under the under the roadside wardrobe. The bottom cabinet panel pulls off for access.

The **28 ft. W** is under the refrigerator. The bottom cabinet panel pulls off for access.

The **27 ft. Front Bed** is under the under the roadside wardrobe. The bottom two cabinet panels pulls off for access.

To clean the strainer screen, first remove the inlet connection from the pump side of the strainer. This will allow the intake side of the strainer to be rotated about 1/8 turn counterclockwise and be removed. The screen part of the strainer will now be accessible for cleaning.

To reassemble, rotate the inlet side of the strainer until stops are felt. The "O" ring performs the sealing and too much pressure will only break the strainer.

CITY WATER HOOK-UP

The city water hook-up is located on the side of the trailer.

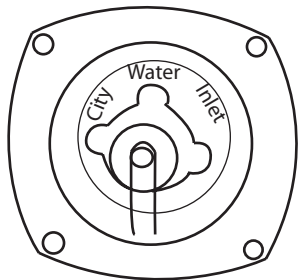

Use a high-pressure hose of at least 1/2" diameter. It should be one that is tasteless, odorless and non-toxic designed for RV use. The city water inlet is a standard garden hose thread. We suggest you carry two lengths of hose. This way you have the ability to reach hookups further away than normal, plus you have a spare hose should one fail or become damaged unexpectedly.

After hooking up the hose and turning on the city water valve provided in the park, slowly open a faucet. There will be a lot of spurts and sputtering until all the air is expelled from the trailer system. If the water heater is empty it will take some time before all the air is expelled and you get a steady flow of water at the faucet. Once a steady flow is achieved at one faucet the others should be opened long enough to expel the air in the lines going to them.

Your plumbing system has a built in pressure regulator to protect your lines and faucets from extremely high pressures on some city water systems.

CAUTION: Turn the Sureflo water pump off when hooked to city water. A check valve inside the pump protects water flowing back to the fresh water tank. See optional pump directions below. The optional Aquatec pump can be turned on while hooked to city water.

Aquajet Pump (Optional)

Water pressure at some campgrounds may be low. The water pump can be turned on to assist the city water hookup pressure. Be sure there is some water in the fresh water tank. The pump will only use the water that is needed out of the tank to bring the pressure up to the usual standard. The water pump should be turned off when the trailer is left unattended.

DRAIN VALVES SAFARI

19 foot Bambi has low point water line drain valves are located in two different places. Two are located under the rear bed and access has been provided in the bed top under the mattress. (If you are long and lanky, they can be reached through the exterior storage compartment.) The other two line drain valves are located under the roadside dinette seat. The water tank drain valve is also located under the same roadside dinette seat.

The 20 foot model has a pair of hot and cold water line drain valves located under the front dinette seat and another pair accessed through the rear exterior access door. Remove the foam cushion and there are two access holes cut in the seat. It has the fresh water tank drain, a white petcock on the tank pan, located under the trailer on the roadside rear.



PLUMBING

The 23 foot model have a white petcock under the trailer on the tank pan between the roadside tires to drain the water tank. The 23 foot model also has two valves located under the bed for draining the hot and cold water lines. They can be reached through a hole in the bed top of through the exterior access door in the rear of the trailer.

The 25 foot sleep six - through curbside rear exterior access door - look to left.

The 25 foot front bed model has an access door on the bed top.

The 25 foot twin and double bed models has access through the exterior roadside rear access door - look to right.

The 25 foot front bed, 28 foot rear bed and the 27 foot front bed has exterior water line drain valves. If you look between your tires you can see a "box" that is a few inches lower than the trailer frame. This "box" or tank pan supports the water tank. The line drains will be the two brass pet cocks extending from the bottom of the pan. The white plastic petcock located on the same pan is to drain the water tank.

To Empty Fresh Water Tank

Pumping the water out with the self-contained water pump can empty the fresh water tank. Simply turn on the pump switch and open a couple of faucets until the water will no longer come out. Or on all models except the 20 foot, use the petcock type drain valve located in the wheel well, which extends out through the tank support pan.

Water Heater Draining

All models have a drain plug or petcock on the water heater. Access is from the exterior. The plug or valve is usually located in the lower left corner, viewed as you face the exterior of the water heater.

WINTERIZING AND STORAGE

When storing your trailer for short or long periods use the same precautions as you would in your own home in regard to perishables, ventilation and rain protection. In addition, for prolonged storage periods flush out all the drain lines and the holding tanks. Also drain the entire water system including the water heater and the water storage tank. Instructions for draining the water system are explained in the following paragraphs on winterizing.

THE MAIN CONSIDERATION IN WINTERIZING IS TO GUARD AGAINST FREEZING DAMAGE TO THE FRESH WATER SYSTEM LINES, TANK, AND PUMP; THE WASTE DRAIN SYSTEM INCLUDING THE TRAPS AND TANKS, THE WATER HEATER AND THE BATTERIES.

To completely winterize your trailer follow this procedure.

1. Level the trailer from side to side and front to rear. Open all faucets.
2. Turn the water pump switch to the ON position to expel water from the storage tank
3. Open all drain valves including drain plug or valve on water heater and exterior water service valve. (See drain valves on previous page)
4. While the water is draining from the system, open and flush the toilet-flushing valve. Depress hand spray lever while holding the spray head down inside the bowl. Depress hand spray thumb button on the telephone shower head while holding down inside the tub and drain all water from the flexible hose. Unscrew the heads on both spray units and store.
5. Turn the pump switch OFF after all water has been removed from the storage tank.
6. Remove exhaust hose from water pump.

7. Disconnect the water pump inlet connection and turn the pump on until all the water is expelled. This water, about 1/2 cup, can be caught in a towel or rag.
 8. Lower the front of the trailer as far as the jack will allow until water ceases to drain, then crank the jack up as high as it will go and let any remaining water drain out.
 9. After the water has stopped running from the drain lines, apply at least 60 lbs. of air pressure at the city water inlet. An air to city water adapter is available from your dealer's RV accessory store. Be sure the toilet valve and all drain valves and faucets are open and pump outlet hose is disconnected. This can be accomplished at a service station and will force any remaining water from the water heater and remove any water which may be trapped in low areas.
 10. Pour a cup of *approved non-toxic RV antifreeze into the lavatory, sink and tub drains to prevent trap freeze-up.
- *Approved and listed by a recognized testing authority such as UL (Underwriter Lab).
11. Be sure to open the waste holding tank drain valves and drain and flush the tanks thoroughly (THIS IS VERY IMPORTANT AS THE SEWAGE IN THE TANKS, IF FROZEN, COULD SERIOUSLY DAMAGE THE TANKS.)
 12. Remove the cartridge of the water purifier and leave the purifier valve in the open position. (If so equipped.)
 13. Remove the batteries from your trailer and store in a cool dry place where there is no danger of freezing. It is very important for optimum life of a battery to check it periodically and to keep it fully charged.
 14. Remove any items (food, cosmetics, etc.) from trailer interior that might be damaged by freezing - or might damage the trailer if containers break.

For additional winterizing protection add a non-toxic antifreeze (approved for drinking

water system) to the water lines using the following procedure.

1. Reconnect all lines except the hose to the pump inlet port. Close all drain valves.
2. Turn by-pass valve to by-pass position. To by-pass the water heater for winterizing, close valves A and C and open valve B (See illustration on next page).
3. Attach a length of hose to the pump inlet port. This piece of hose should be long enough for the free end to be inserted into and reach the bottom of the antifreeze container.
4. Dilute the antifreeze solution in accordance with the manufacturer's instructions
5. Open all water faucets.
6. Insert hose length into the antifreeze container, turn the pump switch on, and run the water pump until the antifreeze solution fills all water lines. Flush toilet. Work hand shower spray while holding down in tub.
7. Shut off the pump and close all faucets.
8. Disconnect the hose length from pump inlet fitting and reconnect water system inlet line.



PLUMBING

Water Heater Bypass

For Normal Operation

Turn water heater by-pass valves to normal flow position. Shut off valve B - open valves A and C.

For Winterizing (bypass position) close valves A and C, open valve B.

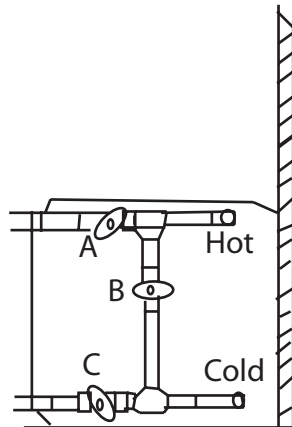

Valve access is:

19 Ft. Bambi and the 23 Ft.- under the corner bed, accessible from holes in the bed top under the mattress.

20 Ft. is under roadside front dinette seat, remove the seat cushion and there are holes in the seat base for access.

25 Ft. Sleep Six and 30 ft. models are assessed through the curbside rear exterior access door.

25 Ft. F B is through the curbside front exterior access door.

25 ft A & B models are accessed through the roadside rear access door.

28 Ft. rear bed model is under the front lounge on the roadside. An access hole is provided in the lounge top.

27 Ft. front bed model is under bathroom lavatory. Open the lavatory cabinet door to access a drop down door. Open the drop down door to access the valves on the water heater.

NOTES



PLUMBING

DRAIN AND WASTE SYSTEM

Your trailer has a drain and waste system that includes waste-holding tanks made from molded plastic, free from corrosion problems, with trouble-free dump valves.

The MAIN HOLDING TANK enables you to use the toilet for several days away from disposal facilities.

The wastewater from the sink, shower, bath and lavatory drains in the AUXILIARY HOLDING TANK. Each tank has its own dump valve, however, both tanks drain through a common outlet. Therefore, you need to make only one connection when hooking up in a trailer park with sewer facilities.

CAUTION: Never put wet strength paper towels or tissues in your holding tank since they won't dissolve and can "catch" in the mechanism of the dump valve. Colored toilet tissue is slower to dissolve than white. Most RV accessory stores offer tissue designed for RVs that will completely dissolve.

Deodorizers

There are many deodorizers on the market in tablet, liquid and powder form. These not only combat odor, but also stimulate the bacteria that works to dissolve the solids in your tank.

Monitor Panel

Check your monitor panel frequently. When the BLACK WATER HOLDING TANK is completely full, sewage cannot be emptied from the toilet bowl. If the GRAY WATER HOLDING TANK is overfilled, drain water will "backup" into the tub and cause an unpleasant cleaning job. Never drain the tanks at any place other than an approved dumping station.

Emptying Tanks

Almost all campgrounds will have dumping facilities. Park directories such as Woodalls and Rand McNally also list dumping stations.

To empty one or both tanks attach the sewer hose by pressing the bayonet fitting onto the dump valve outlet and rotate clockwise until it feels solid and secure. Attach the outlet end of the hose to the sewage outlet; making sure that the hose is placed so it will drain completely.

Pull the dump valve handle as far as it will go and wait until the tank is drained. When dumping, the main holding tank should be dumped first; then the auxiliary holding tank. This will help to rinse out the sewer line with auxiliary holding tank water.

The main holding tank must be flushed out until all paper and waste material is removed. Close the dump valve and refill the tank with clean water and repeat until clean. Replace the cap prior to traveling.

BLACK TANK FLUSH (Optional)

The trailer has a water hose connector marked "black tank flush". To use, hook up a hose and turn on full force. Within the tank a spray head with a multiple holed head will spray the interior surface of the tank. The vacuum breaker and check valve will be located inside the trailer above the exterior connection. In most models this will place them under the lavatory.

The gate valve should be closed for the first couple of minutes, and then opened to let the water out in a rush. Repeat as needed.

When Parked and Connected to Sewer Outlet

When you are in a park and connected to a sewer outlet keep the main holding tank dump valve closed, and empty the tank every few days or whenever it becomes almost full. ONLY BY SENDING A LARGE VOLUME OF LIQUID THROUGH THE MAIN HOLDING TANK AT A TIME WILL TOILET PAPER AND OTHER SOLIDS COMPLETELY WASH AWAY.

This practice will avoid the accumulation of solids in the main holding tank, which could lead to an unpleasant cleaning job. Should solids accumulate, close the dump valve; fill the tank about half full with water, then tow the trailer for a few miles. The turbulence and surging of the water will usually dissolve the solids into suspension so the tank can be drained. Keep the auxiliary tank valve open when connected to a sewer outlet.

Draining the tanks as described will protect them from freezing during storage. When traveling in sub-freezing temperatures use a winterizing solution designed for RV use. Follow the directions on the container.

Drain Systems Cleaning

The only cleaning agents that can be used without causing harm to the system are household ammonia and tri-sodium phosphate in small quantities. Do not use any product that contains any portion of petroleum distillates. This attacks the rubber seals of your toilet and dump valve. Also, do not use any dish detergent or abrasive cleaners. All products should be marked approved for ABS drainage systems.

Use only RV type antifreeze, approved for plumbing systems, when winterizing drains. These are sold through your dealer.



PLUMBING

TOILET

Manufacturer:

Thetford Corporation
7101 Jackson Road
Ann Arbor, MI 48103
313-769-6000

The RV toilet in your Airstream is a design that has been used for many years. There are two pedals. The large pedal opens and closes the slide mechanism, and the smaller pedal opens and closes a water valve.

In normal use, when you are hooked up to city water, both pedals are depressed together. This dumps the sewage and fresh water and flushes down the side of the bowl. Water will continue to run into the bowl for a short time after the pedals are released.

When you wish to conserve water hold the hand-spray head over the bowl and hold down the thumb-operated lever. Now when you depress the pedal all the water is routed through the hand-spray.

CAUTION: When you dump the bowl of the toilet make sure all paper and solids have cleared the slide mechanism before you allow it to close. Failure to do so can cause the groove for the slide to become jammed and the slide will no longer close completely.

If the problem should occur a small nail or bent clothes hanger can be used to “pick” the material out of the groove.

GALLEY FAUCET, MOEN PURETOUCH® CLASSIC (Option Safari)

1-800-374-6542

WATER FILTRATION SAFEGUARDS

Your Moen PureTouch® Classic Filtering Faucet System integrates carbon block filtration technology designed by Culligan International into a faucet spout. This technology is fast and effective at reducing contaminants commonly found in water and is certified by NSF® International. The PureTouch Filtering Faucet System and installation must comply with State and Local laws and regulations. To ensure optimal operation of your new Moen faucet, please read the following safeguards carefully.

MicroTech™ Filter Cartridges

- MicroTech filter cartridges will reduce:
 - Chlorine, Taste and Odor (MicroTech 400, 600)
 - Lead (MicroTech 400,600)
 - Cysts (Cryptosporidium, Giardia) (MicroTech 600)*

*The contaminants removed or reduced by this filter are not necessarily in your water.

- Do not use with water that is micro biologically unsafe or of unknown quality without adequate disinfections before or after the system. Systems certified for cyst reduction may be used on disinfected waters that may contain filterable cysts.
- MicroTech filter cartridges are designed for replacement after dispensing 200 gallons of filtered water. Water conditions and usage may affect filter life and water taste.
- The electronic indicator will signal when filter replacement is necessary
- Use only MicroTech 400 or 600 filter cartridges with the PureTouch *Classic* Filtering Faucet System.
- Filter flow rate = .4-.5 gpm at rated pressure (20 psi min. – 125 psi max.).

Water Temperature

- Minimum/Maximum faucet operating temperature = 40 degrees – 150 degrees F
- **CAUTION:** Do not filter water above 100 degrees F.

MicroTech Filter Flushing Instructions

- New MicroTech Filter Cartridge: Allow cold water to run through a new filter for 5 minutes to flush out any loose carbon particles. Once these small black specks are washed out the filter is ready for use.
- Daily Use: Allow cold water to run through the filter for 10-15 seconds prior to first use. If the filter has not been used for two days, run cold water through the filter for 60 seconds prior to use.

Questions

- If you have any questions please call our toll-free help lines:

1-877-DRINK-H2O

Monday through Friday 8:00 a.m. to 8:00 P.M.

1-877-374-6542

Saturday 8:00 a.m. to 6:30 p.m.



PLUMBING

MICROTECH™ FILTER

INSTALLATION/REPLACEMENT

1. Install a new filter by wetting the outlet ports with water and then inserting into the round filter ports on the faucet head and pushing the filter and head together. Both outlet ports must be fully inserted into the filter ports.
2. Install the filter and faucet head assembly on to the spout by wetting the faucet head O-ring seal and then carefully sliding the free end of the filter into the spout. The head will need to be initially turned approximately 1/2 turn counter clockwise from its normal position to slip past the safety catch. Lock the head into place by simultaneously pushing and twisting the head clockwise. When properly installed the head will feel secure, and will be correctly oriented on the spout.
3. Reset the filter life indicator by pushing the filter button 3 times. Wait 10 seconds. You should not be running water while resetting the filter life indicator because the filter button will remain depressed, with the first push as it switches to filter mode. The filter life indicator has been correctly reset if a short series of rapidly flashing green light occurs, indicating that the new filter-flushing period has begun.
4. Flush the filter for 5 minutes before initial use.

Your new Moen faucet is now ready for normal use.

To replace filter:

1. Turn off the faucet. Remove the faucet head by twisting it approximately 1/4 turn counter clockwise to unlock it. Gently pull the faucet head away from the spout and twist it approximately another 1/4 turn to get the faucet head past the safety catch. The faucet head and depleted filter (if one is installed) can now be pulled completely out of the spout.
2. The filter is held to the faucet head by two outlet ports, which connect into the head. Remove the old filter by simply pulling it straight off. Discard the old filter and install a new MicroTech 400 or 600 filter.

Note: The faucet will function correctly in unfiltered stream mode with or without a filter installed. The faucet will not function correctly in filter mode without a filter. If a filter is not installed and the filter button is depressed, unfiltered water will flow from both the filtered water outlet and the stream outlet aerator, and the filter button will not automatically stay depressed.

Use only Microtech 400 or 600 filter cartridges with the PureTouch Classic Filtering Faucet system. The Microtech filters are high performance carbon block filters developed specifically for the PureTouch system.

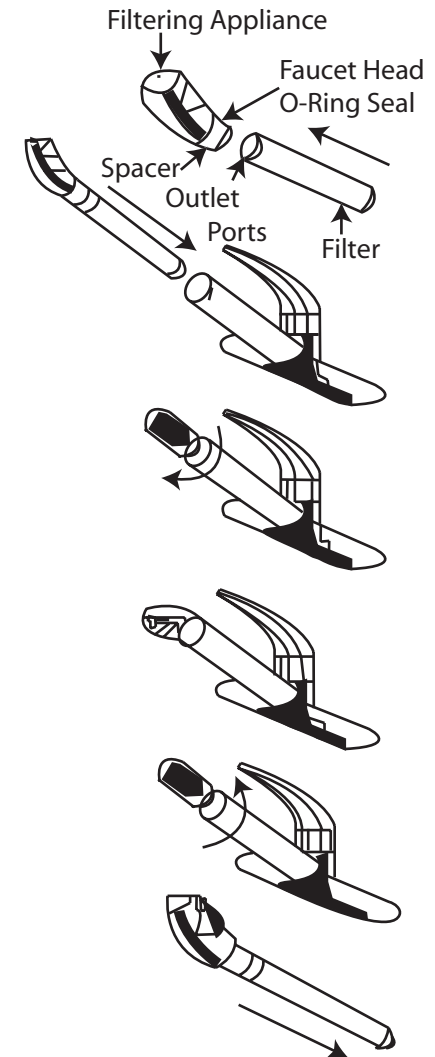

OPERATING INSTRUCTIONS

Controlling The Water

The PureTouch system has two options for water delivery, unfiltered stream and filtered water.

STREAM MODE: Unfiltered water in regular stream flow

When the water is turned on at the faucet, the spout will always begin operating in the regular stream mode.

FILTERED WATER MODE: Filtered water dispensed through the separate filtered water outlet.

Pressing the front filtered water button will divert water through the filter and dispense filtered water from a separate outlet. To exit the filter mode, shut off the faucet.

CAUTION: Only filter cold water. Do not filter water above 100 degrees F.

Electronic Indicator

The flashing light on the electronic filter life indicator provides information regarding the performance of the filter. The indicator provides you with information throughout the life of the filter to help communicate the level at which it is performing.

*If fast red doesn't change to slow amber/green after memory has been reset, the reset was not complete and needs to be redone. Follow step 3 on the previous page.

A standard replaceable 3V lithium watch battery (2032) designed to last several years powers the electronic indicator.

Indicate Color	Performance
Amber & Green	A new filter must be flushed with cold water for 5 minutes after it is installed. This procedure helps clean the filter of loose carbon particles.
Green	Filter performing at optimum efficiency.
Amber	Warning: Filter is ready for replacement. (Approximately 16 gallons left.)
Red	Warning: Filter life is depleted, discard old filter and replace with a new Microtech 400 or 600 filter.

Battery Replacement

Follow filter replacement instructions to remove filter appliance. Locate battery compartment drawer, pull out and replace battery, positive side up.



CARE AND MAINTENANCE

All that is needed to clean your faucet is a soft damp cloth. Moen does not recommend the use of scour pads, cleansers or chemicals. The abrasive nature of these substances could damage the faucet's finish. A non-abrasive car wax will help to protect the finish.

DO NOT SUBMERGE OR PLACE FAUCET HEAD IN DISHWASHER.

PLUMBING

LAVATORY FAUCET, STANDARD

Moen, Chateau Single handled Kitchen Faucet w/Protégé Side Spray

Model 7460

For parts and local warranty service contact Moen at 1-800-Buy Moen

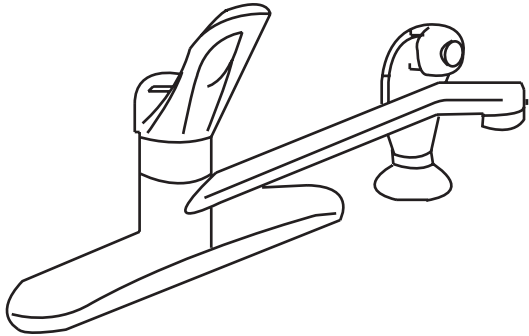

CARE AND MAINTENANCE

All that is needed to clean your faucet is a soft damp cloth. Moen does not recommend the use of scour pads, cleansers or chemicals. The abrasive nature of these substances could damage the faucet's finish. A non-abrasive car wax will help to protect the finish.

DO NOT SUBMERGE OR PLACE FAUCET HEAD IN DISHWASHER.

ELECTRICAL SYSTEM

OPERATION

The major portion of electrical power in your Airstream is 12-volt. The 12-volt current powers the fans, furnaces, water pump, and water heater ignition. The exceptions would be the air conditioner and microwave oven.

All 12-volt current comes through the battery system in the front of your trailer. The batteries are accessible in the battery box on the A-frame of your trailer. Power from the batteries goes to a set of four Type 2 thermal breakers located under the front bed and riveted to the inside skin front plate. The breakers are tied together by a brass bus bar. One breaker (30 Amp.) protects the 12-volt tow vehicle charge line coming from the 7-way cord. Another breaker (20 Amp.) feeds the trailer brakes breakaway switch located near the hitch coupler. A 50-amp breaker feeds the Battery Disconnect relay. The current leaves the relay and goes to the 12-volt distribution panel located in the converter and then to the rest of the trailer. Open the brown decorative door on the front of the converter under the dinette to access the panel and its fuses. A 12-volt layout diagram is shown later in this section.

If you replace a blown fuse and it immediately blows again, do not replace the fuse again until a qualified service technician can correct the problem.

If the replacement fuse holds for a week or more and the gap in the fusible metal is barely melted apart it usually indicates an overload condition. Reducing the number of lights or appliances used on that particular circuit at the same time could prevent any further fuse failure.

BATTERY DISCONNECT SWITCH

The disconnect switch is used to separate the batteries from the 12-volt distribution panel and converter charging system.

When the switch is turned "**use**" (on) and the trailer is plugged into a 110-volt shoreline, the 12-volt distribution panel will receive power from the converter and the batteries will be charged through the converter charging system.

When the switch is turned to "**store**" (off) and the trailer is plugged into a 110-volt shoreline, the 12-volt distribution panel will still receive power from the converter, but the batteries are disconnected from the system. The batteries will not be drained with the switch in the store position. The converter will not charge the batteries with the switch in this position.

The charge in the 12-volt batteries is replenished when towing from the tow vehicle alternator through the 7-way cord. This charge will go to the batteries no matter which position the Battery Disconnect Switch is in.



ELECTRICAL SYSTEM

BATTERY (Lead Acid)

CAUTION: A normal battery can discharge by itself in 30 to 40 days when not in use, therefore, **IT IS NECESSARY TO PERIODICALLY CHECK THE BATTERY AND CHARGE IT AS IS NECESSARY.**

We suggest checking the batteries at least every two weeks in freezing weather. The temperature at which a battery will freeze depends on the condition of its charge. As an example: a fully charged battery with a specific gravity of 1.265 will not freeze until the electrolyte temperature drops to - 71.3 degrees F, while a discharged battery will freeze at +19 degrees F. The following table shows the freezing points of batteries at various specific gravity readings, temperature corrected 80 degrees F.

1.265	-71.3 F
1.250	-62 F
1.200	-16 F
1.100	+5 F
1.150	+19 F

Do not add water to a battery in freezing temperatures unless the vehicle will be put to use at once, otherwise the added water may freeze. Neglect is expensive. Care costs little. Check your batteries regularly.

MAINTAIN A CLEAN BATTERY TOP AND CHECK TERMINALS AND CABLES FOR TIGHTNESS AND CLEANLINESS. A dirty battery will dissipate its charge through surface contamination. Clean battery top with a damp cloth and dry thoroughly.

The terminals should be tight and free of corrosion. To clean terminals, neutralize with a solution of baking soda, rinse in clear water, and dry.

Note: Care must be used to make sure soda is not allowed to enter battery cells.

To insure maximum battery capacity on the charge and the discharge, the battery terminals and the inside portion of the cable connector should be scraped or brushed until both of these surfaces are shiny bright. The cable connectors should then be reconnected to the battery and tightened. The complete assembly, battery post and cable connector should be coated with heavy body mineral grease, petroleum grease or petroleum jell.

CAUTION: RECONNECT THE BATTERY CABLES TO THE CORRECT BATTERY POSTS. The black cable should be connected to the negative (-) post and the red cable to the (+) post. The polarity of your tow vehicle must also be negative (-) ground since it must always match the trailer. Most tow vehicles are negative grounded, but always check your vehicle owner's manual to be sure.

ADD WATER TO CELLS AS NECESSARY. Check the electrolyte level at least once a month. When you are traveling steadily and for an extended period of time, or if you are in climates above 90 degrees F, check the electrolyte level about every two weeks.

CAUTION: Do not fill battery above the split ring in filler opening. **DO NOT MEASURE SPECIFIC GRAVITY IMMEDIATELY** after adding water. The water must mix with the electrolyte by charging or by driving a few miles.



WARNING: The gases generated within a storage battery cell may be ignited by an open flame or spark in the vicinity of the battery. Do not use a match or flame to provide light for checking the level of the water.

During the winter the batteries should be removed from the trailer and stored in a cool, dry place, where there is no danger of freezing. It should be kept full of water, cleaned and charged monthly. A battery that is allowed to completely lose its charge will never regain its original power or a full charge.

ELECTRICAL SYSTEM

For battery service or replacement, go to any service station or dealer who sells and services the make battery installed in your trailer.

When being towed, the 12-volt batteries in your trailer are receiving a constant charge from the tow vehicle's generator or alternator through the seven-way connector.

Your tow vehicle's voltage regulator controls the charge rate. It is important to keep the seven-way connector clean. One method is to use "Spray-Kleen".

Whenever possible use the automatic built in charge of the converter system for charging. The charging circuit automatically controls the current, reducing it as the batteries increase in charge.

At service stations make certain they give your batteries a slow charge because quick charges will drastically shorten the life of the batteries, as will allowing repeated complete discharges.

GLASS MATT BATTERIES (Optional w/Solar Panel Charging System)

In AGM sealed batteries, the acid is absorbed between the plates and immobilized by a very fine fiberglass mat. No silica gel is necessary. This glass mat absorbs and immobilizes the acid while still keeping the acid available to the plates. This allows a fast reaction between acid and plate material.

Battery Maintenance is an important issue. The battery should be cleaned using a baking soda and water mix; a couple of table spoons to a pint of water. Cable connection needs to be clean and tightened regularly.

Battery Storage:

The following recommendations may be helpful if the battery is to be stored:

- When storing the battery in a vehicle or vessel, it is not necessary to leave it on

charge. Disconnect the negative battery cable. This will prevent inadvertent discharging of the battery that may lead to a complete discharge.

Fully charge the battery before putting it in storage and store in a cool place.

- Boost charge the battery every 2 to 3 months to ensure maximum battery life.

POWER CENTER (Converter, 12-Volt Distribution, 110 Volt Distribution)

MagneTec 7300

MagneTec

102 North Main Street

Goodland, Indiana 47948

Phone: (800) 443 4859

Fax: (219) 297 2305

The converter/charging system is the interior low voltage electrical system that enables you to use the interior lights, fans, pumps and 12-volt appliances whether operating on self-contained battery power or 120-volt city power. The 12-volt light bulbs give off the same light as regular household bulbs, so that when operating on self-contained battery power, everything works normally except the 110-volt convenience outlets and 110-volt appliances. The converter system is designed to maintain constant output voltages regardless of the variances that occur in city power systems.

12V POWER CIRCUITS

The current in the converter system is 12 volts direct current (12VDC) negative grounded. Power sources that supply 12VDC current to the system are as follows:

- A. Main charge line from tow vehicle
- B. Trailer Batteries
- C. Converter



ELECTRICAL SYSTEM

The power sources above are all electrically connected to the 12-volt distribution fuse panel that distributes current to interior branch circuits. The circuits provide power to operate all 12-volt DC lights, pumps, motors and appliances.

The 7300 series power converter is a solid-state electronic power supply and is maintenance free. It is so self-sufficient and quiet that you will probably not know it is working except for the fact that your batteries are always charged, and your 12-volt lights and appliances always work. If any 12-volt appliance fails to operate, first check your recreational vehicles 12-volt distribution fuse block located behind the decorative front door in the front right hand corner of the converter and inspect all fuses. If a fuse is opened or blown replace it with the same size fuse (never install a larger use). If the fuse opens again, have an electrician or certified RV technician locate the circuit trouble. Replace blown fuses with Littelfuse type 257 fuses only.

If the 7300 series power converter is not working, first confirm the RV supply or shore-line cord is plugged into a live circuit. Then check all the 120-volt breakers in your RV distribution panel to make sure they are on. If the breaker is tripped, follow the instructions to reset the breakers. If the breaker trips again, consult an electrician or certified RV technician.

CONVERTER OPERATION

The MagneTec 7300 series electronic power converter is designed to supply the nominal 12-volt filtered D.C. power for all 12 volt operated devices encountered in RV service. Although the converter is an excellent battery charger, the converter does not require a battery to be connected to it for proper operation.

CAUTION: When installing a battery (s) always observe polarity. Connecting a battery reverse polarity will blow the power converter main fuses located on the 12 volt D.C. distribution fuse block.

120-VOLT AC PANEL BOARD

The AC panel board section of the series 7300 is located behind the decorative door in the upper left-hand corner. This panel contains the 120 Vac branch circuit breakers for your RV. One of the breakers controls the 120-volt power to the 12-volt converter section located in the lower half of the 7300. This breaker may also control another branch circuit. Check the label next to each breaker for what each branch circuit breaker controls.

The 120 volt circuits may be turned “on” by putting their breaker handle up to the on position or “off” by flipping the handle down to the off position. To reset the tripped breaker move handle to off then on.

CONVERTER COOLING SYSTEM

The 7300 electronic fan cooling system is the key to long life and trouble-free operation. The fan is never on more than required to cool electronic components in the converter. You may never hear the fan operate.

Converter

The converter transforms 120-volt alternating current (AC) into 12-volt direct current (DC). This provides power to charge the trailer battery and to operate the 12 volt interior lighting, fans, and appliances.

The converter is energized only when the trailer is hooked up to 120-volt city power.

Converter Testing

- A. Confirm 120 volt power is going into converter.
- B. Disconnect the 12+ wire from the master switch.



C. Using a voltmeter check voltage output between heavy positive and negative wires coming out of converter.

D. The voltage must be within 13.8 and 14.0 volts. (The meter of the tester should be calibrated periodically.)

E. If converter is not within these voltages, have it serviced by a qualified technician or replace it.

Note: The 7 way wire is spliced to the main harness in the area of the 12-volt distribution panel in front of the trailer.

One of these wires is not spliced onto a wire of the same color. It is the back up wire that is yellow in the cable and black in the harness.

BACK UP CAMERA PRE-WIRE

Your trailer has a 2-pin power connector pre-wired into the running light 12-volt system for the installation of a Power Line Vision System made by Power Linx. For more information on this system contact PowerLinx at their website or call <http://rvenjoyment.com/rearview.htm>.

INVERTOR (option)

The Inverter powers the TV and one additional labeled 110 volt receptacle. The inverter converts 12 volt electricity from your batteries into 110 volt power. The switch for the inverter is located under the monitor panel. Overloading the inverter will cause a automatic shut off to activate. Removing the load will allow the inverter to reset.



ELECTRICAL SYSTEM

12-Volt Circuit Diagram

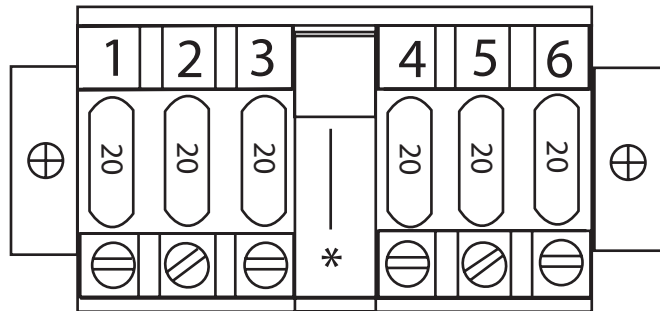

Circuit 1 - Bedroom, Bath fan, Storage compartment lights

Circuit 2 - Living Area, Galley, Radio

Circuit 3 - Water pump, range, Vents/Lights, Refrigerator

* - 12 Volt feed from battery disconnect

Circuit 4 - TV Jacks

Circuit 5 - Ceiling fan, Bath Lights

Circuit 6 - Hitch jack & light, Furnace

G

ELECTRICAL SYSTEM

TV ANTENNA

Manufacturer:

Winegard Company

3000 Kirkwood Street

Burlington, Iowa 52601

Phone: 800-843-4741

Raising Antenna to Operating Position

Turn elevating crank in "UP" direction until some resistance to turning is noted. Antenna is now in operating position. Check to make sure switch on front TV jack is on.

Rotating Antenna

Make sure antenna is in "UP" position. Pull down on directional handle with both hands until it disengages ceiling plate and rotate for best picture and sound on television set.

Lowering Antenna to Travel Position

Rotate antenna until pointer on directional handle aligns with pointer on ceiling plate.



WARNING: Antenna must be in "down" position while traveling to prevent damage.

Turn elevating crank in the "Down" direction until resistance is noted. Antenna is now locked in travel position.

Raising Antenna

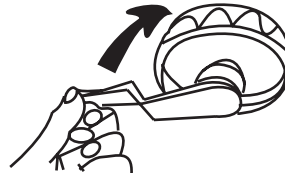

Rotating Antenna



Lowering Antenna

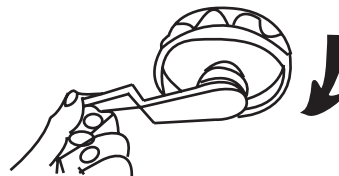

Checking Operation:

1. Tune TV receiver to nearest station and rotate antenna for best picture and sound.
2. Turn off switch on power supply. Picture on TV receiver should be considerably degraded with the power off.

DO'S

1. Do check parking location for obstructions before raising antenna.
2. Do carefully raise, lower and rotate - if difficult, check for cause.
3. Do rotate slowly when selecting station and check fine-tuning on TV set to make sure it is properly adjusted.
4. Do lower antenna before moving vehicle.

DON'TS

1. Don't force elevating crank up or down. Check for cause of trouble.
2. Don't rotate directional handle hard against stops.
3. Don't travel with lift in up position.
4. Don't leave lift part way up or down.
5. Don't apply sealing compound or paint over top of base plate or anywhere on lift.



ELECTRICAL SYSTEM

Maintenance

Lubrication

To lubricate the elevating gear apply a liberal amount of silicone spray lubricant to the elevating gear with the lift in the down position, then run the lift up and down a few times to distribute lubricant over gears.

Lubricating Rotating Gear Housing

In the event that rotating the antenna becomes difficult, lubricating the bearing surface between the rotating gear housing and the base plate can restore normal operation. Any spray type silicone lubricant may be used.

Elevate antenna and remove setscrew from rotating gear housing as shown. Spray lubricant into hole and around edges of gear housing. Rotate gear housing until lubricant coats bearing surfaces and antenna rotates freely.

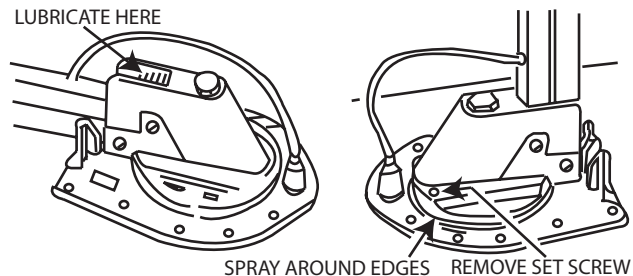

TV Booster/12 Volt Outlet

The TV booster amplifies the signal from the TV antenna. Pushing the small button activates and deactivates the booster. A green light comes on when the booster is activated. For viewing while hooked up to an exterior cable TV source, turn the booster off.

NOTE: The TV Booster must be on to receive antenna signals and off for cable TV operation.

Please review the antenna and booster manuals include in your owner's packet before operating the system.

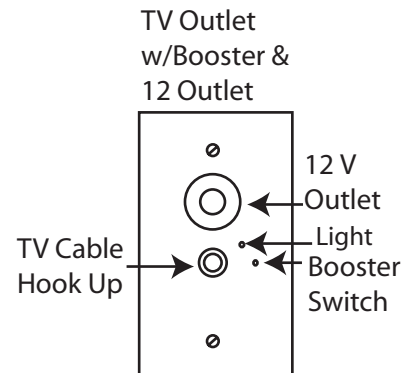

Wireless Speakers (Optional)

Your trailer may have wireless speakers which is included in the optional upgrade package. An operating guide is included with each kit.

ELECTRICAL SYSTEM

SATELLITE ANTENNA WIRING

If you compare the two previous drawings you'll see wiring for a satellite dish antenna is relatively simple.

Units have a faceplate with two coax cable hook-ups. It is located in the TV credenza on all models except the slide-out model with the overhead TV, which is located in the cabinet to the roadside of the TV. The faceplate has a small coax cable jumper running between the hook-ups to complete the cable TV circuit when in use. To install a satellite system use the following procedure:

1. Remove the jumper wire from the coax faceplate.
2. Hook a portable dish into the Cable TV receptacle in the roadside rear underbelly compartment. This feeds the dish signal to the input side of the faceplate.
3. Install the satellite receiver input and output into the dual coax faceplate.

To return to a cable TV system, remove the satellite receiver from the faceplate and reinstall the jumper cable.

COAXIAL CABLE WITH CABLE HOOK UP

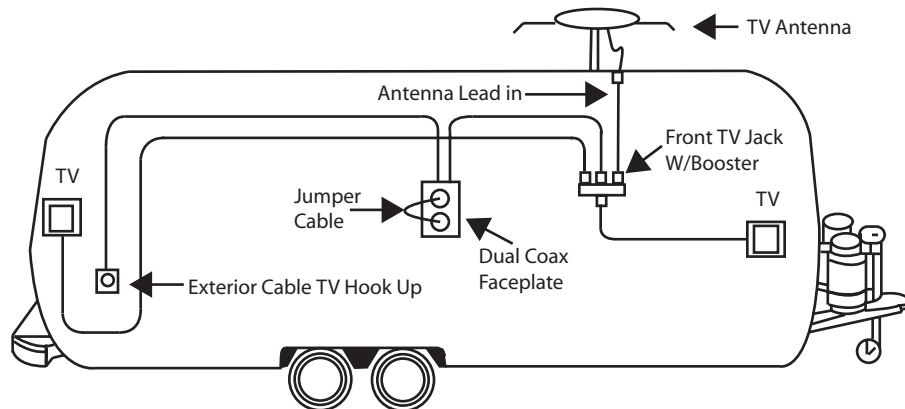

COAXIAL CABLE WITH SATELLITE HOOK UP

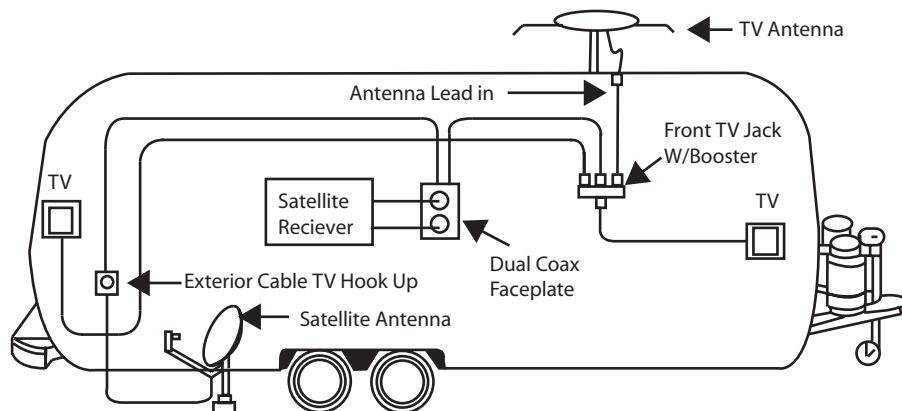

ELECTRICAL SYSTEM

SOLAR PANEL PRE-WIRE

Airstream Travel Trailers are pre-wired for an Intermountain Solar Technology Solar Panel/Charge Controller/Display System. This system may be installed on your trailer as an option. A manual on the use of the system is included with the Airstream Owner's Blue Delivery Case.

Intermountain Solar Technologies
 10288 South Jordan Gateway #D
 South Jordan, UT 84095
 800-671-0169

1. YELLOW (like the sun) positive and GREEN (like the earth) negative leads runs from battery breaker buss bar area to a harness inside the exterior refrigerator access door. The battery buss bar is located behind the sofa on front lounge models or behind the front cabinets on slide outs, and next to the battery compartment. Front bed models have the bar located under the front bed. Battery cables will run to this bar. Roof mounted panels require dropping the panel wires down through the refrigerator vent to the inside of the exterior refrigerator access door. Portable solar panels can be set outside close to the access door. The wires from the solar panel are connected to the positive and negative wires (yellow and green) of the pre-wire system.

2. A Cat 5 patch cord for the solar panel display runs from the battery buss bar to an area just below the CatCon seven display. The solar panel display panel can be mounted just below the CatCon monitor panel

by routing the proper size hole. The Cat 5 wire is plugged into the display panel.

CAUTION: The Yellow wire must be fused with a 10-amp in-line fuse at the 12-volt positive.

NOTE: All wires are identified with labels at all locations.

The Intermountain solar panel has charge controller that should be mounted close to the battery buss bars as the battery leads are hooked into it to sense the actual battery charge. The Cat 5 wire plugs into it also.

The following drawing is the way Airstream wires the system on factory installed units and is the recommended wiring for use of the pre-wire system.

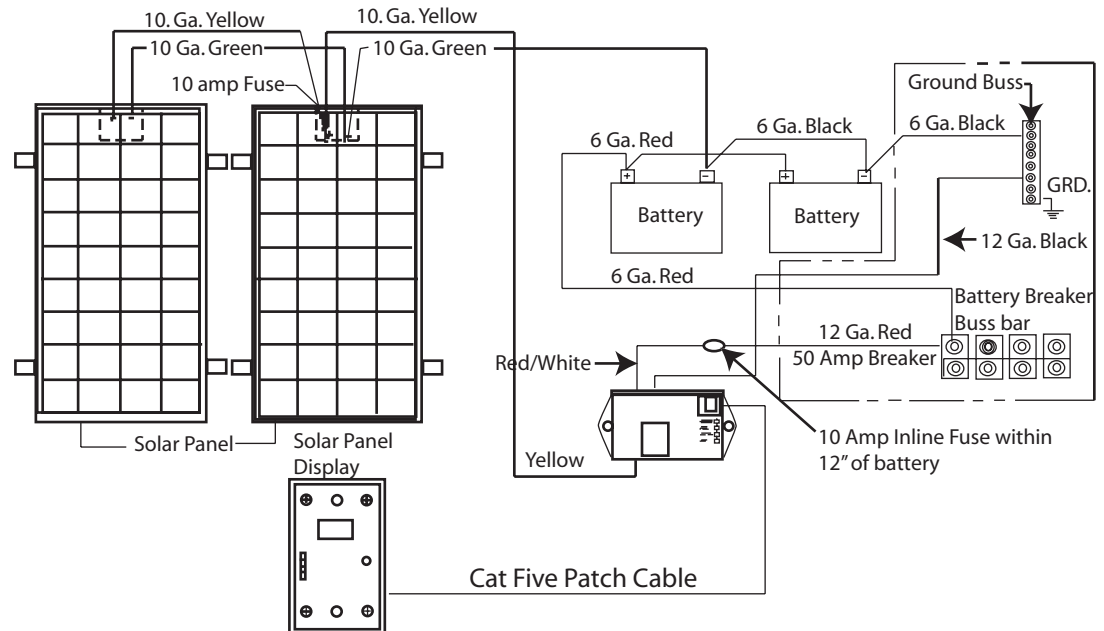

Wireless Speakers (Optional)

Your trailer may have wireless speakers which is included in the optional upgrade package. An operating guide is included with each kit. The selector is located in the front roof locker. A port is located in the selector switch to plug the speaker sending unit.

Operating Guide

- Turn Master Volume to 10.
- Turn speaker selection to outdoor or both.
 - Select mono on speaker (if one speaker being used).
- Adjust volume on speaker to desired level.
- To optimize speaker reception adjust tuning on speaker.
 - Red "tuning light" should be solid.

APPLE I POD / MP3 INPUT. 12 V POWER PORT & RCA JACK CONNECTOR PANEL (option)

A 12 volt port, two RCA jack cords, and a plug in is provided with Audio/Video Upgrade option. These are used to for an Apple Ipod or MP3 player input. Use the SOURCE button on the radio to access the auxiliary port that the Ipod or MP3 player is plugged into.



ELECTRICAL SYSTEM

110-VOLT ELECTRICAL SYSTEM

City Power

The Airstream converter system enables you to use the lights and appliances whether operating on self-contained battery power or hooked up to 110-volt city power. The 12-volt light bulbs give off the same light as regular household bulbs, so that when operating on self-contained battery power, everything works normally except the 110-volt convenience outlets and 110-volt appliances.

Exterior outlets for 110 volts are located on the curbside exterior wall between the wheels and above the wheel well.

CAUTION: When operating with city power make very certain that the service is 110 volt and not 220 volt.

The converter system is a transformer designed to maintain constant output voltages regardless of the variances that occur in city power systems. The design eliminates the need for complex electronic sensing systems to charge the batteries, minimizing the possibility of failures and greatly increasing its overall reliability.



WARNING: When the three-pronged plug can be used there will be no problems with proper polarity or grounding.

In some older parks and other locations where three pronged outlets are not available, certain precautions to insure proper grounding and polarity must be taken. These precautions are listed below:

1. Attach the three-pronged plug to a two-pronged adapter. The third conductor line of this adapter has a short wire lead, which must be grounded.
2. For proper grounding connect the short ground lead to a grounded outlet box

or to a cold water pipe. When no water pipe is available drive a metal rod two feet into the ground and attach the ground lug to it, thus providing the unit with proper grounding.

To operate self-contained, simply disconnect the power supply cable.

When your trailer is hooked up to 110 volt AC, the converter system automatically charges the trailer batteries with the battery disconnect switch in the “use” (on) position and, if the 7-way cord is hooked up, your tow vehicle battery as well. The speed and degree of charge depends on how much power is used for lights and appliances, as only the surplus goes to charging the battery. If you are making an extended stay, then you should keep your trailer hooked up to a 110 volt current if it is available.

While you are connected to the 110-volt receptacle the wiring is protected by circuit breakers in the breaker panel. The circuit breaker panel for the 110-volt system is located in the converter. Open the brown decorative converter door under the dinette.

In the event of a failure of a 110-volt circuit, first check your trailer circuit breakers and the breaker for the outlet your trailer shoreline cord is plugged into. If a breaker continues to trip after you have reset it several times, your circuit may be overloaded with appliances or there may be a short in the circuit. Try lessening the load on the circuit. Perhaps an electric griddle, hair dryer, or an electric heater can be turned off. If that does not solve the problem consult an Airstream Service Center.

The 110-volt electrical system provides power to operate the air conditioner, converter and 110-volt receptacles for portable appliances. The power is carded through the 110-volt city power flexible cord to the 110-volt distribution panel, and then is distributed to each appliance or receptacle.

All wire, components, and wiring methods conform to federal and state requirements.

ELECTRICAL SYSTEM

GROUND FAULT CIRCUIT INTERRUPTER (GFCI)

Many states require trailers which are sold in their state, and which have exterior 110 volt receptacles, to have a ground fault circuit interrupter.

Trailers manufactured for sale in these states have type THQL IS amp GFCI breakers installed on the general circuit, since the exterior breaker is on this circuit. The breaker replaced the standard TQL-15 amp breaker.

When properly installed, the GFCI circuit breaker provides reliable overload and short circuit protection PLUS protection from Ground Faults that might result from contact with a "HOT" load wire and ground.

IMPORTANT NOTE: The GFCI circuit breaker will NOT reduce shock hazard if contact is made between a "HOT" load wire and a neutral wire or 2 "HOT" load wires.

Each GFCI circuit breaker is calibrated to trip with a ground current of 5 milliamperes or more. Since most persons can feel as little as 2 milliamperes, a distinct shock may be felt if the need for protection exists. However, the shock should be of such short duration that the effects would be reduced to less than the normally dangerous level. However, persons with acute heart problems or other conditions that can make a person particularly susceptible to electric shock may still be seriously injured.

While the GFCI circuit breaker affords a high degree of protection, there is no substitute for the knowledge that electricity can be dangerous when carelessly handled or used without reasonable caution.



WARNING: The GFCI circuit breaker provides protection only to the circuit to which it is connected. It does NOT provide protection to any other circuit.

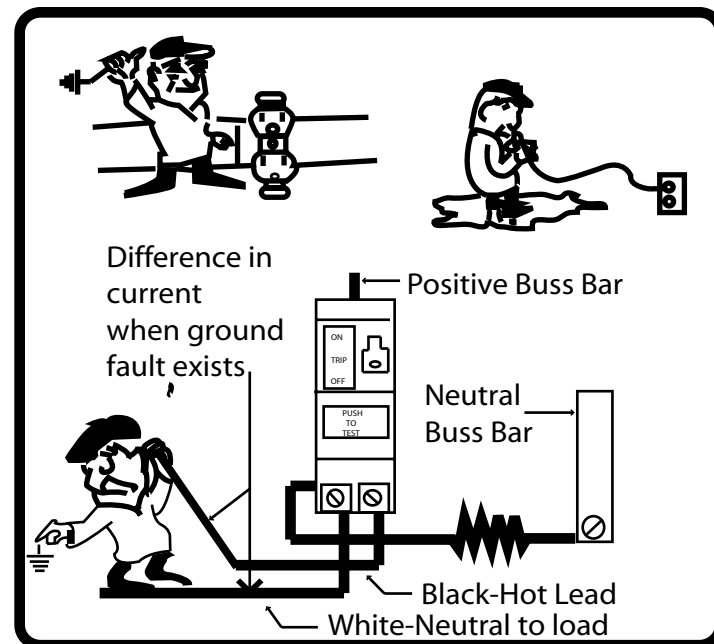

ELECTRICAL SYSTEM

OCCUPANT:

Perform this test on the GFI Breaker each month and record the date on the chart.

1. With handle B in "ON" position, press PUSH TO TEST button A.
2. Handle B should move to TRIP position, indicating that GFCI breaker has opened the circuit.
3. To restore power move handle B to "OFF" and the to "ON"

Important: If handle B does not move to TRIP position when test button is pressed, the GFCI breaker protection is not complete. If this happens, replace GFCI breaker.

	JAN	FEB	MAR	APR	MAY	JUN	JUL	AUG	SEP	OCT	NOV	DEC
2006												
2007												
2008												
2009												
2010												
2011												



APPLIANCES

All appliances are delivered to Airstream Inc. with in depth Owner's Manuals. Those manuals are included in the delivery case supplied by your dealer. The manuals may contain warnings, cautions, and operating instruction that should be read and followed before operating the appliances. The information contained in the appliances manuals supersedes any information contained in the Airstream Trailer Owner's Manual on appliances. If you believe contradictory information on appliances is contained in this manual, please contact the Airstream Customer Service Department at 937-596-6111 or write:

Airstream Factory Service Center
P.O. Box 629
419 W. Pike Street
Jackson Center, Ohio 45334-0629
937-596-6111

If any appliance manuals have not been provided with your trailer, contact your dealer, the respective appliance manufacturer or Airstream Customer Service. A manual will be provided to you.

AIR CONDITIONER

Manufacturer:
Dometic Sales Corporation
2320 Industrial Parkway P.O. Box 490
Elkhart, IN 46515
Phone: 219-295-5228

Note: Review the air conditioning literature supplied in your Owner's Packet before proceeding,

The roof air conditioner used on Airstream trailers is one of the most popular on the market today. In your Owner's Packet is a set of literature covering all operating and

maintenance instructions. If the literature is misplaced please contact the air conditioner manufacturer or your Airstream dealer for replacement.

The voltage to the air conditioner is critical. We commonly refer to 110 or 120 volts, but a check with a voltmeter may find voltage much lower. Your air conditioner will probably not function if the current drops below 105 volts. Low voltage is usually associated with older or poorly maintained trailer parks, but many people have found their homes, built only twenty or thirty years ago, may not be capable of operating the air conditioner on some receptacles, Parking your trailer so the power cord can be plugged into a receptacle close to the fuse or circuit breaker box can alleviate the problem. Avoid extension cords and adapters whenever possible. If an extension cord must be used it should be as short and heavy as possible to provide the most current to the air conditioner.

If high temperatures are expected, make an effort to park in a shaded area. Starting the air conditioner early in the morning also helps. It is much easier to hold a comfortable temperature than it is to lower the temperature after the interior of the trailer is already hot.

FURNACE

Manufacturer:
Hydro Flame Corporation 1874
South Pioneer Road
Salt Lake City, UT 84104
Phone: 801-972-4621

The manufacturer of the furnace in your trailer has been well known in the RV industry for many years. The furnace burns LP gas, and is powered by 12 volt current from the batteries or power converter when plugged into city power. Operating instructions are located in your Owners Packet. If they should become misplaced new literature can be ordered direct from the manufacturer or your Airstream dealer. The manufacturer also



APPLIANCES

offers a detailed service guide for your furnace.



WARNING: Carefully read all the manufacturer's instructions prior to operating. NEVER store flammable material next to the furnace.

NOTE: If warranty service is required use only a service location recommended by the furnace manufacturer or your Airstream dealer.

RANGE

Manufacturer:

Magic Chef

28812 Phillips Street

Elkhart, Indiana 46514

219-264-9578

People using gas ranges in their home will find little difference in the operation of the range in the trailer. Other customers, used to electric ranges may be a little apprehensive at first; but will quickly gain confidence. The basic operation of the gas ranges have been the same for many years, but please be sure to read all the directions furnished by the manufacturer and located in the Owner's Packet. Excellent service and parts manuals are available from the manufacturer.



WARNING: The operation manual for the range is titled "Maytag RV Cooking Appliances". If this has not been provided with your trailer, contact the manufacturer listed at the top of the page to obtain. Their manual contains specialized warnings and cautions that should be reviewed prior to operating the appliance.

MICROWAVE OVENS

Manufacturer:

Dometic Sales Corporation OR Sharp Electronics Corporation

2320 Industrial Parkway

10 Sharp Plaza

P.O. Box 490

Paramus, New Jersey 07652

Elkhart, IN 46515

201-5112-0055

219-295-5228

Only federally certified technicians are permitted to service microwave ovens. For this reason the only service instructions contained in this manual are for removal of the complete oven. If you have a microwave problem please contact the appropriate manufacturer.

Both microwave ovens can be removed for service by removing the screws in the vented trim ring. The trim rings are fastened to microwave oven. After removing the screws, pull straight out on the oven until the 110-volt plug can be unplugged.

REFRIGERATOR

Manufacturer:

Dometic Sales Corporation 2320

Industrial Parkway P.O. Box 490

Elkhart, Indiana 46514

Phone: 1-800-544-4881

Review all refrigerator literature supplied in your Owner's Packet or stored in the refrigerator prior to operating.

In absorption refrigerant system ammonia is liquefied in the finned condenser coil at the top rear of the refrigerator. The liquid ammonia then flows into the evaporator (inside the freezer section) and is exposed to a circulating flow of hydrogen gas, which causes the ammonia to evaporate, creating a cold condition in the freezer.

The tubing in the evaporator section is specifically sloped to provide a continuous movement of liquid ammonia, flowing downward by gravity, through this section. If the refrigerator is operated out-of-level when the vehicle is not moving, liquid ammonia will accumulate in portions of the evaporator tubing. This will slow the circulation of hydrogen and ammonia gas, or in severe cases, completely block it, resulting in a loss of cooling.

Any time the vehicle is parked for several hours with the refrigerator operating the vehicle should be leveled to prevent this loss of cooling. The vehicle needs to be leveled only so it is **comfortable to live in** (no noticeable sloping of floor or walls).

When the vehicle is moving the leveling is not critical, as the rolling and pitching movement of the vehicle will pass to either side of level, keeping the liquid ammonia from accumulating in the evaporator tubing.

OPERATION

The refrigerator requires 12-volt current to operate even if running on LP or 110 volt modes. The 12-volt is used to power the circuit board that directs the refrigerator functions. When running in a mode such as LP, it means the heat source, by far the largest power requirement; to evaporate the ammonia is being provided by an LP Gas burner.

Safari 19, 20, & 23 ft. Models are equipped with a fan inside the exterior refrigerator compartment. This fan pulls ambient temperature air across the condensation coils on the backside of the refrigerator to aid in the cooling. A "Fan Switch" is located inside the main door on the panel in front of the refrigerator. You may desire to turn the fan off when using your patio due to its noise. The fan is thermostatically controlled when the switch is on.

The fan does increase the cooling efficiency of the refrigerator; therefore Airstream recommends leaving the switch on whenever the patio is not in use. Please note that turning the fan off during hot, humid weather conditions may substantially affect the cooling capacity of the refrigerator.



WARNING: Most LP gas appliances used in recreational vehicles are vented to the outside of the vehicle. When parked close to a gasoline pump, it is possible that gasoline fumes could enter this type of appliance and ignite the burner flame, CAUSING A FIRE OR AN EXPLOSION.

APPLIANCES

WATER HEATER

Manufacturer

Atwood Mobile Products 4750

Hiawatha Drive P.O. Box 1205

Rockford, Illinois 61105

Phone: 815-877-7461

Note: Review the water heater literature supplied in your Owner's Packet before proceeding.

CAUTION: Hydrogen gas can be produced in a hot water system served by this heater that has not been used for a long period of time (generally two weeks or more). Hydrogen gas is extremely flammable. To reduce the risk of injury under these conditions, it is recommended that the hot water faucet be opened for several minutes at the kitchen sink before using any electrical appliance connected to the hot water system. If hydrogen is present there will probably be an unusual sound such as air escaping through the pipe as the water begins to flow. There should be no smoking or open flame near the faucet at the time it is open.

Electronic Ignition

The switch used to light your electronic ignition water heater is located in the bathroom above the lavatory top. When the switch is turned on, the red light will come on indicating the "try" mode is in effect. Normally the burner will ignite in just a few seconds, and the light will go out. If your LP system hasn't been used for some time, the system may go into safety lockout (about 20 seconds) before the air is all expelled from the lines. Turning the switch off for 30 seconds, then back on, reinstates the "try" mode.

SAFETY

If your water system is full and cold and the water heater is ignited the system can see pressures as high as 120 psi before the relief valve starts to open. Since the water system normally operates in the 40-psi range the water expanding does put unusual stress on the system. This normally does not cause any problems, but the stress is easily alleviated. As the water is heating just open any faucet and run as little as a cup of water. Just removing this small amount of water reduces the pressure build up significantly.

For fun, watch the sequence of events your family goes through when you park the trailer and ignite the water heater. More than likely someone will run water and relieve the pressure without even realizing it.

HIGH VOLUME ROOF VENT (OPTIONAL)

Manufacturer:

FAN-TASTIC VENT CORP. 4349 S. Dort Hwy.

Burton, MI 48529

1-313-742-0330

1-800-521-0298

The optional High-volume roof vent system is designed to quickly exhaust stale, hot air and draw in fresh air. It's great to use when the outside temperature really doesn't call for air conditioning, but heat has built up in your coach.

OPERATING INSTRUCTIONS:

- 1) Open dome approximately 3" or more (ceiling fan has a built in safety switch that will not allow motor to operate unless dome is partially open).
- 2) Turn 3- speed knob to desired performance lever (3-Low, 2-Medium, 1-High, O-Off)
- 3) Open a window or door for airflow,
- 4) Source of airflow is determined by the window(s) or door(s) opened. For best results, close all roof vents and open 1 (one) window the greatest distance from your Fan-Tastic Vent ceiling fan,

CAUTION: Never place Lindeen™ or a like cover over ceiling fan. Greatly restricted airflow & increased sound levels will occur.

WHEN EQUIPPED WITH REVERSE SWITCH

- 1) Turn fan motor off by:
 - a) Setting 3-speed switch to "O" - OFF.
 - b) Closing Dome.
 - c) Selecting center position on IN/OUT rocker switch
- 2) Wait for fan blade to stop.
- 3) Select IN position, brings air from the roof area into your coach (pressurizes inside).
- 4) Or select OUT position, brings air in through any or all openings in coach and exhausts through the roof. 5) Turn fan motor On.

WHEN EQUIPPED WITH THERMOSTAT:

- 1) Follow "Operating Instructions: 1 thru 4
- 5) Select desired temperature or comfort level on thermostat. Fan motor will now start & stop automatically as interior temperature of coach exceeds or drops below selected level.

NOTE: Fan motor will not start if temperature selected is warmer than interior temperature of coach.

CLEANING INSTRUCTIONS:

- 1) Turn fan motor Off.
- 2) Remove 8 painted flat head Phillips screws around perimeter of screen insert only.
- 3) Clean screen with soap & water solution and reinstall.



APPLIANCES

MONITOR PANEL

Micropulse Systems Monitor
CATCON PRODUCTS INC.
817-921-2188
sales@catconproducts.com
techsupport@catconproducts.com



The MicroPulse System makes use of a single solid-state sensor per tank. The MicroPulse sensor measures the static (head) pressure at the bottom of the tank and transmits this information to the MicroPulse System Monitor. Knowing this pressure value, after a one-time calibration has been performed, the MicroPulse System will calculate and accurately display the tank level in 1/8 increment.

A single sensor is installed on the sidewall of each tank, near the bottom, via a 3/4" female NPT spin-in thread. The sensor is solid state, there are no moving parts to wear or maintain. Because the principle of operation does not involve any electrical current flow through the tanks contents (conducted or induced), the nature of the fluid in the tank is unimportant.

The monitor system has been calibrated at the factory and should never need another calibration. If you feel the system is not operating correctly, please contact CATCON Products or a local Airstream dealer. The following instructions are provided for qualified service technicians.

MONITOR WIRE CONNECTIONS

Red	12VDC, Battery Only
Black	Ground, Battery Only
Purple	Water pump, 15A, 12VDC
White	LPG Sensor, 90 ohm
Fresh	Fresh Tank Sensor
Gray 1	Gray 1 Sensor
Gray 2	Gray 2 Sensor
Black	Black Sensor

MICROPULSE SYSTEMS MONITOR OPERATION INSTRUCTIONS

This example shows the monitor reporting the following:

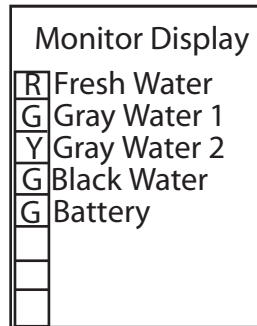

Fresh Water = 7/8 to Full
Gray Water 1 = Empty to 5/8
Gray Water 2 = 3/4
Black Water = Empty to 5/8
Battery = 3/8 to Full.

On the diagram the Letters R=Red, Y=Yellow, G=Green, Blank=no LED lit.

NORMAL OPERATION

The MicroPulse Monitor will display the condition of each system at all times. The tri-color LED beside the system will indicate the condition of the system using the following color code.

Fresh Water & Battery are as follows:

Green LED = 3/8 to Full

Yellow LED = 1/4

Red LED = 1/8 to Empty

Gray Water & Black Water are as follows:

Green LED = Empty to 5/8

Yellow LED = 3/4

Red LED = 7/8 to Full

TO OBTAIN EXACT READING

To obtain an exact reading of all systems press and release the status button one time. The monitor will flash the LED beside the system it is about to report. It will then display the exact condition of that system by lighting the bar graph from Empty to Full. The monitor will display the exact condition of each system and then return to normal operation mode.

To obtain an exact reading of an individual system press and release the status button until the LED beside the system that you want the condition of is lit. Release the status button and the monitor will display the exact condition of that system by lighting the bar graph from Empty.

NOTE: The steel LP tanks on the Safari Models do have a level sensor. The monitor system does not read LP Gas levels.



SPECIFICATIONS

Note: All weights were made on prototype vehicles. Your production trailer may vary slightly. More information on weighing and loading your trailer can be found under “Weight Rating” in the forward section of this manual. Information pertaining to your trailer can be found in your vehicle on the back of the wardrobe door about 60” up from the floor. The Unit Base Weight (UBW) and the Net Carrying Capacity (NCC) is not the same as the Unloaded Vehicle Weight (UVW) and the Cargo Carrying Capacity (CCC) shown on the Trailer Weight Information tag in your vehicle. The UBW and NCC weights are for the base unit with no options and fluids. The UVW and CCC on the Trailer Weight Information tag are weights for the individual vehicle as built with its options and certain water capacities.

SPECIFICATIONS	19'	20'	23'	25' AB	25' SS	25' FB	27'	28'
Length - Exterior	19' 2"	20' 10"	23'	25'11"	25' 11"	25' 11"	28'	27'11"
Width - Exterior	8'	8'	8'	8' 5 ½"	8' 5 ½"	8' 5 ½"	8' 5 ½"	8' 5 ½"
Width-Interior	7' 7"	7' 7"	7' 7"	8' 1"	8' 1"	8' 1"	8' 1"	8' 1"
Height-Ext. w/ A/C	9' 5"	9' 5"	9' 5"	9' 7"	9' 7"	9' 7"	9' 7"	9' 7"
Height-Int. w/ A/C	6' 4½"	6' 4½"	6' 5"	6' 5"	6' 5"	6' 5"	6' 5"	6' 5"
*Hitch ball Height	17 ¼"	17 ¼"	17 ¾"	17 ¾"	17 ¾"	17 ¾"	17 ¾"	17 ¾"
Hitch Wt. (Dry, no options)	480	600	600	860	750	720	790	830
GVWR (lbs.)	4500	5000	6000	7000	7300	7300	7600	7300
UBW (lbs.)	3680	3965	4460	5065	5380	5210	5399	5495
NCC (lbs.)	820	1035	1540	1935	1920	2090	2201	1805
Fresh Water (Gal)	23	23	30	39	39	39	39	39
Gray Water (Gal)	21	21	21	39	39	37	37	37
Black Water (Gal.)	18	18	18	33	18	33	39	35

*** Measuring Hitch Ball Height**

The proper height will vary according to the weight you carry and the tires you use. However, checking the height on your trailer is relatively easy:

1. With trailer on fairly level ground measure from ground to bottom of frame, front and rear.
2. Adjust front jack until measurements are equal.
3. Now measure from ground to the inside top of ball coupler. This figure is the hitch height. The hitch ball is then usually set ½” to 1” higher, according to the spring rate of your tow vehicle, to allow for it to settle when the trailer is hitched up.

SPECIFICATIONS

Gross Vehicular Weight Rating (**GVWR**): is the maximum permissible weight of this trailer when fully loaded. It includes all weight at the trailer axle(s) and tongue or pin.

Unit Base Vehicle Weight (**UBW**): is the dry weight of the base unit with bedroom group and w/o options or fluids.

Net Carrying Capacity (**NCC**): is equal to **GVWR** minus **UBW**.

Gross Axle Weight Rating (**GAWR**): is the value specified as the load carrying capacity of a single axle system, as measured at the tire-ground interfaces.

GAWR Gross Axle Weight Ratings are located on the manufacturing tag that is positioned on the roadside side sheet of your travel trailer.

Tire Size with Maximum Inflation Pressure Cold

ST 215-75 R14 - 50 psi

ST 225-75 R15 - 65 psi

PSI = Pounds per square inch.

INDEX

Accessories	B-10	Cleaning	D-1	Emergency Escape Window.....	C-1, D-2
Air Conditioner	H-1	Circuit Breakers.....	G-1, G-4, G-13	Exhaust Fans.....	E-3
Antenna TV.....	G-7	Condensation.....	C-6	Extended Stay.....	C-3
Appliances.....	H-1	Converter.....	G-3, G-12	Exterior Maintenance	D-1
Axles.....	D-7	Connector		External Speaker Jacks.....	G-11
Awning.....	D-2	7-Way	G-1, G-12		
		110 volt.....	G-12	Factory Service	A-5
Backup Camera Pre-wire	G-5	Couch.....	E-2	Fans.....	E-3, H-5
Backing	B-10	Counter top	E-2	Faucets.....	F-6, F-32
Battery.....	G-2	Coupler.....	D-3	Fill Valves, LP	F-1
Battery Disconnect Switch.....	G-1	Curtains	E-2	Fire Extinguisher.....	E-8
Bath Exhaust	E-3	Control Panel.....	E-3	Flat Tire.....	C-3, D-4
Bathroom Switches	E-4			Furnace	H-1
Bearing	D-7	Dimensions.....	I-1	Fuses.....	G-1
Beds	E-2	Dinette	E-2		
Black Tank	E-3, F-11	Doors:		Galley.....	E-2
Black Tank Flush	F-12	Main.....	D-2	Gas, LP.....	C-5, E-7, F-1
Bottles, LP.....	F-2	Screen	D-2	Grey Tank (Aux)	E-3, F-11, I-1
Brake Controller	B-9, D-9	Drain Valves.....	F-6	Ground Fault Interrupter.....	G-13
Brakes	B-2, B-9, D-9	Drain System.....	F-11	Grounding.....	G-12
Break-Away Switch	B-2, D-9	Drapes.....	E-2	GVWR.....	B-3, I-1
Bulbs	A-8	Dump Valves.....	F-11	GAWR.....	B-3, I-1
Camping.....	C-1	Electrical.....	G-1	High Volume fan	H-7
Carbon Monoxide Alarm	E-9	12 Volt Fuse.....	G-6	Hitch	B-6, I-2
Carpet.....	E-2	110-volt	C-12	Hitching Up	B-6
Capacities.....	I-1	Circuit Breakers.....	G-1, G-12, G-13	Hitch operation.....	D-3
Cargo.....	B-3			Holding Tanks.....	F-11, 1-1
Caution	Introduction	Diagrams		Hitch Ball Height.....	I-1
Chassis.....	D-3	Cable TV.....	G-11	Humidity	C-5
Check List	B-12	Satellite Pre-Wire.....	G-9		
City Water Hook-Up	C-4, F-6	Solar Panel Pre-Wire	G-10		

INDEX

Interior	E-1	Safety	A-5, C-1, E-8, F-3, H-4	Upholstery	E-1
Jacks	B-6, C-2, C-8, D-3, D-10	Safety Chains	B-7	Valves, Drain	F-6
Leveling	C-3	Sanitizing	F-5	Vents	E-3
Lights	E-4	Satellite Hookup	G-9	Warning	Introduction
Loading	B-3, E-4	Screens	D-2	Warranty	A-1
Lounge	E-2	Service	A-5	Washing	D-1
LP Gas	C-5, E-7, F-1	Seven Way Connector	B-2, G-3, G-5	Waste System	F-11
LP Gas Detector	E-7	Sewer Hose	F-11	Water System	F-5
Maintenance Parts	A-8	Shower	E-2	Heater	E-4, F-9, H-4
Maintenance Record	A-9	Sink	E-2	Filter	F-5
Maintenance Schedule	A-6	Slide Out Room	C-8	Tank	F-5, F-7, I-1
Microwave	H-2	Smoke Alarm	E-4	Pump	E-3, F-5, F-6
Mold Prevention	C-7	Sofa	E-2	Inlet Connection	F-6
Monitor Panel	E-3, F-5, F-11, H-6	Solar Panel	G-10	Drainage	F-11
Oven	H-2	Spare Tire Carrier	D-6	Strainer	F-6
Overnight Stop	C-2	Specifications	I-1	Waxing	D-1
Parking	C-2	Stabilizing	C-3	Weight	B-3, D-12
Passing	B-9	Step	D-2	Weight Distribution	B-5
Plumbing	F-1	Storage	E-4	Wheel	
Power Cord	C-4, G-12	Stove	H-2	Torque	D-4
Power Jack	D-10	Table	E-3	Alignment	D-7, I-1
Range	H-2	Tires	D-4, D-11, I-1	Bearing	D-7
Refrigerator	H-3	Tire Changing	C-3, D-4	Windows	D-2
Regulator, LP	F-2	Tongue Latch	D-3	Winter Traveling	C-5
Roof Vents	E-3	Tongue Weight	B-5	Winterizing	F-7
Rotation, Tire	D-6	Toilet	F-13		
		Towing	B-1, B-9		
		Tow Vehicle	B-1, B-7		
		TV Hookup	C-4		
		TV Antenna	G-7		

Airstream Safari Travel Trailer Owners Manual

©AIRSTREAM INC. 2006

Free Manuals Download Website

<http://myh66.com>

<http://usermanuals.us>

<http://www.somanuals.com>

<http://www.4manuals.cc>

<http://www.manual-lib.com>

<http://www.404manual.com>

<http://www.luxmanual.com>

<http://aubethermostatmanual.com>

Golf course search by state

<http://golfingnear.com>

Email search by domain

<http://emailbydomain.com>

Auto manuals search

<http://auto.somanuals.com>

TV manuals search

<http://tv.somanuals.com>