

# aiwa

**OPERATING INSTRUCTIONS  
INSTRUCCIONES DE MANEJO  
MODE D'EMPLOI**

# CA-DW248

**COMPACT DISC CARRY COMPONENT SYSTEM  
SISTEMA DE COMPONENTES DE DISCOS  
COMPACTOS PORTATIL  
MINICHAINÉ PORTABLE A LECTEUR DE CD**

English : See page 2.

En

Español : Ver la página 12.

E

Français : Voir page 22.

F

8B-CTA-903-01  
001130ACK-I-FM

U

**COMPACT  
disc  
DIGITAL AUDIO**

## WARNING

TO REDUCE THE RISK OF FIRE OR ELECTRIC SHOCK, DO NOT EXPOSE THIS APPLIANCE TO RAIN OR MOISTURE.



### Explanation of Graphical Symbols:



The lightning flash with arrowhead symbol, within an equilateral triangle, is intended to alert the user to the presence of uninsulated "dangerous voltage" within the product's enclosure that may be of sufficient magnitude to constitute a risk of electric shock to persons.



The exclamation point within an equilateral triangle is intended to alert the user to the presence of important operating and maintenance (servicing) instructions in the literature accompanying the appliance.

### OWNER'S RECORD

For your convenience, record the model number (you will find it on the rear of the unit) and serial number (you will find it in the battery compartment) in the space provided below. Please refer to them when you contact your AIWA dealer in case of difficulty.

Model No.

Serial No.

## Precautions

Read the Operating Instructions carefully and completely before operating the unit. Be sure to keep the Operating Instructions for future reference. All warnings and cautions in the Operating Instructions and on the unit should be strictly followed, as well as the safety suggestions below.

### Installation

- 1 Water and moisture** - Do not use this unit near water, such as near a bathtub, washbowl, kitchen sink, laundry tub, in a wet basement, swimming pool, or the like.
- 2 Heat** - Do not use this unit near sources of heat, including heating vents, stoves, or other appliances that generate heat.  
It also should not be placed in temperatures less than 5°C (41°F) or greater than 35°C (95°F).
- 3 Mounting surface** - Place the unit on a flat, even surface.
- 4 Ventilation** - The unit should be situated with adequate space around it so that proper heat ventilation is assured.  
Allow 20 cm (7 7/8 in.) clearance from the top, 10 cm (4 in.) from the rear, and 5 cm (2 in.) from each side of the unit.
  - Do not place the unit on a bed, rug, or similar surface that may block the ventilation openings.
  - Do not install the unit in a bookcase, cabinet, or airtight rack where ventilation may be impeded.
- 5 Objects and liquid entry** - Take care that objects or liquids do not get inside the unit through the ventilation openings.
- 6 Carts and stands** - When placed or mounted on a stand or cart, the unit should be moved with care.  
Quick stops, excessive force, and uneven surfaces may cause the unit or cart to overturn or fall.
- 7 Condensation** - Moisture may form on the CD pickup lens when:
  - The unit is moved from a cold spot to a warm spot
  - The heating system has just been turned on
  - The unit is used in a very humid room
  - The unit is cooled by an air conditionerWhen this unit has condensation inside, it may not function normally. Should this occur, leave the unit for a few hours, then try to operate again.
- 8 Wall or ceiling mounting** - The unit should not be mounted on a wall or ceiling, unless specified in the Operating Instructions.



### Electric Power

- 1 Power sources** - Use on batteries or AC house current, as specified in the Operating Instructions and marked on the unit.
- 2 Polarization** - As a safety feature, some units are equipped with polarized AC power plugs which can only be inserted one way into a power outlet. If it is difficult or impossible to insert the AC power plug into an outlet, turn the plug over and try again. If it still does not easily insert into the outlet, please call

a qualified service technician to service or replace the outlet. To avoid defeating the safety feature of the polarized plug, do not force it into a power outlet.

### 3 AC power cord

- When disconnecting the AC power cord, pull it out by the AC power plug. Do not pull the cord itself.
- Never handle the AC power plug with wet hands, as this could result in fire or shock.
- Power cords should be firmly secured to avoid being bent, pinched, or walked upon. Pay particular attention to the cord from the unit to the power socket.
- Avoid overloading AC outlets and extension cords beyond their capacity, as this could result in fire or shock.

**4 Extension cord** - To help prevent electric shock, do not use a polarized AC power plug with an extension cord, receptacle, or other outlet unless the polarized plug can be completely inserted to prevent exposure of the blades of the plug.

**5 When not in use** - Unplug the AC power cord from the AC outlet or remove all the batteries if the unit will not be used for several months or more. When the cord is plugged in, a small amount of current continues to flow to the unit, even when the power is turned off.

### Maintenance

Clean the unit only as recommended in the Operating Instructions.

### Damage Requiring Service

Have the units serviced by a qualified service technician if:

- The AC power cord or plug has been damaged
- Foreign objects or liquid have got inside the unit
- The unit has been exposed to rain or water
- The unit does not seem to operate normally
- The unit exhibits a marked change in performance
- The unit has been dropped, or the cabinet has been damaged

**DO NOT ATTEMPT TO SERVICE THE UNIT YOURSELF.**

## Specifications

### Tuner section

Frequency range, antenna — FM: 87.5 - 108.0 MHz  
Rod antenna, AM: 530 - 1,710 kHz Ferrite bar antenna

### Deck section

Track format — 4 tracks, 2 channels / Frequency range — Normal tape: 50 - 12,000 Hz (EIAJ) / Recording system — AC bias / Erasing system — Magnet erase / Heads — Deck 1: Recording/playback head (1), Erasure head (1); Deck 2: Playback head (1)

### CD player section

Disc — Compact disc / Scanning method — Non-contact optical scanner (semiconductor laser) / Rotation speed — Approx. 500 - 200 rpm/CLV / Error correction — Cross interleave, Reed, Solomon code / Number of channels — 2 channels / D/A conversion — 1 bit DAC

### General

Power requirements — DC 12 V using eight size D (R20) batteries, AC 120 V, 60 Hz / Dimensions (W × H × D) — 274 × 245 × 213 mm (10<sup>7</sup>/<sub>8</sub> × 9<sup>3</sup>/<sub>4</sub> × 8<sup>1</sup>/<sub>2</sub> in.) / Weight — 3.0 kg (6 lb 10 oz.) (excluding batteries) / Power output — 2.5 W + 2.5 W (EIAJ, 7 ohms DC) / Power consumption — 18 W / Accessories — AC cord (1), Remote control (1)

### Speaker

Type — 120 mm cone type / Dimensions (W × H × D) — 160 × 236 × 170 mm (6<sup>3</sup>/<sub>8</sub> × 9<sup>3</sup>/<sub>8</sub> × 6<sup>3</sup>/<sub>4</sub> in.) / Weight — Approx. 0.9 kg (2 lb) × 2 / Impedance — 7 ohms / Allowable max. input — 5 W

Specifications and external appearance are subject to change without notice.

### COPYRIGHT

Please check the copyright laws relating to recordings from disc, radio or external tape for the country in which the machine is being used.

## Power supply

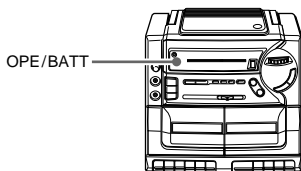

The OPE/BATT indicator lights up while the power is on.

### Using on AC house current

Connect the AC cord as illustrated below.

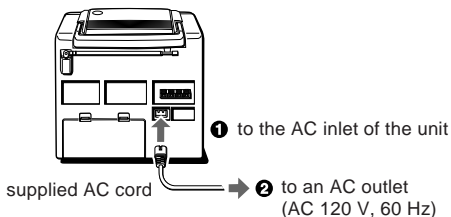

#### CAUTION

Use only the supplied AC cord. Use with other cords may result in the risk of fire.

### Using on batteries

Open the lid of the battery compartment on the rear and insert eight R20 (size D) batteries, not supplied, as illustrated below. Then close the lid.

To switch from AC power supply to battery supply, disconnect the AC cord from the AC inlet.

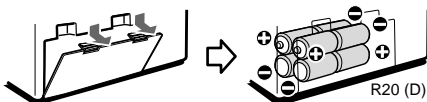

When the OPE/BATT indicator becomes dim, the tape speed slows down, volume decreases, or sound is distorted during operation, replace the batteries.

#### Notes on batteries

To avoid damage from leakage or explosion, observe the following:

- Insert the batteries with the  $\oplus$  and  $\ominus$  marks correctly aligned.
- Do not mix different types of batteries or old batteries with new ones.
- When the unit is not to be used for a long period, remove the batteries.
- Never recharge the batteries, apply heat to them or take them apart.
- Remove dead batteries.

If liquid leaks from the batteries, wipe thoroughly to remove.

## Connections

#### IMPORTANT

- Make sure that the AC cord is disconnected and batteries are removed before connecting speakers.
- Do not connect other than the supplied speakers.

### 1 Position the speakers.

To couple with the speakers, slide each speaker down into the guide brackets on the center unit until the height is level with the unit.

To separate the unit from the speakers, slide the speakers up and off, while pressing the speaker release knob.

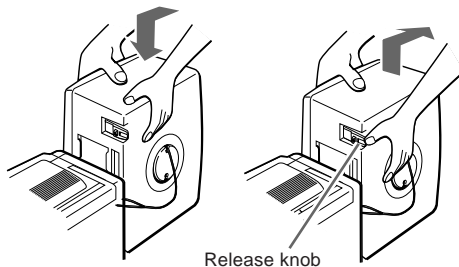

### 2 Connect the speakers.

Connect the right speaker cord to the R terminals, and the left speaker to the L terminals.

Connect the speaker cord with the white broken line to  $\oplus$  and the other cord to  $\ominus$ .

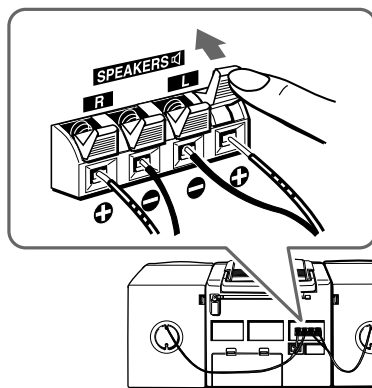

# Remote control

Insert two R6 (size AA) batteries.

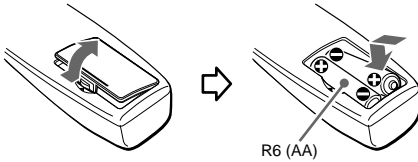

When the reach of the remote control signal is less than 5 meters (16 feet), replace the batteries.

## The remote control may not operate correctly when:

- The unit is exposed to intense light, such as direct sunlight
- Objects block the remote control signal to the unit

## To use the buttons on the remote control

Buttons on the remote control and the main unit with identical indications have the same functions.

## To turn the power on

Press POWER to turn on the display.

When using the unit on the batteries, this button will not turn the power on.

## To turn the power off

Press POWER to turn off the display.

When one of the deck operation buttons is pressed, this button will not turn the power off.

## To use the FUNCTION button

Each time FUNCTION is pressed while the power is on, the function is selected cyclically.



\* applicable when one of the deck operation buttons is pressed

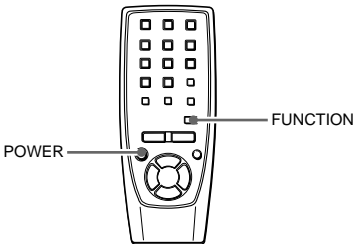

## Maintenance

### To clean the cabinet

Use a soft cloth lightly moistened with mild detergent solution. Do not use strong solvents such as alcohol, benzene or thinner.

### To clean the heads

When the tape heads are dirty;

- high frequency sound is not emitted
- the sound is not adequately high
- the sound is off-balance
- the tape cannot be erased
- the tape cannot be recorded on

After every 10 hours of use, clean the tape heads with a head cleaning cassette.

Use separately sold dry-type or wet-type cleaning cassette.

Refer to the instructions of the cleaning cassette for details.

### To clean the lens

Use a cotton swab slightly moistened with cleaning fluid. Wipe gently from the center to the edge.

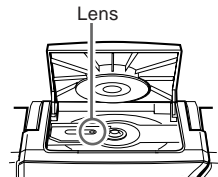

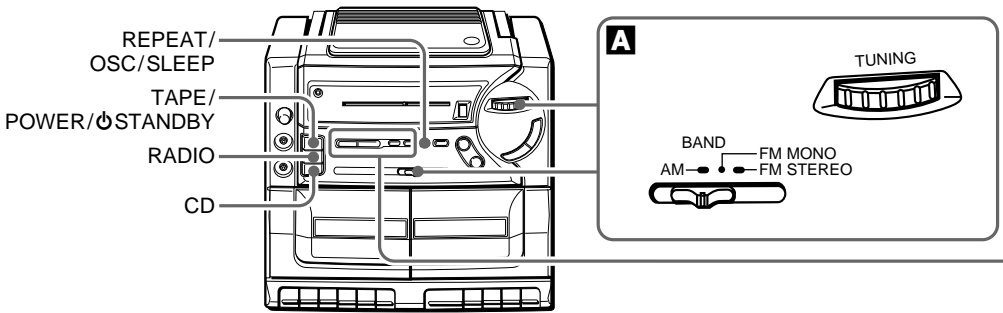

## A TUNER OPERATION

### 1 Press RADIO.

The power is turned on.  
The RADIO indicator lights up and the volume level is displayed.

### 2 Select a band (AM or FM STEREO) with BAND.

### 3 Tune to a station with TUNING.

After listening, press TAPE/POWER/STANDBY to turn the power off.

#### For better reception

FM



Extend the rod antenna and orient it for the best reception.

AM



The antenna is inside the unit. Position the unit for the best reception.

#### If an FM stereo broadcast contains noise

Select FM MONO with BAND.  
Noise is reduced although reception is monaural.  
To restore stereo reception, select FM STEREO.

#### \*REPEAT/OSC/SLEEP

If a high-pitched sound is heard during AM recording, press the button repeatedly until the noise is reduced.  
\* or MODE on the remote control

#### NOTE

If the unit picks up noise from other electrical appliances nearby, like a TV or fluorescent lights, move the unit.

## B CD OPERATION

### 1 Press CD.

The power is turned on and the CD indicator lights up.

### 2 Press CD OPEN to open the disc compartment. Place a disc with the printed side up and close the disc compartment.

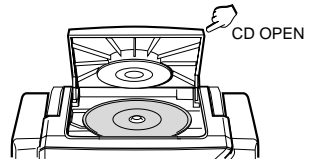

The total number of tracks is displayed. It will take about 15 seconds when loading a CD-RW disc.  
"1" indicates the 1st track, and "• 1" indicates the 11th track. "1" and a flashing "\*" indicate the 21st, 31st ... 91st track.

### 3 Press \* ►► II PLAY/PAUSE to start play.

The number of the track being played is displayed.  
\* or ►► PLAY on the remote control

#### ■ STOP/MEMORY – Stops play.

\* ►► II PLAY/PAUSE – Pauses play. To resume play, press again.  
\* or II PAUSE on the remote control

◀◀, ►► SKIP/SEARCH – Searches for a particular point during playback. Keep ◀◀ or ►► pressed and then release it.

– Skips to the beginning of a track. Press ◀◀ or ►► repeatedly.

\* REPEAT/OSC/SLEEP – Repeats a single track or all tracks. Select as follows.

The REPEAT indicator flashes: A single track is played repeatedly. Select a track with ◀◀ or ►►.

The REPEAT indicator lights up: All tracks are played repeatedly.

\* or REPEAT on the remote control

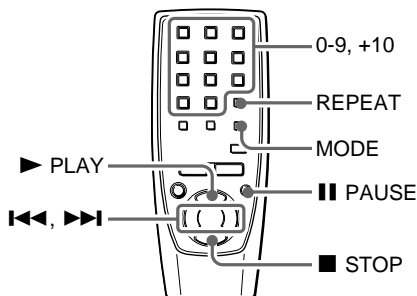
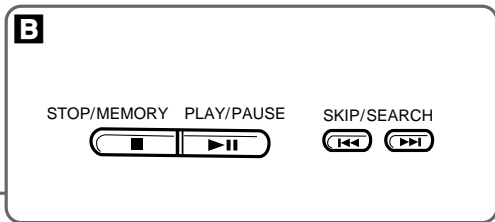

**To start play when the power is off**, press CD. The power is turned on and play of the loaded disc begins (Direct Play Function).  
If you load a disc while the CD indicator flashes in step 2, play starts without pressing ►||.

**To select a track directly with the remote control**, press the numbered buttons 0-9 and +10. CD play starts from the selected track and continues to the last track.

Example:

To select number 25, press +10, +10 and 5.

To select number 10, press +10 and 0.

**After listening**, press TAPE/POWER/⏻STANDBY to turn the power off.

#### NOTE

- Do not use irregular shape CDs (example: heart-shaped, octagonal ones). It may result in malfunctions.
- Do not place more than one disc in the disc compartment.
- Do not try to open the disc compartment during play.
- Do not touch the lens. Doing so may cause malfunctions.
- The unit may not play a CD-R/RW disc that is recorded on personal computers or some kinds of CD-R/W recorders because of differences in recording platforms.
- Do not attach any seal or label to either side (the recordable side or the labeled side) of a CD-R/RW disc. It may cause malfunction.
- Do not load an unrecorded CD-R/RW disc. It will take over 30 seconds to read the disc. The disc may be damaged if you try to open the disc compartment while reading the disc.

## PROGRAMMED PLAY

Up to 20 tracks can be programmed from the disc.

- In stop mode, keep \* ■ STOP/MEMORY pressed until program number flashes in the display.**

\* or ■ STOP on the remote control

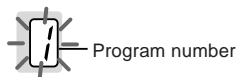

- Press \* ◀◀, ▶▶ to select a track, then press ■ STOP/MEMORY to store it.**

The next program number starts flashing.

\* or the numbered buttons 0-9 and +10 on the remote control

- Repeat step 2 to program other tracks.**

- Keep ■ STOP/MEMORY pressed until ◻ appears in the display to finish the program.**

◻ indicates the unit stores the programmed tracks.

- Press ►|| to start play.**

**To check the program**, press ◀◀ or ▶▶ in stop mode.

**To clear the program**, press ■ once in stop mode so that ◻ disappears in the display.

**To change the programmed tracks**, clear the program and repeat all the steps again.

## C TAPE OPERATION

- Use Type I (normal) tapes only.
- Note that recording is done on only one side of the tape.

### INSERTING A TAPE

Press **■/▲** to open the cassette holder and insert a tape with the exposed side down and the side to be played facing out.

Push the cassette holder to close.

### PLAYING A TAPE

Press **▶** while the power is off.

The power is turned on and play of the inserted tape begins.

The volume level is displayed during tape operation.

**■/▲** – Stops play. The power will be automatically turned off.

**||** – Pauses play. To resume play, press again.

**◀◀/▶▶** – Rewinds/ fast forwards. To stop the winding, press **■/▲**.

#### Continuous play

After play on deck 2 finishes, play on deck 1 will start without interruption.

During play on deck 2, press **||** then press **▶** on deck 1.

**||** on deck 1 will be released at the end of play on deck 2.

## RECORDING FROM A CD OR THE TUNER

**1** Insert a tape to be recorded on into deck 1 with the side to be recorded facing out.

**2** Get ready to record from the source.  
To record from a CD, press CD and load the disc.  
To record from a radio broadcast, press RADIO and tune to a station.

**3** Press **●** on deck 1 to start recording.  
**▶** is pressed simultaneously.  
When the selected function is CD, CD play and recording starts simultaneously.

#### To record only the selected tracks of a CD

- 1 Follow steps 1 to 4 of PROGRAMMED PLAY on page 7 to program tracks.
- 2 Press **●**.

To stop recording, press **■/▲** on deck 1. To stop CD play, press **■** STOP/MEMORY.

To pause recording, press **||**. To resume recording, press again.

To erase recording, press **●** on deck 1 while the power is off.

After recording, press TAPE/POWER/⏻STANDBY to



## DUBBING A TAPE

- 1** Press **TAPE/POWER/⏻STANDBY** to turn the power off.
- 2** Insert a tape to be recorded on into deck 1 with the side to be recorded facing out.
- 3** Insert a tape to be played into deck 2 with the side to be played facing out.
- 4** Press **⏸** then press **●** on deck 1 to enter recording pause mode.  
The power is turned on.  
**▶** is pressed simultaneously.
- 5** Press **HI-SPEED DUBBING** to select a dubbing speed.  
The HI-SPEED DUBBING indicator lights up: Dubs at high speed.  
The HI-SPEED DUBBING indicator goes off: Dubs at normal speed.
- 6** Press **▶** on deck 2.  
**⏸** on deck 1 is released and recording starts.

**To stop recording**, press **■/▲** on deck 1 and deck 2. The power will be automatically turned off.

### NOTE

When recording near a television, noise may be recorded. Move the unit away from the television.

### To prevent accidental erasure

Break off the plastic tabs on the cassette tape with a screwdriver or other pointed tool after recording.

### To record on the tape again

Cover the tab openings with adhesive tape, etc.



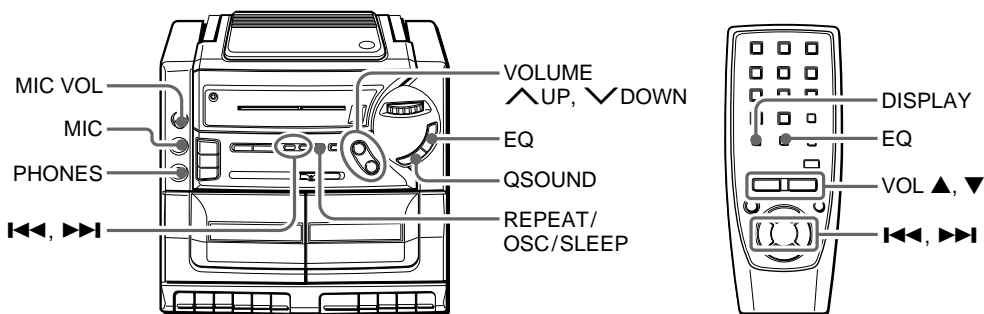

## GENERAL

### SOUND ADJUSTMENT

Volume or tone adjustment does not affect recording.

#### VOLUME (VOL)

Press VOLUME  $\wedge$  UP or  $\vee$  DOWN. The volume level is displayed as a number from 0 to 19.

"1" in the display indicates the level 1 and "• 1" indicates the level 11.

- The volume level is automatically set to 9 if the power is turned off when the volume level is set to 10 or more. (except when turning the power back on within 4 seconds)
- Pressing DISPLAY on the remote control displays the adjusted volume level.

#### 3-mode EQ (equalizer)

Press EQ repeatedly until the desired mode is displayed.

The equalizer mode changes to ROCK, POP, JAZZ or no equalization, cyclically.



**ROCK** - Emphasizes the high and low range of music.

**POP** - Emphasizes voice and midrange of music.

**JAZZ** - Emphasizes the low range of music.

#### QSOUND system

This system provides a rich, three dimensional sound area for stereo sources.

You can enjoy more enhanced sound.

Press QSOUND and the QSOUND indicator lights up.

- At higher volumes, turning QSOUND on may cause sound distortion. In this case, make the volume down.

### SETTING THE SLEEP TIMER

The unit can be turned off automatically at a specified time.

- 1 Keep REPEAT/OSC/SLEEP pressed until "• 1" flashes in the display.



The dot and number flash.

- 2 Within 4 seconds, press  $\lll$  or  $\ggg$  to specify the time until the power is turned off.

Each time it is pressed, the time changes between 10 and 90 minutes in 10-minute steps.

Example: The unit will turn off after 30 minutes.

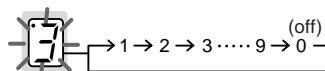

While the sleep timer works the dot keeps flashing.



The volume level or a CD track number.

#### To check the time remaining until the power is turned off

Repeat step 1 shown above. The remaining time is displayed for 4 seconds.

#### To cancel the sleep timer

Display the remaining time and press  $\lll$  or  $\ggg$  repeatedly until  $\square$  (off) is displayed.

#### NOTE

If the unit is turned off during tape playback,  $\blacktriangleright$  on the deck will not be released. Press  $\blacksquare$ / $\blacktriangle$  to release  $\blacktriangleright$ .

## MICROPHONE MIXING

### **Connect a microphone with a mini plug to the MIC jack and play a source to be mixed.**

To record the microphone mixing sound, insert a tape in deck 1 and press ●.

- During dubbing at high speed, the microphone mixing sound is not recorded.

**MIC VOL** – Adjusts the microphone volume. If a howling sound is produced, turn the volume down.

- To prevent howling, hold the microphone away from the speakers. The use of unidirectional type microphones is also recommended.

---

### **To listen with the headphones**

Connect headphones with a stereo mini plug to the PHONES jack.

### **If an erroneous display or malfunction occurs**

Make sure that none of the deck operation buttons is pressed.

Press ■ while pressing TAPE/POWER/⊕STANDBY.

If the unit cannot be reset in the way above, disconnect the AC cord and remove all the batteries to turn off the display.

Leave the unit for a while and turn the power back on.

## **NOTE**

This equipment has been tested and found to comply with the limits for a Class B digital device, pursuant to Part 15 of the FCC Rules. These limits are designed to provide reasonable protection against harmful interference in a residential installation.

This equipment generates, uses, and can radiate radio frequency energy and, if not installed and used in accordance with the instructions, may cause harmful interference to radio communications. However, there is no guarantee that interference will not occur in a particular installation. If this equipment does cause harmful interference to radio or television reception, which can be determined by turning the equipment off and on, the user is encouraged to try to correct the interference by one or more of the following measures:

- ... Reorient or relocate the receiving antenna.
- ... Increase the separation between the equipment and receiver.
- ... Connect the equipment into an outlet on a circuit different from that to which the receiver is connected.
- ... Consult the dealer or an experienced radio/TV technician for help.

## **CAUTION**

Modifications or adjustments to this product, which are not expressly approved by the manufacturer, may void the user's right or authority to operate this product.

**AIWA CO.,LTD.**

Printed in China

## Free Manuals Download Website

<http://myh66.com>

<http://usermanuals.us>

<http://www.somanuals.com>

<http://www.4manuals.cc>

<http://www.manual-lib.com>

<http://www.404manual.com>

<http://www.luxmanual.com>

<http://aubethermostatmanual.com>

Golf course search by state

<http://golfingnear.com>

Email search by domain

<http://emailbydomain.com>

Auto manuals search

<http://auto.somanuals.com>

TV manuals search

<http://tv.somanuals.com>