

DVD PLAYER
PLATINA DVD

XD-DV380

OPERATING INSTRUCTIONS
MANUAL DE INSTRUCCIONES
MODE D'EMPLOI

Owner's record

For your convenience, record the model number and serial number (you will find them on the rear of your set) in the space provided below. Please refer to them when you contact your Aiwa dealer in case of difficulty.

Model No.	Serial No. (Lot No.)

En (English)

E (Español)

F (Français)

For assistance and information,
call toll free 1-800-BUY-AIWA.
(United States and Puerto Rico)



8B-AV3-905-01
010209AMK-Y-L

U

WARNING

TO REDUCE THE RISK OF FIRE OR ELECTRIC SHOCK, DO NOT EXPOSE THIS APPLIANCE TO RAIN OR MOISTURE.

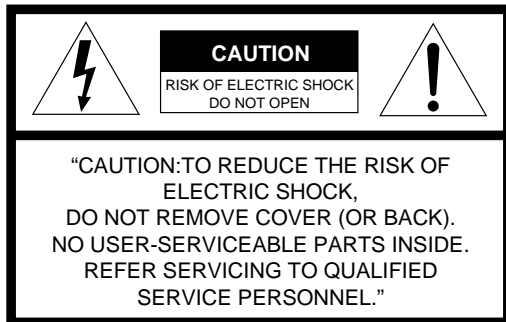

Explanation of Graphical Symbols:

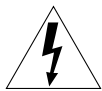

The lightning flash with arrowhead symbol, within an equilateral triangle, is intended to alert the user to the presence of uninsulated "dangerous voltage" within the product's enclosure that may be of sufficient magnitude to constitute a risk of electric shock to persons.



The exclamation point within an equilateral triangle is intended to alert the user to the presence of important operating and maintenance (servicing) instructions in the literature accompanying the appliance.

PRECAUTIONS

Read the Operating Instructions carefully and completely before operating the unit. Be sure to keep the Operating Instructions for future reference. All warnings and cautions in the Operating Instructions and on the unit should be strictly followed, as well as the safety suggestions below.

Important

This unit is designed for the NTSC color systems only.

Installation

- 1 Water and moisture** — Do not use this unit near water, such as near a bathtub, sink, swimming pool, or the like.
- 2 Heat** — Do not use this unit near sources of heat, including heating vents, stoves, or other appliances that generate heat. This unit should not be placed in temperatures less than 5°C (41°F) or greater than 35°C (95°F).
- 3 Mounting place** — Place the unit:
 - on a flat, even surface
 - away from strong magnetic fields
 - at least one meter away from any radios or receivers
 Do not place heavy objects on the unit.
- 4 Ventilation** — The unit should be situated with adequate space around it so that proper heat ventilation is assured. Allow a clearance of 10 cm (4 in.) from the rear and the top of the unit, and 5 cm (2 in.) from each side.

- Do not place the unit on a bed, rug, or similar surface that may block the ventilation openings.
- Do not install the unit in a bookcase, cabinet, or airtight rack where ventilation may be impeded.
- To avoid internal heat build-up, do not cover the ventilation openings on the rear panel.

5 Foreign objects and liquid — Be careful that foreign objects or liquid do not enter the unit through the ventilation openings.

6 Carts and stands — The unit should be moved with care when placed or mounted on a stand or cart. Sudden stops, excessive force, or an uneven surface may cause the unit or cart to fall over.



7 Condensation — Moisture may form on the pickup lens when:

- This unit is moved from a cold spot to a warm spot
- A heating system has just been turned on
- The unit is used in a very humid room
- The unit is cooled by an air conditioner

When this unit has condensation inside, it may not function normally. Should this occur, leave the unit for a few hours, then try to operate again.

Electric power

1 Power sources — Connect this unit only to power sources specified in the Operating Instructions, and as marked on the unit.

2 AC power cord

- When disconnecting the AC power cord, pull it out by the AC power plug. Do not pull the cord itself.
- Never handle the AC power plug with wet hands, as this could result in fire or electrical shock.
- Power cords should be firmly secured to avoid being severely bent, pinched, or walked upon. Pay particular attention to the cord from the unit to the power socket.
- Avoid overloading AC power plugs and extension cords beyond their capacity, as this could result in fire or electrical shock.

3 When not in use — Unplug the AC power cord from the AC outlet if the unit will not be used for several months or more. When the cord is plugged in, a small electrical current continues to flow into the unit, even if the power is turned off.

4 In case of lightning — Immediately disconnect the AC power cord from the AC outlet.

Maintenance

Clean the unit only as recommended in the Operating Instructions.

Damage requiring service

Have this unit serviced by a qualified service technician if:

- The AC power cord or plug has been damaged
- A foreign object or liquid has entered the unit
- The unit has been exposed to rain or water
- The unit does not seem to operate normally
- The unit exhibits a marked change in performance
- The unit has been dropped, or the cabinet has been damaged

DO NOT OPEN THE CABINET AND ATTEMPT TO SERVICE THE UNIT YOURSELF.

TABLE OF CONTENTS

Introduction

Precautions	2
Before Use	4
Supported disc formats	4
Disc-related terms	4
Types of Video CDs	4
Handling the unit	5
Handling discs	5
Cleaning the unit	5
Cleaning discs	5
Storing discs	5
Notes on copyright	5
Parts and Controls	6
Front panel	6
Remote control	7
Display window	8

Preparations

Connections	9
A Connecting to a TV only	10
B Connecting to a TV and an amplifier with a Digital In jack	11
C Connecting to a TV and an audio system	12
D Connecting to an AV receiver equipped with a Dolby Digital (AC-3) decoder	13
E Connecting to an AV receiver equipped with a DTS decoder	14
F Connecting to a TV and an AV receiver with the Dolby Pro Logic Surround system	15
Connecting to a TV equipped with an S-video jack	16
Connecting to a TV or monitor with component video input connectors	17
Remote control	18
About symbols	18

Basic Operations

Playback	19
Still (Pause)	20
Frame Advance	20
Resuming playback	20
Fast Forward and Reverse	21
Slow playback	21
Skipping	21
On Screen Display (OSD) menu	22
Detailed description of each OSD menu	23

More Features

Search	24
Title search/Track search	24
Chapter search	25
Time search	25
Mark Search	26
Zooming and changing the angle	27
Zooming the picture	27
Changing the angle	27
Random and repeat playback	28
Random playback	28
Repeat playback	28
Repeating a portion between two specified points (A-B Repeat)	29
Programmed playback	30
Creating a 3D surround effect	31
Changing the audio track	32

Displaying and changing subtitles	33
Playing back an MP3 disc	34
Notes on MP3 discs	34
Glossary	34
Playing back an MP3 disc	35
Programmed playback	36
Repeat playback	37

As Necessary

Changing setup values	38
Basic operations	38
Disc Audio	39
Disc Subtitle	39
Disc Menu	39
Rating	40
Password	41
TV Aspect	42
Menu Language	43
Digital Audio Output	43
Others	44
Language codes	45
Troubleshooting	46
Specifications	47

Features

DVD provides a completely new dimension in video entertainment.

- **Multi-language function***: You can select an audio soundtrack in up to 8 languages, and subtitles in up to 32 languages.
- **Multi-angle function***: You can select a viewing angle of scenes shot from multiple camera angles and recorded on the disc.
- **Parental lock function***: You can prevent playback of specified discs unsuitable for certain audiences.

* These functions differ depending on the DVD software.

High quality digital audio and images

- **The linear PCM sound of a 96 kHz/24 bit** creates audio quality superior to that of audio CDs.
- **Compatible with video CDs and audio CDs, as well as DVDs**
- **MP3 playback**

Accessory checklist



- Remote control (1)
- Audio cord (1)
- Video cord (1)
- Operating Instructions

BEFORE USE

Please read the following before operating the unit.

Supported disc formats

This unit can play discs with the following marks only.

	DVD (8 cm disc/12 cm disc)
	Video CD (VCD) (8 cm disc/12 cm disc)
	Audio CD (8 cm disc/12 cm disc)

In addition, this unit can play a CD-R or CD-RW that contains audio titles or MP3 files.

NOTES

- Depending on the conditions of the recording equipment or the CD-R/RW disc itself, some CD-R/RW discs cannot be played on the unit.
- The unit cannot play the CD-R/RW discs that contain no data, or contain different kinds of formatted data other than MP3.
For more information about MP3, see page 34.
- Do not attach any seal or label to either side (the labeled side or the recorded side) of a disc.
- Do not use irregular shaped CDs (e.g., heart-shaped or octagonal). It may result in malfunctions.

Notes on color system

This unit is designed for the NTSC color systems only.

The materials for both DVD discs and Video CDs are recorded in the PAL and NTSC color systems.

Select the DVD and Video CD recorded in the NTSC color system.

Notes on DVDs and Video CDs

Some playback operations of DVDs and Video CDs may be intentionally fixed by software manufacturers. As this unit plays DVDs and Video CDs according to disc content designed by the software manufacturer, some playback features of the unit may not be available, or other functions may be added. Refer also to the instructions supplied with the DVDs and Video CDs.

Some DVDs made for business purposes may not be played on the unit.

Region code of the DVD player and DVDs



This DVD player is designed and manufactured for playback of region "1" encoded DVD software. The region code on the labels of some DVD discs indicates which type of player can play those discs. This unit can play only DVD discs labeled "1" or "ALL." If you try to play any other discs, the message "Check Regional Code" will appear on the TV screen. Some DVD discs may not have a region code label even though their playback is prohibited by area limits.

4 **ENGLISH**

Note on DTS-encoded CDs

When playing DTS-encoded CDs, excessive noise will be exhibited from the analog stereo outputs. To avoid possible damage to the audio system, turn down the volume before playing back such discs, adjust the volume gradually, and keep the volume level low. To enjoy DTS Digital Surround™ playback, an external 5.1 channel DTS Digital Surround™ decoder system must be connected to the digital output of the unit.

Disc-related terms

Title (DVD only)

The longest section of a picture or a musical piece on a DVD, a movie for a picture piece on video software, or an album for a musical piece on audio software. Each title is assigned a title number enabling you to locate the title you want.

Chapter (DVD only)

Sections of a picture or a musical piece that are smaller than titles.

A title is composed of several chapters. Each chapter is assigned a chapter number, enabling you to locate the chapter you want. Depending on the disc, no chapters may be recorded.

Track (Video CD and audio CD only)

Sections of a picture or a musical piece on a video CD or an audio CD. Each track is assigned a track number, enabling you to locate the track you want.

Scene

On a Video CD with PBC (Playback control) functions, moving pictures and still pictures are divided into sections called "Scenes." Each scene is displayed in the menu screen and assigned a scene number, enabling you to locate the scene you want.

A scene is composed of one or several tracks.

Types of Video CDs

There are two types of Video CDs:

Video CDs equipped with PBC (Version 2.0)

PBC (Playback control) functions allow you to interact with the system via menus, search functions, or other typical computer-like operations. Moreover, still pictures of high resolution can be played if they are included in the disc.

Video CDs not equipped with PBC (Version 1.1)

Operated in the same way as audio CDs, these discs allow playback of video pictures as well as sound, but they are not equipped with PBC.

Handling the unit

When shipping the unit

The original shipping carton and packing materials come in handy. For maximum protection, re-pack the unit as it was originally packed at the factory.

When setting the unit

The picture and sound of a nearby TV, VCR, or radio may be distorted during playback. In this case, position the unit away from the TV, radio, or VCR, or turn off the unit after removing the disc.

To keep the surface clean

Do not use volatile liquids, such as insecticide spray, near the unit. Do not leave rubber or plastic products in contact with the unit for a long period of time. They will leave marks on the surface.

Handling discs

Do not touch the playback side of the disc.
Hold the disc by the edges so that fingerprints will not get on the surface.
Do not stick paper or tape on the disc.

Cleaning the unit

To clean the cabinet

Use a soft, dry cloth. If the surfaces are extremely dirty, use a soft cloth lightly moistened with a mild detergent solution. Do not use strong solvents, such as alcohol, benzene, or thinner, as these might damage the surface of the unit.

To obtain a clear picture

The DVD player is a high-tech, precision device. If the optical pick-up lens and disc drive parts are dirty or worn down, the picture quality will be poor. Regular inspection and maintenance are recommended after every 1,000 hours of use. (This depends on the operating environment.)
For details, please contact your Aiwa dealer.

Cleaning discs

Fingerprints and dust on the disc can cause poor picture quality and sound distortion. Before playing, clean the disc with a clean cloth. Wipe the disc from the center out.

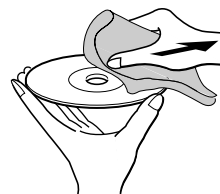

Do not use strong solvents such as alcohol, benzene, thinner, commercially available cleaners, or anti-static spray intended for analog records.

Storing discs

After playing, store the disc in its case.
Do not expose the disc to direct sunlight or sources of heat, or leave it in a parked car exposed to direct sunlight, as there may be a considerable temperature increase inside the car.

Notes on copyright

It is forbidden by law to copy, broadcast, show, broadcast via cable, play in public, or rent copyright material without permission.

This product features the copy protection function developed by Macrovision. Copy protection signals are recorded on some discs. When recording and playing the pictures of these discs on a VCR, the picture noise will appear.

This product incorporates copyright protection technology that is protected by method claims of certain U.S. patents and other intellectual property rights owned by Macrovision Corporation and other rights owners. Use of this copyright protection technology must be authorized by Macrovision Corporation, and is intended for home and other limited viewing uses only unless otherwise authorized by Macrovision Corporation. Reverse engineering or disassembly is prohibited.

PARTS AND CONTROLS

The instructions in this manual refer mainly to the buttons on the remote control. Buttons on the main unit with the same names as those on the remote control can be used as well.

Front panel

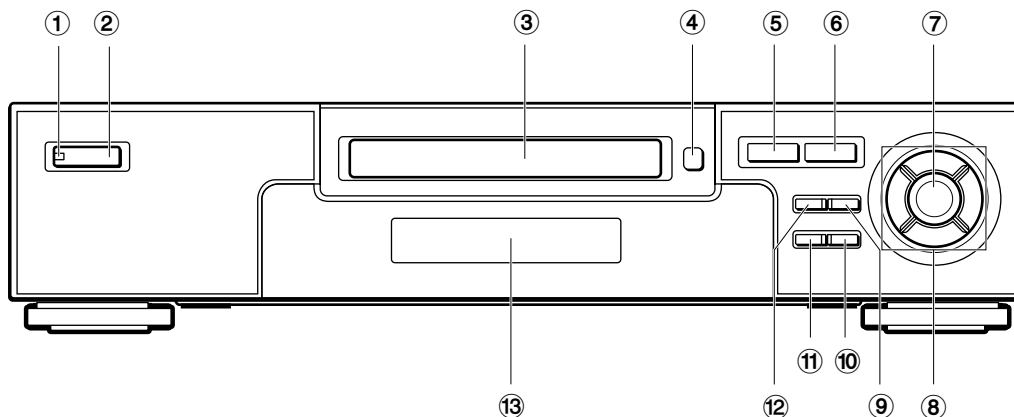

- ① **STANDBY/ON** indicator
 - Lights in red when the unit is in standby mode.
 - Lights in green when the unit is turned on.
- ② **POWER** button
 - Press to turn on and off the unit.
- ③ Disc tray
 - Loading and removing discs.
- ④ **OPEN/CLOSE** button
 - Press to open and close the disc tray.
- ⑤ **PLAY** ► button
 - Press to start playback.
- ⑥ **STOP** ■ button
 - Press to stop playing back a disc.
- ⑦ **ENTER** button
 - Press to execute or fix the selected item from a disc menu.
- ⑧ ▲/▼/◀/▶ cursor buttons
 - Press to select an item.
- ⑨ ►►/►►► button
 - Press to skip to the next chapter/track.
 - Hold down to fast forward a disc.
- ⑩ **MENU** button
 - Press to display menu programs on the DVD.
- ⑪ **PAUSE** ■■ button
 - Press to pause playback.
- ⑫ ◀◀/◀◀ button
 - Press to return to the beginning of the current chapter/track or skip back to the previous chapter/track.
 - Hold down to fast reverse a disc.
- ⑬ **Display window**
 - Displays the information of the unit's status.

Remote control

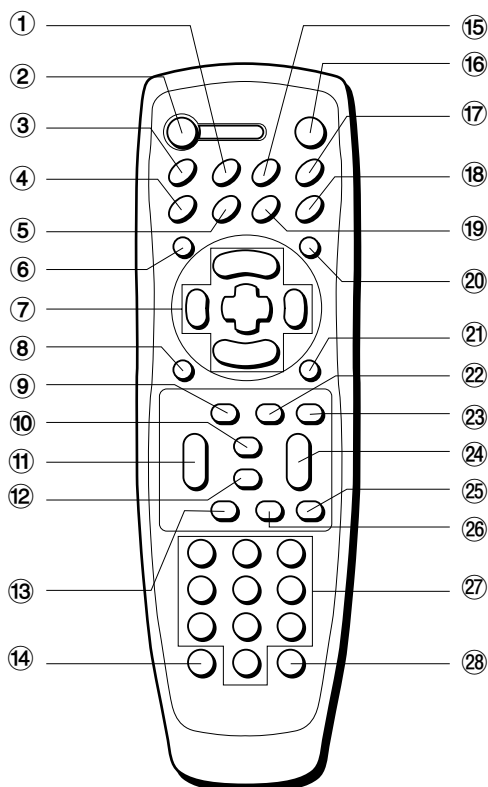

- ① **A-B** button
Press to memorize the point you want to repeat.
- ② **POWER** button
Press to turn on and off the unit.
- ③ **REPEAT** button
Press to repeat playback.
- ④ **AUDIO** button
Press to select the sound tracks.
- ⑤ **SUBTITLE** button
Press to change the subtitle language during DVD playback.
- ⑥ **TOP MENU** button
Press to display the title menu on the DVD.
- ⑦ **▲/▼/◀/▶/ENTER** buttons
- Press a ▲/▼/◀/▶ cursor button to select an item.
 - Press **ENTER** to execute or fix the selected item from a disc menu.
- ⑧ **↶ RETURN** button
- Press to display the title menu of a Video CD that supports PBC (Playback control).
 - Press to exit the setup menu screen.
- ⑨ **MARK** button
Press to mark any point in a DVD during playback.
- ⑩ **▶ PLAY** button
Press to start playback.
- ⑪ **▶▶/◀◀ SEARCH** button
- Hold down ▶▶ to fast forward a disc.
 - Hold down ◀◀ to fast reverse a disc.
- ⑫ **■ STOP** button
Press to stop playing back a disc.
- ⑬ **|| PAUSE/STEP** button
- Press to pause playback.
 - Each time you press it, the program advances one frame.
- ⑭ **PROGRAM** button
Press to program titles/tracks.
- ⑮ **RANDOM** button
Press to play in random order.
- ⑯ **▲ OPEN/CLOSE** button
Press to open and close the disc tray.
- ⑰ **DISPLAY** button
Press to display the On Screen Display information.
- ⑱ **ZOOM** button
Press to enlarge the picture during DVD playback.
- ⑲ **ANGLE** button
Press to change the picture angle during DVD playback.
- ⑳ **MENU** button
Press to display menu programs on the DVD.
- ㉑ **SETUP** button
Press to display the setup menu on the TV screen.
- ㉒ **M-SEARCH** button
Press to display the marked point on the TV screen during playback or in stop mode.
- ㉓ **3D** button
Press to turn on and off the 3D surround effect.
- ㉔ **▶▶/◀◀ SKIP** button
- Press ▶▶ to skip the next chapter/track.
 - Press ◀◀ to return to the beginning of the current chapter/track or skip back to the previous chapter/track.
- ㉕ **F.SLOW** button
Press to execute a forward slow playback when playing a DVD or Video CD.
- ㉖ **B.SLOW** button
Press to execute a backward slow playback when playing a DVD.
- ㉗ **Number** buttons
Press to select a track or title directly.
- ㉘ **CLEAR** button
- Press to clear the MARK memory.
 - Press to cancel a wrong track number when programming tracks on the disc.

En

CONTINUE

ENGLISH 7

PARTS AND CONTROLS (CONTINUED)

Display window

This unit shows On-Screen Display messages on the screen of the TV connected to the unit, as well as the display window of the unit.

The On-Screen Display of each operation makes operation simple and easy, especially when playing DVDs or Video CDs. They appear when you press the DISPLAY button on the remote control.

The instructions in this manual refer mainly to the On-Screen Display messages.

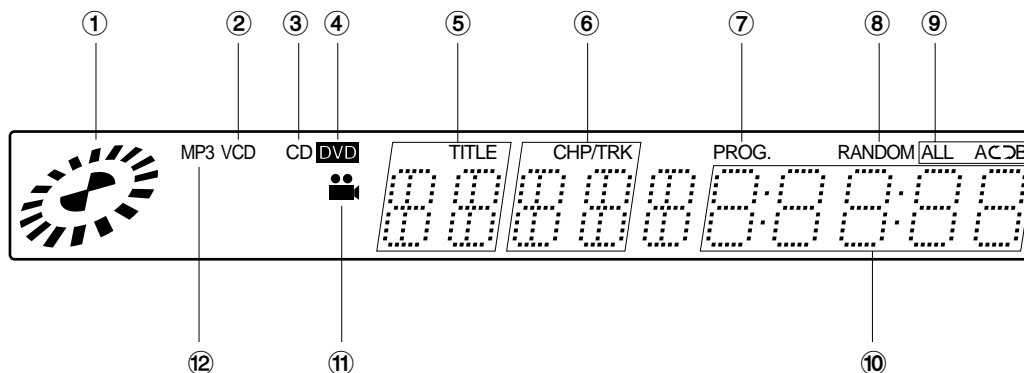

- ① **Operating status** indicator
Rotates when loading and playing back a disc.
- ② **VCD** indicator
Lights when a Video CD is loaded.
- ③ **CD** indicator
Lights when a CD is loaded.
- ④ **DVD** indicator
Lights when a DVD is loaded.
- ⑤ **TITLE** indicator
Indicates the title number being played during DVD playback.
- ⑥ **CHP/TRK** indicator
 - Indicates the chapter number being played during DVD playback.
 - "PBC" is displayed instead of CHP/TRK indicator when a Video CD that supports PBC is loaded.
 - Indicates the total number of tracks in stop mode, or the track number being played during playback of a CD or Video CD without PBC.
- ⑦ **PROG.** indicator
Lights during programmed playback.
- ⑧ **RANDOM** indicator
Lights during random playback.
- ⑨ **ALL ACDB repeat** indicator
 - \curvearrowright : Indicates one track repeat play mode.
 - ALL \curvearrowright : Indicates all track repeat play mode.
 - ACDB: Indicates A-B repeat play mode (when playing a desired portion of a track repeatedly).
- ⑩ **Time** counter
 - Indicates the elapsed time of the chapter or track except for a video CD that supports PBC. (Only "PBC" is displayed while playing back the video CD that supports PBC.)
 - Indicates the total playing time of a CD or video CD without PBC, in stop mode. (The total playing time is not displayed when other kinds of discs stopped.)
- ⑪ **Angle** indicator
 - Lights when a DVD with multi-angles is loaded.
 - Blinks when a multi-angle scene comes on during DVD playback.
- ⑫ **MP3** indicator
Lights when an MP3 disc is loaded.

CONNECTIONS

Before connecting, identify your type of audio equipment or TV referring to the following chart. Then, decide the connection and the setup procedure accordingly.

NOTES

- The unit cannot be connected to a TV which is not equipped with a video input connector.
- Use a commercially available stereo-monaural audio cord when connecting to a monaural TV.

Audio system to be connected	Input jack of equipment to be connected to the unit	Connection type
None (only a TV is connected)	—	A on page 10
A stereo system or an amplifier	Digital input jack	B on page 11
	Analog audio input jacks (L/R)	C on page 12
An AV receiver equipped with Dolby Digital decoder or a Dolby Digital decoder	Digital input jack	D on page 13
	Analog audio input jacks (L/R)	F on page 15
An AV receiver equipped with DTS decoder or a DTS decoder	Digital input jack	E on page 14

Before making connections

- Connect the AC cords of the unit and any external equipment last, after finishing all other connections.
- Insert the plugs completely into the jacks. Loose connections may produce a humming sound or other noise interference.
- When using an optical connection, remove the dust cap from the DIGITAL OUT (OPTICAL) jack on the rear of the unit. Keep the cap handy. When not using optical connections, the dust cap should be replaced.
- Refer to the instructions of the connected equipment.

NOTES

- If picture noise appears while playing copy-protected DVDs, connect the unit directly to a TV. Do not connect through a VCR, TV/VCR, or AV selector.
- For speaker connection, refer to the instructions of the AV receiver.

CAUTION

Do not select "DOLBY DIGITAL/PCM" or "Stream/PCM" in the "Digital Audio Output" of the setup menu when connecting to an AV receiver not equipped with a Dolby Digital decoder or DTS decoder (with an optical or coaxial connecting cord).

Merely attempting to play a DVD may cause a screeching noise which could be harmful to your ears and damage the speakers. In such a case, be sure to select "PCM" in the "Digital Audio Output."

CONNECTIONS (CONTINUED)

A Connecting to a TV only

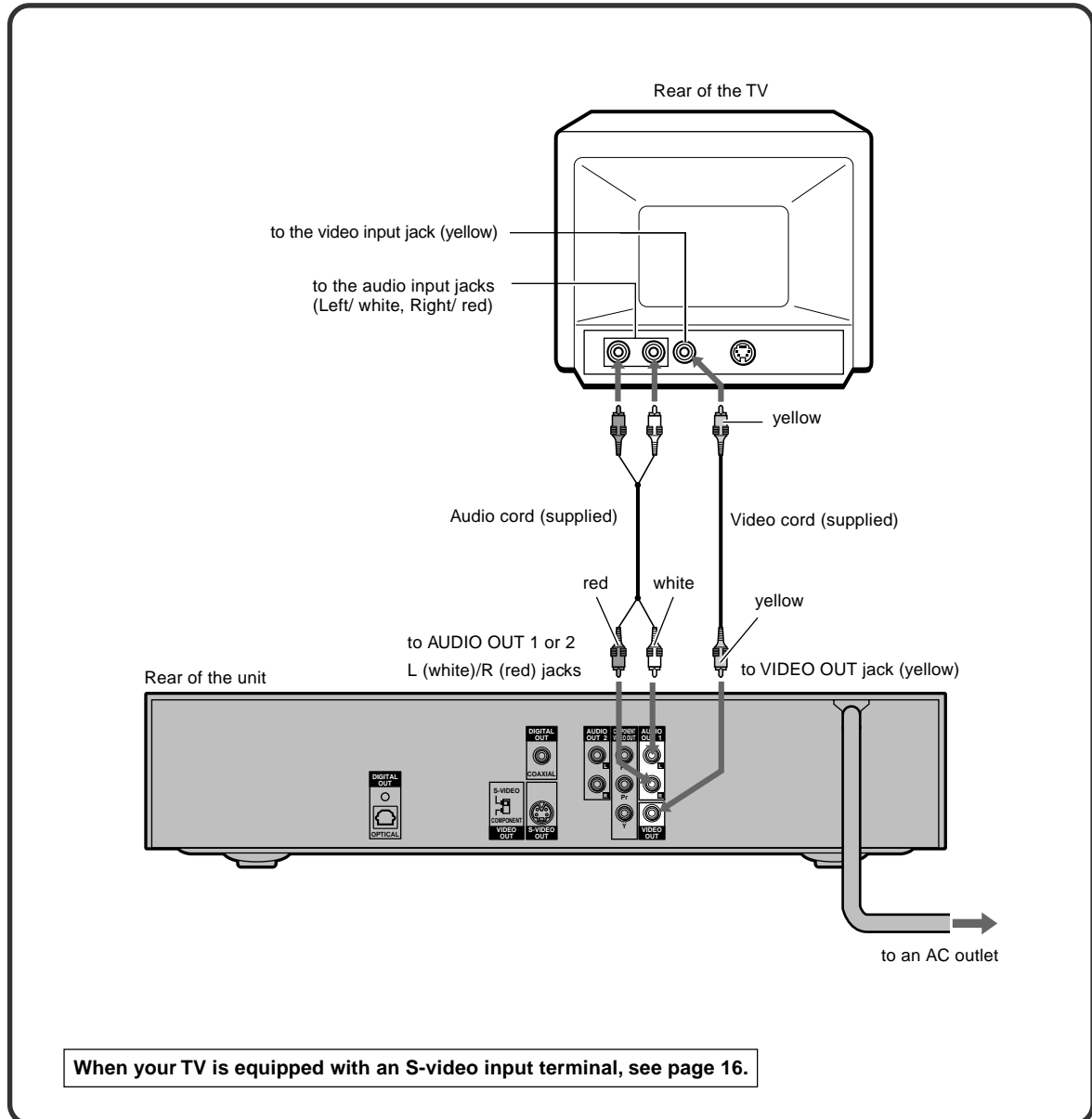

Set the setup menu correctly after connecting!

Set the "TV Aspect" of the setup menu according to the audio equipment and TV connected to the unit as follows: (See "CHANGING SETUP VALUE" on page 38 for details.)

TV Aspect

When your TV is a conventional-screen size TV:

4:3 Letter box

When your TV is a wide-screen size TV:

16:9 Wide

NOTE

If picture noise appears while playing copy-protected DVDs, connect the unit directly to a TV. Do not connect through a VCR, TV/VCR, or AV selector.

B Connecting to a TV and an amplifier with a Digital In jack

Use either a commercially available optical cord or a 75 ohm coaxial cord when connecting the unit to an AV receiver with a Digital In jack. The supplied video cord is also available instead of a coaxial cord.

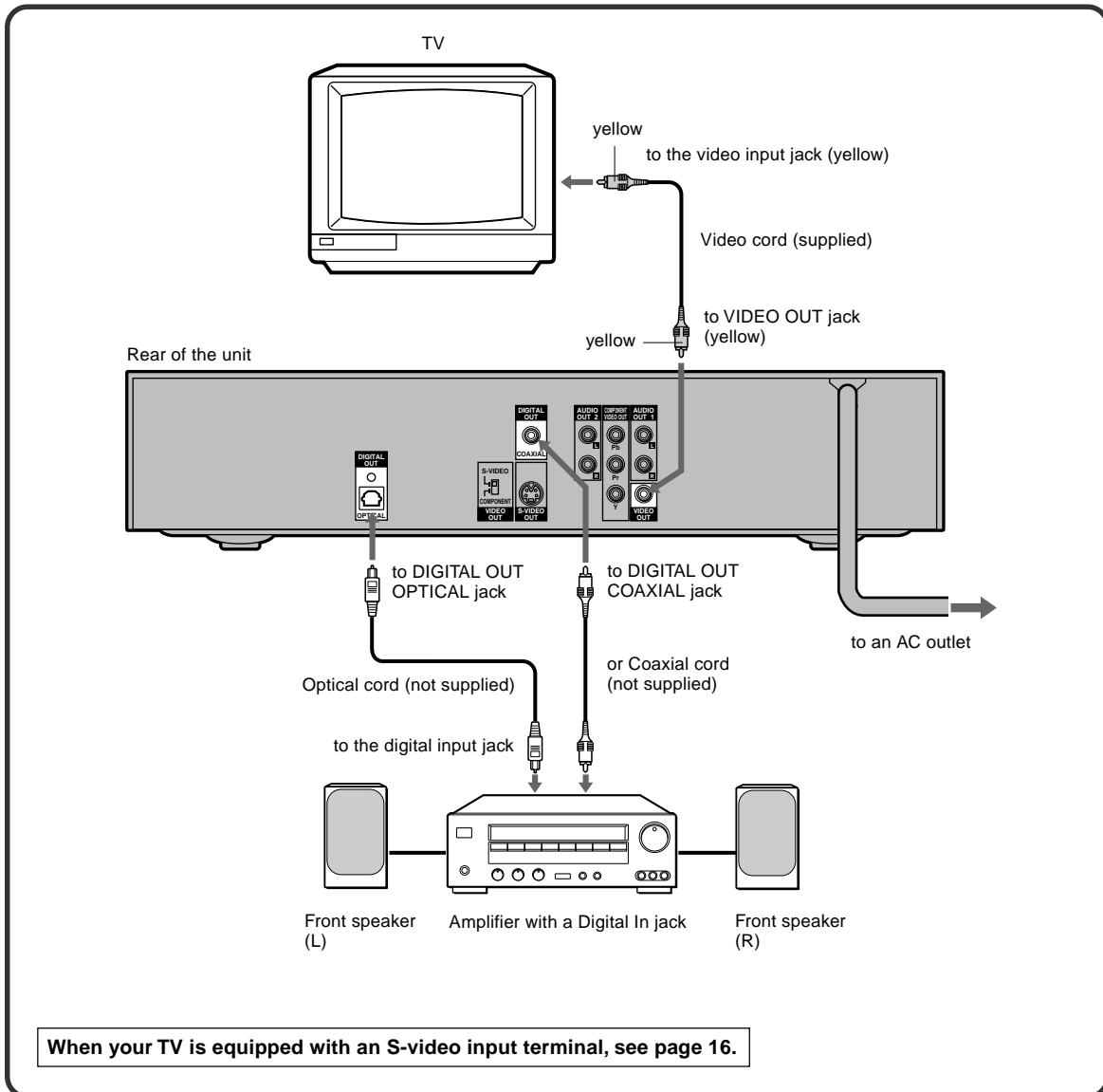

En

Set the setup menu correctly after connecting!

Set the "TV Aspect" and "Digital Audio Output" of the setup menu according to the audio equipment and TV connected to the unit as follows:
(See "CHANGING SETUP VALUE" on page 38 for details.)

Digital Audio Output

PCM

TV Aspect

When your TV is a conventional-screen size TV:

4:3 Letter box

When your TV is a wide-screen size TV:

16:9 Wide

NOTE

If picture noise appears while playing copy-protected DVDs, connect the unit directly to a TV. Do not connect through a VCR, TV/VCR, or AV selector.

CONTINUE

ENGLISH 11

CONNECTIONS (CONTINUED)

Connecting to a TV and an audio system

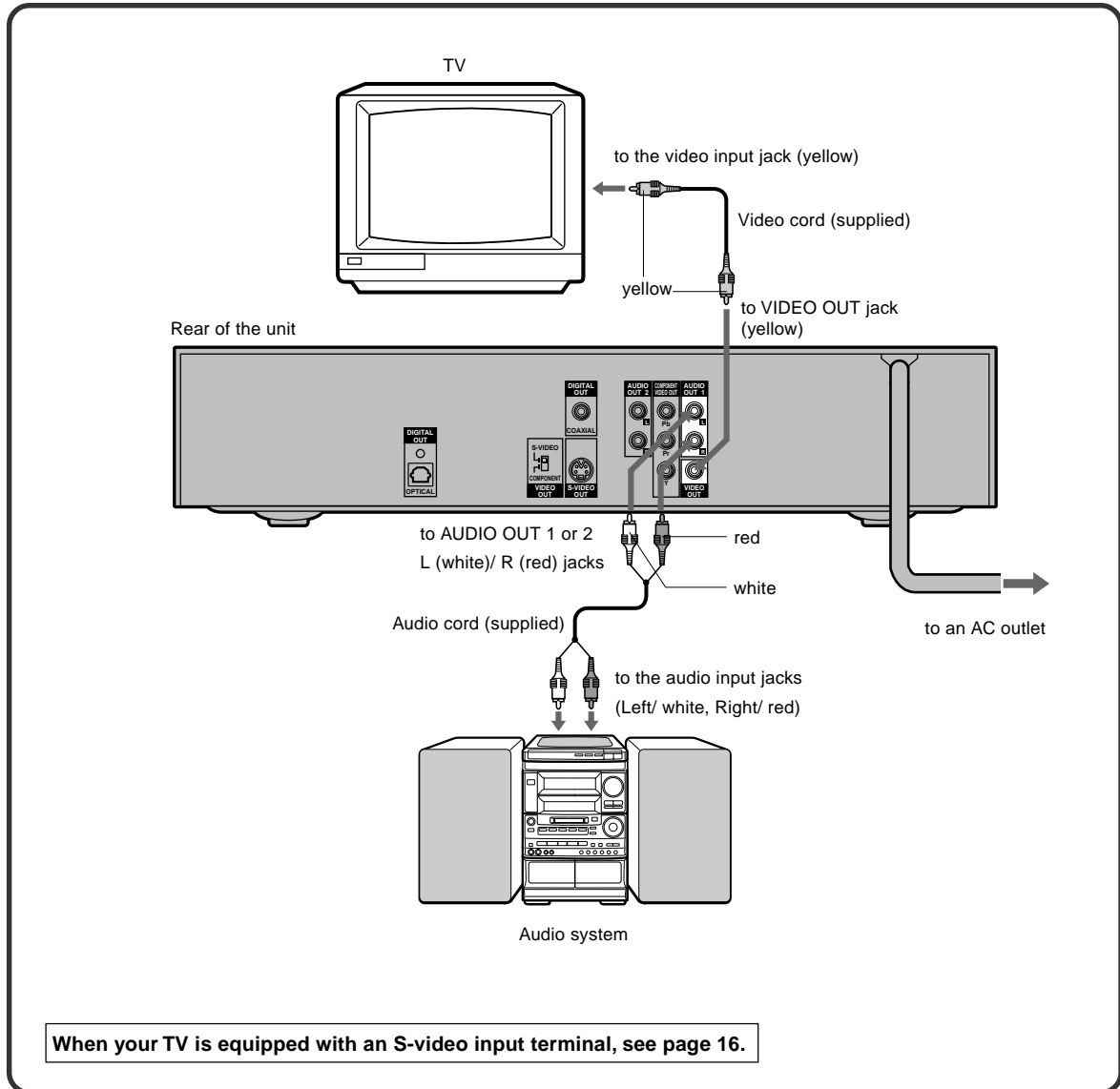

Set the setup menu correctly after connecting!

Set the "TV Aspect" of the setup menu according to the audio equipment and TV connected to the unit as follows: (See "CHANGING SETUP VALUE" on page 38 for details.)

TV Aspect

When your TV is a conventional-screen size TV:

4:3 Letter box

When your TV is a wide-screen size TV:

16:9 Wide

NOTE

If picture noise appears while playing copy-protected DVDs, connect the unit directly to a TV. Do not connect through a VCR, TV/VCR, or AV selector.

D Connecting to an AV receiver equipped with a Dolby Digital (AC-3) decoder

Use either a commercially available optical cord or a 75 ohm coaxial cord when connecting this unit to an AV receiver with a Digital In jack. The supplied video cord is also available instead of a coaxial cord.

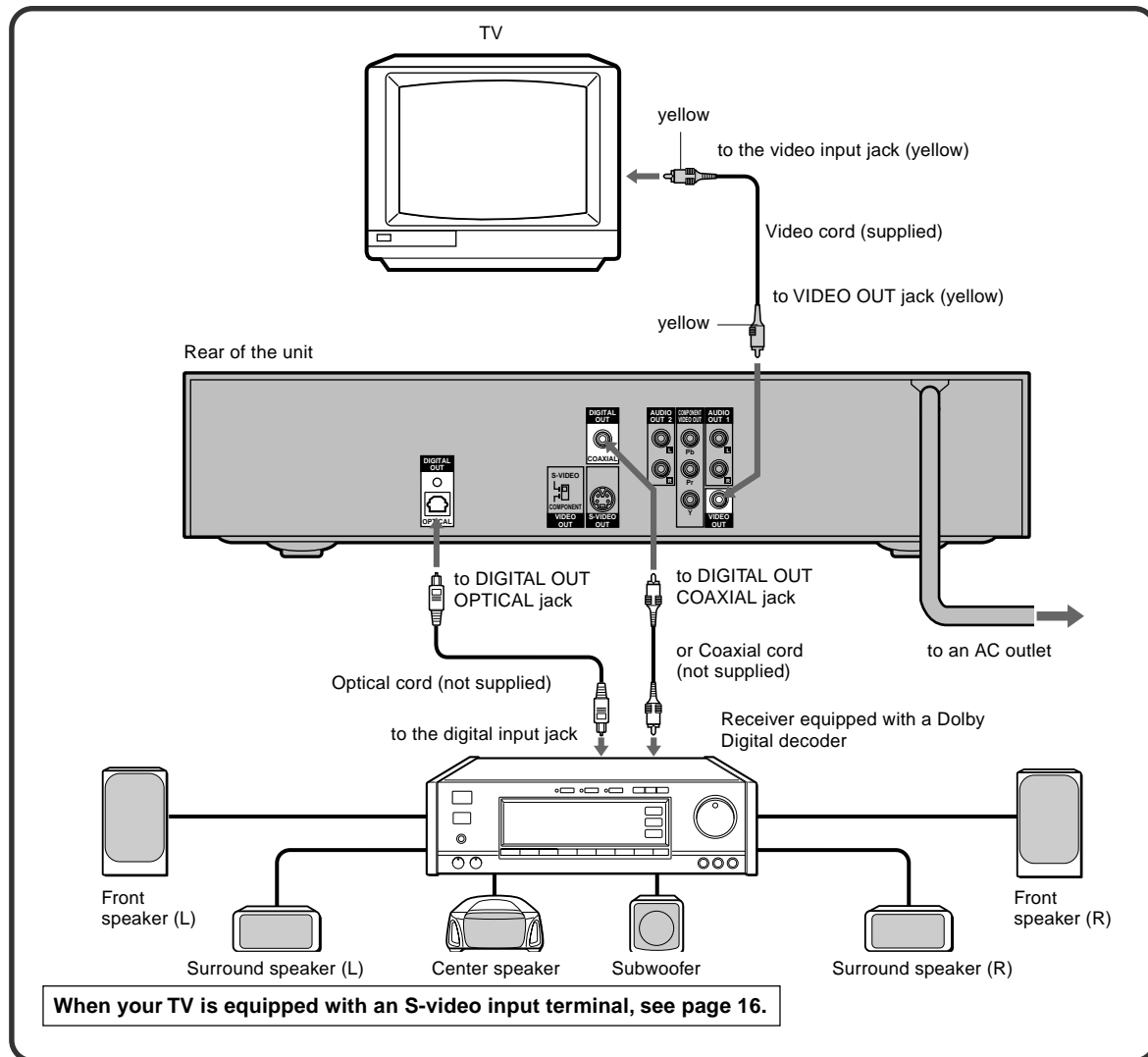

Set the setup menu correctly after connecting!

Set the "TV Aspect" and "Digital Audio Output" of the setup menu according to the audio equipment and TV connected to the unit as follows:
(See "CHANGING SETUP VALUE" on page 38 for details.)

Digital Audio Output DOLBY DIGITAL/PCM

TV Aspect

When your TV is a conventional-screen size TV:
4:3 Letter box
When your TV is a wide-screen size TV:
16:9 Wide

NOTE

If picture noise appears while playing copy-protected DVDs, connect the unit directly to a TV. Do not connect through a VCR, TV/VCR, or AV selector.

CAUTION

When connecting an AV receiver not equipped with a Dolby Digital decoder using an optical or coaxial connecting cord, do not select "DOLBY DIGITAL/PCM" in the "Digital Audio Output" of the setup menu.
Merely attempting to play a DVD may cause a screeching noise which could be harmful to your ears and damage the speakers. In such a case, be sure to select "PCM" in the "Digital Audio Output."

CONTINUE

ENGLISH 13

CONNECTIONS (CONTINUED)

Connecting to an AV receiver equipped with a DTS decoder

Use either a commercially available optical cord or a 75 ohm coaxial cord when connecting the unit to an AV receiver with a Digital In jack. The supplied video cord is also available instead of a coaxial cord.

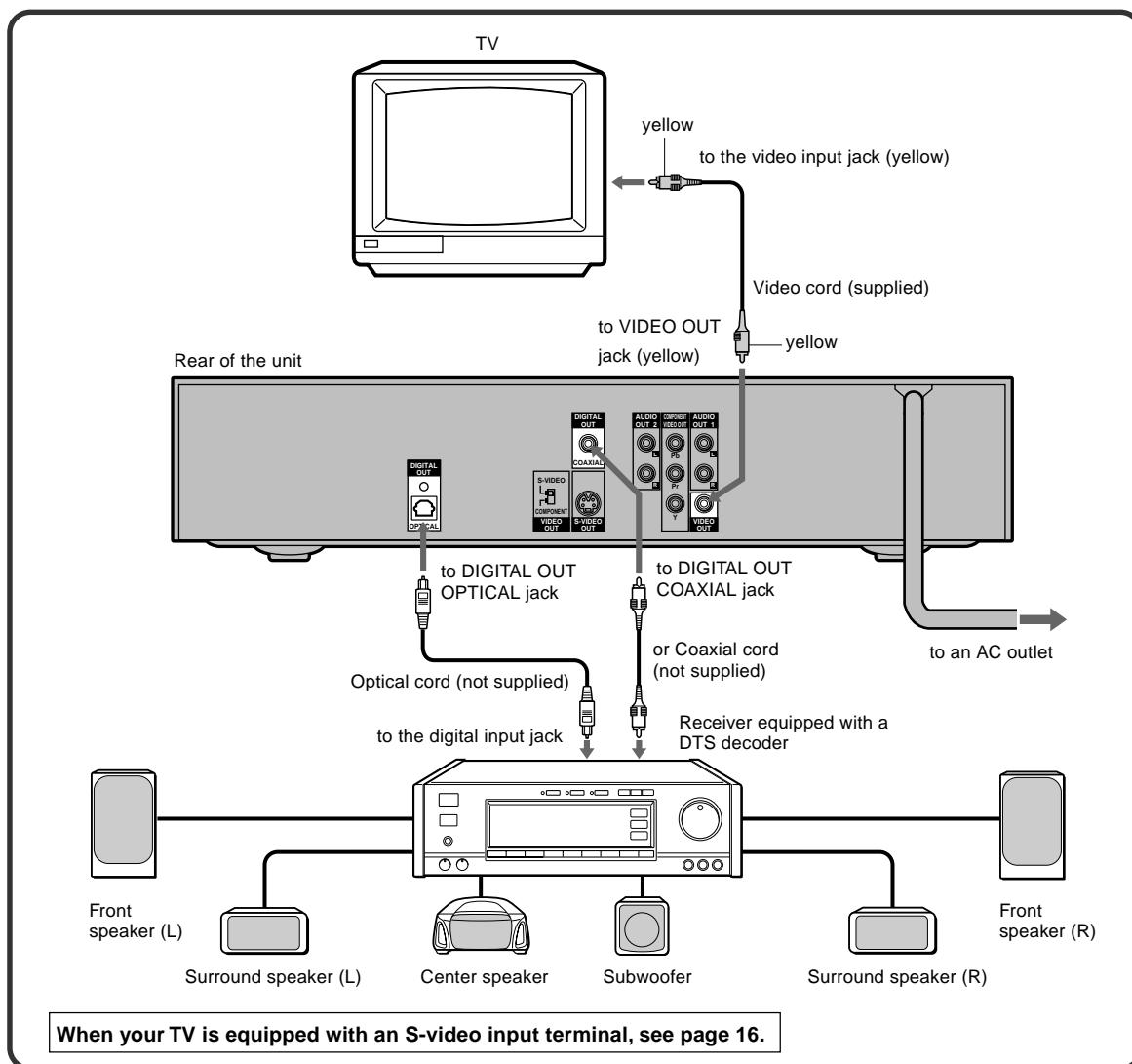

Set the setup menu correctly after connecting!

Set the "TV Aspect" and "Digital Audio Output" of the setup menu according to the audio equipment and TV connected to the unit as follows:
(See "CHANGING SETUP VALUE" on page 38 for details.)

Digital Audio Output

Stream/PCM

TV Aspect

When your TV is a conventional-screen size TV:

4:3 Letter box

When your TV is a wide-screen size TV:

16:9 Wide

NOTE

If picture noise appears while playing copy-protected DVDs, connect the unit directly to a TV. Do not connect through a VCR, TV/VCR, or AV selector.

CAUTION

When connecting an AV receiver not equipped with a DTS decoder using an optical or coaxial connecting cord, do not select "Stream/PCM" in the "Digital Audio Output" of the setup menu.

Merely attempting to play a DVD may cause a screeching noise which could be harmful to your ears and damage the speakers. In such a case, be sure to select "PCM" in the "Digital Audio Output."

Connecting to a TV and an AV receiver with the Dolby Pro Logic Surround system

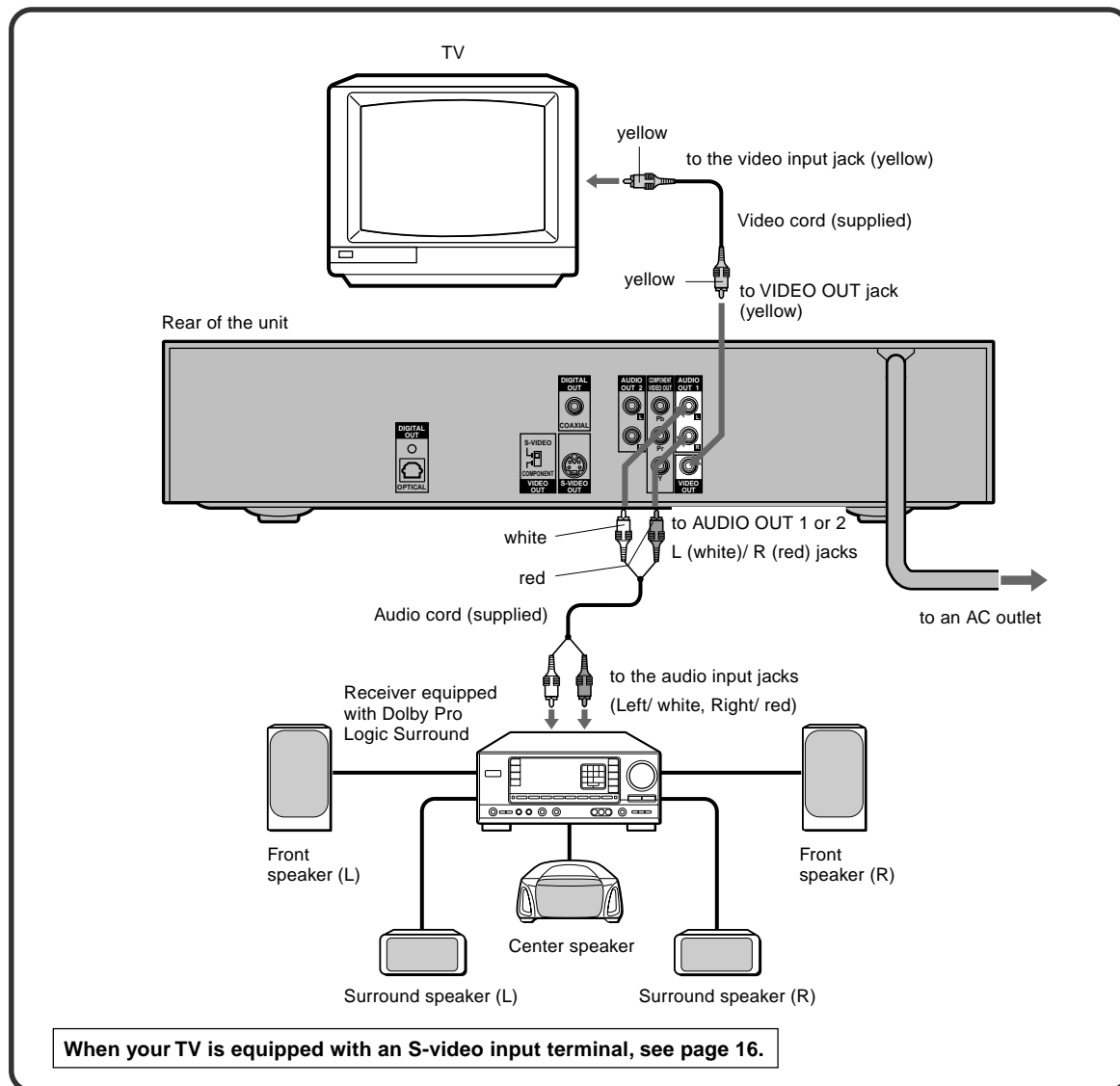

Set the setup menu correctly after connecting!

Set the "TV Aspect" and "Digital Audio Output" of the setup menu according to the audio equipment and TV connected to the unit as follows:
(See "CHANGING SETUP VALUE" on page 38 for details.)

Digital Audio Output DOLBY DIGITAL/PCM

TV Aspect

When your TV is a conventional-screen size TV:

4:3 Letter box

When your TV is a wide-screen size TV:

16:9 Wide

NOTE

If picture noise appears while playing copy-protected DVDs, connect the unit directly to a TV. Do not connect through a VCR, TV/VCR, or AV selector.

CONTINUE

ENGLISH 15

CONNECTIONS (CONTINUED)

Connecting to a TV equipped with an S-video jack

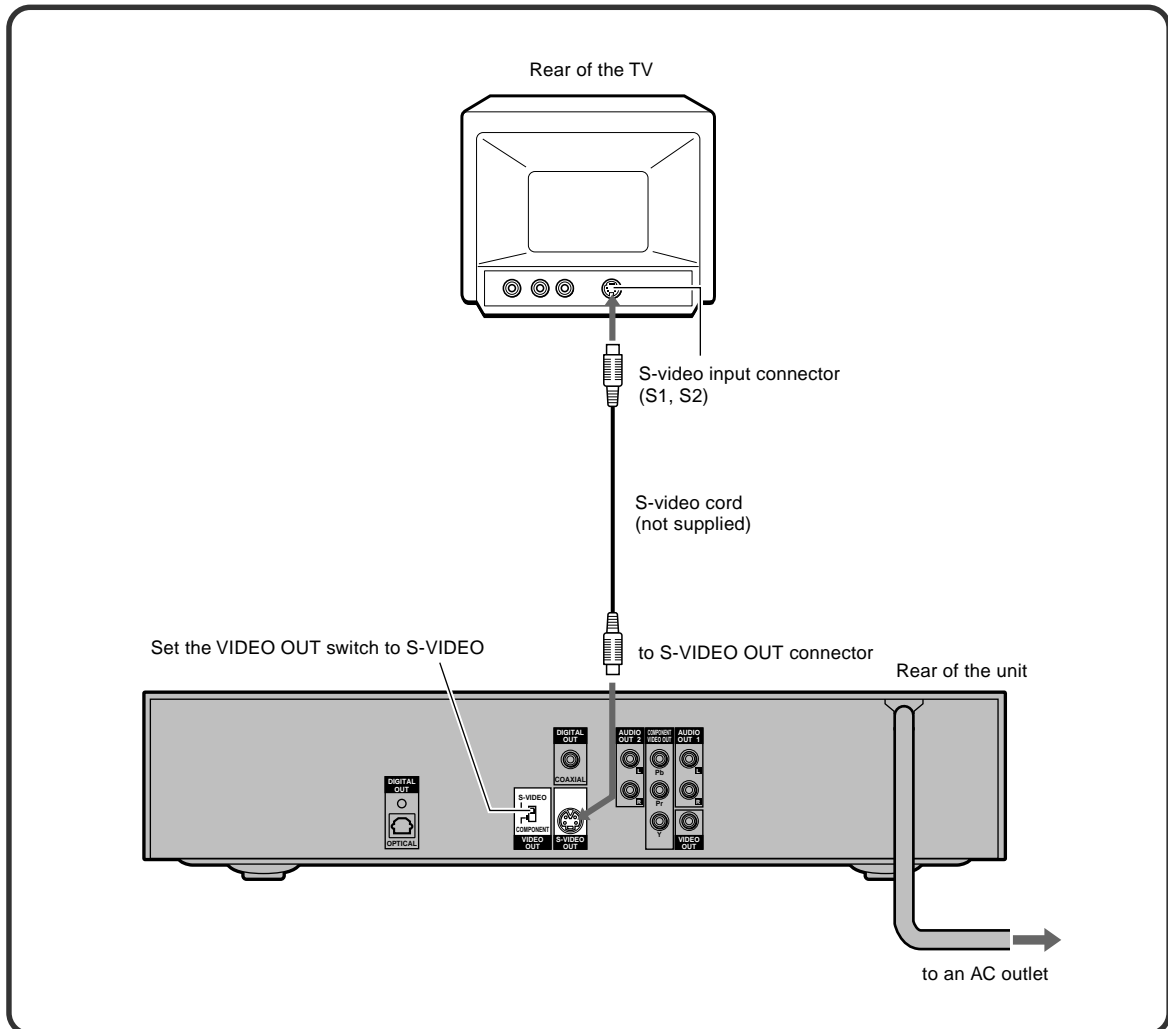

Before connecting!

Set the VIDEO OUT switch to **S-VIDEO** when connecting to a TV with an S-video jack.

Tip

Video signals are always output from VIDEO OUT jack on the unit regardless of this setting.

Set the setup menu correctly after connecting!

Set the "TV Aspect" of the setup menu according to the audio equipment and TV connected to the unit as follows: (See "CHANGING SETUP VALUE" on page 38 for details.)

TV Aspect

When your TV is a conventional-screen size TV:

4:3 Letterbox

When your TV is a wide-screen size TV:

16:9 Wide

NOTES

- For the best possible picture clarity, it is recommended that an S (separate) video cord (not supplied) be used when connecting the unit to a TV equipped with an S-video input terminal.
- If picture noise appears while playing copy-protected DVDs, connect the unit directly to a TV. Do not connect through a VCR, TV/VCR, or AV selector.

Connecting to a TV or monitor with component video input connectors

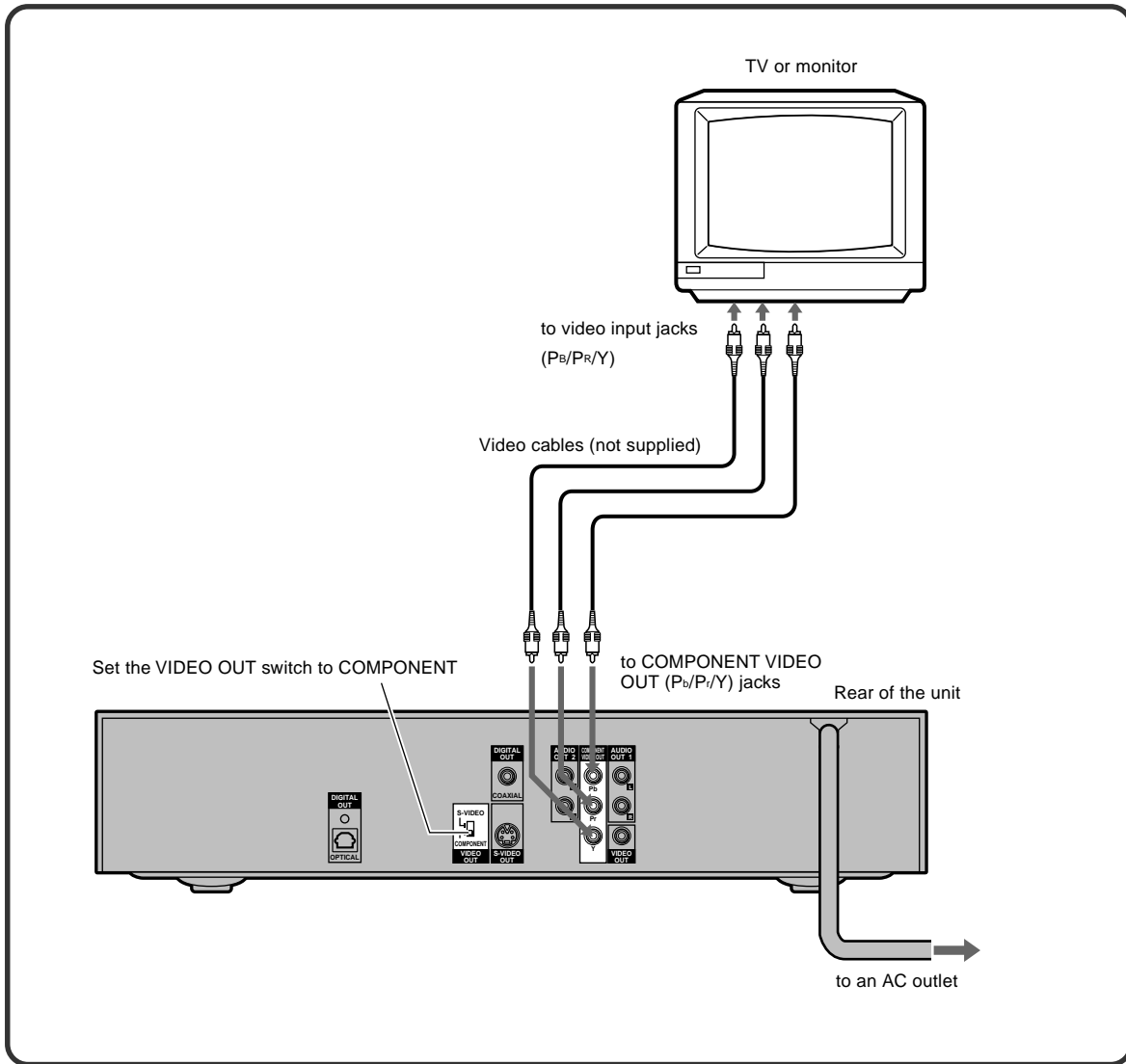

En

Before connecting!

Set the VIDEO OUT switch to **COMPONENT** when connecting to a TV with component video input jacks.

Tip

Video signals are always output from VIDEO OUT jack on the unit regardless of this setting.

Component video output jacks (Pb/Pb/Y)

The component video output jacks output the different color signals (Pb/Pb) and luminance signal (Y) separately in order to achieve high fidelity in reproducing colors. The description of the component video output connectors may differ depending on the connected TV or monitor (e.g. Pb/Pb/Y, Cb/Cb/Y, B-Y/R-Y/Y, etc.). Refer to the operating instructions of the TV for details.

Set the setup menu correctly after connecting!

Set the "TV Aspect" of the setup menu according to the audio equipment and TV connected to the unit as follows: (See "CHANGING SETUP VALUE" on page 38 for details.)

TV Aspect

When your TV is a conventional-screen size TV:

4:3 Letterbox

When your TV is a wide-screen size TV:

16:9 Wide

NOTE

If picture noise appears while playing copy-protected DVDs, connect the unit directly to a TV. Do not connect through a VCR, TV/VCR, or AV selector.

REMOTE CONTROL

Installing batteries

Detach the battery cover on the rear of the remote control, and insert two R03 (size AAA) batteries with \oplus and \ominus aligned correctly.

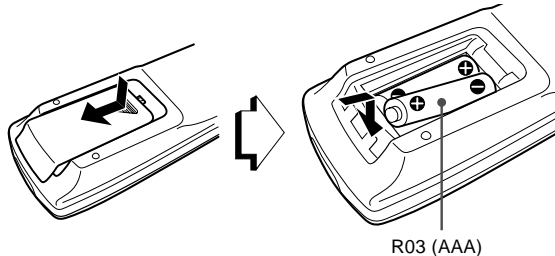

When to replace the batteries

The maximum operational distance between the remote control and the sensor of the unit should be approximately 7 meters (23 feet). If this distance decreases, replace the batteries with new ones.

NOTES

- When operating with the remote control, point the front of the remote control toward the player.
- If the unit is not going to be used for an extended period of time, remove the batteries to prevent possible electrolyte leakage.
- The remote control may not operate correctly when:
 - The line of sight between the remote control and the unit or the unit itself is exposed to intense light, such as direct sunlight.
 - There is fluorescent lighting near the remote sensor in the display window of the unit.
 - Other remote controls are used nearby (those of a TV set, etc.).

ABOUT SYMBOLS

Although this unit can play DVDs, Video CDs, Audio CDs or MP3 discs, some of the functions are restricted dependent on the type of disc.

The following symbols are used to make distinction.

Playback of MP3 discs is different from that of other kinds of discs. For information about playing back MP3 discs, see page 34.

DVD : Shows the function or the display for only DVDs.

VCD2.0 : Shows the function or the display for only Video CDs with the PBC (Playback control) function.

VCD1.1 : Shows the function or the display for only Video CDs without the PBC (Playback control) function.

CD : Shows the function or the display for only audio CDs.

No symbols: The function works for DVDs, Video CDs, and audio CDs.

About the \odot symbol display

- The \odot symbol will be displayed on the TV screen if you press a button which cannot be used or enter an incorrect number.
- Some DVD discs may have places where pressing of the STOP, SKIP, or other buttons is not allowed. The \odot mark will be displayed on the TV screen if you press a button that is not allowed in such a place.

PLAYBACK

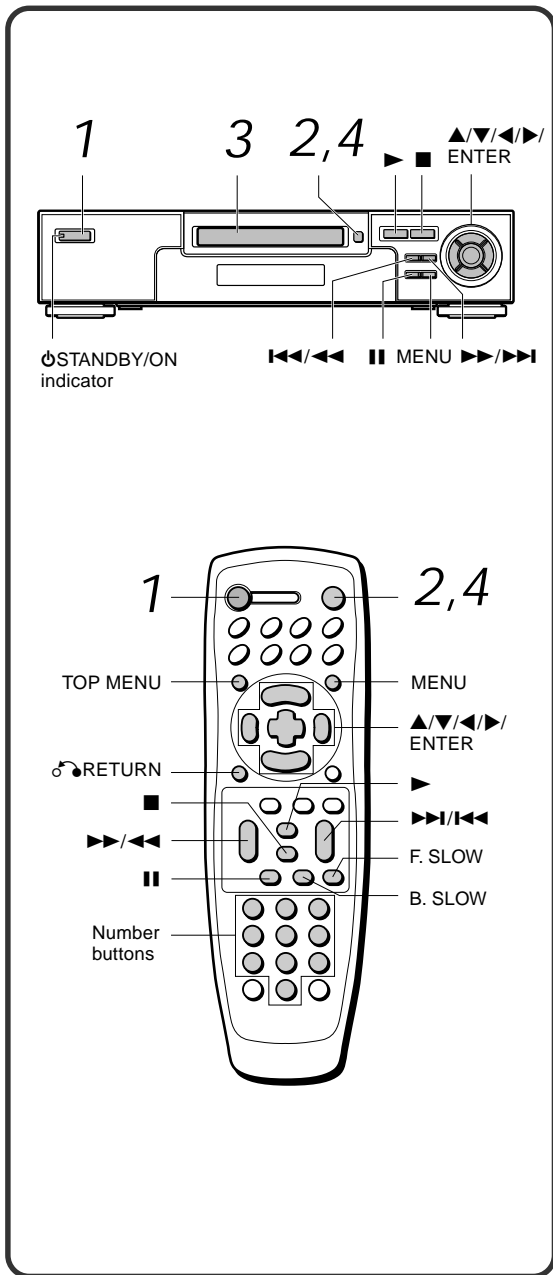

Getting ready to play

- Turn on the TV, and set its video source (Video 1, Video 2, Video 3, etc.) to the one connected to the unit.
- Turn on the audio equipment connected to the unit. Set its input source to the one connected to the unit.

1 Press POWER.

The unit turns on and the ϕ STANDBY/ON indicator turns green. The "aiwa DVD VIDEO" screen appears on the TV screen.

2 Press \blacktriangle OPEN/CLOSE.

The disc tray opens.

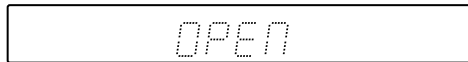

3 Load a disc.

Place a disc in the tray guides (depressed area) with the label side facing up. When loading an 8-cm disc, place it in the inner depression.

4 Press \blacktriangle OPEN/CLOSE.

The disc tray closes, and the unit automatically starts playing the disc.

If playback does not start, press \blacktriangleright .

- If a disc is placed in upside down, "DISC Error" will be indicated and the disc tray will open.

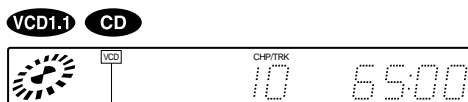
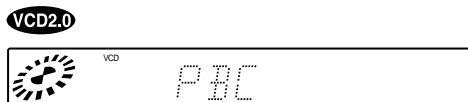
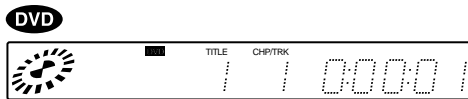

"CD" is displayed when loading a CD.

PLAYBACK (CONTINUED)

When the menu screen is displayed

The menu screen may be displayed first after loading a DVD or Video CD which contains a menu.

DVD

Use the ▲/▼/◀/▶ buttons to select the title/chapter you want to view, then press **ENTER** to start playback. Press **TOP MENU** or **MENU** to return to the menu screen.

VCD2.0

Use the number buttons to select the track you want to view.

Press **RETURN** to return to the menu screen.

Menu settings and the exact operating procedures for using the menu may differ depending on the disc. Follow the instructions on each menu screen.

Tip

The unit can switch on/off the PBC (Playback control) function in the setup menu. When PBC is turned off, Video CD is played back the same as an audio CD. To turn off PBC, see "CHANGING SETUP VALUE" on page 38.

To stop playback

Press **■**.

To turn the power off

Press **POWER**. The unit enters power standby mode and the **STANDBY/ON** indicator turns red.

If the unit is left for 8 minutes without any operations

The unit automatically enters standby mode.

NOTE

The disc continues to spin while the menu screen is displayed even if **■** is pressed. When you are finished using the unit, turn the power off after pressing **■**.

Still (Pause)

Press **||** during playback.

To return to normal playback

Press **▶**.

Frame Advance

DVD VCD2.0 VCD1.1

Press **||** during pause.

Each time you press the button, the program advances one frame. There is no audio during Frame Advance playback.

To return to normal playback

Press **▶**.

Resuming playback

DVD VCD1.1 CD

The unit remembers the point where you stopped the disc and you can resume playback from that point.

Press **▶** in stop mode.

To clear the resume point

Press **■** again after you stop the disc.

The resume point is also cleared when you press **▲ OPEN/CLOSE** to open the disc tray, or **POWER** to turn the power off.

NOTE

VCD2.0

During Video CD playback with PBC turned on, the resume function does not work.

To resume playback from the point where you stopped, turn off the PBC.

Fast Forward and Reverse

Press **▶▶** or **◀◀** on the remote control during playback.

Each time you press the button, the playback speed changes as shown below.

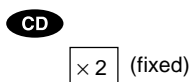
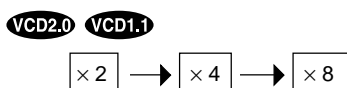

To return to normal playback

Press **▶**.

NOTE

There is no audio during DVD or Video CD playback.

Slow playback

DVD **VCD2.0** **VCD1.1**

Press **F.SLOW** or **B.SLOW** during playback.

Each time you press the button, the playback speed changes as shown below.

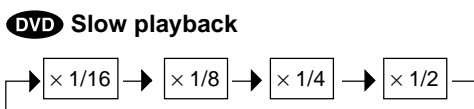

VCD2.0 **VCD1.1** **Slow playback (forward only)**

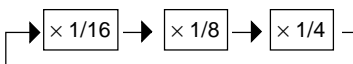

To return to normal playback

Press **▶**.

NOTES

- Slow playback in reverse does not work during Video CD playback.
- There is no audio during slow playback.
- Subtitles do not appear on the TV screen during slow playback.

Skipping

Press **◀◀** or **▶▶**.

To skip to the next chapter or track: ▶▶

The disc position advances one chapter or track each time the button is pressed.

To return to the previous chapter or track: ◀◀

Pressing **◀◀** once skips to the beginning of the chapter (track) currently being played, and pressing **◀◀** twice skips to the previous chapter.

NOTE

VCD2.0

When you press **◀◀** during playback, you are returned to the beginning of the track currently being played.

To skip to the desired track directly using the number buttons

VCD1.1 **CD**

During playback or in stop mode, enter the desired track number using the number buttons on the remote control.

Example: To play track 3
Press **3**.

Example: To play track 20
Press **2** and **0**.

Playback starts from the beginning of the selected track.

Performing fast forward, fast reverse, or skipping operations during Video CD playback with PBC on may cause the unit to return to the menu screen.

PLAYBACK (CONTINUED)

On Screen Display (OSD) menu

The general playback status can be displayed on the TV screen. Some items can be changed on the menu.

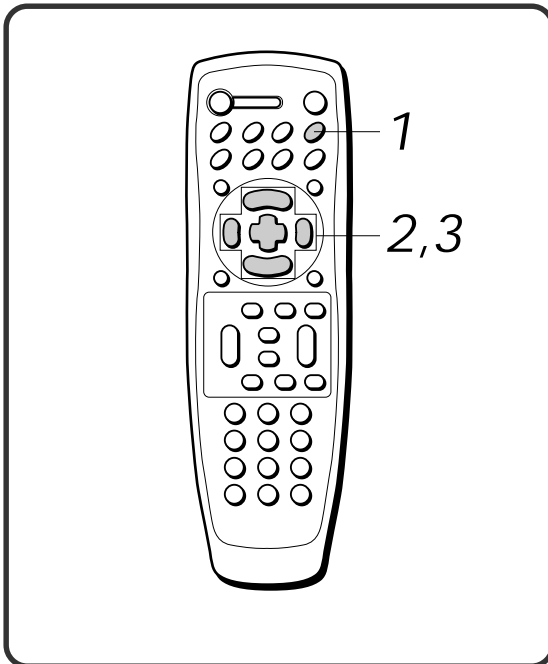

1 Press **DISPLAY** during playback.

2 Press **▲/▼** to select the desired item.

The currently selected item is indicated by a yellow frame on its OSD menu.

3 Press **◀/▶** to select the desired setting.

The number buttons can also be used for setting numbers (e.g., title number). For some functions, press **ENTER** to execute the setting.

To turn off the OSD menu

Press **DISPLAY**.

NOTE

If no button is pressed for 10 seconds, the OSD menu disappears.

Examples of On Screen Display (OSD) menu

(The OSD menu may differ depending on the disc contents.)

DVD



VCD1.1 CD









VCD2.0



Detailed description of each OSD menu

Each item shows its current status and can be changed on the OSD menu. For details of the functions or optional settings, refer to the page in parentheses.





DVD

Items	Show the current selected item	Function
 1	Title number	Skip to the desired title (Title search on page 24)
 1	Chapter number	Skip to the desired chapter (Chapter search on page 25)
 0:16:57	Elapsed playing time	Search the point by the elapsed time directly (Time search on page 25)
 1 ENG D D D 6 CH	Audio soundtrack language Encoding method Channel number	Change the settings (page 32)
 OFF	Subtitle language	Change the setting (page 33)
 1	Angle number	Change the angle (page 27)
 NORM.	Sound	Change the setting (page 31)

VCD2.0

VCD1.1

CD

Items	Show the current selected item	Function
 1	Track number	Skip to the desired track (Track search on page 24)
 16:57	Elapsed playing time	_____
 STER.	Audio channel	Change the setting (page 32)
 NORM.	Sound	Change the setting (page 31)

NOTE

Some discs may not provide all of the above OSD menu.

SEARCH

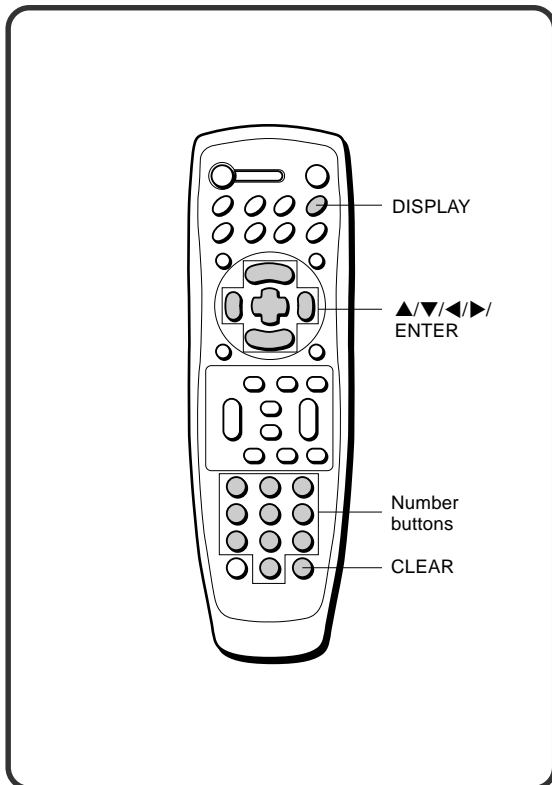

This unit provides 4 types of DVD searches.

Title search/Track search

Specifies a title or track number.

- To use this feature with Video CDs that support PBC, turn off PBC first. (See "CHANGING SETUP VALUE" on page 38.)

Chapter search

Specifies a chapter number.

Time search

Specifies the elapsed time of the desired position.

Mark search

Specifies the marked point.

Title search/Track search

DVD VCD1.1 CD

- 1 Press **DISPLAY** during playback or in stop mode.

If in DVD stop mode continue to step 3.

- 2 Press **▲/▼** to select "T (title/track)."



- 3 Press **◀/▶** to enter the desired title or track number.



- The number buttons can also be used to select the desired number.

Example: To play title/track number 2
Press **2**.

Example: To play title/track number 10
Press **1, 0**.

If you enter the wrong number

Press **CLEAR** and then enter the correct number.

- 4 Press **ENTER**.

Playback of the specified title or track starts.

NOTE

If no button is pressed for 10 seconds, the OSD menu disappears.

Chapter search

DVD

1 Press **DISPLAY** during playback.

2 Press **▲/▼** to select "C (chapter)."



3 Press **◀/▶** to enter the desired chapter number.



- The number buttons can also be used to select the desired number.

Example: To play chapter number 17
Press 1, 7.

If you enter the wrong number

Press **CLEAR** and then enter the correct number.

4 Press **ENTER**.

Playback of the specified chapter starts.

NOTES

- Chapter search does not work on DVDs with no chapters recorded.
- Chapter search will not work if you specify a chapter number which does not exist on the disc.

Time search

DVD

When the elapsed time is displayed during DVD playback, you can specify a time on the disc to locate the desired position.

1 Press **DISPLAY** during playback.

2 Press **▲/▼** to select **TIME** icon.



3 Use the number buttons to enter the time of the desired position.



Example: To start play at 1 hour, 17 minutes, 30 seconds (1:17:30)
Press 1, 1, 7, 3, then 0.

Example: To start play at 8 minutes 7 seconds (0:08:07)
Press 8, 0, then 7.

If you enter the wrong numbers

Press **CLEAR** repeatedly to cancel the numbers. Then enter the correct numbers.

4 Press **ENTER**.

Playback starts from the specified position (time).

NOTES

- Time search does not work if you specify a time longer than the length of the disc.
- Time search may not work with some discs even if the elapsed time is displayed.

En

SEARCH (CONTINUED)

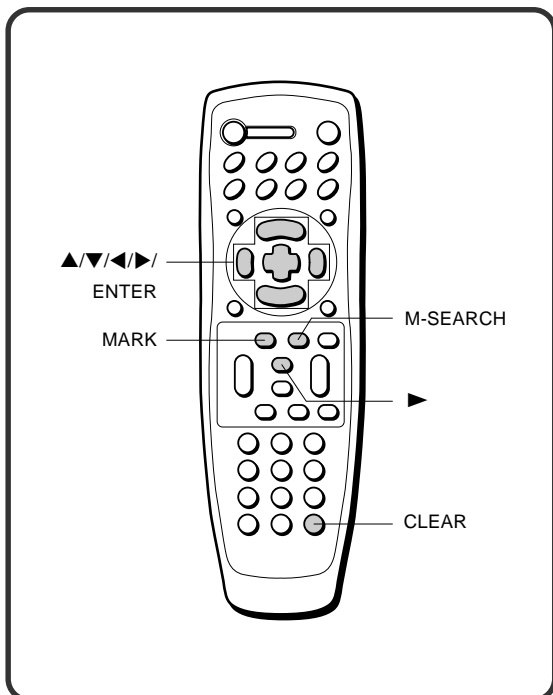

1 Press M-SEARCH during playback or in stop mode.

The marked pictures are displayed.

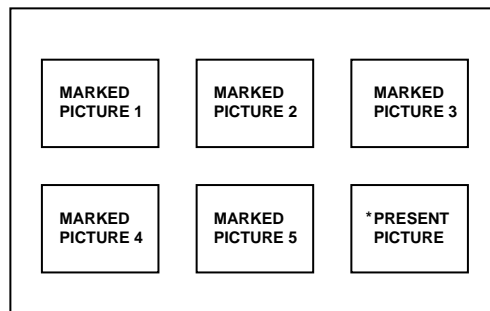

*The picture currently playing.

2 Press ▲/▼/◀/▶ to select the desired marked picture.

3 Press ► or ENTER.

Playback resumes from the selected marked point.

To clear the marked point

Press ▲/▼/◀/▶ to select the marked picture in step 2, then press **CLEAR**.

The "PRESENT PICTURE" is not cleared.

NOTES

- Mark search may not work with multi-angle scenes or portions where subtitles are recorded.
- All the marked points are cleared when:
 - the power is turned off,
 - the disc is removed,
 - you skip to another title number.

Mark search

DVD

Playback can restart from the marked point.
Up to 5 points can be marked within the same title number.

To mark a desired point

Press **MARK** at that point during playback.

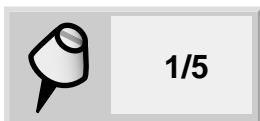

"1/5" is displayed and the picture marked "1" is memorized.
Each time you press **MARK**, the desired points are memorized.

ZOOMING AND CHANGING THE ANGLE

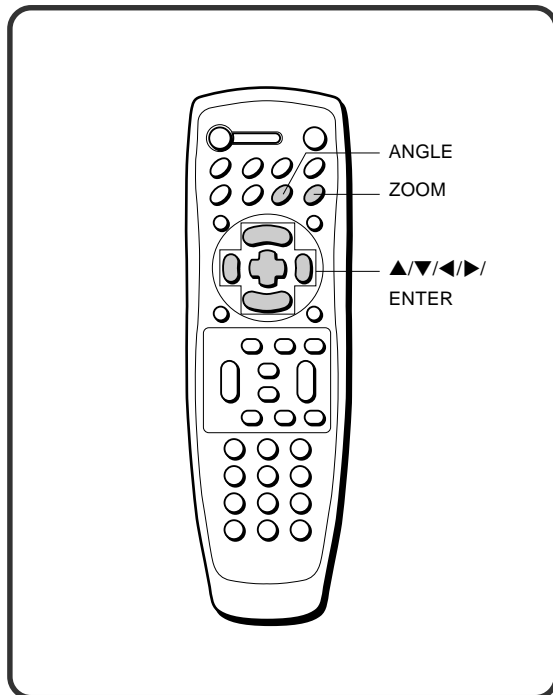

Changing the angle

DVD

When playing a DVD with multi-angles recorded (photographed from several different angles), you can select the angle you want to view.

When a multi-angle scene comes on during playback, "4" will blink in the display window to let you know that you can change the angle.

You can also change the angle using the ▲/▼/◀/▶ buttons after displaying the OSD menu (page 22). The following procedure is the simpler method.

1 Press ANGLE during playback.

The current angle number is displayed.



2 Press ANGLE repeatedly until the desired angle is selected.



⊙ symbol appears if you press **ANGLE** during playback of a disc with no multi-angles recorded, or at a scene where the angle cannot be changed.

Zooming the picture

DVD

This function allows you to zoom-in and enlarge the picture to either 4 times or 16 times.

1 Press ZOOM during playback or pause.

Each time the button is pressed, the magnification changes as shown below.

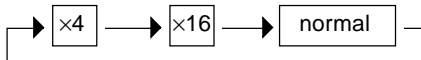

To move the zoom area

Press ▲/▼/◀/▶.

2 Press ENTER.

The selected zoom area is displayed in full size on the TV screen.

To return to the normal playback

Press **ZOOM** repeatedly.

NOTES

- The zoom function may not work for some DVDs.
- The zoom function may not work on multi-angle scenes.

Tip

The total number of angles recorded on the DVD appears on the DVD case within the following symbol.



RANDOM AND REPEAT PLAYBACK

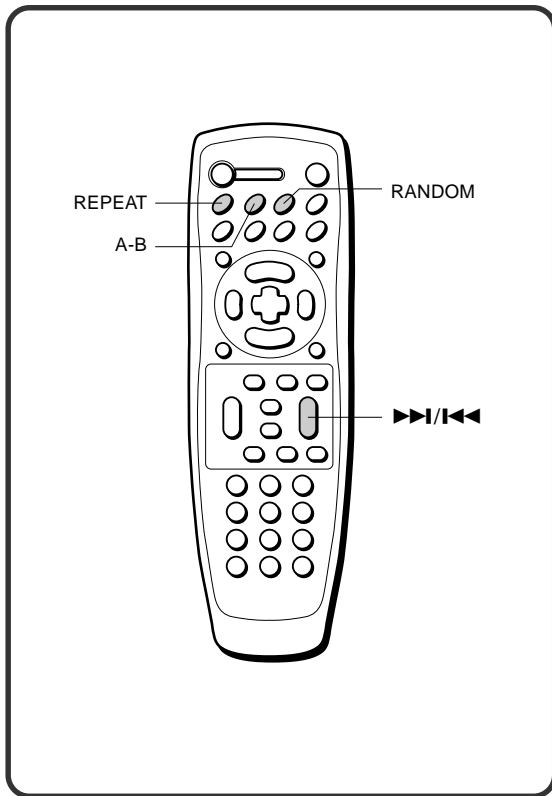

Random playback

DVD KARAOKE **VCD1.1** **CD**

Press **RANDOM** during playback or in stop mode.

The unit automatically begins Random playback and the "RANDOM" indicator lights in the display window. By pressing **◀◀** or **▶▶** during Random playback, the unit selects another title (track) and resumes Random playback.

To resume normal playback

Press **RANDOM**. The "RANDOM" indicator turns off.

NOTE

This function only works with DVD Karaoke discs, Video CDs without PBC, and audio CDs. To turn off PBC, see "CHANGING SETUP VALUE" on page 38.

Repeat playback

Press **REPEAT** during playback.

Repeat mode will change each time you press **REPEAT**.

DVD

CHAPTER:

Repeats the chapter currently being played.



TITLE:

Repeats the title currently being played.



OFF:

Cancels repeat playback. (Normal playback)



NOTE

Chapter repeat playback does not work on DVDs with no chapters recorded.

VCD1.1 CD

TRACK:
Repeats the track currently being played.



ALL:
Repeats all tracks on the disc.



OFF:
Cancels repeat playback. (Normal playback)



Repeat playback does not work for a Video CD with PBC function on. To turn off PBC, see "CHANGING SETUP VALUE" on page 38.

NOTE

- Repeat playback will be also canceled, when:
- the title, chapter, or track is changed track by pressing **▶▶(▶▶)** or **◀◀(◀◀)**.
 - playback stops.

Repeating a portion between two specified points (A-B Repeat)

You can select a portion of a track to be repeated. The portion to be repeated cannot span a track boundary, but must be within a single track.

- 1 During playback, press A-B at the starting point (A) of the section you want to repeat.



- 2 Press A-B again at the ending point (B) of the section you want to repeat.

The unit returns to point A and plays the section between A and B repeatedly.



To return to the normal playback

Press A-B again during playback.



NOTE

At the portion of the disc recorded in multi-angle, the unit may play a section other than you selected for A-B repeat playback.

MORE FEATURES

En

PROGRAMMED PLAYBACK

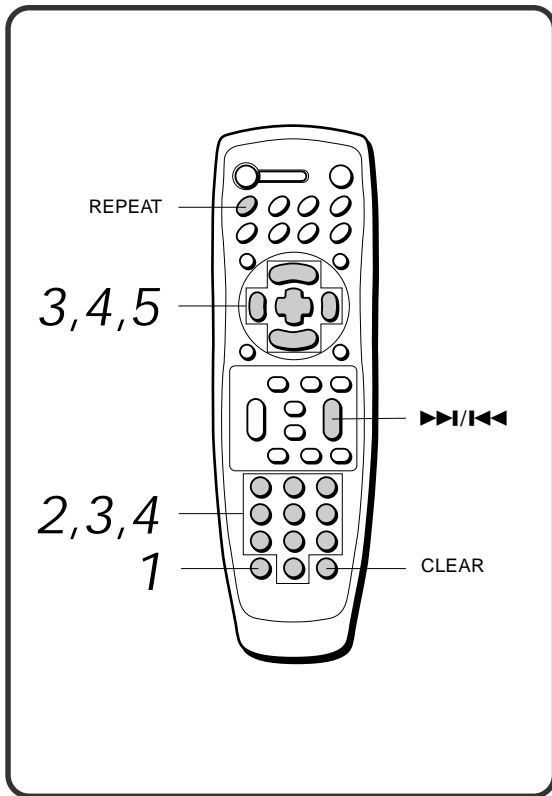

VCD1.1 CD

You can select up to 20 tracks, and play them in programmed order.

- To use this feature with Video CDs that support PBC, turn PBC off first. See "CHANGING SETUP VALUE" on page 38.

1 Press PROGRAM during playback or in stop mode.

The program menu screen appears on the TV screen.

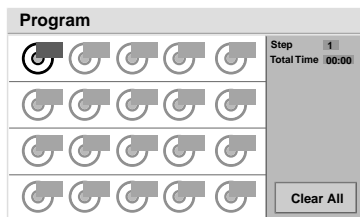

- To turn off the menu screen, press **PROGRAM** again.

2 Press the number buttons to select the desired track number.

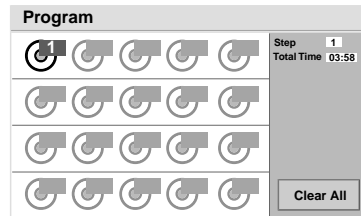

3 Press the right cursor button and the number buttons to select the next track number.

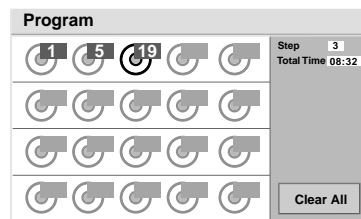

4 Repeat step 3 to select another track.

5 Press ENTER to start playback.

The selected tracks are memorized and playback starts in the programmed order.

To repeat the programmed playback

Press **REPEAT** repeatedly. Each time you press the button, Repeat mode changes (see page 29). When you select "ALL," all programmed tracks are played repeatedly in the programmed order.

To skip tracks

Press **◀◀** or **▶▶** repeatedly. Playback skips to the previous or succeeding tracks within the program setting.

To delete a track from the program setting

Press **▲/▼/◀/▶** in step 3 above to select an unwanted track and press **CLEAR**.

To clear all the programs settings

- 1 Press **▲/▼/◀/▶** in step 3 above to select "Clear All" and press **ENTER**.
- 2 Press **ENTER** again.
The program's settings are also cleared when the disc is removed.

CREATING A 3D SURROUND EFFECT

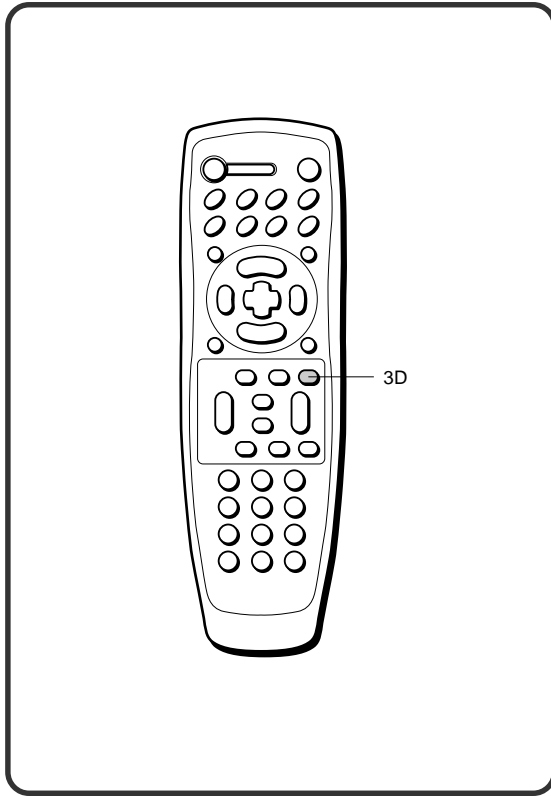

The unit can produce a 3D Surround effect, which simulates multi-channel audio playback from two conventional stereo speakers, instead of the five or more speakers normally required to listen to multi-channel audio from a home theater system. This feature works with discs encoded with Dolby Digital (AC-3) surround sound.

You can also change the sound effect using the ▲/▼/◀/▶ buttons after displaying the OSD menu (page 22). The following procedure is the simpler method.

- 1 Press 3D during playback.



- 2 Press 3D to select "3D SUR."



To turn off the 3D Surround effect

Press **3D** again to select **NORM.**

NOTES

- The 3D Surround effect may not work for some DVD discs, such as those recorded with a mono audio soundtrack.
- Turn off the TV surround sound and other surround effects when using this 3D surround effect.
- Do not press **3D** while recording music. Otherwise the sound signals from the unit will be interrupted.

CHANGING THE AUDIO TRACK

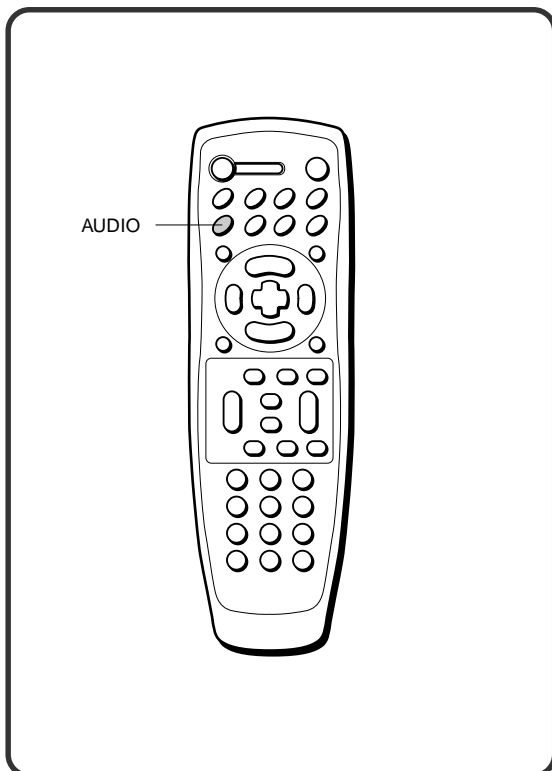

Some discs have more than one audio track, such as soundtracks with different languages. While playing such a disc, the audio track can be changed to play the different soundtracks.

You can also change the sound track using the ▲/▼/◀/▶ buttons after displaying the OSD menu (page 22). The following procedure is the simpler method.

DVD

1 Press AUDIO during playback.

The audio soundtrack language is displayed.



2 Press AUDIO repeatedly until the desired language is selected.



- When playing a DVD with soundtracks in multiple languages, the audio will automatically be played in the designated language set in the set up menu. If that language is not on the disc, the original language for the disc is selected.
- The audio track may only be changed for discs which contain multiple audio tracks.
- The number of audio tracks available differs from disc to disc.

Tip

The total number of sound tracks on the DVD appears on the DVD case within the following symbol.



NOTE

This unit does not apply to the multiple karaoke function. When playing back karaoke DVDs, this unit cannot turn on and off the sound of the vocal part.

VCD2.0

VCD1.1

CD

1 Press AUDIO during playback.

The currently selected audio channel is displayed.



2 Press AUDIO repeatedly until the desired audio channel is selected.

Each time you press the button, the display changes as follows:

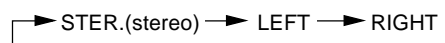

DISPLAYING AND CHANGING SUBTITLES

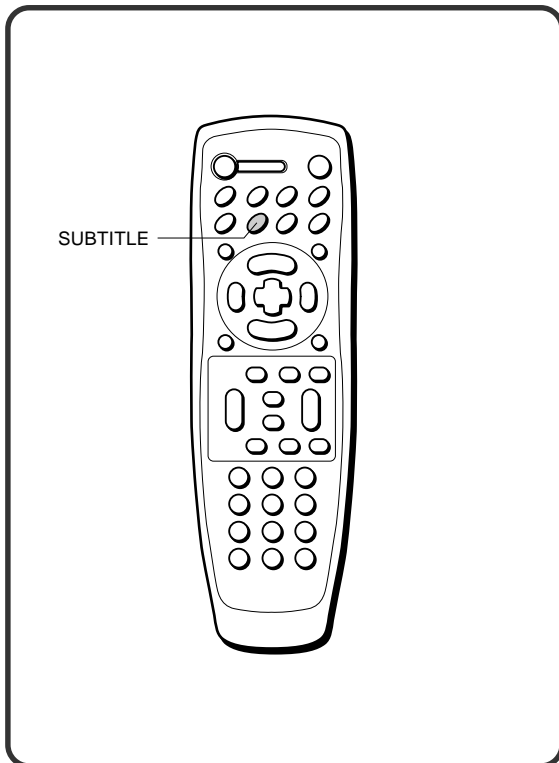

- The subtitle is displayed in the designated language set in the set up menu (page 38). If that language is not on the disc, the original language for the disc is selected.
- Subtitles may only be changed with discs which contain more than one set of subtitles.
- The number of subtitle languages differs depending on the disc.
- With some discs, it may take a few moments to display new subtitles after you press **SUBTITLE**.

Tip

The total number of subtitle languages on the DVD appears on the DVD case within the following symbol.



DVD

When playing DVD discs which contain subtitles, you can display the subtitles on the screen or change the language of the subtitles.

You can also change the subtitle language using the ▲/▼/◀/▶ buttons after displaying the OSD menu (page 22). The following procedure is the simpler method.

1 Press SUBTITLE during playback.

When no subtitles are recorded, no display appears.



2 Press SUBTITLE repeatedly until the desired language is selected.

The selected subtitle language is displayed.



To cancel the On Screen Subtitles

Press **SUBTITLE** repeatedly to select "OFF".

NOTE

When playing a disc supporting closed captions, the subtitle and the closed captions may overlap each other on the TV screen. In this case, turn the subtitle setting off.

PLAYING BACK AN MP3 DISC

The unit can play back MP3s recorded on CD-ROM, CD-R or CD-RW discs.

Before playing back an MP3 disc, read the following notes.

Notes on MP3 discs

An MP3 file stores audio data compressed using MPEG1, the audio layer-3 file-coding scheme.

In this manual, we refer to what, in PC terminology, are called "folders" and "files" as "albums" and "tracks."

Notes on playing MP3s

- An MP3 track must be recorded on a disc in the format compliant with ISO 9660. Note however, that the unit may not play tracks in the order they were recorded.
- The maximum allowable number of tracks and/or albums in a disc is 256, including the root albums (directory).
- The maximum allowable depth of a nested folder is 50, including files.
- If a disc contains audio tracks and MP3 tracks, the unit cannot play it.
- As for multi-session discs, the unit plays only the first session.
- The unit can play only MP3 tracks which were converted with a sampling frequency of 44.1 kHz and a fixed bit rate of 128 kbps.
- The unit may not play MP3 tracks recorded using a packet writing utility.
- The unit can play only MP3 tracks having a file extension ".mp3."
- It may take 30 seconds or more before the unit can start play of MP3 tracks, depending on the number of recorded tracks and the complexity of the album tree.
- If you play a non-MP3 track that has the ".mp3" file extension, you may hear some noise.
- Digital recordings with this unit cannot be done while playing back MP3 discs.

Notes on display indications during playback

- Up to 14 characters are displayed for the name of an album or track.
- Characters other than uppercase letters ("A" to "Z"), numerals ("0" to "9") and underscore ("_") may not be displayed, or may be displayed in different characters.
- The elapsed playing time may not be displayed correctly for MP3 tracks.
- Ⓞ is displayed on the MP3 menu if a non-MP3 track is included in a directory or album.
- Depending on the condition of the recording equipment or the CD-R/RW disc itself, a false album or track which cannot be played on the unit may be displayed on TV screen.

Notes on creating MP3 discs

- When converting audio data to MP3
Create MP3 files with a sampling frequency of 44.1 kHz and a fixed bit rate of 128 kbps.
- When creating MP3 discs
Do not store more than 256 albums and/or tracks in a disc.
- To play tracks in the order they were recorded
 1. Use a writing software capable of recording MP3 tracks (files) in numerical and alphabetical order. For details on using the software, refer to the operating instructions supplied with the software.
 2. Use only one album. (Do not create a sub-album within an album.)
 3. Include a two or three-digit number at the beginning of each album or track name so that the albums and tracks are played in order.
<Example of recommended name structure>
01XXXXX.mp3
02XXXXX.mp3
03XXXXX.mp3
04XXXXX.mp3
05XXXXX.mp3
<Avoid using the following structure>
1XXXXX.mp3
5XXXXX.mp3
10XXXXX.mp3
15XXXXX.mp3
20XXXXX.mp3
(The beginning numbers determine the order, therefore the tracks shown above will be played in wrong order, i.e., "1," "10," "15," "20," and "5.")

Glossary

File extension:

A 3-character string added to a file name under the Windows or DOS environment is called a "file extension." A file extension is used mainly to identify types of files. The file extension for MP3 files is ".mp3."

ISO 9660:

ISO stands for the "International Organization for Standardization." ISO 9660 determines the file structure for the CD-ROMs. This unit can play MP3 files recorded in the format compliant with ISO 9660.

Nesting of folders (albums):

To organize data files stored in a PC, you can store related files in a folder. A folder can contain other folders as well as files. For example, folder A can contain folder B, and folder B can contain folder C; this is called "nesting of folders."

Session:

A session is one uninterrupted section of written data on a disc.

A multi-session disc is a disc which has more than two sessions.

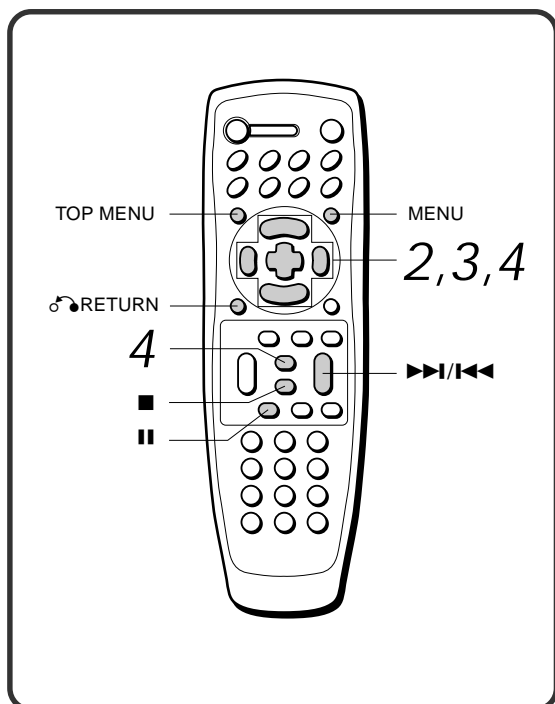

Playing back an MP3 disc

1 Load an MP3 disc.

The MP3 menu is displayed.

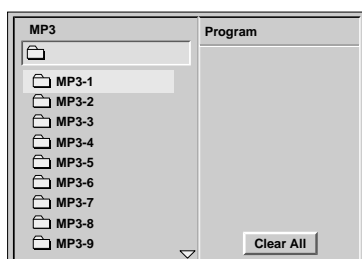

NOTES

- It may take over 30 seconds to read the MP3 files depending on the complexity of the folder tree.
- If you press **RETURN**, **MENU**, or **TOP MENU** during playback, playback stops.

2 Press ▲/▼ to select the album containing the track you want to play.

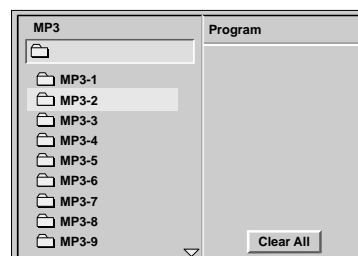

To return to the previous MP3 menu

Press **RETURN**.

To move to the first MP3 menu

Press **MENU**.

3 Press ENTER and press ▲/▼ to select the desired track.

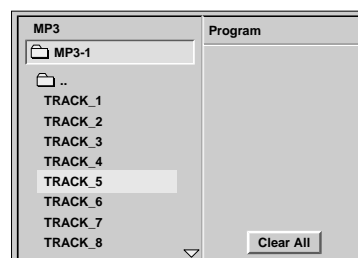

To return to the top of the page within the album

Press **TOP MENU**.

Each time you press the button, the pages within the album will change in rotation.

4 Press ENTER or ▶.

Playback starts and will stop after playing back the last track within the album.

To skip to another track during playback

Press **▶▶/◀◀** repeatedly during playback.
Or press **▲/▼** to select the desired track and press **ENTER**. Playback skips to the desired track within the album.

To stop playback

Press **■**.

To pause playback

Press **||** during playback. To resume playback, press **▶**.

PLAYING BACK AN MP3 DISC (CONTINUED)

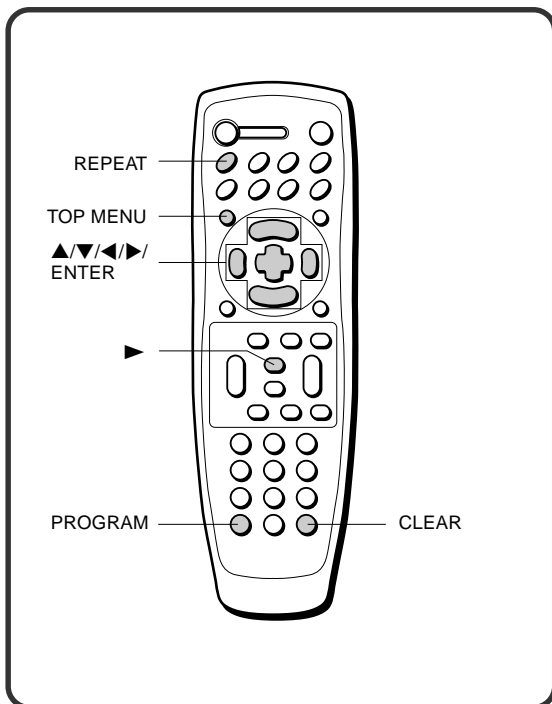

2 Press PROGRAM to list the selected track on the MP3 Program list.

Repeat steps 1 and 2 to select tracks within the album or select a track from another album.

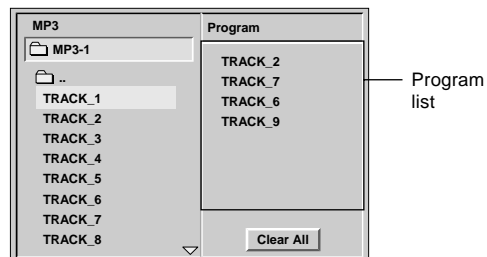

To check the order of programmed tracks

Press the ► right cursor button. Then press **TOP MENU** repeatedly. The program lists will change in rotation when more than 9 tracks are selected. Press the ◀ left cursor button after checking.

3 Press the ► right cursor button.

The programmed track you selected last is highlighted on the program list.

4 Press ▲/▼ to select the track you want to start playing.

To select the first track on the program list, press **TOP MENU** once.

Each time you press **TOP MENU** repeatedly, the highlighted area moves to the first track on each page of the program list.

5 Press ENTER or ►.

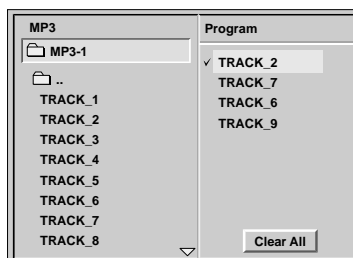

Playback stops after playing the last programmed track on the program list.

NOTE

Unlike Audio CD operations, the following playback modes and functions do not work when playing back an MP3 disc.

- Fast forward ►►, Fast reverse ◀◀, Random and A-B Repeat playback.
- OSD menu, Resume, Surround and Selecting audio track function.

Programmed playback

Up to 60 tracks per disc can be programmed.

1 Follow steps 2 and 3 of "Playing back an MP3 disc" on page 35.

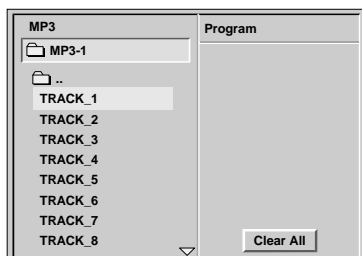

To clear the programs one by one

Press ▲/▼ in step 4 to the left to delete the track from the MP3 program list, then press **CLEAR**.

To clear all the programs

Press ▲/▼ in step 4 to the left to select "Clear All" on the MP3 program list, then press **ENTER**.
The program settings are also cleared when the disc is removed.

To return to the normal playback

Press the ◀ left cursor button. Then select an album or a desired track.

NOTES

- The ⏮ **RETURN** and **MENU** buttons do not work during programmed playback.
- If you press **TOP MENU** repeatedly during programmed playback, playback starts from the first track on each page of the program list.

Repeat playback

To play back a track repeatedly

Press **REPEAT** once during playback.
The current track will be played back repeatedly.

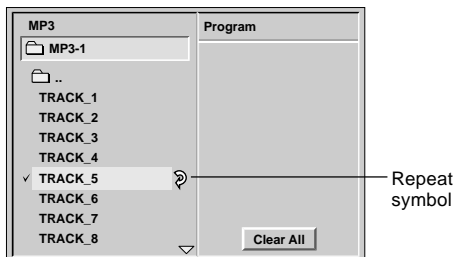

To play back a programmed track repeatedly

Press **REPEAT** once during programmed playback.
The current track will be played back repeatedly.

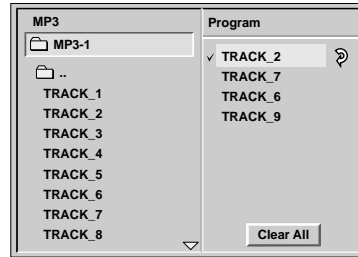

To play back all of the listed tracks repeatedly

Press **REPEAT** twice during programmed playback.
All of the listed tracks on the MP3 Program list will be played back repeatedly.

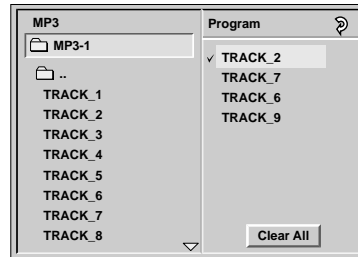

To cancel repeat playback

Press **REPEAT** repeatedly until the Repeat symbol disappears.

NOTE

Repeat playback of one track will be canceled if you press ▲/▼ or ◀▶▶▶.

To play back an entire album repeatedly

Press **REPEAT** twice during playback.
All of the tracks within the album will be played back repeatedly.

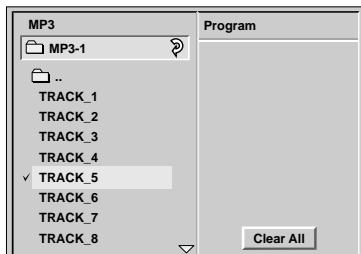

En

CHANGING SETUP VALUES

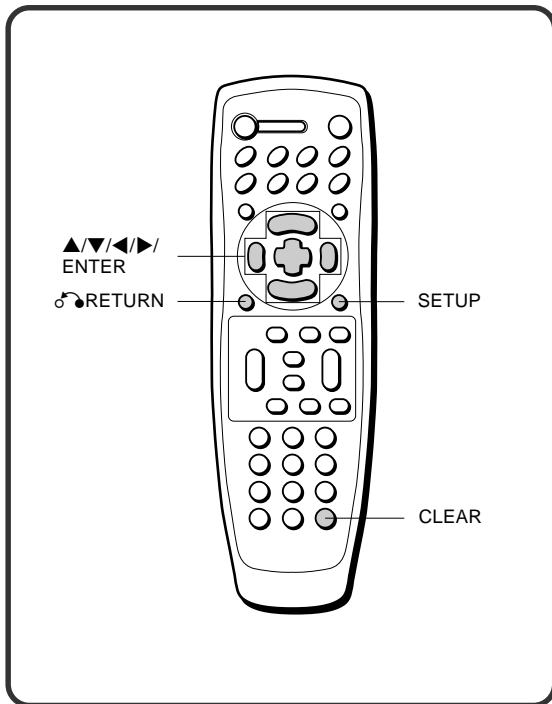

2 Press ▲/▼ to select the item to be changed, then press the ► right cursor button or ENTER.

Disc Audio*

Sets the audio soundtrack language.

Disc Subtitle*

Sets the subtitle language.

Disc Menu*

Sets the language used in the DVD menu screen.

* If the selected language does not exist on the disc, the original language for the disc.

Rating

Sets the preset restriction level for playback. When playing discs with preset restriction level encoding, the unit automatically cuts scenes of excessive violence, etc.

Password

Sets the password to prevent children from changing the restriction level.

TV Aspect

Sets the aspect ratio of the TV connected to the unit.

Menu Language

Sets the language on the setup menu.

Digital Audio Output

Sets the digital audio to be output from the unit according to the type of audio equipment connected to the unit.

Others

Turns on/off the DRC (Dynamic Range Control) and PBC (Playback control) function.

All the basic settings of the unit are properly preset at the factory.

- Check that "Digital Audio Output" and "TV Aspect" in the setup menu are correctly set according to the type of equipment connected to the unit. For details on the setting, refer to the "Connections" section on pages 9 to 17.
- Change any other settings according to your individual setup preferences.

Basic operations

1 Press SETUP during playback or in stop mode.

The setup menu is displayed.



3 Press ▲/▼ to select the desired setting and press ENTER.

Some items require additional steps. For details of the setting options for each item, see the procedure of each setting on the following pages.

To exit the setup menu

Press SETUP or RETURN.

Disc Audio

The audio sound track language on a DVD disc can be changed. If the selected language is not available on the disc, the original language for the disc is selected.

- 1 Press ▲/▼ to select "Disc Audio" on the setup menu and press the ► right cursor button.



- 2 Press ▲/▼ to select the desired language and press ENTER.

Original :

The original language set for the disc is selected.

English/French/German/Spanish/Italian/Chinese/Polish/Hungarian/Russian

Other :

To select another language, press the number buttons to enter the corresponding 4-digit number according to the language code list on page 45. If you enter the wrong language cord, press **CLEAR**.

Disc Subtitle

The subtitle language on a DVD disc can be changed. If the selected language is not available on the disc, the original language for the disc is selected.

- 1 Press ▲/▼ to select "Disc Subtitle" on the setup menu and press the ► right cursor button.



- 2 Press ▲/▼ to select the desired language and press ENTER.

The language selections are the same as that of the Disc Audio setting.

Disc Menu

The language used in the DVD menu can be changed. If the selected language is not available on the disc, the original language for the disc is selected.

- 1 Press ▲/▼ to select "Disc Menu" on the setup menu and press the ► right cursor button.



- 2 Press ▲/▼ to select the desired language and press ENTER.

The language selections are the same as that of the Disc Audio setting.

CHANGING SETUP VALUES (CONTINUED)

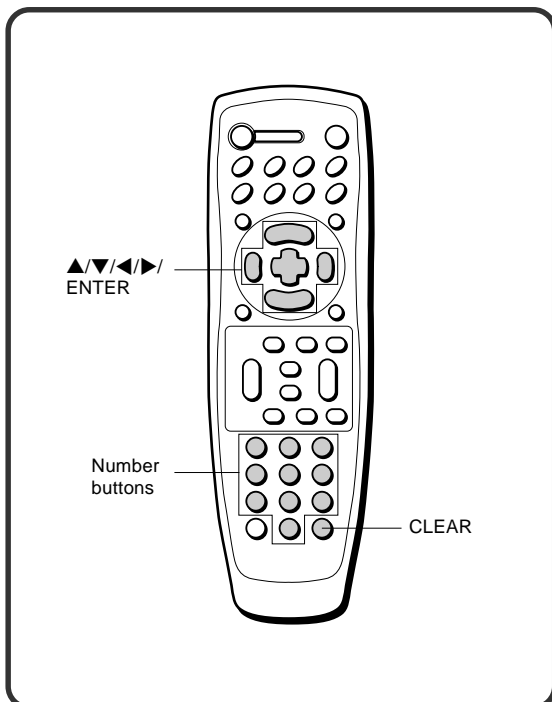

2 Press ▲/▼ to select the desired restriction level and press ENTER.

Disc Audio	8 Blocked
Disc Subtitle	7 Blocked
Disc Menu	√6
Rating	5
Password	4
TV Aspect	3
Menu Language	2
	1
Digital Audio Output	Unlock
Others	

You cannot play DVD discs rated higher than the level you select unless you cancel the parental lock function. For example, when you select level 6, discs rated higher than level 6 are blocked and cannot be played.

- The parental lock level is equivalent to the following USA movie ratings.

Example:
 Level 7: NC-17 Level 6:R Level 4: PG 13
 Level 3: PG Level 1: G

- The password (4-digits) can be set so that the rating cannot be easily changed. After setting the password, the rating cannot be changed unless you input the password. For details on setting the password, see "Password" on page 41.

Rating

Some DVD discs contain a restriction level which enables parents to remove scenes or prevent children from playing the discs. This unit is equipped with a password designed to prevent children from changing the level.

1 Press ▲/▼ to select "Rating" on the setup menu and press the ► right cursor button.

Disc Audio	8
Disc Subtitle	7
Disc Menu	6
Rating	5
Password	4
TV Aspect	3
Menu Language	2
	1
Digital Audio Output	►Unlock
Others	

To cancel the rating

Select "Unlock" in step 2.

Password

A 4-digit password can be set to prevent playing discs with higher ratings.

- 1 Press ▲/▼ to select "Password" on the setup menu and press the ► right cursor button.



- 2 Enter a 4-digit password using the number buttons, then press ENTER.

Example : To set the password 1234
Press 1, 2, 3 and 4.

Do not forget your password.



• If you enter the wrong number, press CLEAR.

- 3 Enter the same 4-digit password again to verify, then press ENTER.



The password is set.

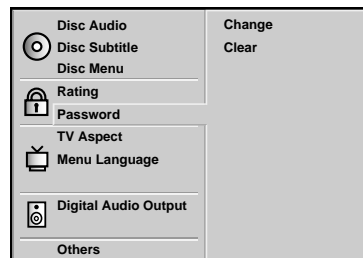

The rating is locked. Any discs with a higher rating than the setting cannot be played back.

To change the rating level

- 1 Select "Rating" on the setup menu and press the ► right cursor button.
- 2 Enter the password using the number buttons and press ENTER.
- 3 Change the rating level and press ENTER (see page 40).

To change the password

- 1 Select "Password" on the setup menu and press the ► right cursor button.
- 2 Enter the 4-digit password and press ENTER.
- 3 Select "Change" and press ENTER.
- 4 Follow steps 2 and 3 of password setting on the left.

To clear the password

- 1 Select "Password" on the setup menu and press the ► right cursor button.
- 2 Enter the 4-digit password and press ENTER.
- 3 Select "Clear" and press ENTER.

If you forget your 4-digit password

- 1 Select "Password" on the setup menu.
- 2 Enter the 6-digit number "210499" and press ENTER.
The 4-digit password that you entered is cleared.

AS NECESSARY

En

CONTINUE

ENGLISH 41

CHANGING SETUP VALUES (CONTINUED)

TV Aspect

Select the appropriate screen type of your TV:
conventional size screen (4:3) or wide-screen (16:9).

- 1 Press ▲/▼ to select "TV Aspect" on the setup menu and press the ► right cursor button.



- 2 Press ▲/▼ to select the desired TV Aspect and press ENTER.

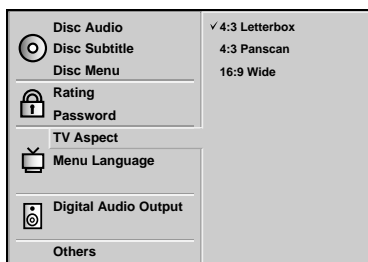

4:3 Panscan :

Select this when playing media that contains pan-scan encoding. Media recorded in wide (16:9) format will be played at the full screen height, with the left and right portions cut off. Other media will be played in "Letterbox" style.

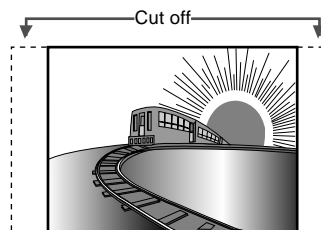

4:3 Panscan

16:9 Wide :

Select this when a wide-screen TV is connected.
Played in "FULL" size. (Setting the wide-screen TV to "FULL" mode is also necessary.)

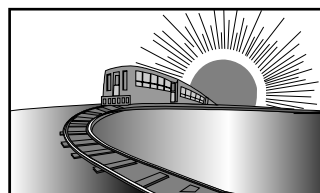

16:9 Wide

- Each screen shows an example when playing material for a wide-screen.
(This setting does not affect the video material for conventional size.)

4:3 Letterbox :

Select this when a conventional TV is connected. Media recorded in wide (16:9) format will be played in "Letterbox" style, with black bands at the top and bottom of the screen.



4:3 Letterbox

Menu Language

The language used in this setup menu can be changed.

- 1 Press ▲/▼ to select "Menu Language" on the setup menu and press the ► right cursor button.



- 2 Press ▲/▼ to select the desired language and press ENTER.



English/Spanish/French/German/Italian:

The setup menu is displayed in the selected language.

Digital Audio Output

Each DVD disc has a variety of audio output options. Set the Digital Audio Output of the unit according to the type of audio system you use.

CAUTION

When connecting an AV receiver not equipped with a Dolby Digital decoder or DTS decoder using an optical or coaxial connecting cord, do not select "DOLBY DIGITAL/PCM" or "Stream/PCM" in the "Digital Audio Output."

Merely attempting to play a DVD may cause a screeching of noise which could be harmful to your ears and damage the speakers. In such a case, be sure to select "PCM."

- 1 Press ▲/▼ to select "Digital Audio Output" on the setup menu and press the ► right cursor button.



- 2 Press ▲/▼ to select the desired output and press ENTER.



AS NECESSARY

En

CONTINUE

ENGLISH 43

CHANGING SETUP VALUES (CONTINUED)

DOLBY DIGITAL/PCM:

Select this when connecting to an AV receiver or other equipment equipped with a Dolby Digital (AC-3) decoder or a Dolby Pro Logic Surround decoder.

Stream/PCM:

Select this when connecting to an AV receiver or other equipment equipped with a DTS decoder or an MPEG decoder.

PCM:

The default setting. Select when connecting to an audio system without a Dolby Digital(AC-3), DTS, or other special decoder.

Playback Disc	OUTPUT		
	Stream/PCM	DOLBY DIGITAL/PCM	PCM
96kHz Linear PCM DVD	PCM	PCM	PCM
DTS DVD	DTS bit Stream	Not output	Not output
Dolby Digital DVD	Dolby Digital bit Stream	Dolby Digital bit Stream	PCM
MPEG DVD	MPEG bit Stream	PCM	PCM
Audio CD/ Video CD	PCM	PCM	PCM
DTS Audio CD	DTS bit Stream	DTS bit Stream	DTS bit Stream

Others

The settings for DRC (Dynamic Range Control) and PBC (Playback control) can be changed.

- 1 Press ▲/▼ to select "Others" on the setup menu and press the ► right cursor button.



- 2 Press ▲/▼ to select the desired items and press ENTER.

Each time you press ENTER, the setting turns "On" or "Off" in turn.

Dynamic Range Control (DRC) setting

When listening at a low volume, Dynamic Range Control reduces the volume of loud sounds such as explosions, etc., and increases the volume of quiet sounds such as whispered dialog, etc.

This function only works for the analog audio output signals (AUDIO OUT1 and 2 of this unit) while playing DVDs recorded with DOLBY DIGITAL(AC-3).

DRC On:

Select this when playing back at low volume.

DRC Off:

The sound is played back normally.

Playback control (PBC) setting

PBC On:

Select this when playing VIDEO CD discs with the PBC function.

PBC Off:

Video CDs are played back in the same way as audio CDs.

Language codes

Code	Language	Code	Language	Code	Language
6565	Afar	7285	Hungarian	8084	Portuguese
6566	Abkhazian	7289	Armenian	8185	Quechua
6570	Afrikaans	7365	Interlingua	8277	Rhaeto-Romance
6577	Amharic	7378	Indonesian	8279	Romanian
6582	Arabic	7383	Icelandic	8285	Russian
6583	Assamese	7384	Italian	8365	Sanskrit
6588	Aymara	7387	Hebrew	8368	Sindhi
6590	Azerbaijani	7465	Japanese	8372	Serbo-Croatian
6665	Bashkir	7473	Yiddish	8373	Singhalese
6669	Byelorussian	7487	Javanese	8375	Slovak
6671	Bulgarian	7565	Georgian	8376	Slovenian
6672	Bihari	7575	Kazakh	8377	Samoaan
6678	Bengali; Bangla	7576	Greenlandic	8378	Shona
6679	Tibetan	7577	Cambodian	8379	Somali
6682	Breton	7578	Kannada	8381	Albanian
6765	Catalan	7579	Korean	8382	Serbian
6779	Corsican	7583	Kashmiri	8385	Sundanese
6783	Czech	7585	Kurdish	8386	Swedish
6789	Welsh	7589	Kirghiz	8387	Swahili
6865	Danish	7665	Latin	8465	Tamil
6869	German	7678	Lingala	8469	Telugu
6890	Bhutani	7679	Laothian	8471	Tajik
6976	Greek	7684	Lithuanian	8472	Thai
6978	English	7686	Latvian, Lettish	8473	Tigrinya
6979	Esperanto	7771	Malagasy	8475	Turkmen
6983	Spanish	7773	Maori	8476	Tagalog
6984	Estonian	7775	Macedonian	8479	Tonga
6985	Basque	7776	Malayalam	8482	Turkish
7065	Persian	7778	Mongolian	8484	Tatar
7073	Finnish	7779	Moldavian	8487	Twi
7074	Fiji	7782	Marathi	8575	Ukrainian
7079	Faroese	7783	Malay	8582	Urdu
7082	French	7784	Maltese	8590	Uzbek
7089	Frisian	7789	Burmese	8673	Vietnamese
7165	Irish	7865	Nauru	8679	Volapük
7168	Scots Gaelic	7869	Nepali	8779	Wolof
7176	Galician	7876	Dutch	8872	Xhosa
7178	Guarani	7879	Norwegian	8979	Yoruba
7185	Gujarati	7982	Oriya	9072	Chinese
7265	Hausa	8065	Punjabi	9085	Zulu
7273	Hindi	8076	Polish		
7282	Croatian	8083	Pashto, Pushto		

AS NECESSARY

En

TROUBLESHOOTING

If something seems to be wrong with your DVD player, first check the items in the table below.

Symptom	Check	See page
The power does not come on.	<ul style="list-style-type: none"> Is the power cord plugged firmly into a live outlet? 	9
The disc does not play. Playback stops almost immediately.	<ul style="list-style-type: none"> Is there condensation inside the unit? (Leave the player idle with the power on for 1 to 2 hours.) Are you trying to use a disc not available for the unit, such as a PHOTO CD? Is the disc dirty? Is it loaded properly? Does the disc exceed the specified parental control rating level? 	2 4 5, 19 40
No picture.	<ul style="list-style-type: none"> Is the unit connected correctly? Are the video connections firmly attached? Is the television video mode set correctly? 	9 9 19
The picture is bad.	<ul style="list-style-type: none"> Is the unit in a place subject to vibrations? Are the video connections firmly attached? Is the disc dirty? Is the unit connected directly to the TV? Or is it connected through a VCR, a selector switch, or a TV/VCR? <p>The picture may be bad when used with some television sets or projectors, due to the DVD copy protection scheme.</p> <p>The picture quality may also suffer if the DVD player is connected through a selector switch with other video equipment. Try turning off the power to the other video equipment.</p> <p>The picture quality may be somewhat poor when paused, when doing Frame Advance, or during fast forward or fast reverse. This is normal.</p>	2 9 5 9
No sound.	<ul style="list-style-type: none"> Is the unit connected correctly? Are the audio connections firmly attached? Is the connected audio equipment turned on? Is the volume set correctly? (Note that there will be no audio playback during slow playback, Frame Advance, fast forward, or fast reverse.) 	9 9 19
The remote control does not work, or does not work correctly.	<ul style="list-style-type: none"> Are the remote control batteries installed correctly? Is the remote control too far from the main unit? Is there something in the way? Are the remote control batteries getting weak? Is the unit in strong sunlight or strong fluorescent light? 	18 18 18 18

DVD has many capabilities

Some of these capabilities may differ based on the disc being played. The following situations may be caused by information on the disc itself.

- The audio or subtitles are not reproduced in the language specified in the setup menu.
- The audio track or subtitles cannot be changed.
- Subtitles are not displayed.
- The DVD menu is not displayed. The DVD menu is not displayed in the language you want.
- The viewing angle cannot be changed.
- The rating restriction does not work.

SPECIFICATIONS

Power supply	120 V AC, 60 Hz
Power consumption	16 W
Power consumption in standby mode	2.9 W
Weight	3.2 kg (7.1 lbs)
External dimensions	430 × 88 × 245 mm (w × h × d) (17 × 3.5 × 9.9 inches)
Laser	Semiconductor Laser, wavelength 650/780 nm
Signal format	NTSC
Supported discs	DVD video discs 12 cm (single-sided single-layer, single-sided double-layer, double-sided double-layer) 8 cm (single-sided single-layer, single-sided double-layer, double-sided double-layer) Compact discs (CD-DA, video CD) 12 cm and 8 cm discs
S video output	Y output: 1 Vp-p (75 ohms, sync negative) C output: 0.286 Vp-p 1 Mini Din 4 pin
Video output	Video composite output 1 Vp-p (75 ohms, sync negative) 1 RCA jack Video component output Y output: 1 Vp-p (75 ohms, sync negative) P _B , P _R output: 0.7 Vp-p (75 ohms) 1 RCA jacks (P _B , P _R , Y)
Audio output	Digital output 0.5 Vp-p (75 ohms) 1 Fiber optical connector 1 RCA jack Analog output 2.0 Vrms (1 kHz, 0 dB, 330 ohms) 2 RCA jacks (L/R)
Audio output characteristics	Signal to noise ratio More than 105 dB (EIAJ) Dynamic range More than 95 dB (EIAJ) Harmonic distortion 0.003% Frequency range: CD/VCD: 2 Hz to 20 kHz DVD: 2 Hz to 22 kHz (48 kHz sampling) 2 Hz to 44 kHz (96 kHz sampling) Wow and flutter: unmeasurable
Operating conditions	5°C to 35°C (41°F to 95°F)
Accessories	Video cable (1) Audio cable (1) Remote control (1)

NOTE

This equipment has been tested and found to comply with the limits for a Class B digital device, pursuant to Part 15 of the FCC Rules. These limits are designed to provide reasonable protection against harmful interference in a residential installation.

This equipment generates, uses, and can radiate radio frequency energy and, if not installed and used in accordance with the instructions, may cause harmful interference to radio communications. However, there is no guarantee that interference will not occur in a particular installation. If this equipment does cause harmful interference to radio or television reception, which can be determined by turning the equipment off and on, the user is encouraged to try to correct the interference by one or more of the following measures:

- Reorient or relocate the receiving antenna.
- Increase the separation between the equipment and receiver.
- Connect the equipment into an outlet on a circuit different from that to which the receiver is connected.
- Consult the dealer or an experienced radio/TV technician for help.

CAUTION

Modifications or adjustments to this product, which are not expressly approved by the manufacturer, may void the user's right or authority to operate this product.

- Manufactured under license from Dolby Laboratories. "Dolby", "Pro Logic" and the double-D symbol are trademarks of Dolby Laboratories. Confidential unpublished works. ©1992-1997 Dolby Laboratories. All rights reserved.

- Manufactured under license from Digital Theater Systems, Inc. US Pat. No. 5,451,942 and other worldwide patents issued and pending. "DTS" and "DTS Digital Surround" are trademarks of Digital Theater Systems, Inc. ©1996 Digital Theater systems, Inc. All rights reserved.



As an ENERGY STAR® Partner, AIWA has determined that this product meets the ENERGY STAR® guidelines for energy efficiency.

AS NECESSARY

En

Specifications are subject to change without notice.

ENGLISH 47

AIWA CO.,LTD.

 <http://www.aiwa.co.jp>

For Assistance and Information, *Call Toll Free 1-800-BUY-AIWA* (United States and Puerto Rico)

Printed in Korea

Free Manuals Download Website

<http://myh66.com>

<http://usermanuals.us>

<http://www.somanuals.com>

<http://www.4manuals.cc>

<http://www.manual-lib.com>

<http://www.404manual.com>

<http://www.luxmanual.com>

<http://aubethermostatmanual.com>

Golf course search by state

<http://golfingnear.com>

Email search by domain

<http://emailbydomain.com>

Auto manuals search

<http://auto.somanuals.com>

TV manuals search

<http://tv.somanuals.com>