



Micro Hi-Fi Component System

Operating Instructions

Owner's Record

The model and serial numbers are located on the rear of the unit. Record the serial number in the space provided below. Refer to them whenever you call upon your Aiwa dealer regarding this product.

Model No. _____ Serial No. _____



AWP-ZX7

©2004 Sony Corporation

Download from www.Somanuals.com. All Manuals Search And Download.

WARNING

To prevent fire or shock hazard, do not expose the unit to rain or moisture.

To prevent fire, do not cover the ventilation of the apparatus with news papers, table-cloths, curtains, etc. And don't place lighted candles on the apparatus.

To prevent fire or shock hazard, do not place objects filled with liquids, such as vases, on the apparatus.

Do not install the appliance in a confined space, such as a bookcase or built-in cabinet.

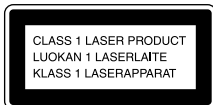

This appliance is classified as a CLASS 1 LASER product. This marking is located on the rear exterior.



Don't throw away the battery with general house waste, dispose of it correctly as chemical waste.

NOTICE FOR THE CUSTOMERS IN THE U.S.A.



This symbol is intended to alert the user to the presence of uninsulated "dangerous voltage" within the product's enclosure that may be of sufficient magnitude to constitute a risk of electric shock to persons.



This symbol is intended to alert the user to the presence of important operating and maintenance (servicing) instructions in the literature accompanying the appliance.

CAUTION

The use of optical instruments with this product will increase eye hazard.

WARNING

This equipment has been tested and found to comply with the limits for a Class B digital device, pursuant to Part 15 of the FCC Rules. These limits are designed to provide reasonable protection against harmful interference in a residential installation. This equipment generates, uses, and can radiate radio frequency energy and, if not installed and used in accordance with the instructions, may cause harmful interference to radio communications. However, there is no guarantee that interference will not occur in a particular installation. If this equipment does cause harmful interference to radio or television reception, which can be determined by turning the equipment off and on, the user is encouraged to try to correct the interference by one or more of the following measures:

- Reorient or relocate the receiving antenna.
- Increase the separation between the equipment and receiver.
- Connect the equipment into an outlet on a circuit different from that to which the receiver is connected.
- Consult the dealer or an experienced radio/TV technician for help.

Note to CATV system installer:

This reminder is provided to call the CATV system installer's attention to Article 820-40 of the NEC that provides guidelines for proper grounding and, in particular, specifies that the cable ground shall be connected to the grounding system of the building, as close to the point of cable entry as practical.

CAUTION

You are cautioned that any changes or modifications not expressly approved in this manual could void your authority to operate this equipment.

NOTICE FOR THE CUSTOMERS IN THE
U.S.A.

If you have any questions about this product, you may
call; Aiwa Customer Information Service Center
1-800-289-2492 or <http://www.us.aiwa.com/>

The Number below is for the FCC related matters only.

Regulatory Information

Declaration of Conformity

Trade name: AIWA
Model No.: AWP-ZX7
Responsible Party: Sony Electronics Inc.
Address: 16450 W. Bernardo Dr, San
Diego, CA 92127 U.S.A.
Telephone No.: 858-942-2230

This device complies with Part 15 of the FCC Rules.
Operation is subject to the following two
conditions: (1) This device may not cause harmful
interference, and (2) this device must accept any
interference received, including interference that
may cause undesired operation.

NOTICE FOR THE CUSTOMERS IN CANADA

CAUTION

TO PREVENT ELECTRIC SHOCK, MATCH WIDE
BLADE OF PLUG TO WIDE SLOT, FULLY
INSERT.

CAUTION

The use of optical instruments with this product will
increase eye hazard.

Except for European model



ENERGY STAR® is a U.S.
registered mark. As an ENERGY
STAR® partner, Sony Corporation
has determined that this product
meets the ENERGY STAR®
guidelines for energy efficiency.

- Microsoft, Windows and Windows NT are trademarks or registered trademarks of Microsoft Corporation in the United States and/or other countries.
- IBM and PC/AT are registered trademarks of International Business Machines Corporation.
- Macintosh is a trademark of Apple Computer, Inc. in the United States and/or other countries.
- MMX and Pentium are trademarks or registered trademarks of Intel Corporation.
- All other trademarks and registered trademarks are trademarks or registered trademarks of their respective holders.
- ™ and ® marks are omitted in this manual.

Table of Contents

| | |
|---|----|
| How to use this manual..... | 5 |
| Playable discs..... | 5 |
| <hr/> | |
| Getting Started | |
| Hooking up the system..... | 7 |
| Setting the clock..... | 9 |
| <hr/> | |
| CD/MP3 – Play | |
| Loading a disc..... | 10 |
| Playing a disc..... | 10 |
| — Normal Play/Shuffle Play | |
| Playing repeatedly..... | 12 |
| — Repeat Play | |
| Creating your own program..... | 13 |
| — Program Play | |
| <hr/> | |
| Tuner | |
| Presetting radio stations..... | 14 |
| Listening to the radio..... | 15 |
| — Preset Tuning | |
| — Manual Tuning | |
| Using the Radio Data System (RDS).... | 16 |
| (European model only) | |
| <hr/> | |
| Tape – Play | |
| Loading a tape..... | 17 |
| Playing a tape..... | 17 |
| <hr/> | |
| Tape – Recording | |
| Recording your favorite CD tracks on a tape..... | 18 |
| — CD-TAPE Synchro Recording | |
| Recording on a tape manually..... | 19 |
| — Manual Recording | |
| <hr/> | |
| Sound Adjustment | |
| Adjusting the sound..... | 20 |
| <hr/> | |
| Timer | |
| Falling asleep to music..... | 20 |
| — Sleep Timer | |
| Waking up to music..... | 21 |
| — Play Timer | |
| Timer recording radio programs..... | 22 |
| — Rec Timer | |
| <hr/> | |
| Display | |
| Turning off the display..... | 23 |
| — Power Saving Mode | |
| Viewing information about the disc in the display..... | 23 |
| <hr/> | |
| Optional Personal Computer | |
| Connecting a personal computer to the system..... | 25 |
| Installing the driver..... | 26 |
| Listening to audio files on a personal computer..... | 29 |
| <hr/> | |
| Optional Components | |
| Hooking up optional components..... | 30 |
| Listening to audio from a connected component..... | 31 |
| <hr/> | |
| Troubleshooting | |
| Problems and remedies..... | 32 |
| Messages..... | 35 |
| <hr/> | |
| Additional Information | |
| Precautions..... | 36 |
| Specifications..... | 37 |
| List of button locations and reference pages..... | 39 |





How to use this manual

This manual mainly explains operations using the remote, but the same operations can also be performed using the buttons on the system having the same or similar names.

Playable discs

You can play back the following discs on this system. Other discs cannot be played back.

List of playable discs

| Format of discs | Disc logo |
|--------------------------------------|--|
| Audio CDs |  |
| CD-R/CD-RW (audio data/MP3 files) |     |

Discs that this system cannot play

- An 8 cm disc
- An 8 cm disc converted to a standard disc using an adaptor
- CD-ROMs
- CD-Rs/CD-RWs other than those recorded in the following formats:
 - music CD format
 - MP3 format that conforms to ISO9660¹⁾ Level 1/Level 2, Joliet, Romeo or Multi Session²⁾
- A disc that has a non-standard shape (e.g., card, heart).
- A disc with paper or stickers on it.
- A disc that has the adhesive, cellophane tape, or a sticker still left on it.

1) ISO 9660 Format

The most common international standard for the logical format of files and folders on a CD-ROM. There are several specification levels. In Level 1, file names must be in the 8.3 format (no more than eight characters in the name, no more than three characters in the extension “.MP3”) and in capital letters. Folder names can be no longer than eight characters. There can be no more than eight nested folder levels. Level 2 specifications allow file names and folder names up to 31 characters long. Each folder can have up to 8 trees.

For Joliet or Romeo in the expansion format, make sure of the contents of the writing software, etc.

2) Multi Session

This is a recording method that enables adding of data using the Track-At-Once method. Conventional CDs begin at a CD control area called the Lead-in and end at an area called Lead-out. A Multi Session CD is a CD having multiple sessions, with each segment from Lead-in to Lead-out regarded as a single session.

CD-Extra: This format records audio (audio CD data) on the tracks in session 1 and data on the tracks in session 2.

Mixed CD: This format records data on the first track and audio (audio CD data) on the second and subsequent tracks of a session.

continued

Notes on CD-R and CD-RW

- Some CD-Rs or CD-RWs cannot be played on this system depending upon the recording quality or physical condition of the disc, or the characteristics of the recording device. Furthermore, the disc will not play if it has not been correctly finalized. For more information, see the operating instructions for the recording device.
- Discs recorded on CD-R/CD-RW drives may not be played back because of scratches, dirt, recording condition or the driver's characteristics.
- CD-R and CD-RW discs recorded in multi-session that have not ended by "closing the session" are not supported.
- The system may be unable to play MP3 format files that do not have the ".MP3" extension.
- Attempting to play non-MP3 format files that have the ".MP3" extension may result in noise or malfunction.
- With formats other than ISO9660 level 1 and 2, folder names or file names may not be displayed correctly.
- The following discs take a longer time to start playback.
 - a disc recorded with complicated tree structure.
 - a disc recorded in Multi Session.
 - a disc to which data can be added (non-finalized disc).

Music discs encoded with copyright protection technologies

This product is designed to playback discs that conform to the Compact Disc (CD) standard. Recently, various music discs encoded with copyright protection technologies are marketed by some record companies. Please be aware that among those discs, there are some that do not conform to the CD standard and may not be playable by this product.

Cautions when playing a disc that is recorded in Multi Session

- If the disc begins with a CD-DA session, it is recognized as a CD-DA (audio) disc, and playback continues until an MP3 session is encountered.
- If the disc begins with an MP3 session, it is recognized as an MP3 disc, and playback continues until a CD-DA (audio) session is encountered.
- The playback range of an MP3 disc is determined by the tree structure of files produced by analyzing of the disc.
- A disc with a mixed CD format will be recognized as a CD-DA (audio) disc.

Hooking up the system

Perform the following procedures **1** to **4** to hook up your system using the supplied cords and accessories.

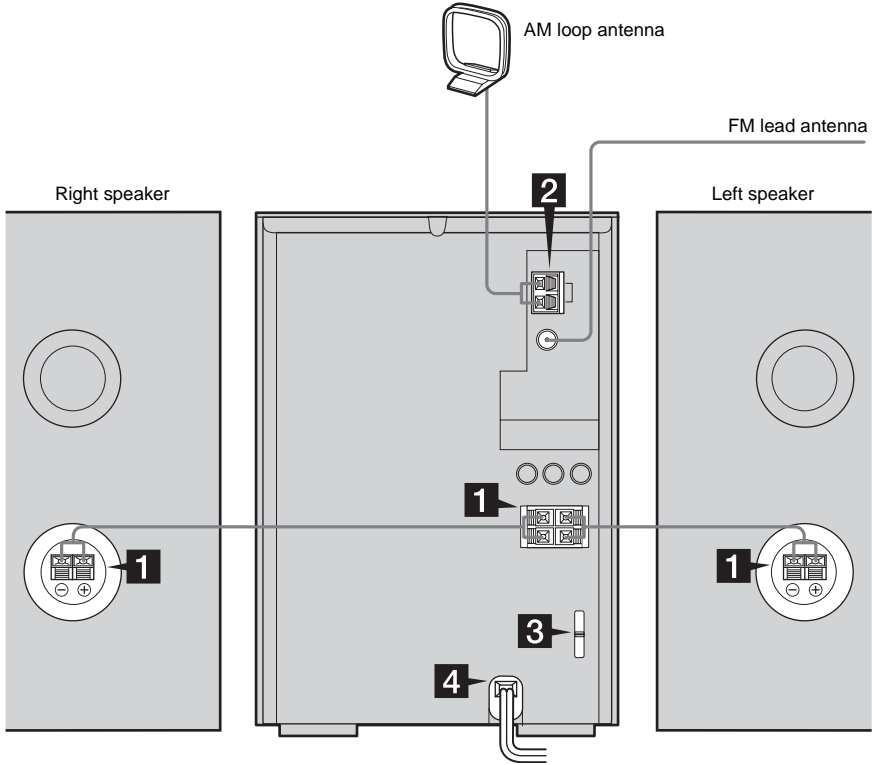

1 Connect the speakers.

Connect the right and left speaker cords to the SPEAKER terminals as shown below.

Main Unit

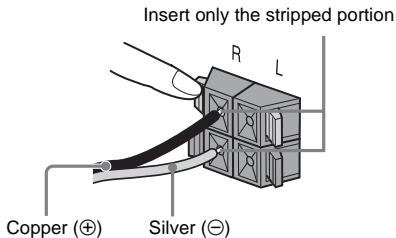

Speakers

Insert only the stripped portion

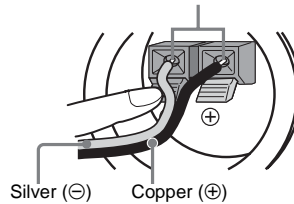

continued

2 Connect the FM and AM antennas.

Set up the AM loop antenna, then connect it.

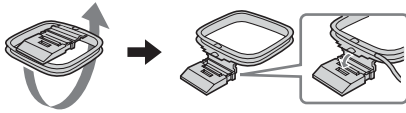

Plug type **A**

AM loop antenna

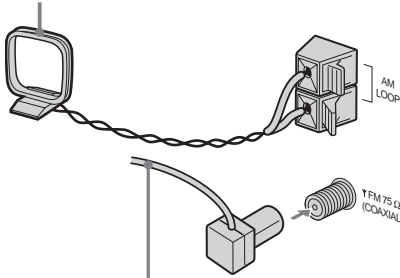

Extend the FM lead antenna horizontally

Plug type **B**

AM loop antenna

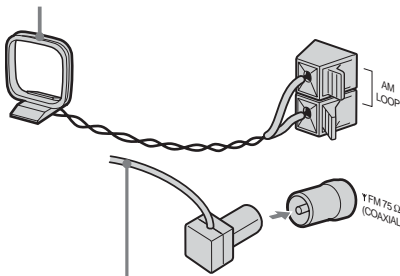

Extend the FM lead antenna horizontally

Note

Keep the antennas away from the speaker cords.

3 For models with a voltage selector, set VOLTAGE SELECTOR to the local power line voltage.

Refer to the print on your system's VOLTAGE SELECTOR for available settings.

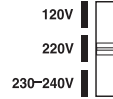

4 Connect the power cord to a wall outlet.

If the plug does not fit the wall socket, detach the supplied plug adaptor (only for models equipped with an adaptor).

To turn on the system, press I/⏻.

Inserting two R6 (size AA) batteries into the remote

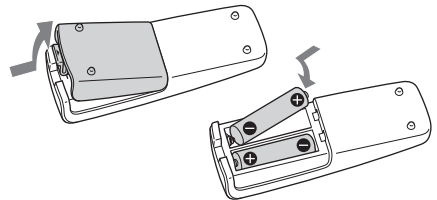

Note

If you do not use the remote for a long period of time, remove the batteries to avoid possible damage from battery leakage and corrosion.

Tip

When the remote no longer operates the system, replace both batteries with new ones.

Attaching the speaker pads

Attach the supplied speaker pads to the bottom of the speakers to stabilize the speakers and prevent them from slipping.

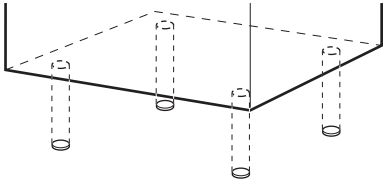

When carrying this system

Perform the following procedure to protect the CD mechanism.

- 1 Make sure that all discs are removed from the system.
- 2 Press FUNCTION repeatedly to switch the function to CD.
- 3 Hold down ▲ CD and then press ►► on the unit until "STANDBY" appears. After "STANDBY" disappears, then "LOCK" appears.
- 4 Unplug the power cord.

Setting the clock

Use buttons on the remote for the operation.

- 1 Press I/⏻ to turn on the system.
- 2 Press CLOCK/TIMER SET.
- 3 Press I◀◀ or ▶▶I repeatedly to set the hour.
- 4 Press ENTER.
- 5 Press I◀◀ or ▶▶I repeatedly to set the minute.
- 6 Press ENTER.

The clock starts working.

To adjust the clock

- 1 Press CLOCK/TIMER SET.
- 2 Press I◀◀ or ▶▶I until "CLOCK SET?" appears, then press ENTER.
- 3 Do the same procedures as step 3 to 6 above.

Notes

- The clock settings are canceled when you disconnect the power cord or if a power failure occurs.
- You cannot set the clock in Power Saving Mode (page 23).

Loading a disc

Use buttons on the unit for the operation.

- 1 Press **DISC 1 – 5** to select a disc **stocker**.

If a disc is loaded, press **▲ CD** to remove a disc from the disc slot. “No Disc” appears.

- 2 Insert a disc in the disc slot with the **label side facing right**.

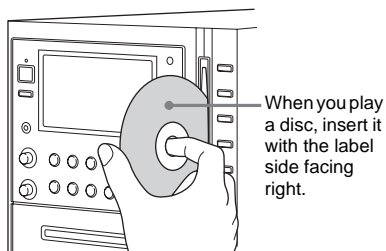

To insert additional discs, repeat steps 1 through 2.

Notes

- **When you turn on the system, the disc is not pulled into the disc slot until “No Disc” appears in the display. Do not attempt to push in the disc until “No Disc” appears.**
- When pressing **▲ CD** and then reinserting the disc that appears in the disc slot, do not simply push in the disc. Remove the disc from the disc slot and then reinsert it.
- Do not turn off the system with a disc halfway inserted in the disc slot. Doing so may cause the disc to fall.
- Do not use a disc with tape, seals or paste on it as this may cause malfunction.
- Do not load an 8 cm disc with an adaptor. Doing so may cause the system to malfunction.
- When you eject a disc, handle the disc by its edge. Do not touch the surface.
- If you load a disc that is not playable by this system, it will be ejected automatically.

Playing a disc

— Normal Play/Shuffle Play

This system lets you play audio CDs and discs with MP3 audio tracks.

Example: When a disc is loaded

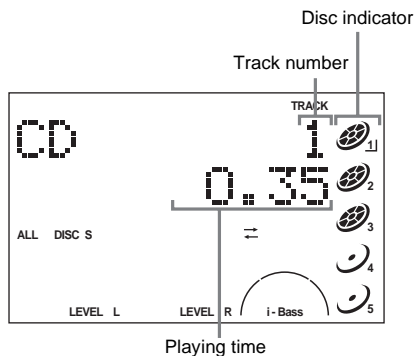

- 1 Press **CD** (or **FUNCTION** repeatedly) to switch the function to **CD**.

2 Press **PLAY MODE** in stop mode repeatedly until the mode you want appears.

| Select | To play |
|-------------------------------------|--|
| ALL DISCS (Normal Play) | All discs in the disc slot continuously. |
| 1DISC (Normal Play) | The tracks on the disc you have selected in original order. |
| ALBM (Normal Play) | All MP3 audio tracks in the album on the disc you have selected in original order. When playing a non-MP3 disc, Album Play becomes 1DISC Play. |
| ALL DISCS SHUF (Shuffle Play) | The tracks on all discs in random order. |
| 1DISC SHUF (Shuffle Play) | The tracks on the disc you have selected in random order. |
| ALBM SHUF (Shuffle Play) | The MP3 audio tracks in the album on the disc you have selected in random order. When playing a non-MP3 disc, Album Shuffle Play becomes 1DISC SHUF Play. |
| PGM (Program Play) | The tracks on the disc in the order you want them to be played (see “Creating your own program” on page 13). |

3 Press **▶** (or CD **▶||** on the unit).

Other operations

| To | Do this |
|---|---|
| Stop play | Press ■ . |
| Pause | Press (or CD ▶ on the unit). Press again to resume play. |
| Select a track | Press ◀◀ or ▶▶ repeatedly. |
| Select an album of MP3 | Press ALBUM - or + repeatedly after step 2. |
| Find a point in a track ¹⁾ | Keep pressing ◀◀ or ▶▶ during playback and release it at the desired point. |
| Select a disc | Press DISC SKIP ²⁾ (or DISC 1 - 5 on the unit). |
| Switch to CD function from another source | Press DISC 1 - 5 on the unit (Automatic Source Selection). |
| Remove a disc | Press DISC 1 - 5 , then press ▲ CD on the unit. |

1) You may not be able to search between multiple files. Also, the time may not be displayed correctly for some files.

2) You cannot select an empty disc stocker.

continued

Notes

- You cannot change the play mode during playback.
- Some time may be needed to start playback of discs recorded in complex configurations such as many layers.
- When the disc is inserted, the player reads all the tracks on that disc. If there are many albums or non-MP3 audio tracks on the disc, it may take a long time for play to begin or for the next MP3 audio track to start play.
- Do not save unnecessary albums or tracks other than MP3 ones in the disc to be used for MP3 listening. We recommend that you do not save other types of tracks or unnecessary albums on a disc that has MP3 audio tracks.
- An album that does not include an MP3 audio track is skipped.
- Maximum album number: 150 (including root folder)
- The maximum number of MP3 audio tracks and albums that can be contained on a single disc is 300.
- Playback is possible up to 8 levels.
- MP3 audio tracks are played back in alphabetical order.
- Depending on the encoding/writing software, recording device, or the recording media used at the time an MP3 audio track is recorded, you may encounter such problems as disabled playback, sound interruptions, and noise.

Tip

When disc access takes a long time, set “CD POWER ON” by CD power manage function (page 15).

Playing repeatedly

— Repeat Play

You can play all the tracks or a single track on a disc repeatedly.

Press REPEAT repeatedly during playback until “REP” or “REP1” appears.

REP: For all the tracks on a disc, or all the MP3 audio tracks in an album up to five times.

REP1: For a single track only.

To cancel Repeat Play

Press REPEAT repeatedly until both “REP” and “REP1” disappear.

Notes

- You cannot select “REP” and “ALL DISCS SHUF” at the same time.
- When you select “REP1”, that track is repeated endlessly until “REP1” is canceled.

Creating your own program

— Program Play

You can make a program of up to 25 steps from all the discs in the order you want to play them. You can synchro record the programmed tracks onto a cassette tape (page 18).

- 1 Press CD (or FUNCTION repeatedly) to switch the function to CD.**
- 2 Press PLAY MODE in stop mode repeatedly until “PGM” appears.**
- 3 Press DISC SKIP (or DISC 1 – 5 on the unit) to select a disc.**
To program all the tracks on a disc at once, proceed to step 5 with “AL” displayed.
- 4 Press ◀◀ or ▶▶ repeatedly until the desired track number appears.**

When programming the MP3 audio tracks, press ALBUM – or + to select album, then press ◀◀ or ▶▶ repeatedly until the desired track number appears.

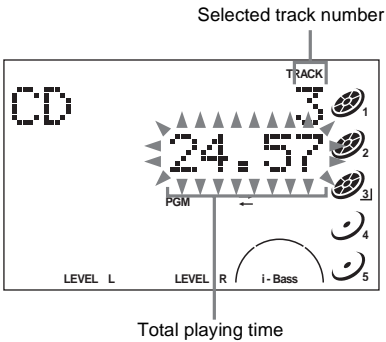

- 5 Press ENTER (or PLAY MODE).**
The track is programmed.
The step number appears, followed by the last programmed track number.

6 Program additional discs or tracks.

| To program | Repeat steps |
|-------------------------------|--------------|
| Other discs | 3 and 5 |
| Other tracks on the same disc | 4 and 5 |
| Other tracks on other discs | 3 to 5 |

7 Press ▶ (or CD ▶|| on the unit).

Program Play starts.

Other operations

| To | Do this |
|----------------------------|---|
| Cancel Program Play | Press PLAY MODE in stop mode repeatedly until “PGM” disappears. |
| Clear a track from the end | Press CLEAR in stop mode. |

Tips

- The program you made remains after Program Play finishes. To play the same program again, press CD (or FUNCTION repeatedly) to switch the function to CD, then press ▶ (or CD ▶|| on the unit). When you eject a disc after programming tracks from multiple discs, only the tracks contained on the ejected disc are deleted from the program.
- “-- --” appears when the total CD program time exceeds 100 minutes, or when you select a CD track whose number is 21 or over, or when you select an MP3 audio track.

Presetting radio stations

You can preset up to 20 FM stations and 10 AM stations. You can then tune in any of those stations simply by selecting the corresponding preset number.

Automatic tuning preset

You can automatically tune in all of the stations that can be received in your area and then store the radio frequency of the desired stations.

- 1** Press **TUNER BAND** (or **FUNCTION** repeatedly) to switch the function to tuner.
- 2** Press **TUNER BAND** repeatedly to select “FM” or “AM”.
- 3** Press **TUNING MODE** repeatedly until “AUTO” appears in the display.
- 4** Press **– or +** (or **TUNING – or +** on the unit).

The frequency changes as the system scans for a station. Scanning stops automatically when a station is tuned in. At that time, “TUNED” and “STEREO” (for stereo program only) appear.

If “TUNED” does not appear and the scanning does not stop

Set the frequency of the desired radio station as described in steps 3 and 4 of “Manual tuning preset” (page 14).

5 Press **TUNER MEMORY**.

The preset number flashes. Perform steps 6 and 7 while the preset number flashes.

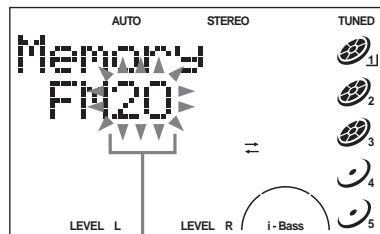

Preset number

- 6** Press **– or +** (or **TUNING – or +** on the unit) repeatedly to select the desired preset number.
- 7** Press **ENTER**.
- 8** Repeat steps 2 through 7 to preset other stations.

Tip

Press **■** to stop scanning.

Manual tuning preset

You can manually tune in and store the radio frequency of the desired stations.

- 1** Press **TUNER BAND** (or **FUNCTION** repeatedly) to switch the function to tuner.
- 2** Press **TUNER BAND** repeatedly to select “FM” or “AM”.
- 3** Press **TUNING MODE** repeatedly until “AUTO” and “PRESET” disappear from the display.
- 4** Press **– or +** (or **TUNING – or +** on the unit) repeatedly to tune in the desired station.
- 5** Press **TUNER MEMORY**.
- 6** Press **– or +** (or **TUNING – or +** on the unit) repeatedly to select the desired preset number.
- 7** Press **ENTER**.
- 8** Repeat steps 2 through 7 to preset other stations.

Other operations

| To | Do this |
|---|---|
| Tune in a station with a weak signal | Follow the procedure described in "Manual tuning preset" (page 14). |
| Set another station to the existing preset number | Start over from step 2. After step 5, press – or + (or TUNING – or + on the unit) repeatedly to select the preset number you want to store the station. |

To improve tuner reception

When tuner reception is poor, set CD player power off by CD power manage function. CD power is factory set to on.

- 1 Press FUNCTION repeatedly to switch the function to CD.
- 2 Press I/⏻ to turn off the system.
- 3 Press I/⏻ while holding ■ on the unit. "CD POWER OFF" appears.

To set CD power on

Repeat the procedure above and "CD POWER ON" appears.

Notes

- When "CD POWER OFF" is selected, disc access time is increased.
- You cannot change the setting in Power Saving Mode.

To change the AM tuning interval (except for European models)

The AM tuning interval is factory-preset to 9 kHz (or 10 kHz for some areas). To change the AM tuning interval, tune in any AM station first, then turn off the system. While holding ►►, press I/⏻ on the unit. When you change the interval, all the AM preset stations are erased.

To reset the interval, repeat the same procedure.

Note

You cannot change the AM tuning interval in Power Saving Mode.

Tips

- The preset stations are retained for about a day even if you disconnect the power cord or if a power failure occurs.
- To improve broadcast reception, adjust the supplied antennas, or connect a commercially available external antenna.

Listening to the radio

You can listen to a radio station either by selecting a preset station, or by manually tuning in the station.

Listening to a preset station

— Preset Tuning

Preset radio stations in the tuner's memory first (see "Presetting radio stations" on page 14).

- 1 Press TUNER BAND (or FUNCTION repeatedly) to switch the function to tuner.
- 2 Press TUNER BAND repeatedly to select "FM" or "AM".
- 3 Press TUNING MODE repeatedly until "PRESET" appears in the display.
- 4 Press – or + (or TUNING – or + on the unit) repeatedly to select the desired preset station.

Listening to non-preset radio station

— Manual Tuning

- 1 Press TUNER BAND (or FUNCTION repeatedly) to switch the function to tuner.
- 2 Press TUNER BAND repeatedly to select "FM" or "AM".
- 3 Press TUNING MODE repeatedly until "AUTO" and "PRESET" disappear from the display.
- 4 Press – or + (or TUNING – or + on the unit) repeatedly to tune in the desired station.

Note

When tuner function is selected as the current function and CD is pressed to select CD during "CD POWER OFF", it may take some time to switch the function (page 15).

continued

Tips

- To improve broadcast reception, adjust the supplied antennas, or connect a commercially available external antenna.
- When an FM stereo program has static noise, press FM MODE repeatedly until "MONO" appears. There will be no stereo effect, but the reception will improve.
- Press TUNING MODE repeatedly until "AUTO" appears in step 3 above, then press – or + (or TUNING – or + on the unit). The frequency indication changes and scanning stops when the system tunes in a station (Automatic Tuning).
- To record the radio programs, use manual recording (pages 19 and 22).

Using the Radio Data System (RDS)

(European model only)

What is the Radio Data System?

Radio Data System (RDS) is a broadcasting service that allows radio stations to send additional information along with the regular program signal. RDS is available only on FM stations.*

Note

RDS may not work properly if the station you are tuned in is not transmitting the RDS signal properly or if the signal is weak.

* Not all FM stations provide RDS service, nor do they provide the same types of services. If you are not familiar with the RDS system, check with your local radio stations for details on RDS services in your area.

Receiving RDS broadcasts

Simply select a station from the FM band.

When you tune in a station that provides RDS services, the station name appears in the display.

To check the RDS information

Each time you press DISPLAY, the display changes cyclically as follows:

Station name¹⁾ → Preset number²⁾ and frequency → Clock display → Bass level → Treble level

¹⁾ If the RDS broadcast is not properly received, the station name may not appear in the display.

²⁾ Preset number is displayed only if you preset radio stations.

Loading a tape

- 1 Press **▲** PUSH on the unit.
- 2 Load a recorded/recordable tape into the cassette holder.

With the side you want to play/record facing towards you.

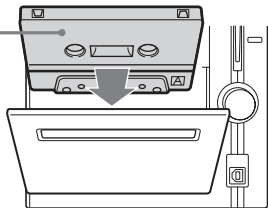

Playing a tape

You can use TYPE I (normal) tape.

- 1 Press **TAPE** (or **FUNCTION** repeatedly) to switch the function to **TAPE**.
- 2 Press **DIRECTION** on the unit repeatedly to select “**↔**” to play one side of a tape, “**↔↔**” to play both sides, or “**↔↔**”* to play both sides repeatedly.
 - * The tape deck stops automatically after repeating the sequence five times.
- 3 Press **▶** (or **TAPE** **◀▶** on the unit).
The tape starts playing. Press the button again to play the reverse side.

Other operations

| To | Do this |
|------------------------|---|
| Stop play | Press ■ . |
| Pause | Press . Press again to resume play. |
| Fast-forward or rewind | Press ◀◀ or ▶▶ . |
| Remove a tape | Press ▲ PUSH on the unit in stop mode. |

Recording your favorite CD tracks on a tape

— CD-TAPE Synchro Recording

You can record a whole CD on a tape.

You can use TYPE I (normal) tape.

Use buttons on the unit for the operation.

1 Load a recordable tape.

2 Load a CD you want to record.

If you have already loaded the disc, press DISC 1 – 5 to select the disc, then press ■.

When you want to record an album from an MP3 disc, be sure to press PLAY MODE repeatedly to select ALBM, then use ALBUM – or + on the remote to select the desired album before proceeding.

3 Press CD SYNC.

“CD SYNCHRO” appears. “REC” flashes. The tape deck stands by for recording and the CD player pauses for play.

4 Press DIRECTION repeatedly until ⇄ appears to record on one side or ⇄ (or ⇄) to record on both sides.

5 Press TAPE ◀▶ repeatedly to select recording side.

If you select both sides recording or front side recording, press TAPE ◀▶ to light up the ▶ indicator. If you record on the reverse side, press TAPE ◀▶ again to light up the ◀ indicator.

6 Press ● REC PAUSE/START.

Recording starts.

When the recording is completed, the CD player and the tape deck stop automatically.

To stop recording

Press ■.

To record a disc by specifying track order

You can record only your favorite CD tracks using Program Play. Between steps 2 and 3, perform steps 1 to 6 of “Creating your own program” (page 13).

Tip

If you select both sides recording and the tape reaches the end of the front side part-way through a track, the entire track is recorded again from the beginning of the reverse side.

Recording on a tape manually

— Manual Recording

You can record just the portions you like from a CD, tape or radio program on a tape.

You can also record from connected components (see “Hooking up optional components” on page 30).

Use buttons on the unit for the operation.

- 1 Load a recordable tape.**
- 2 Press FUNCTION repeatedly to select the desired source to record.**
 - CD: To record from this system’s CD player.
 - FM or AM: To record from this system’s tuner.
 - AUX: To record from the optional component connected to the AUX IN jacks.
 - PC: To record from the personal computer connected to the USB port.
- 3 Press ● REC PAUSE/START.**

“REC” flashes and the tape deck stands by for recording.
- 4 Press DIRECTION repeatedly until ⇄ appears to record on one side or ⇄ (or ⇄) to record on both sides.**
- 5 Press TAPE ◀▶ repeatedly to select recording side.**

If you select both sides recording or front side recording, press TAPE ◀▶ to light up the ▶ indicator. If you record on the reverse side, press TAPE ◀▶ again to light up the ◀ indicator.
- 6 Press ● REC PAUSE/START, then start playing the desired source to record.**

Recording starts.

To stop recording

Press ■.

Notes

- You cannot listen to other sources while recording.
- If you press CD, TUNER BAND, TAPE or FUNCTION during recording and select a sound source different from the sound source being recorded, the recording stops.

Tips

- When you record on both sides, be sure to start from the front side. If you start from the reverse side, recording stops at the end of the reverse side.
- For recording from the tuner:
 - If noise is heard while recording from the tuner, move the respective antenna to reduce the noise.

Adjusting the sound

Adjusting the bass and treble

You can adjust the bass and treble to enjoy more powerful sound.

1 Press EQ repeatedly to select “BASS” or “TREBLE”.

Each time you press the button, the display changes as follows:

BASS ↔ TREBLE

2 Press – or + repeatedly to adjust the level while “BASS” or “TREBLE” appears.

To adjust the bass on the unit

Turn BASS control.

To adjust the treble on the unit

Turn TREBLE control.

To exit the bass and treble settings

Press any button other than EQ or +/-.

Also, if you do not perform any operations for a few seconds, the display automatically returns to the original display.

Adjusting the i-Bass

You can reinforce the bass and create a more powerful sound.

Press i-Bass on the unit.

Each time you press the button, the display changes cyclically as follows:

i-Bass 1* → i-Bass 2* → i-Bass OFF

* The i-Bass indicator changes.

Falling asleep to music

— Sleep Timer

You can set the system to turn off after a certain time, so that you can fall asleep to music.

Press SLEEP.

Each time you press the button, the minute display (the turn-off time) changes cyclically as follows:

AUTO* → 90min → 80min → ... → 10min → OFF

* The system automatically turns off in 100 minutes or after the current CD or tape finishes playing.

Other operations

| To | Press |
|---------------------------------|---|
| Check the remaining time* | SLEEP once. |
| Change the time to turn off | SLEEP repeatedly to select the time you want. |
| Cancel the Sleep Timer Function | SLEEP repeatedly until “OFF” appears. |

* You cannot check the remaining time if you select “AUTO”.

Tip

You can use the Sleep Timer, even if you have not set the clock.

Waking up to music

— Play Timer

You can wake up to music at a preset time. Make sure you have set the clock (see “Setting the clock” on page 9).

Use buttons on the remote for the operation.

1 Prepare the sound source you want to play.

- CD: Load a disc. To start from a specific track, make a program (see “Creating your own program” on page 13).
- TAPE: Load a tape (see “Playing a tape” on page 17).
- FM or AM: Tune in the preset radio station (see “Listening to the radio” on page 15).

2 Press VOLUME +/- to adjust the volume.

3 Press CLOCK/TIMER SET.

4 Press ◀◀ or ▶▶ repeatedly until “PLAY SET?” appears, then press ENTER.

“ON TIME” appears and the hour indication flashes.

5 Set the time to start playing.

Press ◀◀ or ▶▶ repeatedly to set the hour, then press ENTER.

The minute indication flashes.

Press ◀◀ or ▶▶ repeatedly to set the minute, then press ENTER.

6 Set the time to stop playing following the same procedure as step 5.

7 Press ◀◀ or ▶▶ repeatedly until the desired sound source appears.

Each time you press the button, the display changes cyclically as follows:



8 Press ENTER.

“PLAY TIMER”, the start time, the stop time and the sound source appear in turn, then the original display returns.

9 Press I/⏻ to turn off the system.

Other operations

| To | Do this |
|--|--|
| Activate the timer/ check the setting | <ol style="list-style-type: none">1 Press CLOCK/TIMER SELECT.2 Press ◀◀ or ▶▶ repeatedly until “SELECT PLAY SEL?” appears, then press ENTER. |
| Change the setting | Start over from step 1. |
| Cancel the timer | <ol style="list-style-type: none">1 Press CLOCK/TIMER SELECT.2 Press ◀◀ or ▶▶ repeatedly until “SELECT TIMER OFF?” appears, then press ENTER. |

Notes

- You cannot activate the Play Timer and Rec Timer at the same time.
- If you use the Play Timer and the Sleep Timer at the same time, the Sleep Timer has priority.
- Do not operate the system from the time the system turns on until the play starts (about 15 seconds before the preset time).
- If the system is on about 15 seconds before the preset time, the Play Timer will not be activated.
- You cannot use the optional component connected to AUX IN jacks or USB port as the sound source for Play Timer.

Timer recording radio programs

— Rec Timer

You can record a preset radio station from a specified time.

To timer record, you must first preset the radio station (see “Presetting radio stations” on page 14) and set the clock (see “Setting the clock” on page 9).

Use buttons on the remote for the operation.

- 1 Tune in the preset radio station (see “Listening to a preset station” on page 15).**
- 2 Press CLOCK/TIMER SET.**
- 3 Press or repeatedly until “REC SET?” appears, then press ENTER.**
“ON TIME” appears and the hour indication flashes.
- 4 Set the time to start recording.**
Press or repeatedly to set the hour, then press ENTER.
The minute indication flashes.
Press or repeatedly to set the minute, then press ENTER.
- 5 Set the time to stop recording following the same procedure as step 4.**
Rec Timer settings and the desired station appear, then the original display returns.
- 6 Load a recordable tape.**
- 7 Press TAPE on the unit repeatedly to select recording side.**
If you select both sides recording or front side recording, press TAPE on the unit to light up the indicator. If you record on the reverse side, press TAPE on the unit again to light up the indicator.
- 8 Press .**
- 9 Press DIRECTION on the unit repeatedly until appears to record on one side or (or) to record on both sides.**

10 Press to turn off the system.

Other operations

| To | Do this |
|--|---|
| Activate the timer/ check the setting | <ol style="list-style-type: none"> 1 Press CLOCK/TIMER SELECT. 2 Press or repeatedly until “SELECT REC SEL?” appears, then press ENTER. |
| Change the setting | Start over from step 1. |
| Cancel the timer | <ol style="list-style-type: none"> 1 Press CLOCK/TIMER SELECT. 2 Press or repeatedly until “SELECT TIMER OFF?” appears, then press ENTER. |

Notes

- You cannot activate the Play Timer and Rec Timer at the same time.
- If you use the Rec Timer and the Sleep Timer at the same time, the Sleep Timer has priority.
- Do not operate the system from the time the system turns on until the recording starts (about 15 seconds before the preset time).
- If the system is on about 15 seconds before the preset time, the Rec Timer will not be activated.
- The volume is reduced to minimum during recording.
- Note that if the Rec Timer is set at the same time as the Play Timer sound source is set to tape, the Rec Timer sound may be recorded onto the tape.

Display

Turning off the display

— Power Saving Mode

The clock display can be turned off to minimize the amount of power consumed during standby (Power Saving Mode).

Press DISPLAY repeatedly while the system is off until the clock display disappears.

To cancel Power Saving Mode

Press DISPLAY while the system is off. Each time you press the button, the display switches cyclically as follows:

Clock display* → No display (Power Saving Mode)

* The clock is displayed only if you set the clock.

Note

You cannot perform the following operations in Power Saving Mode.

- setting the clock
- changing the AM tuning interval (except for European models)
- changing the CD power manage function

Tips

- I/⏻ indicator lights up even in Power Saving Mode.
- The timer continues to operate in Power Saving Mode.

Viewing information about the disc in the display

You can check the playing time and remaining time of the current track or that of the disc.

Checking the remaining time and titles (CD/MP3)

Press DISPLAY during Normal Play.

Each time you press the button, the display changes cyclically as follows:

Current track number and elapsed playing time
→ Current track number and remaining time¹⁾
→ Remaining time of the disc²⁾ → Track title (disc with MP3 audio tracks³⁾ only) → Album title (disc with MP3 audio tracks only) → Clock display (for eight seconds) → BASS level (for four seconds) → TREBLE level (for four seconds)

1) “—.—” appears when playing back MP3 audio tracks.

2) “—.—” appears in ALL DISCS, SHUF or program play mode or when playing back MP3 audio tracks.

3) When you play back a track with an ID3 tag ver.1 or ver.2, the ID3 tag appears. The ID3 tag displays only the track title information.

Checking the total playing time and titles (CD/MP3)

Press DISPLAY in stop mode.

Each time you press the button, the display changes cyclically as follows:

■ When a CD/MP3 is in Normal Play mode

TOC display¹⁾ or total album number of the disc²⁾ or total track number of the current album³⁾ → Volume label⁴⁾ or album name⁴⁾ → Clock display (for eight seconds) → BASS level (for four seconds) → TREBLE level (for four seconds)

- ¹⁾ TOC = Table of Contents; displays total number of tracks on the disc, and total playing time of the disc
- ²⁾ For discs with MP3 audio tracks in Normal play or SHUF mode
- ³⁾ For discs with MP3 audio tracks in ALBM or ALBM SHUF mode
- ⁴⁾ For discs with MP3 audio tracks, album titles or volume label may not be displayed depending on the play mode

■ When a CD/MP3 is in Program Play mode

The last track number of the program and the total playing time → Total track number of the program (for eight seconds) → Volume label* → Clock display (for eight seconds) → BASS level (for four seconds) → TREBLE level (for four seconds)

* For discs with MP3 audio tracks

Checking the station name (TUNER)

Press DISPLAY while listening to the radio.

Each time you press the button, the display changes cyclically as follows:

Station name¹⁾ → Preset number²⁾ and frequency → Clock display (for eight seconds) → BASS level (for four seconds) → TREBLE level (for four seconds)

¹⁾ European model only

²⁾ Preset number is displayed only if you preset radio stations (page 14)

Notes

- The total playing time is not displayed for a disc with MP3 audio tracks.
- ID3 tag applies to version 1 and version 2.
- If the MP3 audio track you play back has an ID3 tag, the ID3 tag information is displayed as a track title.
- In the following cases, elapsed playing time and remaining time of the track may not be displayed accurately.
 - when an MP3 audio track of VBR (variable bit rate) is played.
 - when fast forward or fast reverse is performed.

Optional Personal Computer

Connecting a personal computer to the system

Use the supplied USB cable for the connection. You can listen to the audio recorded in the computer's hard disk or on a CD-ROM loaded on the CD-ROM drive through the system's speakers.

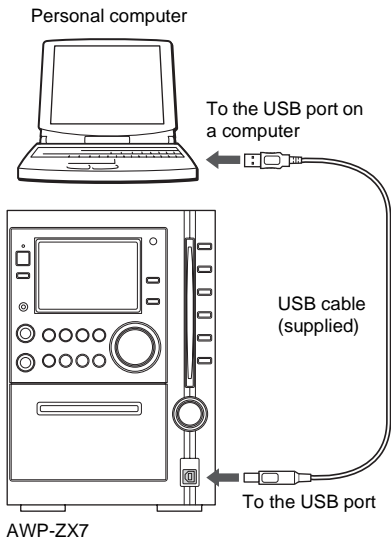

Operation is not assured in the following environments

- Personally constructed PCs or operating systems
- Windows XP versions other than Home Edition or Professional
- Windows 98 versions other than Second Edition
- Windows NT
- Windows 95
- Mac OS versions other than 9.0.4, 9.2 or X 10.0 to 10.3
- An environment upgraded to the other operating systems
- Multi-boot environment
- Multi-monitor environment

Notes

- Operations are not guaranteed for all the recommended computer environments mentioned above.
- You cannot perform system operations from the computer side, or computer operations from the system side.
- Operations are not guaranteed when the computer and the system are connected through a USB hub or a USB extension cable.
- When the computer has multiple USB ports, connect the USB cable to the port that supports a route hub. (See the operation manual supplied with the computer for the port that supports a route hub.)

Required system equipment

The following environments are necessary for the computer to connect to the system.

- USB port that supports USB 1.1 or higher
- IBM PC/AT compatible or Macintosh
- Operating System installed at the factory:
 - For Windows users
Windows 98 Second Edition, Windows 2000 Professional, Windows Millennium Edition, Windows XP Professional/Home Edition
 - CPU: MMX Pentium 266 MHz or higher
 - For Macintosh users
Mac OS 9.0.4, 9.2 or X 10.0 to 10.3

Installing the driver

When first connecting the computer to the system's USB port, you must install the driver. The driver is supplied as standard with the OS. The installation procedure differs according to the OS type. Follow the procedures described below. (Also see the operation manual supplied with the computer.)

For Windows 98 Second Edition/Windows Millennium Edition

To install the USB driver

- 1 Start up the computer.
- 2 Press I/⏻ to turn on the system.
- 3 Press FUNCTION repeatedly to switch the function to PC.
- 4 Connect the system to the computer with the USB cable (see page 25).
The computer automatically detects the system and begins the device (OS standard driver) installation.

- 5 Follow the instructions appearing on the monitor.



The illustrations above show examples of Windows Millennium Edition screens.

Notes

- The OS CD-ROM may be required depending on your computer. In this case, follow the instructions and set the CD-ROM in the drive.
- Do not disconnect or connect the USB cable during detection.

To verify the status of the installed devices

Be sure to check the status of the installed devices after you have installed their drivers.

- 1 Open the [Control Panel].
In the Start menu, point to [Settings] and click [Control Panel].
- 2 Double-click the [System] icon.
The “System Properties” dialog box appears.

Note
(For Windows Me) If you cannot find the [System] icon, click “View all Control Panel options”.
- 3 Click the [Device Manager] tab.
Make sure that “View devices by type” is selected.
- 4 Make sure that the following items are listed in the “Device Manager” dialog box.
 - “USB Audio Device” under “Sound, video and game controllers”
 - “USB Compatible Device” under “Universal Serial Bus controllers”

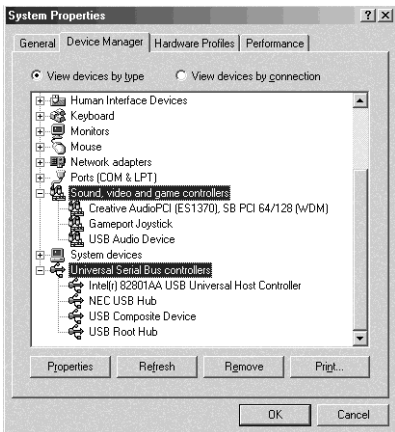

The illustration above shows an example of Windows Millennium Edition screen.

Note

If you do not see these items or if a “!” is displayed on top of any of the icons, it means the respective device driver is not installed or recognized by the OS. In this case, install the device driver again.

- 5 Click [OK] to close the “System Properties” dialog box.

Notes

- Other items in the “Device Manager” list may differ depending on your computer environment.
- If the devices are not recognized, disconnect and reconnect the USB cable, and try to automatically install the drive drivers again. If the devices still are not recognized, reboot the computer.

For Windows 2000 Professional or Windows XP Professional/Home Edition

To install the USB driver

- 1 Start up the computer.
- 2 Press I/⏻ to turn on the system.
- 3 Press FUNCTION repeatedly to switch the function to PC.
- 4 Connect the system to the computer with the USB cable (see page 25).
The computer automatically detects the system and begins the device (OS standard driver) installation. Installation finishes automatically.

Notes

- The OS CD-ROM may be required depending on your computer. In this case, follow the instructions and set the CD-ROM in the drive.
- Do not disconnect or connect the USB cable during detection.

Tip

To not install the driver, follow the instructions appearing on the monitor.

To verify the status of the installed devices

Be sure to check the status of the installed devices after you have installed their drivers.

- 1 Open the [Control Panel].
In the Start menu, point to [Settings] and click [Control Panel].
(For Windows XP) In the Start menu, click [Control Panel], and then click [Switch to Classic View] on the left panel of the window.
- 2 Double-click the [System] icon.
The “System Properties” dialog box appears.
- 3 Click the [Hardware] tab.

continued

- 4 Click the [Device Manager] button.
Make sure that “devices by type” is selected in the “View” menu.
- 5 Make sure that the following items are listed in the “Device Manager” dialog box.
 - “USB Audio Device” under “Sound, video and game controllers”
 - “USB Composite Device” under “Universal Serial Bus controllers”

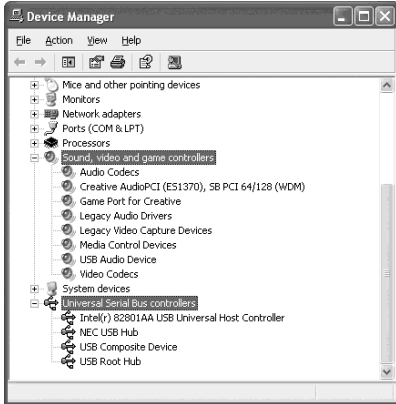

The illustration above shows an example of Windows XP Professional screen.

Notes

- Other items in the “Device Manager” list may differ depending on your computer environment.
- If the devices are not recognized, disconnect and reconnect the USB cable, and try to automatically install the drive drivers again. If the devices still are not recognized, reboot the computer.

For Mac OS 9.0.4, 9.2 or X 10.0

To install the USB driver

- 1 Start up the computer.
- 2 Press I/⏻ to turn on the system.
- 3 Press FUNCTION repeatedly to switch the function to PC.
- 4 Connect the system to the computer with the USB cable (see page 25).

For Mac OS X 10.1 to 10.3

To install the USB driver

- 1 Start up the computer.
- 2 Press I/⏻ to turn on the system.
- 3 Press FUNCTION repeatedly to switch the function to PC.
- 4 Connect the system to the computer with the USB cable (see page 25).
- 5 Select [System Preferences...] in the Apple menu.
- 6 Click the [Sound] icon in the [Hardware] menu.
- 7 Click the [Output] tab, then click to select [USB Audio DAC] in the [Choose a device for sound output] window.

Listening to audio files on a personal computer

- 1 Start up the computer.**
Wait for the OS to start up properly.
- 2 Press I/⏻ to turn on the system.**
- 3 Press FUNCTION repeatedly to switch the function to PC.**
- 4 Perform the operations on the computer side to start playback.**
- 5 Press VOLUME +/- (or turn VOLUME control on the unit) to adjust the volume.**

Notes

- When playing back music through the USB port, do not turn off the system or change the sound source. This may cause the computer to malfunction.
- Before turning off the system or the computer or disconnecting the USB cable, be sure to first quit the software being used to play back music on the computer.
- When turning off the power, turning off the system first and then turning off the computer is recommended.
- After turning off the power, disconnect the USB cable.
- When setting the computer to hibernation mode or sleep mode, turning off the system first is recommended.
- The sound may skip or there may be noise depending on the computer environment.
- Also see the operation manuals supplied with the computer and the music playback software.
- If the computer experiences a malfunction, reboot the computer.

Optional Components

Hooking up optional components

To enhance your system, you can connect optional components. Refer to the operating instructions provided with each component.

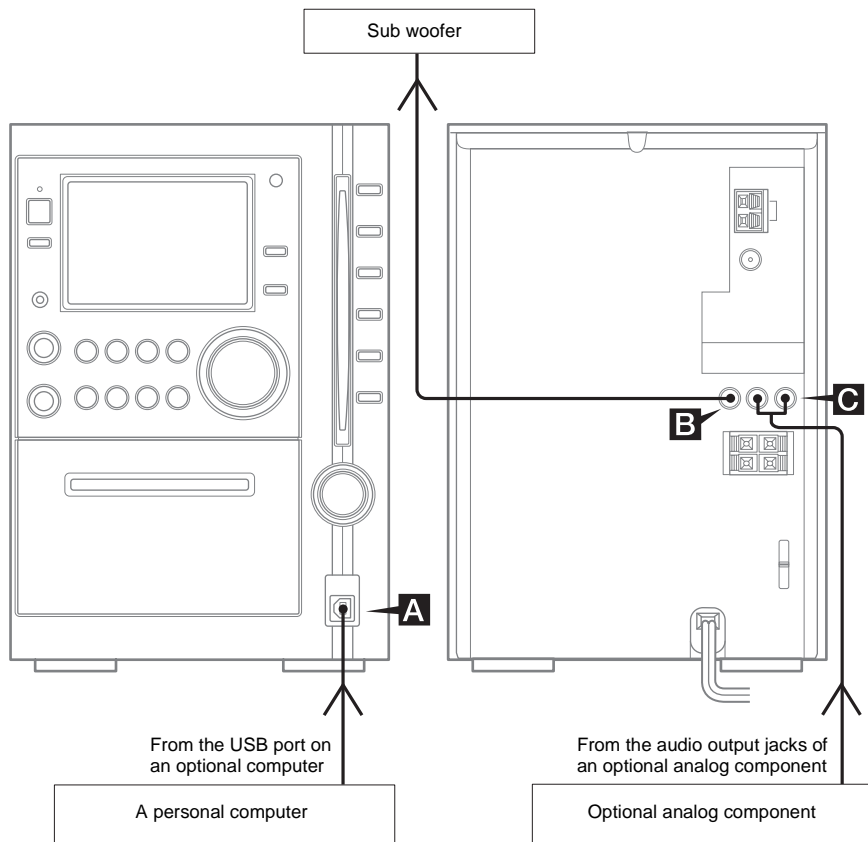

A USB port

Use the supplied USB cable to connect a personal computer (see “Optional Personal Computer” on page 25).

B SUB WOOFER OUT jack

Use an audio cord (not supplied) to connect an optional sub woofer to this jack. You can then output audio to the component from this system.

Note

The effects may be limited or noise may occur depending on the connected sub woofer or the type of music being played. For details, consult your nearest Aiwa dealer.

To place the sub woofer

To obtain a better bass reproduction, we recommend you to place the subwoofer on a solid floor where resonance is unlikely to occur.

Notes

- Always place the subwoofer vertically, keeping it a few centimeters away from the wall.
- If the sub woofer is placed in the center of a room, the bass could be extremely weakened. This is due to the influence of the standing wave of the room. If this happens, move the subwoofer away from the center of the room or eliminate the cause of the standing wave, by placing a bookshelf against the wall, etc.

C AUX IN jacks

Use audio cords (not supplied) to connect an optional analog component (MD deck or VCR, etc.) to these jacks. You can then listen to the sound from the component.

Listening to audio from a connected component

1 Connect audio cords.

See “Hooking up optional components” on page 30.

2 Press **FUNCTION** repeatedly until “**AUX**” appears.

Start playing the connected component.

Problems and remedies

Should you encounter a problem with your system, do the following:

- 1 Make sure the power cord and speaker cords are correctly and firmly connected.
- 2 Find your problem in the troubleshooting checklist below and take the indicated corrective action.

If the problem persists after doing all of the above, consult your nearest Aiwa dealer.

When the I/⏻ indicator flashes

Immediately unplug the power cord and check the following items.

- If your system has a voltage selector, is the voltage selector set to the correct voltage? Check the voltage for your region, then make sure the voltage selector is set correctly.
- Are the + and – speaker cords short-circuited?
- Are you using the supplied speakers?
- Is anything blocking the ventilation holes on the rear of the system?

Check all the above items and fix any problems found. After I/⏻ indicator stops flashing, reconnect the power cord and turn on the system. If the indicator still flashes, or if the cause of the problem cannot be found even after checking all the above items, consult your nearest Aiwa dealer.

General

“- -: -” appears in the display.

- A power interruption has occurred. Set the clock (page 9) and timer settings (pages 21 and 22) again.

The clock setting/radio presetting/timer is canceled.

- Redo the following:
 - “Setting the clock” (page 9)
 - “Presetting radio stations” (page 14)
 - “Falling asleep to music” and “Waking up to music” (pages 20 and 21)
 - “Timer recording radio programs” (page 22)

There is no sound.

- Press VOLUME + (or turn VOLUME control on the unit clockwise).
- Make sure the headphones are not connected.
- Check the speaker connections (page 7).
- There is no audio output during Rec Timer.
- The system is in pause mode. Press ► (or CD ►|| on the unit) to return to normal play mode.

There is severe hum or noise.

- Move the system away from the source of noise.
- Connect the system to a different wall outlet.
- Install a noise filter (commercially available) to the power cord.

The timer cannot be set.

- Set the clock again (page 9).

The timer does not function.

- Press CLOCK/TIMER SELECT to set the timer and light up “⏻PLAY” or “⏻REC” in the display (pages 21 and 22).
- Check the timer setting and set the correct time (pages 21 and 22).
- Cancel the Sleep Timer Function (page 20).
- Make sure the clock is correctly set.

The remote does not function.

- Remove the obstacle.
- Move the remote closer to the system.
- Point the remote at the system’s sensor.
- Replace the batteries (R6/size AA).
- Locate the system away from the fluorescent light.

The color irregularity on a TV screen persists.

- Turn off the TV set once, then turn it on after 15 to 30 minutes. If the color irregularity still persists, place the speakers farther away from the TV set.

Speakers

Sound comes from only one channel, or the left and right volumes are unbalanced.

- Check the speaker connections and placement.
-

CD/MP3 player

“LOCKED” appears.

- Contact your Aiwa dealer or local authorized Aiwa service facility.
-

The disc does not eject.

- You cannot eject the disc during CD Synchro Recording. Press **■** to cancel the CD Synchro Recording, then press **▲ CD** on the unit to eject the disc.
 - Consult your nearest Aiwa dealer.
-

Play does not start.

- Check whether a disc is loaded (The disc indicator lights up when a disc is loaded.).
 - Wipe the disc clean (page 36).
 - Replace the disc.
 - Insert the disc that this system can play.
 - Insert the disc correctly.
 - Insert the disc in the slot with the label side facing right.
 - Remove the disc and wipe away the moisture on the disc, then leave the system turned on for a few hours until the moisture evaporates.
 - Press **▶▶** (or **CD ▶▶ II** on the unit) to start play.
-

Disc access takes a long time.

- Set “CD POWER ON” by CD power manage function (page 15).
-

The sound skips.

- Wipe the disc clean (page 36).
 - Replace the disc.
 - Try moving the system to a place without vibration (e.g., on top of a stable stand).
 - Try moving the speakers away from the system, or placing them on separate stands. When you listen to a track with bass sounds at high volume, the speaker vibration may cause the sound to skip.
-

Play does not start from the first track.

- Press **PLAY MODE** repeatedly until both “PGM” and “SHUF” disappear to return to Normal Play.
-

MP3 audio track cannot be played back.

- Recording was not performed according to the ISO9660 level 1, level 2 format, Joliet or Romeo in the expansion format.
 - The MP3 audio track does not have the extension “.MP3”.
 - The file is not stored in MP3 format.
 - Discs containing files other than MPEG 1 Audio Layer-3 files cannot be played.
-

MP3 audio tracks take longer to begin play back than others.

- After the system reads all tracks on the discs, playback may take more time than usual if:
 - the number of albums or tracks on the disc is very large.
 - the album and track organization structure is very complex.
-

The album title, track title and ID3 tag do not appear correctly.

- Use a disc that conforms with ISO9660 level 1, level 2, Joliet or Romeo in the expansion format.
 - The disc ID3 tag is not ver. 1 or ver. 2.
 - Only up to 30 characters of ID3 tags are displayed.
 - The characters that can be displayed by this unit are as follows:
 - Upper cases (A to Z)
 - Numbers (0 to 9)
 - Symbols (< > * + , - / [] \ _)Other characters may not be displayed correctly.
-

Tuner

Severe hum or noise/stations cannot be received.

- Set the proper band and frequency (page 14).
 - Connect the antenna properly (page 8).
 - Find a place and an orientation that provide good reception, then set up the antenna again. If you cannot obtain good reception, we recommend you connect a commercially available external antenna.
 - The supplied FM lead antenna receives signals along its entire length, so make sure you extend it fully.
 - Keep the antennas away from the system and other components.
 - Consult your nearest Aiwa dealer if the supplied AM antenna has come off the plastic stand.
 - Try turning off surrounding electrical equipment.
 - Set “CD POWER OFF” by CD power manage function (page 15).
-

A stereo FM program cannot be received in stereo.

- Press FM MODE on the unit until “STEREO” appears in the display.

Noise is heard while loading/removing a disc.

- Change the location of the AM antenna.
-

Tape deck

The tape does not record or play, or there is a decrease in sound level.

- The heads are dirty. Clean them (page 37).
 - The record/playback heads are magnetized. Demagnetize them (page 37).
-

The tape does not erase completely.

- The record/playback heads are magnetized. Demagnetize them (page 37).
-

There is excessive wow or flutter, or the sound drops out.

- The capstans in the tape deck are dirty. Clean them using a cleaning cassette.
-

Noise increases or the high frequencies are erased.

- The record/playback heads are magnetized. Demagnetize them (page 37).
-

The tape does not record.

- No cassette is loaded. Load a cassette.
 - The tab has been removed from the cassette. Cover the broken tab with adhesive tape (page 37).
 - The tape has wound to the end.
-

Optional components

There is no sound.

- Refer to General item “There is no sound.” (page 32) and check the condition of the system.
 - Connect the component properly (page 30) while checking:
 - if the cords are connected properly.
 - if the cord plugs are firmly inserted all the way.
 - Turn on the connected component.
 - Refer to the operating instructions supplied with the connected component and start playing.
 - Press FUNCTION repeatedly to select “AUX” (page 31) or “PC” (page 29).
-

The sound is distorted.

- Set the volume of the connected component lower.
-

If the system still does not operate properly after performing the above measures, reset the system as follows:

Use buttons on the unit for the operation.

- 1 Disconnect the power cord.
- 2 Reconnect the power cord.
- 3 Press I/⏻ to turn on the system.
- 4 Press i-Bass and I/⏻ at the same time and hold more than two seconds.

The system is reset to the factory settings. You should set the settings you made, such as the preset stations, clock, and timer.

Messages

One of the following messages may appear or flash in the display during operation.

CD/MP3

No Disc

There is no disc in the player.

Reading

The system is reading TOC information of the disc.
Some buttons are not available.

NO STEP

All of the programmed tracks have been erased.

OVER

You have reached the end of the disc while pressing
▶▶ during playback or pause.

Push STOP!

You pressed PLAY MODE during playback.

Step Full!

You tried to program 25 or more tracks (steps).

TUNER

Complete!

The preset operation ended normally.

TAPE

No Tab

You cannot record the tape because the tab has been removed from the cassette.

No Tape

There is no tape in the tape deck.

Timer

TIME NG!

The Play Timer or Rec Timer start and end times are set to the same time.

SET CLOCK!

The clock has not been set, therefore the timer setting is unavailable. Set the clock to the correct time, then set the timer.

SET TIMER!

You cannot select the timer function when the Play Timer or Rec Timer are not set.

Precautions

On operating voltage

Before operating the system, check that the operating voltage of your system is identical with the voltage of your local power supply.

On safety

- The unit is not disconnected from the AC power source (mains) as long as it is connected to the wall outlet, even if the unit itself has been turned off.
- Unplug the system from the wall outlet (mains) if it is not to be used for an extended period of time. To disconnect the power cord (mains lead), pull it out by the plug. Never pull the cord itself.
- Should any solid object or liquid fall into the system, unplug the system and have it checked by qualified personnel before operating it any further.
- AC power cord must be changed only at the qualified service shop.

On placement

- Do not place the system in an inclined position.
- Do not place the system in locations where it is:
 - Extremely hot or cold
 - Dusty or dirty
 - Very humid
 - Subject to vibrations
 - Subject to direct sunlight.
- Use caution when placing the unit or speakers on surfaces that have been specially treated (with wax, oil, polish, etc.) as staining or discoloration of the surface may result.

On heat buildup

- Although the system heats up during operation, this is not a malfunction.
- Place the system in a location with adequate ventilation to prevent heat build-up in the system.
- If you continuously use this system at a high volume, the cabinet temperature of the top, side and bottom rises considerably. To avoid burning yourself, do not touch the cabinet.
- To prevent a malfunction, do not cover the ventilation hole.

In case color irregularity is observed on nearby a TV screen

With the magnetically shielded type of speaker system, the speakers can be installed near a TV set. However, color irregularity may still be observed on the TV screen depending on the type of your TV set.

On operation

- If the system is brought directly from a cold to a warm location, or is placed in a very damp room, moisture may condense on the lens inside the CD player. Should this occur, the system will not operate properly. Remove the disc and leave the system turned on for about an hour until the moisture evaporates.
- When you move the system, take out any disc.

If you have any questions or problems concerning your system, please consult your nearest Aiwa dealer.

Notes on discs

- Before playing, clean the disc with a cleaning cloth. Wipe the disc from the center out.
- Do not use solvents such as benzine, thinner, commercially available cleaners or anti-static spray intended for vinyl LPs.
- Do not expose the disc to direct sunlight or heat sources such as hot air ducts, nor leave it in a car parked in direct sunlight.
- Do not use discs encircled with a protection ring. This may cause a malfunction to the system.
- When using discs that have glue or similar tacky substance on the label side of the disc or that used a special ink when the label was printed, there is a chance that the disc or label may become attached to parts inside this unit. When this occurs, it may not be possible to remove the disc, and may also cause this unit to malfunction. Be sure to check that the label side of the disc is not sticky before using.
The following types of disc should not be used:
 - Rental or used discs with attached seals where the glue extends beyond the seal. The perimeter of the seal on the disc is tacky.
 - Discs that have labels printed using a special ink that feels tacky when touched.
- Discs with non-standard shapes (e.g., heart, square, star) cannot be played on this unit. Attempting to do so may damage the unit. Do not use such discs.

Cleaning the cabinet

Clean the cabinet, panel and controls with a soft cloth slightly moistened with mild detergent solution. Do not use any type of abrasive pad, scouring powder or solvent such as thinner, benzene or alcohol.

To save a tape permanently

To prevent a tape from being accidentally recorded over, break off the cassette tab from side A or B as illustrated.

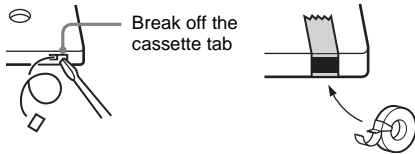

If you later want to reuse the tape for recording, cover the broken tab with adhesive tape.

Before placing a cassette in the tape deck

Take up any slack in the tape. Otherwise, the tape may get entangled in the parts of the tape deck and become damaged.

When using a tape longer than 90 minutes

The tape is very elastic. Do not change the tape operations such as play, stop, and fast-winding frequently. The tape may get entangled in the tape deck.

Cleaning the tape heads

Clean the tape heads after every 10 hours of use.

Be sure to clean the tape heads before you start an important recording or after playing an old tape.

Use a separately sold dry-type or wet-type cleaning cassette. For details, refer to the instructions of the cleaning cassette.

Demagnetizing the tape heads

Demagnetize the tape heads and the metal parts that have contact with the tape after every 20 to 30 hours of use with a separately sold demagnetizing cassette. For details, refer to the instructions of the demagnetizing cassette.

Specifications

Main Unit (CX-LZX7)

Amplifier section

For the U.S. model

AUDIO POWER SPECIFICATIONS

POWER OUTPUT AND TOTAL HARMONIC DISTORTION:

With 6-ohm loads, both channels driven, from 120 – 10,000 Hz: rated 60 watts per channel minimum RMS power, with no more than 10% total harmonic distortion from 250 milliwatts to rated output.

North American model:

Continuous RMS power output (reference):

60 + 60 W

(6 ohms at 1 kHz, 10% THD)

Total harmonic distortion less than 0.05% (6 ohms at 1 kHz, 30 W)

European model:

DIN power output (rated): 45 + 45 W

(6 ohms at 1 kHz, DIN)

Continuous RMS power output (reference):

60 + 60 W

(6 ohms at 1 kHz, 10% THD)

Music power output (reference):

100 + 100 W

(6 ohms at 1 kHz, 10% THD)

Other models:

The following measured at 220 – 240 V AC, 50/60 Hz

DIN power output (rated): 45 + 45 W

(6 ohms at 1 kHz, DIN)

Continuous RMS power output (reference):

60 + 60 W

(6 ohms at 1 kHz, 10% THD)

Inputs

AUX IN (RCA pin jacks): Sensitivity 1 V, impedance 47 kilohms

Outputs

PHONES (stereo mini jack):

accepts headphones with an impedance of 32 ohms or more

SPEAKER: accepts impedance of 6 ohms
SUB WOOFER OUT: voltage 1.5 V

CD player section

System Compact disc and digital audio system
Laser Semiconductor laser ($\lambda=770 - 810$ nm)
Emission duration: continuous
Frequency response 20 Hz – 20 kHz
Signal-to-noise ratio More than 90 dB
Dynamic range More than 90 dB

Tape deck section

Recording system 4-track 2-channel stereo
Frequency response 100 – 10,000 Hz, using Sony TYPE I cassettes
Wow and flutter $\pm 0.15\%$ W. Peak (IEC)
 0.1% W. RMS (NAB)
 $\pm 0.2\%$ W. Peak (DIN)

Tuner section

FM stereo, FM/AM superheterodyne tuner

FM tuner section

Tuning range
North American model: 87.5 – 108.0 MHz (100-kHz step)
Other models: 87.5 – 108.0 MHz (50-kHz step)

Antenna FM lead antenna
Antenna terminals 75 ohms unbalanced
Intermediate frequency 10.7 MHz

AM tuner section

Tuning range
Pan-American model: 530 – 1,710 kHz (with the tuning interval set at 10 kHz)
 531 – 1,710 kHz

(with the tuning interval set at 9 kHz)

European model: 531 – 1,602 kHz (with the tuning interval set at 9 kHz)

Other models: 530 – 1,710 kHz (with the tuning interval set at 10 kHz)
 531 – 1,602 kHz (with the tuning interval set at 9 kHz)

Antenna AM loop antenna, external antenna terminal
Intermediate frequency 450 kHz

Speaker (SSX-LZX7)

Speaker system 2-way, bass-reflex type
Speaker units
Woofers: 12 cm dia., cone type
Tweeters: 5 cm dia., cone type
Nominal impedance 6 ohms

General

Power requirements
North American model: 120 V AC, 60 Hz
European model: 230 V AC, 50/60 Hz
Korean model: 220 V AC, 60 Hz
Other models: 120 V, 220 V or 230 – 240 V AC, 50/60 Hz
 Adjustable with voltage selector

Power consumption
North American model: 60 W
European model: 60 W
 0.3 W (in Power Saving mode)

Other models: 70 W
Dimensions (w/h/d) incl. projecting parts and controls

Amplifier/Tuner/Tape/CD section: Approx. $190 \times 277 \times 361.4$ mm
Speakers: Approx. $170 \times 277 \times 188$ mm

Mass
Amplifier/Tuner/Tape/CD section: Approx. 6.2 kg
Speakers: Approx. 2.7 kg net per speaker
Supplied accessories Remote commander (1)
 R6 (size AA) batteries (2)
 AM loop antenna (1)
 FM lead antenna (1)
 Speaker pads (8)
 Speaker cables (2)
 USB cable (1)

Design and specifications are subject to change without notice.

Remote control

ALPHABETICAL ORDER

A - E

ALBUM + **11** (11, 13, 18)
 ALBUM - **13** (11, 13, 18)
 CD **18** (10, 13, 19)
 CLEAR **15** (13)
 CLOCK/TIMER SELECT **2**
 (21, 22)
 CLOCK/TIMER SET **3** (9, 21,
 22)
 DISC SKIP **10** (11, 13)
 DISPLAY **21** (16, 23)
 ENTER **9** (9, 13, 14, 21, 22)
 EQ **14** (20)

F - Z

FM MODE **4** (16)
 FUNCTION **6** (10, 13, 14, 15,
 17, 19, 26, 29, 31)
 PLAY MODE **20** (11, 13)
 REPEAT **4** (12)
 SLEEP **22** (20)
 TAPE **17** (17, 19)
 TUNER BAND **5** (14, 15, 19)
 TUNER MEMORY **19** (14)
 TUNING MODE **20** (14, 15)
 VOLUME +/- **12** (21, 29)

BUTTON DESCRIPTIONS

I/⏻ (power) **1** (8, 15, 21, 26)
 ◀▶ (rewind/fast forward)
7 (11, 15, 17)
 ⏸ (pause) **8** (11, 17)
 ■ (stop) **8** (11, 17, 18, 22)
 ▶ (play) **8** (11, 17)
 +/- (tuning) **16** (14, 20)
 ◀◀/▶▶ (go back/go forward)
16 (9, 11, 21)

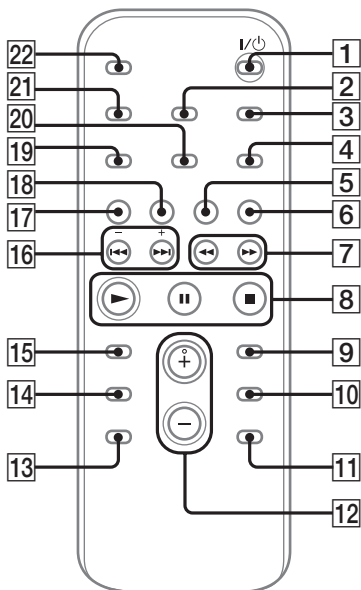

Free Manuals Download Website

<http://myh66.com>

<http://usermanuals.us>

<http://www.somanuals.com>

<http://www.4manuals.cc>

<http://www.manual-lib.com>

<http://www.404manual.com>

<http://www.luxmanual.com>

<http://aubethermostatmanual.com>

Golf course search by state

<http://golfingnear.com>

Email search by domain

<http://emailbydomain.com>

Auto manuals search

<http://auto.somanuals.com>

TV manuals search

<http://tv.somanuals.com>