



# PA91

## REAR-MOUNT BOOM MOWER

Published 03/09

Part No. 7191852C

# OPERATOR'S MANUAL



This Operator's Manual is an integral part of the safe operation of this machine and must be maintained with the unit at all times. READ, UNDERSTAND, and FOLLOW the Safety and Operation Instructions contained in this manual before operating the equipment. *C01-Cover*

BC-0004

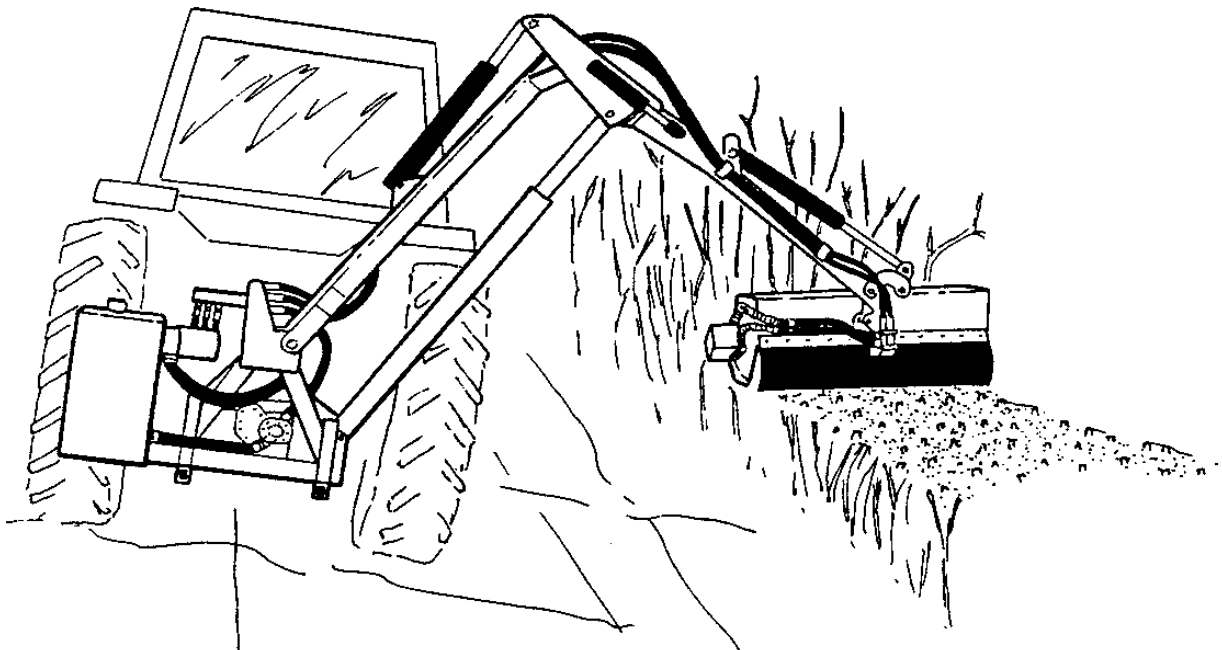

**ALAMO INDUSTRIAL®**

1502 E. Walnut  
Seguin, Texas 78155  
830-372-3551  
Email: [parts@alamo-industrial.com](mailto:parts@alamo-industrial.com)



©2009 Alamo Group Inc.

\$0.00

# To the Owner/Operator/Dealer





All implements with moving parts are potentially hazardous. There is no substitute for a cautious, safe-minded operator who recognizes the potential hazards and follows reasonable safety practices. The manufacturer has designed this implement to be used with all its safety equipment properly attached to minimize the chance of accidents.

**BEFORE YOU START!!** Read the safety messages on the implement and shown in your manual. Observe the rules of safety and common sense!



# DANGER

FAILING TO FOLLOW SAFETY MESSAGES AND OPERATING INSTRUCTIONS CAN CAUSE SERIOUS BODILY INJURY OR EVEN DEATH TO OPERATOR AND OTHERS IN THE AREA.

<p>1. </p>	<p>2. NORIDERS. NO CHILDREN OPERATORS. </p>	<p>3. USE SAFETY SHOES, HARD HAT, SAFETY GLASSES, SEAT BELTS, &amp; ROPS. </p>	<p>4. BLOCK UP SECURELY BEFORE WORKING UNDER. </p>
---	--	--	---

1. Study and understand Operator's Manuals, Safety Signs, and Instructional Decals for tractor and implement to prevent misuse, abuse and accidents.

- Learn how to stop engine suddenly in an emergency. Be alert for passersby and especially children.

2. Allow no children on or near implement or tractor. Allow no riders on tractor or implement. Falling off may cause serious injury or death from being run over by tractor or cutter or contact with rotating blades.

3. Operate only with tractor having Roll-Over Protective Structure (ROPS) and with seatbelt fastened securely and snugly to prevent injury and possible death from falling off or tractor overturn. Personal Protective Equipment such as Hard Hat, Safety Glasses, Safety shoes, and Ear Plugs are recommended.

4. Block up or support raised machine and all lifted components securely before putting hands or feet under or working underneath any lifted components to prevent crushing injury or death from sudden dropping or inadvertent operation of controls. Make certain area is clear before lowering or folding.

5. Before transporting, put Lift Lever in detent or full-lift position. Secure the implement for transport by installing Cylinder Stops or Transport Pin on pull-type implement center axle and Wing Transport Locks on folding implements.





- Attach Safety Chain to cutter and towing unit securely. See Operator's Manual.

6. Make certain that SMV sign, Warning Lights, and Reflectors are clearly visible. Follow local traffic codes.

7. Never operate with Cutting Head raised if passersby, bystanders, or traffic are in the area to reduce possibility of injury or death from objects thrown by Blades under Guards or cutter structure.

8. Before dismounting, secure implement in transport position or lower to ground.

- Put tractor in park or set brake, disengage PTO, stop engine, and remove key, and wait until noise of rotation has ceased to prevent entanglement in rotating parts which can cause injury or death.
- Never mount or dismount a moving vehicle. Crushing from runover may cause injury or death.

<p>5. TRANSPORT SAFELY, CARRY LOW TO GROUND </p>	<p>6. USE SMV, LIGHTS, &amp; REFLECTORS. </p>	<p>7. DO NOT OPERATE WITH CUTTER RAISED. </p>	<p>8. DO NOT MOUNT OR DISMOUNT WHILE MOVING. </p>
---	--	---	--

00777519

## WARRANTY INFORMATION:

Read and understand the complete Warranty Statement found in this Manual. Fill out the Warranty Registration Form in full and return it to within 30 Days. Make certain the Serial Number of the Machine is recorded on the Warranty Card and on the Warranty Form that you retain.

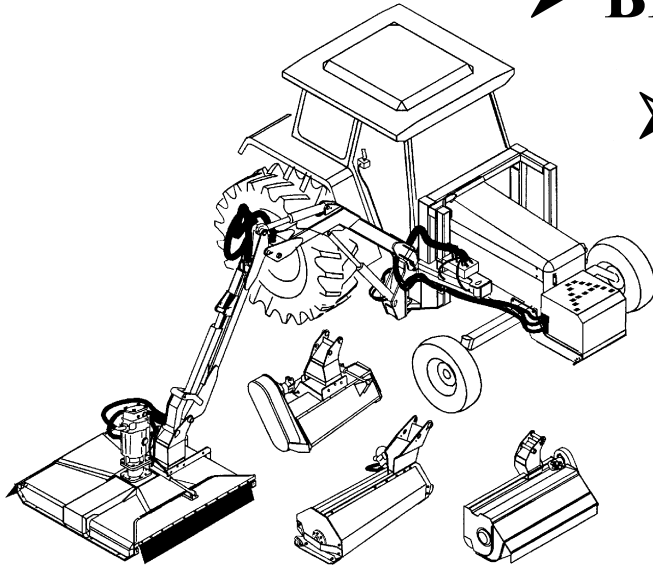

➤ **BE SAFE!**

➤ **BE ALERT!**

➤ **BE ALIVE!**

➤ **BE TRAINED  
before operating  
the Mower!**

**ALAMO  
INDUSTRIAL**

*Safety Training  
Makes the Difference*

In order to reduce accidents and enhance the safe operation of mowers, *Alamo Industrial*, in cooperation with other industry manufacturers has developed the AEM/FEMA Industrial and Agricultural Mower Safety Practices video and guide book.

The video will familiarize and instruct mower-tractor operators in safe practices when using industrial and agricultural mowing equipment. It is important that Every Mower Operator be educated in the operation of their mowing equipment and be able to recognize the potential hazards that can occur while operating a mower. This video, along with the mower operator's manual and the warning messages on the mower, will significantly assist in this important education.

Your Authorized *Alamo Industrial* Dealer may have shown this video and presented you a DVD Video when you purchased your mower. If you or any mower operator have not seen this video, **Watch the Video, Read this Operator's Manual, and Complete the Video Guidebook** before operating your new mower. If you do not understand any of the instructions included in the video or operator's manual or if you have any questions concerning safety of operation, contact your supervisor, dealer or *Alamo Industrial*.

If you would like a VHS video tape of the video, please email [AEMVideo@alamo-group.com](mailto:AEMVideo@alamo-group.com) or Fax AEM VHS Video at (830) 372-9529 or mail in a completed copy of the form on the back of this page to AEM VHS Video 1502 E Walnut Street, Seguin, TX 78155. and request the VHS video version. Please include your name, mailing address, mower model and serial number.

Every operator should be trained for each piece of equipment (Tractor and Mower), understand the intended use, and the potential hazards before operating the equipment.

**Alamo Industrial Division is willing to provide  
one (1) AEM Mower Safety Practices Video**

- Please Send Me:  VHS Format – AEM/FEMA Mower Operator Safety Video  
 DVD Format – AEM/FEMA Mower Operator Safety Video  
 Mower Operator’s Manual  
 AEM Mower Operator’s Safety Manual

Requester Name \_\_\_\_\_ Phone: \_\_\_\_\_

Requester Address: \_\_\_\_\_

City \_\_\_\_\_

State \_\_\_\_\_

Zip Code \_\_\_\_\_

Mower Model: \_\_\_\_\_ Serial Number: \_\_\_\_\_

Date Purchased: \_\_\_\_\_ Dealer Salesperson: \_\_\_\_\_

Dealership Name: \_\_\_\_\_ Dealership Location: \_\_\_\_\_

Mail to:

AEM Video Services

1502 E Walnut street

Seguin, TX 78155

Or Fax to:

(830) 372-9529

Or Email to:

AEMVideo@alamo-group.com



# TABLE OF CONTENTS

<b>SAFETY SECTION .....</b>	<b>1-1</b>
General Safety Instructions and Practices .....	1-2
Operator Safety Instructions and Practices .....	1-3
Equipment Operation Safety Instructions and Practices .....	1-5
COncecting or Disconnecting Implement Safety Instructions and Practices .....	1-11
Transporting Safety Instructions and Practices .....	1-12
Maintenance and Service Safety Instructions and Practices .....	1-14
Concluding Safety Instructions and Practices .....	1-16
Decal Location .....	1-17
Decal Description .....	1-19
Federal Laws and Regulations .....	1-27
<b>INTRODUCTION SECTION .....</b>	<b>2-1</b>
<b>ASSEMBLY SECTION .....</b>	<b>3-1</b>
TRACTOR SELECTION .....	3-2
Horsepower and Weight Requirements .....	3-2
Linkage Requirements .....	3-2
Linkage Isolation .....	3-2
Check Chains/ Stabilizers .....	3-2
Tractor Relief Valve .....	3-2
Tractor Hydraulic Flow Rates .....	3-2
P.T.O. Shaft .....	3-2
Draft Control .....	3-2
TRACTOR PREPARATION .....	3-3
Fitting Operator Guard .....	3-3
Ballast Weight .....	3-4
JOHN DEERE CONVERSION KIT (81- 30- 059) .....	3-4
DELIVERY .....	3-5
ATTACHMENT TO TRACTOR .....	3-5
Si Model .....	3-5
Ti Model .....	3-6
FITTING CONTROL UNIT IN CAB .....	3-8
OIL REQUIREMENTS .....	3-9
Tank .....	3-9
Gearbox .....	3-9
RUNNING UP PROCEDURE .....	3-10
PA91 Ti .....	3-10
PA91 Si .....	3-10
REMOVAL FROM TRACTOR .....	3-11
STORAGE .....	3-11
PROPER TORQUE VALUES FOR FASTENERS .....	3-12
<b>OPERATION SECTION .....</b>	<b>4-1</b>
Standard Equipment and Specifications .....	4-3
OPERATOR REQUIREMENTS .....	4-4
<b>TRACTOR REQUIREMENTS .....</b>	<b>4-5</b>
ROPS and Seat Belt .....	4-5

Operator Thrown Object Protection .....	4-5
Tractor Lighting and SMV Emblem .....	4-6
Tractor Ballast .....	4-7
Tractor Safety Devices .....	4-7
Tractor Horsepower .....	4-7
3-Point Hitch .....	4-8
Hydraulics .....	4-8
Front End Weight .....	4-8
Power Take Off (PTO) .....	4-9
GETTING ON AND OFF THE TRACTOR .....	4-9
Boarding the Tractor .....	4-10
Dismounting the Tractor .....	4-10
STARTING THE TRACTOR .....	4-11
Connecting Attaching Head to the Boom .....	4-12
Connecting Mower Head Hydraulics .....	4-12
PRE-OPERATION INSPECTION AND SERVICE .....	4-14
Tractor Pre-Operation Inspection/Service .....	4-14
Boom Unit Pre-Operation Inspection and Service .....	4-15
OPERATING THE BOOM MOWER .....	4-21
Machine Controls .....	4-21
Engaging Drive .....	4-21
Forward Speed .....	4-22
Tractor Position .....	4-22
Operating Speed .....	4-22
Working Close In and High .....	4-22
Breakaway .....	4-22
Wire Trap .....	4-22
Hedge Cutting Procedure .....	4-23
Lift Float Kit (Optional) .....	4-25
Flail Types .....	4-26
Machine Configuration .....	4-26
DRIVING THE TRACTOR AND IMPLEMENT .....	4-27
Starting the Tractor .....	4-28
Brake and Differential Lock Setting .....	4-29
Transport Position .....	4-30
Driving the Tractor and Boom .....	4-31
OPERATING THE TRACTOR AND IMPLEMENT .....	4-32
OPERATING INSTRUCTIONS .....	4-32
Foreign Debris Hazards .....	4-34
Bystanders/Passersby Precautions .....	4-34
Engaging the Power Take Off (PTO) .....	4-35
Operating Speed and Ground Speed .....	4-36
Operating the Mower .....	4-36
Shutting Down the Attached Head .....	4-38
TRACTOR, BOOM, AND ATTACHED HEAD STORAGE .....	4-39
TRANSPORTING THE TRACTOR AND IMPLEMENT .....	4-40
Transporting on Public Roadways .....	4-40
Hauling the Tractor and Implement .....	4-43
TROUBLESHOOTING GUIDE .....	4-44
<b>MAINTENANCE SECTION .....</b>	<b>5-1</b>
LUBRICATION .....	5-2
HYDRAULIC SYSTEM .....	5-3
FLOAT KIT ACCUMULATOR TEST .....	5-3

HYDRAULIC PUMPS .....	5-4
FLAILHEAD .....	5-4
CABLE OPERATED ARMHEAD CONTROL VALVE .....	5-5
Replacing Damaged or Worn Spool "O" Rings .....	5-5
Main Relief Valve .....	5-6
Non-Return Valve .....	5-6
CABLES .....	5-6
HYDRAULIC RAMS .....	5-7
Ram Seal Replacement - General Information .....	5-7
Angling Arm .....	5-7
Reach Ram .....	5-7
ROTOR CONTROL VALVE/RELIEF VALVE .....	5-8
Relief Valve .....	5-8
Replacing Worn or Damaged "O" Rings .....	5-8
P.T.O. GEARBOX .....	5-8
HYDRAULIC MOTOR .....	5-8
Replacing Shaft Seals .....	5-9
HYDRAULIC HOSES .....	5-9
Hose Replacement .....	5-9
Hose Warranty .....	5-9



# **SAFETY SECTION**

Safety Section 1-1

# SAFETY

## General Safety Instructions and Practices

A careful operator is the best operator. Safety is of primary importance to the manufacturer and should be to the owner/operator. Most accidents can be avoided by being aware of your equipment, your surroundings, and observing certain precautions. The first section of this manual includes a list of Safety Messages that, if followed, will help protect the operator and bystanders from injury or death. Read and understand these Safety Messages before assembling, operating or servicing this Implement. This equipment should only be operated by those persons who have read the manual, who are responsible and trained, and who know how to do so responsibly.



The Safety Alert Symbol combined with a Signal Word, as seen below, is used throughout this manual and on decals which are attached to the equipment. The Safety Alert Symbol means: "ATTENTION! BECOME ALERT! YOUR SAFETY IS INVOLVED!" The Symbol and Signal Word are intended to warn the owner/operator of impending hazards and the degree of possible injury faced when operating this equipment.

Practice all usual and customary safe working precautions and above all--remember safety is up to YOU. Only YOU can prevent serious injury or death from unsafe practices.



Indicates an imminently hazardous situation that, if not avoided, WILL result in DEATH OR VERY SERIOUS INJURY.



Indicates an imminently hazardous situation that, if not avoided, COULD result in DEATH OR SERIOUS INJURY.



Indicates an imminently hazardous situation that, if not avoided, MAY result in MINOR INJURY.



Identifies special instructions or procedures that, if not strictly observed, could result in damage to, or destruction of the machine, attachments or the environment.

**NOTE:** *Identifies points of particular interest for more efficient and convenient operation or repair.* (SG-1)

READ, UNDERSTAND, and FOLLOW the following Safety Messages. Serious injury or death may occur unless care is taken to follow the warnings and instructions stated in the Safety Messages. Always use good common sense to avoid hazards. (SG-2)



Si no lee ingles, pida ayuda a alguien que si lo lea para que le traduzca las medidas de seguridad. (SG-3)

¡ LEA EL INSTRUCTIVO!



# SAFETY



Engine Exhaust, some of its constituents, and certain vehicle components contain or emit chemicals known to the state of California to cause cancer and birth defects or other reproductive harm. (SG-30)



Battery posts, terminals and related accessories contain lead and lead compounds, chemicals known to the state of California to cause cancer, birth defects or other reproductive harm. (SG-31)

## Operator Safety Instructions and Practices



The rotating parts of this machine continue to rotate even after the PTO has been turned off. The operator should remain in his seat for 60 seconds after the brake has been set, the PTO disengaged, the tractor turned off, and all evidence of rotation has ceased. (S3PT-10)

**“Wait a minute...Save a life!”**



Never crawl under a raised Implement supported solely by the Tractor 3-Point hitch. Release of the control lever or mechanical failure will result in the Implement falling and possible injury or death. Always securely block up the Implement before crawling underneath to perform repairs and service. (S3PT-19)



Never operate the Tractor or Implement until you have read and completely understand this Manual, the Tractor Operator's Manual, and each of the Safety Messages found in the Manual or on the Tractor and Implement. Learn how to stop the tractor engine suddenly in an emergency. Never allow inexperienced or untrained personnel to operate the Tractor and Implement without supervision. Make sure the operator has fully read and understood the manuals prior to operation. (SG-4)

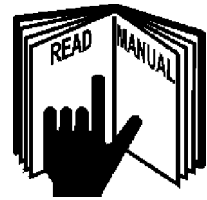

The operator and all support personnel should wear hard hats, safety shoes, safety glasses, and proper hearing protection at all times for protection from injury including injury from items that may be thrown by the equipment. (SG-16)

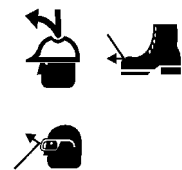

# SAFETY

**CAUTION**

PROLONGED EXPOSURE TO LOUD NOISE MAY CAUSE PERMANENT HEARING LOSS! Tractors with or without an Implement attached can often be noisy enough to cause permanent hearing loss. We recommend that you always wear hearing protection if the noise in the Operator's position exceeds 80db. Noise over 85db over an extended period of time will cause severe hearing loss. Noise over 90db adjacent to the Operator over an extended period of time will cause permanent or total hearing loss. **NOTE:** *Hearing loss from loud noise [from tractors, chain saws, radios, and other such sources close to the ear] is cumulative over a lifetime without hope of natural recovery.* (SG-17)



**WARNING**

Always read carefully and comply fully with the manufacturer's instructions when handling oil, solvents, cleansers, and any other chemical agent. (SG-22)



**DANGER**

KEEP AWAY FROM ROTATING ELEMENTS to prevent entanglement and possible serious injury or death. (SG-24)



**DANGER**

Never allow children to play on or around Tractor or Implement. Children can slip or fall off the Equipment and be injured or killed. Children can cause the Implement to shift or fall crushing themselves or others. (SG-25)

**DANGER**

NEVER use drugs or alcohol immediately before or while operating the Tractor and Implement. Drugs and alcohol will affect an operator's alertness and coordination and therefore affect the operator's ability to operate the equipment safely. Before operating the Tractor or Implement, an operator on prescription or over-the-counter medication must consult a medical professional regarding any side effects of the medication that would hinder their ability to operate the Equipment safely. NEVER knowingly allow anyone to operate this equipment when their alertness or coordination is impaired. Serious injury or death to the operator or others could result if the operator is under the influence of drugs or alcohol. (SG-27)



**WARNING**

Prolonged operation may cause operator boredom and fatigue affecting safe operation. Take scheduled work breaks to help prevent these potentially impaired operating conditions. Never operate the Implement and Tractor in a fatigued or bored mental state which impairs proper and safe operation. (SG-32)



# SAFETY



**WARNING**

Use extreme caution when getting onto the Implement to perform repairs, maintenance and when removing accumulated material. Only stand on solid flat surfaces to ensure good footing. Use a ladder or raised stand to access high spots which cannot be reached from ground level. Slipping and falling can cause serious injury or death. (SG-33)



**WARNING**

Avoid contact with hot surfaces including hydraulic oil tanks, pumps, motors, valves and hose connections. Relieve hydraulic pressure before performing maintenance or repairs. Use gloves and eye protection when servicing hot components. Contact with a hot surface or fluid can cause serious injury from burns or scalding. (SG-34)



**DANGER**

DO NOT operate this Implement on a Tractor that is not properly maintained. Should a mechanical or Tractor control failure occur while operating, immediately shut down the Tractor and perform repairs before resuming operation. Serious injury and possible death could occur from not maintaining this Implement and Tractor in good operating condition. (SG-36)



**WARNING**

Avoid contact with hot surfaces of the engine or muffler. Use gloves and eye protection when servicing hot components. Contact with a hot surface or fluid can cause serious injury from burns or scalding. (SG-38)



**WARNING**

Do not put hands or feet under mower decks. Blade Contact can result in serious injury or even death. Stay away until all motion has stopped and the decks are securely blocked up. (SGM-09)

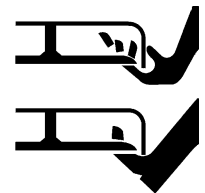

**DANGER**

Always keep a careful lookout and use extreme care when working around utility and municipal obstructions. Never allow the Mower to contact any utility, municipal, or other type structure. Clearly mark all mowing obstructions and consult local utility providers for a safe code of operation. (SPU-5)



**DANGER**

Do not operate the implement while wearing loose fitting clothing. Entanglement of the clothing with the rotating elements can result in serious injury or even death. Stay clear of all rotating elements at all times. (SSP-03)

## Equipment Operation Safety Instructions and Practices



**WARNING**

Never leave the Tractor and Implement unattended while the Implement is in the lifted position. Accidental operation of lifting lever or a hydraulic failure may cause sudden drop of unit with injury or death by crushing. To properly park the implement when disconnecting it from the tractor, lower the stand and put the retaining pin securely in place, or put a secure support under the A-Frame. Lower the implement carefully to the ground. Do not put hands or feet under lifted components. (S3PT-1)

**SAFETY**

# SAFETY



**WARNING** Use extreme care when lowering or unfolding the implement's wings. Make sure no bystanders are close by or underneath the wings. Allow ample clearance around the implement when folding or unfolding the wings. Use extreme caution around buildings or overhead power lines. (S3PT-05)



**DANGER** This Implement is wider than the Tractor. Be careful when operating or transporting this equipment to prevent the Implement from running into or striking sign posts, guard rails, concrete abutments or other solid objects. Such an impact could cause the Implement and Tractor to pivot violently resulting in loss of steering control, serious injury, or even death. Never allow the Implement to contact obstacles. (S3PT-12)



**DANGER** Be sure you have adequate knowledge of the property you will be working on. Take time to make yourself aware of any area underground lines or cables. Contact with buried lines or cable could result in **serious injury** or **death**. If in doubt about buried utility lines call 811 before digging or 1-800-258-0808. (SBH-6)



**WARNING** Do not operate Mower if excessive vibration exists. Shut down PTO and the Tractor engine. Inspect the Mower to determine the source of the vibration. If Mower blades are missing or damaged replace them immediately. Do not operate the mower until the blades have been replaced and the Mower operates smoothly. Operating the Mower with excessive vibration can result in component failure and broken objects to be thrown outward at very high velocities. To reduce the possibility of property damage, serious injury, or even death, never allow the Mower to be operated with blades missing. (SFL-4)



**WARNING** Operate this Equipment only with a Tractor equipped with an approved roll-over-protective system (ROPS). Always wear seat belts. Serious injury or even death could result from falling off the tractor--particularly during a turnover when the operator could be pinned under the ROPS. (SG-7)



**DANGER** BEFORE leaving the tractor seat, always engage the brake and/or set the tractor transmission in parking gear, disengage the PTO, stop the engine, remove the key, and wait for all moving parts to stop. Place the tractor shift lever into a low range or parking gear to prevent the tractor from rolling. Never dismount a Tractor that is moving or while the engine is running. Operate the Tractor controls from the tractor seat only. (SG-9)

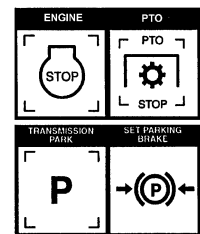

**DANGER** Never allow children or other persons to ride on the Tractor or Implement. Falling off can result in serious injury or death. (SG-10)



# SAFETY

## **DANGER**

Never allow children to operate, ride on, or come close to the Tractor or Implement. Usually, 16-17 year-old children who are mature and responsible can operate the implement with adult supervision, if they have read and understand the Operator's Manuals, been trained in proper operation of the tractor and Implement, and are physically large enough to reach and operate the controls easily. (SG-11)



## **WARNING**

Do not mount or dismount the Tractor while the tractor is moving. Mount the Tractor only when the Tractor and all moving parts are completely stopped. (SG-12)



## **DANGER**

Start tractor only when properly seated in the Tractor seat. Starting a tractor in gear can result in injury or death. Read the Tractor operators manual for proper starting instructions. (SG-13)



## **WARNING**

Do not operate this Equipment with hydraulic oil or fuel leaking. Oil and fuel are explosive and their presence could present a hazard. Do not check for leaks with your hand! High-pressure oil streams from breaks in the line could penetrate the skin and cause tissue damage including gangrene. To check for a hose leak, SHUT the unit ENGINE OFF and remove all hydraulic pressure. Wear oil impenetrable gloves, safety glasses and use Cardboard to check for evidence of oil leaks. If you suspect a leak, REMOVE the HOSE and have it tested at a Dealer. If oil does penetrate the skin, have the injury treated immediately by a physician knowledgeable and skilled in this procedure. (SG-15)



## **DANGER**

Never run the Tractor engine in a closed building or without adequate ventilation. The exhaust fumes can be hazardous to your health. (SG-23)

## **WARNING**

Do not exceed the rated PTO speed for the Implement. Excessive PTO speeds can cause Implement driveline or blade failures resulting in serious injury or death. (SG-26)

SAFETY

# SAFETY



Operate the Tractor and/or Implement controls only while properly seated in the Tractor seat with the seat belt securely fastened around you. Inadvertent movement of the Tractor or Implement may cause serious injury or death. (SG-29)



In case of mechanical difficulty during operation, place the transmission in the park position, set the parking brake, shut down all power, including the PTO and the engine and remove the key. Wait until all rotating motion has stopped before dismounting. (SG-39)



Do Not operate this equipment in areas where insects such as bees may attack you and/or cause you to lose control of the equipment. If you must enter in such areas, use a tractor with an enclosed Cab and close the windows to prevent insects from entering. If a tractor cab is not available, wear suitable clothing including head, face, and hand protection to shield you from the insects. Attacking insects can cause you to lose control of the tractor, which can result in serious injury or death to you or bystanders. Never dismount a moving tractor. (SG-40)



Mow only in conditions where you have clear visibility in daylight or with adequate artificial lighting. Never mow in darkness or foggy conditions where you cannot clearly see at least 100 yards(90 m) in front and to the sides of the tractor and mower. Make sure that you can clearly see and identify passersby, steep slopes, ditches, drop-offs, overhead obstructions, power lines, debris and foreign objects. If you are unable to clearly see these type of items discontinue mowing. (SGM-1)



There are obvious and hidden potential hazards in the operation of this Mower. REMEMBER! This machine is often operated in heavy brush and in heavy weeds. The Blades of this Mower can throw objects if shields are not properly installed and maintained. Serious injury or even death may occur unless care is taken to insure the safety of the operator, bystanders, or passersby in the area. Do not operate this machine with anyone in the immediate area. Stop mowing if anyone is within 100 yards of mower. (SGM-02)



The rotating parts of this machine have been designed and tested for rugged use. However, the blades could fail upon impact with heavy, solid objects such as metal guard rails and concrete structures. Such impact could cause the broken objects to be thrown outward at very high velocities. To reduce the possibility of property damage, serious injury, or even death, never allow the cutting blades to contact such obstacles. (SGM-4)

# SAFETY

## **WARNING**

Extreme care should be taken when operating near loose objects such as gravel, rocks, wire, and other debris. Inspect the area before mowing. Foreign objects should be removed from the site to prevent machine damage and/or bodily injury or even death. Any objects that cannot be removed must be clearly marked and carefully avoided by the operator. Stop mowing immediately if blades strike a foreign object. Repair all damage and make certain rotor or blade carrier is balanced before resuming mowing. (SGM-05)



## **WARNING**

Many varied objects, such as wire, cable, rope, or chains, can become entangled in the operating parts of the mower head. These items could then swing outside the housing at greater velocities than the blades. Such a situation is extremely hazardous and could result in serious injury or even death. Inspect the cutting area for such objects before mowing. Remove any like object from the site. Never allow the cutting blades to contact such items.

(SGM-06)

## **WARNING**

Mow at the speed that you can safely operate and control the tractor and mower. The correct mowing speed depends on terrain condition and grass type, density, and height of cut. Normal ground speed range is from 2 to 5 mph(3-8 kph). Use slow mowing speeds when operating on or near steep slopes, ditches, drop-offs, overhead obstructions, power lines, or when debris and foreign objects are to be avoided. (SGM-07)

## **WARNING**

Avoid mowing in reverse direction when possible. Check to make sure there are no persons behind the mower and use extreme care when mowing in reverse. Mow only at a slow ground speed where you can safely operate and control the tractor and mower. Never mow an area that you have not inspected and removed debris or foreign material.

(SGM-08)

## **WARNING**

Do not mow with two machines in the same area except with Cab tractors with the windows closed. (SGM-11)

**SAFETY**

# SAFETY



Follow these guidelines to reduce the risk of equipment and grass fires while operating, servicing, and repairing the Mower and Tractor:



- Equip the Tractor with a fire extinguisher in an accessible location.
- Do Not operate the Mower on a Tractor with an underframe exhaust.
- Do Not smoke or have an open flame near the Mower and Tractor.
- Do Not drive into burning debris or freshly burnt areas.
- Ensure slip clutches are properly adjusted to prevent excessive slippage and plate heating.
- Never allow clippings or debris to collect near drivelines, slip clutches, and gearboxes. Periodically shut down the Tractor and Mower and clean clippings and collected debris from the mower deck. (SGM-12)



The Mower is designed for certain mowing applications and is rated to cut up to a specific size vegetation (see Mower Standard Equipment and Specifications). DO NOT use this mower to cut vegetation above the Mower's rated capacity or to cut any type of non-vegetative material. Only operate this Mower on a properly sized and equipped Tractor. Operating this Mower in an application for which it is not designed and/or operating the Mower with the wrong size Tractor can cause Mower component damage and equipment failure resulting in possible serious injury or death. (SGM-14)



Do not operate or pull the mower into standing water. When uplift or fan type mower blades contact water they can be severely deflected downward causing possible failure of blade resulting in serious injury to the operator or bystanders. (SGM-15)



Use extreme caution when raising the Mower above ground level. Stop the Blades from turning when the Mower is raised and passersby are within 100 yards. Raising the Mower exposes the Cutting Blades which creates a potentially serious hazard and can cause serious injury by objects thrown from the Blades or by contact with the Blades. (SPU-1)

# SAFETY



Rotary Mowers are capable under adverse conditions of throwing objects for great distances (300 feet or more) and causing serious injury or death. Follow safety messages carefully.

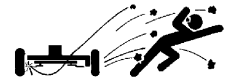

## STOP MOWING IF PASSERSBY ARE WITHIN 100 YARDS UNLESS:

- Front and Rear Deflectors, Chain Guards, or Bands are installed and in good, workable condition;
- Mower sections or Wings are running close to and parallel to the ground without exposed Blades;
- Passersby are outside the existing thrown-object zone;
- All areas have been thoroughly inspected and all foreign material such as rocks, cans, glass, and general debris has been removed.

**NOTE:** *Where there are grass and weeds high enough to hide debris that could be struck by the blades, the area should be: inspected and large debris removed, mowed at an intermediate height, inspected, closely with any remaining debris being removed, and mowed again at desired final height. (This will also reduce power required to mow, reduce wear and tear on the Mower drivetrain, spread cut material better, reduce streaking, and make the final cut more uniform).* (SRM-01)



Do not turn so sharp or lift mower so high to produce a severe "knocking" of the Driveline which will cause accelerated wear and breakage of drive train components and could result in possible injury from the separated Driveline sections. (SRM-04)



Do not let the Blades turn when the Mower Deck is raised for any reason, including clearance or for turning. Raising the Mower deck exposes the Cutting Blades which creates a potentially serious hazard and could cause serious injury or even death from objects thrown from the Blades. (SRM-07)



## COnnecting or DIsconnecting Implement Safety Instructions and Practices



**DO NOT** use a PTO adapter to attach a non-matching Implement driveline to a Tractor PTO. Use of an adapter can double the operating speed of the Implement resulting in excessive vibration, thrown objects, and blade and implement failure. Adapter use will also change the working length of the driveline exposing unshielded driveline areas. Serious bodily injury and/or equipment failure can result from using a PTO adapter. Consult an authorized dealer for assistance if the Implement driveline does not match the Tractor PTO. (S3PT-14)

# SAFETY



Always shut the Tractor completely down, place the transmission in park, and set the parking brake before you or anyone else attempts to connect or disconnect the Implement and Tractor hitches. (S3PT-15)



Never operate the Tractor and Mower if the Implement input driveline is directly connected to the Tractor transmission. Tractor braking distances can be substantially increased by the momentum of the rotating Mower blades driving the Tractor transmission even though the Tractor clutch has been disengaged. Install an over running clutch between the Tractor PTO and the Mower driveline to prevent this potentially dangerous situation. (S3PT-16)



When attaching the Implement input driveline to the Tractor PTO, it is important that the connecting yoke spring activated locking collar slides freely and the locking balls are seated securely in the groove on the Tractor PTO shaft. Push and pull the driveline back and forth several times to ensure it is securely attached. A driveline not attached correctly to the Tractor PTO shaft could come loose and result in personal injury and damage to the Implement. (S3PT-17)



Before operating the Implement, check to make sure the Implement input driveline will not bottom out or become disengaged. Bottoming out occurs when the inner shaft penetrates the outer housing until the assembly becomes solid-it can shorten no more. Bottoming out can cause serious damage to the Tractor PTO by pushing the PTO into the Tractor and through the support bearings or downward onto the PTO shaft, breaking it off. A broken driveline can cause personal injury. (S3PT-18)

## Transporting Safety Instructions and Practices



Be particularly careful when transporting the Implement with the Tractor. Turn curves or go up hills only at a low speed and using a gradual steering angle. Rear mounted implements move the center of gravity to the rear and remove weight from the front wheels. Make certain, by adding front ballast, that at least 20% of the tractor's weight is on the front wheels to prevent rearing up, loss of steering control or Tractor tip-over. Slow down on rough or uneven surfaces to prevent loss of steering control which could result in property damage or possible injury. Do not transport unless 3-Point lift lever is fully raised and in the latched transport position. Dropping implement in transport can cause serious damage to the tractor and/or Implement and possibly cause the operator or others to be injured or killed. (S3PT-02)



Allow sufficient clearance for the Implement to swing outward while turning. Implements carried behind the Tractor will swing outside the tire path when making turns. Contacting a solid object while turning will cause equipment damage and possible injury. (S3PT-20)



# SAFETY

## **WARNING**

Make certain that the "Slow Moving Vehicle" (SMV) sign is installed in such a way as to be clearly visible and legible. When transporting the Equipment use the Tractor flashing warning lights and follow all local traffic regulations. (SG-6)

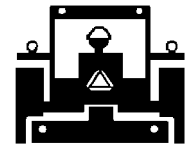

## **WARNING**

Transport only at speeds where you can maintain control of the equipment. Serious accidents and injuries can result from operating this equipment at high speeds. Understand the Tractor and Implement and how it handles before transporting on streets and highways. Make sure the Tractor steering and brakes are in good condition and operate properly.



Before transporting the Tractor and Implement, determine the proper transport speeds for you and the equipment. Make sure you abide by the following rules:

Test the tractor at a slow speed and increase the speed slowly. Apply the Brakes smoothly to determine the stopping characteristics of the Tractor and Implement. As you increase the speed of the Tractor the stopping distance increases. Determine the maximum transport speed not to exceed 20 mph (30 kph) for transporting this equipment.

Test the equipment at a slow speed in turns. Increase the speed through the turn only after you determine that the equipment can be operated at a higher speed. Use extreme care and reduce your speed when turning sharply to prevent the tractor and implement from turning over. Determine the maximum turning speed for you and this equipment before operating on roads or uneven ground.

Only transport the Tractor and Implement at the speeds which allow you to properly control the equipment.



Be aware of the operating conditions. Do not operate the Tractor with weak or faulty brakes or worn tires. When operating down a hill or on wet or rain slick roads, the braking distance increases: use extreme care and reduce your speed. When operating in traffic always use the Tractor's flashing warning lights and reduce your speed. Be aware of traffic around you and watch out for the other guy. (SG-19)

## **DANGER**

Be particularly careful when transporting the Implement using the tractor. Turn curves or go up or down hills only at a low speed and at a gradual steering angle. Make certain that at least 20% of the tractor's weight is on the front wheels to maintain safe steering. Slow down on rough or uneven surfaces. (STI-01)

## **WARNING**

Only tow the Implement behind a properly sized and equipped Tractor which exceeds the weight of the Implement by at least 20%. DO NOT tow the Implement behind a truck or other type of vehicle. Never tow the Implement and another Implement connected in tandem. Never tow the Implement at speeds over 20 MPH. (STI-06)



SAFETY

# SAFETY



**WARNING**

Your driving vision may be reduced or impaired by the tractor, cab, or implement. Before driving on public roadways identify any limited vision areas, and make adjustments to your operating position, mirrors, and the implement transport position so that you can clearly see the area where you will be traveling, and any traffic that may approach you. Failure to maintain adequate vision of the public roadway and traffic can result in serious injury or even death. (STI-10)

## Maintenance and Service Safety Instructions and Practices



**DANGER**

Make sure the PTO shield, integral driveline shields, and input shields are installed when using PTO-driven equipment. Always replace any shield if it is damaged or missing. (S3PT-8)



**WARNING**

Relieve hydraulic pressure prior to doing any maintenance or repair work on the Implement. Place the Implement on the ground or securely blocked up, disengage the PTO, and turn off the tractor engine. Push and pull the Remote Cylinder lever in and out several times prior to starting any maintenance or repair work. (S3PT-09)



**DANGER**

Always disconnect the main PTO Driveline from the Tractor before performing service on the Implement. Never work on the Implement with the tractor PTO driveline connected and running. Rotating Parts, Blades or Drivelines could turn without warning and cause immediate entanglement, injury or death. (S3PT-11)



**WARNING**

Always maintain the safety signs in good readable condition. If the safety signs are missing, damaged, or unreadable, obtain and install replacement safety signs immediately. (SG-5)



**WARNING**

Do not modify or alter this Implement. Do not permit anyone to modify or alter this Implement, any of its components or any Implement function. (SG-8)



**DANGER**

Never work under the Implement, the framework, or any lifted component unless the Implement is securely supported or blocked up to prevent sudden or inadvertent falling which could cause serious injury or even death. (SG-14)



**WARNING**

Never attempt to lubricate, adjust, or remove material from the Implement while it is in motion or while tractor engine is running. (SG-20)

# SAFETY

## **WARNING**

Periodically inspect all moving parts for wear and replace when necessary with authorized service parts. Look for loose fasteners, worn or broken parts, and leaky or loose fittings. Make sure all pins have cotter pins and washers. Serious injury may occur from not maintaining this machine in good working order. (SG-21)

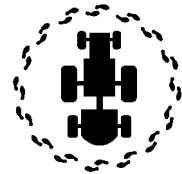

## **DANGER**

Do Not fill fuel tank while engine is running. Refuel only after engine has cooled down. If fuel is spilled, move machine away from the area of the spill and avoid creating any source of ignition until the gasoline has evaporated. (SG-28)

## **WARNING**

Perform service, repairs and lubrication according to the maintenance section. Ensure the unit is properly lubricated as specified in the lubrication schedule and all bolts and nuts are properly torqued. Failure to properly service, repair and maintain this Implement in good operating condition could cause component failure and possible serious injury or even death. (SG-35)

## **WARNING**

Use caution and wear protective gloves when handling sharp objects such as blades, knives, and other cutting edges. Be alert to worn component surfaces which have sharp edges. Sharp surfaces can inflict severe laceration injuries if proper hand protection is not worn. (SG-37)

## **DANGER**

All Safety Shields, Guards and Safety devices including (but not limited to) - the Deflectors, Chain Guards, Steel Guards, Gearbox Shields, PTO integral shields, and Retractable Door Shields should be used and maintained in good working condition. All safety devices should be inspected carefully at least daily for missing or broken components. Missing, broken, or worn items must be replaced at once to reduce the possibility of injury or death from thrown objects, entanglement, or blade contact. (SGM-3)

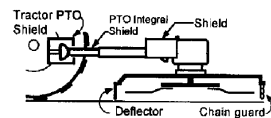

## **DANGER**

Replace bent or broken blades with new blades. NEVER ATTEMPT TO STRAIGHTEN, WELD, OR WELD HARDFACING ON BLADES SINCE THIS WILL LIKELY CRACK OR OTHERWISE DAMAGE THE BLADE WITH SUBSEQUENT FAILURE AND POSSIBLE SERIOUS INJURY FROM THROWN BLADES. (SGM-10)

## **WARNING**

DO NOT weld or repair rotating mower components. Welds and other repairs may cause severe vibration and/or component failure resulting in part being thrown from the mower causing serious bodily injury. See your Authorized Dealer for proper repairs. (SGM-13)

**SAFETY**

# SAFETY

## PARTS INFORMATION

Alamo Industrial mowers use balanced and matched system components for blade carriers, blades, cuttershafts, knives, knife hangers, rollers, drivetrain components, and bearings. These parts are made and tested to Alamo Industrial specifications. Non-genuine "will fit" parts do not consistently meet these specifications. The use of "will fit" parts may reduce mower performance, void mower warranties, and present a safety hazard. Use genuine Alamo Industrial mower parts for economy and safety. (SPRM-1)

### SEE YOUR ALAMO DEALER



Be sure you have adequate knowledge of the property you will be working on. Take time to make yourself aware of any area underground lines or cables. Contact with buried lines or cable could result in **serious injury** or **death**. (STL-1)



In wet conditions where there is a likelihood of material collecting on the Implement, make certain that this material is removed before traveling on public roadways. (STL-7)

## Concluding Safety Instructions and Practices

In addition to the design and configuration of this Implement, including Safety Signs and Safety Equipment, hazard control and accident prevention are dependent upon the awareness, concern, prudence, and proper training of personnel involved in the operation, transport, maintenance, and storage of the machine. Refer also to Safety Messages and operation instruction in each of the appropriate sections of the Tractor and Equipment Manuals. Pay close attention to the Safety Signs affixed to the Tractor and Equipment. (SG-18)

# SAFETY

## Decal Location

**NOTE:** Alamo Industrial supplies safety decals on this product to promote safe operation. Damage to the decals may occur while in shipping, use, or reconditioning. Alamo Industrial cares about the safety of its customers, operators, and bystanders, and will replace the safety decals on this product in the field, free of charge (Some shipping and handling charges may apply). Contact your Alamo Industrial dealer to order replacement decals.

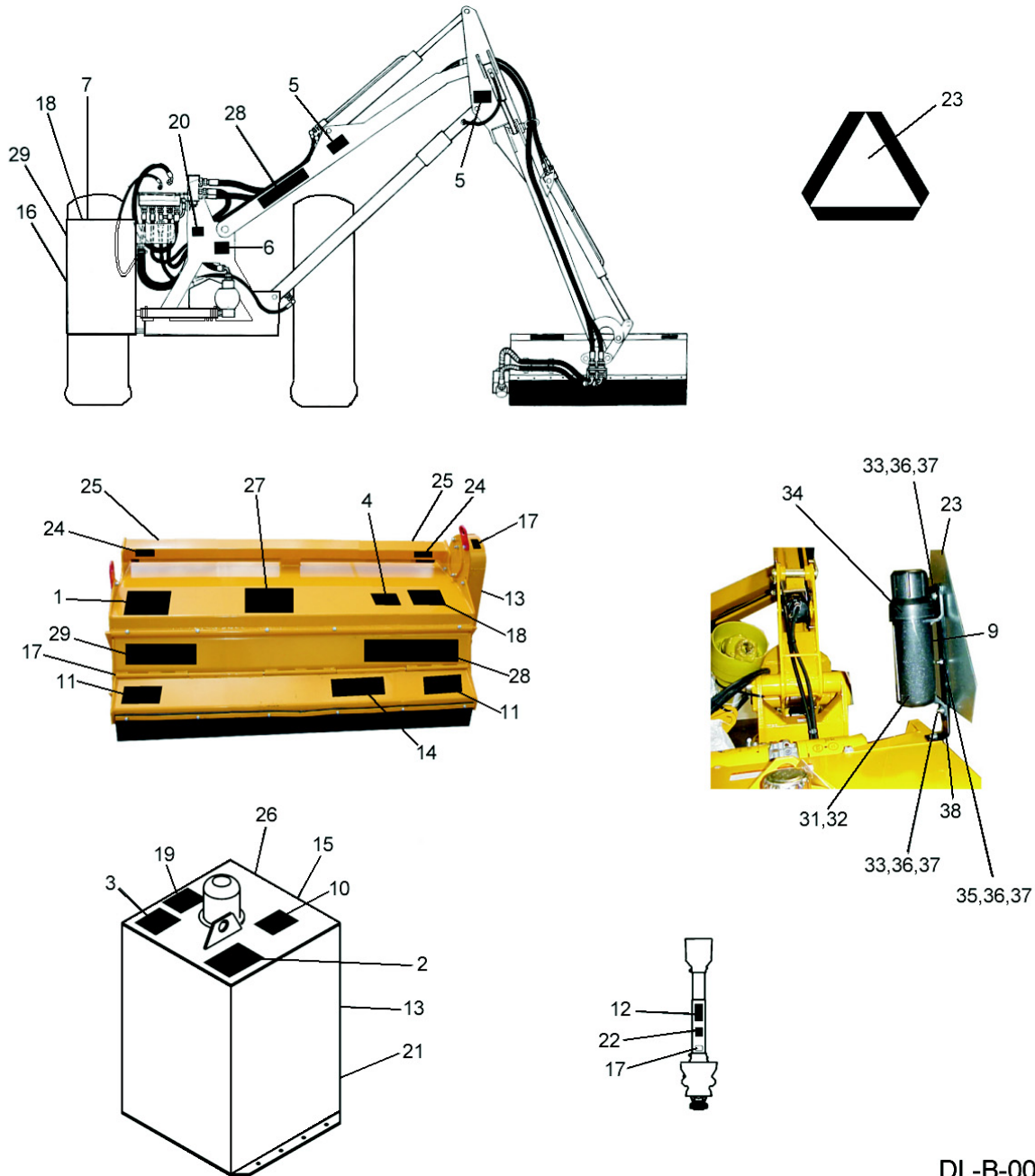

SAFETY

DL-B-0033

# SAFETY

SAFETY

ITEM	PART NO.	QTY	LEVEL	DESCRIPTION
1.	002369	1	DANGER	Multiple Hazard Flail
2.	02958241	1	DANGER	Multiple Hazard Boom
3.	02965262	1	DANGER	Oil Leak/Penetration
4.	02965100	1	INSTRUCT	Use Genuine Alamo Industrial Parts
5.	02962764	2	DANGER	Pinch Points/Scissors
6.	02962765	1	DANGER	Multiple Hazard/Crushing
7.	02965093	1	ATTENTION	Do not over speed engine
8.	00763977	1	NOTICE	Operator's Manual Shipped with Equipment
9.	02977417	1	NOTICE	Operator's Manual Inside
10.	03200437	1	WARNING	Pressurized Tank
11.	00769737	1	DANGER	Keep Away Thrown Objects
12.	00756005	1	DANGER	Rotating Driveline, Entanglement
13.	00756007	1	DANGER	Use/Repair Shields & Guards
14.	00756485	1	DANGER	Blades, Thrown Objects
15.	00756494	1	DANGER	Driveline Hazards
16.	02958241	1	DANGER	Boom Mower Multi-Hazard
17.	000678	3	INSTRUCT	Grease Fitting Inside
18.	000108	1	INSTRUCT	Flail Operating Instructions
19.	02966305	1	INSTRUCT	Use Universal Hyd Oil
20.	1290030	1	INSTRUCT	EP90 Oil in Speed Increaser
21.	00725746	1	PELIGRO	Spanish Warning
22.	D103	1	WARNING	540 PTO
23.	03200347	1	REFLECT	SMV Sign
24.	1458392	2	REFLECT	Red
25.	1458393	2	REFLECT	Amber
26.	00773723	1	PELIGRO	Rotating Driveline Translation
27.	02976881	1	INSTRUCT	Mowing Safety Tips
28.	001651	2	LOGO NAME	Alamo Industrial
29.	001650	1	LOGO	Alamo Industrial
30.	NFS	1	SER PLT	Serial Plate
31.	7191852C	1	_____	PA91 Operator's Manual
32.	02977046	1	_____	AEM Mower Safety Manual
33.	02153100	2	_____	Bolt
34.	00776031	1	_____	Operator's Manual Canister
35.	10058000	1	_____	Bolt
36.	02919924	3	_____	Locknut
37.	00024100	3	_____	Flatwasher
38.	02982492	1	_____	Bracket, Canister

**NOTE:** Alamo Industrial supplies safety decals on this product to promote safe operation. Damage to the decals may occur while in shipping, use, or reconditioning. Alamo Industrial cares about the safety of its customers, operators, and bystanders, and will replace the safety decals on this product in the field, free of charge (some shipping and handling charges may apply). Contact your Alamo Industrial dealer to order replacement decals.

# SAFETY

## Decal Description

Danger! Multi-Hazard Warning. Failing to follow these Safety Messages and Operating Instructions can cause serious bodily injury or even death to operator and others in the area.

P/N 002369



SAFETY

# DANGER

FAILING TO FOLLOW SAFETY MESSAGES AND OPERATING INSTRUCTIONS CAN CAUSE SERIOUS BODILY INJURY OR EVEN DEATH TO OPERATOR AND OTHERS IN THE AREA.

<p>1.</p>	<p>2. NO RIDERS, NO CHILDREN OPERATORS</p>	<p>3. USE SAFETY SHOES, HARD HAT, SAFETY GLASSES, SEAT BELTS, &amp; ROPS</p>	<p>4. BLOCK UP SECURELY BEFORE WORKING UNDER.</p>
-----------	--	--	---

1. Study and understand Operator's Manuals, Safety Signs, and Instructional Decals for tractor & flail mower to prevent misuse, abuse, & accidents. Practice before operating mower in a confined area or near passersby.

- Learn how to stop engine suddenly in an emergency. Be alert for passersby and especially children.

2. Allow no children on or near implement or tractor. Allow no riders on tractor or implement. Falling off can cause serious injury or death from being runover by tractor or mower or contact with Flail Mower Blades.

3. Operate only with tractor having Roll-Over Protective Structure (ROPS) and with seatbelt fastened securely and snugly to prevent injury and possible death from falling off or tractor overturn. Personal Protective Equipment such as Hard Hat, Safety Glasses, Safety Shoes, and Ear Plugs are recommended.

4. Block up or support raised machine and all lifted components securely before putting hands or feet under or working underneath any lifted component to prevent crushing injury or death from sudden dropping or inadvertent operation of controls. Make certain that area is clear before lowering or folding.

5. Before transporting, put Lift Lever in detent or full-lift position. Install Transport Safety Devices securely on folding implements. Slow down when turning and on hillsides.

- Install \*\*Restrictor in folding circuit to slow down lowering and unfolding if action is faster than is desirable.

6. Make certain that SMV sign, Warning Lights, and Reflectors are clearly visible. Follow local traffic codes.

7. Never operate with Flail Mower or Folding Section raised if passersby, bystanders or traffic are in the area to reduce possibility of injury or death from objects thrown by Blades under Shields or implement structure.

8. Before dismounting, secure flail mower in transport position or lower to ground.

- Put tractor in park or set brake, disengage PTO, stop engine, remove key, and wait until noise of rotation has ceased to prevent entanglement in rotating parts which may cause injury or death.
- Never mount or dismount a moving vehicle. Crushing from runover may cause injury or death.

<p>5. TRANSPORT SAFELY, LOCK UP.</p>	<p>6. USE SMV, LIGHTS, &amp; REFLECTORS.</p>	<p>7. DONOT OPERATE WITH MOWER OR WING RAISED.</p>	<p>8. DO NOT MOUNT OR DISMOUNT WHILE MOVING.</p>
--------------------------------------	--	--	--

002369

# SAFETY

**DANGER!** - Multi-Hazard Boom. Take precautions while transporting and operating Boom Unit.

**DANGER**

- EACH REAR WHEEL MUST HAVE A MINIMUM OF 1000 POUNDS CONTACT WITH THE SURFACE TO PREVENT LATERAL INSTABILITY AND POSSIBLE TIPPING OVERBOARD. REAR WHEELS TRACK AND ADD WEIGHTS IF NEEDED. SEE MANUAL OR CALL CUSTOMER SERVICE FOR CORRECTING PROCEDURES.
- TRANSPORT CAREFULLY! SLOW DOWN EVEN MORE ON SLOPES AND WHEN TURNING. NEVER TURN UP A SLOPE SWIFTLY OR UNSUPPORTED AND USE STEER CARE THROUGHOUT HEAVY WEIGHTS TO PREVENT OVERTURN AND POSSIBLE CRUSHING INJURY OR DEATH. IF YOUR VIEW TO THE REAR IS OBSCURED, IT IS YOUR RESPONSIBILITY TO INSTALL MIRRORS THAT PROVIDE A REAR VIEW TO PREVENT ACCIDENTS FROM REVERSE SPOTS.
- REAR MOUNTED BOOM HOMOERS MOVE CENTER OF GRAVITY TO THE REAR AND REMOVE WEIGHT FROM FRONT WHEELS. ADD FRONT BALLAST UNTIL AT LEAST 50% OF TRACTOR WEIGHT IS ON FRONT WHEELS TO PREVENT REARING UP, LOSS OF STEERING CONTROL, AND POSSIBLE INJURY.
- NEVER OPERATE UNIT WITHOUT AN OPS OPERATOR PROTECTIVE STRUCTURE OR CAB TO PREVENT INJURY FROM OBJECTS THROWN FROM ROTATING COMPONENTS. STOP CUTTING IF ANYONE IS WITHIN 100 YARDS.
- KEEP THE BOOM AND OUTRIGGER AT LEAST 1 FEET FROM ELECTRIC LINES AND WIRE LINES TO PREVENT ACCIDENTAL CONTACT AND POSSIBLE SERIOUS INJURY OR DEATH.
- NEVER TRANSPORT THE BOOM DOWN ON A TRUCK OR TRAILER. THE HEIGHT OR WIDTH MAY EXCEED LEGAL LIMITS. CONTACT WITH SIDE OR OVERHANG STRUCTURES OR POWER LINES CAN CAUSE SERIOUS INJURY OR DEATH. ALWAYS LOWER BOOM TO FLOOR OR RAMP AREA OR REMOVE BOOM HEAD TO REDUCE WIDTH TO THE LEGAL LIMITS IF NEEDED. 808804

P/N 02958241

**WARNING!** Failure to INSPECT and REPAIR or REPLACE Hoses may allow worn Hoses to rupture SUDDENLY and VIOLENTLY with resulting serious BODILY INJURY from SCALDING or FIRE with resulting BURN INJURY or DEATH.

**WARNING**

**DO NOT OPERATE EQUIPMENT WITH OIL LEAKS**

- High pressure fluid can be invisible and can be injected into the body through the skin. Serious injury or even death can result. A doctor familiar with this type of injury must surgically remove the injected fluid immediately.
- You should visually inspect for hydraulic fluid leaks before using the equipment. Never use your hand to check for leaks. Wear oil impervious gloves, safety glasses, and use a piece of wood or cardboard to check for evidence of leaks. If you suspect a leak, remove the hose and have it tested at a Dealer.
- Inspect hoses regularly. Frayed, torn, or congealed hoses may rupture suddenly and violently resulting in serious bodily injury from a flying hose end or from scalding, burn injuries, or oil penetration. Oil sprayed on hot equipment or components can result in fire. Repair or replace hoses as indicated to prevent unexpected failure and possible serious injury to operator or bystanders.

KEEP SHIELDS OVER HYDRAULIC COMPONENTS IN PLACE. 0296262

P/N 02965262

**IMPORTANT** - Use only Genuine Alamo Industrial replacement parts.

**IMPORTANT**

For your safety and to guarantee optimum product reliability, always use Genuine ALAMO INDUSTRIAL replacement parts. The use of inferior "will-fit" parts will void Warranty of your ALAMO INDUSTRIAL implement and may cause premature or catastrophic failure which can result in serious injury or death. If you have any questions concerning the repair parts you are using, contact ALAMO INDUSTRIAL, 1502 E. Walnut Seguin, TX 78155 (830) 372-3551.

**ALAMO**  
INDUSTRIAL  
02925100

P/N 02925100

**WARNING!** Pinch Points

**WARNING**

**PINCH POINTS**

02962764

P/N 02962764



# SAFETY

**DANGER!** Crushing and Pinch Points.  
Moving machinery parts can pinch or crush or fall-which may cause injury or death.

P/N 02962765

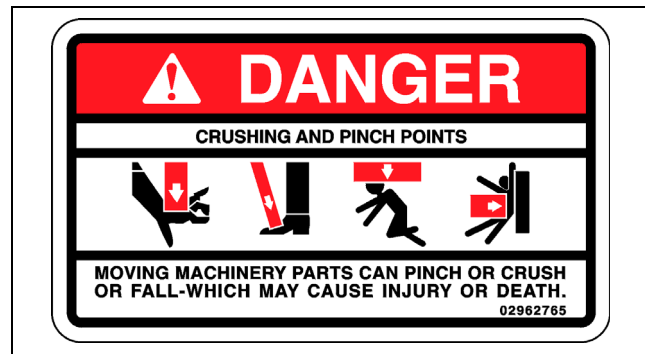

**INFORMATION** - To prevent premature hydraulic component failure, do not over speed the engine. When using the mower attachment, operate tractor at the engine speed which will deliver 540 PTO RPM on Tachometer. Over speeding the engine and pump when operating the mower will overheat and rapidly ruin the oil which will decrease the life of the hydraulic components.

P/N 02965093

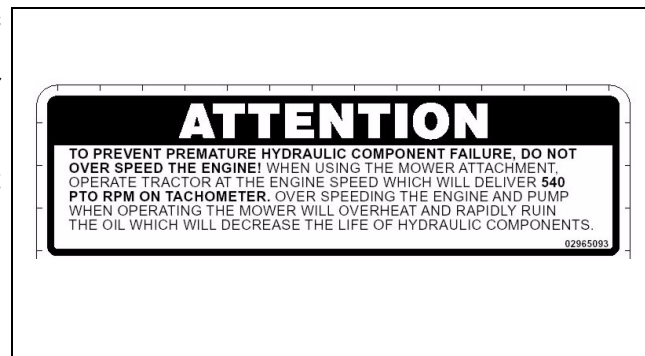

Operator's Manual (with repair parts) and warranty was attached to this implement during final inspection.

P/N 00763977

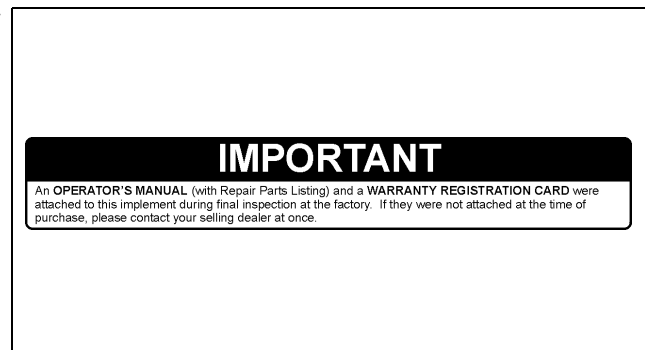

**INSTRUCTIONS** - Read Operator's Manual and Understand, before operating Tractor and Implement.

P/N 02977417



SAFETY

# SAFETY

WARNING: Pressurized Tank

03200437

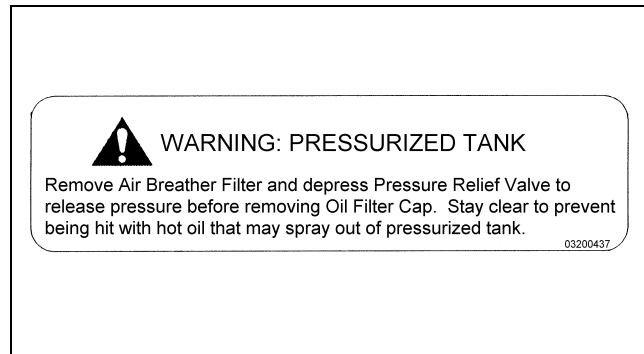

DANGER! Keep Away Thrown Objects.

Inspect the area before mowing for potential mower hazards. Remove or avoid all foreign objects such as wire, cable, metal objects, and all other foreign material.

Foreign material can be thrown from the mower and cause serious bodily injury to the operator and passerby.

Do Not let rotating blades contact solid objects like rocks, posts, curbs or guard rails.

Operate only if all Guards, Deflectors are in place and in good condition.

Do Not operate with Mower or Wing raised off the ground.

Stop mowing if Passersby enter the area of thrown objects. (See Operator's Manual)

Stay away from rotating blades. Keep hands and feet away from rotating blades.

Do Not approach mower until all motion has stopped.

P/N 00769737



DANGER! Rotating Driveline Keep Away, Contact can cause death.

P/N 00756005



# SAFETY

**WARNING!** Keep all safety shielding installed, repaired and replaced when damaged so that machine stays in safe condition.

P/N 00756007

**⚠ WARNING**

WHENEVER THIS MACHINE IS OPERATED IN ANY AREA WHERE THROWN OBJECTS COULD INJURE PERSONS OR PROPERTY, SAFETY SHIELDING MUST BE INSTALLED AND IN GOOD REPAIR TO REDUCE THE POSSIBILITY OF INJURY FROM THROWN OBJECTS.

CHAIN GUARDS, SOLID BANDS, RUBBER FLAPS, AND OTHER GUARDS ARE SUBJECT TO WEAR AND LOST OR BROKEN PIECES. IT IS THE OPERATOR'S RESPONSIBILITY TO SEE THAT THESE ITEMS OF SAFETY EQUIPMENT ARE REPAIRED AND/OR REPLACED AS SOON AS DAMAGE OCCURS, OR YOU WILL BE OPERATING MACHINE THAT IS IN AN UNSAFE CONDITION.

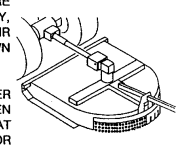

00756007

**DANGER!** Keep Away - Rotating Blades

P/N 00756485

**⚠ DANGER**

CUTTING BLADES      THROWN OBJECTS



FLAIL



ROTARY



FLAIL



ROTARY

**KEEP AWAY - ROTATING BLADES**

SERIOUS INJURY OR DEATH CAN RESULT FROM THROWN OBJECTS OR BLADE CONTACT.

- \* STOP MOWING IF PERSONS ARE NOT CLEAR OF THROWN OBJECTS.
- \* DO NOT STAND ON OR NEAR MACHINE WHEN IN OPERATION.
- \* DO NOT OPERATE WITH DEFLECTORS OR GUARDS REMOVED. 00756485

**DANGER!** Make certain that drivelines are correct length and are securely attached.

P/N 00756494

**⚠ DANGER**

1. MAKE CERTAIN DRIVELINES ARE OF THE CORRECT LENGTH AND SECURELY ATTACHED. DRIVELINE SEPARATION AND/OR PTO STUB SHAFT FAILURE CAN CAUSE INJURY OR DEATH. (See Operator's Manual for procedure.)
2. MAKE CERTAIN THAT DRIVELINE SHIELDS ARE INSTALLED CORRECTLY AND TURN FREELY TO PREVENT INJURY OR DEATH FROM ENTANGLEMENT.
3. MAKE CERTAIN THAT DRIVELINE IS INSTALLED CORRECTLY ON TRACTOR PTO SHAFT. MOVE YOKE BACK AND FORTH UNTIL LOCKING COLLAR CLICKS FORWARD AND LOCKS YOKE IN PLACE.
4. 540 PTO RPM UNLESS SPECIFICALLY MARKED OTHERWISE.

00756494

**DANGER!** - Multi-Hazard Boom. Take precautions while transporting and operating Boom Unit.

P/N 02958241

**⚠ DANGER**

1. EACH REAR WHEEL MUST HAVE A MINIMUM OF 100 POUNDS CONTACT WITH THE SURFACE TO PREVENT LATERAL INSTABILITY AND PRESENT TO USER WITH STABLE REAR WHEEL TRACK AND 400 WEIGHTS IF NEEDED. (SEE MANUAL OR CALL CUSTOMER SERVICE FOR CORRECTNESS PROCEDURE.)
2. TRANSPORT CAREFULLY. SLOW DOWN EVEN MORE ON SLOPES AND WHEN TURNING. NEVER TURN UP A BLADE (SWAY) OR AN OVERHEAD. MAY BE USED FOR PROTECTION OF BARNY VEHICLES TO PREVENT OVERHANG AND POSSIBLE OR SWING INJURY OR DEATH. IF YOUR VIEW TO THE REAR IS BLOCKED IT IS YOUR RESPONSIBILITY TO INSTALL MIRRORS THAT PROVIDE A REAR VIEW TO PREVENT ACCIDENTS AND POSSIBLE INJURY.
3. REAR MOUNTED BOOM MOWERS MUST BE CENTER OF GRAVITY TO THE REAR AND REMOVE WEIGHT FROM FRONT WHEELS. ADD FRONT BALLAST WEIGHT AT LEAST 50% OF TRACTOR WEIGHT ON FRONT WHEELS TO PREVENT REARING UP. LOSS OF STEERING CONTROL AND POSSIBLE INJURY.
4. NEVER OPERATE UNIT WITHOUT AN OPERATOR PROTECTIVE STRUCTURE OR CAB TO PREVENT INJURY FROM OBJECTS THROWN FROM MOWER AND OTHERS THREATENING. STOP CUTTING IF ANYONE IS WITHIN 100 YARDS.
5. KEEP THE BOOM AND CUTTINGHEAD AT LEAST 10 FEET FROM ELECTRICAL LINES AND POWER LINES TO PREVENT ACCIDENTS AND POSSIBLE SERIOUS INJURY OR EVEN DEATH.
6. WHEN TRANSPORTING BOOM MOWERS ON A TRUCK OR TRAILER THE HEIGHT OF MOWER MUST EXCEED LEGAL LIMITS. CONTACT WITH SIDES OR OVERHEAD STRUCTURES OR POWER LINES CAN CAUSE PERSON INJURY OR DEATH. LOWER BOOM TO REDUCE HEIGHT AND ON REVERSE MOWING HEAD TO PREVENT BUMP TO THE LEGAL LIMITS IF NEEDED. 002958241

**SAFETY**

# SAFETY

Information that Grease Fitting is present and must apply grease.



P/N 000678

Instructions to properly lubricate and check mower for potential problems prior to operation.

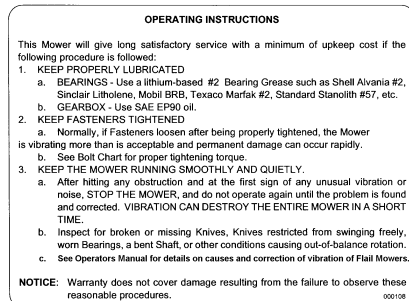

P/N 000108

INFORMATION - Attention - Service Hydraulic System with Universal Tractor Hydraulic Oil. Alamo Group part Number 02966307.

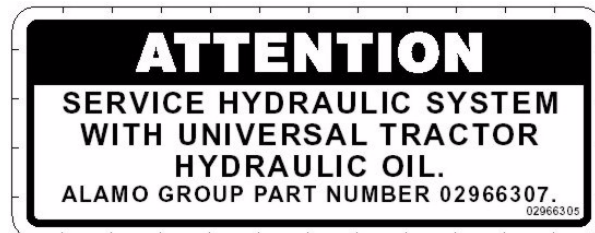

02966305

Peligro Translation, If you do not know how to read English, please find someone who knows how to read English.



P/N 00725746

# SAFETY

WARNING! Avoid Bodily Injury, Use 540RPM PTO Speed Only.

P/N D103



Slow Moving Vehicle Decal. Keep SMV reflector clean and visible. DO NOT transport or operate without the SMV.

P/N 03200347

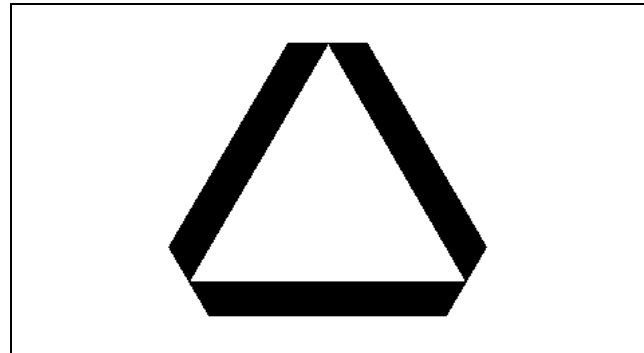

Red Reflector. Keep reflectors clean and visible.

P/N 1458392

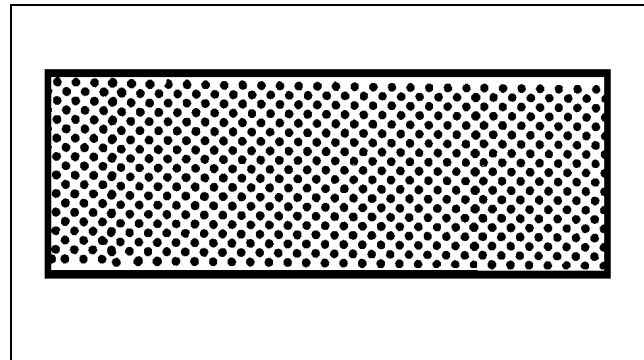

Amber Reflector. Keep reflectors clean and visible.

P/N 1458393

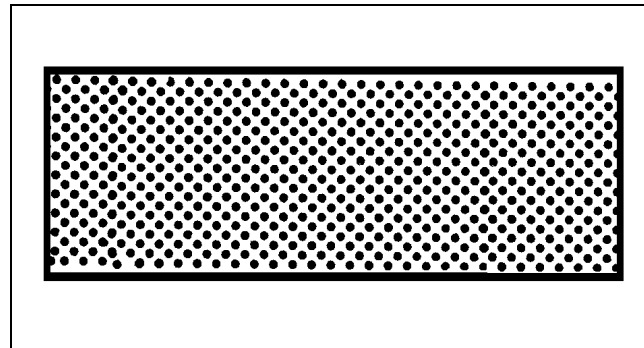

SAFETY

# SAFETY

PELIGRO! Spanish Translation for Driveline Safety



P/N 00773723

ALAMO INDUSTRIAL LOGO



P/N 001651

ALAMO NAME LOGO.



P/N 001650

Read Operator's Manual! The operator's manual is located inside this canister. If the manual is missing order one from your dealer.

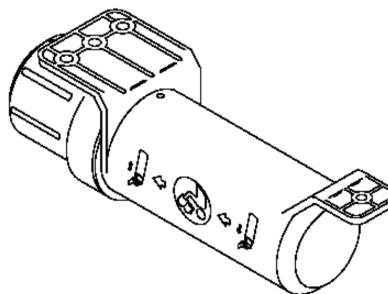

P/N 00776031

# SAFETY

## **Federal Laws and Regulations**

This section is intended to explain in broad terms the concept and effect of federal laws and regulations concerning employer and employee equipment operators. This section is not intended as a legal interpretation of the law and should not be considered as such.

### Employer-Employee Operator Regulations

U.S. Public Law 91-596 (The Williams-Steiger Occupational and Health Act of 1970) OSHA

#### **This Act Seeks:**

"...to assure so far as possible every working man and woman in the nation safe and healthful working conditions and to preserve our human resources..."

#### **DUTIES**

Sec. 5 (a) Each employer-

- (1) shall furnish to each of his employees employment and a place of employment which are free from recognized hazards that are causing or are likely to cause death or serious physical harm to his employees;
- (2) shall comply with occupational safety and health standards promulgated under this Act.
- (b) Each employee shall comply with occupational safety and health standards and all rules, regulations and orders issued pursuant to this Act which are applicable to his own actions and conduct.

#### **OSHA Regulations**

OSHA regulations state in part: "At the time of initial assignment and at least annually thereafter, the employer shall instruct every employee in the safe operation and servicing of all equipment with which the employee is, or will be involved."

### Employer Responsibilities:

To ensure employee safety during Tractor and Implement operation, it is the employer's responsibility to:

1. Train the employee in the proper and safe operation of the Tractor and Implement.
2. Require that the employee read and fully understand the Tractor and Implement Operator's manual.
3. Permit only qualified and properly trained employees to operate the Tractor and Implement.
4. Maintain the Tractor and Implement in a safe operational condition and maintain all shields and guards on the equipment.
5. Ensure the Tractor is equipped with a functional ROPS and seat belt and require that the employee operator securely fasten the safety belt and operate with the ROPS in the raised position at all times.
6. Forbid the employee operator to carry additional riders on the Tractor or Implement.
7. Provide the required tools to maintain the Tractor and Implement in a good safe working condition and provide the necessary support devices to secure the equipment safely while performing repairs and service.
8. Require that the employee operator stop operation if bystanders or passersby come within 25 feet.

### Child Labor Under 16 Years of Age

Some regulations specify that no one under the age of 16 may operate power machinery. It is your responsibility to know what these regulations are in your own area or situation. (Refer to U.S. Dept. of





# INTRODUCTION SECTION

Introduction Section 2-1

# INTRODUCTION

## INTRODUCTION

This trimmer is designed with care and built with quality materials by skilled workers. Proper assembly, maintenance, and operating practices, as described in this manual, will help the owner/ operator get years of satisfactory service from the machine.

The purpose of this manual is to familiarize, and instruct. The Assembly Section instructs the owner/operator in the correct assembly of the Mower using standard and optional equipment. The Parts Listing section is designed to familiarize the owner/operator with replaceable parts on the Mower. This section provides exploded assembly drawings of each mower component illustrating each piece and the corresponding part number.

Careful use and timely service saves extensive repairs and costly downtime losses. The Operation and Maintenance Sections of the manual train the owner/operator how to work the Mower correctly and attend to appropriate maintenance. The Trouble Shooting Guide helps diagnose difficulties with mower and offers solutions to the problems.

Safety is of primary importance to the owner/operator and to the manufacturer. The first section of this manual includes a list of Safety Messages, that, if followed, will help protect the operator and bystanders from injury or death. Many of the Safety Messages will be repeated throughout the manual. The owner/operator/dealer should know these Safety Messages before assembly and be aware of the hazards of operating this mower during assembly, use, and maintenance. The Safety Alert Symbol combined with a Signal Word, as seen below, is intended to warn the owner/operator of impending hazards and the degree of possible injury faced when operating this machine.



**DANGER**

Indicates an imminently hazardous situation that, if not avoided, WILL result in DEATH OR VERY SERIOUS INJURY.



**WARNING**

Indicates an imminently hazardous situation that, if not avoided, COULD result in DEATH OR SERIOUS INJURY.



**CAUTION**

Indicates an imminently hazardous situation that, if not avoided, MAY result in MINOR INJURY.

**Important**

Identifies special instructions or procedures that, if not strictly observed, could result in damage to, or destruction of the machine, attachments or the environment.

# INTRODUCTION

BC-0004

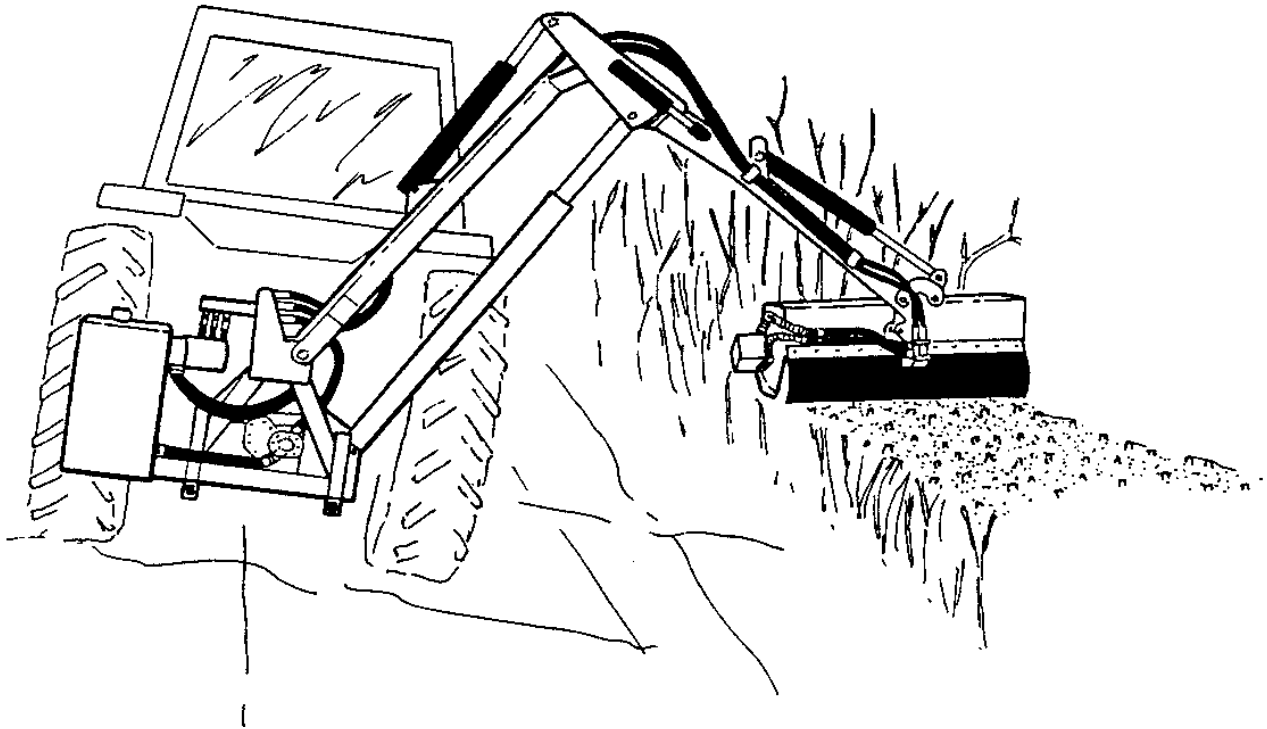

INTRODUCTION

These hydraulically driven flail trimmers are designed for medium-duty work. They can mow pastures and control grass and weeds on highways or industrial sites.

**⚠ DANGER**

For Non-Agricultural use, OSHA, ASAE, SAE and ANSI standards require the use of Chain Guards, Deflectors, or Solid Skirts at all times. The Mower manufacturer strongly recommends the use of Chain Guards, Deflectors, or Solid Skirts for Agricultural purposes as well to reduce the risk of property damage, serious bodily injury, or even death from objects thrown out by or from contact with the Cutting Blades.

**⚠ WARNING**

At least 20% of the tractor's total weight must be on the front tires with the Mower lifted to provide adequate traction for safe steering under good conditions. Slow down on hills, rough terrain, and curves.

Mower Orientation: Front and rear, and left and right are determined by the normal direction of travel (the same as on your automobile).

# INTRODUCTION

## ATTENTION OWNER/ OPERATOR

BEFORE OPERATING THIS MACHINE:

1. Carefully read the Operator's Manual, completely understand the Safety Messages and instructions, and know how to operate correctly both the Mower and Power Unit.
2. Fill out the Warranty Card in full. Be sure to answer all questions, including the Serial Number of the Mower. Mail promptly using the return envelope included with the Operator's Manual.

**NOTE:** Warranties are honored only if completed "Owner Registration and Warranty" forms are received by Alamo Group within thirty days of delivery of the mower.

3. Record the Mower Model and Serial Numbers on the Warranty page at the end of the Operator's Manual. Keep this as part of the permanent maintenance file for the Mower.

# IMPORTANT

For your safety and to guarantee optimum product reliability, always use Genuine ALAMO INDUSTRIAL replacement parts. The use of inferior "will-fit" parts will void Warranty of your ALAMO INDUSTRIAL implement and may cause premature or catastrophic failure which can result in serious injury or death. If you have any questions concerning the repair parts you are using, contact ALAMO INDUSTRIAL, 1502 E. Walnut Seguin, TX 78155 (830) 372-3551.

 **ALAMO**<sup>™</sup>  
INDUSTRIAL

02925100

# ASSEMBLY SECTION

Assembly Section 3-1

# ASSEMBLY

## TRACTOR SELECTION

### Horsepower and Weight Requirements

The Power Arm 91 requires a tractor with a minimum of 30 HP in conjunction with a minimum weight of 1500Kg (1.5 tons imp. 1.6 tons U.S.). If necessary, add ballast to achieve this weight. Check in the tractor's handbook that it does not exceed the maximum allowed.

Bear in mind that these are minimum requirements for optimum working conditions. Tractor selection must take into account the type of terrain upon which it is proposed to operate and the degree of stability required.

### Linkage Requirements

The tractor must be equipped with either CAT I or CAT II linkage.

### Linkage Isolation

Although it may be possible to operate the semi-independent version of the PA91 without linkage isolation, a severe strain would be put upon the attachment yoke and pins. Most modern tractors are equipped with a ready means of providing linkage isolation through a conveniently operated valve.

Linkage isolation is not required on the fully independent model of the PA91 and the tractors hydraulic controls should be neutralized.

### Check Chains/ Stabilizers

To hold the machine firmly in position, check chains or stabilizer bars must be fitted. It is dangerous to operate the machine without these elements.

### Tractor Relief Valve

The main relief valve in the hedger hydraulic control unit is set at 1800 PSI (125 Bar). Therefore, if operating the PA91 in semi-independent form, the tractor's relief valve setting must be at least a little above 1800 PSI for satisfactory operation.

### Tractor Hydraulic Flow Rates

Oil flow rates are not crucial when operating a semi-independent PA91. Flow rates of up to 10 GPM (45 l/min.) should not have any adverse to the inching response that it is sometimes required from the control valve.

### P.T.O. Shaft

Tractor must be equipped with live drive-independent PTO shaft to enable forward movement to be halted while the flail head continues to operate.

### Draft Control

Loads imposed through the draft sensing mechanism will not normally be sufficient to put a strain on the tractor. However, any provision for draft control should be set to minimum response. Where a draft control rocker is fitted with a dead pin this should be utilized.

# ASSEMBLY

## TRACTOR PREPARATION

### Fitting Operator Guard

A tractor fitted with a cab that has a safety glass windows should be used whenever possible. This is a basic safety precaution applicable to the use of all flail-type hedge trimmers.

Power arms are supplied with an operator guard kit (Part No. 73 13 324) which must be fitted to the tractor before commencing work.

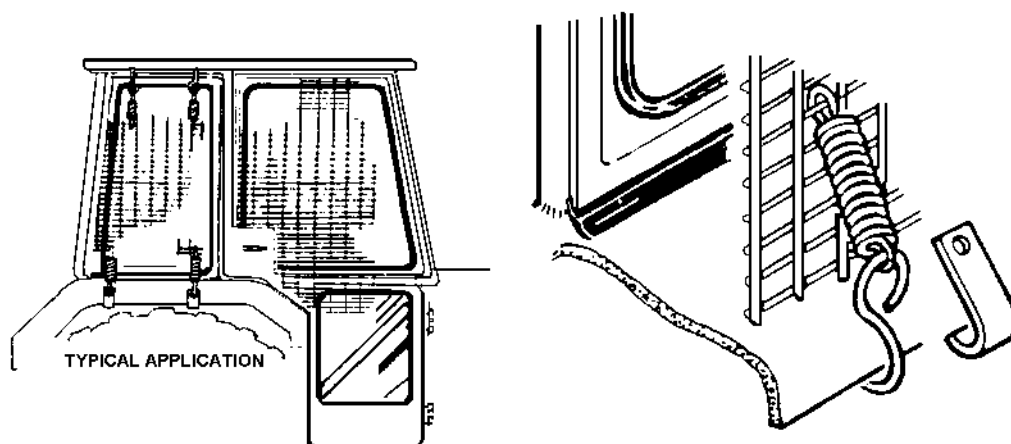

ASM-FL-0092

It consists of two areas of wire mesh which can be shaped to suit and be secured against the cab window with a spring loaded hooks; the upper edge being anchored around the cab gutter and the lower edge around the mudwing.

According to the great range of cabs, it may be necessary to adapt or make brackets to secure the mesh.

If the flail is operated on a tractor that is equipped with a safety frame or roll bar only, an additional frame must be made and fixed to the tractor onto which the guard mesh can be secured. In addition to the guard mesh, a sheet of Polycarbonate transparent glazing must be fitted to the frame to provide further operator protection. This material must also be used when the cab does not have safety glass installed.

The operator guard kit supplied is suitable for all standard applications; i.e., rear mounted on a conventional tractor. For other applications, additional mesh guarding may need to be constructed to give adequate operator protection. A guideline to follow when assessing any additional guarding that may be required is that the operator must always be looking at the flail head through the mesh when it is in any working position.

Polycarbonate transparent sheeting is an impact resistant material which can be readily sawed and shaped according to requirements. Unfortunately, it is susceptible to surface damage and scratching. Therefore, it is advisable to place the material on the inside of the window for protection. No attempt should be made to wipe the sheeting with dirt ingrained cloth.

Toughened grades of polycarbonate sheeting are available under the brand names of "Makrolon", "Tuffak" and "Lexan".

In case of difficulty in obtaining this material locally, contact F.W. McConnell Ltd. through your normal dealer.

# ASSEMBLY

## Ballast Weight

Tractor must be stable while operating the hedge cutters under all conditions. Pay attention when operating on slopes. Front end ballast as well as rear wheel weights to counterbalance the overhang of the flail head should be added as appropriate. On steeply banked ground, it may not be sufficient to depend alone on the counterweight provided by the oil reservoir.

In addition, rear wheel track should be set as wide as possible to increase stability. It will also increase the protection to the reservoir.

## JOHN DEERE CONVERSION KIT (81- 30- 059)

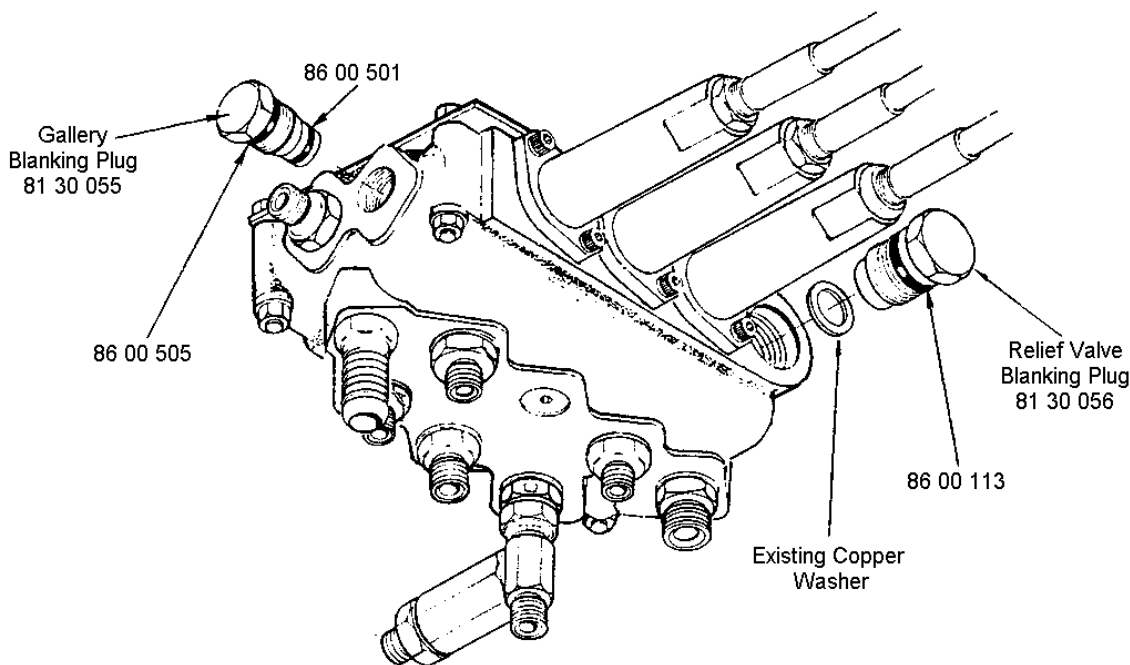

ASM-FL-0093

The John Deere utilizes a “closed center” hydraulic principle and because of this, it is recommended to use trimmers with a fully independent hydraulic system on tractors of this manufacture. However, it is practicable for the semi independent model of the PA91 to be used with these. Tractors subject to certain modifications. There are the following two alternatives.

1. A flow limiting valve manufactured by John Deere is available to provide an “open center” external supply sufficient for PA91 requirements. For further advice consult your John Deere dealer.
2. Components are available from F.W. McConnel Ltd. to convert the standard “open center” valve. Part No. 81-30-059 consists of a relief valve blanking plug which should be installed in place of existing relief valve. Be careful when extracting the relief valve not to damage the copper sealing washer as it is reused with the blanking plug. In addition, a pressure gallery blanking plug is installed in place of the standard blanking plug at the valve outlet end next to the lift ram gland connection.

When working in this mode, the tractor’s pressure control valve must not exceed 1800 PSI (125 Bar).



# ASSEMBLY

## DELIVERY

1. The machine is delivered in a partially dismantled condition. To make ready for attachment to the tractor it will be necessary to select a hard level surface
2. Cut the banding straps and remove the attached articles.
3. Fill the reservoir to capacity with oil selected from the chart on Section 3-9 to increase the stability of the machine.
4. Remove and discard the transport strap connecting the flail head to the frame and also the lift ram stop strapped to the rod.

## ATTACHMENT TO TRACTOR

### Si Model

1. On Si model, drive the tractor up as closely as possible and connect the return and supply hoses to the tractor. Fit suitable return connection to the tractor and connect the return hose before connecting the supply hose to the tractors external services point with a suitable self seal coupling.

\*With the aid of a crowbar prise the flail head sideways until there is sufficient clearance to allow the tractor to be driven up and the draft links connected. Assistance will be needed to simultaneously select "Reach out" and "Angle down" to allow the oil to flow while the arms are being moved.



As a safety precaution, to prevent the possibility of the flail head slipping sideways and the arm collapsing on the fitter as the head is pried sideways, a loop of strong rope or wire with sufficient slack to allow the required flail head movement should connect the frame and dipper. This will then act as a stopper in the event of this happening. Leave in position until attachment is complete.

2. Swing up the linkage plate and fix securely in position with the nut and bolt provided.
3. Adjust tractor drop arms to enable the draft links to lower within 15 ins (375 MM.) of the ground.
4. Remove the top link and machine yoke completely.
5. Reverse the tractor squarely to the front of the machine, engage draft link pins and secure.
6. Attach yoke to the top hitch position on the tractor ensuring the lug for the top link is uppermost.
7. Unlimber the machine controls from its storage position and fit into the tractor cab.
8. Install the top link between the yoke and upper hitch position on the machine. If necessary, fit Cat I sleeves into the ball ends of the top link.

\*Raise the machine on its three point linkage to the working height, i.e. when the PTO shaft and the gearbox stub shaft are (as near as possible) in a straight line.



Do not operate quadrant lever of machine controls through the rear cab window while standing on or amongst linkage components. Always seek assistance.

\*Measure the PTO drive shaft length as shown in diagram below and subtract 1 inch (25 MM.).

# ASSEMBLY

## ASSEMBLY

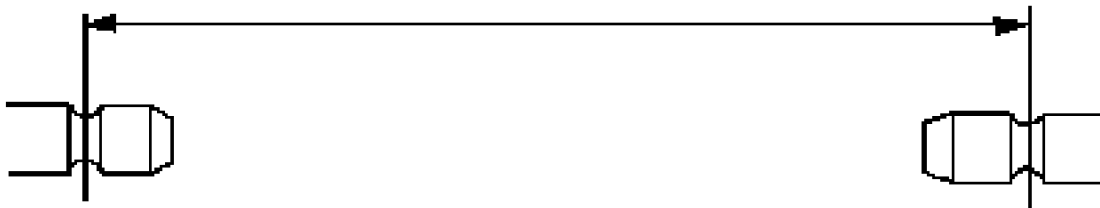

ASM-FL-0094

\*This measurement which is the fully closed final length of the PTO drive shaft measured button to button should be taken carefully before the PTO drive shaft is shortened to suit by cutting off both the driving and driven members of the tube by an equal amount. Likewise, the plastic shield will similarly have to be cut. Take heed if too much is cut, it cannot be stuck back on. Measure twice and cut once. Accurate measurement is important on some close coupled tractors to ensure maximum engagement during operation.

9. Lower the machine to the ground and fit the PTO shaft in position. Ensure that the collar locking devices on the PTO shaft are fully engaged. Wrap the torque chain around the tractor drawbar or any convenient point to prevent the shaft guard from rotating.
10. Raise the machine to working height.

### Ti Model

1. Check that the rotor control valve is in the STOP position.
  2. With PTO engaged on Ti model or with tractor external services activated on Si model, select "Lift Down". This will level the frame and enable the lower yoke pins to be fitted. Select the hole which will, as near as possible position the PTO shaft horizontally in line.
  3. Lower the quadrant lever so that the machines weight is taken by the yoke.
  4. Adjust the top link to bring the pillar upright.
- \*Remove the rope arrestor loop.
5. Carry out final adjustment of the tractor lift arm leveling box to bring the main frame horizontal. This should be checked with the arms at approximately half reach with the flail head clear of the ground.
  6. Tighten up the check chains or adjustable stabilizers to hold the machine rigid without side-sway.
  7. Raise the parking feet in their sockets and secure in the transport position.
  8. Carefully operate the machine through its full range of movement while checking that the hoses are not strained, pinched, chaffed or kinked and that all movements are functioning correctly.
  9. Assemble the front hood to the flail head.
  10. Fold the machine into the transport position.
  11. The machine is now ready to proceed to the work site.

# ASSEMBLY

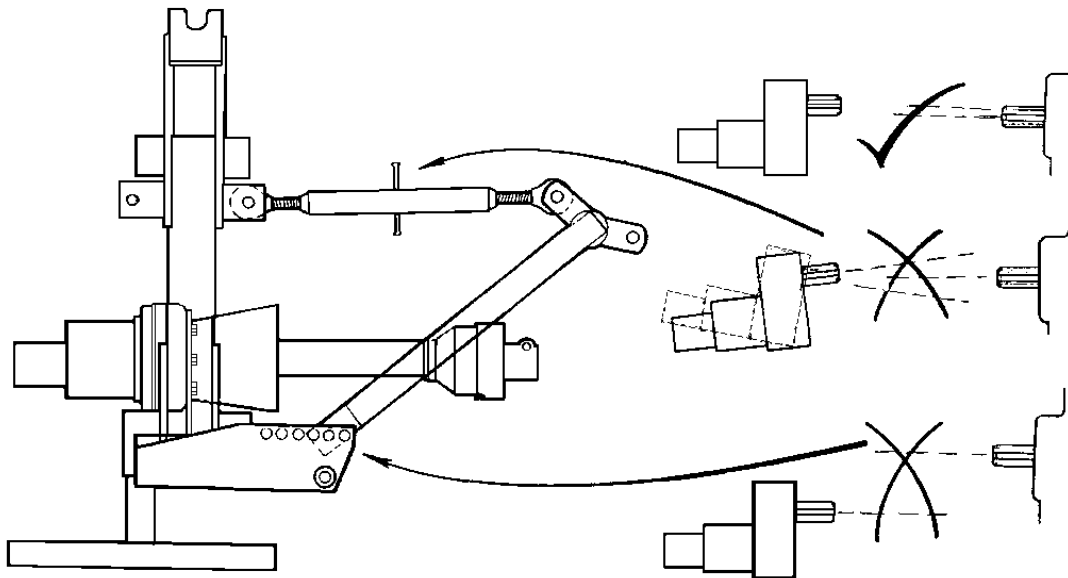

ASM-FL-0095

ASSEMBLY

This procedure is for initial attachment only, for subsequent attachment paras marked \* do not apply. If it is required to mount the machine on a different tractor, bear in mind that the engagement of the PTO shaft will alter. A safe minimum engagement between the two halves of the shaft is 6". This dimension must be checked before work is commenced.

# ASSEMBLY

## FITTING CONTROL UNIT IN CAB

The 3 lever control unit which is cable operated is mounted on an adjustable stalk that is attached to a seat bracket which is of universal design for mounting in many models of tractor. The bracket is normally trapped between the seat runners and their mounting base. It may sometimes be necessary to drill extra holes in the seat bracket to find the ideal operator position.

On tractors other than quiet cab models, it is permissible to attach the control unit to the mudwing or the cladding or the cab, observing the precaution that no structural member of the safety frame should be drilled. For this purpose, the mounting stalk can be bent round in a "U" shape.

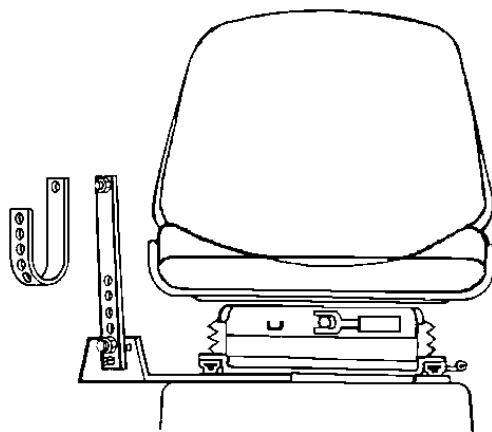
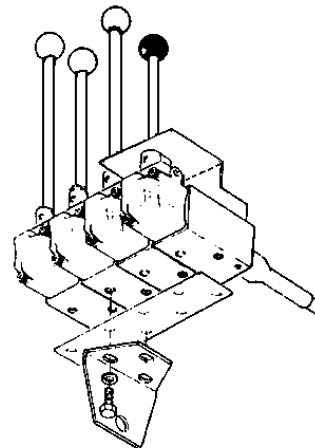
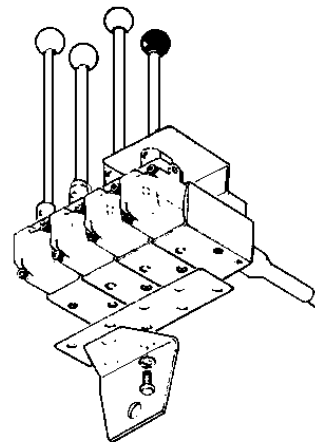

Illustration shows T1 model.  
Rotor control lever can be mounted  
on either end of main controls.



ASM-FL-0096

The control unit itself is bolted to an angled mounting bracket in either a transverse or longitudinal position thus giving a variety of mounting position, which in conjunction with flexibility of the mounting pillar will enable a satisfactory working position to be achieved.

Shown above is detail of alternative fitting of the mounting spigot. In deciding the final of the control box, remember that tight bends in the cables will reduce their operational life. Do not exceed the minimum acceptable bend radii of 8".

The handles may be screwed into alternative holes in the levers to give an "in line" installation should it be desirable.

# ASSEMBLY

## OIL REQUIREMENTS

### Tank

The machine is delivered from the factory without oil. Fill the reservoir with a light hydraulic oil as recommended in the chart until the oil level is approximately 2" below the top of the tank. The total capacity is approximately 117 tires (25 gallons). Do not overfill. The oil must have anti-frothing characteristics suitable for use in hydraulic systems.

Supplier	Cold or Temperature Climate	Hot Climate
Castrol	Agricastrol hydraulic oil Hy-spin AWS32	Hy-spin AWS68
Shell	Tellus 32	Tellus 68
Mobil	D.T.E. 25	D.T.E. 26
Esso	Nuto "H" or "A" 32	Nuto "H" or "A" 68
Texaco	Rando HD 32	Rando HD 68
Gulf	Hydrasil 32	Hydrasil 32
B.P.	Energal HLP 32	Energal HLP 68
Dalton	Silkolene Dove 32 or Derwnet 32	Silkolene Dove 68
Elf	Hydrelf 32	Hydrelf 68
ISO VG	32	68
SAE	10W	20

### Gearbox

Check the gearbox oil level. On level ground, gearbox should be filled until oil is in visible level with the lip of the filler plug aperture. Do not attempt to fill by removing the breather as the depth of tapped thread in the casing is insufficient to allow repeated loosening and tightening of the breather plug at this point. The gearbox capacity is 700 milliliters (1-1/4 pint), use EP 90 gear oil.

# ASSEMBLY

## RUNNING UP PROCEDURE

### PA91 Ti

1. Ensure that the rotor control is in "STOP" position, start the tractor, engage PTO and allow the oil to circulate for about 5 minutes without operation of the armhead control lever. This will allow all the oil to circulate thoroughly through the return line filter.
2. Operate the armhead levers through their complete range ensuring that all movements are functioning correctly.
3. Place the flail head at a safe attitude and move the rotor control to "ON" position. After initial fluctuation due to priming, the rotor should settle to a steady speed. Increase PTO speed to approximately 360 RPM and run for a further five minutes before engaging and stopping tractor. Check the hose runs and observe that they are free from any pinching, chafing, straining or kinks. Recheck the oil level in the tank and top up as necessary.

### PA91 Si

1. Ensure PTO lever is in neutral position, and isolate tractor hydraulic linkage. Start the tractor and select external service supply on the hydraulic controls. Allow the tractor to run for several minutes before attempting to operate any of the machine control levers.
2. While operating, move the levers through their complete range ensuring that all movements are functioning correctly.
3. Check the tractor rear axle oil level and top up if necessary.
4. Place the flail head at a safe attitude and bring tractor engine revolutions to 1000 RPM to avoid stalling when the starting load is placed on the motor. Engage PTO and allow the rotor to run for several minutes. Do not leave the tractor cab or allow anyone to approach the flail head at this time.



Do not allow the pump to continue working if the rotor does not turn. Overheating and serious pump damage to the pump can be caused in a very short time.

5. After running up the machine, increase PTO speed to approximately 360 RPM. Run machine further for five minutes before disengaging the PTO and stopping tractor. The reason for this running period under a no load condition is to thoroughly circulate the oil in the reservoir through the return line filter.
6. Check the hose runs and observe that they are free from any pinching, chafing, straining or kinks. Recheck the oil level in the tank and top up as necessary.

# ASSEMBLY

## REMOVAL FROM TRACTOR

1. Select a firm level site for parking the machine.
2. Lower the parking legs and secure.
3. Operate the hydraulic service to place the arms at 1/2 to 3/4 reach and with the flail head roller horizontal and level with the bottom of the parking feet.
4. Disengage tractor PTO and remove.
5. Disconnect stabilizers bars or loosen check chains as applicable.
6. Unbolt the control unit from the mounting pillar, remove from tractor cab and stow in a suitable location clear of the ground. On Si models only, the supply and return hoses must be disconnected from the tractor and stowed with their ends covered and clear of the ground.
7. Raise the machine on the tractor's linkage to take the weight off the yoke and remove the lower yoke bolts.
8. Lower the tractor draft links and place machine firmly on the ground.
9. Remove draft links and top link from the machine, drive tractor away and remove yoke. Blank off the end of the return hose with plug or small plastic bag if a self-seal coupling is not fitted.

## STORAGE

If machine is to be left standing for an extended period of time, lightly coat the exposed portions of the ram rods with grease. Subsequently, this grease which becomes contaminated with dust and grit should be wiped off before the rams are next moved.

If the machine has to be stored outside, tie a piece of tarpaulin or canvas over the control assembly. Do not use a plastic fertilizer bag which could lead to rapid corrosion.

# ASSEMBLY



## PROPER TORQUE VALUES FOR FASTENERS

The chart lists the correct tightening torque for fasteners. When bolts are to be tightened or replaced, refer to this chart to determine the grade of bolts and the proper torque except when specific torque values are assigned in manual text.





RECOMMENDED TORQUE IN FOOT POUNDS UNLESS OTHERWISE STATED IN THE MANUAL\*

**NOTE:** These values apply to fasteners as received from supplier, dry or when lubricated with normal engine oil. They do not apply if special graphitized or molydisulphide greases or other extreme pressure lubricants are used. This applies to both UNF fine and UNC coarse threads.

Proper Torque values for bolts that are measured in Inches

Bolt Diameter			
	Head Marking No Marks Grade Two Pound - Foot Value Dry	Head Marking Three Lines Grade Five Pound - Foot Value Dry	Head Marking Six Lines Grade Eight Pound - Foot Value Dry
1/4"	5.5	9	12.5
5/16"	11	18	26
3/8"	20	33	46
7/16"	32	52	75
1/2"	60	80	115
9/16"	70	115	160
5/8"	100	160	225
3/4"	175	280	400
7/8"	175	450	650
1"	270	675	975
1-1/8"	375	850	1350
1-1/4"	530	1200	1950
1-3/8"	700	1550	2550
1-1/2"	930	2100	3350

Proper Torque values for Metric bolts

Bolt Diameter				
	Head Marking 4.8 Pound - Foot Value Dry	Head Marking 8.8 or 9.8 Pound - Foot Value Dry	Head Marking 10.9 Pound - Foot Value Dry	Head Marking 12.9 Pound - Foot Value Dry
6mm	4.5	8.5	12	14.5
8mm	11	20	30	35
10mm	21	40	60	70
12mm	37	70	105	120
14mm	60	110	165	190
16mm	92	175	255	300
18mm	125	250	350	410
20mm	180	350	500	580
22mm	250	475	675	800
24mm	310	600	850	1000
27mm	450	875	1250	1500
30mm	625	1200	1700	2000

\*To get Newton-Meters multiply pound-foot of torque by 1.356



# OPERATION SECTION

Operation Section 4-1

# OPERATION

## ALAMO INDUSTRIAL POWER ARM 91 OPERATING INSTRUCTIONS

Alamo Industrial Interstater flail mowers are manufactured with quality material by skilled workers. These mowers are designed for cutting grass and small weeds. The mower is equipped with protective deflectors to prevent objects being thrown from the mower by the blades, however, no shielding is 100% effective. All shields, guards, and deflectors equipped on the mower must be maintained in good operational condition.

It is the operator's responsibility to be knowledgeable of all potential operating hazards and to take every reasonable precaution to ensure oneself, others, animals, and property are not injured or damaged by the mower, tractor, or a thrown object. Do not operate the mower if passersby, pets, livestock, or property are within 100 yards of the unit.

This section of the Operator's Manual is designed to familiarize, instruct, and educate safe and proper mower use to the operator. Pictures contained in this section are intended to be used as a visual aid to assist in explaining the operation of a Interstater flail mower and are not specific to any model. Some pictures may show shields removed for picture clarity. NEVER operate implement without all shields in place and in good operational condition. The operator must be familiar with the mower and tractor and all associated safety practices before operating the mower and tractor. Proper operation of the mower, as detailed in this manual, will help ensure years of safe and satisfactory use of the mower.

**IMPORTANT:** To avoid mower damage, retorque all bolts after the first 10 hours of operation. Refer to the Torque Chart at the end of the Maintenance Section to ensure bolts are properly tightened.

**READ AND UNDERSTAND THE ENTIRE OPERATING INSTRUCTIONS AND SAFETY SECTION OF THIS MANUAL AND THE TRACTOR MANUAL BEFORE ATTEMPTING TO USE THE TRACTOR AND IMPLEMENT.** If you do not understand any of the instructions, contact your nearest authorized dealer for a full explanation. Pay close attention to all safety signs and safety messages contained in this manual and those affixed to the implement and tractor. *OPS-U- 0001*

READ, UNDERSTAND, and FOLLOW the following Safety Messages. Serious injury or death may occur unless care is taken to follow the warnings and instructions stated in the Safety Messages. Always use good common sense to avoid hazards. (SG-2)

**SAFETY INSTRUCTIONS**



**PELIGRO**

Si no lee ingles, pida ayuda a alguien que si lo lea para que le traduzca las medidas de seguridad. (SG-3)

**¡ LEA EL INSTRUCTIVO!**



# OPERATION

## **1. Standard Equipment and Specifications**

### **Standard Specifications**

Welded Tubular Frame  
CAT I or CAT II Three Point Hitch  
24-Gallon Reservoir with 12 Micron Filtration  
Self-Contained Hydraulics  
Hydraulic Breakaway  
3-Spool Valve with Work Port Reliefs  
1-1/2" King Post  
Inner Boom Arm Tubing: 4" x 4" x 3/16"  
Outer Boom Arm Tubing: 4" x 4" x 1/4"  
Boom Reach: Up - 12'10", Out - 12'8", Do n- 7'10"  
Safety Cage (ROPS Units Only)  
Weight Approx. 1,900 lbs (excluding cutting head)

### **Head Specifications**

39" Flail Head with 20 Drop-Forged, Double-Edged Knives  
11- Gauge Top Deck with 1/4" Side Skirts  
3 - 1/16" x 5/16" Wall Cutter Shaft with 2 - 3/16" Bearings  
Motor to Cutter Shaft is Direct Drive  
Front & Rear Safety Deflectors

# OPERATION

## 2. OPERATOR REQUIREMENTS

Safe operation of the unit is the responsibility of a qualified operator. A qualified operator has read and understands the implement and tractor Operator's Manuals and is experienced in implement and tractor operation and all associated safety practices. In addition to the safety messages contained in this manual, safety signs are affixed to the implement and tractor. If any part of the operation and safe use of this equipment is not completely understood, consult an authorized dealer for a complete explanation.

If the operator cannot read the manuals for themselves or does not completely understand the operation of the equipment, it is the responsibility of the supervisor to read and explain the manuals, safety practices, and operating instructions to the operator.

Safe operation of equipment requires that the operator wear approved Personal Protective Equipment (PPE) for the job conditions when attaching, operating, servicing, and repairing the equipment. PPE is designed to provide operator protection and includes the following safety wear:

### PERSONAL PROTECTIVE EQUIPMENT (PPE)

- Protective Eye Glasses, Goggles, or Face Shield
- Hard Hat
- Steel Toe Safety Footwear
- Gloves
- Hearing Protection
- Close Fitting Clothing
- Respirator or Filter Mask (depends on operating conditions) *OPS-U- 0002*

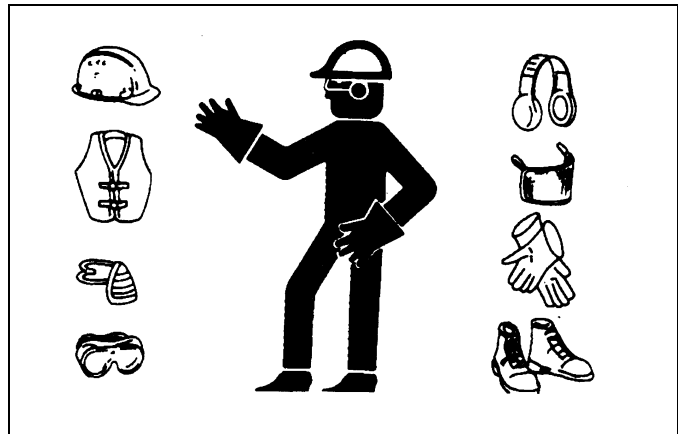

### **▲ DANGER**

NEVER use drugs or alcohol immediately before or while operating the Tractor and Implement. Drugs and alcohol will affect an operator's alertness and coordination and therefore affect the operator's ability to operate the equipment safely. Before operating the Tractor or Implement, an operator on prescription or over-the-counter medication must consult a medical professional regarding any side effects of the medication that would hinder their ability to operate the Equipment safely. NEVER knowingly allow anyone to operate this equipment when their alertness or coordination is impaired. Serious injury or death to the operator or others could result if the operator is under the influence of drugs or alcohol. (SG-27)

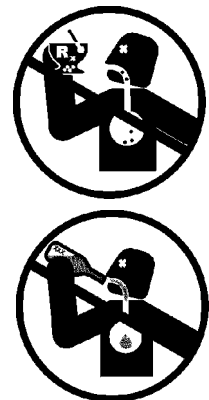

# OPERATION

## 3. TRACTOR REQUIREMENTS

In addition to tractor horsepower and size required to operate the mower unit, the tractor must also be properly equipped to provide operator protection, to alert approaching vehicle drivers of the tractor's presence, and to ensure tractor stability when mowing with the boom fully extended.

### Tractor Requirements and Capabilities

- ASAE approved Roll-Over Protective Structure (ROPS) or ROPS cab and seat belt.
- Tractor Safety Devices ..... Slow Moving Vehicle (SMV) emblem, lighting, PTO master shield
- Tractor Horsepower-Minimum ..... 35 - 55 hp
- Tractor Weight ..... 1500 KG
- Hitch ..... Three-point Hitch
- Hydraulics ..... Fully independent or Semi-independent hydraulic system
- Power Take Off ..... 540 RPM

### 3.1 ROPS and Seat Belt

The tractor must be equipped with a Roll-Over-Protective-Structure (ROPS) (tractor cab or roll-bar) and seat belt to protect the operator from falling off the tractor, especially during a roll over where the driver could be crushed and killed. Only operate the tractor with the ROPS in the raised position and seat belt fastened. Tractor model not equipped with a ROPS and seat belt should have these life saving features installed by an authorized dealer. *OPS-U- 0003*



Operate this Equipment only with a Tractor equipped with an approved roll-over-protective system (ROPS). Always wear seat belts. Serious injury or even death could result from falling off the tractor--particularly during a turnover when the operator could be pinned under the ROPS. (SG-7)



### 3.2 Operator Thrown Object Protection

The tractor must be equipped with protective equipment to shield the operator from falling and thrown objects. For cab tractors, the tractor must be equipped with an operator safety screen on its right side or the right side windows must be fitted with a shatter proof safety window. For non-cab tractors, the tractor must be equipped with a ROPS and operator protective safety cage that provides protection to the right and above the operator seat. DO NOT remove the ROPS from non-cab tractors to equip a safety cage.

*OPS-B- 0001\_A*



# OPERATION



Never operate the Tractor and Mower Unit without an OPS (Operators Protective Structure) or Cab to prevent injury from objects thrown from ground or from overhead trimming. Stop mowing if workers or passersby are within 100 yards. (SBM-9)

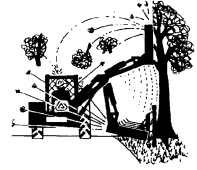

## **3.3 Tractor Lighting and SMV Emblem**

If the tractor will be operated near or traveled on a public roadway it must be equipped with proper warning lighting and a Slow Moving Vehicle (SMV) emblem which are clearly visible from the rear of the unit. Most tractor's have different settings for operating and transporting lighting. Refer to the tractor operator's manual for using the tractor's light switch and operating the turn signals.

*OPS-B- 0017*



# OPERATION

## 3.4 Tractor Ballast

To ensure tractor stability when operating on flat surfaces the left rear tractor tire MUST exert a minimum down force (weight) of 1500 lbs. on the ground when the tractor is on level ground, its boom is fully extended and the mower head is horizontal and two feet above the ground. For units which have the ability to operate on either side of the tractor, these requirements must also be met for the right side tire when the boom is extended to the left side as described above. A tractor that does not meet this criteria is DANGEROUS and should not be operated as upset of the unit can occur resulting in possible serious injury and property damage. NOTE: All factory mounted units are tested and meet the ballast requirement before shipment; further testing is not required unless the unit is operated in a manner other than what is considered standard operating conditions.

For additional information on properly ballasting the tractor, refer to Alamo Industrial Tractor and Mower Stability Pamphlet P/N #02959010

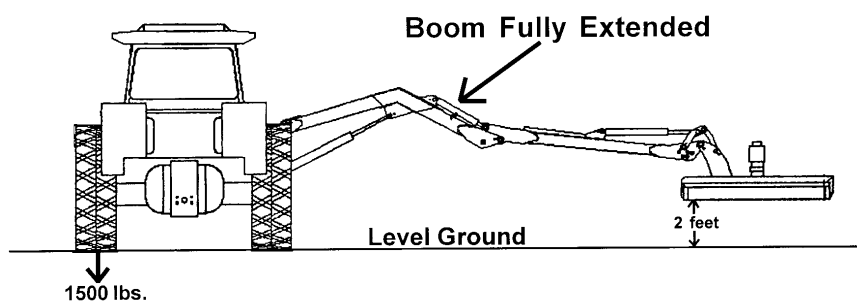

Op-71

If the unit is operated on slopes greater than 5°, additional counterweight will be required. Operation of the unit on slopes greater than 11 percent (6.4 degrees) is not recommended under any circumstances. On a tractor with a 96" outside to outside tire spread, an 11 percent (6.4 degrees) slope occurs when one rear tractor tire is about 8" lower than the other rear tire. OPS-B- 0018

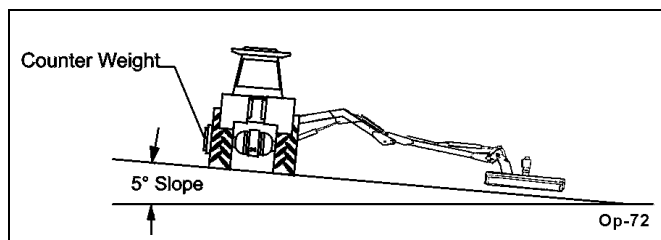

## 3.5 Tractor Safety Devices

If transporting or operating the tractor and implement near a public roadway, the tractor must be equipped with proper warning lighting and a Slow Moving Vehicle (SMV) emblem which are clearly visible from the rear of the unit. Lights and a SMV emblem must be equipped directly on implements if the visibility of the tractor warning signals are obscured.

Maintain all manufacturer equipped safety shields and guards. Always replace shields and guards that were removed for access to connect, service, or repair the tractor or implement. Never operate the tractor PTO with the PTO master shield missing or in the raised position. OPS-U- 0004

## 3.6 Tractor Horsepower

The horsepower required to operate the mower depends on many factors including vegetation to be cut, terrain condition, operator experience, and condition of the mower and tractor. For most mowing condition, the PA91 flail trimmer requires a tractor with at least 65 HP. Operating the mower with a tractor that does not have adequate power may damage the tractor engine.

# OPERATION

## 3.7 3-Point Hitch

PA91 boom mowers can attach to tractors with either a CAT I or II hitch. Refer to the tractor operator's manual for the category of the tractor used. If the hitch does not conform to ASAE Cat I or II dimensions, the mower may not fit or raise properly. Consult an authorized dealer for possible modification procedures to mount nonconforming hitches.

Use the correct hitch pins for the hitch category being used. For a Cat I hitch, 7/8" lower and 3/4" upper diameter hitch pins are used and Cat II hitches require 1-1/8" lower and 1" upper diameter hitch pins.

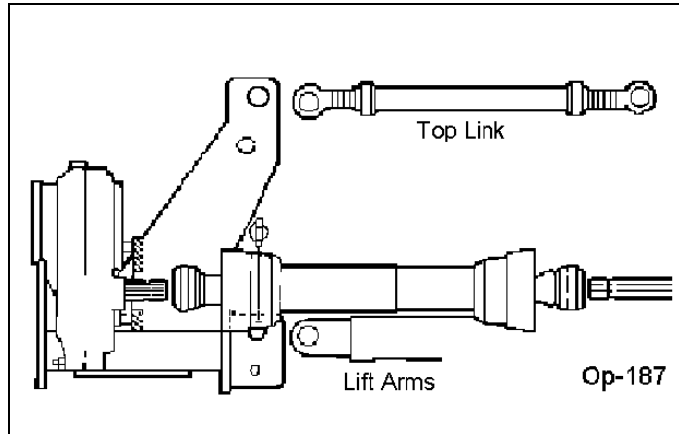

### CAT I Implement / Hitch Specification

Width from outside to outside A-frame.....	26 7/8"
Quick Hitch width inside lug to lug .....	27 1/8"
Height from bottom hitch pin to top pin .....	18"
Lower pin diameter .....	7/8"
Upper pin diameter .....	3/4"
Lynch pin diameter .....	15/32"

### CAT II Implement/ Hitch Specification

Width from outside to outside A-frame .....	32-3/8"
Quick Hitch width inside lug to lug.....	33-5/8"
Height from bottom hitch pin to top pin.....	19"
Lower pin diameter.....	1-1/18"
Upper pin diameter.....	1"
Lynch pin diameter .....	15/32"

## 3.8 Hydraulics

The PA91 is available with either a Semi or Totally Independent hydraulic system complete with rotor rotation control. The semi-independent system takes its power from the tractor external hydraulic supply while the fully independent system is operated by an extra lever on the control console, which allows selection of rotor rotation.

## 3.9 Front End Weight

A minimum of 20% total tractor weight must be maintained on the tractor front end at all times. Front end weight is critical to maintain steering control and to prevent the tractor from rearing up while driving. If the front end is too light, add weight until a minimum of 20% total weight is reached on the front tires. Front weights and weight carriers can be purchased through an authorized tractor dealership. OPS-U- 0005



# OPERATION

## **3.10 Power Take Off (PTO)**

Depending on the unit, the mower is designed to operate at a PTO speed of 540 or 1000 RPM. Most tractors operate at either 540, or a combination of 540 and 1000 RPM PTO speeds. The operating speed of the mower and tractor can be determined by the number of splines on the driveline yoke and PTO output shaft. Those operating at 540 RPM will have a 6-spline shaft and those operating at 1000 RPM will have a 21-spline shaft or a 1-3/4" 20 spline shaft. Refer to the tractor owner's manual for instructions to change PTO speeds on models that operate at more than one speed.

If operating an older model tractor where the tractor's transmission and PTO utilize one master clutch, an over-running clutch must be used between the PTO output shaft and the driveline of the mower. An authorized tractor dealer can provide the over-running clutch and its installation if needed. *OPS-U- 0006*



**DO NOT** use a PTO adapter to attach a non-matching Implement driveline to a Tractor PTO. Use of an adapter can double the operating speed of the Implement resulting in excessive vibration, thrown objects, and blade and implement failure. Adapter use will also change the working length of the driveline exposing unshielded driveline areas. Serious bodily injury and/or equipment failure can result from using a PTO adapter. Consult an authorized dealer for assistance if the Implement driveline does not match the Tractor PTO.

(S3PT-14)



Never operate the Tractor and Mower if the Implement input driveline is directly connected to the Tractor transmission. Tractor braking distances can be substantially increased by the momentum of the rotating Mower blades driving the Tractor transmission even though the Tractor clutch has been disengaged. Install an over running clutch between the Tractor PTO and the Mower driveline to prevent this potentially dangerous situation. (S3PT-16)

## **4. GETTING ON AND OFF THE TRACTOR**

Before getting onto the tractor, the operator must read and completely understand the implement and tractor operator manuals. If any part of either manual is not completely understood, consult an authorized dealer for a complete explanation. *OPS-U- 0007*



Do not mount or dismount the Tractor while the tractor is moving. Mount the Tractor only when the Tractor and all moving parts are completely stopped. (SG-12)



# OPERATION

## 4.1 Boarding the Tractor

Use both hands and equipped handrails and steps for support when boarding the tractor. Never use control levers for support when mounting the tractor. Seat yourself in the operator's seat and secure the seat belt around you.

Never allow passengers to ride on the tractor or attached equipment. Riders can easily fall off and be seriously injured or killed from falling off and being ran over. It is the operator's responsibility to forbid all extra riders at all times. OPS-U- 0008



Never allow children or other persons to ride on the Tractor or Implement. Falling off can result in serious injury or death. (SG-10)



Never allow children to operate or ride on the Power Unit or Implement. (SPU-17)



## 4.2 Dismounting the Tractor

Before dismounting, park the tractor and implement on a reasonably level surface, apply the parking brake, idle the engine down, disengage the PTO, and lower the implement to the ground. Shut down the tractor engine according to the operator's manual, remove the key, and wait for all motion to completely stop. Never leave the seat until the tractor, its engine and all moving parts have come to a complete stop.

Use hand rails and steps when exiting the tractor. Be careful of your step and use extra caution when mud, ice, snow or other matter has accumulated on the steps or hand rails. Use all handrails and steps for support and never rush or jump off the tractor. OPS-U- 0009



BEFORE leaving the tractor seat, always engage the brake and/or set the tractor transmission in parking gear, disengage the PTO, stop the engine, remove the key, and wait for all moving parts to stop. Place the tractor shift lever into a low range or parking gear to prevent the tractor from rolling. Never dismount a Tractor that is moving or while the engine is running. Operate the Tractor controls from the tractor seat only. (SG-9)

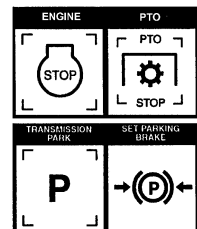

# OPERATION

## 5. STARTING THE TRACTOR

The operator must have a complete understanding of the placement, function, and operational use of all tractor controls before starting the tractor. Review the tractor operator's manual and consult an authorized dealer for tractor operation instructions if needed.

Essential Tractor Controls:

- Locate the ignition key/switch
- Locate the engine shut off control
- Locate the hydraulic control levers
- Locate the light control lever
- Locate the brake pedals and clutch
- Locate the PTO control
- Locate the 3 point hitch control lever
- Locate the boom operating controls (joystick or valve bank)

Before starting the tractor ensure the following:

- Conduct all pre-start operation inspection and service according to the tractor operator's manual.
- Make sure all guards, shields, and other safety devices are securely in place.
- The parking brake is on.
- The tractor transmission levers are in park or neutral.
- The boom operating controls are in the neutral and off position.
- The PTO control lever is disengaged.
- The hydraulic remote control levers are in the neutral position.

Refer to the tractor owner's manual for tractor starting procedures. Only start the tractor while seated and belted in the tractor operator's seat. Never bypass the ignition switch by short circuiting the starter solenoid. After the tractor engine is running, avoid accidental contact with the tractor transmission to prevent sudden and unexpected tractor movement. OPS-B- 0003



Never run the Tractor engine in a closed building or without adequate ventilation. The exhaust fumes can be hazardous to your health. (SG-23)



Start tractor only when properly seated in the Tractor seat. Starting a tractor in gear can result in injury or death. Read the Tractor operators manual for proper starting instructions. (SG-13)



# OPERATION

## 5.1 Connecting Attaching Head to the Boom

1. Start by using a hoist to lower the boom(1) down to the mower head (6). Align the Boom with the Head Hitch Post(7), insert the upper hitch pin(2) through the top hole of the Head Hitch Post (7) and upper linkage (11). Attach with bolt (8), washer(9) , and nut (10).

2. Then align the lower linkage (12) of the Boom and insert the lower hitch pin(3) through lower hole of hitch post(7). Attach with bolt (8), washer (9) and nut(10).

3. Finally make sure all bolts, nuts, and pins are tightened to recommended torque. (Refer to Figures Ops-1206 & Ops-1207)

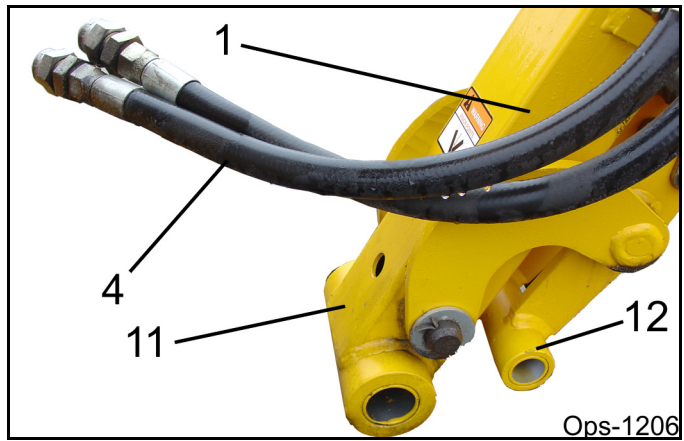

Ops-1206

## 5.2 Connecting Mower Head Hydraulics

Attach the hoses(4), from the articulating arm to the hydraulic motor ports (5) on the head. Use recommended hose end torque values in chart below. (Refer to Figures Ops-1206, Ops-1207 & Mnt-B-0004)

Use extreme caution when connecting the mower to the tractor. The mower should be securely resting at ground level or on blocks. Place a block in front of and behind the tires to prevent the mower from moving. Keep hands and feet out from under the mower and clear of pinch points between the tractor and mower.

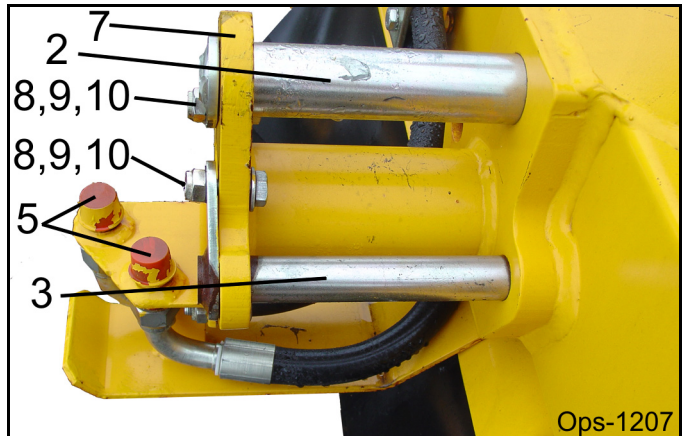

Ops-1207

### RECOMMENDED HOSE END TORQUE VALUES FOR 37 DEGREE ANGLE STEEL HOSE END FITTINGS

DASH SIZE	NOMINAL SIZE (IN.O)	TORQUE (IN.LBS.)	VALUE* (FT.LBS.)
-4	1/4	140	12
-6	3/8	230	19
-8	1/2	450	38
-10	5/8	650	54
-12	3/4	900	75
-16	1	1200	100
-20	1-1/4	1600	133
-24	1-1/2	2000	167
-32	2	2800	233

\* Straight threads do not always seal better when higher torques are used. Too much torque causes distortion and may lead to leakage.

Mnt-B-0004

### **WARNING**

Avoid contact with hot surfaces including hydraulic oil tanks, pumps, motors, valves and hose connections. Relieve hydraulic pressure before performing maintenance or repairs. Use gloves and eye protection when servicing hot components. Contact with a hot surface or fluid can cause serious injury from burns or scalding. (SG-34)

# OPERATION

## **DANGER**

Always shut the Tractor completely down, place the transmission in park, and set the parking brake before you or anyone else attempts to connect or disconnect the Implement and Tractor hitches. (S3PT-15)

## **WARNING**

Periodically inspect all moving parts for wear and replace when necessary with authorized service parts. Look for loose fasteners, worn or broken parts, and leaky or loose fittings. Make sure all pins have cotter pins and washers. Serious injury may occur from not maintaining this machine in good working order. (SG-21)

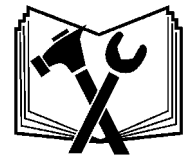

## **DANGER**

All Safety Shields, Guards and Safety devices including (but not limited to) - the Deflectors, Chain Guards, Steel Guards, Gearbox Shields, PTO integral shields, and Retractable Door Shields should be used and maintained in good working condition. All safety devices should be inspected carefully at least daily for missing or broken components. Missing, broken, or worn items must be replaced at once to reduce the possibility of injury or death from thrown objects, entanglement, or blade contact. (SBM-18)

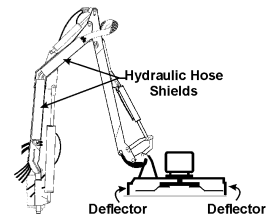

## **DANGER**

Never work under the Implement, the framework, or any lifted component unless the Implement is securely supported or blocked up to prevent sudden or inadvertent falling which could cause serious injury or even death. (SG-14)



## **WARNING**

Do not let the Blades turn when the Mower Deck is raised for any reason, including clearance or for turning. Raising the Mower deck exposes the Cutting Blades which creates a potentially serious hazard and could cause serious injury or even death from objects thrown from the Blades. (SRM-07)



# OPERATION

## **6. PRE-OPERATION INSPECTION AND SERVICE**

Before each use, a pre-operation inspection and service of the implement and tractor must be performed. This includes routine maintenance and scheduled lubrication, inspecting that all safety devices are equipped and functional, and performing needed repairs. DO NOT operate the unit if the pre-operation inspection reveals any condition affecting safe operation. Perform repairs and replacement of damaged and missing parts as soon as noticed. By performing a thorough pre-operation inspection and service, valuable down time and repair cost can be avoided. *OPS-U-0029*



Periodically inspect all moving parts for wear and replace when necessary with authorized service parts. Look for loose fasteners, worn or broken parts, and leaky or loose fittings. Make sure all pins have cotter pins and washers. Serious injury may occur from not maintaining this machine in good working order. (SG-21)

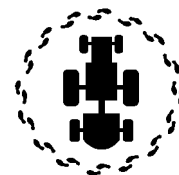

### **6.1 Tractor Pre-Operation Inspection/Service**

Refer to the tractor operator's manual to ensure a complete pre-operation inspection and scheduled service is performed according to the manufacturers recommendations. The following are some of the items that require daily service and inspection:

- Tire condition/air pressure
- Wheel lug bolts
- Steering linkage
- PTO shield
- SMV sign is clean and visible
- Tractor's lights are clean and functional
- Tractor Seat belt is in good condition
- Tractor ROPS is in good condition
- ROPS is in the raised position
- No tractor oil leaks
- Radiator free of debris
- Engine oil level and condition
- Engine coolant level and condition
- Power brake fluid level
- Power steering fluid level
- Fuel condition and level
- Sufficient lubrication at all lube points
- Air filter condition *OPS-U-0030*



# OPERATION

## 6.2 Boom Unit Pre-Operation Inspection and Service

Inspect and service the boom arm and head prior to operation. Damaged and/or broken parts should be repaired and/or replaced immediately. To ensure the unit is ready for operation, conduct the following:

OPS-B- 0020



All Safety Shields, Guards and Safety devices including (but not limited to) - the Deflectors, Steel Guards, Gearbox Shields, PTO integral shields, and Retractable Door Shields should be used and maintained in good working condition. All safety devices should be inspected carefully at least daily for missing or broken components. Missing, broken, or worn items must be replaced at once to reduce the possibility of injury or death from thrown objects, entanglement, or blade contact. (SFL-5)

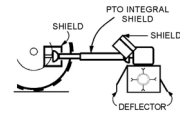

Replace bent or broken blades with new blades. NEVER ATTEMPT TO STRAIGHTEN, WELD, OR WELD HARDFACING ON BLADES SINCE THIS WILL LIKELY CRACK OR OTHERWISE DAMAGE THE BLADE WITH SUBSEQUENT FAILURE AND POSSIBLE SERIOUS INJURY FROM THROWN BLADES. (SGM-10)

The operator's manual and safety signs affixed on the unit contain important instructions on the safe and proper use of the equipment. Maintain these important safety features on the implement in good condition to ensure the information is available to the operator at all times.

- Ensure the manual canister is secured to the equipment with the operator's manual inside.
- Ensure all safety signs are in place and legible. Replace missing, damaged, and illegible decals. OPS-U- 0011



**NOTE:** The mower Operator's Manual and affixed Decals contain important instructions on the safe and proper use of the mower. Maintain these important safety features on the mower in good condition to ensure the information is available to the operator at all times.



KEEP AWAY FROM ROTATING ELEMENTS to prevent entanglement and possible serious injury or death. (SG-24)



# OPERATION

## FRAME ASSEMBLY

- Inspect condition of mounting frame weldment.
  - Inspect condition of King Post frame.
  - Ensure all bolts and screws are in position and are properly torqued.
  - Ensure all pins are in place and fastened with screws.
  - Ensure frame is properly mounted to tractor and hardware is properly installed and tightened.
- OPS-B- 0021\_D*

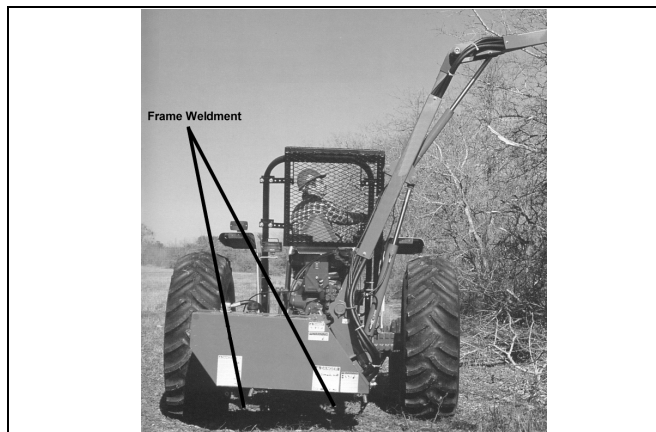

## BOOM ARM ASSEMBLY

- Inspect condition of each arm section weldment
- Ensure all pins are in place.
- Ensure all bolts and screws are properly installed.
- Check condition of teflon bushings at boom pivot points.
- Ensure each hydraulic cylinder is installed and retained correctly. Ensure the proper size pins are used to retain the cylinders in place and are secured properly.
- Ensure that all joints are lubricated. See Maintenance Section for Lubrication Chart. *OPS-B-022\_E*

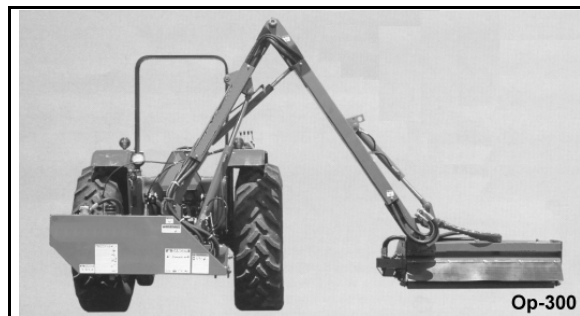

Never attempt to lubricate, adjust, or remove material from the Implement while it is in motion or while tractor engine is running. (SG-20)

## HYDRAULIC LINE INSPECTION

- Check for hydraulic leaks along hoses, cylinders and fittings. **IMPORTANT:** DO NOT use your hands to check for oil leaks. Use a piece of heavy paper or cardboard to check for hydraulic oil leaks.
  - Inspect the condition of the valve weldment.
  - Ensure fitting is properly connected
  - Inspect condition of nylon bushings.
- OPS-B- 0023\_E*

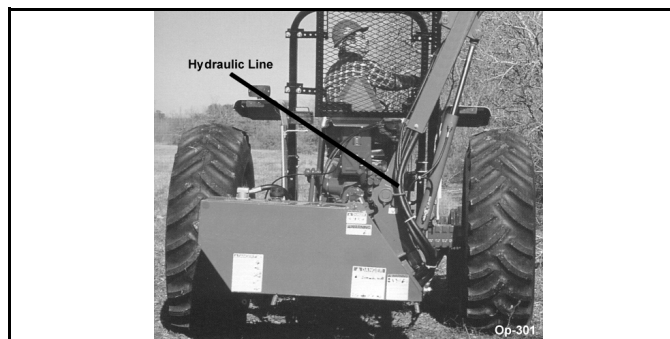



# OPERATION

## **WARNING**

Relieve hydraulic pressure prior to doing any maintenance or repair work on the Implement. Place the Mower Head on the ground or securely supported on blocks or stands, disengage the PTO, and turn off the engine. Push and pull the control Levers or Joystick several times to relieve pressure prior to starting any maintenance or repair work. (SBM-6)

## **WARNING**

Never Leave the mower unattended while the head is in the raised position. The mower could fall causing serious injury to anyone who might inadvertently be under the mower. (SBM-4)



## **WARNING**

Do not operate this Equipment with hydraulic oil or fuel leaking. Oil and fuel are explosive and their presence could present a hazard. Do not check for leaks with your hand! High-pressure oil streams from breaks in the line could penetrate the skin and cause tissue damage including gangrene. To check for a hose leak, SHUT the unit ENGINE OFF and remove all hydraulic pressure. Wear oil impenetrable gloves, safety glasses and use Cardboard to check for evidence of oil leaks. If you suspect a leak, REMOVE the HOSE and have it tested at a Dealer. If oil does penetrate the skin, have the injury treated immediately by a physician knowledgeable and skilled in this procedure. (SG-15)



OPERATION

### HYDRAULIC PUMP/OIL RESERVOIR

- Check oil reservoir level and oil condition. (Add specific type oil if low)
- Change hydraulic oil filter and hydraulic oil according to maintenance schedule.
- Ensure there are no oil leaks and fitting are properly connected
- Inspect overall condition of hydraulic pump.
- Inspect pump drive shaft.



Check the fluid level in the Hydraulic Tank on the Tractor, and add oil if required. As the air has been forced out of the Cylinders and Hoses, it goes into the Hydraulic Tank and reduces the volume of oil. Maintain the oil level within the sight gauge located on the side of the reservoir. Never fill the tank above the sight gauge to allow for the expansion of the oil. The tank maintains pressure after the mower has been run. Stand off to one side when removing the breather cap element to prevent possible injury. To relieve pressure remove the breather cap element and depress the spring loaded pressure valve to release any excess air. OPS-B- 0024\_H

# OPERATION

## **WARNING**

Do not operate this Equipment with hydraulic oil or fuel leaking. Oil and fuel are explosive and their presence could present a hazard. Do not check for leaks with your hand! High-pressure oil streams from breaks in the line could penetrate the skin and cause tissue damage including gangrene. To check for a hose leak, SHUT the unit ENGINE OFF and remove all hydraulic pressure. Wear oil impenetrable gloves, safety glasses and use Cardboard to check for evidence of oil leaks. If you suspect a leak, REMOVE the HOSE and have it tested at a Dealer. If oil does penetrate the skin, have the injury treated immediately by a physician knowledgeable and skilled in this procedure. (SG-15)



## **WARNING**

Attention: Oil Filler Cap is also the Pressure Relief Cap.

Remove cap slowly to relieve pressure before removing cap completely. Stay clear to prevent being scalded with hot oil that may spray out of the tank that is still pressurized and may cause serious injury to eyes, face, and exposed skin. (Ops-0001-MISC)

## **WARNING**

Avoid contact with hot surfaces including hydraulic oil tanks, pumps, motors, valves and hose connections. Relieve hydraulic pressure before performing maintenance or repairs. Use gloves and eye protection when servicing hot components. Contact with a hot surface or fluid can cause serious injury from burns or scalding. (SG-34)

### FLAIL HEAD INSPECTION

- Inspect blades and blade bolts for looseness and excessive wear. Rotate to 90° to make for checking easier. Replace damaged, worn, and missing blades as complete sets to maintain cuttershaft balance.
- Ensure rubber deflectors are in position and not damaged. Replace worn, broken, and missing sections immediately.
- Ensure the rollers are in good condition and rotate freely.
- Inspect that all bolts and screws are in position and are properly torqued.
- Ensure hydraulic lines are properly connected to the hydraulic motor. Check for hydraulic leaks along hoses and fittings. DO NOT use your hands to check for oil leaks. Use a piece of heavy paper or cardboard to check for hydraulic oil leaks.
- Inspect the condition of the drive belts.
- Ensure the drive belt shields are in place and in good repair.
- Remove any grass or other debris which may be wrapped around the cuttershafts ends.
- Inspect the condition of deck skid shoes and hardware. OPS-B- 0026\_B

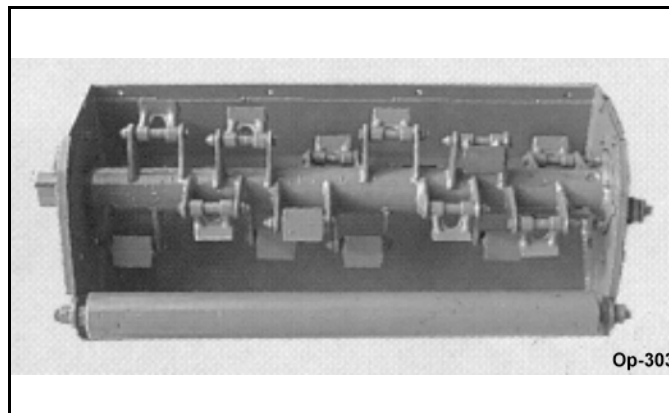

# OPERATION

## Boom Mower PRE-OPERATION Inspection



Mower ID# \_\_\_\_\_ Make \_\_\_\_\_

Date: \_\_\_\_\_ Shift \_\_\_\_\_



**Before conducting the inspection, make sure the tractor engine is off, all rotation has stopped and the tractor is in park with the parking brake engaged. Make sure the mower is resting on the ground or securely blocked up and all hydraulic pressure has been relieved.**

Item	Condition at Start of Shift	Specific Comments if not O.K.
The Operator's Manual is in the canister on the mower		
All safety decals are in place and legible		
The Mounting frame bolts are in place and tight		
The Boom connection bolts & pins are tight		
There are no cracks in boom		
The Hydraulic Cylinders pins are tight		
The Hydraulic Pump hose connections are tight		
The Hydraulic Valve hose connections are tight		
The Hydraulic Valve controls function properly		
There are no leaking or damaged hoses		
The Hydraulic Oil level is full		
There is no evidence of Hydraulic leaks		
The Blades are not chipped, cracked or bent		
The Blade bolts are tight		
The Deflectors are in place and in good condition		
The Mower shields are in place and in good condition		
The Skid shoes are in good condition & tight		
There are no cracks or holes in mower deck		
The Hyd. motor mounting bolts are tight		
The mower head spindle housing is tight and lubricated		

Operator's Signature: \_\_\_\_\_

**DO NOT OPERATE an UNSAFE TRACTOR or MOWER**

**OPERATION**

# OPERATION

## Tractor PRE-OPERATION Inspection



Mower ID# \_\_\_\_\_ Make \_\_\_\_\_

Date: \_\_\_\_\_ Shift \_\_\_\_\_



**Before conducting the inspection, make sure the tractor engine is off, all rotation has stopped and the tractor is in park with the parking brake engaged. Make sure the mower is resting on the ground or securely blocked up and all hydraulic pressure has been relieved.**

**OPERATION**

Item	Condition at Start of Shift	Specific Comments if not O.K.
The flashing lights function properly		
The SMV Sign is clean and visible		
The tires are in good condition with proper pressure		
The wheel lug bolts are tight		
The tractor brakes are in good condition		
The steering linkage is in good condition		
There are no visible oil leaks		
The hydraulic controls function properly		
The ROPS or ROBS Cab is in good condition		
The seatbelt is in place and in good condition		
The 3-point hitch is in good condition		
The drawbar pins are securely in place		
The PTO master shield is in place		
The engine oil level is full		
The brake fluid level is full		
The power steering fluid level is full		
The fuel level is adequate		
The engine coolant fluid level is full		
The radiator is free of debris		
The air filter is in good condition		

Operator's Signature: \_\_\_\_\_

**DO NOT OPERATE an UNSAFE TRACTOR or MOWER**

This Inspection Form may be freely duplicated for extra copies.

# OPERATION

## **7. OPERATING THE BOOM MOWER**

### **7.1 Machine Controls**

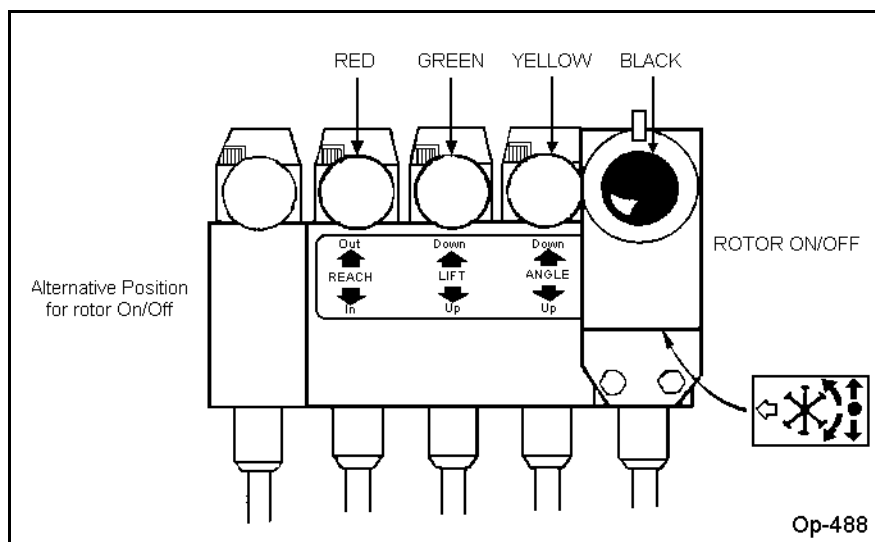

Moving the Arm control levers away from the cables will result in "Lift Down", "Angle Down" and "Reach Out".

For Ti Models only, the Flail On/Off valve can be mounted on either end of the main control block. It is delivered with the lever control gate set in the position limiting the lever selection to "Flail Off" and "Flail On - Upwards Cut". Should a downward cut be required, the lever gate can be rotated to allow "Flail Off" and "Flail On - Downward Cut" selection.

Before making this adjustment, disengage the PTO shaft and ensure that the rotor has stopped rotating.

Do not be tempted to discard the lever gate; it is there to prevent sudden, inadvertent changes of rotation which could cause damage to the machine.

### **7.2 Engaging Drive**

#### **Fully Independent Model**

Ensure that the rotor control lever is moved to the "STOP" position before engaging the PTO shaft. Allow the oil to circulate for a minute or so before operating the armhead levers. Position the flail head in a safe position, increase the engine speed to a high idle and move rotor control lever to "ON". After initial surging the rotor will run at an even speed. Starting the rotor this way reduces the starting loads imposed on the hydraulic motor and the drive splines.

#### **Tractor Supply Model**

Place the flail head at a safe attitude and bring the tractor engine revolutions to 1000 RPM to avoid stalling when the starting load is placed on the motor. Engage the PTO and slowly increase revs until operating speeds are attained.

PA91 02/08

Operation Section 4-21

# OPERATION

## **7.3 Forward Speed**

Tractor ground speed is determined by common sense and experience. It should be slow enough to allow sufficient time for the flails to cut the work without overloading. It is obviously better to make a second pass or more in heavier growth to avoid undue strain.

## **7.4 Tractor Position**

The position of the tractor in relation to the hedgerow will again be determined by experience. For a normal straight forward hedgerow the position should be such as to allow the reach ram to be in mid-stroke. This effectively allows the reach to be adjusted in either direction without altering the tractor's position.

## **7.5 Operating Speed**

The flail head should be run at a speed no higher than is needed to make a clean cut with no fall off in rotor speed. This also allows better control of the tractor and reduces the tendency of the operator to "ride the clutch pedal". The recommended rotor speed is 2500 RPM. To achieve these speeds it will be necessary to run the tractor engine to give a PTO speed of 450 RPM.



Never exceed 540 RPM on the PTO shaft.

## **7.6 Working Close In and High**

When attempting to position the flail head to cut close in and high the main arm may touch against the stop before the required head position is achieved. If this occurs select "Reach out", this will cause the main arm to lift off the stop allowing the "Lift up" motion to be continued on service selection.

By the use of this technique it is possible to position the flail head in the close in position from ground level to full height.

## **7.7 Breakaway**

The pivoted arm is held rigid and in line by the oil pressure in the fully extended breakaway ram. When the flail head meets an obstruction and the tractor continues to move forward, oil pressure will build up against a relief valve situated in the base of the breakaway ram. When the preset pressure is reached the valve will blow and the oil will be vented into the lift ram. This will allow the flail head to pivot backwards and at the same time cause the arms to rise. When the obstruction is cleared, oil pressure contained in the lift ram will cause the arm and flail head to the work position.

## **7.8 Wire Trap**

The flail hood is equipped with a wire trap. The trap consists of a steel plate welded across the underside. Any loose ends of wire which are picked up and carried round by the rotor are cut by the edge of the metal plate and fall harmlessly to the ground. This plate should not be interfered with or modified in any way.

Furthermore, this wire trap does not relieve the operator of the responsibility of checking and cleaning the flail when it is suspected that wire has caught in the rotor.

# OPERATION

## 7.9 Hedge Cutting Procedure

### **Upward Cutting**

The flail head is assembled at the factory for the flails to cut with an upward motion. Upward cutting produces a cleaner finish minimizes split stems and is ideal for a light hedge that has been regularly maintained. The front hood and rear flap must always be in position when hedging with an upward cutting action. The front hood is pivot mounted and can be adjusted to four working positions. To minimize the throwing of debris specially when roadside cutting the hood should be adjusted to its lowest position. Raising the hood will allow longer material to be cut but there will be a greater tendency for debris to be thrown.

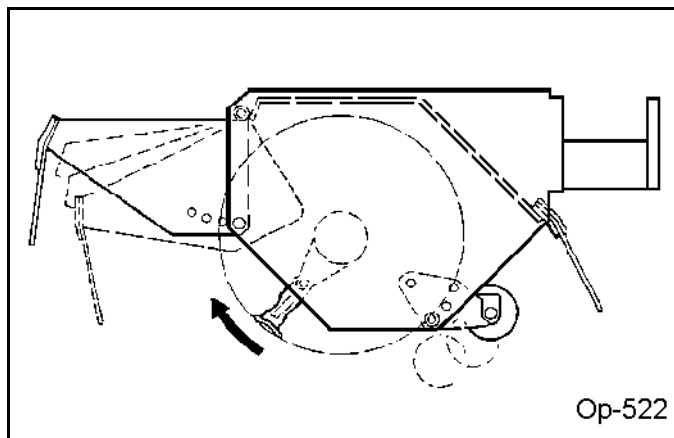

### **Front Flap Kit (Optional Extra)**

To further reduce the possibility of debris being thrown out of the front of the hood a flap kit consisting of seven rubber flaps which are attached to the leading edge of front hood is available.

### **Optional Downward Cutting**

It is possible to reverse the rotation of the flail for downward cutting. This chopping action subjects the rotor to a more violent usage and should therefore be avoided whenever possible.

### **For Downward Cutting**

The rear flap must always remain in position to deflect the cut material downwards into the hedge. Because of the tendency to throw material out of the rear of the hood when downward cutting it is especially important that the rear flap is kept in good condition. It is permissible to remove the front hood to allow longer material to pass under the flail.

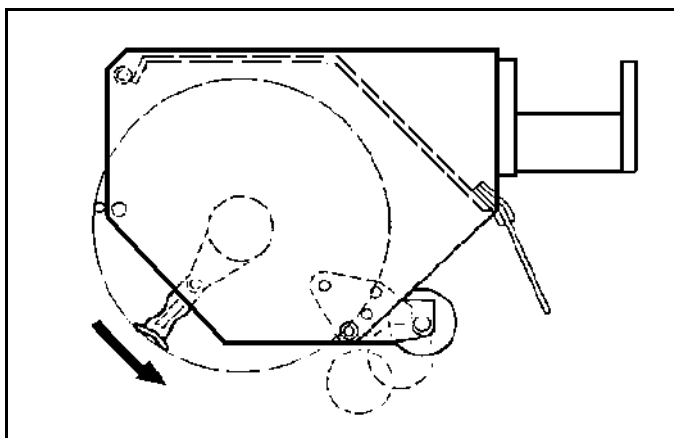

OPERATION

# OPERATION

## Reversing Rotation (Si Only)

Fully extend the armhead and lower flail to the ground to minimize oil loss. Release the rotor hoses from either the flail motor or the rotor control valve and interchange the connections. Do not cross over the flail supply and return hoses at any other point as the hose routing and cross overs in the installation are necessary to allow the hoses to flex correctly during arm movements.

To ascertain the direction of cut without running the machine the following applies.

Connection MP - lower motor connection - upward cutting

Connection MR - upper motor connection - upward cutting

Connection MP - upper motor connection - downward cutting

Connection MR - lower motor connection - downward cutting

## Reversing Rotation (Ti Only)

The flail rotor rotation can be reversed using the rotor control lever. Place the lever in the "Off" position and rotate the lever stop gate through 180 degrees. This allows the selection of "On" and "Downward Rotation".



Do not remove the lever stop gate as it prevents the unintentional instant reversal of rotation and the likely machine damage that would be caused as a result.

## Cutting Sequence

Operator preference will ultimately decide on the order of cutting. Where it is difficult to determine the original hedge line because of overgrowth a recommended method is to start by siding up the hedge first, if necessary making more than one pass.

A second cut should then be taken at an incline along the hedge top and again if there is prolific growth it may be necessary to make more than one pass until the hedge is reduced to the height and contour required.

Finally, finish with a ground cut. The roller should be lowered for this. This ground cut defines the base line of the hedge, severs shrubs and debris that encroach out from the bottom, and further mulches the toppings that have fallen.

**NOTE:** *Flails are more prone to accidental damage and blunting by stones on a ground cut. Therefore, when convenient, this should be left until the end.*

Where the hedge has been well maintained in the past, it may be found better to cut the top before siding up.



Do not be tempted to make a vertical cut on the fast side of the hedge. This would entail cutting "blind" and the rotating flail would be capable of throwing debris through the hedgerow in line with the operator.

Where both sides of a roadside hedge are to cut, always cut the field side first. The uncut roadside helps to reduce the amount of debris being flung through the hedge into the road. Also by sloping the vertical cut to give an "A" shape, debris is thrown down into the hedge bottom and the spread of material is reduced.



# OPERATION

## 7.10 Lift Float Kit (Optional)

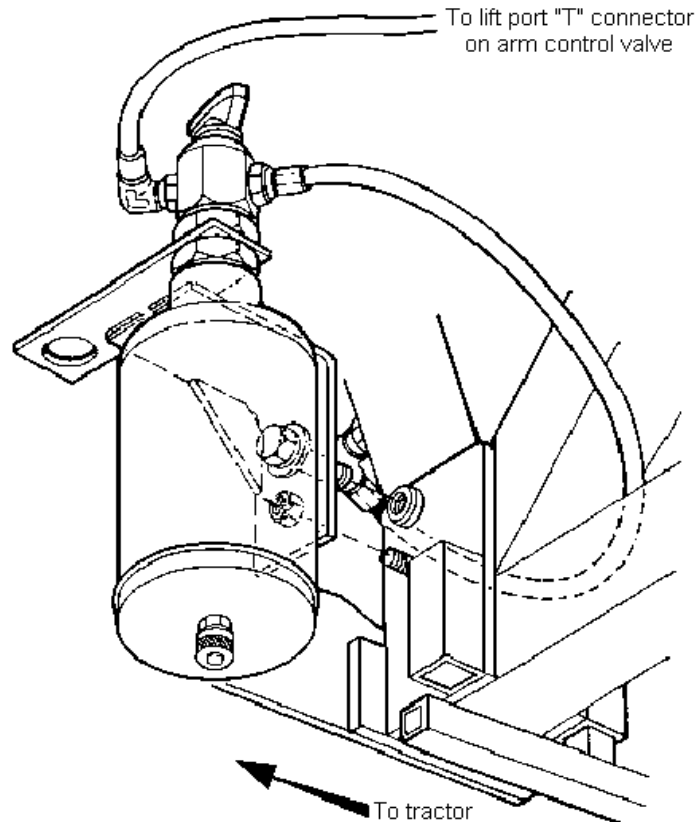

Op-524

Ground scrub flailing can be a slow tedious task requiring a high degree of operator concentration especially when working on a rough or rising ground. A hydraulic float kit is available which is mounted tap upwards through the inboard mounting hole of a bracket which is located and bolted vertically to the face of the lift ram base lug nearest the tractor. See Illustration. The small hose supplied with the kit connects one side of the tap to the base connection of the lift ram. The existing lift ram hose is then attached to the remaining tap connection.

In work, with the stop tap open, the flail runs along the ground automatically lifting and riding over bumps. Any shock loads are absorbed by the accumulator which is precharged with nitrogen to 600 PSI (41 Bar).

To obtain optimum working performance the lift control should be operated to take approximately fifty percent of the flail head weight off the flail roller. This is important as with too little weight on the roller, the flail head will tend to remain in the air after riding over a bump and leave areas of uncut material, while with too much weight on the roller the float will be inoperative. The ground will be scalped in places and increase flail wear, loss or damage to flails could occur.

To revert to hedge cutting or to use the flail without it running along the ground, the stop tap should be closed to isolate the accumulator.

# OPERATION

## 7.11 Flail Types

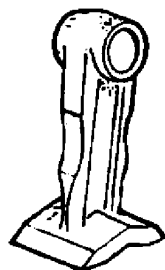

F91 H



F91 G

Op-525

Two types of flail are available:

The F91 H is a cast flail suitable for continuous hedge and scrub cutting. It will also cut grass, but the finish will be inferior to that produced by the F91 G and the power requirements greater.

The F91 G is a pressed flail suitable for grass and scrub cutting. It can also be used to cut hedges, but continuous use in this material will noticeably shorten its working life.

## 7.12 Machine Configuration

The machine can be supplied to be either front or rear mounted and to cut on the right or left side of the tractor. Conversion to any configuration can be carried out without recourse to specially handed mechanical components. Some new hoses will be required, refer to hydraulic installation pages in the parts list for specific requirements.

It is stressed that conversion is a major rebuild and not an in-field adjustment. A workshop with overhead lifting tackle is required.

Before commencing, drain the hydraulic system and empty the reservoir.

### Important Points

The pump/gearbox assembly is horizontally mounted. For left front and rear right builds it is mounted with the pump away from the tank.

For right front and rear left builds, it is mounted with the pump towards the tank.

The hydraulic hoses to the flail motor and the angle ram are always routed up the front face of the main arm crossed over at the pivot and down the rear face of the dipper regardless of machine build.

The flail head is dispatched with the motor mounted inboard. If converting right to left or vice versa and if an inboard mounted motor is an important operational requirement, it will be necessary to rebuild the flail head with the motor mounted at the opposite end.

# OPERATION

## 8. DRIVING THE TRACTOR AND IMPLEMENT

Safe tractor transport requires the operator to possess a thorough knowledge of the model being operated and precautions to take while driving with an attached implement. Ensure the tractor has the capacity to handle the weight of the boom and the tractor operating controls are set for safe transport. To ensure safety while driving the tractor with a boom, review the following.

Read all safety instructions. Decals on the Boom warn you of particular and multiple hazards. Some decals are attached close to part of the Boom where there is a possible hazard. Read and make sure you understand the safety messages before you operate the implement. Keep all decals clean and readable. Replace lost or damaged decals, refer to safety section for more information.

Power for operating the mower is supplied from the tractor PTO. Refer to your tractor manual instructions for engaging and disengaging the PTO. Start the tractor and bring the engine speed up to normal operating 540 PTO speed. Always engage the PTO at low engine RPM and run the mower for a short period until all air is removed from the hoses. Keep all person's well clear of mower since blades can throw objects with great velocity for a considerable distance! KEEP CLEAR! OPS-B- 0005



Never operate the Tractor or Implement until you have read and completely understand this Manual, the Tractor Operator's Manual, and each of the Safety Messages found in the Manual or on the Tractor and Implement. Learn how to stop the tractor engine suddenly in an emergency. Never allow inexperienced or untrained personnel to operate the Tractor and Implement without supervision. Make sure the operator has fully read and understood the manuals prior to operation.

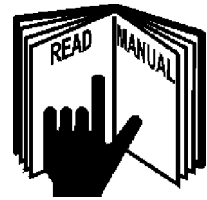

(SG-4)



Always maintain the safety signs in good readable condition. If the safety signs are missing, damaged, or unreadable, obtain and install replacement safety signs immediately. (SG-5)



This Implement is wider than the Tractor. Be careful when operating or transporting this equipment to prevent the Implement from running into or striking sign posts, guard rails, concrete abutments or other solid objects. Such an impact could cause the Implement and Tractor to pivot violently resulting in loss of steering control, serious injury, or even death. Never allow the Implement to contact obstacles. (S3PT-12)



BEFORE leaving the tractor seat, always engage the brake and/or set the tractor transmission in parking gear, disengage the PTO, stop the engine, remove the key, and wait for all moving parts to stop. Place the tractor shift lever into a low range or parking gear to prevent the tractor from rolling. Never dismount a Tractor that is moving or while the engine is running. Operate the Tractor controls from the tractor seat only. (SG-9)

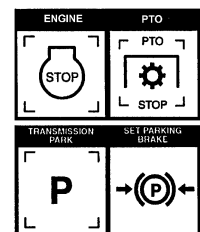

# OPERATION

**WARNING** Transport only at speeds where you can maintain control of the equipment. Serious accidents and injuries can result from operating this equipment at high speeds. Understand the Tractor and Implement and how it handles before transporting on streets and highways. Make sure the Tractor steering and brakes are in good condition and operate properly.



Before transporting the Tractor and Implement, determine the proper transport speeds for you and the equipment. Make sure you abide by the following rules:

Test the tractor at a slow speed and increase the speed slowly. Apply the Brakes smoothly to determine the stopping characteristics of the Tractor and Implement. As you increase the speed of the Tractor the stopping distance increases. Determine the maximum transport speed not to exceed 20 mph (30 kph) for transporting this equipment.

Test the equipment at a slow speed in turns. Increase the speed through the turn only after you determine that the equipment can be operated at a higher speed. Use extreme care and reduce your speed when turning sharply to prevent the tractor and implement from turning over. Determine the maximum turning speed for you and this equipment before operating on roads or uneven ground.

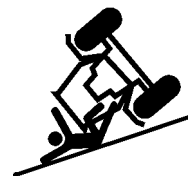

Only transport the Tractor and Implement at the speeds which allow you to properly control the equipment.

Be aware of the operating conditions. Do not operate the Tractor with weak or faulty brakes or worn tires. When operating down a hill or on wet or rain slick roads, the braking distance increases: use extreme care and reduce your speed. When operating in traffic always use the Tractor's flashing warning lights and reduce your speed. Be aware of traffic around you and watch out for the other guy. (SG-19)

## **8.1 Starting the Tractor**

The procedure to start the tractor is model specific. Refer to the tractor operator's manual for starting procedures for your particular tractor. Consult an authorized dealer if the starting procedure is unclear. Ensure the 3-point control lever is in the lowered position and the PTO is disengaged before starting the tractor. OPS-U-0033



Op-24

# OPERATION

## **8.2 Brake and Differential Lock Setting**

Make sure the tractor brakes are in good operating condition. Tractor brakes can be set to operate independently allowing single rear wheel braking action or locked together to provide simultaneous rear wheel braking. FOR MOST DRIVING AND OPERATING CONDITIONS, THE BRAKE PEDALS SHOULD BE LOCKED TOGETHER TO PROVIDE THE MOST EFFECTIVE BRAKING ACTION.

Always disengage the tractor differential lock when turning. When engaged the differential lock will prevent or limit the tractor from turning. During normal cutting conditions, locking the differential provides no benefit and should not be used.  
*OPS-U- 0013*

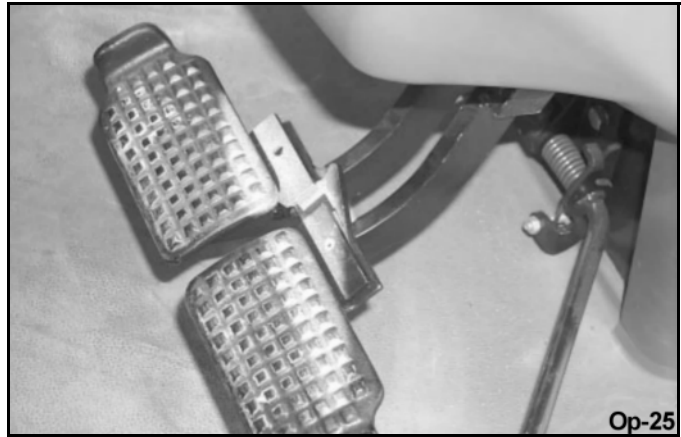

### **▲WARNING**

Be aware of the operating conditions. Do not operate the Tractor with weak or faulty brakes. When operating down a hill or on wet or rain slick roads, the braking distance increases; use extreme care and reduce your speed in these conditions. When operating in traffic, always use the Tractor's flashing warning lights and reduce your speed. Be aware of traffic around you and watch out for the other guy.

# OPERATION

## 8.3 Transport Position

- For transport on public highway, the boom must be folded within the overall width of the tractor. Position the arm until the boom head is approximately 4 ft. (1.5 M) clear of the ground and the dipper is horizontal.
- Pull the dipper arm to the rear to remove tension on the breakaway ram base pin and remove it.
- Manually break back the dipper until the base of the ram is relocated between the inboard holes in the ram lugs. Replace the ram base pin.
- Select “Reach In” and “Lift Up” until the main arm is adjacent against the stop on the top of the main frame. Fully extend the angle ram to face the booms inboard.
- Remove the transport lock pin from its stowage position beneath the main arm and locate in position through the retaining ped. Secure with spring cotter.
- For offroad transport where width is not critical, it will be sufficient to fully fold the arms and engage the lock pin.
- To revert to “work mode”, the above procedures must be reversed. OPS-B- 0053



### **WARNING**

Use extreme care when lowering or unfolding the implement's wings. Make sure no bystanders are close by or underneath the wings. Allow ample clearance around the implement when folding or unfolding the wings. Use extreme caution around buildings or overhead power lines. (S3PT-05)

### **DANGER**

Do not put hands or feet under mower decks. Blade Contact can result in serious injury or even death. Stay away until all motion has stopped and the decks are securely blocked up. (SFL-2)

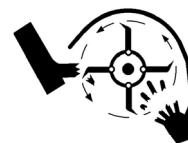

### **DANGER**

Make certain that the Boom swing path is clear of bystanders, powerlines, and obstructions to prevent injury, electrocution, and possible machine damage. Swing Boom SLOWLY AND CAREFULLY. Avoid sudden starting and stopping. (Ops-0002-MISC)

# OPERATION

## 8.4 Driving the Tractor and Boom

Start off driving at a slow speed and gradually increase your speed while maintaining complete control of the tractor. Never operate the tractor at speeds that cannot be safely handled or which will prevent the operator from stopping quickly during an emergency. If the power steering or engine ceases operating, stop the tractor immediately as the tractor will be difficult to control.

Perform turns with the tractor and mower at slow speeds to determine how the tractor with and attached implement handles a turn. Determine the safe speed to maintain proper control of the tractor when making turns. When turning with the implement the overall working length and width of the unit is increased. Allow additional clearance for the unit when turning or when passing large obstructions.

To avoid overturns, drive the tractor with care and at safe speeds, especially when operating over rough ground, crossing ditches or slopes, and turning corners. Use extreme caution when operating on steep slopes. Keep the tractor in a low gear when going downhill. DO NOT coast or free-wheel downhill.

OPS-B- 0006



### **WARNING**

Never Leave the mower unattended while the head is in the raised position. The mower could fall causing serious injury to anyone who might inadvertently be under the mower. (SBM-4)



### **DANGER**

Always keep a careful lookout and use extreme care when working around overhead obstructions. Never allow the Mower head or boom within 10 feet of any power line. When working close to overhead power lines consult your electric company for a safe code of operation. (SBM-7)

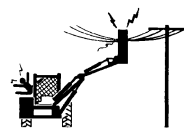



# OPERATION

## 9. OPERATING THE TRACTOR AND IMPLEMENT

**THE OPERATOR MUST COMPLETELY UNDERSTAND HOW TO OPERATE THE TRACTOR AND IMPLEMENT AND ALL CONTROLS BEFORE ATTEMPTING TO OPERATE.** The operator must read and understand the Safety and Operation Sections of the implement and tractor operator's manuals. These manuals must be read and explained to any operator who cannot read. Never allow someone to operate the implement and tractor without complete operating instructions.

Before starting any operation, the operator must become familiar with the area to be worked in and any obstacles and hazards contained within to ensure safety to the operator, bystanders, and equipment. Special attention should be paid to foreign debris, rough terrain, steep slopes, and passersby and animals in the area.  
*OPS-U- 0015*



Extreme care should be taken when operating near loose objects such as gravel, rocks, wire, and other debris. Inspect the area before mowing. Foreign objects should be removed from the site to prevent machine damage and/or bodily injury or even death. Any objects that cannot be removed must be clearly marked and carefully avoided by the operator. Stop mowing immediately if blades strike a foreign object. Repair all damage and make certain rotor or blade carrier is balanced before resuming mowing. (SGM-05)



### 9.1 OPERATING INSTRUCTIONS

1. Engage the PTO shaft at low engine RPM and speed the engine up after blades are fully engaged. Never engage the PTO shaft at a high engine RPM. This could cause damage to the PTO shaft as well as the Speed Increaser and Pump. Always operate PTO at the recommended RPM when mowing. This is necessary to maintain proper blade speed and to produce a clean cut.
2. Proper ground speed for cutting will depend upon the height, type, and density of material to be cut. Normally, ground speed will range from 2 to 5 m.p.h. Tall dense material should be cut at low speed while thin medium height material can be cut at a faster ground speed.
3. Always run the Mower at the highest position which will enable you to obtain the desired cutting results. Allowing the blades to cut into the ground will cause wear and undue strain on the mower frame and mower components.

If you are mowing in conditions of heavy growth or rough ground where the blades cut into the ground and the tractor engine slows down, do not slip the clutch to allow the engine to speed up and engage the clutch again. This procedure exerts tremendous strain on Mower components. Always disengage the PTO and move forward or backwards until the machine is clear.

This mower is designed with free swinging blades. This feature reduces the amount of shock transmitted to other components. Always make sure the blades can swing freely on the blade bar.



# OPERATION

When cutting foliage and fine shredding is desired, run the mower level or slightly lower in the rear so as to keep the material in the mower until it is shredded. This will require more power but will shred better. When cutting heavy foliage and fine shredding is not desired, raise the rear of the mower. This will allow the high volume of material to be discharged and requires much less power.

Do not ride the clutch on the tractor. Mow in the appropriate gears to give the correct ground speed.

Extremely tall grass should be cut twice. Raise mower and cut twice the desired height. Cut the second time at desired height at 90 degrees to first pass.

Remember, sharp blades produce cleaner cuts and use less power.

Before cutting, analyze the area to determine the best cutting procedure. Consider the height and type of material and the terrain type: hilly, level or rough.

**WARNING**

Do not mow with two machines in the same area except with Cab tractors with the windows closed. (SGM-11)

**WARNING**

Mow only in conditions where you have clear visibility in daylight or with adequate artificial lighting. Never mow in darkness or foggy conditions where you cannot clearly see at least 100 yards(90 m) in front and to the sides of the tractor and mower. Make sure that you can clearly see and identify passersby, steep slopes, ditches, drop-offs, overhead obstructions, power lines, debris and foreign objects. If you are unable to clearly see these type of items discontinue mowing. (SGM-1)

**WARNING**

Avoid mowing in reverse direction when possible. Check to make sure there are no persons behind the mower and use extreme care when mowing in reverse. Mow only at a slow ground speed where you can safely operate and control the tractor and mower. Never mow an area that you have not inspected and removed debris or foreign material. (SGM-08)

**WARNING**

Never operate the mower head tilted down where the operator can see the blades of the mower. The blade could throw an object toward the operator causing serious injury or death. Never operate the mower without an Operator Protective Structure. Always wear safety glasses and a hard hat. (Ops-0005-MISC)

**WARNING**

Many varied objects, such as wire, cable, rope, or chains, can become entangled in the operating parts of the mower head. These items could then swing outside the housing at greater velocities than the blades. Such a situation is extremely hazardous and could result in serious injury or even death. Inspect the cutting area for such objects before mowing. Remove any like object from the site. Never allow the cutting blades to contact such items. (SGM-06)

# OPERATION

## **9.2 Foreign Debris Hazards**

Before mowing, inspect the area to make sure there are no foreign objects that the mower blades could hit or become entangled with. Remove all foreign objects and debris. If objects are too big to remove, mark them clearly and be sure to prevent the mower blades from contacting them.

If you hit a solid object or foreign debris, stop the mower and tractor at once. Immediately idle the engine speed and disengage the PTO. Wait for all mower rotating motion to stop, then raise the mower and move the tractor and implement off the object. Inspect the area and remove, or mark the location of the debris. Inspect the condition of the mower and make any needed repairs immediately. Make sure the blades are not damaged and the carrier is balanced before resuming operation.

Always wear your seat belt securely fastened and only operate the tractor and mower with the ROPS in the raised position. If the tractor or mower hits a tree stump, rock, or bump, a sudden movement could throw you off of the seat and under the tractor and/or mower. The seat belt is your best protection from falling off the tractor and the ROPS provides protection from being crushed during a tractor roll-over. *OPS-R-0023A*



## **9.3 Bystanders/Passersby Precautions**

If a bystander comes within 300 feet of the tractor while the mower is being operated, stop the tractor at once, idle the engine and disengage the PTO. Do not engage the PTO again until all bystanders are well past the 300 foot distance. *OPS-R-0024*

# OPERATION



Rotary Mowers are capable under adverse conditions of throwing objects for great distances (300 feet or more) and causing serious injury or death. Follow safety messages carefully.



## **STOP MOWING IF PASSERSBY ARE WITHIN 100 YARDS UNLESS:**

- Front and Rear Deflectors, Chain Guards, or Bands are installed and in good, workable condition;
- Mower sections or Wings are running close to and parallel to the ground without exposed Blades;
- Passersby are outside the existing thrown-object zone;
- All areas have been thoroughly inspected and all foreign material such as rocks, cans, glass, and general debris has been removed.

**NOTE:** *Where there are grass and weeds high enough to hide debris that could be struck by the blades, the area should be: inspected and large debris removed, mowed at an intermediate height, inspected, closely with any remaining debris being removed, and mowed again at desired final height. (This will also reduce power required to mow, reduce wear and tear on the Mower drivetrain, spread cut material better, reduce streaking, and make the final cut more uniform).* (SRM-01)

## **9.4 Engaging the Power Take Off (PTO)**

Before engaging the PTO, make certain that the area is clear of bystanders and passersby. The implement must be completely lowered and the deck positioned at a safe operating height. NEVER engage the PTO with the implement in the raised position.

Set the tractor engine speed at approximately 1,000 RPM before engaging the PTO. Shift the PTO control to the on position, and slowly increase the engine speed until the PTO is operating at the rated speed. If you hear unusual noises or see or feel abnormal vibrations, disengage the PTO immediately. Inspect the implement to determine the cause of the noise or vibration and repair the abnormality. OPS-U- 0027



Do not put hands or feet under mower decks. Blade Contact can result in serious injury or even death. Stay away until all motion has stopped and the decks are securely blocked up. (SGM-09)

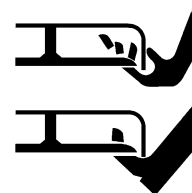

# OPERATION

## **9.5 Operating Speed and Ground Speed**

Ground speed for mowing will depend upon the height, type, and density of vegetation to be cut. Do Not exceed 2 MPH while operating. Operate the mower at its full rated PTO speed to maintain blade speed for a clean cut. Refer to the tractor operator's manual or the tractor instrument panel for the engine speed and gear to provide the required operating and desired ground speed. Make sure that the mower is operating at its full rated speed before entering the vegetation to be cut. Always start and stop cutting blades with engine near idle.

Ground speed is achieved by transmission gear selection and not by the engine operating speed. The operator may be required to experiment with several gear range combinations to determine the best gear and range which provides the most ideal performance from the implement and most efficient tractor operation. As the severity of cutting conditions increase, the ground speed should be decreased by selecting a lower gear to maintain the proper operating PTO speed. *OPS-B- 0009*



Do not exceed the rated PTO speed for the Implement. Excessive PTO speeds can cause Implement driveline or blade failures resulting in serious injury or death. (SG-26)



Mow at the speed that you can safely operate and control the tractor and mower. The correct mowing speed depends on terrain condition and grass type, density, and height of cut. Normal ground speed range is from 2 to 5 mph(3-8 kph). Use slow mowing speeds when operating on or near steep slopes, ditches, drop-offs, overhead obstructions, power lines, or when debris and foreign objects are to be avoided. (SGM-07)

## **9.6 Operating the Mower**

Only operate the mower from the tractor operator's seat with the seatbelt securely fastened. The tractor must be equipped with a ROPS in the raised position or a ROPS cab.

The mower is designed to cut vegetation up to 1-1/2" in diameter. Sharp blades will produce a cleaner cut and require less power. Travel at a speed that allows the mower sufficient time to cut through the vegetation and maintain the PTO operating speed to prevent overloading the mower and tractor. Choose a driving pattern that provides the maximum pass length and minimizes turning.

Under certain conditions, tractor tires may roll some grasses down preventing them from being cut at the same height as the surrounding area. When this occurs, reduce the tractor ground speed while maintaining the operating speed of the mower. A slower ground speed will permit grasses to at least partially rebound and be cut. Taking a partial cut and/or reversing the direction of travel may also help produce a cleaner cut.

Avoid mowing in the reverse direction when possible. In situations where the mower must be backed to access areas to be cut, make sure there are no persons or other foreign debris behind the mower before mowing in reverse. When mowing in reverse, operate the tractor and mower at a reduced ground speed to ensure tractor and mower control is maintained. *OPS-R-0026*

# OPERATION

## **⚠ DANGER**

There are obvious and hidden potential hazards in the operation of this Mower. REMEMBER! This machine is often operated in heavy brush and in heavy weeds. The Blades of this Mower can throw objects if shields are not properly installed and maintained. Serious injury or even death may occur unless care is taken to insure the safety of the operator, bystanders, or passersby in the area. Do not operate this machine with anyone in the immediate area. Stop mowing if anyone is within 100 yards of mower. (SGM-02)



## **⚠ WARNING**

Do not mow with two machines in the same area except with Cab tractors with the windows closed. (SGM-11)

## **⚠ WARNING**

Mow only in conditions where you have clear visibility in daylight or with adequate artificial lighting. Never mow in darkness or foggy conditions where you cannot clearly see at least 100 yards(90 m) in front and to the sides of the tractor and mower. Make sure that you can clearly see and identify passersby, steep slopes, ditches, drop-offs, overhead obstructions, power lines, debris and foreign objects. If you are unable to clearly see these type of items discontinue mowing. (SGM-1)

## **⚠ WARNING**

Avoid mowing in reverse direction when possible. Check to make sure there are no persons behind the mower and use extreme care when mowing in reverse. Mow only at a slow ground speed where you can safely operate and control the tractor and mower. Never mow an area that you have not inspected and removed debris or foreign material. (SGM-08)

## **⚠ WARNING**

Follow these guidelines to reduce the risk of equipment and grass fires while operating, servicing, and repairing the Mower and Tractor:



- Equip the Tractor with a fire extinguisher in an accesible location.
- Do Not operate the Mower on a Tractor with an underframe exhaust.
- Do Not smoke or have an open flame near the Mower and Tractor.
- Do Not drive into burning debris or freshly burnt areas.
- Ensure slip clutches are properly adjusted to prevent excessive slippage and plate heating.
- Never allow clippings or debris to collect near drivelines, slip clutches, and gearboxes. Periodically shut down the Tractor and Mower and clean clippings and collected debris from the mower deck. (SGM-12)

# OPERATION

OPERATION

## 9.7 Shutting Down the Attached Head

To shut down attached mower head, first bring the tractor to a complete stop. Decrease engine RPM to idle then disengage cutterhead. The mower head will come to a complete stop within a suitable amount of time. Do not engage or disengage the cutterheads at a high RPM unless there is an emergency situation.



Park the tractor on a level surface, place the transmission in park or neutral and apply the parking brake, shut down the engine, remove the key, and wait for all motion to come to a complete stop before exiting the tractor. OPS-B- 0011\_F



**⚠ DANGER**

BEFORE leaving the tractor seat, always engage the brake and/or set the tractor transmission in parking gear, disengage the PTO, stop the engine, remove the key, and wait for all moving parts to stop. Place the tractor shift lever into a low range or parking gear to prevent the tractor from rolling. Never dismount a Tractor that is moving or while the engine is running. Operate the Tractor controls from the tractor seat only. (SG-9)

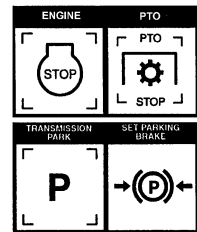

# OPERATION

## 9.8 TRACTOR, BOOM, AND ATTACHED HEAD STORAGE

Properly preparing and storing the unit at the end of the season is critical to maintaining its appearance and to help ensure years of dependable service. The following are suggested storage procedures:

- Thoroughly clean all debris from boom and head to prevent damage from rotting grass and standing water.
- Lubricate all grease points and fill oil levels according to the maintenance lubrication schedule.
- Tighten all bolts to the proper torque. Ensure all pins and other hardware are in place.
- Check the boom arm and head for worn and damaged parts. Perform repairs and make replacements so that the mower will be ready for use at the start of the next season.
- Store the unit in a clean and dry location.
- Use spray touch-up enamel where necessary on bare metal surfaces to prevent rust and to maintain the appearance of the mower.



OPS-B- 0012\_E



Never allow children to play on or around Tractor or Implement. Children can slip or fall off the Equipment and be injured or killed. Children can cause the Implement to shift or fall crushing themselves or others. (SG-25)



BEFORE leaving the tractor seat, always engage the brake and/or set the tractor transmission in parking gear, disengage the PTO, stop the engine, remove the key, and wait for all moving parts to stop. Place the tractor shift lever into a low range or parking gear to prevent the tractor from rolling. Never dismount a Tractor that is moving or while the engine is running. Operate the Tractor controls from the tractor seat only. (SG-9)

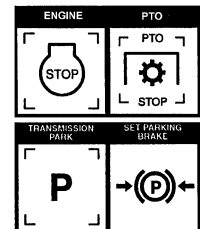

Always shut the Tractor completely down, place the transmission in park, and set the parking brake before you or anyone else attempts to connect or disconnect the Implement and Tractor hitches. (S3PT-15)



Never allow children to play on or around Tractor or Implement. Children can slip or fall off the Equipment and be injured or killed. Children can cause the Implement to shift or fall crushing themselves or others. (SG-25)

# OPERATION

## 10. TRANSPORTING THE TRACTOR AND IMPLEMENT

Inherent hazards of operating the tractor and implement and the possibility of accidents are not left behind when you finish working in an area. Therefore, the operator must employ good judgement and safe operation practices when transporting the tractor and implement between locations. By using good judgement and following safe transport procedures, the possibility of accidents while moving between locations can be substantially minimized. OPS-U- 0017



Never allow children or other persons to ride on the Tractor or Implement. Falling off can result in serious injury or death. (SG-10)



Before transporting the tractor on a public roadway or boarding a trailer for transport, the tractor brake pedals should be locked together. Locking the pedals ensures that both wheels brake simultaneously while stopping, especially when making an emergency stop.

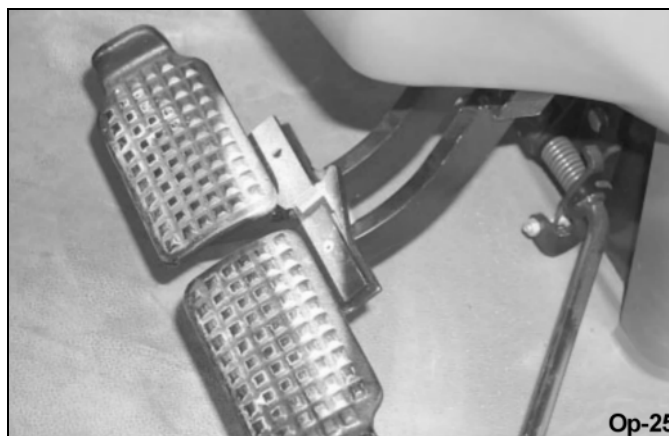

Use extreme caution and avoid hard applications of the tractor brakes when towing heavy loads at road speeds. Never tow the implement at speeds greater than 20 MPH (25 kph). OPS-U- 0018

### 10.1 Transporting on Public Roadways

Extreme caution should be used when transporting the tractor and implement on public roadways. The tractor must be equipped with all required safety warning features including a SMV emblem and flashing warning lights to alert drivers of the tractor's presence. Remember that roadways are primarily designed for automotive drivers and most drivers will not be looking out for you, therefore, you must look out for them. Check your side view mirrors frequently and remember that vehicles will approach quickly because of the tractor's slower speed. Be extremely cautious when the piece of equipment that you are towing is wider than the tractor tire width and/or extends beyond your lane of the road.

Make sure that a proper size safety tow chain is secured between the tractor and implement before entering a public road. OPS-U- 0019

**NOTE:** Ensure that the mower sections are fully raised and that the transport locks are engaged for each section.



# OPERATION

## **WARNING**

Only tow the Implement behind a properly sized and equipped Tractor which exceeds the weight of the Implement by at least 20%. **DO NOT** tow the Implement behind a truck or other type of vehicle. Never tow the Implement and another Implement connected in tandem. Never tow the Implement at speeds over 20 MPH. (STI-06)



## **DANGER**

Never allow children or other persons to ride on the Tractor or Implement. Falling off can result in serious injury or death. (SG-10)



## **WARNING**

Make certain that the "Slow Moving Vehicle" (SMV) sign is installed in such a way as to be clearly visible and legible. When transporting the Equipment use the Tractor flashing warning lights and follow all local traffic regulations. (SG-6)

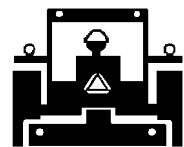

OPERATION

The SMV (Slow-Moving Vehicle) emblem is universal symbol used to alert drivers of the presence of equipment traveling on roadways at a slow speed. SMV signs are a triangular bright orange with reflective red trim for both easy day and night visibility. Make sure the SMV sign is clean and visible from the rear of the unit before transporting the tractor and implement on a public roadway. Replace the SMV emblem if faded, damaged, or no longer reflective. *OPS-U- 0020*



Make sure that all tractor flashing warning lights, headlights, and brake/tail lights are functioning properly before proceeding onto public roads. While newer model tractors have plenty of lighting to provide warning signals and operating lighting, most older models are only equipped with operating lights. Consult an authorized tractor dealer for lighting kits and modifications available to upgrade the lighting on older tractor models. *OPS-U- 0021*



# OPERATION

When operating on public roads, have consideration for other road users. Pull to the side of the road occasionally to allow all following traffic to pass. Do not exceed the legal speed limit set in your country for agricultural tractors. Always stay alert when transporting the tractor and implement on public roads. Use caution and reduce speed if other vehicles or pedestrians are in the area. *OPS-U- 0022*



Reduce speed before turning or applying the brakes. Ensure that both brake pedals are locked together when operating on public roads. *OPS-U- 0023*

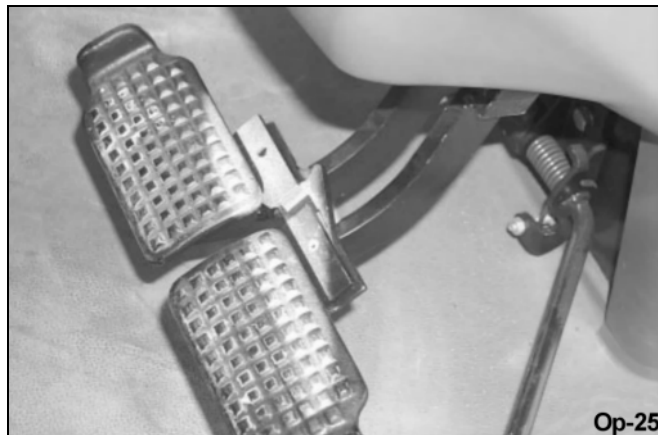

**⚠ DANGER**

When transporting Boom Mower on a truck or trailer, the height or width may exceed legal limits when the boom is in the transport position. Contact with side or overhead structures or power lines can cause property damage or serious injury or death. If necessary lower boom to reduce height and/or remove mowing head to reduce width to the legal limits. (SBM-8)



# OPERATION

## **10.2 Hauling the Tractor and Implement**

Before transporting a loaded tractor and implement, measure the height and width dimensions and gross weight of the complete loaded unit. Ensure that the load will be in compliance with the legal limits set for the areas that will be traveled through. *OPS-U- 0024*



Use adequately sized and rated trailers and equipment to transport the tractor and implement. Consult an authorized dealer to determine the proper equipment required. Using adequately sized chains, heavy duty straps, cables and/or binders, securely tie down both the front and rear of the tractor utilizing the proper tie down locations as specified by the tractor manufacturer. *OPS-U- 0025*



Arrange the chains so that when tightened, the chains are pulling downward and against themselves. Carefully tighten the securing chains or other fasteners using boomers or binders to apply maximum tension. Use extreme care when attaching and removing the securing devices as the extreme tension involved when released has the potential to inflict serious injury.

While hauling the tractor and implement, make occasional stops to check that the tractor and implement have not moved or shifted and that the securing chains have maintained tension. If during transport a hard braking, sharp turning, or swerving action was performed, stop at the next safe location to inspect the security of the load. *OPS-U- 0026*



# OPERATION

## **11. TROUBLESHOOTING GUIDE**

<b>TROUBLE</b>	<b>POSSIBLE CAUSE</b>	<b>POSSIBLE REMEDY</b>
Hydraulic Cylinder Not Working	Hydraulic level low.  Pump not functioning properly. Cylinder not functioning properly. Cylinder has a scored wall, allow oil to flow around piston.	Check hydraulic fluid level. (See sight gauge on tank) Attempt to use another cylinder or pressure gauge. Check line for stoppage.  Replace the cylinder.
Hydraulic Motor Not Working	Kinks or pinched points on the line. Motor "bogging down" under load.	Check line for kinks or pinched places. Recheck relief valve setting on the cutter valve - 2500 PSI.
Hydraulic System Failure	Malfunction in hydraulic valve section.	Check entire system before valve is replaced; may require replacement of hydraulic valve section, but not of the valve bank. Service relief valves and detents individually.

# OPERATION

TROUBLE	POSSIBLE CAUSE	POSSIBLE REMEDY
Structural Members Failure	Rough treatment.	Use only on elements it is designed to cut such as grass, weeds, brush, trees.
Excessive Vibrations	<p>Check Gear box bolts.</p> <p>Check For loose nuts on bladeholder and blades</p> <p>Check for bent output shaft. If shaft is bent oil will normally leak from the bottom seal.</p> <p>Check to see if blades are free swinging.</p> <p>Check for even wear on each blade tip. Were both blades changed at the same time?</p>	<p>Tighten if loose.</p> <p>Tighten If loose</p> <p>Replace shaft if bent.</p> <p>Free blades so they swing</p> <p>Weigh blades. Weight should be within 1 oz. Always replace both blades.</p>
Excessive Vibrations	<p>Blade Broken.</p> <p>Blade carrier bent.</p> <p>Blade hub not properly seated on shaft</p> <p>New Blade or bolts matched</p> <p>Drivelines not phased correctly.</p> <p>Implement &amp; tractor yokes must be in line.</p>	<p>Replace blades, in sets.</p> <p>Replace carrier.</p> <p>Remove hub, check tapered spline shaft, clean and replace.</p> <p>Replace blades or bolts in sets</p> <p>Replace Drivelines.</p>
Gearbox Overheating	<p>Low on lubricant.</p> <p>Improper type lubricant.</p> <p>Excessive trash build-up around gear box</p> <p>Bearing or gears set up improperly</p>	<p>Fill to level plug.</p> <p>Replace with NLGI 000 lubricant.</p> <p>Remove trash.</p> <p>Consult your dealer.</p>
Gearbox Noisy	<p>Rough Gears.</p> <p>Worn Bearing.</p>	<p>Run in or change gears.</p> <p>Replace bearing.</p>
Noise	<p>Damaged Belt Shield (Rubbing on pulleys or belt).</p> <p>Worn Bearing or Gear.</p>	<p>Straighten or replace Shields.</p> <p>Replace Bearing or Gear.</p>
PA91 02/08	Operation Section 4-45	

# OPERATION

TROUBLE	POSSIBLE CAUSE	POSSIBLE REMEDY
Gearbox Leaking	Damaged oil seal Bent shaft. Shaft rough in oil seal area. Oil seal installed wrong. Oil seal not sealing in the housing. Oil level too high. Sand hole is casting. Gasket damaged. Bolts loose.	Replace seal. Replace oil seal and shaft. Replace or repair shaft. Replace seal. Replace seal or use a sealant on OD of Seal. Drain oil to proper level. Replace castings or gearbox. Replace gasket. Tighten bolts.
Clutch Slips Excessively	Clutch linings badly worn or plates warped. Too much power for clutch intake. Oil on facings. Friction facings glazed.	Repair clutch per maintenance section of manuals. Reduce ground speed and material Replace facings. Clean with emery cloth.
Knives Wear Too Fast	Cutting in sandy conditions. Cutting in rocky conditions. Soft "will fit" knives.	Increase cutting height. Increase cutting height. Use genuine Alamo Industrial knives.

# **MAINTENANCE SECTION**

Maintenance Section 5-1

# MAINTENANCE

## LUBRICATION

### General

Refer to the lubrication diagram and grease daily all the points shown.

1. Power take-off shaft - The PTO shaft should be regularly examined to ensure that it is in good condition together with the guards. The universal joints should be greased very sparingly, i.e., one shot a week.

**NOTE:** Overgreasing a universal joint will blow out the cork or neoprene sealing rings that exclude the dirt from the needle bearing inside.

2. The two halves of the plastic guard should be checked daily to ensure that they can spin freely on the shaft. The nylon slip rings which support the guard on the drive shaft should be lightly greased at weekly intervals.
3. The telescoping drive shaft should be similarly separated and grease applied to the internal shaft at approximately 100 hour intervals.

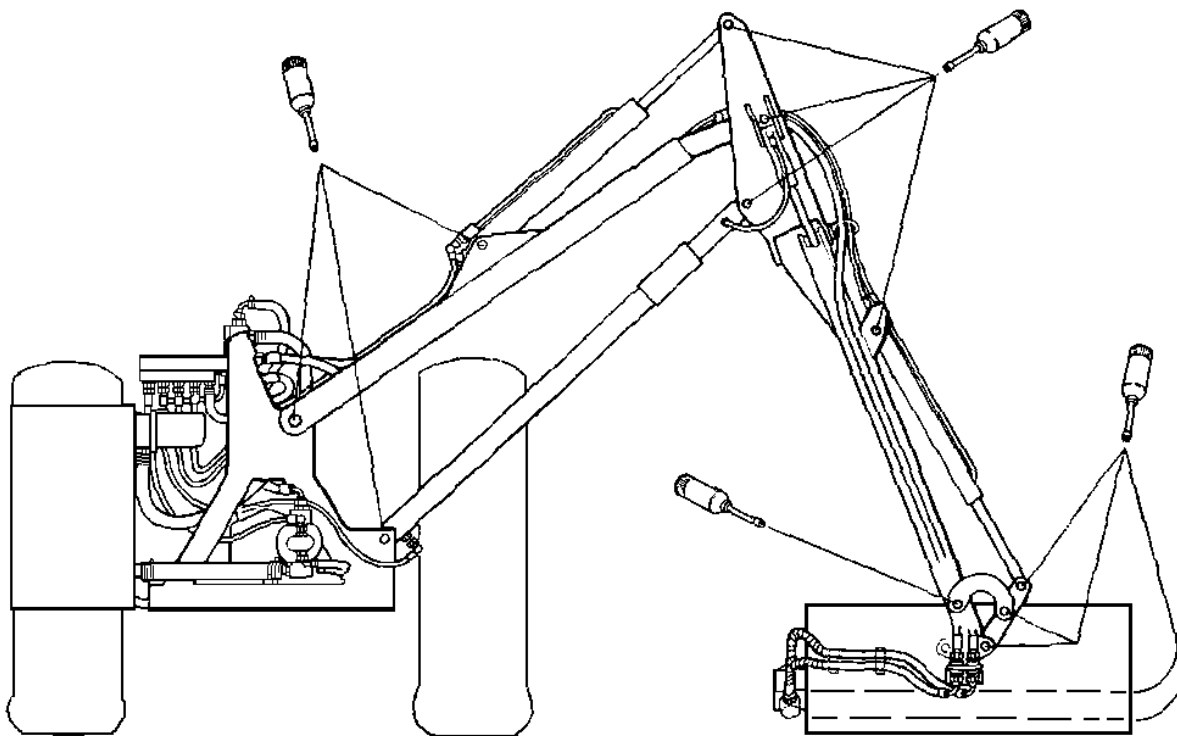

MNT-FL-0074



# MAINTENANCE

## HYDRAULIC SYSTEM

### Oil Supply

Check the oil level in the reservoir daily. The first oil change should take place the first 250 hours of operation and every 500 hours or every 12 months thereafter. Although the oil does not wear out, it does eventually break down through contamination, oxidation and condensation. Continual operation of the machine beyond its rated capacity to almost the stall point of the rotor can cause overheating which produces insoluble gums, sludge, varnish and acids. Overheated oil thins to give a sluggish performance and causes earlier failure of seals and "O" rings. Burnt and scorched oil odors and the oil darkening and thickening are all signs of oxidation and indicate the oil should be changed.

Moisture which results from condensation can become entrapped in the oil and cannot be removed by filtration so that contamination is a progressive factor.

Contamination can be reduced by:

1. Carrying all hydraulic servicing in clean, dust-free surrounding.
2. Cleaning off around the reservoir cap before removal, and keeping that area clean.
3. Using clean containers when replenishing the system.
4. Regular servicing of the filtration system.

### Filtration Maintenance

The machine is protected by a 125 micron suction strainer and a low pressure 10 micron full flow return line filter.

#### 1. Suction Strainer

The strainer is fixed in position within the reservoir. Should indications of pump cavitation or spongy intermittent operation occur the tank must be drained and flushed out with a suitable cleaning agent, e.g. clean diesel oil.

#### 2. Return Line Filter

The element should be changed after the first 50 hours and thereafter at 400 hour intervals or every 12 months. It is important to note hours worked as if the filter becomes blocked. An internal by-pass within the canister will operate and no symptoms of filter malfunction will occur to jog your memory.

## FLOAT KIT ACCUMULATOR TEST

If a leak of Nitrogen is suspected, a test with soapy water around the valve thread and core area should be carried out. A replacement charge valve assembly can be fitted after the accumulator has been fully discharged. It is essential that this work is carried out by the dealer or distributor who must have the facilities for recharging. The accumulator can be removed for this purpose. If oil is leaking from the area of the charge valve then the internal butyl bag is damaged and the accumulator is scrap.

# MAINTENANCE

## MAINTENANCE

### HYDRAULIC PUMPS

1. All pumps are rotate clockwise. No routine maintenance is necessary other than a periodical check for tightness of the mounting bolts and a visual check for oil leakage especially around the pump supply and pressure unions. Where two hose clips are used on the pump supply hose, their worm drive barrels should be placed opposite each other at 180 degrees. When fitted with tandem pump assembly, do not attempt to operate the harmed rams without the 5/8 BSP flail hoses being interconnected. The tandem pumps share a common seal drain and both circuits must be intact before the pumps are run.
2. Pump serving is limited to replacing seals, gaskets and "O" rings. Servicing should take place under clean dust free conditions. Pumps should be thoroughly washed and their end plates and body lightly identified with scribe marks to ensure correct reassembly.
3. When reassembly, lubricate all components with clean oil and tighten down the securing bolts in a diagonal sequence to pull the pumps squarely together. Finally, tightening to a torque load of:  
  
4 - 5 KGM (30-37 lbs/ft.) M10 Setscrew  
2-1/2 to 3 KGM (18-22 lbs/ft.) M8 Setscrew
4. Check for freedom of rotation. The pumps should turn freely under a hand load applied on a 6" radius arm. If tight, the lobe seals and/or backing washers have been trapped and the unit must be dismantled to rectify this.
5. After installation, the serviced pumps should be run for several minutes under a "no load" condition before load is gradually applied. During this time, frequent checks should be made of the pump casing temperature. An excessive temperature rise will indicate that the pump has been assembled incorrectly.
6. Generally, it is unwise to replace major components since they have to be matched in sets. Unless this is done, the pump will be inefficient resulting in overheating and power loss. No detailed parts breakdown is shown, but factory reconditioned units are available within our service exchange scheme.

### FLAILHEAD

1. Frequently inspect the rotor assembly for damaged or missing flails. Bolts and nuts securing the flails to the rotor should be regularly checked and kept tight. The correct torque setting for these locknuts is 135 Nm (100 lbs/ft.). Use only the correct flail bolt and locking nut. Check the flail pivot bushes for possible damage or wear. They do not require oil.
2. Do not attempt to run the rotor with flails missing. Imbalance will cause severe vibration and can rapidly damage the rotor shaft bearings. As an emergency measure, if a flail is broken off or lost, remove another on the opposite site of the rotor to retain balance. Always replace flails in opposite pairs and never match up a new flail with a resharpended one which will of course be lighter.
3. Blunt flails absorb a lot of power and leave an untidy finish to work. They should be sharpened on a grindstone or with a portable grinder periodically. Wear protective gear when sharpening flails.
4. Ensure that the bearing housings and hydraulic mounting nuts and bolts are kept tight. They should be checked during servicing.

# MAINTENANCE

## CABLE OPERATED ARMHEAD CONTROL VALVE

### Replacing Damaged or Worn Spool "O" Rings

1. Release the locknut located on the cable at the back of the sleeve.
2. Remove the two allen headed capscrews that secure the sleeve to the valve block and screw the sleeve back down the threaded portion of the cable to reveal the clevis pin which is then withdrawn from the end of the spool. Take care not to lose the roller in the eye of the spool end.
3. Remove the spring cover at the opposite end of the spool and remove the setscrew to release the return spring assembly.
4. Pull the spool through the block out of the return spring end.
5. Remove the "O" ring marked "B" and refit a new "O" ring.
6. Lightly oil the spool and replace it in the block from the return spring end, pushing it through just far enough to clear "O" ring groove at "A".
7. Fit new "O" ring in groove "A".
8. Push the spool back through from the cable end far enough to reassemble the return spring assembly and cover.
9. Replace the clevis pin in the spindle eye and reassemble the sleeve. Adjustment of the threaded section, being correct when the handle on the control box, is in a vertical position. Retighten the locknut.

**NOTE:** Owing to the sharp edges in the design of the spool, failure to follow the above procedure could result in damage to the new "O" rings resulting in external leakage.

10. The spools are selectively assembled, matched with their mating bores in the block and should not be interchanged.

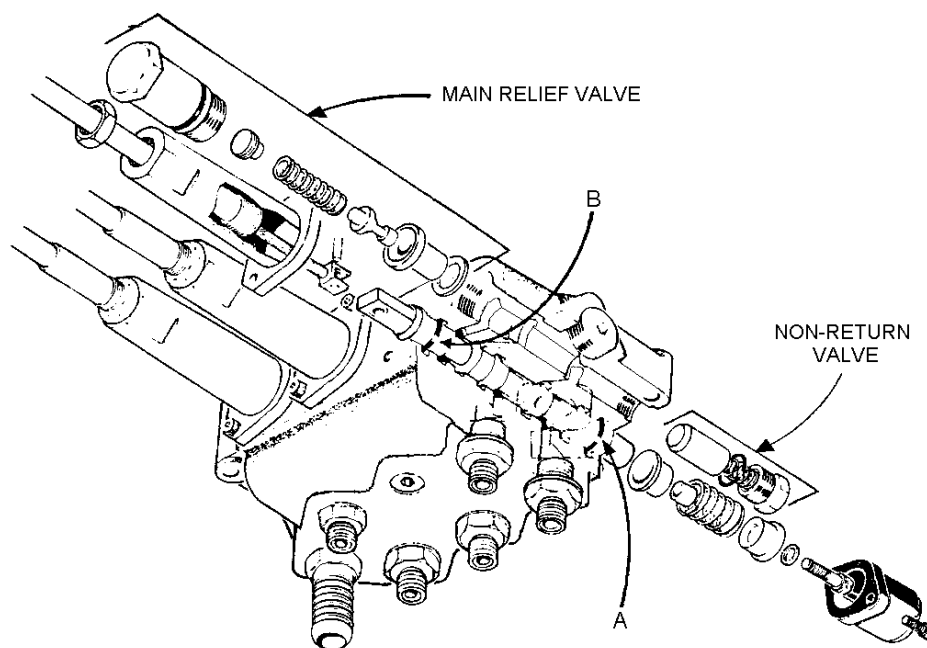

MNT-FL-0075

# MAINTENANCE

## Main Relief Valve

The main relief valve is pressure set at the factory to 1800 PSI (125 Bar) and is non-adjustable. A sticking relief valve will probably cause overheating and/or loss of power. If this is suspected, it should be dismantled and examined for dirt and damage. Undo the large hexagon housing, the relief valve spring, needle and seat can now be withdrawn. If difficulty is experienced in extracting the seat, remove the non-return valve at the opposite end of the gallery and drive out with a soft brass drift. Take care not to damage the copper sealing washer positioned between the seat and the locating shoulder on the block.

Blow out the valve with compressed air and examine the components for damage. These components are specially hardened steel and should only display a seating witness. Any further damage will require the valve to be replaced.



Under no circumstances be tempted to add shims into this valve in a misguided attempt to increase the power of the machine. This could damage the tractor, and may cause personal injury.

## Non-Return Valve

The non-return valve prevents the feed back of oil from the service ports to the pump. It is unlikely to need attention, but if removed for cleaning, a new "O" ring should be fitted.

## CABLES

The cables operate on a push/pull system with the spool centering springs always returning the spool to the neutral position when the handle is released.

Care should be taken during installation and operation to ensure that the cables are not trapped or kinked. Any abrasion or damage to the outer casing should be sealed with plastic insulation tape to avoid moisture penetrating.

No routine adjustment of the cables are necessary as they do not stretch. The threaded collar is correctly adjusted when the lever is in a vertical position in its housing allowing an equal amount of travel in either direction.



On no account should any attempt be made to lubricate the cables which are assembled with a special lubricant during manufacture.

**NOTE:** Be careful in determining the correct cable connections on both the control unit and the valve in the event of cable replacement.

# MAINTENANCE

## HYDRAULIC RAMS

### Ram Seal Replacement - General Information

11. Whenever possible the ram should be removed from the machine and cleaned off before dismantling on a clean work bench.
12. When using a bench vice, do not apply excessive pressure to the ram cylinder - use soft metal jaws when grasping the ram rod.
13. Lubricate all new seals thoroughly prior to assembly.

### Angling Arm

#### Replacing Seals

1. Unscrew the gland and withdraw the complete rod assembly. Remove piston locking nut, slide the piston and gland housing of the rod.
2. Lubricate all new seals prior to assembly.
3. Replace the gland seals ensuring they are positioned in the same location from which they were removed. Carefully place the gland housing complete with seals back on the rod.
4. Separate the piston halves and discard rod seals. Rebuild the piston onto the rod, fitting a new piston rod "O" ring.
5. The piston seals can be replaced in conjunction with the above operation, or alternatively, gently pried into position after the piston and locking nut are reassembled.
6. Refit the piston locking nut using "Permabond A113" or a similar medium strength thread locking compound.
7. Reassemble the complete rod into the ram cylinder. Screw in gland housing and tighten.

### Reach Ram

#### Renewing Gland Seals

1. Unscrew the gland nut using a C spanner and withdraw the complete rod assembly.
2. Remove the piston using a peg scanner and slide off the gland housing.
3. Replace the seals as necessary.
4. Ensure that seals are replaced in the same attitude and in the same position from which they came.

#### Refitting a Piston

The piston is locked onto the rod with a medium strength thread locking fluid such as "Permabond A113", "Loctite Nutloc 242", "Dunlop Nutloc SA5110", "Tru lock Nutgrade 375" or "Hermitite Torqueseal M". The threads must be cleaned with a suitable solvent to remove oil and thoroughly dried before applying a complete film of locking fluid to the rod threads. The piston should be screwed on, tightened firmly and left for 30 minutes before filling with oil and 1 hour before pressurizing.

# MAINTENANCE

## ROTOR CONTROL VALVE/RELIEF VALVE

### Relief Valve

The relief valve within the block is pre-calibrated to give setting of 3000 PSI (210 Bar). No servicing should be required other than cleaning and examining for damage should a malfunction occur. Evidence or damage will require a new component.

### Replacing Worn or Damaged "O" Rings

1. The cable and spring centering mechanism must be removed. The brass bobbin at either end can be extracted and the "O" rings can be removed from their locations using a soft hooked implement.
2. Replace the "O" rings carefully feeding them over the spool ends.
3. Replace the brass bobbins and reassemble the spring centering mechanism and cable to the valve.

## P.T.O. GEARBOX

The gearbox is rigidly bolted on to the main frame and has a filler plug. Oil level is correct when level with the lip of the filler plug aperture. The gearbox oil should be changed every two years or a 1000 hour intervals; whichever occurs first. The capacity of the gearbox is 700 milliliters (1-1/4 pints) of EP 90 gear oil.

## HYDRAULIC MOTOR

Servicing of the hydraulic motor should be limited to replacing seals, gaskets and O rings. Components of the motor are matched to close tolerances and are therefore not replaceable as individual parts.

The torque setting of the cap screws is 6-7 KGM (40-47 lbs/ft.).

To remove the drive coupling from the shaft, use a tool of the sprocket type to remove it. Do not attempt to remove the coupling by hammering or leverage as this will damage the motor internally.

# MAINTENANCE

## Replacing Shaft Seals

1. The double shaft seal assembly must be assembled with the 7 MM. wide single lip seal fitted first with the 1 MM. thick lip support washer on top.
2. The back of the double lip seal should be filled with a light grease before fitting with the wiper lip outermost.
3. The seal kit, Part No. 86-99-166 is a universal Cassapa motor sealkit. It may contain more seals than are necessary; care must be taken in selecting the correct seal to use.

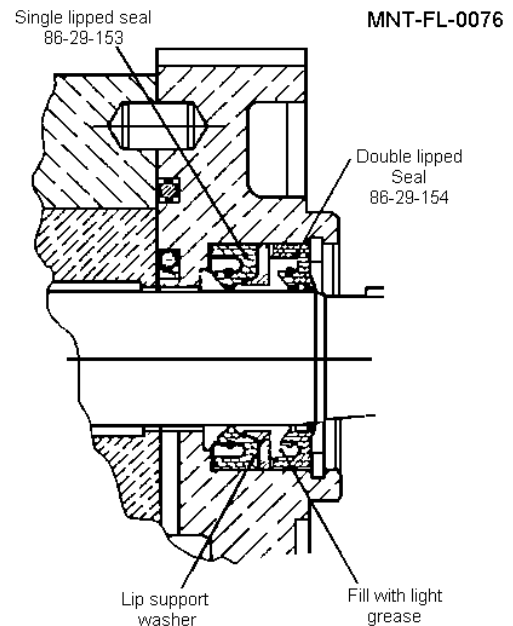

## HYDRAULIC HOSES

The condition of all hoses should be carefully checked during routine service of the machine. Hoses that have been chafed or damaged on their outer casing should be securely wrapped with waterproof adhesive tape to stop the metal braid from rusting. Hoses that have suffered damage to the metal braid should be changed at the earliest opportunity.

### Hose Replacement

1. Replace one hose at a time to avoid the risk of wrong connections.
2. When the hose is screwed to an additional fitting or union, use a second spanner on the union to avoid breaking seals.
3. Do not use jointing compound on the threads.
4. Avoid twisting the hose. Adjust the hose line to ensure freedom from rubbing or trapping before tightening hose end connections.
5. Before changing hoses, study the installation. These should be positioned so that their worm drive barrels are opposed at 180 degrees to reduce the possibility of air entering the system.

### Hose Warranty

Warranty is limited to replacement of hoses which have failed due to faulty materials or manufacture. Warranty will not be considered on hoses that have suffered damage by abrasions, cuts or being pinched or trapped while in work. Neither will a claim be considered where a hose end has been damaged by a blow or where the threads or unions have been damaged by overtightening.

# ALAMO-INDUSTRIAL LIMITED WARRANTY

## 1. LIMITED WARRANTIES

- 1.01. Alamo Industrial warrants for one year from the purchase date to the original non-commercial, governmental, or municipal purchaser ("Purchaser") and warrants for six months to the original commercial or industrial purchaser
- 1.02. Manufacturer will replace for the Purchaser any part or parts found, upon examination at one of its factories, to be defective under normal use and service due to defects in material or workmanship.
- 1.03. This limited warranty does not apply to any part of the goods which has been subjected to improper or abnormal use, negligence, alteration, modification, or accident, damaged due to lack of maintenance or use of wrong fuel, oil, or lubricants, or which has served its normal life. This limited warranty does not apply to any part of any internal combustion engine, or expendable items such as blades, shields, guards, or pneumatic tires except as specifically found
- 1.04. Except as provided herein, no employee, agent, Dealer, or other person is authorized to give any warranties of any nature on behalf of Manufacturer.

## 2. REMEDIES AND PROCEDURES.

- 2.01. This limited warranty is not effective unless the Purchaser returns the Registration and Warranty Form to Manufacturer within 30 days of purchase.
- 2.02. Purchaser claims must be made in writing to the Authorized Dealer ("Dealer") from whom Purchaser purchased the goods or an approved Authorized Dealer ("Dealer") within 30 days after Purchaser learns of the facts on which the claim is based.
- 2.03. Purchaser is responsible for returning the goods in question to the Dealer.
- 2.04. If after examining the goods and/or parts in question, Manufacturer finds them to be defective under normal use and service due to defects in material or workmanship, Manufacturer will:
  - (a) Repair or replace the defective goods or part(s) or
  - (b) Reimburse Purchaser for the cost of the part(s) and reasonable labor charges (as determined by Manufacturer) if Purchaser paid for the repair and/or replacement prior to the final determination of applicability of the warranty by Manufacturer.

The choice of remedy shall belong to Manufacturer.

- 2.05. Purchaser is responsible for any labor charges exceeding a reasonable amount as determined by Manufacturer and for returning the goods to the Dealer, whether or not the claim is approved. Purchaser is responsible for the transportation cost for the goods or part(s) from the Dealer to the designated factory.

## 3. LIMITATION OF LIABILITY.

- 3.01. MANUFACTURER DISCLAIMS ANY EXPRESS (EXCEPT AS SET FORTH HEREIN) AND IMPLIED WARRANTIES WITH RESPECT TO THE GOODS INCLUDING, BUT NOT LIMITED TO, MERCHANTABILITY AND FITNESS FOR A PARTICULAR PURPOSE.
- 3.02. MANUFACTURER MAKES NO WARRANTY AS TO THE DESIGN, CAPABILITY, CAPACITY, OR SUITABILITY FOR USE OF THE GOODS.
- 3.03. EXCEPT AS PROVIDED HEREIN, MANUFACTURER SHALL HAVE NO LIABILITY OR RESPONSIBILITY TO PURCHASER OR ANY OTHER PERSON OR ENTITY WITH RESPECT TO ANY LIABILITY, LOSS, OR DAMAGE CAUSED OR ALLEGED TO BE CAUSED DIRECTLY OR INDIRECTLY BY THE GOODS INCLUDING, BUT NOT LIMITED TO, ANY INDIRECT, SPECIAL, CONSEQUENTIAL, OR INCIDENTAL DAMAGES RESULTING FROM THE USE OR OPERATION OF THE GOODS OR ANY BREACH OF THIS WARRANTY. NOT WITHSTANDING THE ABOVE LIMITATIONS AND WARRANTIES, MANUFACTURER'S LIABILITY HEREUNDER FOR DAMAGES INCURRED BY PURCHASER OR OTHERS SHALL NOT EXCEED THE PRICE OF THE GOODS.
- 3.04. NO ACTION ARISING OUT OF ANY CLAIMED BREACH OF THIS WARRANTY OR TRANSACTIONS UNDER THIS WARRANTY MAY BE BROUGHT MORE THAN TWO (2) YEARS AFTER THE CAUSE OF ACTION HAS OCCURRED.

## 4. MISCELLANEOUS.

- 4.01. Proper Venue for any lawsuits arising from or related to this limited warranty shall be only in Guadalupe County, Texas.
- 4.02. Manufacturer may waive compliance with any of the terms of this limited warranty, but no waiver of any terms shall be deemed to be a waiver of any other term.
- 4.03. If any provision of this limited warranty shall violate any applicable law and is held to be unenforceable, then the invalidity of such provision shall not invalidate any other provisions herein.
- 4.04. Applicable law may provide rights and benefits to purchaser in addition to those provided herein.

### KEEP FOR YOUR RECORDS

ATTENTION: Purchaser should fill in the blanks below for his reference when buying repair parts and/or for proper machine identification when applying for warranty.

Alamo Industrial Implement Model \_\_\_\_\_

Serial Number \_\_\_\_\_

Date Purchased \_\_\_\_\_

Dealer \_\_\_\_\_

ATTENTION: \_\_\_\_\_

READ YOUR OPERATOR'S MANUAL

**ALAMO INDUSTRIAL**  
An Alamo Group Company  
Post Office Drawer 549  
Seguin, Texas 78156  
830-379-1480

BC-0002







# TO THE OWNER/OPERATOR/DEALER

To keep your implement running efficiently and safely, read your manual thoroughly and follow these directions and the Safety Messages in this Manual. The Table of Contents clearly identifies each section where you can easily find the information you need.

The OCCUPATIONAL SAFETY AND HEALTH ACT (1928.51 Subpart C) makes these minimum safety requirements of tractor operators:

## REQUIRED OF THE OWNER:

1. Provide a Roll-Over-Protective Structure that meets the requirements of this Standard; and
2. Provide Seatbelts that meet the requirements of this paragraph of this Standard and SAE J4C; and
3. Ensure that each employee uses such Seatbelt while the tractor is moving; and
4. Ensure that each employee tightens the Seatbelt sufficiently to confine the employee to the protected area provided by the ROPS.

## REQUIRED OF THE OPERATOR

1. Securely fasten seatbelt if the tractor has a ROPS.
2. Where possible, avoid operating the tractor near ditches, embankments, and holes.
3. Reduce speed when turning, crossing slopes, and on rough, slick, or muddy surfaces.
4. Stay off slopes too steep for safe operation.
5. Watch where you are going - especially at row ends, on roads, and around trees.
6. Do not permit others to ride.
7. Operate the tractor smoothly - no jerky turns, starts, or stops.
8. Hitch only to the drawbar and hitch points recommended by the tractor manufacturer.
9. When the tractor is stopped, set brakes securely and use park lock, if available.

- Keep children away from danger all day, every day...
- Equip tractors with rollover protection (ROPS) and keep all machinery guards in place...
- Please work, drive, play and live each day with care and concern for your safety and that of your family and fellow citizens.



BC-0001

## Free Manuals Download Website

<http://myh66.com>

<http://usermanuals.us>

<http://www.somanuals.com>

<http://www.4manuals.cc>

<http://www.manual-lib.com>

<http://www.404manual.com>

<http://www.luxmanual.com>

<http://aubethermostatmanual.com>

Golf course search by state

<http://golfingnear.com>

Email search by domain

<http://emailbydomain.com>

Auto manuals search

<http://auto.somanuals.com>

TV manuals search

<http://tv.somanuals.com>