



INTERSTATER

Assembly Instruction

Manual

New Holland (Cab or Rops Tractor)
TS-100A, TS-115A, TS-125A & TS-135A



Tractors equipped with additional options, special equipment, tractor manufacturer modifications, new tractor models, or Customer alterations may prevent this Mount Kit from being properly mounted to the tractor. Alamo Group is not responsible for modifications to the MountKit to accommodate these differences.

ALAMO INDUSTRIAL

1502 E. Walnut
Seguin, Texas 78155
210-379-1480

© 2004 Alamo Group Inc.

Manual
P/N 02981188



TO THE OWNER/OPERATOR/DEALER

All implements with moving parts are potentially hazardous. There is no substitute for a cautious, safe-minded operator who recognizes the potential hazards and follows reasonable safety practices. The manufacturer has designed this implement to be used with all its safety equipment properly attached to minimize the chance of accidents.

BEFORE YOU START!! Read the safety messages on the implement and shown in your manual. Observe the rules of safety and common sense!



DANGER

FAILING TO FOLLOW SAFETY MESSAGES AND OPERATING INSTRUCTIONS CAN CAUSE SERIOUS BODILY INJURY OR EVEN DEATH TO OPERATOR AND OTHERS IN THE AREA.

1.

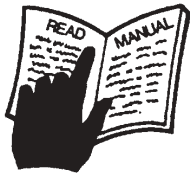

2. NO RIDERS. NO CHILDREN OPERATORS.



3. USE SAFETY SHOES, HARD HAT, SAFETY GLASSES, SEAT BELTS, ROPS & OPS



4. BLOCK UP SECURELY BEFORE WORKING UNDER.



1. Study and understand Operator's Manuals, Safety Decals, and Instructional Decals for tractor and implement to prevent misuse, abuse, and accidents. Practice before operating in a confined area or near passersby.

● Learn how to stop engine suddenly in an emergency. Be alert for passersby and especially children

2. Allow no children on or near folding mower or tractor. Allow no riders on tractor or implement. Falling off may cause serious injury or death from being run over by tractor or mower or contact with rotating blades.

3. Operate only with tractor having Roll-Over Protective Structure (ROPS) and with seat belt securely fastened to prevent injury and possible death from falling off or tractor overturn.

● Personal Protective Equipment such as Hard Hat, Safety Glasses, Safety Shoes, & Ear Plugs are recommended.

4. Block up or support raised machine and all lifted components securely before putting hands or feet under or working underneath any lifted component to prevent crushing injury or death from sudden dropping or inadvertent operation of controls. Make certain area is clear before lowering or folding

5. Before transporting, put Lift Lever in detent or full-lift position. Install Transport Safety Devices securely on folding mowers. Put Booms securely in Transport Rest.

● Folding and Boom Mowers have raised center of gravity. Slow down when turning and on hillsides.

6. Make certain that SMV sign, warning lights, and reflectors are clearly visible. Follow local traffic codes.

7. Never operate with Cutting Head or Folding Section raised if passersby, bystanders, or traffic are in the area to reduce possibility of injury or death from objects thrown by Blades under Guards or mower structure.

8. Before dismounting, secure implement in transport position or lower to ground.

● Put tractor in park or set brake, disengage PTO, stop engine, remove key, and wait until noise of rotation has ceased to prevent crushing by entanglement in rotating parts which could cause injury or death.

● Never mount or dismount a moving vehicle. Crushing from runover may cause serious injury or death.

5. TRANSPORT SAFELY, LOCK UP.

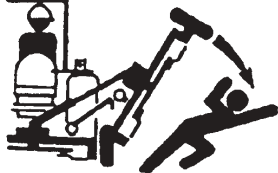

6. USE SMV, LIGHTS, & REFLECTORS.

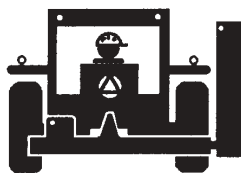

7. DO NOT OPERATE WITH CUTTER OR WING RAISED.



8. DO NOT MOUNT OR DISMOUNT WHILE MOVING.



02967827

WARRANTY INFORMATION:

Read and understand the complete Warranty Statement found in this Manual. Fill out the Warranty Registration Form in full and return it within 30 Days. Make certain the Serial Number of the Machine is recorded on the Warranty Card and on the Warranty Form that you retain. The use of "will-fit" parts will void your warranty and can cause catastrophic failure with possible injury or death.

INTRODUCTION

ABOUT THIS MANUAL:

The intent of this publication to provide the competent technician with the information necessary to perform the CORRECT Assembly to the Alamo Industrial Product. This will, in turn provide for complete customer satisfaction

It is hoped that the information contained in this and other Manuals will provide enough detail to eliminate the need for contact of the Alamo Industrial Technical Service Dept. However, it should be understood that many instances may arrive where correspondence with the Manufacturer is necessary.

CONTACTING MANUFACTURER: (Please help us Help You! Before You Call!)

Alamo Industrial Service Staff Members are dedicated to helping you solve your problem, or your customer's service problem as quickly and efficiently as possible. Unfortunately, we receive entirely to many calls with only a minimum amount of information. In some cases, the correspondent has never gone out to look at the equipment and merely calls inquiring of the problems described to him by the operator or customer.

Most calls received by Alamo Industrial Service can be classified into approx. 6 general categories.

1. Hydraulic or Mechanical Trouble Shooting.
2. Request for Technical Information or Specifications.
3. Mounting or Fitting Problem.
4. Special Service Problem.
5. Equipment Application Problems.
6. Tractor Problem Inquiries.

HOW YOU CAN HELP:

Make sure the call is necessary! Most of the calls received may not be necessary if the Dealer Service Technician would do the following.

1. Check the Service Information at your Dealership provided by Alamo Industrial, This would include, Service Bulletins, Information Bulletins, Parts Manuals, Operators Manuals, Assembly Manual or Service Manual, many of these are available via the Alamo Industrial Internet site (www.Alamo-Industrial.Com). Attempt to diagnose or repair problem before calling.

2. If a call to Alamo Industrial is needed, Certain Information should be available and ready for the Alamo Industrial Service Staff. Such information as, Machine Model, Serial Number, Your Dealer Name, Your Account Number and Any other information that will be useful. This information is vital for the development of a prompt and correct solution to the problem. This will also help to develop a database of problems and related solutions, which will expedite a solution to future problems of a similar nature.

3. The technician may be asked to provide detailed information about the problem including the results of any required trouble shooting techniques. If the information is not available, The technician may be asked to get the information and call back. Most recommendations for repairs will be based on the procedures listed in the Service Manual / Trouble Shooting Guide and Information provided by customer.

CONTACT ALAMO INDUSTRIAL:

Alamo Industrial, 1502 E. Walnut St. Seguin TX. 78155, Technical Service Dept. PH: 830-379-1480

INDEX - ASSEMBLY INSTRUCTION

	Page
Index	
Introduction.....	Index 1
General Index.....	Index 2 & 3
User / Assmby Notes.....	Index 4
Section 1	
Pre-Delivery Check List.....	1-1 to 1-4
Section 2	
Mainframe Assembly.....	2-1 to 2-5
Prepare Tractor.....	2-2
Prepare Main frame.....	2-2
Mount Frame Mounting Rails.....	2-2
Removed Parts From Tractor.....	2-2
Install Mainframe.....	2-3 to 2-4
Prepare & Mount Valve Assembly.....	2-5
Section 3	
Pump - Driveshaft - Hyd. Tank.....	3-1 to 3-9
Pump & Driveshaft Schematic.....	3-2
Prepare Tractor.....	3-3
Install Driveshaft & Pumps.....	3-3 to 3-4
Connect Fittings & Hoses To Pumps.....	3-4 to 3-6
Connect Hoses to Frame.....	3-7 to 3-9
Connect Hoses to Tank & Valve.....	3-8 to 3-9
Install Return Pressure Gauge.....	3-8
Install Oil Level Sight Glass in Tank.....	3-8
Install Oil Temperature Gauge.....	3-8
Install Motor & Valve Tank Return Lines.....	3-8
Section 4	
Remote Control Cable Connections.....	4-1 to 4-11
Cylinder to Valve Hose Connections.....	4-1 to 4-11
Remote Control Handles Installation (Cab Tractor Only).....	4-4 to 4-5
Remote Control Handles Installation (ROPS Tractor Only).....	4-6
Remote Handle Assembly to Cables	4-7 to 4-9
Hydraulic Hose Routeing, Valve to Cylinders.....	4-9
Wire Harness Connections.....	4-10 to 4-11

INDEX - ASSEMBLY INSTRUCTION

	Page
Section 5	
Modify tractor Exhaust system.....	5-1 to 5-3
Section 6	
Tractor Fuel Tank Replacement.....	6-1 to 6-2
Section 7	
Wing Mower Installation.....	7-1 to 7-11
Wing Mower Cut Off Switches.....	7-1 to 7-5
Wing Mower Hose Connections.....	7-6 to 7-11
Wiring Schematic.....	7-7
Pump & Motor Hydraulic Schematic.....	7-8 to 7-11
Section 8	
Rear Mower Installation.....	8-1 to 8-5
Initial Start-Up Procedure.....	8-4 to 8-7
Lubrication chart.....	8-5
Hydraulic Tank Filling Procedure.....	8-6
Section 9	
Tractor & Mower Mounting Requirements.....	9-1 to 9-5

NOTES

Section 1

INTERSTATER

New Holland

TS100A, TS115A

TS125A, TS135A

Tractor

PRE-DELIVERY INSPECTION

CHECKLIST

PRE-DEL INSPECTION CHECKLIST

Pre-Operation Inspection: Check the following items before operating the unit to assure that they are properly assembled. (See following page 1-4 for component location)

Safety Equipment:

- ___ Operators Manual is with Unit.
- ___ The Safety Decals are installed as listed in the Assembly Manual.
- ___ Valve operation plate is installed.
- ___ Operators cage or Tractor Cab is in place
- ___ Deflectors are installed on the Mower Head
- ___ Tractor Rops or Cab with seatbelts installed properly.
- ___ All Foot Guards and safety switch are installed and functional.

Frame:

- ___ Axle Plate Bolts are torqued.
- ___ Head Mounting Bolts tightened.
- ___ Frame attaching Bolts tightened.
- ___ Front Support Bolts are torqued.
- ___ Hydraulic Tank mounting Pins / Bolts in place correctly.
- ___ All Welds inspected to insure proper welds and locations.

Hydraulic System:

- ___ Oil Level in Hydraulic Tank is within the sight gauge. (Item 5 page 1-4)
- ___ Hose connections are tight.
- ___ Hoses do not have any kinks or twist in them.
- ___ Front Pump Shaft adapter bolts are tight.
- ___ Front Pump Shaft Coupler / Drive Shaft is lubricated and has an anti-seize compound on the Splines of Pump and Shafts.
- ___ The Pump Drive Shaft has correct alignment.
- ___ Suction Hose has no leaks or kinks.

Flail Mower Head:

- ___ Skid Shoe Bolts are torqued to 120 ft-lbs
- ___ Motor Bolts are torqued to 120 ft-lbs
- ___ Belt Alignment & tension adjustment is correct.
- ___ Cutter shaft bearings are properly lubricated
- ___ Roller bearings are properly lubricated
- ___ Blades swing freely.
- ___ All Pins and Clips for Rear Mower are installed
- ___ Clutch on Rear Mower has been checked for proper adjustment and conditions per parts book requirements.
- ___ All Belt guards are installed correctly.

PRE-DEL INSPECTION CHECKLIST

Pre-Operation Inspection: Check the following items before operating the unit to assure that they are properly assembled. (See following page 1-4 for component location)

Tractor Mower Operation Inspection:

Using all Safety precautions, operate the Tractor and Mower unit for 30 minutes and while the unit is running check the following items: **Note!** Only make adjustments after the mower has been turned off and all motion has stopped and all hydraulic pressure has been relieved.

- ___ Check for Hydraulic oil leaks at the hose connections
- ___ Operate the boom and mower head throughout its full range of motion and check for hose's rubbing, pinching, or kinking.
- ___ Make sure the Return Filter Gauge is reading in the Green after Oil is warm.
- ___ Check the function of the Mower Head On-Off Valve and switch for proper function
- ___ Make sure that the tractor will not start with the mower on-off switch in the on position.
- ___ Check the Blade Rotation for the Rotary Mower Head to make sure it is turning Clockwise looking from the top of the mower deck.
- ___ Make sure the control valve boom movements agree with the valve operation decal.
- ___ Make Sure Boom Movement operates as expected and is smooth and under control (no air in the control system)
- ___ Look for any unusual or excessive noise or vibrations.
- ___ Make sure the left rear wheel of the tractor stays on the ground when the boom is fully extended horizontally with 200 lbs. placed on the outside of the mower head.

Post-Operation Inspection:

- ___ Check that the oil in the hydraulic tank has not turned milky in color or has foam on top.
- ___ Check that there are no loose fasteners or hardware.

Tractor - Mower Component Location

Check List

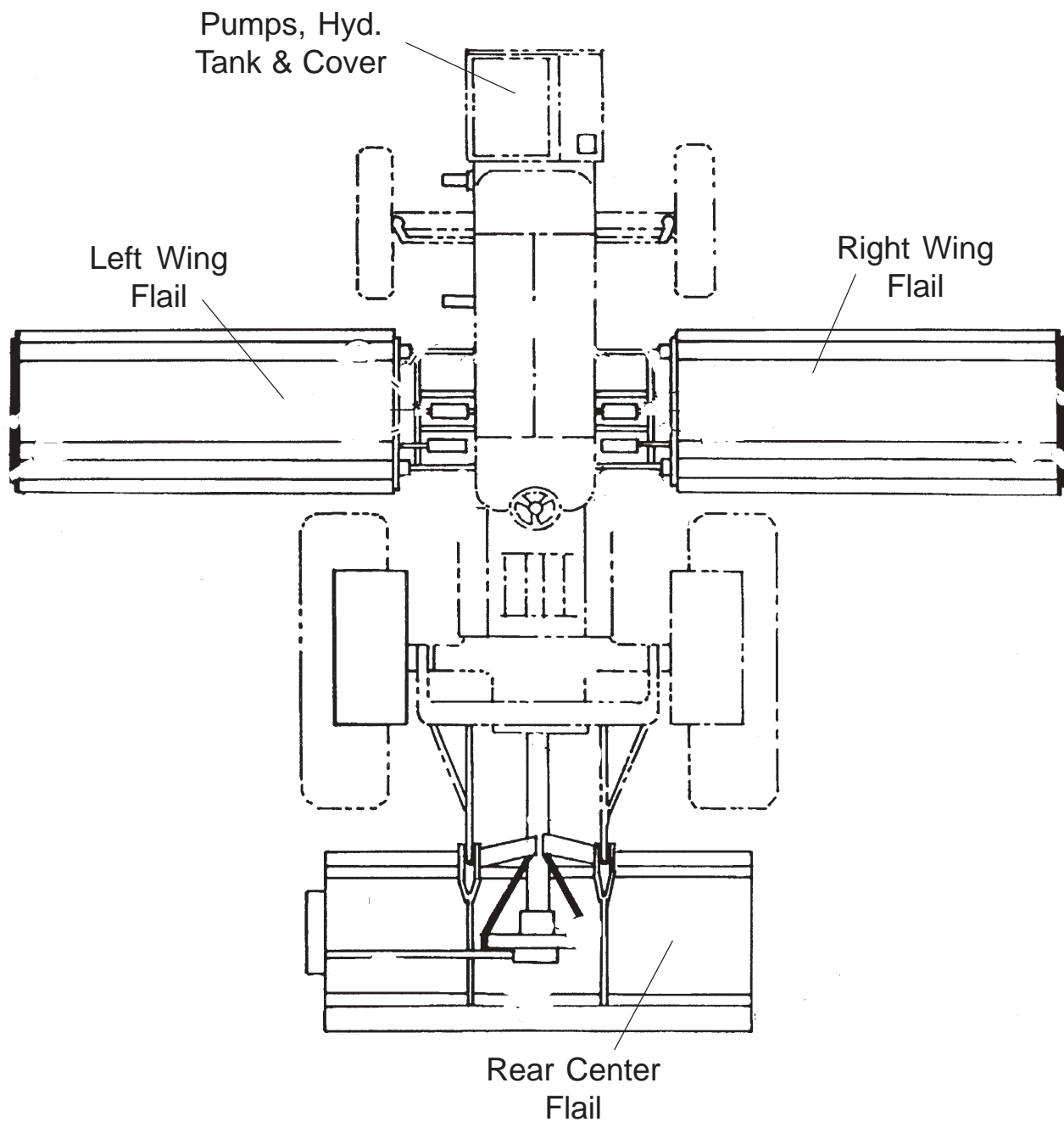

Section 2

INTERSTATER **New Holland** **TS100A, TS115A** **TS125A, TS135A** **Tractor** **Main Frame Asy.**

Main Frame Dual / Single Wing

Prepare Tractor:

Remove Components from Tractor. There are items that must be removed from tractor that will not be used before the mainframe can be mounted. On each side of the tractor there heavy mounting lugs that are bolted to the tractor frame. One on the left hand and one on the right hand side. The steps on the left and right side has to be removed. (See Figure 1) The Battery Relocation Kit will have to be installed, with this modification the battery will no longer swing completely out. To remove Battery after modification is done will best be done by two people as battery is heavy and will have to be lifted out. Before beginning any work on Tractor the Negative Ground Battery cable needs to be disconnected from the battery to protect the electrical system. Before reconnecting Battery cable check all connections that you have made and make certain all components of the tractor are in the OFF position.

Prepare Main Frame:

The Main frame (See Figure 2) will be bolted up under the tractor at the rear of the tractor and to the frame support rails at front. The Hydraulic Tube bracket & tube assembly needs to be bolted to the Main frame. Hydraulic Tube Assembly has a left and a right hand side, the LH and RH side has to be installed as shown (See Figure 2 & 3). If this is not bolted on correctly the hoses will not fit correctly later.

Mount Frame Rails To Tractor:

1. Install the Frame Mounts Rails. There is a LH and a RH Frame Mounting rail. These will bolt to the front of the tractor with three mounting bolts on each side. When Starting the three mounting bolts it will work best to install the RH Side (See Figure 2) and the LH Side (See Figure 3). Do not tighten the three mount bolts on each side, this will allow you to align mounting bolts easier. Move to the rear of the tractor under the rear axle, check the threaded bolt holes in the rear end housing. Remove any plugs or bolts that will be in the way. (See Figure 4 & 5)

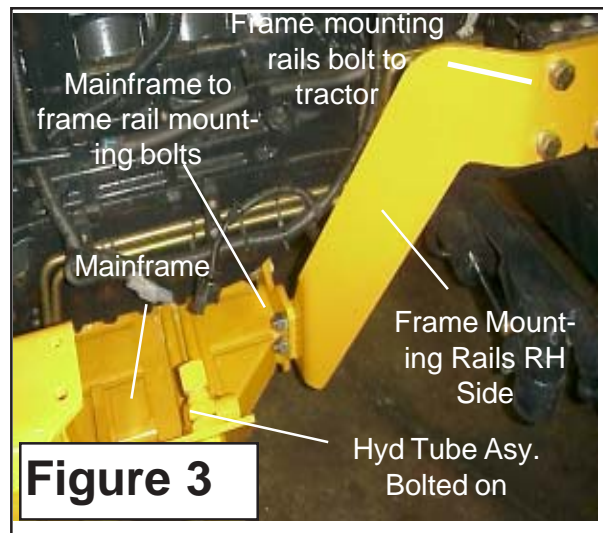
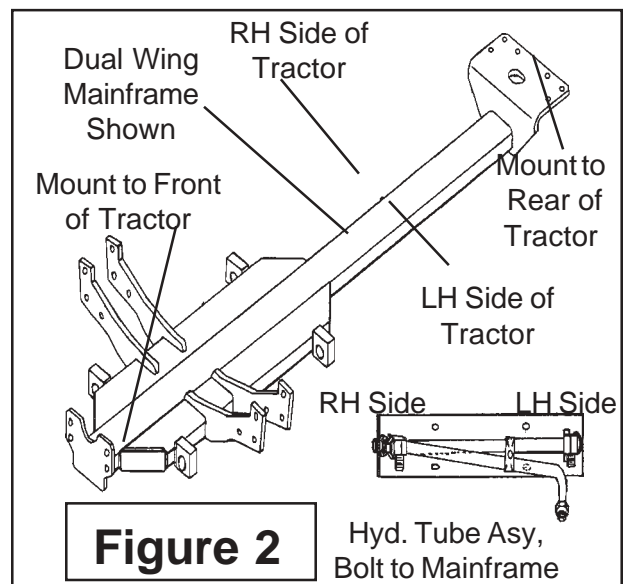

Main Frame Dual / Single Wing

Mount Frame Rails To Tractor:

2. Install the Main Frame. The Mainframe bolts up under the Tractor from the bottom. Bolt the Hyd Tube Assembly to the mainframe before sliding it up under the tractor (See Figure 2 & 3), make certain that the hyd tube assembly is bolted in the right direction as shown in Figure 2 as the tubes must be installed correctly for the hydraulic lines to be installed correctly later. Use floor jacks to support the mainframe under tractor (See Figure 6)

3. Tightening Mainframe Bolts. With all the bolts installed, the bolts at the front of the mainframe to the frame mounting rails, the bolts through the rear of the mainframe into the tractor. Tighten the bolts beginning with the bolts that mount the frame rail mount to the tractor in the front (See Figure 3 & 4). Second tighten the four bolts that mount the frame rail to the frame rail mounts (See Figure 3) . Next tighten the rear mainframe bolts that connects the rear of the mainframe to the tractor rear axle housing. Once all the bolts are tightened you can remove any floor jacks from under main frame.

4. Install RH Wing Lift frame. The wing lift frame pivots on two hinge pins. When installing these pins they must be aligned in a way that will allow the retaining bolt to be installed. The Right side and the Left side will install in the same way (See Figure 7 & 8)

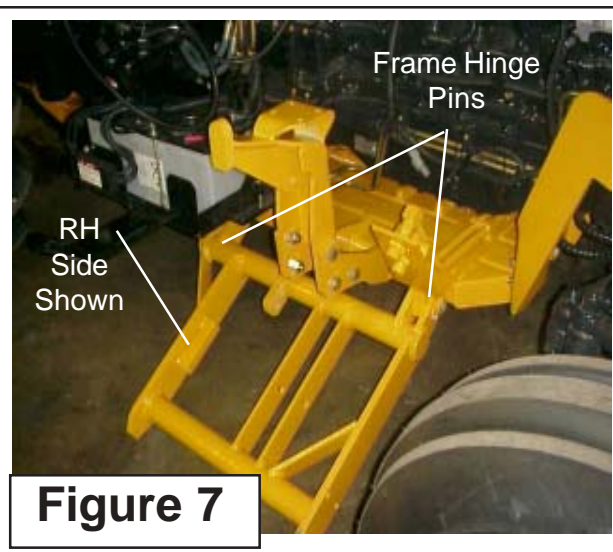
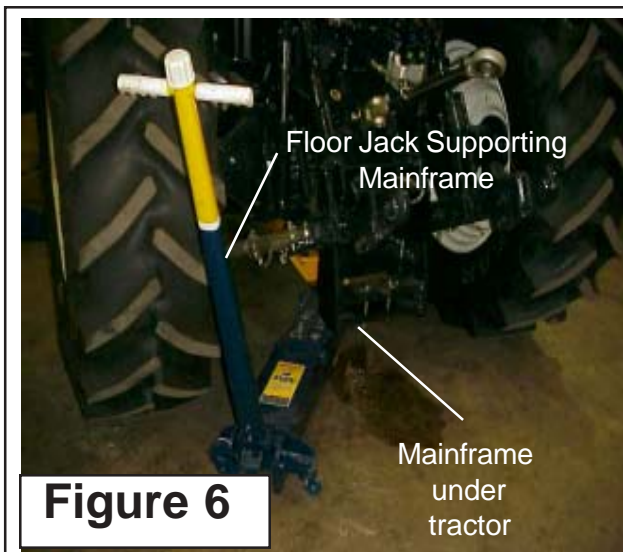
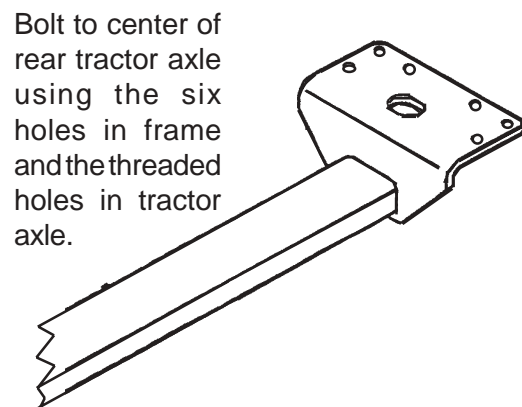
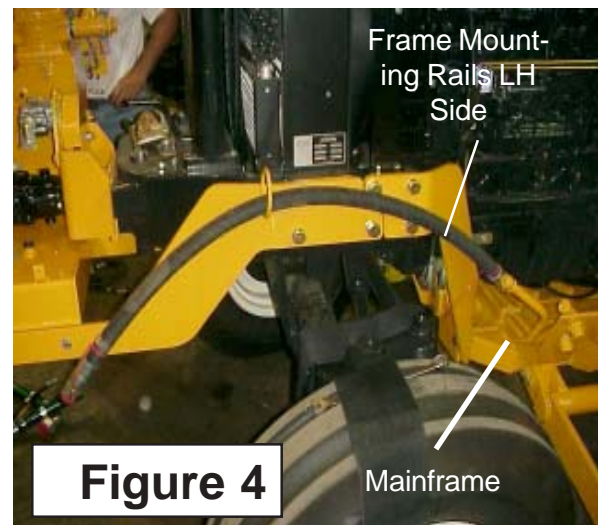

Main Frame Dual / Single Wing

Mount Frame Rails To Tractor:

5. Install LH Wing Lift frame. The wing lift frame pivots on two hinge pins. When installing these pins they must be aligned in a way that will allow the retaining bolt to be installed. The Right side and the Left side will install in the same way (See Figure 7 & 8)

6. Install Lift Cylinder Mount Weldment. The lift cylinder mount is a bolt on weldment that bolts to the main frame with four bolts. The Left Hand and the right hand are not the same. The right hand side will have a mount welded to it to mount the control valve to (See Figure 8), the left hand mount will not have this plate welded to it. The LH & RH will bolt on the same way. Tighten the mounting bolts. Note the bracket also have the transport lugs welded to them.

7. Install the Lift and Tilt Cylinders. Install the Lift cylinder and the Tilt Cylinder. When installing these they must be installed with the rod end clevis grease fitting facing up and out (See Figure 10 & 11). The Cylinder for the Left Wing will install the same as the RH side. **The Wing RH & LH Lift Cylinders MUST have lift control spacers installed to control wing lift height (See Figure 10 & 11).** Do not remove any shipping plugs from cylinders or hoses until you are ready to install the hoses, this will keep the system and components clean while unit is being assembled.

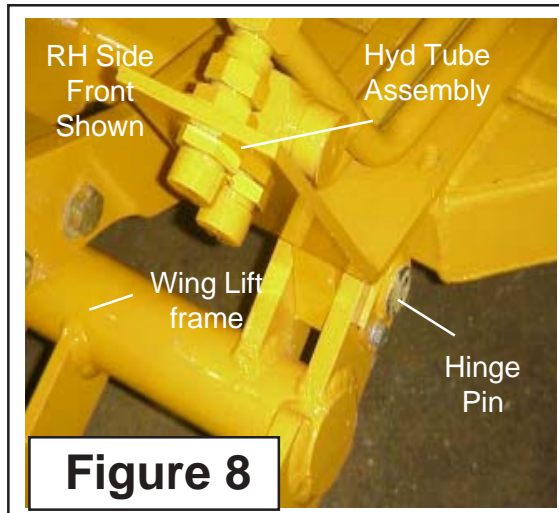

Figure 8

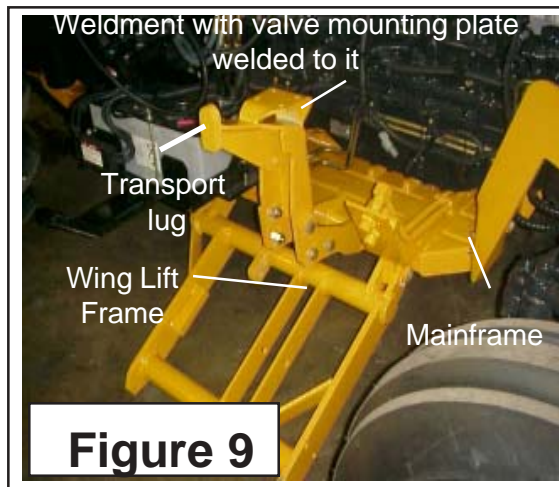

Figure 9

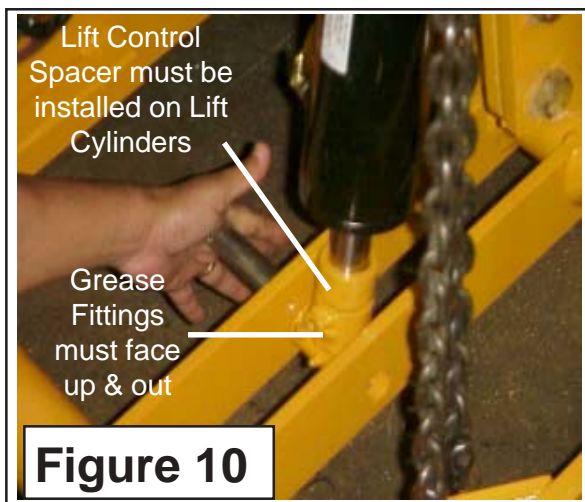

Figure 10

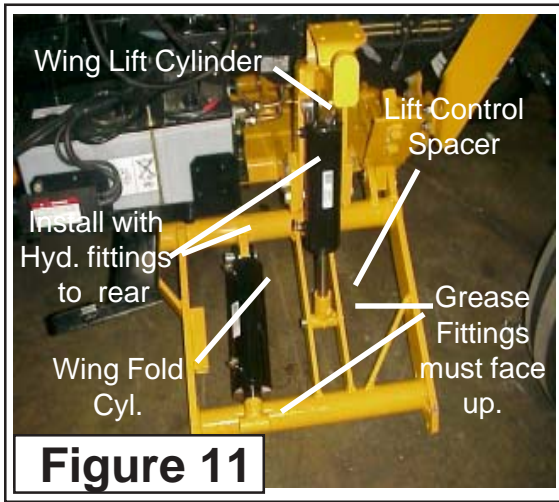

Figure 11

Main Frame Dual / Single Wing

Prepare 4 Spool Control Valve:

1. Remove standard control Handles. When using the remote control cables and handles the standard handles must be removed and discarded. This is done by removing the C-Clips and pins that hold the handles to the valve body and the C-clips and pins that hold handles to the spools. (See Figure 12)
2. Bolt Valve Mounting Bracket to Mainframe. The valve mounting bracket is bolted to the Right Hand side of the tractor. It is bolted to the mainframe. There are two different sets of hole in valve mounting bracket, this allows the location of the valve to be varied.
3. Install The Cylinder Control Valve to Valve Bracket. The control valve is mount to the valve bracket using two bolts. These two bolts is all that will be needed to mount valve to valve bracket. (See Figure 14).



Figure 12



Figure 13

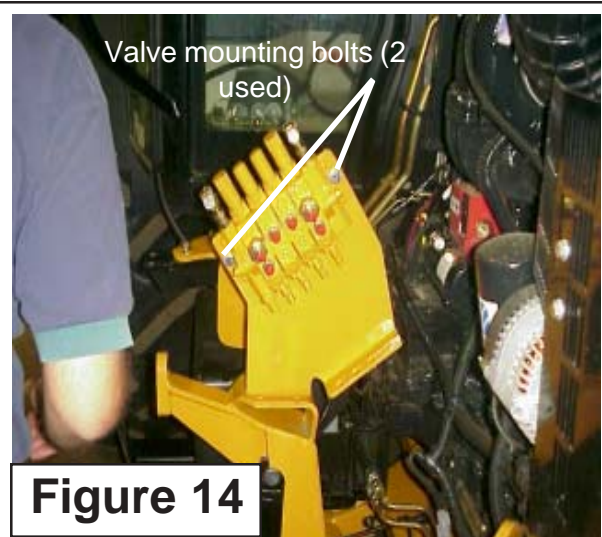

Figure 14

NOTES

Section 3

INTERSTATER

New Holland

TS100A, TS115A

TS125A, TS135A

Tractor

Pump, Driveshaft & Hyd. Tank

Pump & Driveshaft Schematic

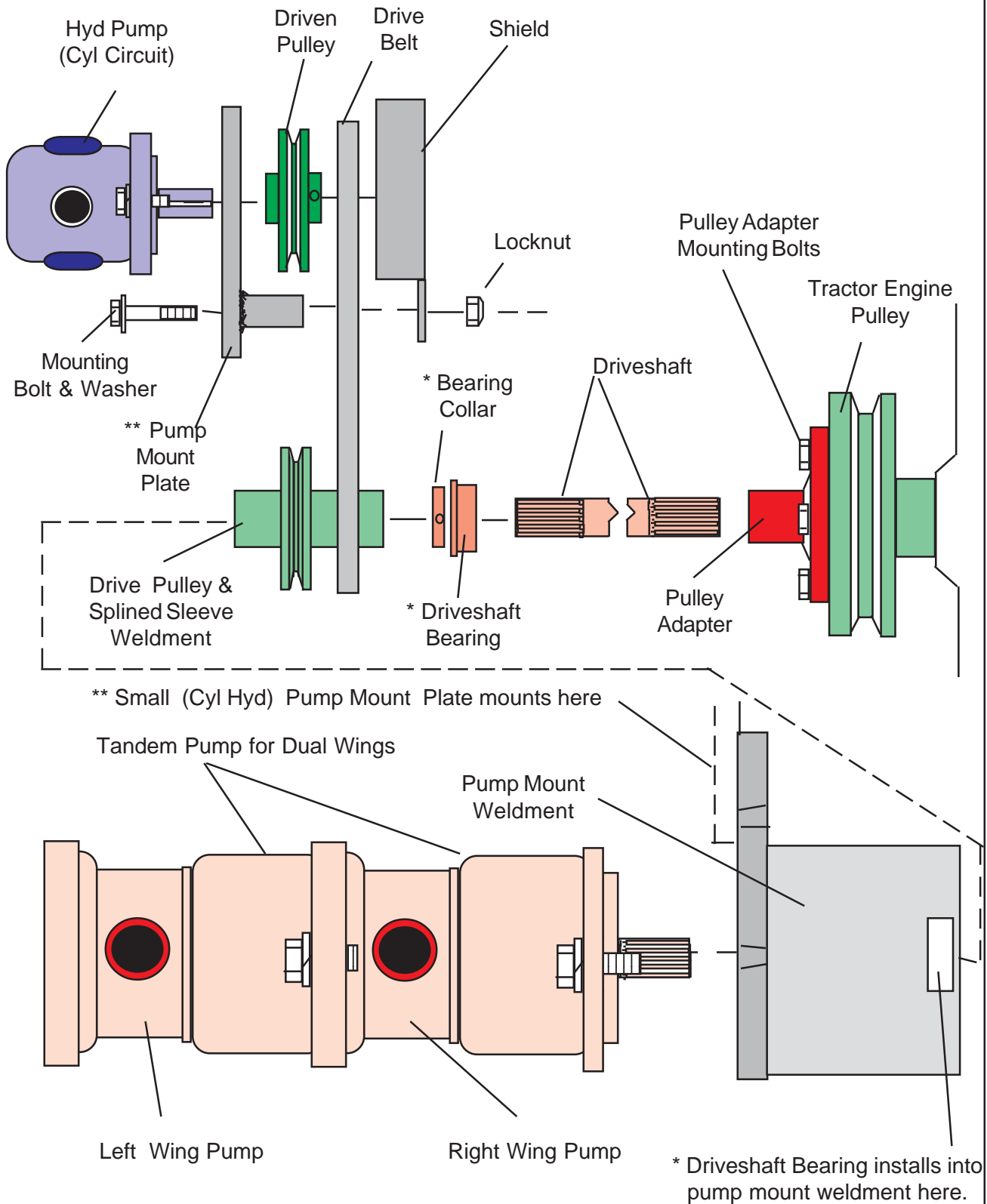

Figure 1

Pump - Driveshaft - Hyd tank

Install Driveshaft, Pump & Tank:

1. Gain Access to Tractor Engine. Raise the hood of the tractor to reveal the tractor engine (See Figure 2). Remove the engine guards on the left hand side of tractor (See Figure 3). This will allow you access to the Tractor Crankshaft Pulley. (See Figure 1). Remove the plate under After cooler which will make installing driveshaft easier.

2. Bolt Pulley Adapter to Engine Crankshaft Pulley. Bolt the pulley adapter to the to the crankshaft pulley with the supplied bolts. Make certain the bolts used are not to long or to short (See Figure 1).

3. Install Driveshaft. Insert driveshaft into crankshaft pulley, both splined ends are the same so it will not matter which end is inserted.

4. Install pump Mount Weldment. Bolt the pump mount weldment to the front bolster of the tractor. The driveshaft will be sicking through the hole in the pump mount weldment. (See Figure 1)

5. Install Driveshaft Bearing & Bearing Collar. Slide the bearing onto the driveshaft until the bearing is seated into the inner hole of the pump mount weldment where the driveshaft comes through. Slide the bearing collar onto driveshaft until seated against bearing. Making certain that driveshaft is seated into crankshaft pulley adapter tighten setscrew for bearing collar. (See Figure 1)

6. Install Drive pulley & Splined sleeve weldment. The drive pulley weldment and drive belt will have to be installed at the same time. If the drive belt is not installed now you will not be able to later.

7. Install Hydraulic Pump (Pumps to operate Wing Motors). Install the Tandem Pump (single pump if only one wing.) By aligning the splines of the pump shaft with the splines of the drive pulley & splined sleeve weldment. Push the pump on till the pump is seated into the pump mount weldment.

8. Install Pump Retaining Bolts. Install the two bolts that retain the Left & Right wing pump(s) to the pump mount weldment and tighten them. (See Figure 1)

9. Install Small Pump (Hyd Cyl System). The Hyd Cyl operate from a small pump bolted above the tandem pump. (See Figure 1) Bolt the Pump onto the Small Pump Mount plate with the two mounting bolts. Install the driven pulley onto the pump, make certain to install the key in pump shaft. DO NOT tighten the setscrews in pulley until later. Slide the Drive Belt onto driven pulley and align the pump mount plate with the holes in the pump mount weldment, use Flat washers on bolts to mount to pump mount weldment (See Figure 4). DO NOT Tighten these bolts yet.

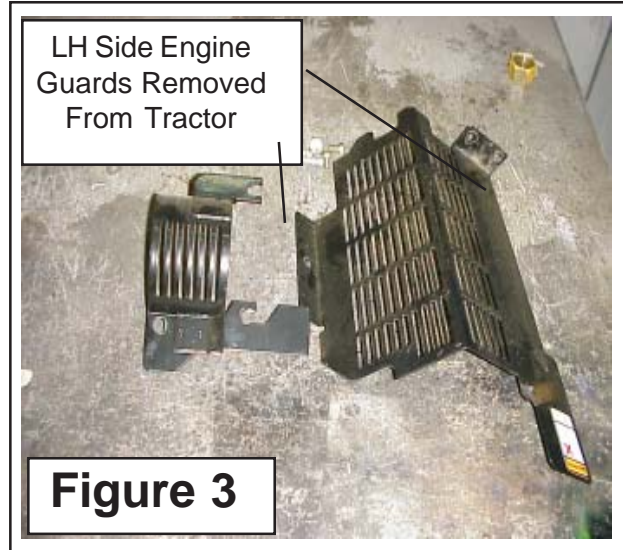
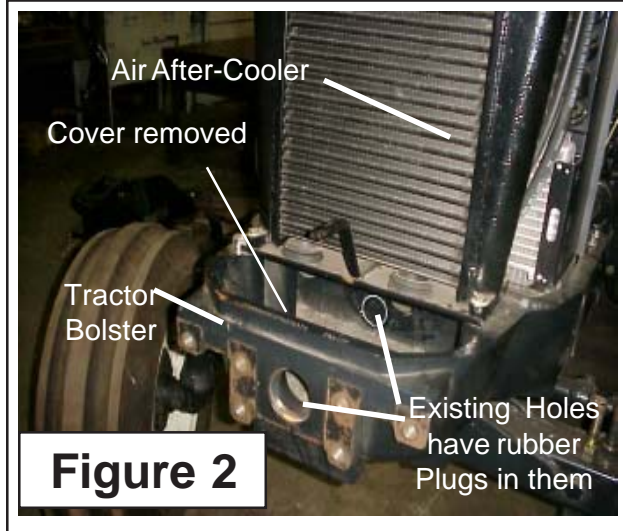

Pump - Driveshaft - Hyd tank

Install Driveshaft, Pump & Tank: (continued)

10. Small Pump Belt Adjustment. The belt Guard is retained with the same bolts that mount the pump plate and the same bolts that are used to adjust the drive belt. For now do not install the belt guard. Snug these bolts for now but do not tighten them

11. Align driven pulley. The driven pulley on the small pump will need to be aligned with the drive pulley below it. Slide the pulley on the pump shaft on or off to align with the drive pulley on the main driveshaft. Tighten setscrews in Driven pulley when aligned.

12. Install Belt Guard on Small Pump. With the driven pulley aligned install the belt guard and reinstall the retaining nuts.

13. Adjust the Belt Tension. Look on the mount plate you will see a 3/8" square hole above the slotted hole (See Figure 5). Using a 3/8" drive ratchet in the 3/8" hole pull up on the ratchet until the belt is adjusted. Do not over tighten the belt, it should be tightened to firm. Holding the tension on the belt tighten the mounting bolts. You may need to get someone to help you with this. DO NOT over tighten the Drive Belt as it could damage the pump. (See Figure 6)

14. Prepare Tandem Pump Fittings DO NOT remove any caps or plugs on hydraulic hoses or connections until you are connecting them, this will keep dirt out. The Tandem Pump will need to be prepared for connecting the hoses. There are fittings that must be changed. The Fittings in the tandem pump should already be installed when you receive it from the factory (See Figure 7). The Pressure Out Port to LH Wing from outer Tandem half of pump straight out fitting will need to be change to a 90 degree elbow fitting (See Figure 7). The Two large caps on the tank suction ports will need to be replaced with two elbow fittings and hose barbs (See Figure 7, 8 & 9). Coat the fittings that screw into pumps and tank with a pipe sealer (NOT Teflon Tape), do not put excess sealer on OD of fittings and none on ID of fittings (See Figure 7). Install the elbow fitting into the pressure port of the LH Motor Pump (outer pump on tandem pump) with the supplied elbow (See Figure 9)

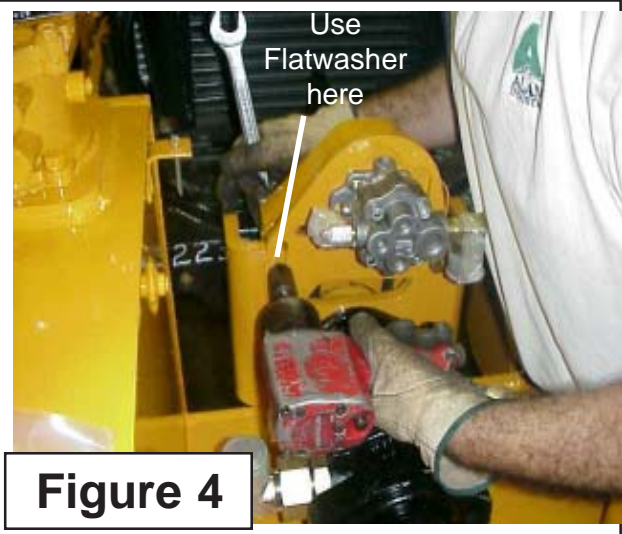

Figure 4

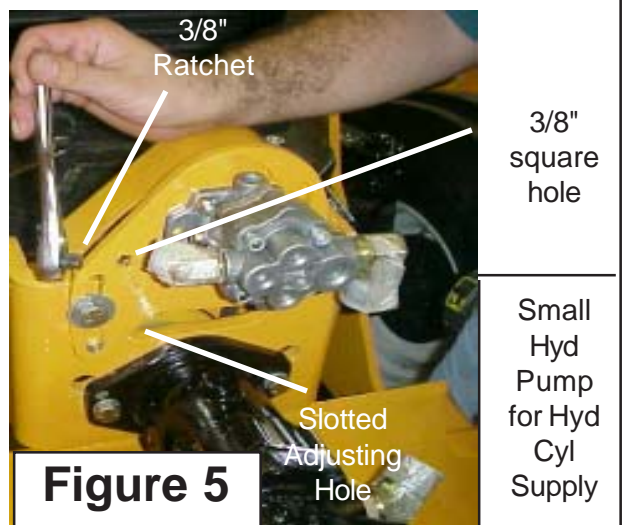

Figure 5

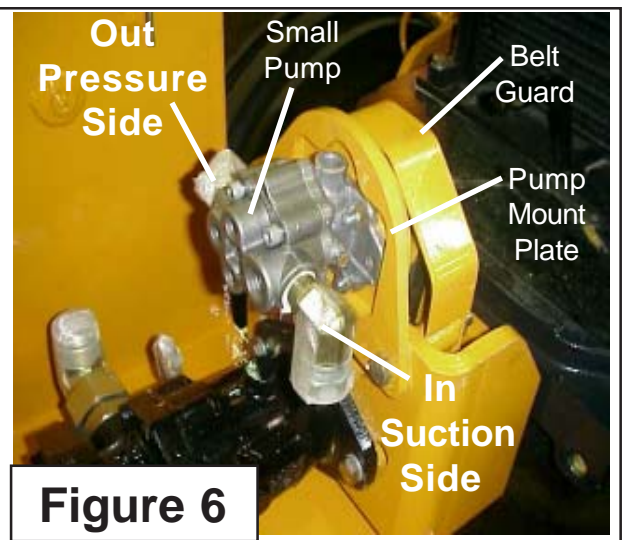

Figure 6

Pump - Driveshaft - Hyd tank

Install Driveshaft, Pump & Tank: (continued)

15. Connect Pump Case Drain To Tank. On the Right Hand side of the tandem pump there will be two small elbows, these are the case drains for the pumps. On the side of the tank and above these elbows there will be two small plugs screwed into tank. Remove these plugs and install the pipe thread end of the two small hose after coating the threads with pipe sealer. Connect the other end of the hose to the elbows on the side of the pumps. NOTE: Only the Tandem pump will have case drains, the smaller pump used to power the hydraulic cylinder system will not use a case drain. (See Figure 9 & 11)

16. The small pump used to supply the cylinder hydraulic system will have a short hose that connects to the small pump and to the tank suction port that is in the tank exclusively for the small pump. This hose needs to be cut to fit, do not install with any kinks in hose. (See Figure 6 & 7) which shows these ports. Make certain the Elbow (pressure port of outer tandem pump (See Figure 9) is installed and tightened pointing to the rear of the pump.

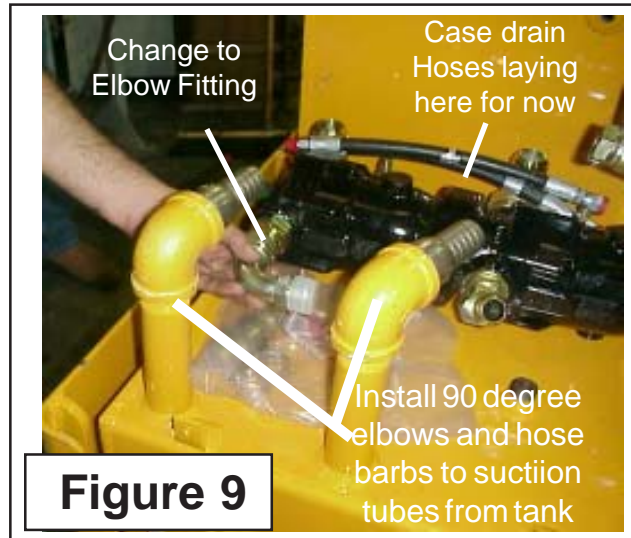
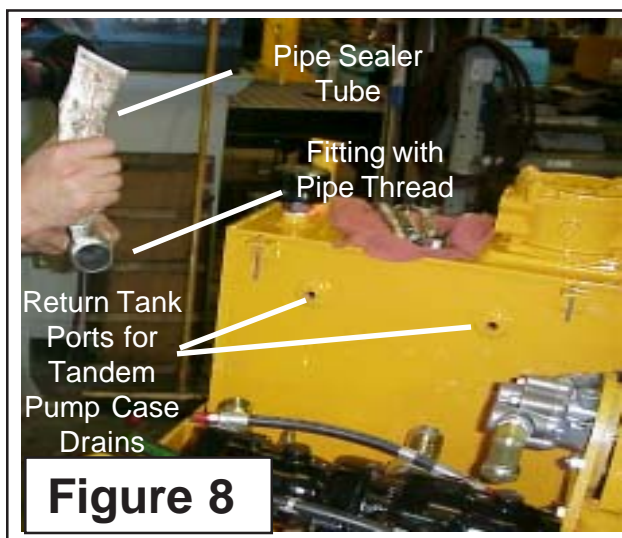
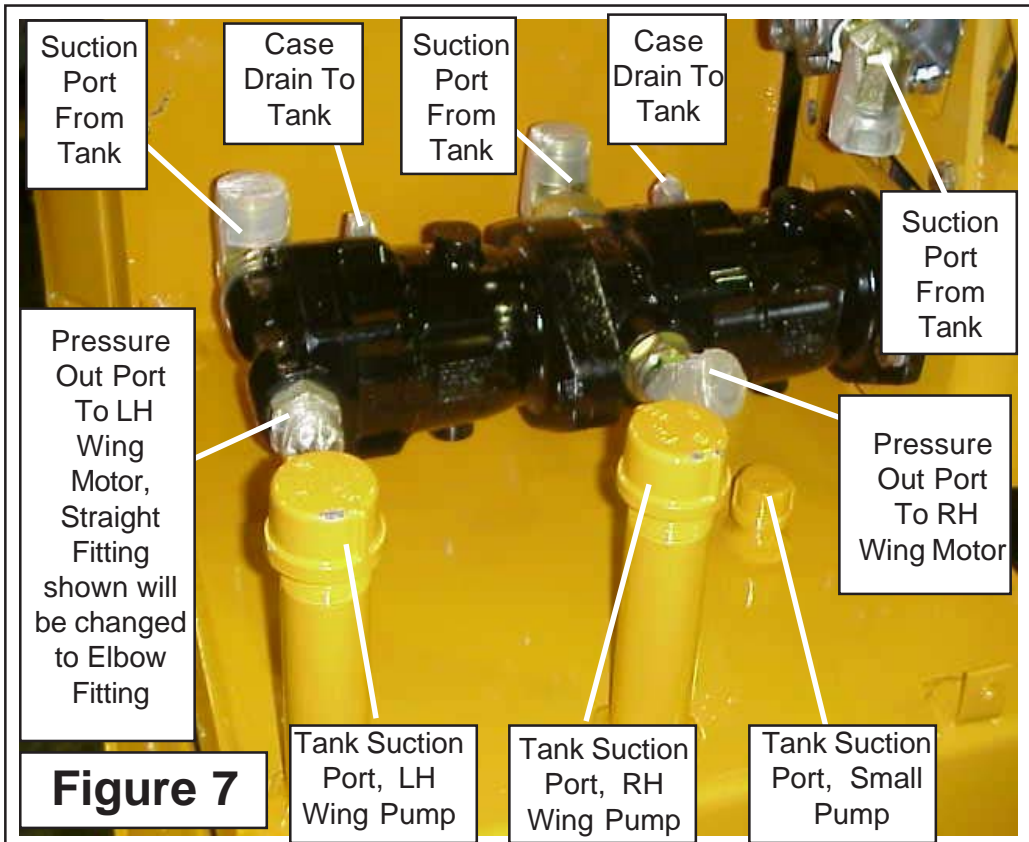

Pump - Driveshaft - Hyd tank

Install Driveshaft, Pump & Tank: (continued)

17. Connect Motor Pressure Supply Hoses to Pump. The Tandem Pump has two pressure hoses. The Rear (closest to Tractor Engine) is the supply for the RH Wing Motor. The Outer Pump is the LH Wing Motor Pressure Supply. The hose for the RH Wing should be marked with a red plastic tie on it, the other hose is not Identified. Connect these two hoses at the pump now.

18. Connect Pump Suction Hoses. The Case drain hoses should already be connected, if not connect them now. Hoses & Fittings with Pipe thread will need a thread sealer used (do not use excess sealer and no sealer on ID of fittings). The Tandem Pump Suction hoses will be sent longer than needed and will need to be cut to fit. (See Figure 11). The Aux. Pump Suction hose will need to be cut to fit and connected now (See Figure 11). **DO NOT** have any kinks in the suction hose, it will starve the pump of oil causing damage to system.

19. Cover Pressure Hoses with Sleevings. With the two pressure hoses run the hose retaining ring (See Figure 12) bolted to the side of tank rails slide the hose sleevings up over the pressure hoses (See Figure 13). Slide the sleevings over hoses and through the hose retaining ring. Slide sleevings up until it is about 2 inches past the edge of the hydraulic tank.

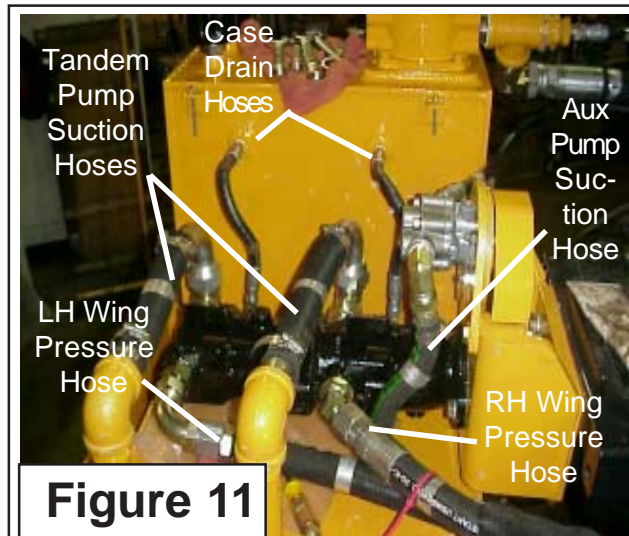
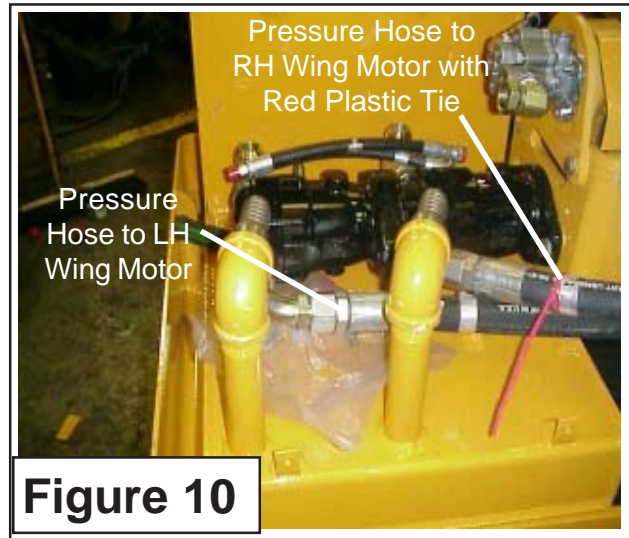

Pump - Driveshaft - Hyd tank

Install Driveshaft, Pump & Tank: (continued)

20. Change Straight Bulkhead fitting to an Elbow Fitting. There is a straight bulkhead fitting installed into main frame crossmember that should be changed to a 90 " elbow (See Figure 14,15,16 & 17).

21. Connect Motor Pressure Supply Hoses to Main Frame Cross Member. The Tandem Pump has two pressure hoses. The Rear (closest to Tractor Engine) is the supply for the RH Wing Motor. The Outer Pump is the LH Wing Motor Pressure Supply. The hose for the RH Wing should be marked with a red plastic tie on it, the other hose is not identified. Connect these two hoses at the Main frame crossmember now (See Figure 16 & 17)

22. Connect Hoses to correct Bulkhead fittings is important here. The Pressure hoses MUST be connected correctly to the correct bulkhead fitting. If they are not they will damage the head cooling tubes and/or other components. DO NOT connect any hoses until instructed to do so. Always double check the hose routing to make sure they are correct.

Remove this
Straight Bulk
Head Fitting &
Replace it with
an Elbow



Figure 14

LH Wing Side Of
Tractor

Install this Elbow
Bulk Head Fitting in
place of straight one.



Figure 15

LH Wing Side Of
Tractor

Install Pressure Hose from Tandem Pump
to Bulk head fitting here for LH Wing
Motor

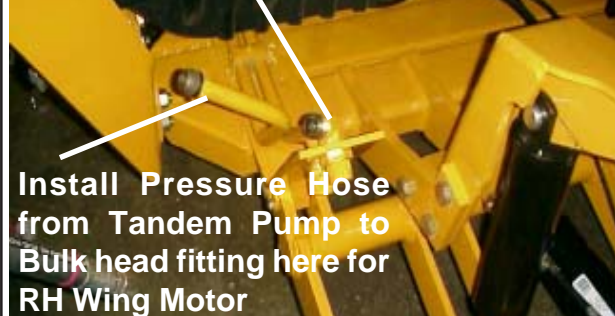

Figure 16

LH Wing Side Of
Tractor

Install Pressure Hose
from Tandem Pump to
Bulk head fitting here for
RH Wing Motor

Pressure Hose f/ Tandem
Pump to Bulk head fitting here
, LH Wing Motor



Figure 17

Pressure Hose f/ Tan-
dem Pump to Bulk
head fitting here , RH
Wing Motor

Pump - Driveshaft - Hyd tank

Install Driveshaft, Pump & Tank: (continued)

23. Install Hose Fittings into Return Filter in Tank. There is a return filter in the top of the RH side of tank. In the end of the filter housing install a Tee Fitting with an Elbow in it, the tee fitting should point outward as seen in figure 19. In the end of the Tee there will be reducer to allow the installing of a smaller hose. This reducer is where the return hose from the control valve will connect (See Figure 18, 19 & 25). The elbow fitting in the tee should be turned downward at approx a 45 degree angle (see Figure 19 & 25) . Installing these fittings in this way will allow the oil cooler to be slid out for maintenance without hydraulic hoses interfering with cooler.

24. Install Return Filter Pressure Gauge. The return filter pressure gauge screws into the side of the return filter housing. This gauge is a low pressure gauge that is marked in green and red areas. (See Figure 19). The Oil Pressure return gauge has a rubbery tip on top of it, the tip till have to have the tip of it cutoff. Using a utility knife (or suitable knife) cut the tip off now (See Figure 20). This will need to be done before unit is run.

25. Install the Oil Level Sight Glass. The Oil Level sight Glass screws into the Hydraulic tank. This is to be covered with oil when tank is at operating level. (See Figure 18 & 19)

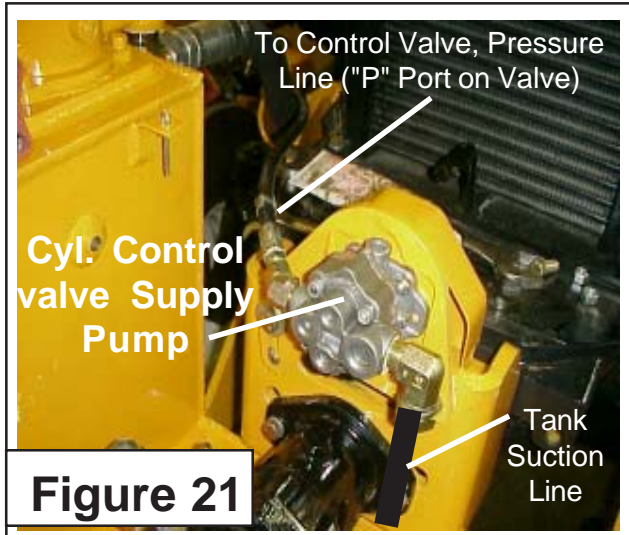
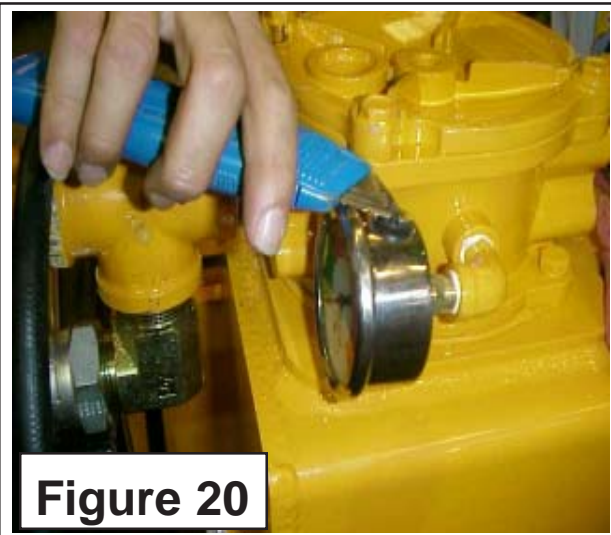
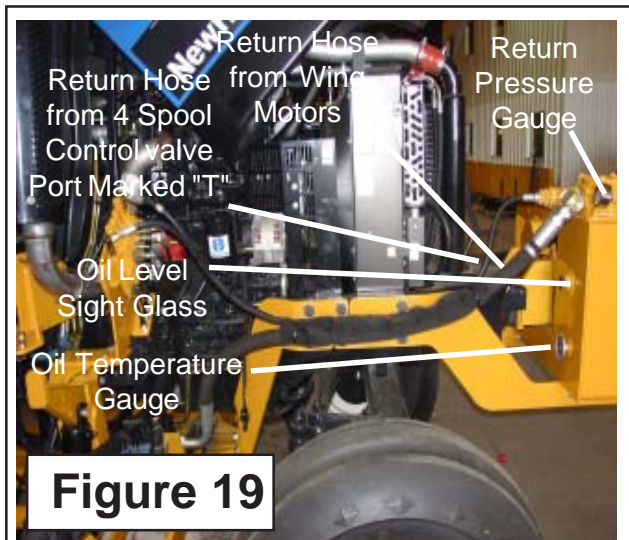
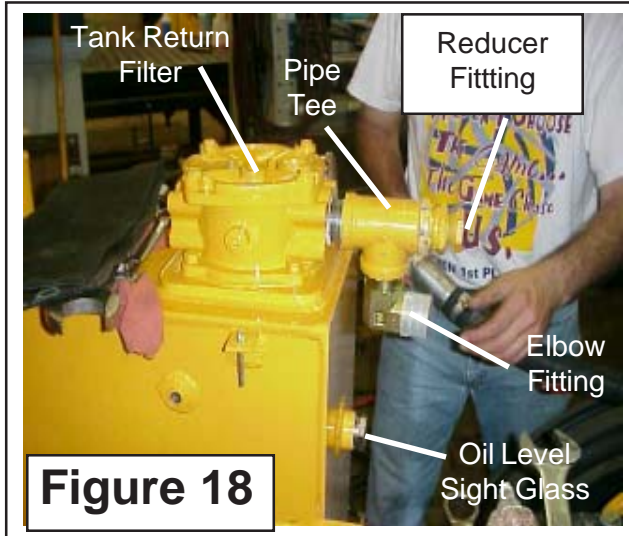

Pump - Driveshaft - Hyd tank

Install Driveshaft, Pump & Tank: (continued)

26. Install the small pump pressure hose to pump. The pressure hose connects to the RH side of the small pump and is run down the RH side of the frame with the return hoses (See Figure 21)

27. Install sleeving over the return hoses from heads and control valve and Control valve Pressure Hose. Slide the three hoses through the sleeving. Slide the hoses with the sleeving through the hose support ring bolted to the side of the tractor. Tie the sleeving using plastic ties around the hoses to keep it from moving (See Figure 22). Tie the sleeving with plastic ties around the pressure hose on the LH side of tractor (See Figure 13)

28. Install return hose to cross member and Hoses to Control Valve. Connect the return hose to the cross member on right hand side of main frame crossmember (See Figure 23). The other end will connect to the return filter Tee fitting (See Figure 24)

29. Connect Pressure & Return Hose to Cylinder Control valve. Connect the pressure hose running from the RH side of small pump to RH Top side of control valve, The port will be marked with a "P" cast into it, the other end is connected to the small supply pump (See Figure 21). Connect the return hose that is connected to the Tee Fitting of the return filter to the Return side of the control valve with a "T" cast into it (See Figure 24 & 25)

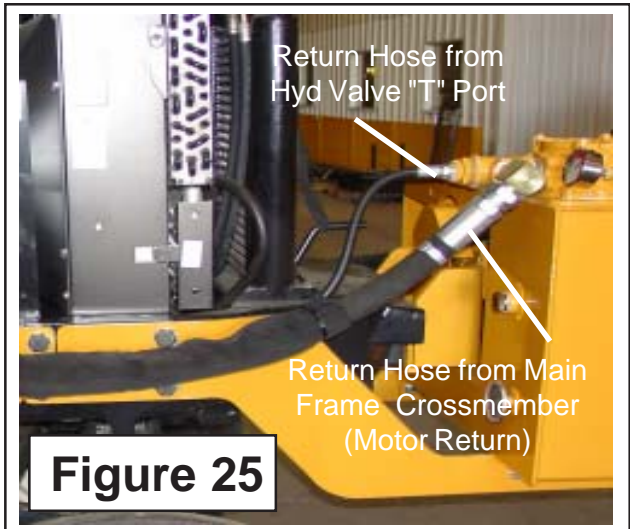
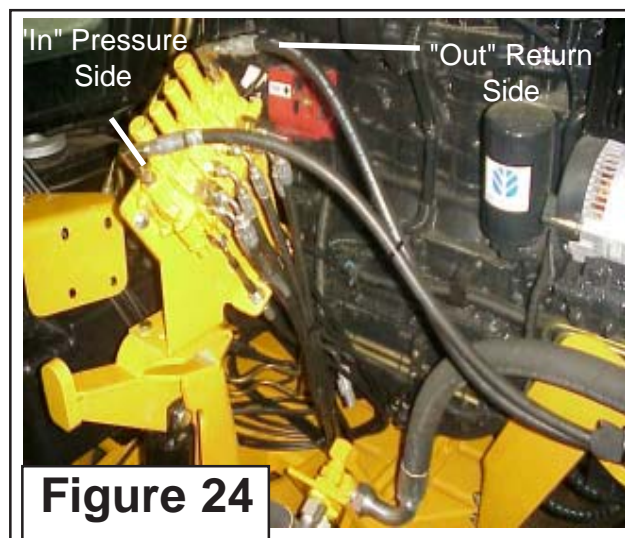
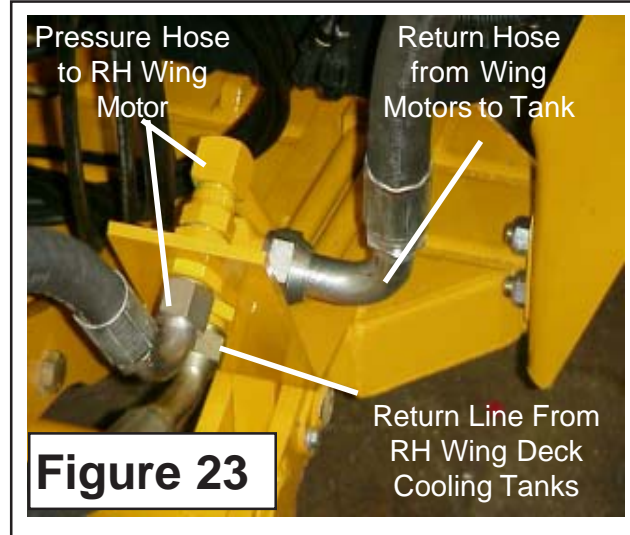
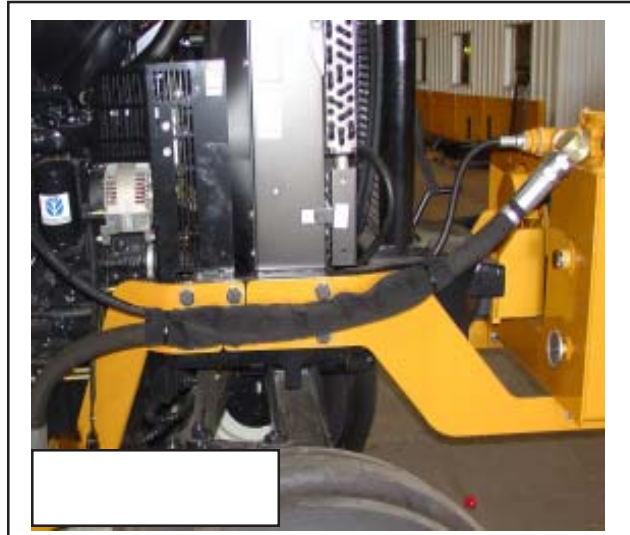

NOTES

Section 4

INTERSTATER

New Holland

TS100A, TS115A

TS125A, TS135A

Tractor

Remote Control Cable

Connections

Remote Control Cable Connections

Remote Control Cable Connections Cab Tractor:

1. Control Valve Cable Clips. Locate the four cable mounting clips and four roll pins (shown laying on muffler bracket for illustration only in Figure 1). Start the roll pins into the clips as shown through one side only (See Figure 1). Insert the Remote Cable through the Control Valve Mount Bracket (See Figure 2). Install the large cable retaining / Adjusting nut onto threaded portion of cable housing (See Figure 2). DO NOT tighten this large nut until later. On the tip of the threaded end of the cable there is a 1/4" nut. Screw this nut down onto cable. Insert the cable clip down over threaded cable end (See Figure 3). Find the four 1/4" nut supplied, install one onto end of cable down into clip. This nut should be screwed onto cable at least the thickness of the nut, do not screw it on so far that it will interfere with the operation of the cable. Using the nut that was already on the cable screw the nut out until it is against the clip from the bottom side, tightening this nut against clip will lock the other nut inside of clip. (See Figure 3).

2. Connect Clip to Valve Spool. Turn the clip and the valve spool to where the hole in the clip and the hole in the spool are aligned. Using a hammer drive the roll pin through the hole in the spool and through the other side of clip (See Figure 4) . Make certain to keep the clip aligned when driving pin in. Turn the clip and spool as shown (See Figure 5), Continue this with the other 4 cables and clips (See Figure 6).

3. Connect Cylinder Hoses to Valve. There are six cylinder hoses that connect to Control Valve. One Pressure "P" hose and one Tank "T" hose. These hoses are connected as follows (See Figure 7 , 9 & 23)

1. Tilt Cyl. Rod End RH Wing.
2. Tilt Cyl, Butt End RH Wing.
3. Lift Cyl. Rod End, RH Wing.
4. Tilt Cyl. Rod End LH Wing.
5. Tilt Cyl. Butt End LH Wing.
6. Lift Cyl. Rod End LH Wing.
7. "P" Pressure Hose from Pump
8. "T" Return Hose To Tank

Connect hoses with elbow pointing down (See Figure 8)

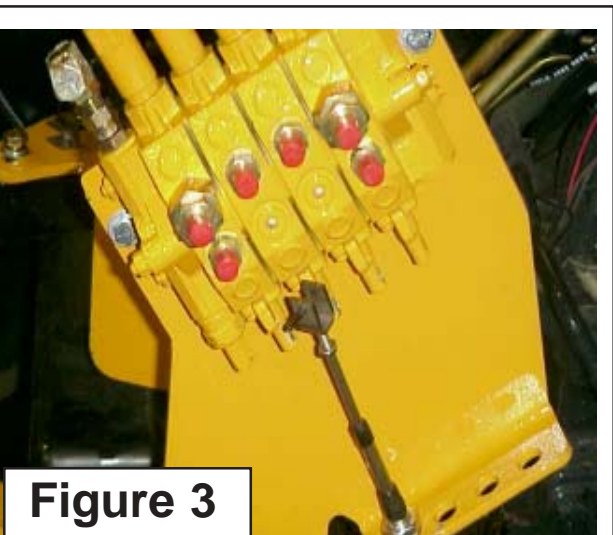
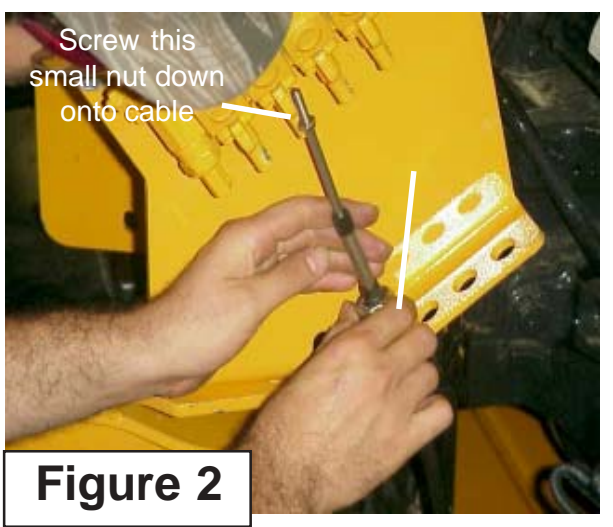
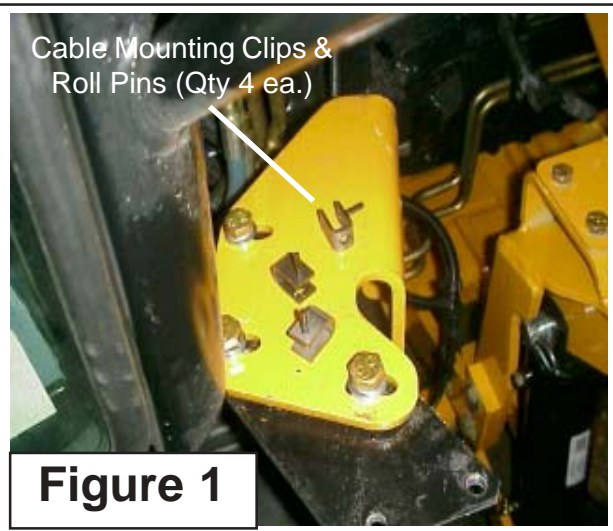

Remote Control Cable Connections

Remote Control Cable Connections: (continued)

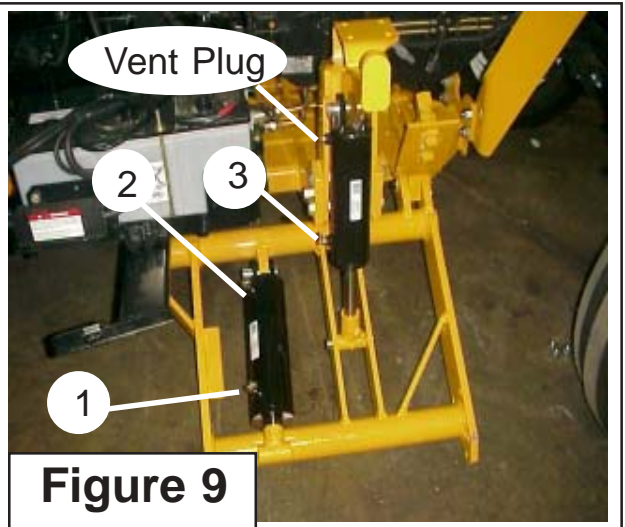
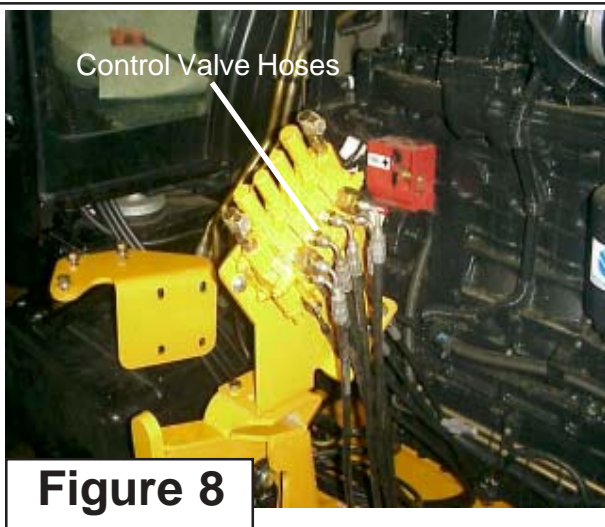
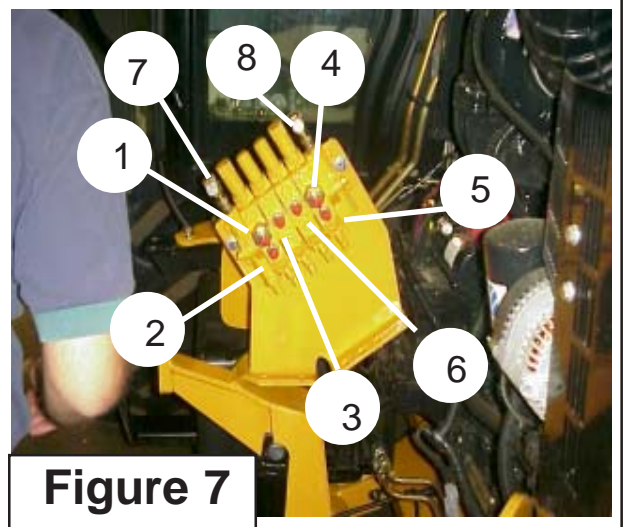
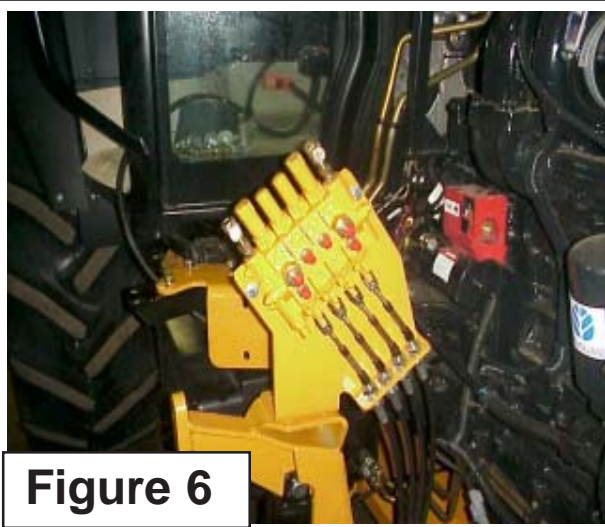
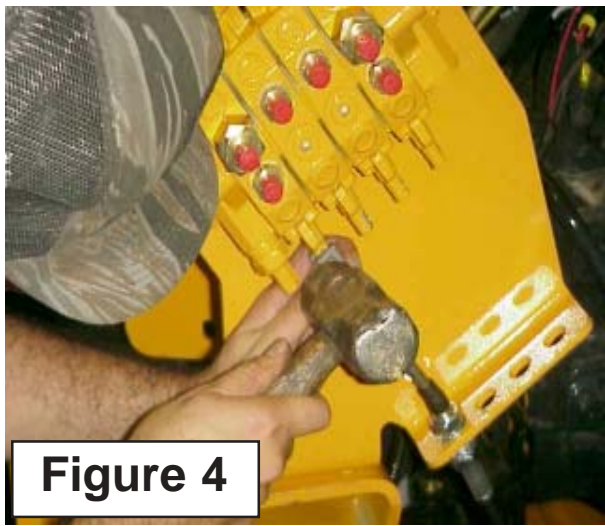

Remote Control Cable Connections (Cab Tractor)

Remote Control Cable Connections Cab Tractor:

1. Install Remote Cable Control Lever Mounting Bracket In Cab Tractor. Locate the four existing threaded holes that are in the RH side on the cab door post (See Figure 10). The Control Lever Mounting bracket will bolt to two of these holes. Align the matching holes of the mounting bracket with two of the threaded door post holes. Install the two mounting bolts through bracket and into door post (See Figure 11)

2. Cut Hole Through Rubber Floor Mat and Cab Floor. Some Cabs may already have a hole through floor, pull up rubber mat and check before cutting hole. It is recommended that a 2" round hole be cut to keep all the cables and wire harness together and smoothly coming up through floor. Before a hole is cut in floor check the under side to make certain that the hole saw is not going to damage any of the components under the floor. Make certain that the hole cut is far enough over that it will not interfere with operators foot room. Cut hole through floor mat and floor using a round 2" hole saw (See Figure 12). After you cut the rubber mat with the hole saw pull the piece of rubber out of saw, this will make it easier to cut through the floor. (See Figure 12)

3. Install Cable/Wire Harness Boot Cover. The Boot cover will be modified, using a knife cut an "X" shaped cut across the small hole at the top. This cut will be cut back approx 1/2" from original hole. Using the 4 screws screw the cover to the rubber mat. (See Figure 13 & 14)

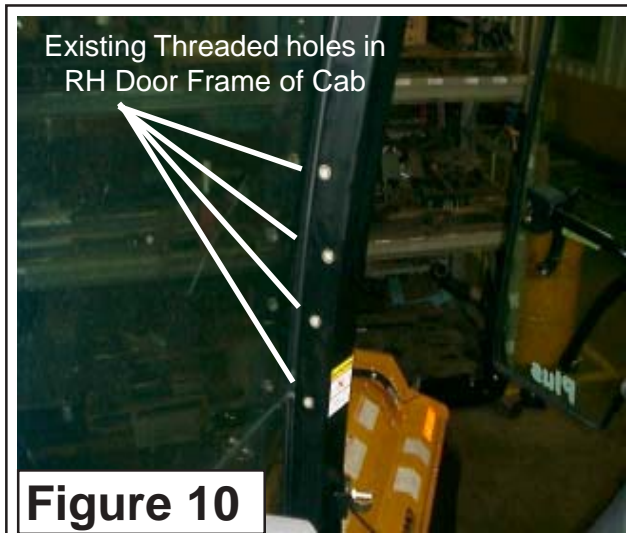

Figure 10



Figure 11



Figure 12



Figure 13

Remote Control Cable Connections (Cab Tractor)

Remote Control Cable Connections Cab Tractor: (continued)

4. Install Wire Harness through floor and boot. The Wire harness will come to you with the on / off switches attached, these switches will need to be removed to Push the Wire Harness up through the floor and boot cover (See Figure 15 & 18).

5. Insert Cables up through Boot Cover. Mark the cables as to which is which on the control valve as they need to be connected in the same order on the inside of the cab as they are connected to the control valve (See Figure 17)

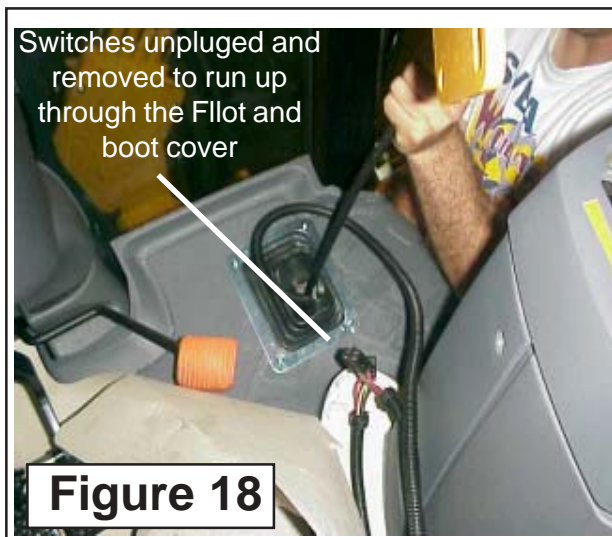
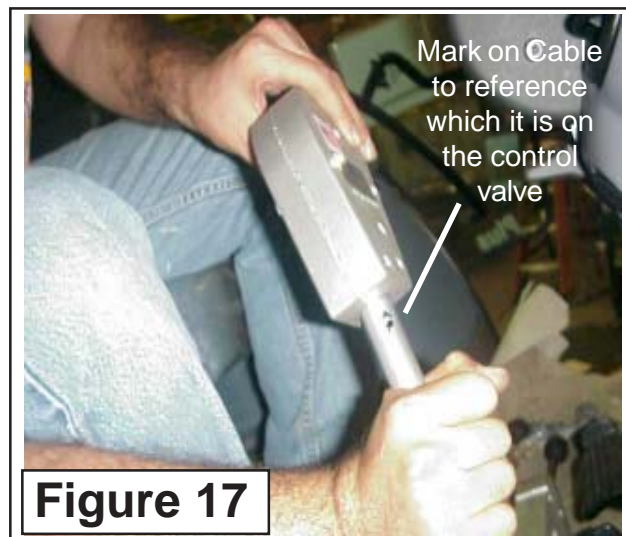
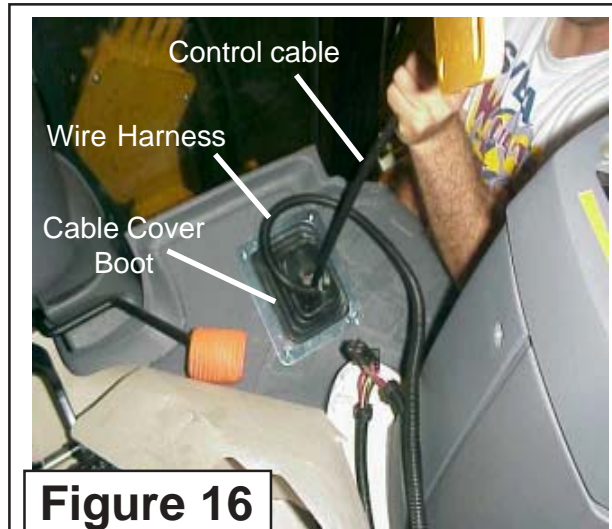
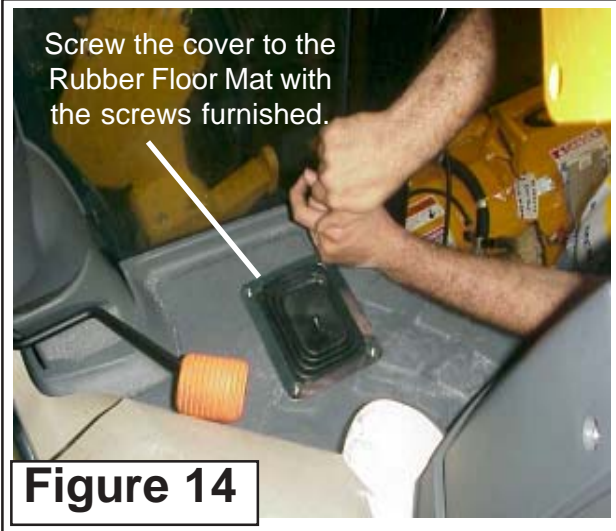

Remote Control Cable Connections (ROPS Tractor)

Remote Control Cable Connections ROPS Tractor:

1. Install Valve Stand to Tractor on ROPS Tractor only. Attach Valve Stand to the top of the Right Lift Cylinder Support with (3) 1/2" x 1-1/2" bolts, and (3) 1/2" locknuts (See Figure 19).
2. Attach Valve Stand to Valve Mount Bracket. Attach Valve Stand to the Valve Mount Bracket with (2) 3/8" x 1-1/4" bolts and (2) 3/8" locknuts (See Figure 20).
3. Attach Control Valve to the Valve Stand. Attach Control Valve to the Valve Stand with (2) 3/8" x 1" bolts, (2) 3/8" locknuts. Attach the Top Cover and the Bottom Cover to the Valve Mount Bracket with (8) 3/8" x 1" bolts, (8) 3/8 washers and (8) 3/8" locknuts (See Figure 21).
4. Install Mower Wing ON / Off Switches. Make certain to install connector so that larger brown wires are located on bottom poles of switch. This applies to Dual Wing and Single Wing applications

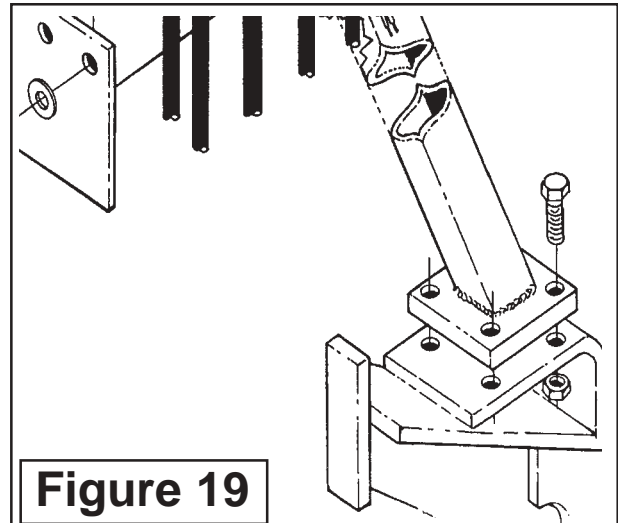

Figure 19

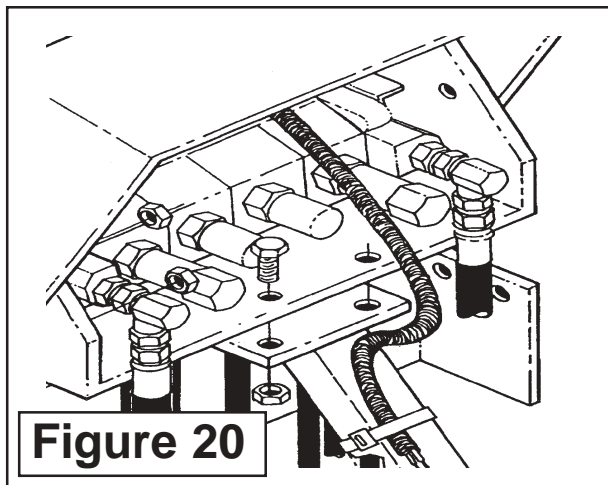

Figure 20

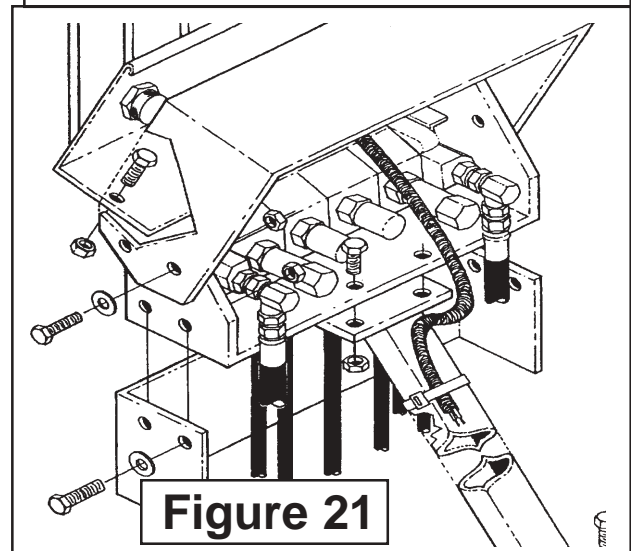

Figure 21

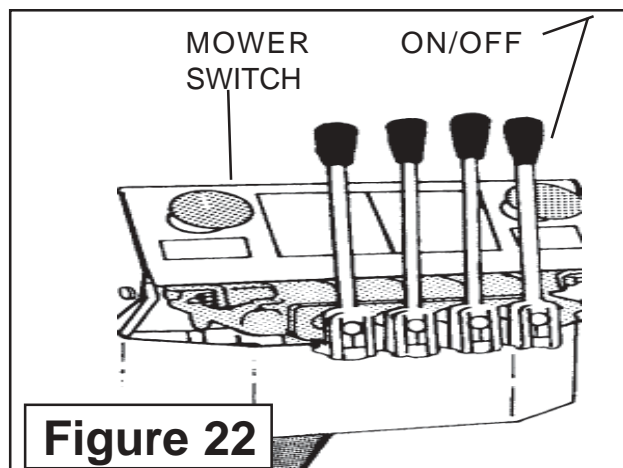

Figure 22

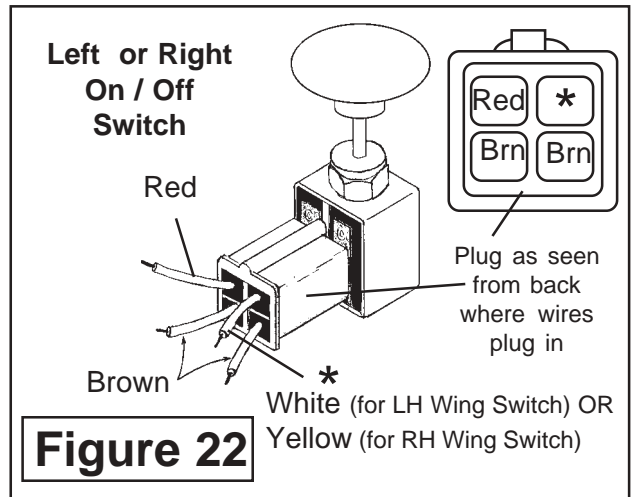

Figure 22

Remote Control Cable Connections

Remote Control Cable Connections: (continued)

6. Each controller assembly comes fully assembled. All required hardware etc. is included. The control cables are not included with the control handles and should be ordered separately. The Controller must face forward as shown or controls will be backward (See Figure 23)

7. To attach the cable, manipulate the controller handle so that the attachment nut is exposed as shown. Remove the lower most nut and screw from the controller housing.

Thread the cable nut into the controller attachment nut and tighten. (See Figure 24)

8. Allow the controller handle to return to neutral. Slide the cable guide tube into the control housing and reinstall and tighten the housing screw.

9. Check the operation of the spool, cable and controller. Some adjustment at the valve end may be required too ensure that the spool returns to neutral when the controller is in the neutral position. (See Figure 25)

10. The control lever assemblies utilizes a small spring to make up for free play in the cable to valve connection. The control valve spool spring provides the centering capabilities of the controller and the valve spool. **Lack of centering at the controller is normally attributed to poor adjustment at the valve to cable connection or binding of the cables due to poor routing.**

11. The control lever assemblies will bolt together to form a group of handles, there will be 4 handles bolted together along with the switch mounting brackets. (See Figure 26 & 27) The switches will mount to these brackets. Dual Wings models will have two switches. The switch for the left wing mount on the left and switch for the right wing mounts on the right (See Figure 26 & 27). The same two long bolts that go through cable control handles will go through switch brackets.

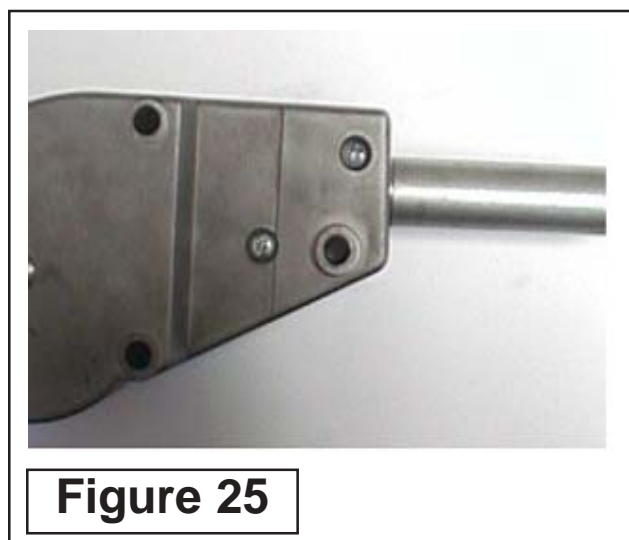
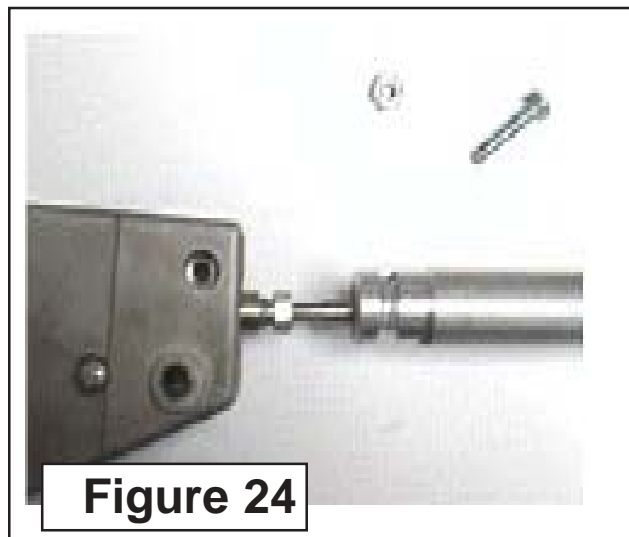
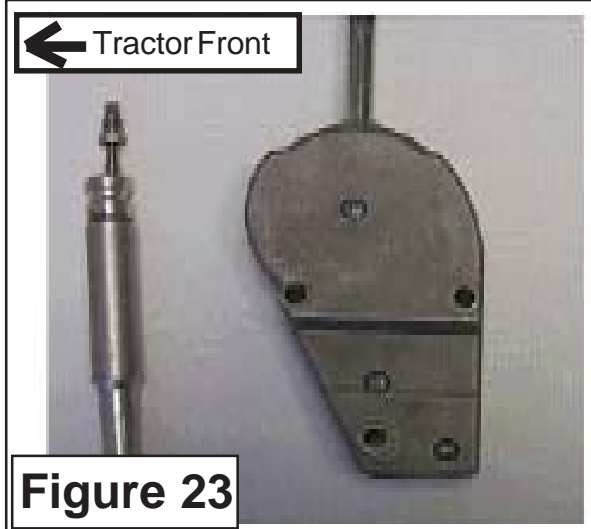

Remote Control Cable Connections

Remote Control Cable Connections: (continued)

12. Adjust Handles. The handles will have some adjustment to the as the Mounting bracket the handles bolt to will have slotted holes to allow the handles to be rotated to position the handles straight up. (See Figures 11, 26 & 27) Cab Model Shown.

13. Tie Cables and Wire Harness together. Tie the cables and Wire Harness together with plastic ties inside the cab and outside the cab. This will keep them from moving around. Cab Model Shown.

14. Control Valve Hydraulic Schematic. The schematic shows the routing of hoses to the cylinder control valve. The cables must be connected in pattern as shown (See Figure 27 & 29) in order for the proper function to match instructions. Cab or Rops model are the same (See Figure 29)

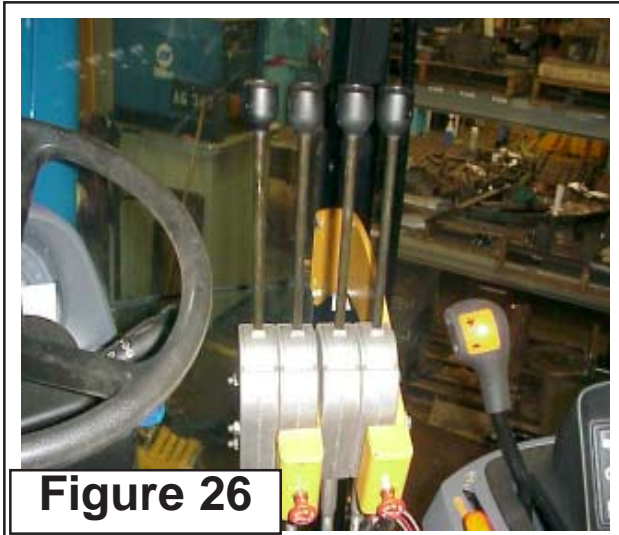

Figure 26

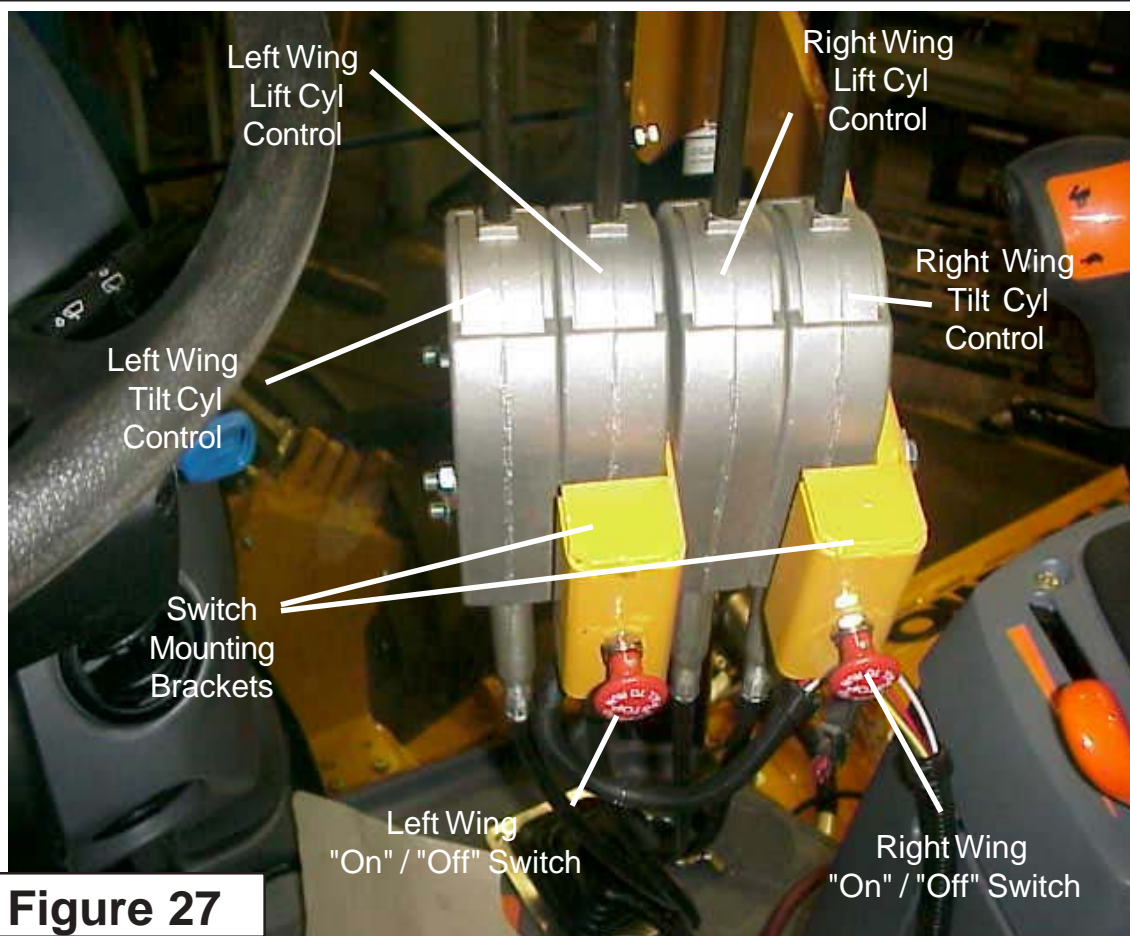

Figure 27

Remote Control Cable Connections

Remote Control Cable Connections: (continued)

15. Adjust Handles. Handles for thr Cab Model or Rops Nodel will adjust about the same. The handles will have some adjustment to them as the retaining nut on the Valve end of the cable is tightened. Tighten these retaining nuts now. (See Figure 28).

16. Check Hydraulic Hose Routing. Shown below is the routing of the hydraulic Cylinder & Control Valve. Double check these before running Unit. (See Figure 29)

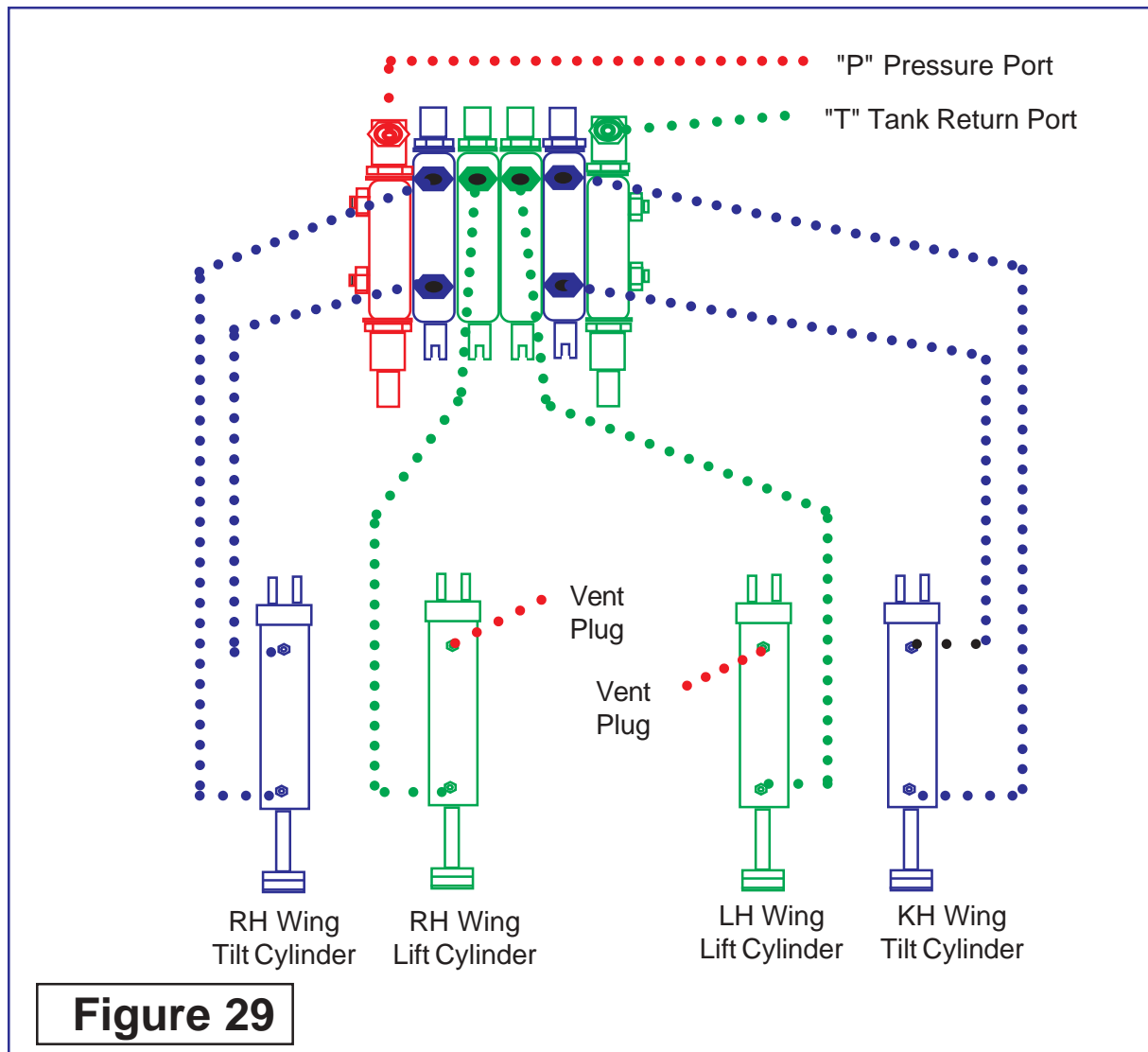

Wire Harness Connections

Wire Harness Connections:

1. Connect Wire Harness to Tractor Starter. The wires to the starter from the off on switches will need to be connected to the tractor near the started connections (See Figure 30, 31 & 32). All see the wire / harness schematic on the following pages. Consult the Tractor Repair Manual for wiring schematic of Tractor.

2. Check all Wire Harness Routing. Inspect all of the wire harness, make certain the all portions of wire harness that have been installed is tied up and out of the way of folding components or any thing that may damage them (See Figure 31 & 32).

3. Wires from the safety switch must be routed close to cutterhousing sidesheet and lift frame pivot points. This will prevent wires from being stretched and broken when cutterhousing is raised or lowered to maximum positons.

NOTE: Route wires in such a manner to prevent interference with the operation of tractor or INTERSTATER. Ensure that wires DO NOT lay against anything which could wear through insulation and cause a short circuit.

After connecting all wires, wrap wires with flexguard tubing. Neatly gather hydraulic hoses and flexguard tubing and strap together using plastic ties.

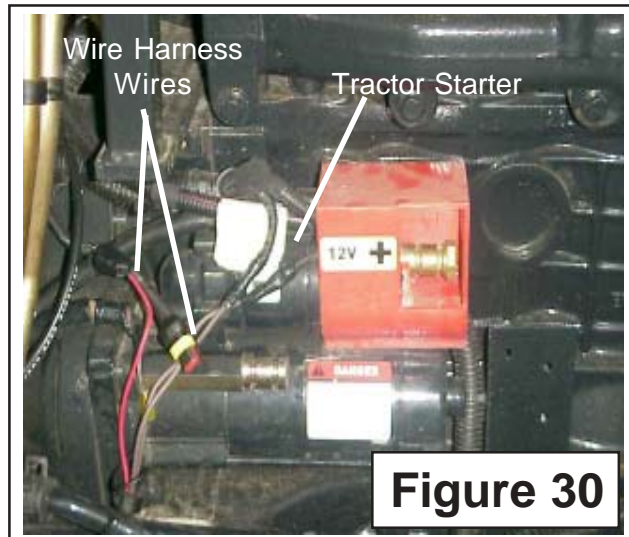

Wiring Harness Schematic

Figure 32

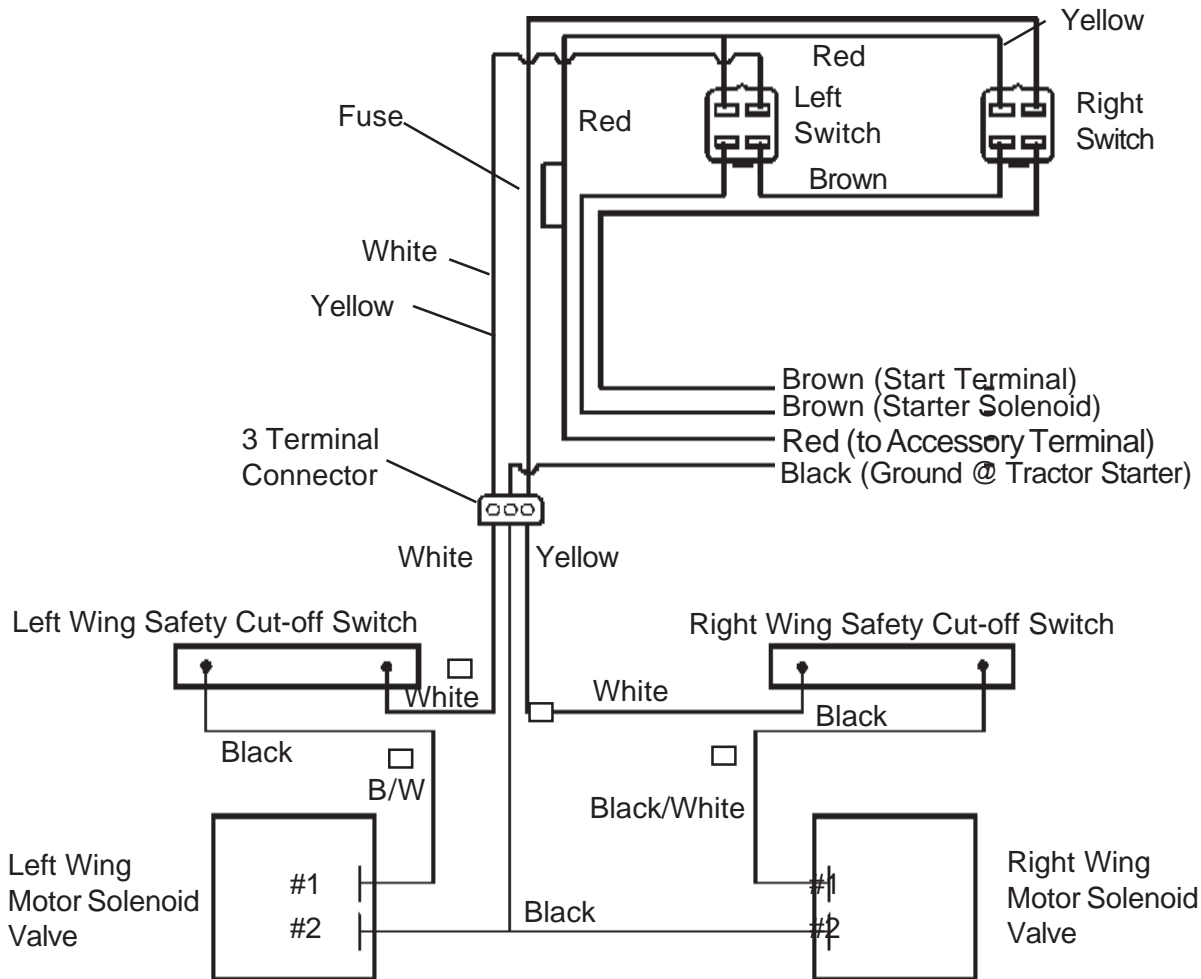
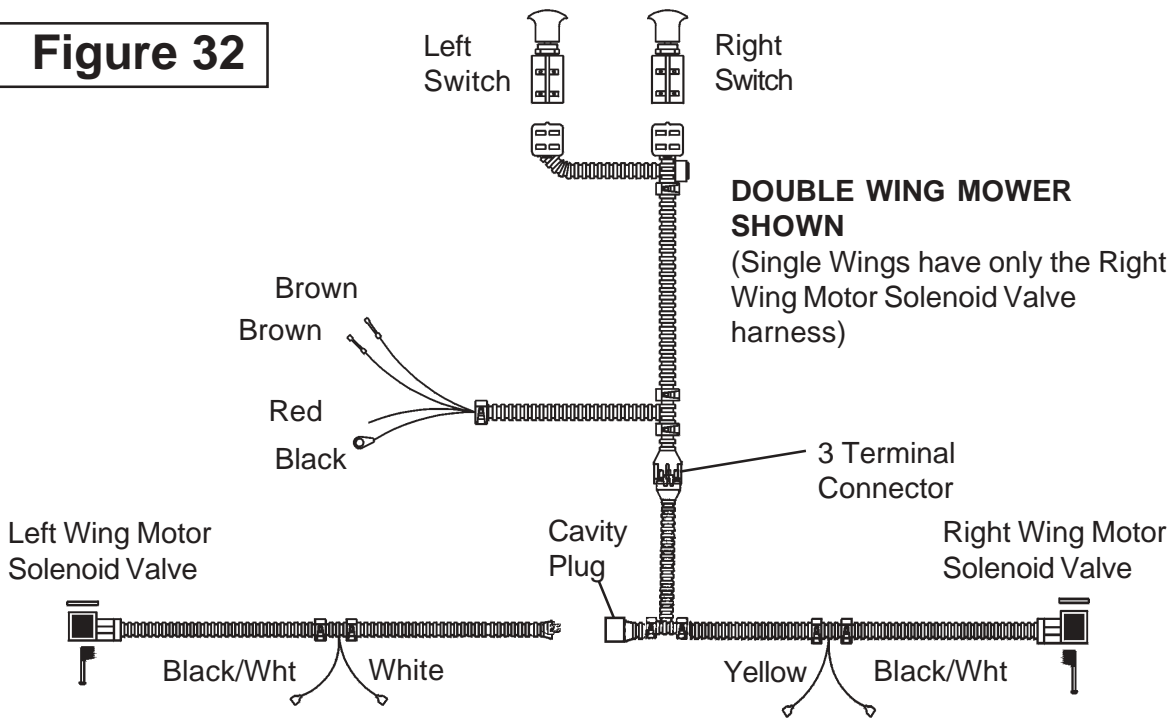

NOTES

Section 5

INTERSTATER

New Holland

TS100A, TS115A

TS125A, TS135A

Tractor

Tractor Exhaust

Modification

Tractor Exhaust Modification

Modify Exhaust on Tractor:

1. Modify Tractor Factory Exhaust System.

The Exhaust of the tractor must be modified to move exhaust (muffler) in closer (8-1/2" Closer) to the hood of tractor to give the Interstater clearance when wing is folded into the transport position. This should be done before the wing mower is mounted.

2. Remove Old Exhaust System. The stock factory muffler is removed first, this will be saved as it will be reused after the exhaust pipe to turbo has been changed.

3. Remove Existing Exhaust Pipe to Turbo & Existing Exhaust Mounting Bracket. There are four socket head bolts that hold the exhaust flange to the turbo, these will need to be removed completely. There is a stock mounting bracket located at the outer corner of the cab that supports the exhaust pipe. This bracket will be removed also. (See Figure 2). Lay the Bracket and exhaust pipe aside as the kit will include replace Pipe, Bracket and Fasteners.

4. Exhaust Relocation Kit. The new Exhaust pipe, mount bracket, clamp and flange mounting bolt will be included in Exhaust Relocation Kit P/N 02980916

Part No.	Qty	Description
02980933	1	Exhaust Brkt Wldmnt
02980917	1	Turbo Downpipe Wldmnt
02959132	2	3-1/2" Exhaust Clamp
02980728	3	Bolt, Hex Head 12 mm X 30 mm
701513C	3	Flat washer, 12 mm
00754566	3	Lockwasher, 12 mm

5. Install Exhaust Turbo Pipe. The new Exhaust pipe will come as a welded assembly (P/N 02980917) using the original flange and bolts. Tighten the four flange bolts that retain the turbo downpipe to the turbo.

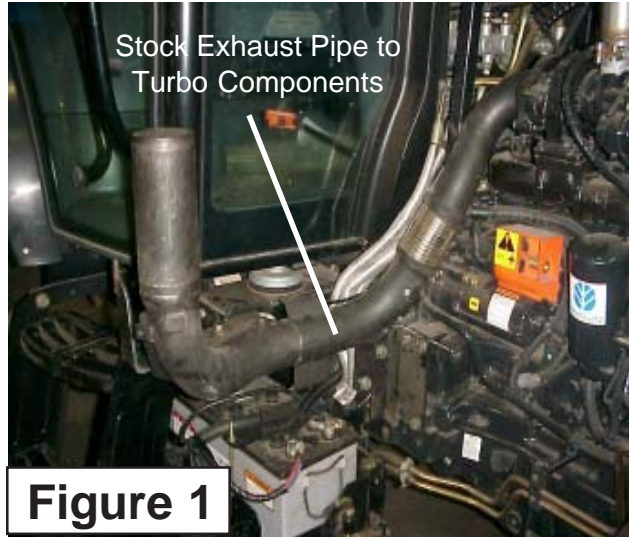

Figure 1

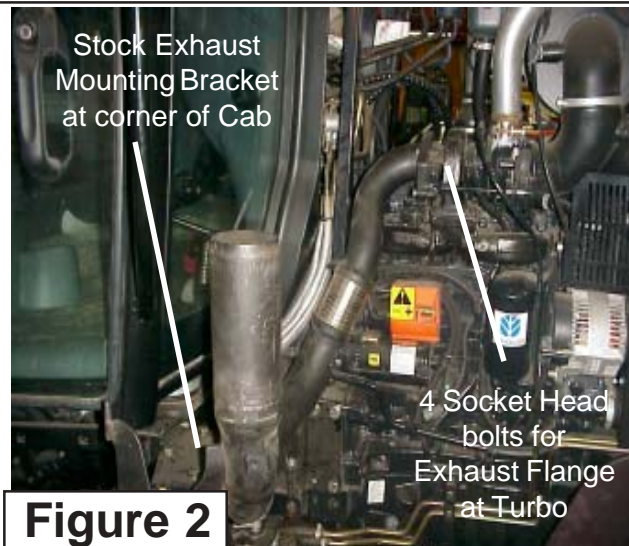

Figure 2

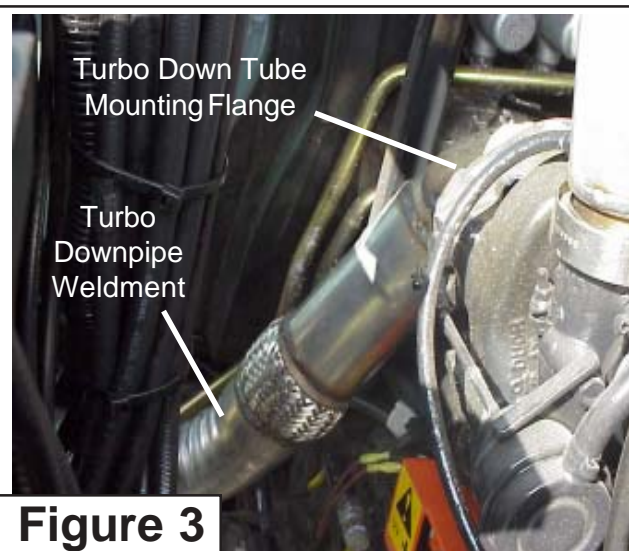

Figure 3

Tractor Exhaust Modification

Modify Exhaust on Tractor: (continued)

6. Install Exhaust Mount Bracket. The new Exhaust mounting Bracket Weldment (See Figure 4 & 5 P/N 02980649) must be installed to mount the new Turbo Downpipe to using the 3-1/2" Clamp (P/N 02959132) to mount the Downpipe the new Exhaust mounting bracket. Note: The New Exhaust Bracket has slotted holes in it that are not shown in the angle that figure 4 is showing the weldment. There are 3 Bolts and lockwashers used to mount this weldment.

7. Reinstall Muffler. Reinstall the muffler using the existing hardware for the muffler. Turn the tip of the muffler toward the LH side of tractor as shown in Figure 6 if it is not already. Muffler should now be 8-1/2" inward from the stock location, this is a must for clearance of the Wing when folded in the up (Transport) position. Note figure 6 show a high frame installed, this is for reference only, the muffler should be modified before frame and boom are mounted.

8. Muffler Clearance. Make certain that the hoses, wiring and other components are not touching the muffler. Make certain that all shields if any are replaced around muffler and exhaust pipe.

9. The LH Outside Rear View Mirror. The Left Hand outside rear view mirror will have to be removed as the boom will not clear it mounted to the cab. Any lights and/or brackets bolted to the hand rail on the RH side of the cab will have to be moved for clearance or remove completely. This will be determined by the installer at the time of installation.

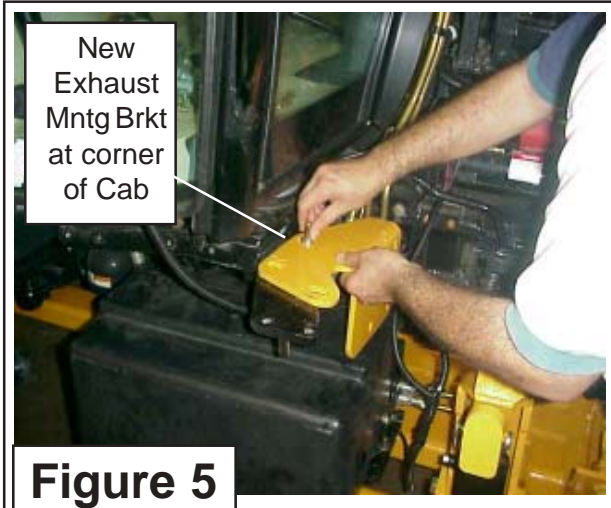
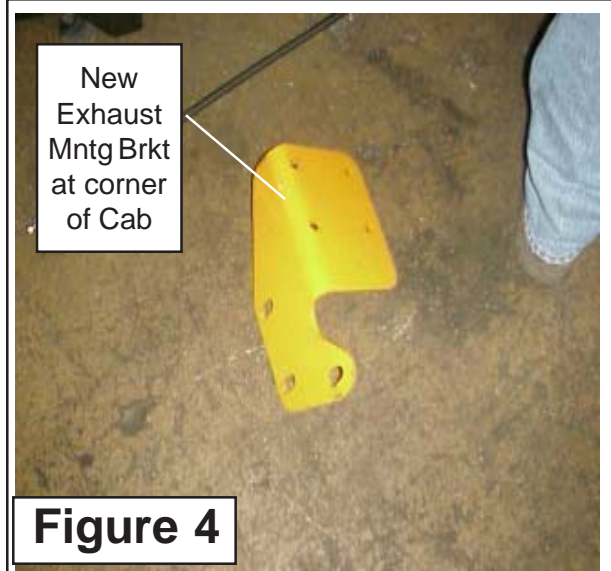

NOTES

Section 6

INTERSTATER

New Holland

TS100A, TS115A

TS125A, TS135A

Tractor

Tractor Fuel Tank

Replacement

Manufactured Fuel Tank Installation

Tractor Fuel Tank Replacement:

1. Remove the New Holland Factory Fuel Tank From Tractor. Drain all the fuel from the fuel tank with an approved pump or other device. Store fuel in an approved area. Remove the factory fuel tank. It is somewhat easier if the left rear tire & wheel are removed but it is not required. Some Tractors come with an optional Fuel Tank Protection Plate under tank, if you have this plate it will not be used with the Alamo Industrial replacement tank. (See Figure 1).
2. Remove the fuel sending unit from the factory tank. The factory fuel sending unit for the fuel level gauge will be reused, it will bolt into the replacement tank with out any modifications (See Figure 3). Note the replacement tank will come to you all ready painted but it may require touching up after mounting.
3. Install New Fuel Tank. The replacement fuel tank will install with the new straps supplied from Alamo Industrial. The is a Step Weldment that will bolt to the fuel tank to tank the place of the factory step that had to be removed.

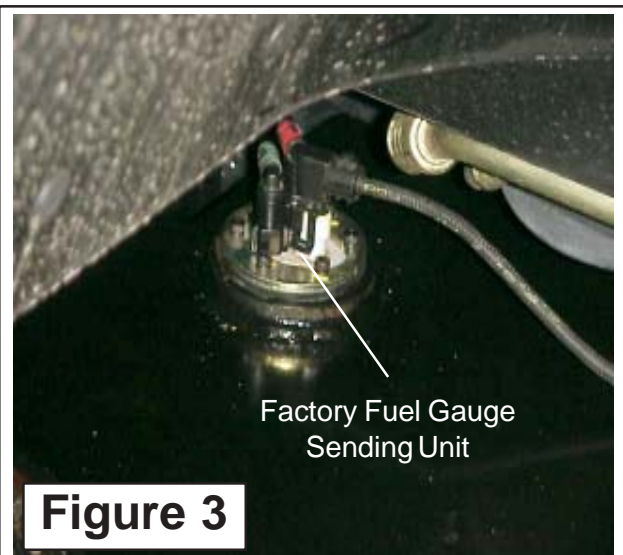
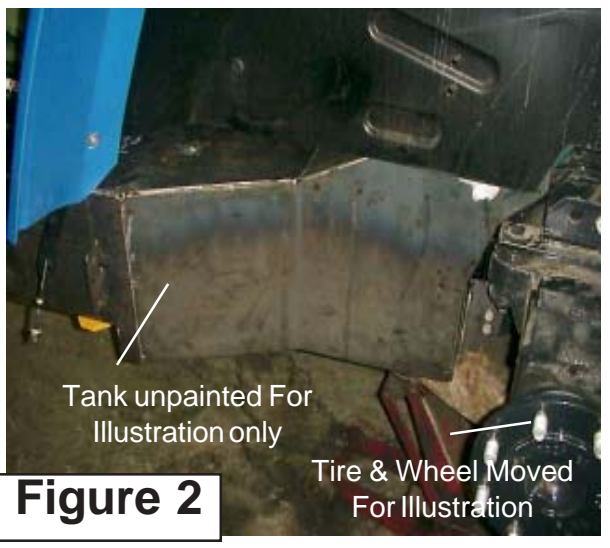
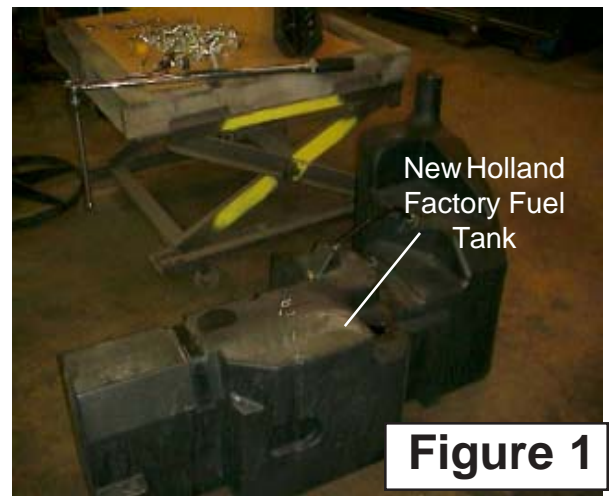

Section 7

INTERSTATER

New Holland

TS100A, TS115A

TS125A, TS135A

Tractor

Wing Mower

Installation

Wing Mower Installation

Wing Cut Off Switch:

1. Assemble Brackets & Magnetic Switches. Locate the Magnetic switch mounting bracket, dual wings there will be two of these (See Figure 1). If Dual wings the two brackets will have the switches mounted on the opposite side (See Figure 2). Once these have the switches bolted on lay the brackets aside for now. (See Figure 20)

2. Assemble Magnetic Switch Activators. This magnetic switch activator has a magnet inside and a cover that must be installed (See Figure 4). There are brackets that these bolt to. With dual wings there is a LH and RH bracket. Bolt the Magnetic activators to the brackets (See Figure 5) LH Bracket Shown). Note there are two sets of mounting holes. In figure 5 the set that have the bolts through them is used to shut wing off at 45 degree up. If the other set of holes are used wing mower will shut off at 90 degrees up. The 45 degree setting is recommended for standard applications.

3. Install Switch Brackets & Head Mounting Brackets. Use a hoist to lift the Wing Mower and position it for mounting. DO NOT get under Mower while lifted on a hoist (See Figure 6). Mower is only be positions so that switch brackets and hinge brackets can be installed to head, this must be done before mower can be mounted to lift frame.

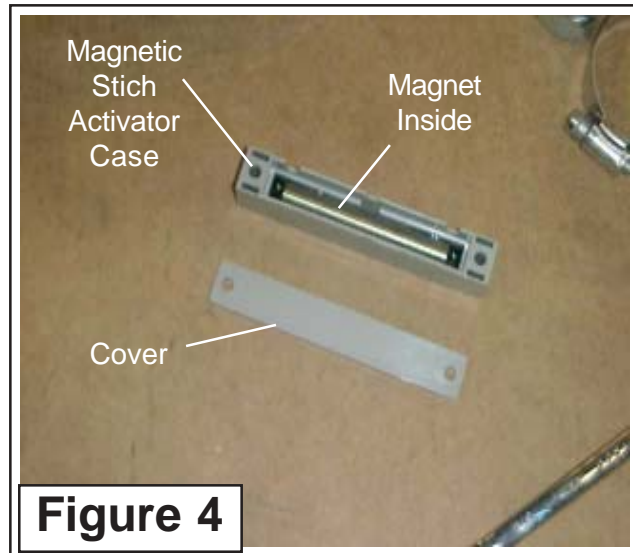
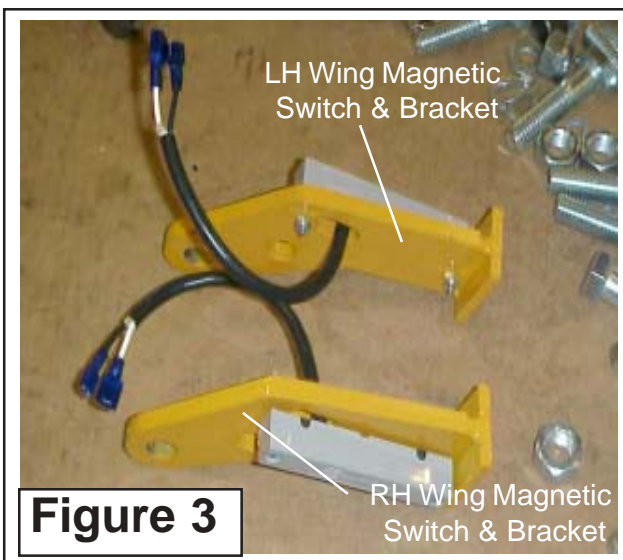
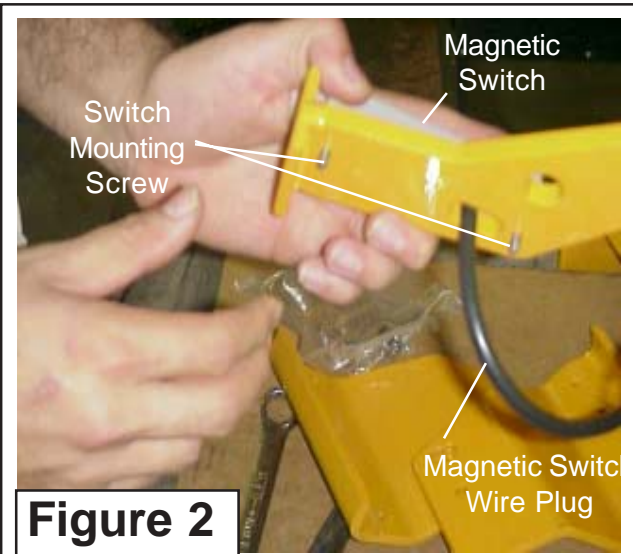
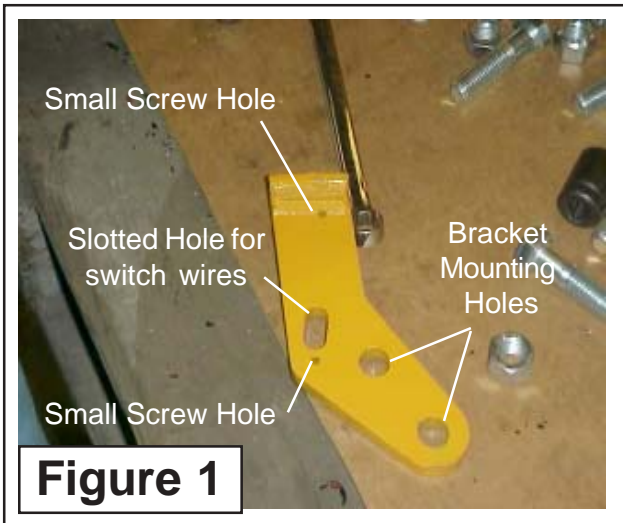

Wing Mower Installation

Wing Cut Off Switch: (continued)

4. Install Mower Rear Mounting Brackets & Magnetic Switches. The Mower Hinge Link has a LH & RH (See Figure 7). These brackets will slide over the Hinge Pin which is bolted to the mower deck at the factory. There are two Threaded holes in the end of the hinge pin (See Figure 7) These two holes serve dual purpose. First they hole the hinge bracket on and the Magnetic Activator Bracket on. Some times you will need to loosen the Hinge pin to align the two holes so the bracket will bolt on. (See Figure 8 & 9). Tighten the two mounting bolts in to the hinge pin. The Hinge bracket will still turn free.

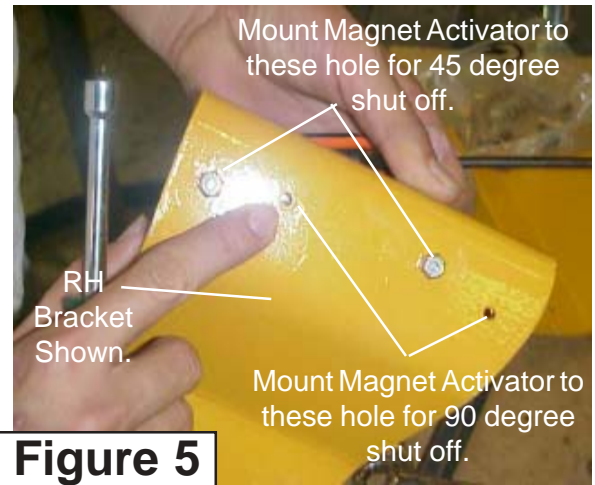

Figure 5

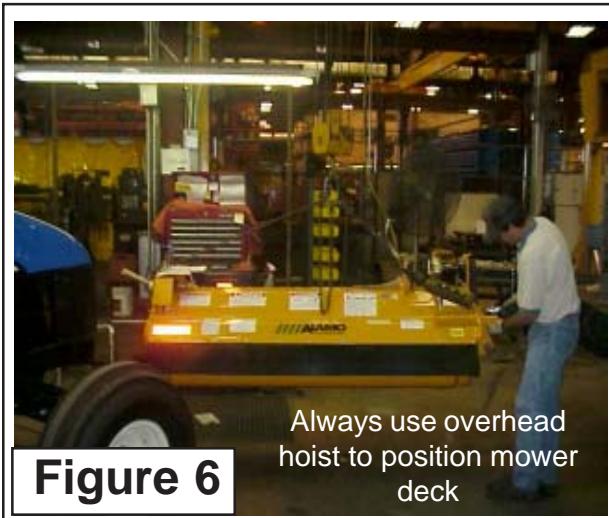

Figure 6

Always use overhead hoist to position mower deck



Figure 7

LH Wing Shown

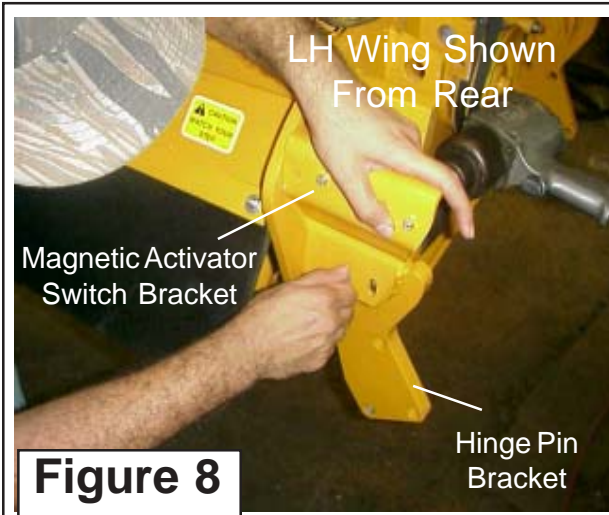

Figure 8

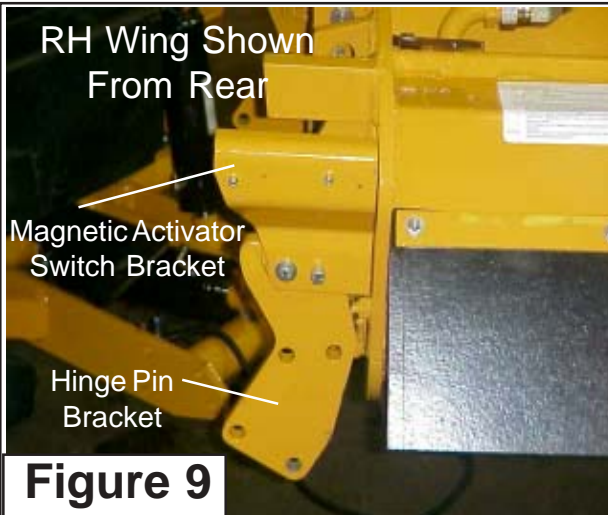

Figure 9

Wing Mower Installation

Wing Cut Off Switch: (continued)

5. Install Mower Front Mounting Brackets. The Mower Hinge Front Bracket has a LH & RH (See Figure 10). These brackets will slide over the Hinge Pin which is bolted to the mower deck at the factory. This bracket will be bolted to the Lift frame with four bolts. This hinge Pin WILL NOT have threaded holes as the rear hinge pin did.

6. Install Wing Mower to Lift Frame. Using the over head hoist position the Mower Deck (See Figure 10) to where the front hinge bracket will align with the lift frame. Install at least two of the mounting bolts and snug them down.

7. Install the wire harness to wings. The Wire harness will have a lead to each wing. These can be determined by the length, the longer lead will go to the left wing. There is a piece of square tube welded to the lift frame on the back for the wire harness to be run through (See Figure 11). The wire harness will be run down and under the round bar of lift frame. Leave harness here for now.

8. Install Magnetic Switch Pickup & Bracket as well as the rear hinge bracket. The Rear hinge Bracket will install similar to the way the front does, but not the same because the Magnetic switches and brackets bolt on with it. Before installing the rear Hinge bracket locate the magnetic Switch Bracket (See Figure 12). There are two spacers about 3/4" long that must be installed between the magnetic switch bracket and the hinge Bracket (See Figure 12), Also the wire harness must be run between these two spacers and between these two brackets (See Figure 13 & 14). Install the remaining two bolts and tighten all the hinge bracket bolts, this will include the front hinge bracket bolts. (See Figure 21)

9. Plug Magnetic Switch into Wire Harness. The wire harness should have a plug that aligns with the magnetic switch wire. Plug these together now and continued to run wire harness up behind the hinge and on up to the mower decks motor. (See Figure 21)

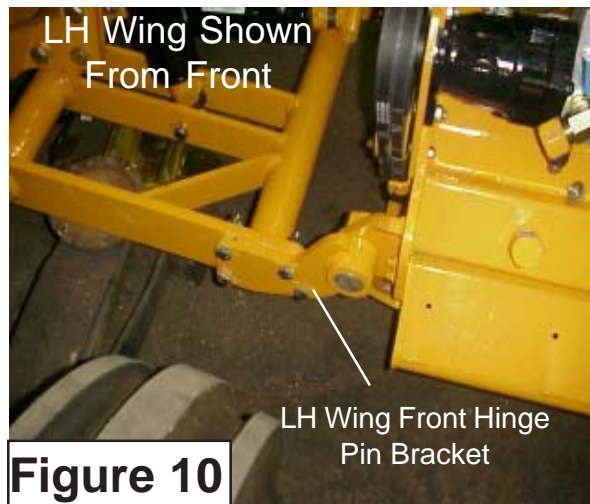

Wing Mower Installation

Wing Cut Off Switch: (continued)

10. Connect Tilt Cylinder to Mower Deck. The Tilt Cylinder connects to the mower head (See Figure 15 & 16). Note you will need to remove the belt guard to connect this cylinder so you will have room for the cylinder mounting pin to be installed (See Figure 16). When connecting the cylinder the grease fitting on the rod end must face up, the locking collar on the cylinder must face up and be tightened on rod end. The RH Wing and the LH Wing will mount the same. Install the RH wing the same as the LH wing . Reinstall Belt Guard.

11. Install Wire Harness to Motor Solenoid. The thumb nut on top of the solenoid will allow the solenoid to be turned to different direction if needed. (See Figure 17 & 21)

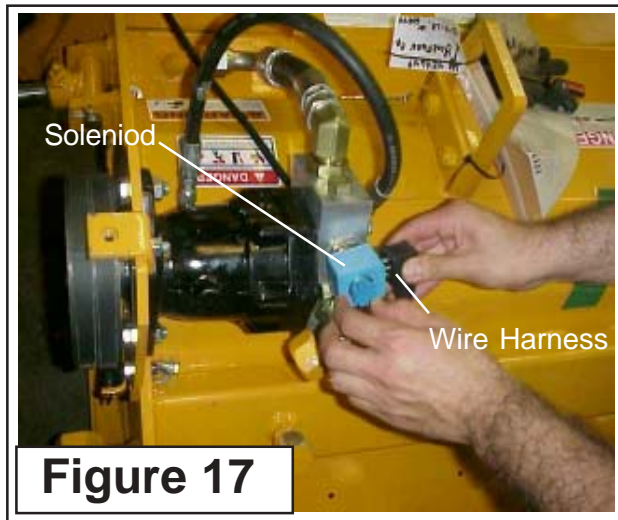
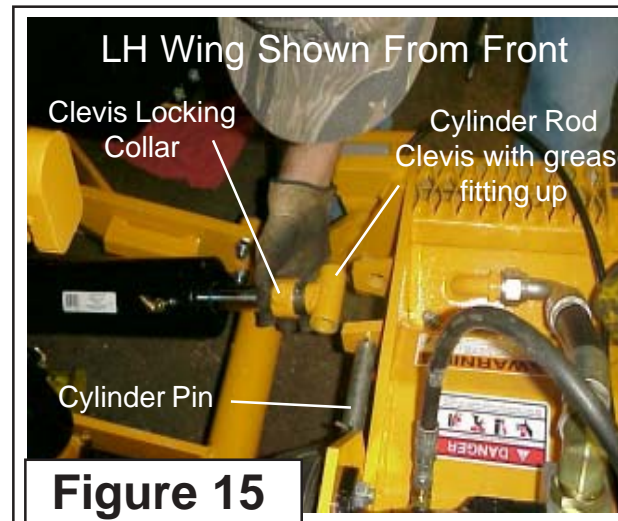

Wing Mower Installation

Connecting Mower Motor Hoses:

1. Connect Motor Pressure & Return Hoses to Mower Deck. Connecting the Motor Hoses is very critical that they are connected to the correct fittings, If these hose are connected backwards it will damage the cooling tubes on the deck, the cooling tubes cannot take the pressure it will make them swell up and bulge.

IMPORTANT FACT. When connecting the hoses to the fittings on the mainframe crossmember remember the top hose is always the pressure hose and will only connect to the motor, never the cooling tubes on the deck. The bottom hoses are the return hoses and will always connect to the cooling tubes on the mower deck. (See Figure 18 & 19). The RH wing will connect the same as the LH mower (Shown). **IMPORTANT.** On the RH Wing the top hose is pressure and connect to the Motor and the bottom hose connects to the Tank return.

2. Double Check all Hose Connections. Before operating the mower make certain all hydraulic hoses are connected correctly. IT IS MOST critical that you make certain NO HIGH PRESSURE hoses are connected to the wet tubes of the mower deck, The wet tubes will expand (swell up) and be damage if the High Pressure hose is connected to the deck wet (cooling) tubes. See Figure 21, 22, 23, 24, 25, 26 & 27. Looking at all these figure before going on to next step is important.

3. Install Pump Cover. The front pump cover will bolt to the tank, this cover will cover pumps and all hoses and/or fittings connected to the pump (See Figure 20). Set the cover down over the pumps. Align the hove in cover with the tabs welded to the tank (See Figure 20).

4. Install Rear Mower. Go on to the Install rear mower section which will also include the Initial Start up procedures. DO NOT START Tractor until you have completed the initial start up section.

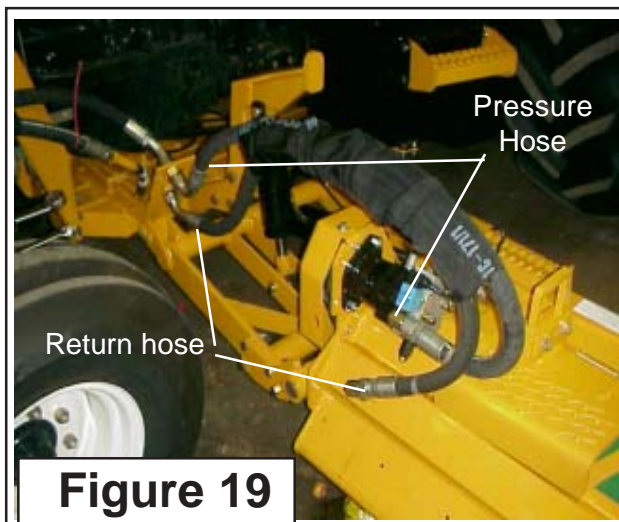
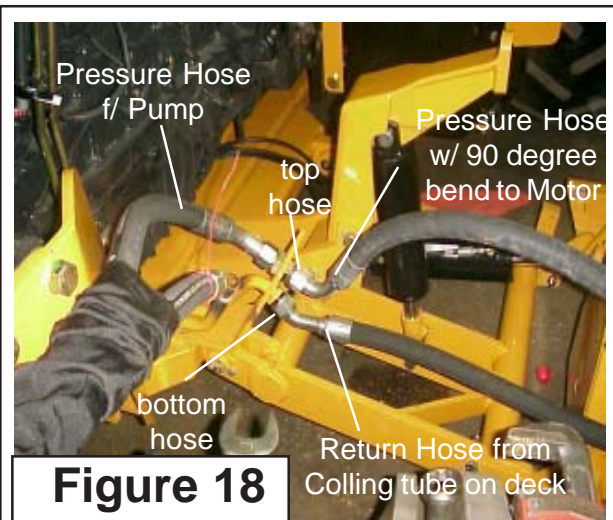

Wiring Schematic

Figure 21

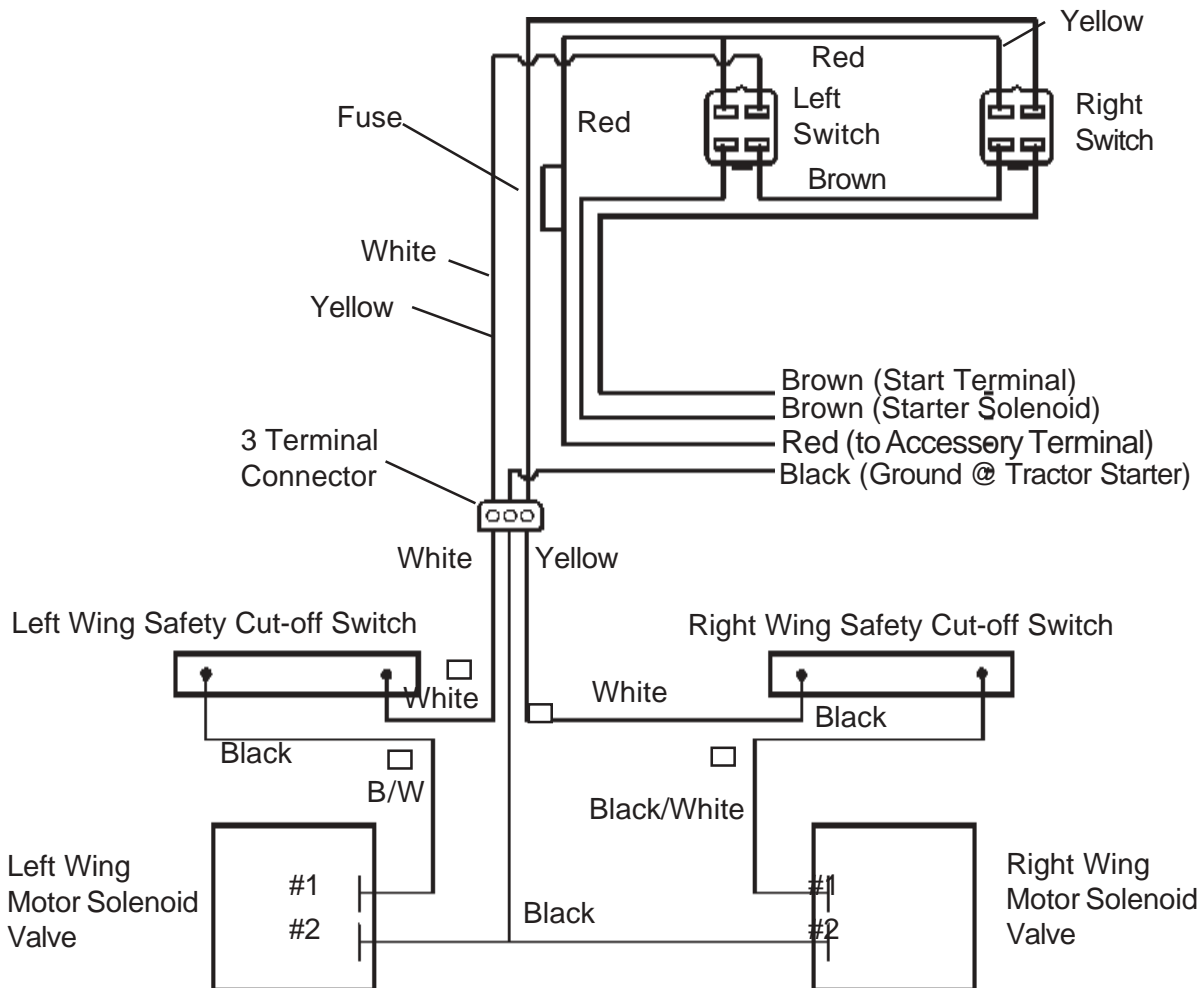
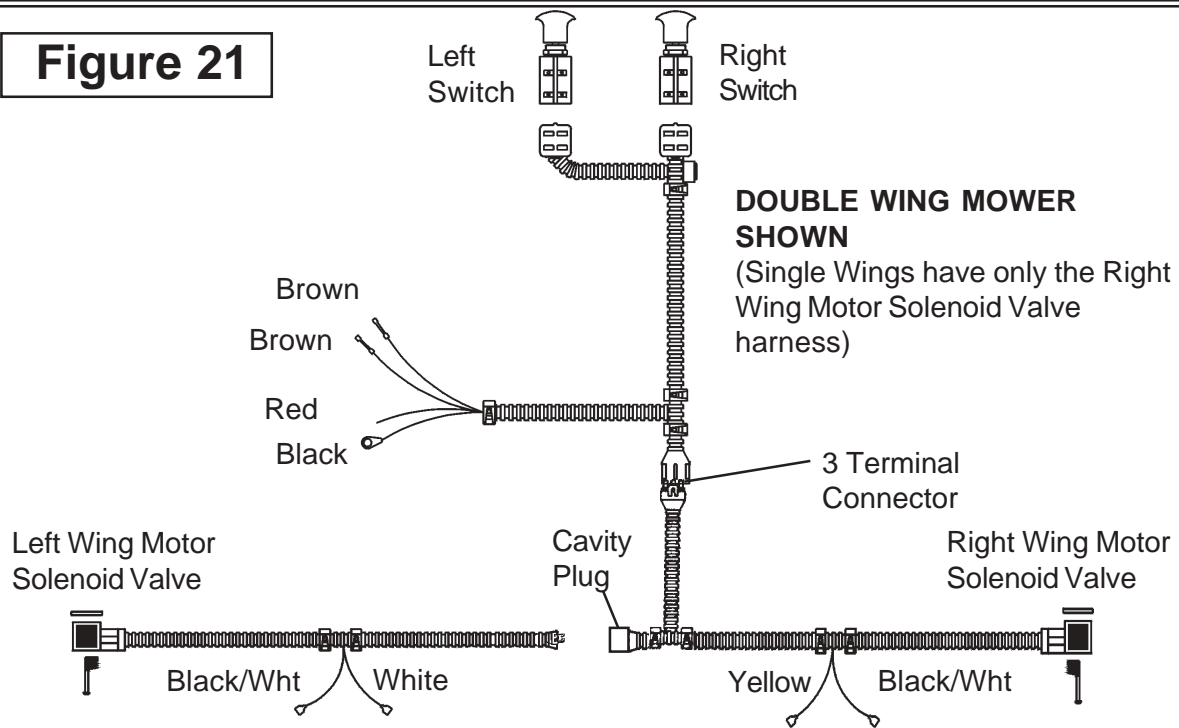

Pump & Motor Hydraulic Schematic

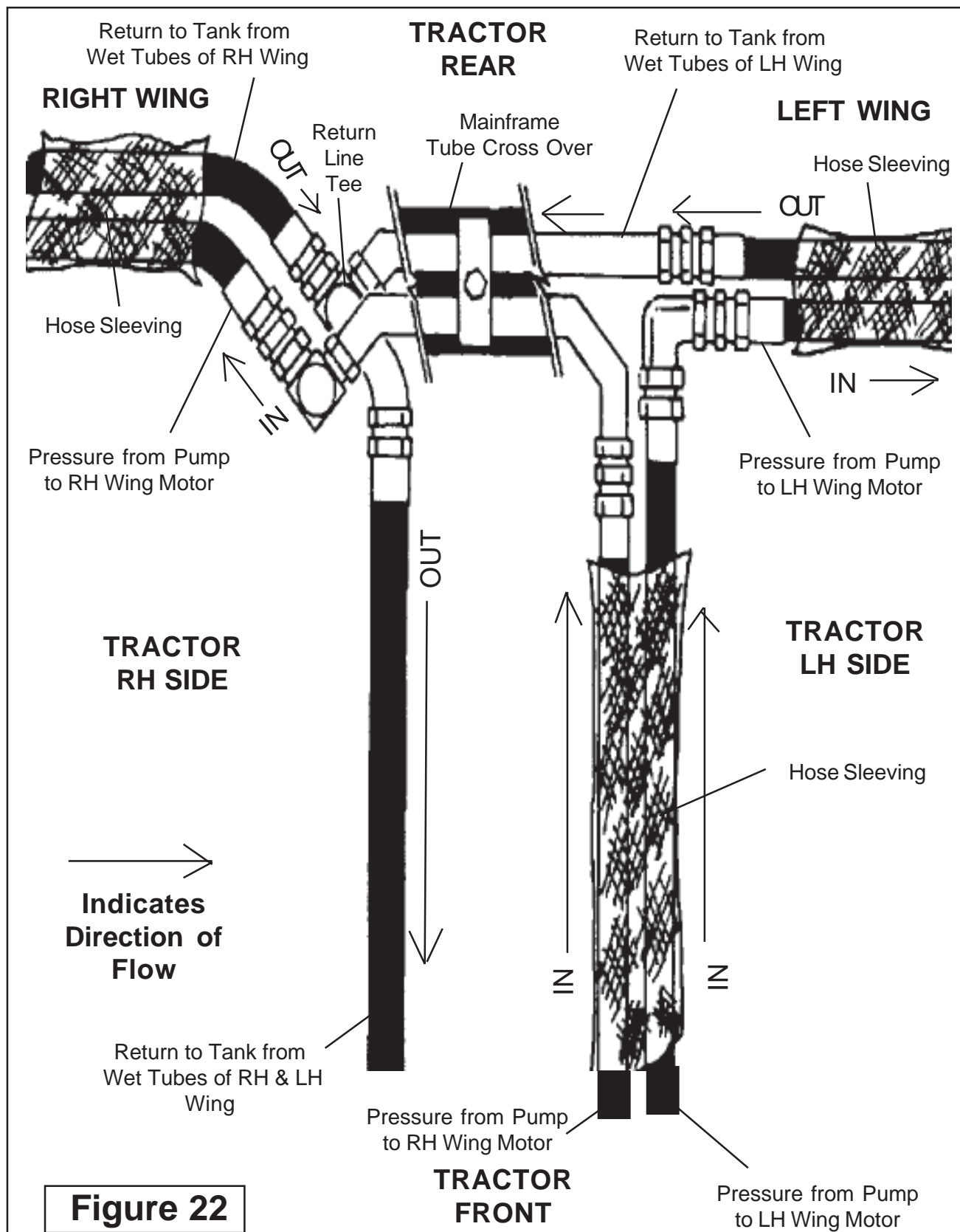

Figure 22

Pump & Motor Hydraulic Schematic

LEFT WING HYDRAULIC MOTOR SHOWN

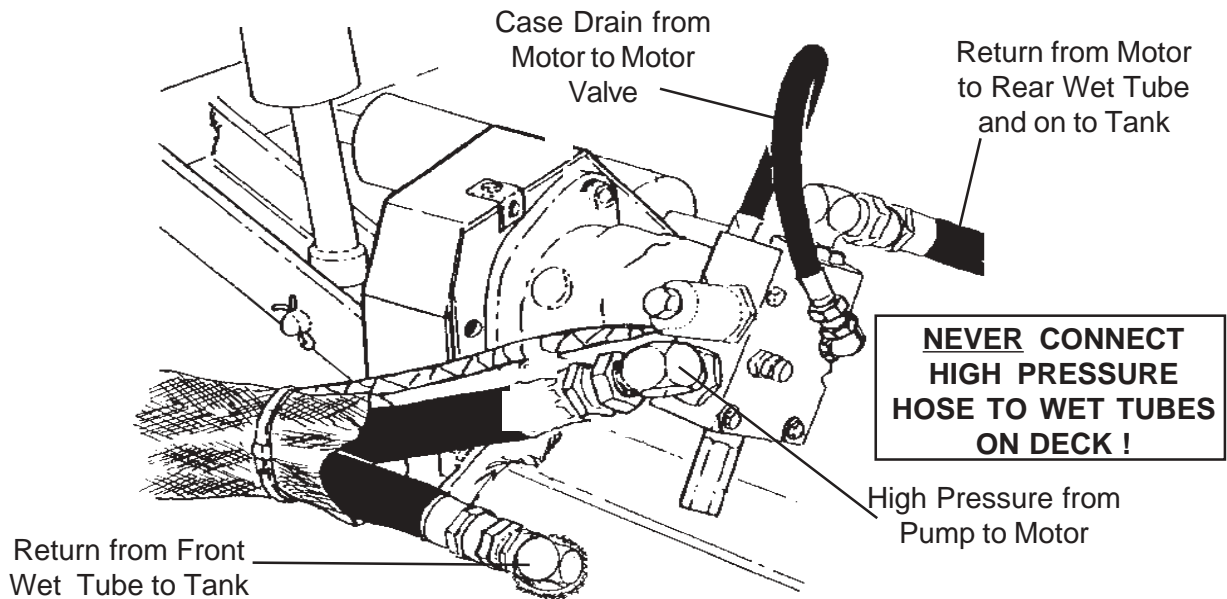

Figure 23

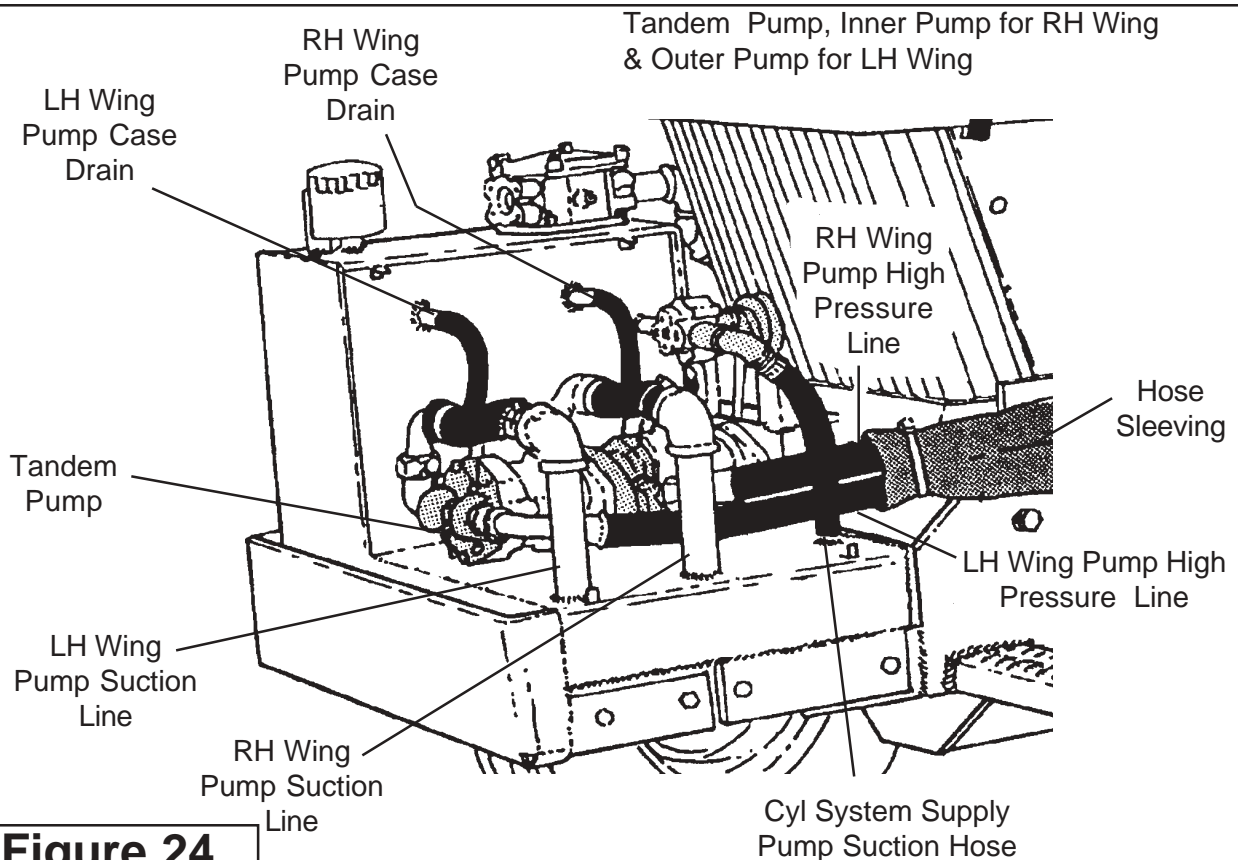

Figure 24

Pump & Motor Hydraulic Schematic

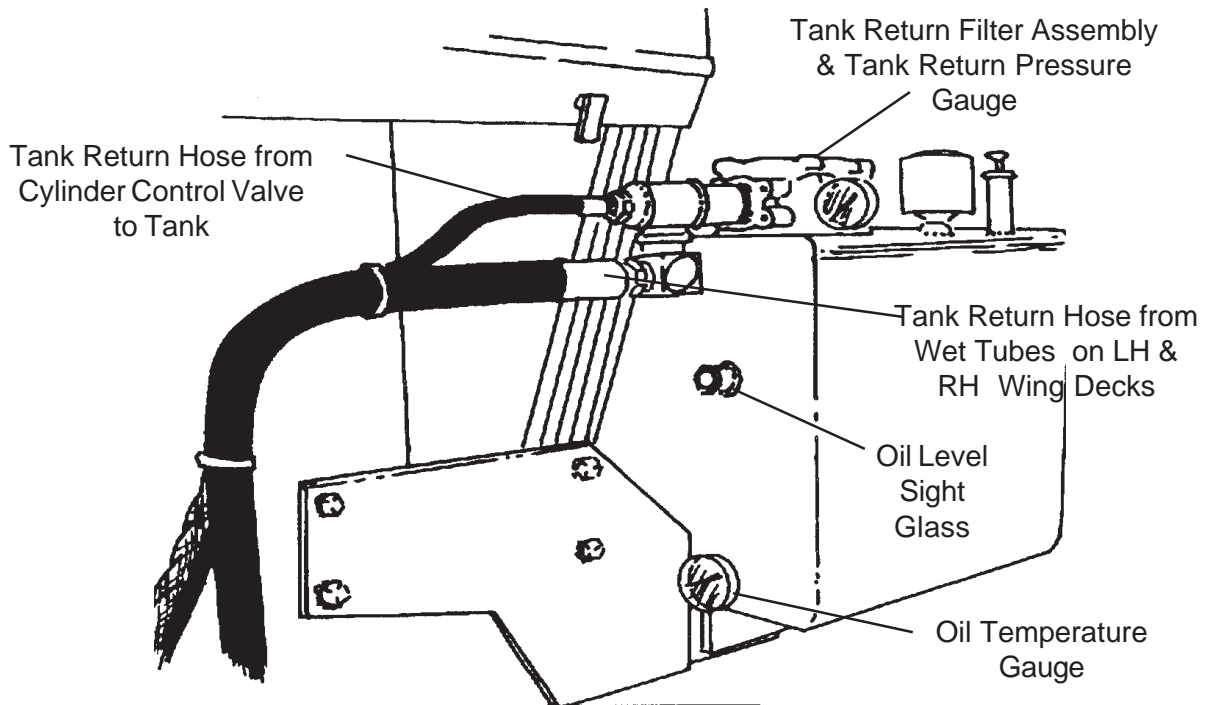

Figure 25

Upper Connection Always from Pump To Wing Motors NEVER TO WET TUBES (HIGH PRESSURE)

Main Frame Cross Over Bracket & Tubes (RH Side Shown, note Tee Fitting in lower fittings)

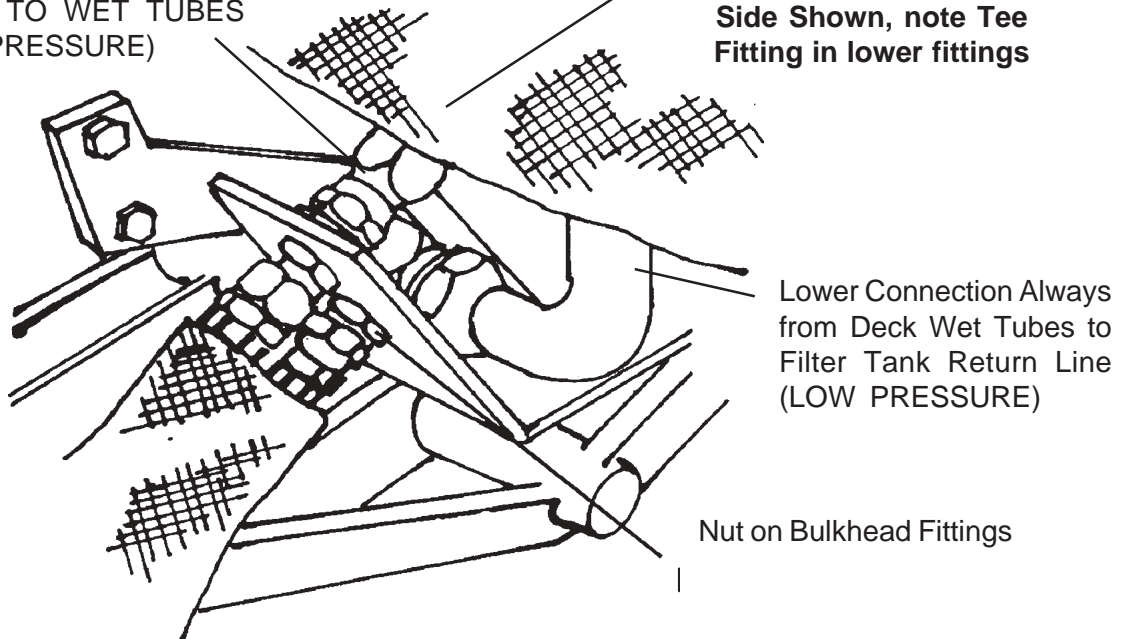
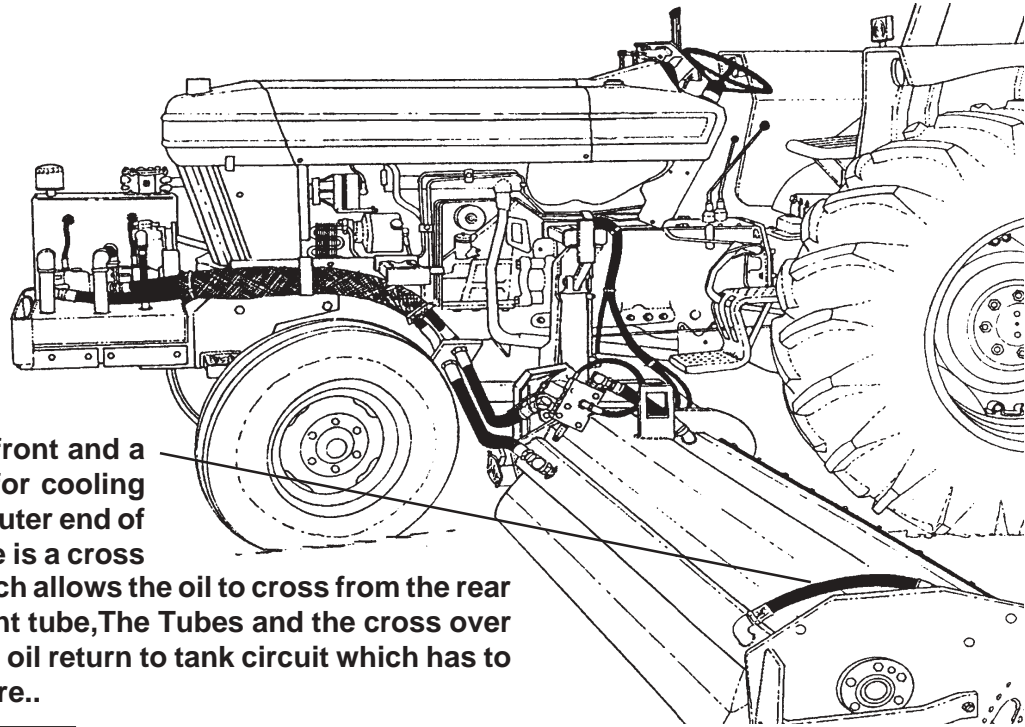

Figure 26

Pump & Motor Hydraulic Schematic



Wings have a front and a rear wet tube for cooling the oil. At the outer end of the decks there is a cross over hose which allows the oil to cross from the rear tube to the front tube, The Tubes and the cross over hose are in the oil return to tank circuit which has to be low pressure..

Figure 27

NOTES

Section 8

INTERSTATER **New Holland** **TS100A, TS115A** **TS125A, TS135A** **Tractor** **Rear Mower Installation**

Rear Three Point Mower

Rear Three Point Mower Connection:

1. The Rear Mower is a standard Three Point Hitch mounted mower that is PTO driven through a driveline. It will be sent already assembled with the driveline tied to it. (See Figure 1)
2. Connect Lower Hitch Pins. The lower hitch pins connect to the lift arms of the tractor with click pins, these pins are furnished with the mower. (See Figure 2). It is best to connect the lower arms of the three point first. You can use the lower arms to
3. Connect Upper Hitch Pin. The upper hitch pin will connect to the top three point adjustable Link with a pin and click pin. The Top Link is furnished with the tractor not with the mower. The Top Link is adjustable in length and is used to level the mower. (See Figure 3)
4. Connect Driveline. The Driveline arrive tied to the mower (See Figure 1 & 4). Cut the ties loose from mower. Connect the clutch end of the driveline to the mower, the clutch is retained to tgearbos input shaft by a clamp yoke on clutch hub. Slip the clutch onto the input shaft untill holes in clamp yoke are aligned with the grooves in the inbut shaft. Install and tighten the two bolts and nuts. The QD Yoke end connect to the Tractor PTO.



Figure 1



Figure 2



Figure 3



Figure 4

Rear Three Point Mower

Rear Three Point Mower Connection:

5. Leveling the Rear Mower & Adjust cutting Cutting Height. The Rear Mower is leveled with the top Three Point Link. The Cutting Height is adjusted by moving the Roller up or down by change the bearing bracket mounting hole. There is a decal on the deck next the Operators/ parts manual cannister (See Figure 5 & 6)

6. Rear Mower Completely Connected. With the rear mower completely connected. Check all Oil levels and grease mower components (See Figure 9) before running mower. Also DO NOT start tractor if the rest of the assembly to the interstater is not done. Make certain that all hoses, components, wiring is completed and Oil Tank for interstater has been filled with oil.

7. Slip clutch is incorporated in the PTO driveline. It is designed to slip, absorb the shock load, and protect the driveline. It is important that the clutch lining plates slip when an obstacle or load heavier than clutch setting is encountered. Therefore, if the machine sits outside longer than 30 days and is exposed to rain and/or humid air it is important to make sure that the clutch lining plates are not rusted/corroded together. Before using the mower use the following procedure to make sure the clutch will slip and give the overload protection required. (See Figure 8) This is a required step because the driveline has been sitting and may be stuck.

- A. Loosen nuts on springs until the springs can freely rotate, yet remain secure on bolts.
- B. Attach mower to tractor and start the tractor. Set the engine speed at 1200 RPM.
- C. Mark outer plates with marker, paint or any form that will work for you to tell if the components of the clutch slipped.
- D. Engage the PTO (approximately one second) and then quickly disengage it. The friction lining plates should break loose (check the mark).
- E. Turn tractor off and tighten the nuts on the springs to their original position of 1-5/16" compressed spring length.



Figure 5

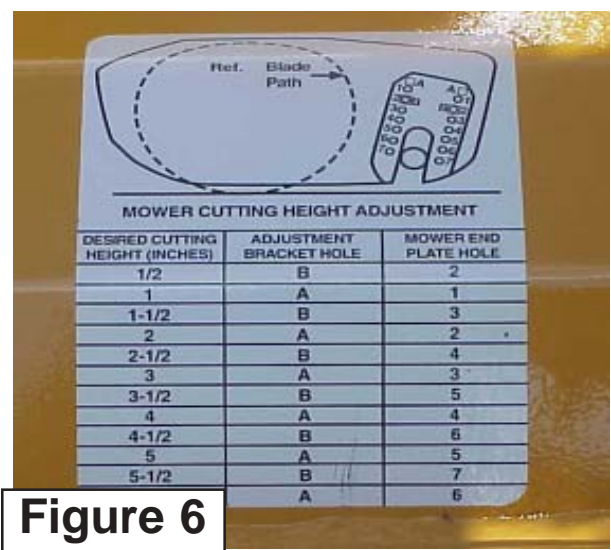

Figure 6

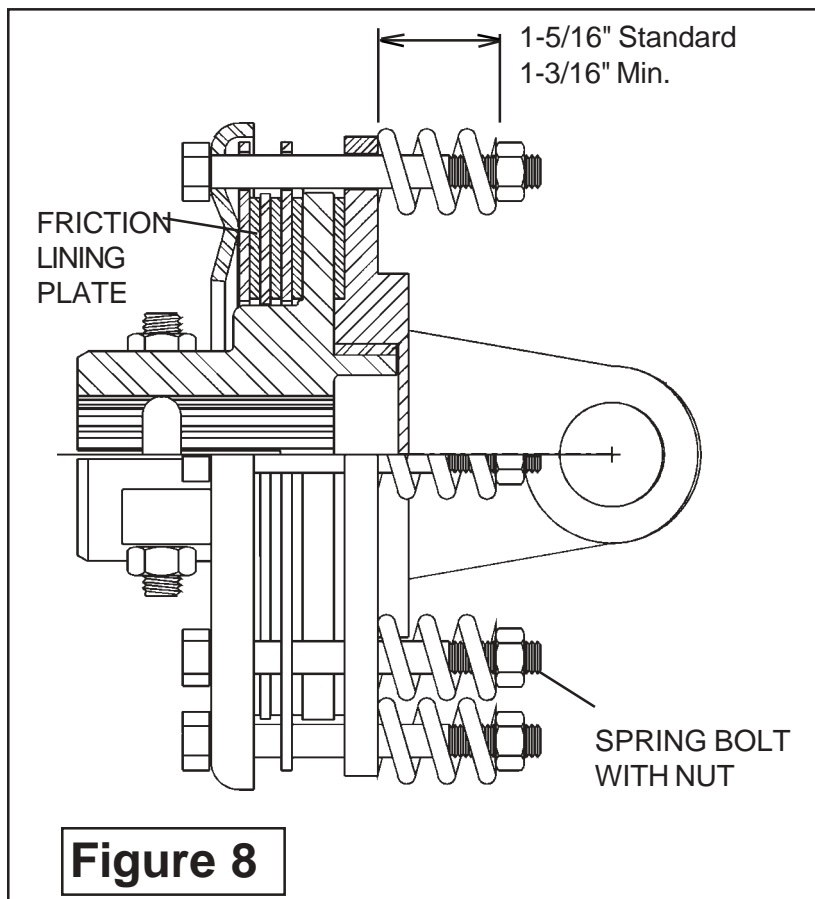

Figure 7

Rear Three Point Mower

Rear Three Point Mower Connection:

8. Slip clutch is incorporated in the PTO driveline. It is designed to slip, absorb the shock load, and protect the driveline. After the first hour of operation, the slip clutch should be checked for overheating. After this first check, the slip clutch should be checked weekly or anytime there is overheating. To adjust the slip clutch, tighten the spring bolts 1/8 (maximum) turn at a time. Bolts should NEVER be adjusted to the point where the springs are compressed solid. Minimum spring length is 1-1/8". The slip clutch should be checked periodically and adjusted to compensate for wear. The lining plates are 1/8" thick when new. Replace after 1/32" wear. If the mower has been idle for an extended period of time, or in wet weather, before operating check to be sure the friction lining plates are not frozen or rusted together. Should this freezing occur refer to the procedure described in the "Seasonal Clutch Maintenance" section on the next page. There are four friction lining plates in the slip clutch. These should be checked weekly for oil or grease, wear, and moisture which could cause corrosion on the drive plates. (See Figure 7) **NOTE: Above information is listed as a reference only and will not apply to mower assembly.**



Lubrication Points

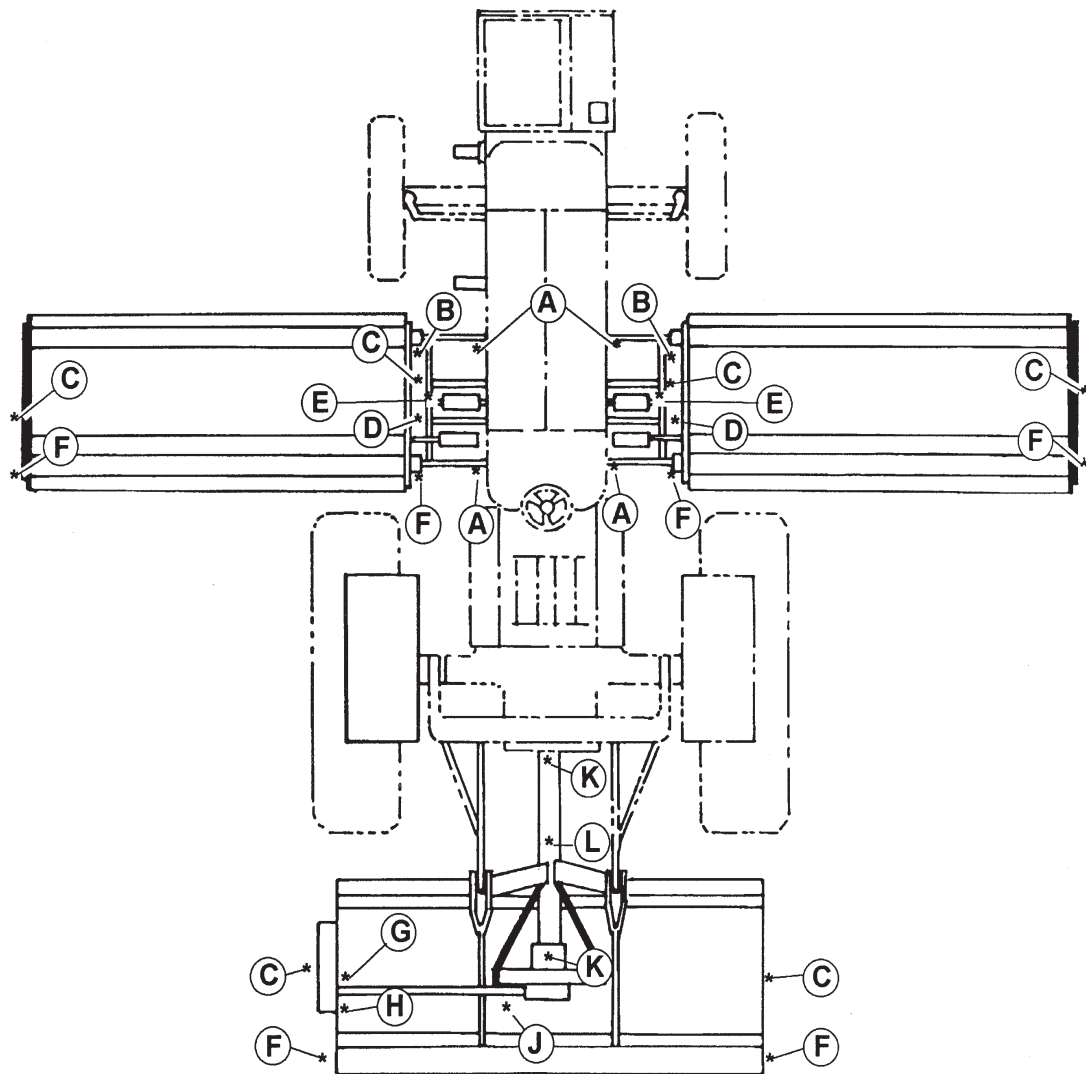

LUBRICATE ALL POINTS BEFORE OPERATING MOWER FIRST TIME

- | | | | |
|---|---------------------------|---|----------------------|
| A | Lift Frame Pivot Pin | G | Rear Mower Idler Arm |
| B | Wing Mower Belt Idler Arm | H | Banjo Bearings |
| C | Cuttershaft Bearings | J | Banjo Coupling |
| D | Tilt Cylinder Rod Ends | K | Driveline Yoke |
| E | Lift Cylinder Rod Ends | L | Driveline slip |
| F | Roller Bearings | | |

Figure 9

Initial Start-Up Procedure

INITIAL START-UP PROCEDURE:

1. Check all nuts and hex head capscrews to ensure all are tight and all lock washers are fully compressed (flattened).
2. Check all hoses and hydraulic connections. Make certain they are secure.
3. Inspect all moving parts and be sure that no wires or hoses will be caught or pinched when the tractor or the INTERSTATER is in operation. Tie down loose wires and hoses.
4. Thoroughly grease the INTERSTATER and install a lubricap on each grease fitting. Refer to the Operation and Maintenance Section.
5. Jack front of tractor up enough to allow axle to pivot through its full range. While turning wheels through their limits, right and left, swing them up and down. Look for interference between tires and any part of the INTERSTATER. If interference occurs, shims (not furnished) must be welded to axle pivot stop or steering arm to limit the movement enough to avoid interference. Tractors with an adjustable front axle may require an outward adjustment of the wheels.
6. To fill the INTERSTATER reservoir with new, clean hydraulic oil, follow the steps below. Refer to the Operation and Maintenance Section for specifications. (See Figure 10)
 - A. With a hydraulic jack raise the right side of the tractor. This will tilt the tank and allow only a minimum amount of air when filling.
 - B. Avoid hydraulic contamination by filtering the hydraulic oil while filling the hydraulic tank.
 - C. Filter buggies or carts are commercially available for hydraulic system clean-up. These consist of a high-efficiency, high-capacity filter, a circulating pump, a drive motor, and hoses for connecting the overhauled machine's hydraulic system.
 - D. After the first 10 hours of operation, replace the hydraulic filter with a new one. An extra Filter Element is provided for you. Refer to the Operation and Maintenance Section for instruction.
7. After the Interstater mower is completely assembled to the tractor and with the wings on the ground, fill the mower hydraulic tank above the oil level sight gauge approximately 5" or 1" below the top of the tank.
8. With mower ON/OFF switches in "ON" position and tractor fuel cut off, crank engine for about 30 to 45 seconds to allow oil to fill pumps and motors. Check the oil level in the sight gauge. If no oil is seen add oil to bring the level up to the sight gauge. NOTE: Do not fill the tank with oil above the level of the sight gauge. Over filling the tank with oil after the initial filling may result in oil being discharged through the air filter on top of the hydraulic tank. Start the tractor and run it for 2 minutes and then turn it off. Again check the oil level in the sight gauge. If the oil level is in the sight gauge, the unit is ready to run. If no oil is seen, add oil to bring the level up to the sight gauge.

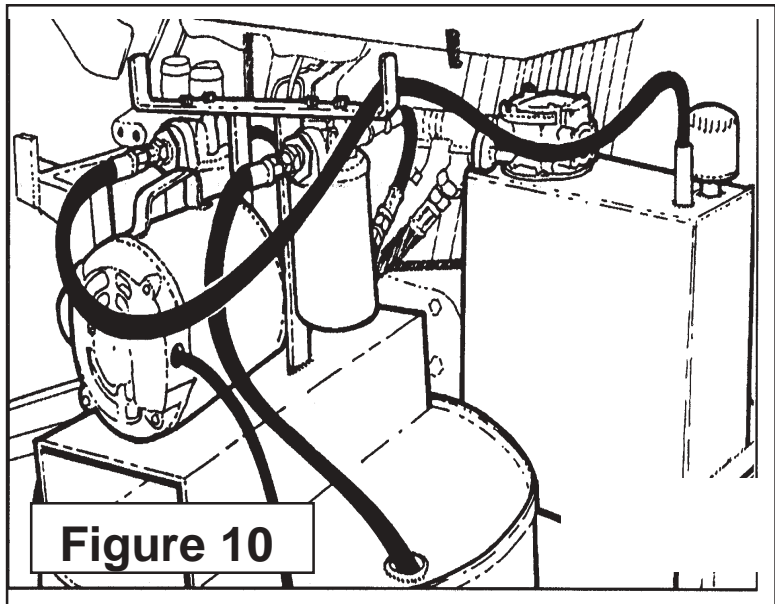

Initial Start-Up Procedure

CAUTION

ROTATING KNIVES!

Remove all foreign objects and stand clear of cutter units. **DO NOT GET NEAR!**



NOTE: On tractor hydraulic powered circuit only, make certain that there is full flow from tractor hydraulic system to control valve. Refer to tractor manual.

9. After hydraulic system is fully charged and functioning properly, switch cutter units on, then speed engine up to 540 RPM PTO speed. Maintain this speed for about 5 minutes. Check complete INTERSTATER, look for any leaks, loose connections, or anything that could cause premature wear or failure.

FINAL CHECK

Run INTERSTATER for about 1/2 hour at full speed. Check for leaks and vibrations. Frequently check oil temperature. Make certain it does not exceed 180 deg.

NOTE: When raising wings, make certain there is no interference with mower, frame, cylinders or tractor. Lift wings slowly.

CAUTION: DO NOT leave unit unattended, and **COMPLY WITH ALL WARNING DECALS.**



If unit starts to make unusual noise, stop unit and check oil level. Also check for frothy oil which would indicate a leak on suction side of system.

NOTES

Section 9

INTERSTATER **New Holland** **TS100A, TS115A** **TS125A, TS135A** **Tractor**

Mounting Specifications **& Mount Kit Numbers**

Tractor / Mower Mounting Specifications

New Holland TS100A Cab/2wd

As of: 4-16-04

10.00-16 Max Front Tire

18.4-30 Max Rear Tire

Mainframe: Right Hand Only (5" Offset Right)	02981068
Comp Crate: RH Only w/Aux Pump	02981075
Mainframe: Dual Wing (5" Offset Left & Right)	02980935
Comp Crate: Dual Wing w/Aux Pump	02980823
Replacement Fuel Tank (46 gal/Req'd for Dual)	02980938

Options:

Lift Chain Kit (See Spec Below)	02980514
---------------------------------------	----------

Specifications:

1. These mount kits include exhaust modification kit #02980717 which allows the vertical A-post style exhaust to be moved in approximately 8-1/2" for head transport clearance. In addition, a portion of the tractor's exhaust mounting bracket must be cut away to allow clearance for the path of the head lock-up lug.
2. These kits also include a battery relocation bracket which shifts the battery up and back. (See Figure 1) Furthermore, as a result of the cylinder mount position, the battery bracket will no longer hinge outward. However, the battery can still be accessed and even removed with the assistance of one additional person.
3. For dual wing mowers, the factory installed fuel tank must be replaced with the one listed above to permit clearance for the cylinder mount (See Figure 2).
4. Full Interstaters must be ordered with a 96" centered rear head. Right hand only models can be ordered with a 96" centered or 88" offset right 8.5" rear head. Two lift chains are recommended for centered heads, while offset heads should only be ordered with one.
5. The mainframe should allow approximately 10- 3/4" of ground clearance with the maximum tire size listed above.
6. As with most dual wing Interstaters, the left wing must be lowered for ingress/egress to the tractor platform.
7. For dual wing models, the left hand tractor steps must be removed. A replacement step is provided with the fuel tank kit. For dual and single wing models, the right hand steps must be removed for clearance as well. Ingress/egress on the right is otherwise blocked by the control stand.
8. The pump mount in this kit is assembled with a carrier bearing to extend the life of the driveline and pulley weldment.
9. Rear tires dimensionally larger than 18.4-30 may interfere with the replacement fuel tank and/or revised battery box position. Adjusting the rear wheels to a "full spread" may resolve such issues, however this has not been properly reviewed by our engineering team at this time.
10. These mount kits should also fit 4 wd tractors with 12.4-24 maximum front tires. However, special wing heads must be fabricated such that the cooling tube return fitting is moved out 12" for front tire clearance during transport. An engineering change request (ECR) must be submitted to revise the heads prior to accepting any 4 wd orders. Clipped foot guards are also recommended for this application.

Tractor / Mower Mounting Specifications

New Holland TS100A ROPS/2wd

As of: 4-16-04

10.00-16 Max Front Tire

18.4-30 Max Rear Tire

Mainframe: Right Hand Only (5" Offset Right)	02981068
Comp Crate: RH Only w/Aux Pump	02981072
Mainframe: Dual Wing (5" Offset Left & Right)	02980935
Comp Crate: Dual Wing w/Aux Pump	02980919
Replacement Fuel Tank (46 gal/Req'd for Dual)	02980938

Options:

Lift Chain Kit (See Spec Below)	02980514
Aluminum Canopy (FOPS Rated)	02980929

Specifications:

1. These mount kits include exhaust modification kit #02980717 which allows the vertical A-post style exhaust to be moved in approximately 8 1/2" for head transport clearance. In addition, a portion of the tractor's exhaust mounting bracket must be cut away to allow clearance for the path of the head lock-up lug.
2. These kits also include a battery relocation bracket which shifts the battery up and back. [\(Pictured on Cab Model Above\)](#) Furthermore, as a result of the cylinder mount position, the battery bracket will no longer hinge outward. However, the battery can still be accessed and even removed with the assistance of one additional person.
3. For dual wing mowers, the factory installed fuel tank must be replaced with the one listed above to permit clearance for the cylinder mount (See Figure 2).
4. Full Interstaters must be ordered with a 96" centered rear head. Right hand only models can be ordered with a 96" centered or 88" offset right 8.5" rear head. Two lift chains are recommended for centered heads, while offset heads should only be ordered with one.
5. The mainframe should allow approximately 10 3/4" of ground clearance with the maximum tire size listed above.
6. As with most dual wing Interstaters, the left wing must be lowered for ingress/egress to the tractor platform.
7. For dual wing models, the left hand tractor steps must be removed. A replacement step is provided with the fuel tank kit. For dual and single wing models, the right hand steps must be removed for clearance as well. Ingress/egress on the right is otherwise blocked by the control stand.
8. The pump mount in this kit is assembled with a carrier bearing to extend the life of the driveline and pulley weldment.
9. Rear tires dimensionally larger than 18.4-30 may interfere with the replacement fuel tank and/or revised battery box position. Adjusting the rear wheels to a "full spread" may resolve such issues, however this has not been properly reviewed by our engineering team at this time.
10. These mount kits should also fit 4wd tractors with 12.4-24 maximum front tires. However, special wing heads must be fabricated such that the cooling tube return fitting is moved out 12" for front tire clearance during transport. An engineering change request (ECR) must be submitted to revise the heads prior to accepting any 4wd orders. Clipped foot guards are also recommended for this application.

Tractor / Mower Mounting Specifications

New Holland TS115A/125A/135A Cab/2wd

As of: 5-19-04

10.00-16SL (F-2) Min / 12.4-24 (R-1) Max Front Tire

18.4-30 (R-1W) Max Rear Tire

Mainframe: Dual Wing (5" Offset Left & Right) 02981078
Comp Crate: Dual Wing w/Aux Pump02981009
Comp Crate: Dual Wing w/Tractor Hyd02981087
Replacement Fuel Tank (46 gal/Req'd for Dual) 02980938

SPECIAL ORDER: For tractors with oversized tires (Ref: 14.9-24 Frt / 18.4-34 Rear)

Dealer/customer responsible for modifying the exhaust for transport clearance.

Mainframe: Right Hand Only (5" Offset Right) 02981085

Comp Crate: RH Only w/Aux Pump **Unreleased (As of this date)**

Mainframe: Dual Wing (5" Offset Left & Right) 02981086

Comp Crate: Dual Wing w/Aux Pump **Unreleased (As of this date)**

Replacement Fuel Tank (46 gal/Req'd for Dual) 02980938

Options:

Lift Chain Kit (See Spec Below) 02980514

Specifications:

1. These mount kits include exhaust modification kit #02980916 which allows the vertical A-post style exhaust to be moved in approximately 6 1/2" for head transport clearance. In addition, a portion of the tractor's exhaust mounting bracket must be cut away to allow clearance for the path of the head lock-up lug. Notice: The "special order" kits will not include a replacement exhaust. The dealer/customer will be responsible for modifying the tractor's original exhaust at their own expense.
2. As a result of the cylinder mount position on the right side, the battery support will no longer completely hinge outward. However, the battery can still be accessed and even removed with the assistance of one additional person. Notice: The "special order" kits will include a battery relocation bracket (See Figure 1), however it was designed for use with 18.4-30 rear tires only. Hence, the dealer/customer is responsible for any necessary modifications.
3. For dual wing mowers, the factory installed fuel tank must be replaced with the one listed above to permit clearance for the cylinder mount (See Figure 2).
4. Full Interstater must be ordered with a 96" centered rear head. Right hand only models can be ordered with a 96" centered or 88" offset right 8.5" rear head. Two lift chains are recommended for centered heads, while offset heads should only be ordered with one.
5. The mainframe should allow approximately 10 3/4" of ground clearance with the maximum tire size listed above.
6. As with most dual wing Interstater, the left wing must be lowered for ingress/egress to the tractor platform.
7. For dual wing models, the left hand tractor steps must be removed. A replacement step is provided with the fuel tank kit. For dual and single wing models, the right hand steps must be removed for clearance as well. Ingress/egress on the right is otherwise blocked by the control stand.
8. The pump mount in this kit is assembled with a carrier bearing to extend the life of the driveline and pulley weldment.
9. Rear tires dimensionally larger than 18.4-30 may interfere with the replacement fuel tank and/or revised battery box position. Adjusting the rear wheels to a "full spread" may resolve such issues, however this has not been properly reviewed by our engineering team at this time.

Tractor / Mower Mounting Specifications

Continued From Previous Page

10. The driveline for these models was designed on a TS115A. Because the TS125A & 135A are equipped with a different crankshaft pulley, some modification to the length may be necessary. However, the pulley adapter should fit all models without any problem. Keep in mind that until a TS125A or 135A is mounted at our Seguin facility, any necessary driveline modifications must be made at the dealer/customer's expense.
11. The dual wing component crate for tractor hydraulics includes hoses and fittings for coupling to the rear tractor hydraulic remotes. Note, the tractor must be equipped with four remotes.

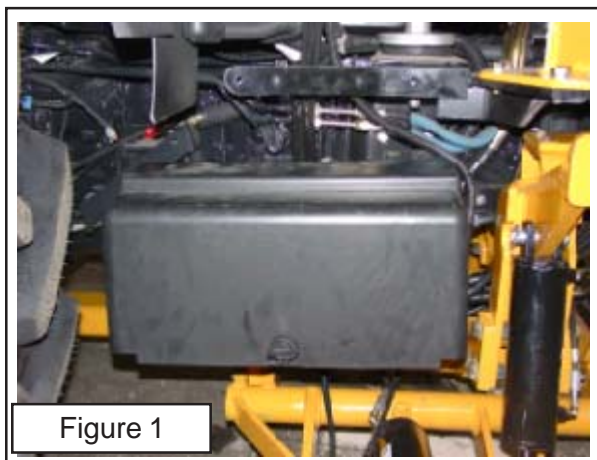

Figure 1
Battery Relocation

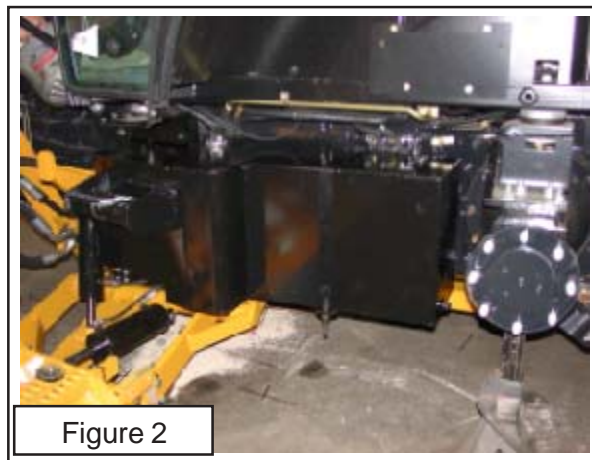

Figure 2
Changed Fuel Tank

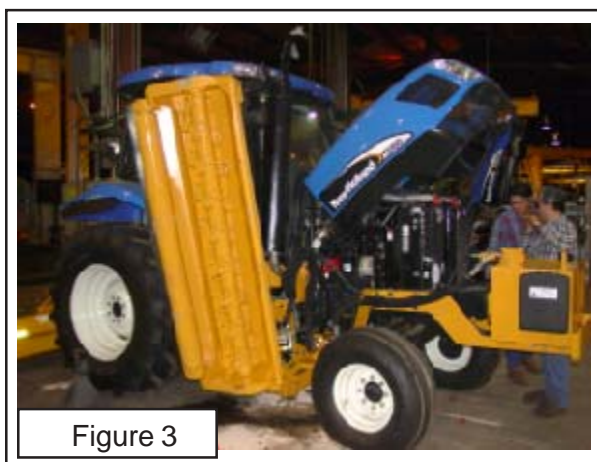

Figure 3
RH Wing (UP)



Figure 4
LH Wing (DOWN)

NOTES



**Interstater Assembly Manual
New Holland
TS-100A,115A, 125A & 135A
2004 Edition
P/N 02981188**

Interstater (NH TS-100A ,115A, 125A & 135A Asy. Manual) 06/04

© 2004 Alamo Group Inc.

Free Manuals Download Website

<http://myh66.com>

<http://usermanuals.us>

<http://www.somanuals.com>

<http://www.4manuals.cc>

<http://www.manual-lib.com>

<http://www.404manual.com>

<http://www.luxmanual.com>

<http://aubethermostatmanual.com>

Golf course search by state

<http://golfingnear.com>

Email search by domain

<http://emailbydomain.com>

Auto manuals search

<http://auto.somanuals.com>

TV manuals search

<http://tv.somanuals.com>