

Aleratec[®]

www.aleratec.com

The Prosumers' Choice

USER GUIDE

Aleratec DVD/CD Flash Copy Tower™



Part No. 310108

Copyright/Model Identification

The content of this manual is for informational purposes only and is subject to change without notice.

This manual is copyright with all rights reserved. Under copyright laws, this manual and the software described within may not be copied, except in the normal use of the product(s) described within or to make a backup copy.

Copyright© 2013
Aleratec, Inc.
9851 Owensmouth Avenue
Chatsworth, CA 91311 U.S.A.

Aleratec® is a registered trademark, and DVD/CD Flash Copy Tower™ is a trademark of Aleratec, Inc

Check out Aleratec Online!

- Blog.Aleratec.com
- Facebook.com/Aleratec
- Twitter.com/Aleratec
- YouTube.com/Aleratec

Please record the following information to help expedite any warranty claim:

Model No. _____ Serial No. _____

Date Purchased _____

Place of Purchase _____

Radio/TV Interference Statement

The equipment described in this guide emits radio frequency energy. If it is not installed in accordance with the manufacturer's instructions, it may cause interference with radio or television reception.

This equipment has been tested and found to comply with the limits for a Class B digital device, pursuant to Part 15 of the FCC Rules. These limits are designed to provide reasonable protection against harmful interference in a residential installation.

This equipment generates, uses, and can radiate radio frequency energy. If not installed and used in accordance with the instruction manual, this equipment may cause harmful interference to radio communications. However, there is no guarantee that interference will not occur in a particular installation. If this equipment does cause harmful interference to radio or television reception, which can be verified by turning the equipment off and on, the user is encouraged to try to correct the interference by one or more of the following measures:

- Reorient or relocate the receiving antenna.
- Increase the separation between the equipment and the receiver.
- Connect the equipment to an electrical outlet on a circuit that is different from the circuit to which the receiver is connected.
- Consult your dealer or an experienced radio/TV technician for help.

This equipment has been certified to comply with the limits for a Class B computing device, pursuant to FCC Rules. In order to maintain compliance with FCC regulations, shielded cables must be used with this equipment. Operation with non-approved equipment or unshielded cables is likely to result in interference to radio and TV reception. The user is cautioned that changes and/or modifications made to this equipment, without the approval of manufacturer, could void the user's authority to operate this equipment.

Safety Regulations

WARNING

To prevent fire or shock hazard, do not expose the unit to rain or moisture.

To avoid electrical shock, do not open the cabinet. Refer servicing to authorized personnel only.

Make sure that the manually switchable power supply is set to the proper voltage for your region.

CAUTION

As the laser beam in these DVD/CD Flash Copy Tower is harmful to the eyes, do not attempt to disassemble the cabinet. Refer servicing to authorized personnel only.

The use of optical instruments with this product will increase eye hazard.

This DVD/CD Duplicator is classified as a CLASS 1 LASER PRODUCT.

The CLASS 1 LASER PRODUCT label is located on top of the internal drive enclosure.

CLASS 1
LASER PRODUCT

LASER KLASSE 1
PRODUKT

Table of Contents

Introduction.....	1
Product Features.....	1
Key Items.....	2
DVD/CD Flash Copy Tower: Display Panel and Buttons.....	2
Function List.....	3
Precautions.....	5
Installation.....	5
Operation.....	5
Transportation.....	5
Overview.....	6
Main Menu.....	6
Subfunctions.....	7
Using the DVD/CD Flash Copy Tower.....	10
Checking the Device Information.....	10
Disc Spanning.....	12
Multi-Session Backup.....	13
Function Overview: 1. Copy.....	14
Function Overview: 2. Compare.....	17
Function Overview: 3. Information.....	20
Function Overview: 4. Utility.....	22
Function Overview: 5. Setup.....	23
Specifications.....	25
Technical Support Addresses and Phone Numbers.....	26
Service and Support.....	27
Technical Support FAX Back Form.....	30



Aleratec[®]
www.aleratec.com
The Prosumers' Choice

www.aleratec.com

Introduction

Thank you for purchasing the Aleratec DVD/CD Flash Copy Tower. Please read this User Guide thoroughly before using this product.

Product Features

The DVD/CD Flash Copy Tower is a Memory Card/USB flash drive to disc copier. No PC needed, no limitation of Memory Card size, just a very simple key button, you can easily backup from Memory Cards or USB flash drive to DVD or CD disc.

DVD/CD Flash Copy Tower can do both multi-session backup and disc spanning. Multi-session allows you to copy several Memory Cards or USB flash drives to one DVD or CD disc. Disc spanning can split backup a big content size Memory Card to several discs. In addition, the DVD/CD Flash Copy Tower can also support disc to disc copying.

- Memory Card or USB flash drive copy backup to DVD/CD disc.
 - Multisession Technology: Allows all different types of Memory Cards to backup to one DVD/CD disc.
 - Disc Spanning Technology: A big capacity Memory Cards can copy to several DVD/CD discs.
- DVD/CD to DVD/CD disc duplicator.
- No PC needed.

Introduction

Key Items

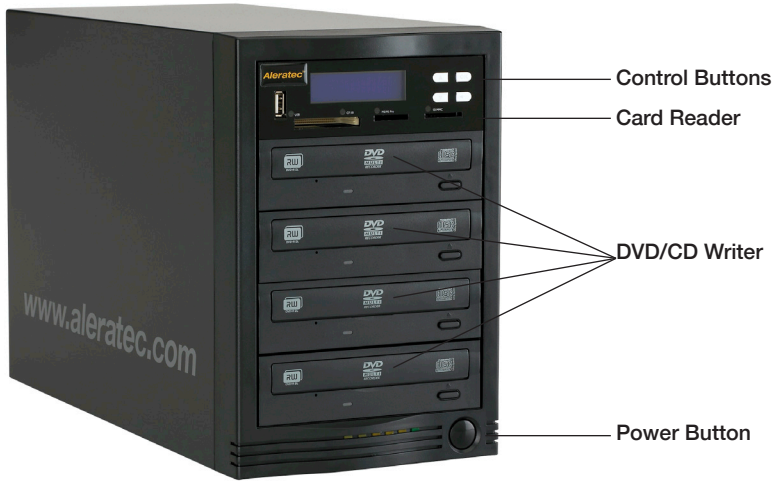

Note: Choose a Good Location

1. Allow adequate clearance for moving parts.
2. Do not place near heat sources such as radiators or air ducts, or in a place subject to direct sunlight, excessive dust, mechanical vibration or shock.
3. Good care will help assure maximum product life. Improper operating environment and misuse may void the warranty.

DVD/CD Flash Copy Tower: Display Panel and Buttons

(View may vary from picture)

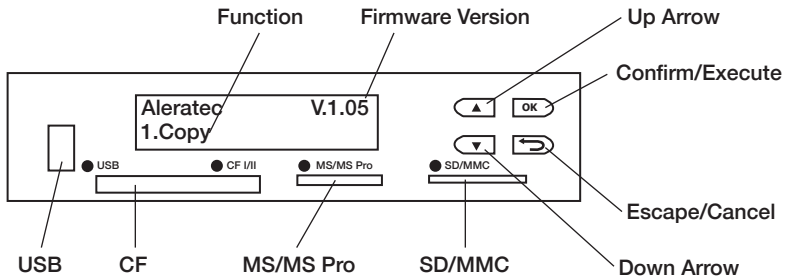

Introduction

Function List

Function	Sub-function	Description
1. Copy	1.1 Memory Card to Disc	Copy one Memory Card to DVD/CD disc
	1.2 USB to Disc	Copy USB flash drive to DVD/CD disc
	1.3 Disc to Disc	DVD to DVD copy CD to CD copy
2. Compare	2.1 Memory Card to Disc	Bit by bit compare between copied disc and Memory Card
	2.2 USB to Disc	Bit by bit compare between USB flash drive and copied disc
	2.3 Disc to Disc	Bit by bit compare between source disc and copied disc
3. Information	3.1 USB Info	Check USB flash drive's content size information
	3.2 Memory Card Info	Check Memory Card's content size information
	3.3 Disc Info	Check disc's content size information
	3.4 Drive Info	Check DVD/CD drives manufacturer and model information
	3.5 System Info	Check the machine's firmware and model information
4. Utility	4.1 System Update	Can upgrade system firmware via USB flash drive or disc
	4.2 Demo I/O	Simulates operation by ejecting and retracting drive doors
5. Set Up	5.1 Copy+Compare	According to your request select "enable" or "disable"
	5.2 Multi-session	According to your request select "enable" or "disable" multi-session function
	5.3 Disc Spanning	According to your request select "enable" or "disable" disc spanning function
	5.4 Burn Multidisc	Set the duplication from one flash media to multiple blank discs
	5.5 Burn Speed	Set the burning speed of DVD/CD writing
	5.6 Beep Sound	Set "ON" or "Off" of the beep sound function
	5.7 Advance Setup	Set disc space that will not be used and back light time

Introduction

Note: Flash media (Memory Card and USB) will be recognized by the DVD/CD Flash Copy Tower only when the format is FAT 12, 16, or 32.

Note: Use only one source at a time. ONLY ONE Memory Card or ONLY ONE USB flash drive may be plugged in at a time.



Note: When the system is in process, do not pull out the card.

Note: CD will copy only to CD. DVD will only copy to DVD.

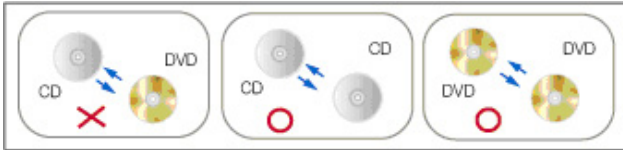

Precautions

Before installing your DVD/CD Flash Copy Tower, please read the following.

Installation

Avoid placing the DVD/CD Flash Copy Tower in a location subject to:

- High humidity
- High temperature
- Excessive dust
- Mechanical vibration
- Direct sunlight
- Electromagnetic radiation

Power

This product has a manually switchable power supply. Make sure that the power supply is set to the proper voltage for your region.

Operation

Do not move the DVD/CD Flash Copy Tower during operation. This may cause it to malfunction during operations.

Avoid exposing the unit to sudden changes in temperature as condensation may form inside the DVD/CD Flash Copy Tower. Should the surrounding temperature suddenly rise while the DVD/CD Flash Copy Tower is on, wait at least one hour before turning off the power. Operating the duplicator immediately after a sudden increase in temperature may result in a malfunction during playback or writing operations.

Transportation

Keep the original packing materials for future moving or shipping of the DVD/CD Flash Copy Tower.

Overview

Main Menu

There are 5 main menu items that will display in the DVD/CD Flash Copy Tower Display Panel. These are:

1. **1. Copy**

2. **2. Compare**

3. **3. Information**

4. **4. Utility**

5. **5. Set Up**

Overview

Subfunctions

The main menu “Copy” function has 3 subfunctions. These are:

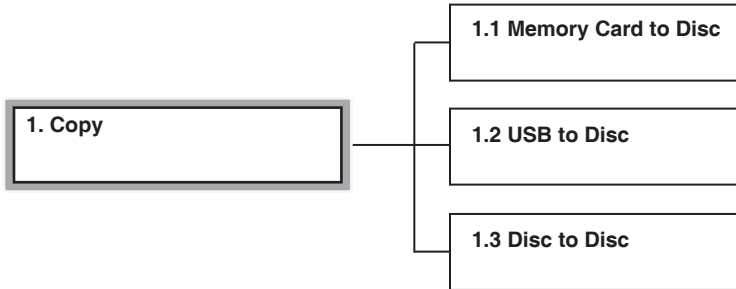

The main menu “Compare” function has 3 subfunctions. These are:

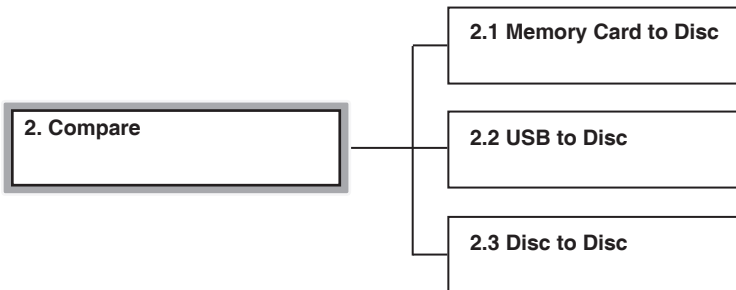

Overview

Subfunctions - *continued*

The main menu “Information” function has 5 subfunctions. These are:

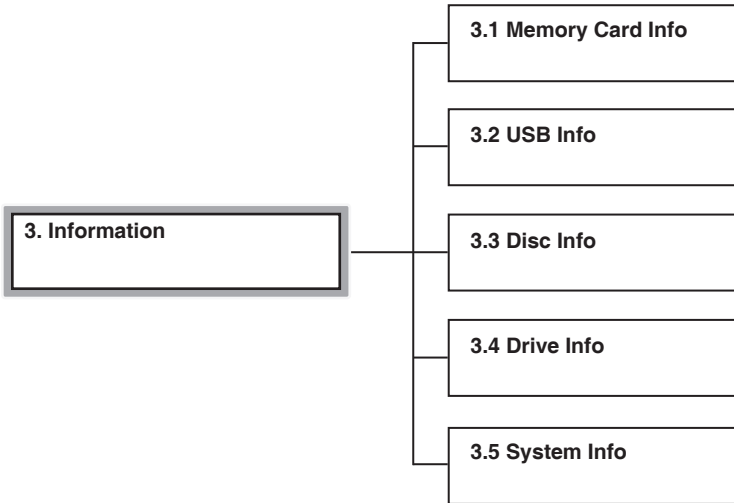

The main menu “Utility” function has 2 subfunction. These are:

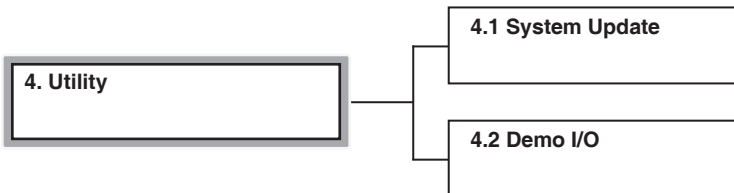

Overview

The main menu “Set Up” function has 7 subfunctions. These are:

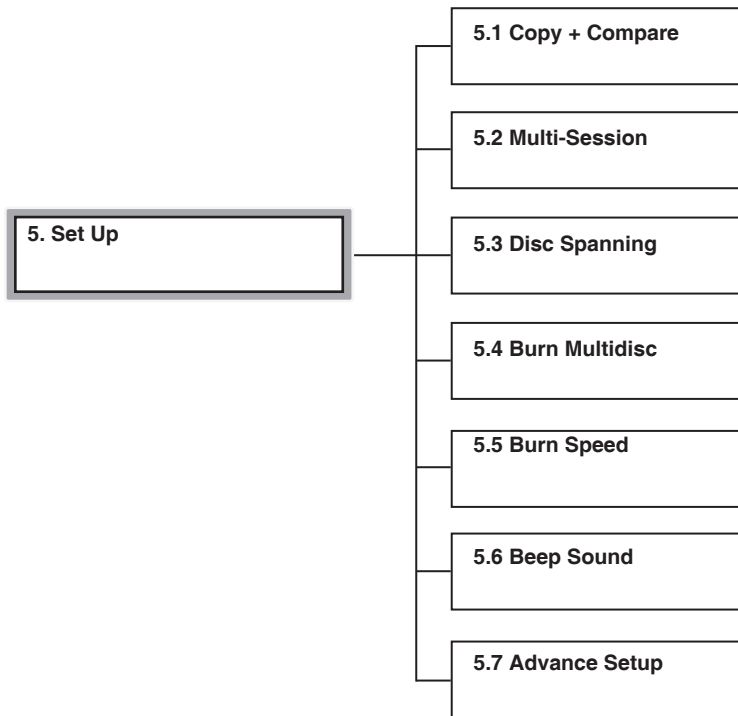

Using the DVD/CD Flash Copy Tower

Checking the Device Information

Before copying, it is recommended that you check each Memory Card, USB, or DVD/CD's content information.

Checking Memory Card Information

1. Select **3. Information**, → Select **1. M-Card info** → Press **OK** → The DVD/CD Flash Copy Tower will show the information of this Memory Card.

SD	3838MB
	Used: 1438MB

Press "ESC" or "OK" to continue to calculate file quantity.

Total File Q'ty:
64

Checking USB Information

1. Select **3. Information**, → Select **2. USB info** → Press **OK** → The DVD/CD Flash Copy Tower will show the information of this USB flash drive.

USB	7.0GB
	Used: 5.0GB

Press "ESC" or "OK" to continue to calculate file quantity.

Total File Q'ty:
4329

Using the DVD/CD Flash Copy Tower

Checking Disc Information

1. Select **3. Information**, → Select **3. Disc info** → Press **OK** → The DVD/CD Flash Copy Tower will show the information of this Disc.

Disc Spanning Disc Information: If the disc was copied from Disc Spanning you will see the disc sequence.

[2] Disc 2/4	Sequence of disc/total disc copied
Disc	512MB
	Disc content size

Multi-session Disc Information: You will see the content size and the remaining free space of the disc.

[1]	2 Session
Disc	1818M

[1]	Free Space
Disc	2674M

Using the DVD/CD Flash Copy Tower

Disc Spanning

To use Disc Spanning go to Setup and enable Disc Spanning. When you want to copy a Memory Card which has a content size bigger than a disc, the DVD/CD Flash Copy Tower will automatically estimate the number of blank discs required for the job and execute Disc Spanning. **When the file size is very close to the writable space on the blank discs, the DVD/CD Flash Copy Tower may under estimate the number of discs needed. If this happens you can add an extra disc before you start or when the DVD/CD Flash Copy Tower displays “Waiting Disc”.** For example, when you copy an SD Card with over 2GB content size to CDs, you place a CD into the burner, and the DVD/CD Flash Copy Tower will calculate total number of discs to back up this SD Card (4 discs for this example, see Setup → Advanced Setup → DVD/CD/Spare Size on page 24 of this User Guide for setting writable space on DVD/CD). If you place a DVD (4.7G) to copy, the DVD/CD Flash Copy Tower will start copying without requiring additional discs.

Using Disc Spanning

1. Plug a Memory Card (ex. SD) and place a blank DVD or CD disc into the burner.
2. Select **1. Copy**, → Select **1. M-Card to Disc** → Press **OK** → The DVD/CD Flash Copy Tower will begin copying.



Example: A total of 4 CD-R discs are required to complete this project

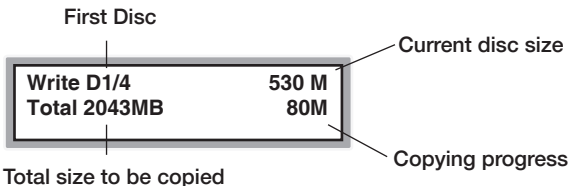

When a disc is finished copying, it will be ejected. If the Disc Spanning process is not complete, the DVD/CD Flash Copy Tower will prompt you for a new blank disc to continue the copying.

Note: The DVD/CD Flash Copy Tower can not use Disc Spanning for a Memory Card that has a single file whose content size is bigger than a disc size.

Using the DVD/CD Flash Copy Tower

Note: Keep disc type consistent when using Disc Spanning. For example, if you place a CD-R as the first disc for copying, do not place a DVD-R or DVD+R to continue copying. The DVD/CD Flash Copy Tower will show an error message and ask for another blank CD-R.

Note: Disc Spanning will automatically detect the next blank disc and eject the completed first disc.

Multi-Session Backup

The DVD/CD Flash Copy Tower can combine several small size Memory Cards and USB flash drives together into a disc. For example, you can put an SD Card, Memory stick, Memory stick pro, USB, MP3(USB), and handy drives, etc. with total content size smaller than a CD disc size (see Setup → Advanced Setup → DVD/CD Spare Size on page 24 of this User Guide for setting writable space on DVD/CD) together. The DVD/CD Flash Copy Tower will execute close session after every copying session, and keep this disc open for next time copying as long as the disc's remaining size is enough.

1. Insert a Memory Card (e.g. USB flash drive) and place a DVD or CD into the burner.
2. Select **1. Copy**, → Select **1. USB to Disc** → Press **OK** → The DVD/CD Flash Copy Tower will begin copying.

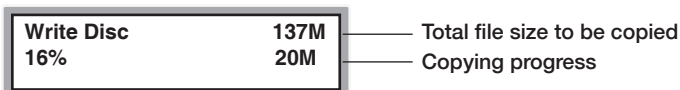
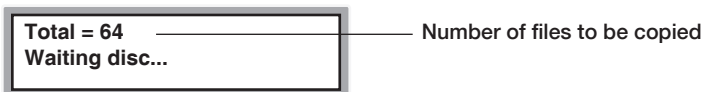

3. When finished, the disc tray will eject, and you can continue to copy another Memory Card or USB, or you can take out the disc and keep it for other copying sessions.

Note: Multi-Session Backup does not support disc spanning.

Note: The DVD/CD Flash Copy Tower can use blank disc to start Multi-Session function; if the disc has data inside, the DVD/CD Flash Copy Tower can't execute Multi-Session function. Therefore, if you like to use CD-RW or DVD RW to backup, please make sure you have erased the original data of the disc.

Using the DVD/CD Flash Copy Tower

Function Overview: 1. Copy

Memory Card to Disc

1. Insert a Memory Card (e.g., SD, MS) and place a blank DVD or CD disc into the burner.
2. Select **1. Copy**, → Select **1. M-Card to Disc** → Press **OK** → The DVD/CD Flash Copy Tower will begin copying.

The DVD/CD Flash Copy Tower will detect the card and decide whether Multisession or Disc Spanning copying will be used.

Disc Spanning Copying

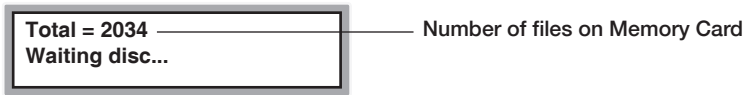

Example: A total of 4 CD-R discs are required to complete this project

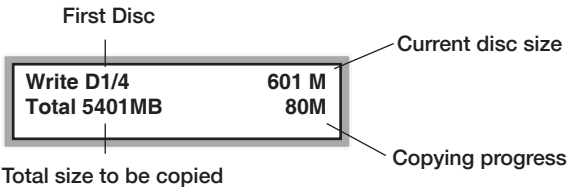

When a disc is finished copying, it will be ejected. If the Disc Spanning process is not complete, the DVD/CD Flash Copy Tower will prompt you for a new blank disc to continue the copying.

Multisession Copying

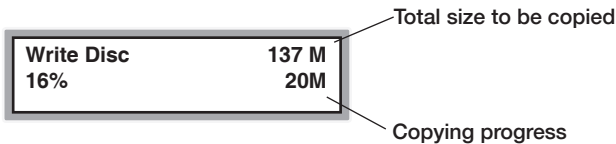
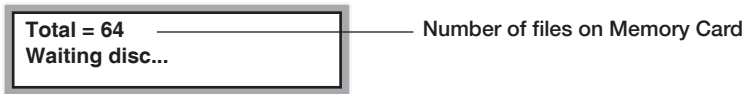

When finished copying, the disc will be ejected, and you can continue to copy another Memory Card.

Using the DVD/CD Flash Copy Tower

USB to Disc

1. Insert a USB flash drive and place a blank DVD or CD disc into the burner.
2. Select **1. Copy**, → Select **2. USB to Disc** → Press **OK** → The DVD/CD Flash Copy Tower will begin copying.

The DVD/CD Flash Copy Tower will detect the USB flash drive and decide whether Multisession or Disc Spanning copying will be used.

Disc Spanning Copying



Example: A total of 4 CD-R discs are required to complete this project

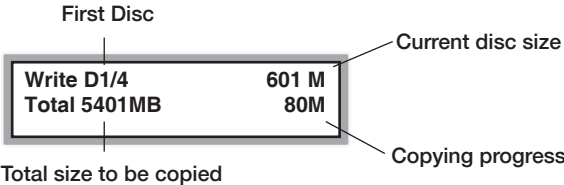

When a disc is finished copying, it will be ejected. If the Disc Spanning process is not complete, the DVD/CD Flash Copy Tower will prompt you for a new blank disc to continue the copying.

Multisession Copying

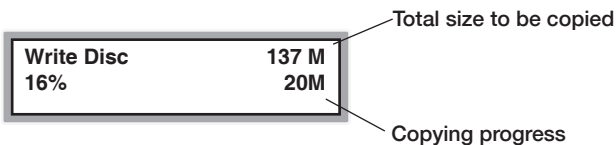

When finished copying, the disc will be ejected, and you can continue to copy another Memory Card, or USB flash drive.

Using the DVD/CD Flash Copy Tower

Disc to Disc

This function allows you to copy DVD to DVD(s) and CD to CD(s).

Note: CD will copy only to CD. DVD will only copy to DVD.

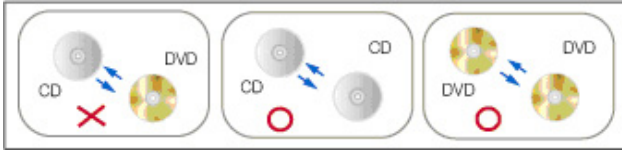

1. Place your source disc into a Reader, and blank discs into Writers.
2. Select **1. Copy**, → Select **3. Disc to Disc copy** → Press **OK** → The DVD/CD Flash Copy Tower will begin copying.

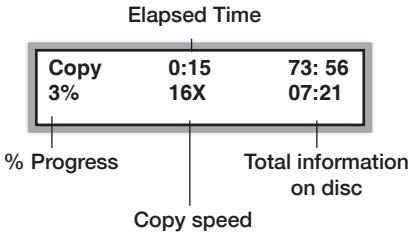

Copy	Result
PASS 1	FAIL 0

Results

3. When copying is completed, the copied disc will be ejected.

Using the DVD/CD Flash Copy Tower

Function Overview: 2. Compare

When “Copy” is completed, the “Compare” function allows you to preform a bit-by-bit comparison of the source media to the completed disc copy.

Memory Card to Disc Compare

1. Insert a Memory Card (e.g. SD, MS) and place a completed written DVD or CD disc into the DVD/CD Flash Copy Tower.
2. Select **2. Compare**, → Select **1. M-Card to Disc** → Press **OK** → The DVD/CD Flash Copy Tower will begin comparison.

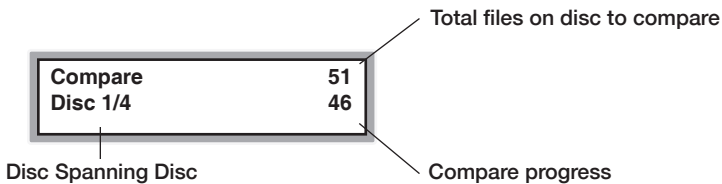

(or)

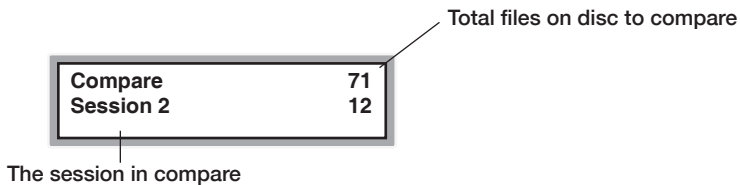

3. When the Memory Card to Disc comparison is complete the following information will be displayed:

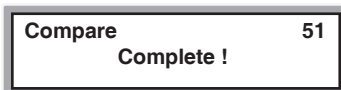

Using the DVD/CD Flash Copy Tower

USB to Disc Compare

1. Insert a USB flash drive and place a finish burner DVD or CD disc into the DVD/CD Flash Copy Tower.
2. Select **2. Compare**, → Select **2. USB to Disc** → Press **OK** → The DVD/CD Flash Copy Tower will begin comparison.



Begins the Compare process

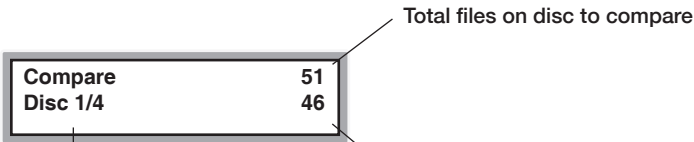

Total files on disc to compare

Disc Spanning Disc

Compare progress

(or)

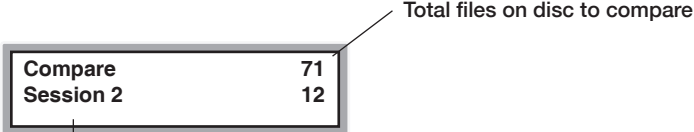

Total files on disc to compare

Multi-Session

3. When the USB to Disc comparison is complete the following information will be displayed:



Using the DVD/CD Flash Copy Tower

Disc to Disc Compare

1. Place the source disc and copied disc into the Reader and Writers.
2. Select **2. Compare**, → Select **3. Disc to Disc** → Press **OK** → The DVD/CD Flash Copy Tower will begin comparison.

Actual comparison time

Compare	0:40	73:56	Total time required to complete comparison
19%	0.0X	17:22	

% "Compare" completed

3. When the Disc to Disc comparison is complete the following information will be displayed:

Compare Result	
Pass 1	Fail 0

Note: The DVD/CD Flash Copy Tower "Compare" function is to do file by file comparison. Therefore, Copy and Compare speeds will be affected by some factors such as the number of files, and the disc reading speed.

Using the DVD/CD Flash Copy Tower

Function Overview: 3. Information

Memory Card Information

1. Insert a Memory Card into the DVD/CD Flash Copy Tower.
2. Select **3. Information**, → Select **1. M-Card info** → Press **OK** → The DVD/CD Flash Copy Tower will show the information of this Memory Card.

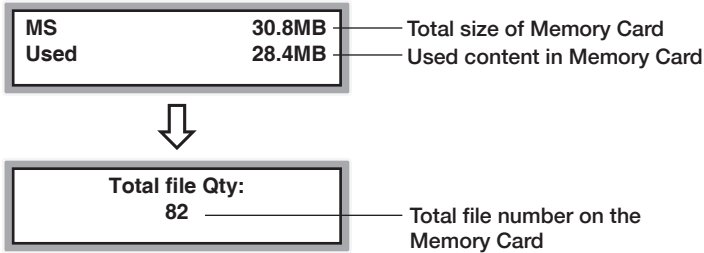

USB Information

1. Insert a USB flash drive into the DVD/CD Flash Copy Tower.
2. Select **3. Information**, → Select **2. USB info** → Press **OK** → The DVD/CD Flash Copy Tower will show the information of this USB flash drive.

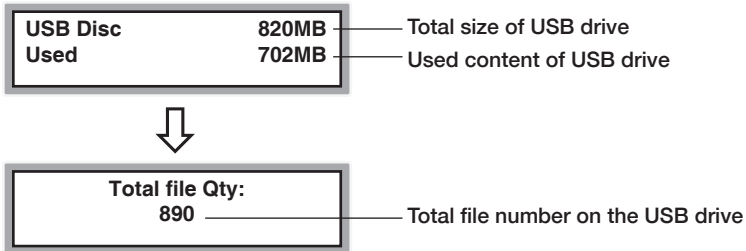

Using the DVD/CD Flash Copy Tower

Disc Information

1. Insert a disc into the DVD/CD Flash Copy Tower.
2. Select **3. Information**, → Select **3. Disc info** → Press **OK** → The DVD/CD Flash Copy Tower will show the information of this Disc.

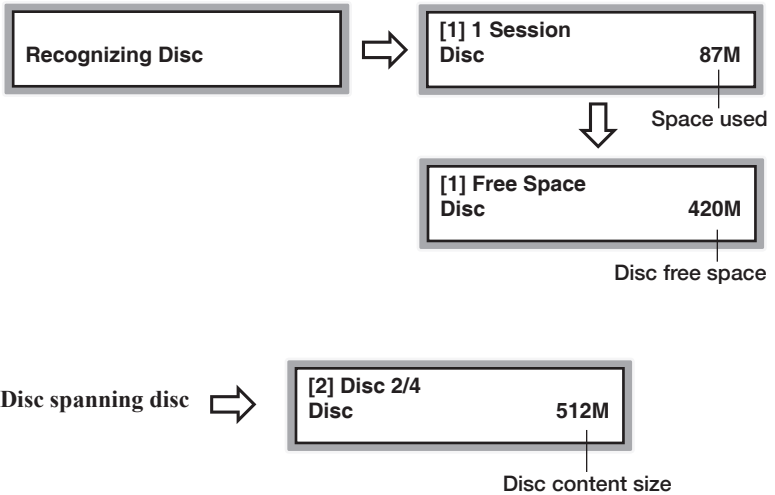

Drive Information

1. Select **3. Information**, → Select **4. Drive info** → Press **OK** → This will show the information of the DVD burner.

Connecting port #

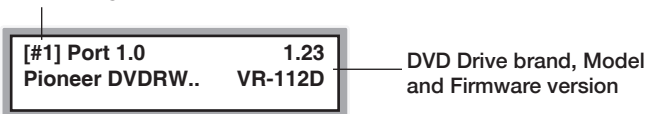

System Information

1. Select **3. Information**, → Select **5. System info** → Press **OK** → This will show the information of this DVD/CD Flash Copy Tower version.

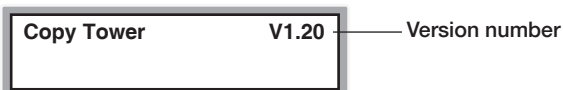

Using the DVD/CD Flash Copy Tower

Function Overview: 4. Utility

System Update

The DVD/CD Flash Copy Tower can use a USB flash drive to update the system firmware.

1. Download / Copy the updated System Firmware to a USB flash drive.
2. Select **4. Utility** → **1. System Update** → Press **OK** → The system will start updating the firmware. When finished, the LCD screen will prompt you to turn off and turn on the system again.

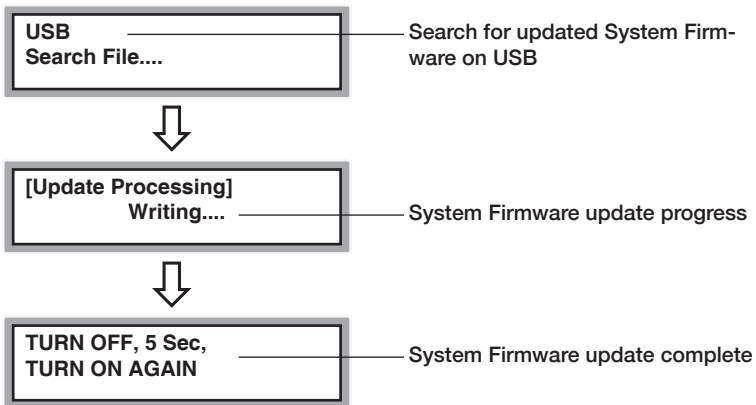

Note: Save the System Firmware update to a USB flash drive. Do not put the System Firmware update in a folder; the system will not be able to find the file in a folder.

Demo I/O

This function simulates operation by mechanically ejecting and retracting drive doors.

1. Select **4. Utility** → **2. Demo I/O** → Press **OK**

Using the DVD/CD Flash Copy Tower

Function Overview: 5. Setup

Copy+Compare

1. You can change the COPY function in the main menu to COPY+COMPARE by enabling this function.
2. Select **5. Setup** → Select **41. Copy+Compare** → Select **Enable** → Press **OK** → Copy mode will now be changed to Copy+Compare.

Note: When Copy+Compare is enabled the finished disc will be ejected. Do not remove the disc from the tray. The tray will automatically close again in 2-3 seconds and begin the compare function.

Multi-Session

This function is to enable or disable Multi-Session function.

Disc Spanning

This function is to enable or disable Disc Spanning function.

Burn Multidisc

This function will copy USB flash drive contents or Memory Card contents to multiple discs loaded in the recorders (as long as the content on the source is the same capacity or less than the capacity of the blank target discs).

Burn Speed

You can use this function to set up the burner speed of your DVD/CD Flash Copy Tower. There are 9 options to choose from. These include: DVD/CD to DVD/CD, Memory Card to DVD/CD and USB to DVD/CD.

Beep Sound

This function enables or disables the sound associated with pushing any of the DVD/CD Flash Copy Tower buttons. The default setting is “On”.

Using the DVD/CD Flash Copy Tower

Advanced Setup

DVD/CD Spare Size (Blu-ray not supported)

Because the outside area of each DVD, CD is more difficult to write data to, you can use this function to set a spare area size on each DVD, CD. This spare area size will not be written to.

Backlight Time

This function is used to set the time the LCD screen will enter a screen saving mode.

Language

This function is used to set the language of the DVD/CD Flash Copy Tower.

Factory Default

This function returns the DVD/CD Flash Copy Tower back to its original default settings.

Specifications

Model	DVD/CD Flash Copy Tower
Operation	Stand Alone
Function	<ul style="list-style-type: none"> • DVD copy to DVD • CD copy to CD • Memory Card copy to DVD/CD disc • USB flash drive copy to DVD/CD disc • Data comparison of backup
Memory Card or USB Backup to Disc Technology	<ul style="list-style-type: none"> • Multi-session • Disc Spanning • Multidisc copy
Memory Card Compatibility	CompactFlash™, MemoryStick/Pro/Duo, SD™ Card, MiniSD, MicroSD
USB Flash Drive Support	USB 1.1 / 2.0 USB Flash Devices
DVD/CD Disc Read Support Format	DVD-ROM, DVD-Video, DVD-Audio, DVD+R, DVD+RW, DVD-R, DVD-RW, Dual Layer DVD+R, CD-ROM, Audio CD, Video CD, MixedMode CD, Multi-session CD, 3" MiniCD-R
DVD/CD Disc Write Support Format	DVD+R, DVD-R, DVD+RW, DVD-RW, Dual Layer DVD+R, 3" MiniCD-R
Memory Card file format	FAT12, FAT16, FAT32
Buzzer	Yes
Display	Monochrome LCD
Power	<ul style="list-style-type: none"> • Voltage: 115-230V • Current: 50-60Hz Switchable
Control Button	Forward, Backward, Escape, and OK
LED	LED for each Memory Card or USB device when device is detected
Humidity	<ul style="list-style-type: none"> • Operating: 20% ~ 80% • Non Operating: 15% ~ 95%
Environment Temperature	<ul style="list-style-type: none"> • Operating: 5°C to 50°C • Non Operating: -20°C to 65°C
Safety	RoHS
Dimensions	267mm x 178mm x 394mm (height x width x deep)
Weight	10.0 kg

Note: The above table information is for reference only. Specifications subject to change without notice.

Technical Support

After reading this User Guide, if you need additional assistance with this product, please contact Aleratec Technical Support. Our technical staff will be happy to assist you, but they may need your help to better assist you. Calling Aleratec Technical Support without all the necessary information can be both time consuming and frustrating. Therefore, please try to have the following information ready before calling:

1. Part Number - the part number is located on the bottom of the DVD/CD Flash Copy Tower.
2. Serial Number - the serial number is located on the back of the DVD/CD Flash Copy Tower.
3. Troubles - your questions about the DVD/CD Flash Copy Tower. Please provide enough information about your problems so our technical staff can recreate and diagnose it.

Technical Support Addresses and Phone Numbers

► By e-mail: **support@aleratec.com**

► By Telephone: **1-818-678-0484** – Skype: **support.aleratec.com**

Technical Support Group can be reached 8:00 AM to 5:00 PM, Pacific Time, Monday through Friday, excluding U.S. holidays.

Please try to call from a phone near your computer system.

► Access is available 24 hours a day, 365 days a year, via:

The World Wide Web at: **www.aleratec.com**

FAX at: **1-818-678-0483**

Service and Support

Aleratec, Inc., Limited Warranty

This Limited Warranty covers defects encountered in the course of normal use of this product and does not apply to damage from improper use, abuse, accidents, unauthorized service, or inadequate packaging when shipping the product to Aleratec, Inc.

Aleratec, Inc. provides the following limited warranty for this product only if the product was originally purchased for use, not re-sale, from Aleratec, Inc., an Aleratec, Inc. authorized dealer or distributor, or any other Aleratec, Inc. approved reseller for this product. This product is warranted to be free from defects in workmanship and material for a period of one year from the date of your original purchase.

If the product fails during normal and proper use within the warranty period, Aleratec, Inc. will, at its option, repair or replace the product at no cost (except shipping and insurance). This limited warranty does not include service to repair damage from improper installation, accident, disaster, misuse, abuse, or modifications to the subsystem, or by any other causes unrelated to defective materials or workmanship.

Service and Support

Please Note:

This Warranty is valid only within the United States and Puerto Rico, and applies only to products that are new and unopened on the date of purchase. For areas outside the United States and Puerto Rico, contact the authorized dealer from whom you purchased this product to determine what dealer warranty, if any, applies.

THIS LIMITED WARRANTY CONSTITUTES YOUR SOLE AND EXCLUSIVE REMEDY, AND THE SOLE AND EXCLUSIVE LIABILITY OF ALERATEC, INC., AND IS IN LIEU OF ALL OTHER WARRANTIES, EXPRESS OR IMPLIED, INCLUDING, BUT NOT LIMITED TO ANY IMPLIED WARRANTY OF MERCHANTABILITY OR FITNESS OF ITEMS FOR A PARTICULAR PURPOSE.

Your sole remedy shall be repair or replacement, with new or refurbished components, as provided in this Limited Warranty. Aleratec, Inc. shall not be liable for any direct, indirect, special, incidental or consequential damages, including, but not limited to, any loss of data or loss of profits or business, regardless of the form of action or theory of liability resulting from any defect in, or use of, this product (even if Aleratec, Inc. has been advised of the possibility of such damages).

In any event, the liability of Aleratec, Inc. under this Limited Warranty, for damages to you or any third party, regardless of the form of action or theory of liability, shall not exceed the purchase price you paid for this product.

Some states do not allow limitations of the disclaimer of implied warranties, the period an implied warranty lasts, or the exclusion or limitation of incidental or consequential damages, so the exclusions and limitations stipulated in this Limited Warranty may not apply to you. This Limited Warranty gives you specific legal rights, and you may have other rights which vary from state to state.

Service and Support

To Obtain Warranty Service:

You must ship your product to the authorized dealer where your product was purchased within the one year warranty period and no later than thirty days after discovery of claimed defect, whichever occurs first. In either case, you must provide proof of original purchase before any warranty service can be performed. Products and parts provided as a result of warranty service may be other than new but will be in good working order and become your property at the time of exchange. At the same time, the exchanged products or parts become the property of Aleratec, Inc.

When shipping the product for service, you agree to insure the product, to prepay shipping charges, and to use the original shipping container or equivalent. Any service outside the scope of this limited warranty shall be at Aleratec, Inc.'s or its Authorized Service Provider's rates and terms then in effect.

This warranty gives you specific legal rights; you may also have other rights which vary from state to state.

Technical Support FAX Back Form

Aleratec, Inc. Technical Support Fax Back Form

Please record the following information to help expedite any warranty claim:

Model No.: _____ Serial No.: _____

Date Purchased _____

Place of Purchase: _____

To: Technical Support Group FAX: 1-818-678-0483

FROM: _____ FAX: _____

E-MAIL _____

RE: _____ TEL: _____

DATE: _____ # OF PAGES: _____

I am experiencing the following problems with my DVD/CD Flash Copy Tower:

By answering these questions, your problem will be solved more rapidly. Make copies as necessary. You can reach us electronically at: www.aleratec.com on the internet.

Notes:



Aleratec[®]
www.aleratec.com
The Prosumers' Choice

Document Number: 9399056_ENG_Rev. F
Specifications subject to change without notice.

Copyright © 2013

Aleratec, Inc.
9851 Owensmouth Avenue
Chatsworth, CA 91311 U.S.A.

www.aleratec.com

Free Manuals Download Website

<http://myh66.com>

<http://usermanuals.us>

<http://www.somanuals.com>

<http://www.4manuals.cc>

<http://www.manual-lib.com>

<http://www.404manual.com>

<http://www.luxmanual.com>

<http://aubethermostatmanual.com>

Golf course search by state

<http://golfingnear.com>

Email search by domain

<http://emailbydomain.com>

Auto manuals search

<http://auto.somanuals.com>

TV manuals search

<http://tv.somanuals.com>