

Aleratec[®]

www.aleratec.com

The Prosumers' Choice

USER GUIDE

**Aleratec
1:1 HDD Cruiser™**



Part No. 350103

Copyright/Model Identification

The content of this manual is for informational purposes only and is subject to change without notice.

This manual is copyright with all rights reserved. Under copyright laws, this manual and the software described within may not be copied, except in the normal use of the product(s) described within or to make a backup copy.

Copyright© 2010
Aleratec, Inc.
9851 Owensmouth Avenue
Chatsworth, CA 91311 U.S.A.

www.aleratec.com

Aleratec® is a registered trademark and 1:1 HDD Cruiser™ is a trademark of Aleratec, Inc.

Please record the following information to help expedite any warranty claim:

Model No. _____ Serial No. _____

Date Purchased _____

Place of Purchase _____

www.aleratec.com

Radio/TV Interference Statement

The equipment described in this guide emits radio frequency energy. If it is not installed in accordance with the manufacturer's instructions, it may cause interference with radio or television reception.

This equipment has been tested and found to comply with the limits for a Class B digital device, pursuant to Part 15 of the FCC Rules. These limits are designed to provide reasonable protection against harmful interference in a residential installation.

This equipment generates, uses, and can radiate radio frequency energy. If not installed and used in accordance with the instruction manual, this equipment may cause harmful interference to radio communications. However, there is no guarantee that interference will not occur in a particular installation. If this equipment does cause harmful interference to radio or television reception, which can be verified by turning the equipment off and on, the user is encouraged to try to correct the interference by one or more of the following measures:

- Reorient or relocate the receiving antenna.
- Increase the separation between the equipment and the receiver.
- Connect the equipment to an electrical outlet on a circuit that is different from the circuit to which the receiver is connected.
- Consult your dealer or an experienced radio/TV technician for help.

This equipment has been certified to comply with the limits for a Class B computing device, pursuant to FCC Rules. In order to maintain compliance with FCC regulations, shielded cables must be used with this equipment. Operation with non-approved equipment or unshielded cables is likely to result in interference to radio and TV reception. The user is cautioned that changes and/or modifications made to this equipment, without the approval of manufacturer, could void the user's authority to operate this equipment.

Safety Regulations

WARNING

To prevent fire or shock hazard, do not expose the unit to rain or moisture.

To avoid electrical shock, do not open the cabinet. Refer servicing to authorized personnel only.

Table of Contents

Introduction.....	1
Product Features.....	1
Key Items.....	2
1:1 HDD Cruiser Front Panel.....	3
1:1 HDD Cruiser Copy Controller Display Panel and Buttons.....	4
Precautions.....	5
Installation.....	5
Choose a Good Location.....	5
Operation.....	5
Transportation.....	5
Overview.....	6
Power Up Sequence.....	6
Main Menu.....	7
Subfunctions.....	8
Using the 1:1 HDD Cruiser.....	10
Loading the Hard Drives.....	10
Removing Hard Drives.....	11
Main Menu.....	12
Copy HDD.....	12
Compare HDD.....	14
PreScan Source.....	15
ReScan BUS.....	16
Source HDD Size.....	17
Secure Erase.....	18
Overwrite.....	20
Setup Menu.....	22
USB Mode.....	32
Advanced Setup Menu.....	34
Specifications.....	45
Troubleshooting.....	45
Technical Support.....	46
Service and Support.....	47
Technical Support FAX Back Form.....	50



Aleratec[®]
www.aleratec.com
The Prosumers' Choice

www.aleratec.com

Introduction

Thank you for purchasing the 1:1 HDD Cruiser. Please read this User Guide thoroughly before using this product.

Product Features

The 1:1 HDD Cruiser is a Hard Disk Drive Duplicator and Hard Disk Drive Sanitizer.

- Sanitizes/Wipes drives clean with the choice of three Overwrite patterns:
 - One Pass
 - Three Pass with Verify
 - Seven Pass per DoD 5220.22M
- Secure Erase
- Duplicates/Makes HDD copies
- Quick load drive bays
- Supports 3.5" SATA HDDs
Optional 2.5" SATA HDD Adapter available (Aleratec Part Number 350106)

Check out Aleratec Online!

- www.aleratec.com
- www.facebook.com/Aleratec
- www.twitter.com/Aleratec
- www.youtube.com/Aleratec

Introduction

Key Items

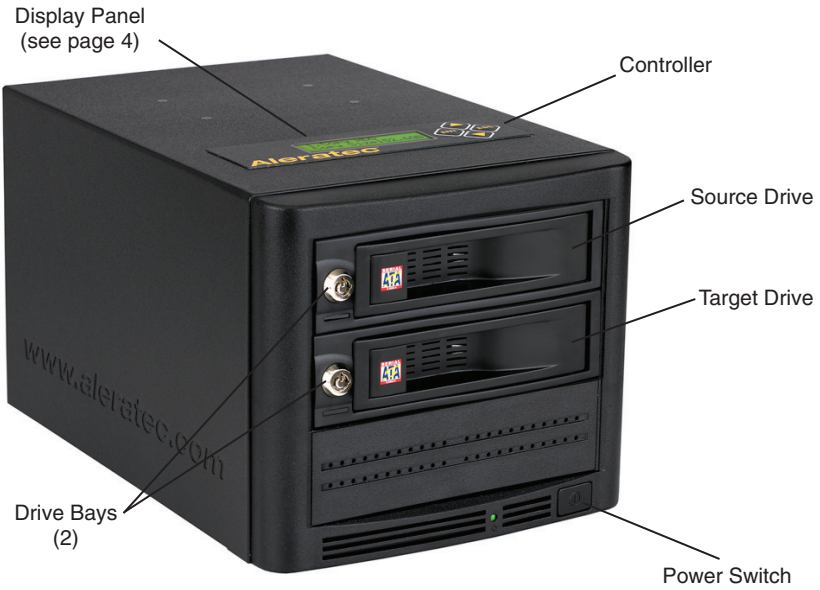

Introduction

1:1 HDD Cruiser Front Panel



1 Drive Bays

Drive bays with quick loading doors.

2 Drive Bay Door

The drive bay handle/tab is used to open the individual drive bays.

3 Drive LEDs

Each HDD bay has a blue power light that will be on when there is an HDD properly inserted in the drive bay.

Each HDD bay has an orange drive activity light that will light when the HDD is being used. Do not remove a drive when this light is on, otherwise you may loose your data.

Introduction

1:1 HDD Cruiser Copy Controller Display Panel and Buttons

(Actual display may vary from illustration)

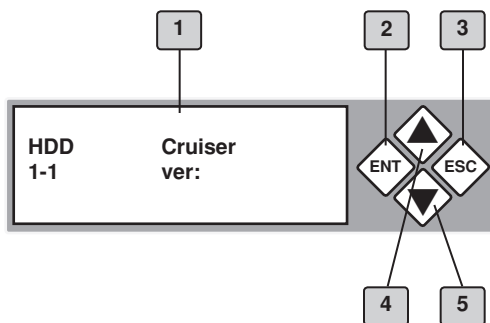

1. LCD display shows all functions and messages
2. **ENT** button is used to execute a selected function, or enter a menu
3. **ESC** button is used to cancel a selected function, or exit a menu
4. **UP** arrow is used to scroll backward through functions or menus
5. **DOWN** arrow is used to scroll forward through functions or menus

Precautions

Before installing your 1:1 HDD Cruiser, please read the following.

Installation

Avoid placing the 1:1 HDD Cruiser in a location subject to:

- High humidity
- High temperature
- Excessive dust
- Mechanical vibration
- Direct sunlight
- Electromagnetic radiation

Choose a Good Location

1. Allow adequate clearance for moving parts.
2. Do not place near heat sources such as radiators or air ducts, or in a place subject to direct sunlight, excessive dust, mechanical vibration or shock.
3. Disconnect the AC adapter from the outlet if the product is not used for an extended period of time.
4. Proper care will help assure maximum product life. Improper operating environment and misuse may void the warranty.

Operation

Do not move the 1:1 HDD Cruiser during operation. This may cause a malfunction or other undesirable results.

Avoid exposing the unit to sudden changes in temperature as condensation may form inside the 1:1 HDD Cruiser. Should the surrounding temperature suddenly rise while the 1:1 HDD Cruiser is on, wait at least one hour before turning off the power. Operating the duplicator immediately after a sudden increase in temperature may result in a malfunction.

Transportation

Keep the original packing materials for future moving or shipping of the 1:1 HDD Cruiser.

Overview

Power Up Sequence

During the normal power-up sequence of the 1:1 HDD Cruiser, the following information will be displayed.

- Figure 1 shows the firmware version

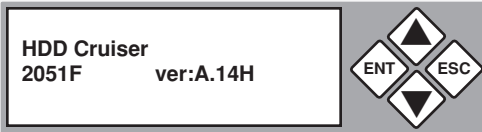

- Figure 2 shows the memory initialization



- Figure 3 shows the scanning of the drives



- Figure 4 shows the number of drives loaded.

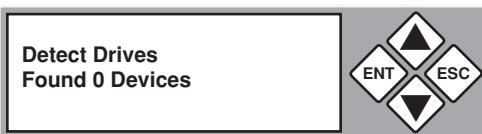











- Figure 5 shows the first function.



Overview

Main Menu

There are ten main menu items that can be seen in the 1:1 HDD Cruiser Copy Controller Display Panel. These are:

1. **1. Copy HDD** 
2. **2. Compare HDD** 
3. **3. PreScan Source** 
4. **4. ReScan Bus** 
5. **5. Source Size** 
6. **6. Secure Erase** 
7. **7. Overwrite** 
8. **8. Setup** 
9. **9. USB Mode** 
10. **10. Adv Setup** 

Note: The Advanced Setup function is a hidden menu. To access this menu, press **ESC** for 3 seconds. After you have completed any desired adjustments, press **ESC** to exit Advanced Setup.

Overview

Subfunctions

The “Setup” menu has nine (9) subfunctions. These are:

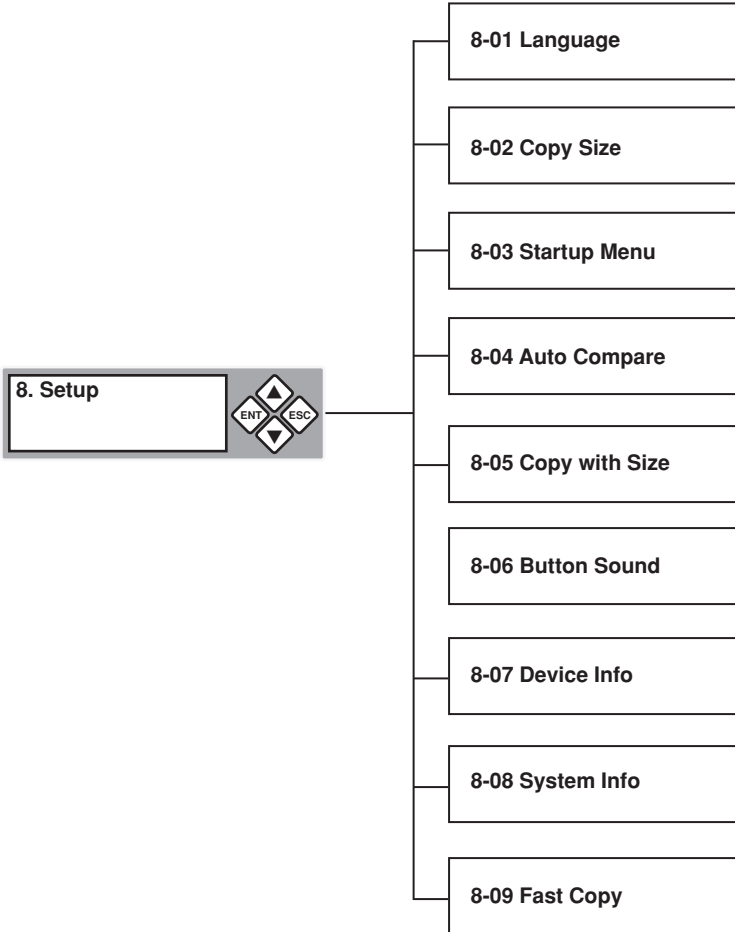

Overview

The “Advanced Setup” menu has ten (10) subfunctions. These are:

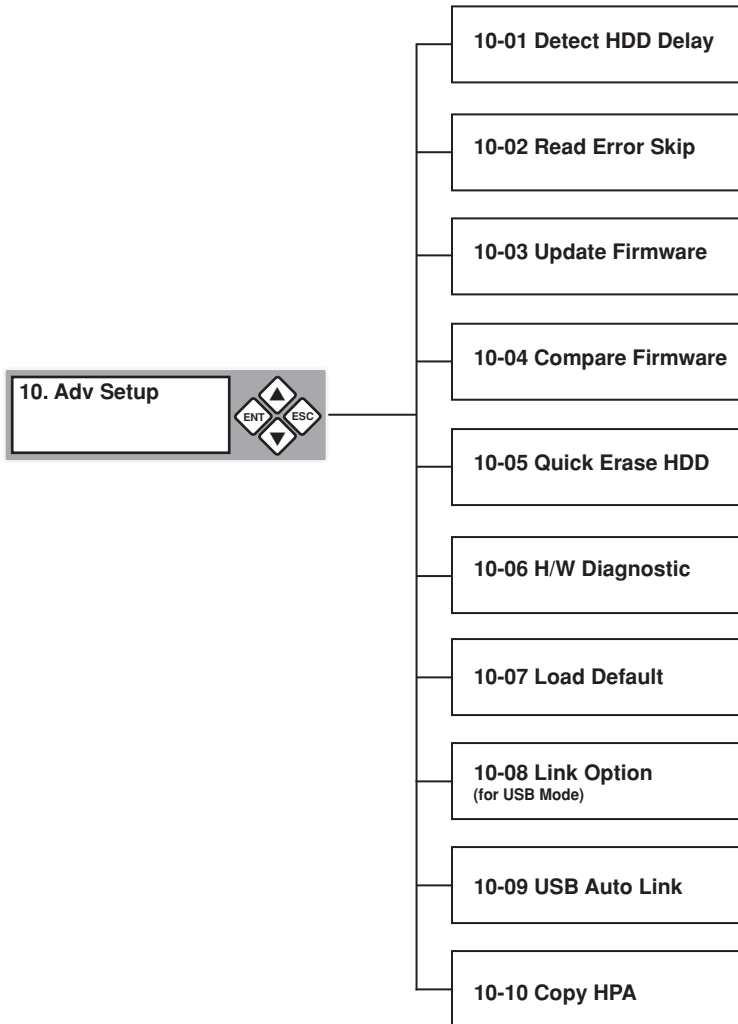

Using the 1:1 HDD Cruiser

Loading the Hard Drives

1. Open the drive tray doors by lifting the tab on the left side of each drive bay you wish to use.



2. Take the Hard Disc Drive (HDD) and align the drive's SATA plug to the lower right hand side of the drive bay.
3. Slide the HDD into the drive bay until it stops. The drive will still be about 1 inch outside of the bay. When the door is closed it will push and plug the HDD into the duplicator.
4. Swing the drive bay door closed and press the left side of the door until the tab latches. When it latches, a click can be felt and heard.

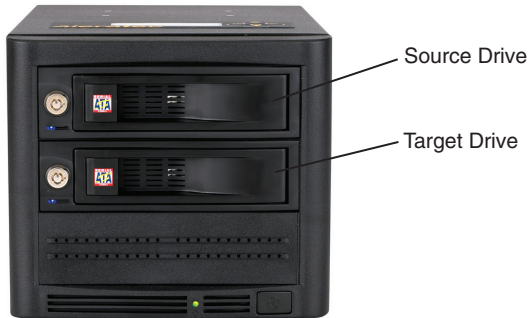

Note: If you are duplicating, the source hard disc drive goes in the top bay.

Using the 1:1 HDD Cruiser

Removing Hard Drives

1. Open the drive tray doors by pulling the handle/tab on the left side of each drive tray door.

Note: Do not attempt to remove the hard drive if the drive activity LED is on.

2. To disengage the HDD, swing the drive tray door to the full open position.
3. Pull drive out toward you, and remove drive.

Using the 1:1 HDD Cruiser

Main Menu

Copy HDD

The “Copy HDD” function performs an actual copy from a source HDD to one or more target HDDs. The target HDDs must be at least as large as the source. The 1:1 HDD Cruiser will copy every block of capacity on the source HDD.

1. Load the source HDD and the target HDDs into the 1:1 HDD Cruiser. The system will auto-detect the hard drives. After the drives have been detected, a screen similar to the one below will be displayed.

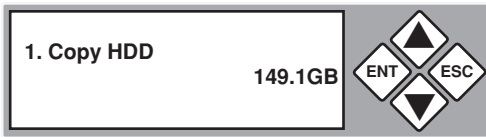

Note: Before copying be sure that the capacity of the target HDD is equal to or larger than the source hard drive.

2. Press **ENT** to start copying. The system will auto-detect the hard drives. The following information will be displayed.



3. During the copy process the 1:1 HDD Cruiser will display progress information.

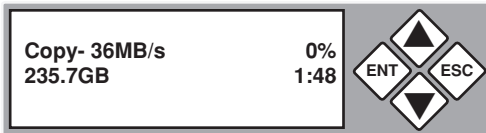

The amount of data remaining to be transferred (shown in gigabytes), and time will be displayed as the percentage of completion increases.

Note: The copying speed, capacity and duration may vary from one source hard drive to another.

Using the 1:1 HDD Cruiser

- Once duplication is complete, a job status screen will be displayed.



Using the 1:1 HDD Cruiser

Main Menu

Compare HDD

The “Compare HDD” function performs a comparison of data from the source hard drive to the data on the target hard drives.

1. With the source and target HDDs loaded use the arrow buttons (▼ or ▲) to select “Compare HDD”. The following screen will be displayed.



2. Press **ENT** to begin the comparison. The system will auto-detect the hard drives.



During the compare process, the 1:1 HDD Cruiser will display progress information.

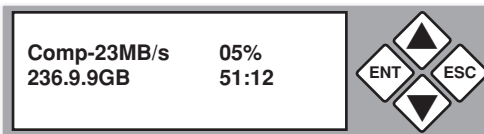

3. When the comparison is completed, a job status screen will be displayed.



Using the 1:1 HDD Cruiser

Main Menu

PreScan Source

The “PreScan Source” scans the source hard drive to determine if it can be read correctly.

1. With the source HDD loaded, use the arrow buttons (▼ or ▲) to select “PreScan Source”. The following screen will be displayed.



2. Press **ENT** to begin the scan. The system will auto-detect the hard drives.



During the PreScan process, the 1:1 HDD Cruiser will display progress information.

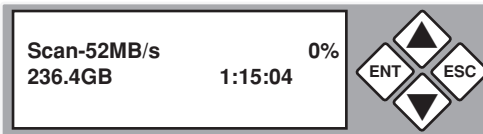

3. When the PreScan is complete, a job status screen will be displayed.



Using the 1:1 HDD Cruiser

Main Menu

ReScan Bus

The “ReScan Bus” function causes the 1:1 HDD Cruiser to redetect connected hard drives. This can be used when you change drives without restarting the system.

1. Use the arrow buttons (▼ or ▲) to select “ReScan BUS”. The following screen will be displayed.



2. Press **ENT** to select. The system will prompt you to confirm that you wish to proceed.



3. Press **ENT** to begin the rescan, during which the following screen will be displayed.



Note: The order of scanning is CH:0 ~ CH:4.

4. When the rescan is complete, the following screen will be displayed.

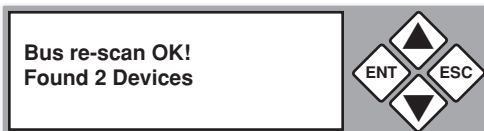

Using the 1:1 HDD Cruiser

Main Menu

Source HDD Size

The “Source size” function is used to display the capacity of the source hard drive.

1. With the source HDD loaded, use the arrow buttons (▼ or ▲) to select “Source size”. The following screen will be displayed.



2. Press **ENT** to display the capacity of the source hard drive.



Using the 1:1 HDD Cruiser

Main Menu

Secure Erase

The “Secure Erase” function will sanitize (wipe clean of all data) the hard disk drives connected to the 1:1 HDD Copy Cruiser using algorithms programmed by the hard drive manufacturer. Since this function is native to the hard drive, it is very fast and reliable. Almost all modern SATA hard drives support this feature. In the rare case that Secure Erase is not supported, please use the “Overwrite” function to sanitize your hard drives.

1. Load the source HDD and the target HDDs into the 1:1 HDD Cruiser. The system will auto-detect the hard drives. Using the arrow buttons (▼ or ▲) select “Secure Erase”. The following screen will be displayed.



2. Press **ENT** to select. The following confirmation screen will be displayed.



3. To perform a “Secure Erase”, select “Yes” and a progress screen showing elapsed time will be displayed.

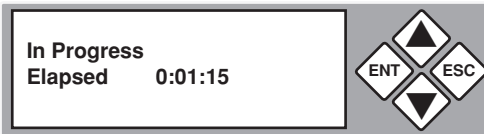

4. When the process is finished, the following screen will be shown.

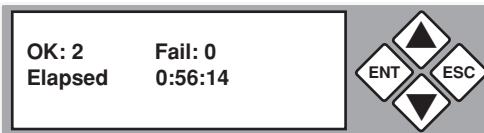

5. You can now scroll up and down for the individual status of each drive.



Using the 1:1 HDD Cruiser

Main Menu

Overwrite

The “Overwrite” function will sanitize (wipe clean of all data) the hard disk drives connected to the 1:1 HDD Copy Cruiser.

1. Load the source HDD and the target HDDs into the 1:1 HDD Cruiser. The system will auto-detect the hard drives. Using the arrow buttons (▼ or ▲) select “Overwrite”. The following screen will be displayed.



Note: Overwriting the entire capacity of all connected hard drives can take an extended period of time.

2. Press **ENT** to select. The following information will be displayed.



3. Use the arrow buttons to scroll between the types of overwrite: One Pass, 3 Pass, and 7 Pass.
 - a. To perform a “One Pass Overwrite”, select “One Pass” and press **ENT**.



The time elapsed for the Overwrite process will be displayed.

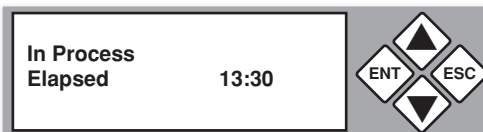

Using the 1:1 HDD Cruiser

- b. To perform a “Three Pass Overwrite”, scroll to “3 Pass” and press **ENT**. This method will write one pass of 1’s, one pass of zeros, and one pass of randomly generated data.



The next screen allows you to choose whether you wish to verify the random overwrite.



Use the arrow buttons to toggle between “On” and “Off”. Press **ENT** to select.

- c. To perform a “Seven Pass Overwrite”, scroll to “7 Pass” and press **ENT**. The following screen will be displayed.



This method will write over the entire capacity of the hard drives connected to the 1:1 HDD Copy Cruiser seven different times.

DoD 5220.22M is the Department of Defense document that discusses both Three and Seven Pass Overwrite data wiping.

Using the 1:1 HDD Cruiser

Main Menu

Setup

The “Setup” menu contains configuration options for the 1:1 HDD Copy Cruiser. It is suggested to use the factory defaults for optimum performance.

1. Use the arrow buttons (▼ or ▲) to select “Setup”. Press **ENT** to select. The following screen will be displayed.



Note: After changing any of the configuration options, you must press **ENT** to accept the change. Once all changes are complete, press **ESC** to exit the Setup menu. The following screen will be displayed.



2. When the configuration changes have been saved, the following screen will be shown.



Using the 1:1 HDD Cruiser

Setup Menu

8-01 Language

This option allows you to select the language that is used for the display.

1. Use the arrow buttons (▼ or ▲) select “Setup”. The following screen will be displayed.



2. Use the arrow buttons (▼▲) to scroll to “Language”. The following screen will be displayed.



3. Press **ENT** to display the current language selection (the default language is English).



4. Use the arrow buttons (▼▲) to toggle through the available options. Once you change a configuration option, remember to press **ENT** to save it.

Using the 1:1 HDD Cruiser

Setup Menu

8-02 Copy Size

This function is used to specify the amount of source disk data to copy to the target drives.

1. Use the arrow buttons (▼ or ▲) select “Setup”, then press **ENT**. The following screen will be displayed.



2. Use the arrow buttons (▼▲) to scroll to “Copy Size”. The following screen will be displayed.



3. Press **ENT** to display the current configuration setting.



4. Use the arrow buttons (▼▲) to toggle through the available copy sizes (1% - 100%). Once you change a setting, remember to press **ENT** to save it.



Using the 1:1 HDD Cruiser

Setup Menu

8-03 Startup Menu

This option lets you select any of the functions (except “Setup”) as the initial function that appears when the 1:1 HDD Cruiser is powered on.

1. Use the arrow buttons (▼ or ▲) select “Setup”. The following screen will be displayed.



2. Use the arrow buttons (▼▲) to toggle between the subfunctions. Press **ENT** to select “Startup Menu”. The following screen will be displayed.



3. Press **ENT** to display the current configuration setting. The default setting is “1. Copy HDD”.



4. Use the arrow buttons (▼▲) to toggle through the available options. Once you change a setting, remember to press **ENT** to save it.

Using the 1:1 HDD Cruiser

Setup Menu

8-04 Auto Compare

This option allows you to choose whether or not to automatically compare the source and target hard drives after every copy operation.

1. Use the arrow buttons (▼ or ▲) select “Setup”. The following screen will be displayed.



2. Use the arrow buttons (▼ ▲) to scroll to “Auto Compare”. The following screen will be displayed.



3. Press **ENT** to display the current configuration setting. The default setting is “Off”.



4. Use the arrow buttons (▼ ▲) to modify the setting. After you change a setting, remember to press **ENT** to save it.

Using the 1:1 HDD Cruiser

Setup Menu

8-05 Copy with Size

This option allows you to choose whether or not to automatically rescan for connected drives immediately before a copy operation.

1. Use the arrow buttons (▼ or ▲) select “Setup”. The following screen will be displayed.



2. Use the arrow buttons (▼▲) to scroll to “Copy with Size”. The following screen will be displayed.



3. Press **ENT** to display the current configuration setting. The default setting is “Off”.



4. Use the arrow buttons (▼▲) to modify the setting. After you change a setting, remember to press **ENT** to save it.

Using the 1:1 HDD Cruiser

Setup Menu

8-06 Button Sound

This option allows you to enable or disable the beeping sound heard when you press a button.

1. Use the arrow buttons (▼ or ▲) select “Setup”. The following screen will be displayed.



2. Use the arrow buttons (▼▲) to scroll to “Button Sound”. The following screen will be displayed.



3. Press **ENT** to display the current configuration setting. The default is “On”.



4. Use the arrow buttons (▼▲) to toggle through the available options. Once you change a default, remember to press **ENT** to save it.

Using the 1:1 HDD Cruiser

Setup Menu

8-07 Device Info

This option displays information about any hard drives connected to the 1:1 HDD Cruiser.

1. Use the arrow buttons (▼ or ▲) to scroll to “Setup”. The following screen will be displayed.



2. Use the arrow buttons (▼▲) to scroll to “Device Info”. The following screen will be displayed.



3. Press ENT to display information about the first device.

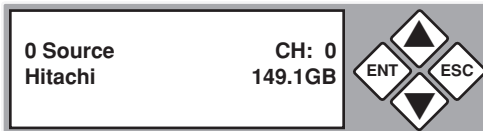

4. Use the arrow buttons (▼ or ▲) to show information about any additional hard drive that is connected. The following screen will be displayed.

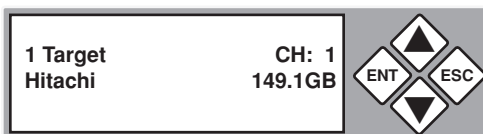

Using the 1:1 HDD Cruiser

Setup Menu

8-08 System Info

This function displays information about the 1:1 HDD Cruiser, including the current firmware version.

1. Use the arrow buttons (▼ or ▲) to select “Setup”. The following screen will be displayed.



2. After selecting “Setup” use the arrow keys (▼▲) to toggle between the subfunctions. Press **ENT** to select. “System Info”. The following information will be displayed.



3. Press **ENT** to display system information.



Using the 1:1 HDD Copy Cruiser

Setup Menu

8-09 Fast Copy

The “Fast Copy” option allows you to choose whether to copy the entire source hard disk, or only the used space.

1. Press the arrow buttons (▼▲) to scroll to “Fast Copy”. The following screen will be displayed.



2. Press **ENT** to display the current configuration setting. The default is “On” (only used space will be copied).



3. Use the arrow buttons (▼▲) to toggle between “On” and “Off”. Once you change a default, remember to press **ENT** to save it.

Using the 1:1 HDD Cruiser

Main Menu

USB Mode

This option connects the HDDs in the drive bays to a PC via the USB port on the back of the 1:1 HDD Cruiser.

1. Use the arrow buttons (▼ or ▲) to select “USB Mode”. The following screen will be displayed.



2. Press **ENT** and the following screen will be displayed.



3. Use the down arrow key (▼) to select “YES” and then press **ENT** again to switch to USB Mode. The following screen will be displayed.



4. Press **ENT** to switch to stand-alone mode. The following screen will be displayed.



Using the 1:1 HDD Cruiser

Main Menu

USB Mode - *continued*

5. Press **ENT** and the following screen will be displayed. Use the down arrow key (**▼**) to select "YES" to return to stand-alone mode. The controller will prompt you to restart the device.

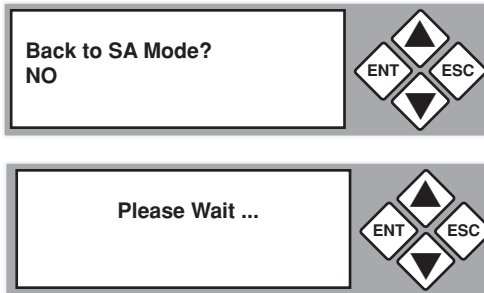

Using the 1:1 HDD Cruiser

Advanced Setup Menu

The “Adv Setup” menu contains additional configuration options for the 1:1 HDD Cruiser.

1. Press and hold the **ESC** button for 3 seconds to enter Adv Setup. The following screen will be displayed.



Note: After changing any of the configuration options, you must press **ENT** to accept the change. Once all changes are complete, press **ESC** to exit the Adv Setup menu. The following screen will be displayed.



2. When the configuration changes have been saved, the following screen will be shown.



Using the 1:1 HDD Cruiser

Advanced Setup Menu

10-01 Detect HDD Delay

This function is used to set the time interval between the system's re-scans of all connected HDD devices.

1. Press and hold **ESC** for about 3 seconds to access the "Adv Setup" menu. The following screen will be displayed.



2. Use the arrow buttons (**▼** or **▲**) to scroll to "Detect HDD Delay". The following screen will be displayed.



3. Press **ENT** to display the current configuration setting. Use the arrow buttons (**▼** or **▲**) to choose different time settings (1-60 seconds).



Using the 1:1 HDD Cruiser

Advanced Setup Menu

10-02 Read Error Skip

This function can be enabled to ignore any error that occurs during copying. By default, the 1:1 HDD Cruiser will halt the copy operation when it encounters an unreadable area of the source hard disk and display an error. Enabling this option will ignore any bad sectors on the source hard drive by skipping over them.

Warning: Setting this function to “On” may result in corrupt data on copied hard drives.

1. Press and hold **ESC** for about 3 seconds to access the “Adv Setup” menu. The following screen will be displayed.



2. Use the arrow buttons (**▼** or **▲**) to scroll to “Read Error Skip”. The following screen will be displayed.



3. Press **ENT** to display the current configuration setting. The default setting is “Off”.



4. Press the arrow buttons (**▼** or **▲**) to toggle the option “On” or “Off”. After changing a setting, remember to press **ENT** to save it.

Using the 1:1 HDD Copy Cruiser

Advanced Setup Menu

10-03 Update Firmware

This function is used to update the 1:1 HDD Copy Cruiser firmware to a later version.

Note: Firmware updates are available from Aleratec technical support.

1.a CD method

Open the case of the 1:1 HDD Copy Cruiser. Disconnect the SATA cable from the blue connector on the controller board. Connect a SATA DVD/CD drive (not included) to the blue connector. Place the firmware CD in the DVD/CD drive.

1.b Hard Drive method

Format a hard drive and create a single partition to the smallest capacity allowable. Copy the firmware file into the root directory of this partition.

2. Power on the 1:1 HDD Copy Cruiser. Once the system has completed its startup process, press and hold the **ESC** button for about 3 seconds to access “Adv Setup”. The following screen will be displayed.



3. Use the arrow buttons (▼▲) to select “Update Firmware”, and then press **ENT**. The system will begin scanning for a new firmware version. If found, screens similar to the following will be displayed.



4. Press **ENT** to begin the firmware update. If the upgrade is successful, the system will restart automatically.

Using the 1:1 HDD Cruiser

Advanced Setup Menu

10-04 Compare Firmware

This function is used to compare the firmware version currently installed with one on a DVD/CD disc.

Note: Use “Compare Firmware” after updating the firmware from e-mail or from the Aleratec web site. This function is used after performing a firmware update on the 1:1 HDD Cruiser.

1. Press and hold **ESC** for about three seconds to access the “Adv Setup” menu. The following screen will be displayed.



2. Use the scroll button (**▼** or **▲**) select “Compare Firmware”. The following screen will be displayed.



3. Press **ENT** to begin comparison. The following screen will be displayed.



Note: The message “Last update F/W” indicates that the installed firmware revision matches that on the DVD/CD disc.

Using the 1:1 HDD Cruiser

Advanced Setup Menu

10-05 Quick Erase HDD

This function is used to erase the data of a hard drive quickly.

Warning: Backup any important data before using this function.

1. Press and hold **ESC** for about three seconds to access the “Adv Setup” menu. The following screen will be displayed.



2. Use the arrow buttons (**▼** or **▲**) to select “Quick Erase HDD”. The following screen will be displayed.



3. Press **ENT**, and then use the arrow keys (**▼▲**) to select a hard drive to erase. An example is shown below.



4. Press **ENT**, and you will be prompted whether you wish to proceed. Use the arrow keys (**▼▲**) to select “Yes” or “No”. The following screen will be displayed.

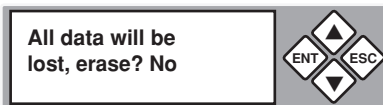

5. Press **ENT** and the Quick Erase will begin. Once complete the following information will be displayed.



Using the 1:1 HDD Cruiser

Advanced Setup Menu

10-06 H/W Diagnostic

This function is used to test various components of the 1:1 HDD Cruiser.

1. Press and hold **ESC** for about three seconds to access the “Adv Setup” menu. The following screen will be displayed.



2. Use the arrow buttons (**▼** or **▲**) to select “H/W Diagnostic”. The following screen will be displayed.



3. Press **ENT** to begin the diagnostic tests. The following tests will be performed: Button Test, Self-Test of SDRAM, Hardware Connection Test, and Flash Test. Follow the on screen prompts to complete each test. All test results will be shown in the display panel.

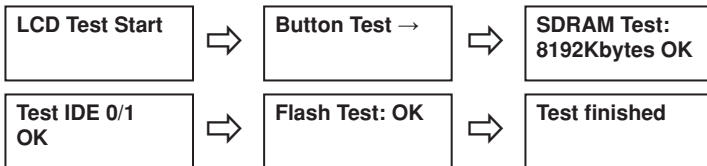

4. When all tests are complete the following information will be displayed.

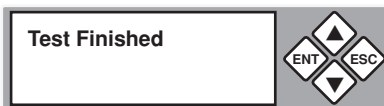

Using the 1:1 HDD Cruiser

Advanced Setup Menu

10-07 Load Default

This function is used to restore all factory settings of the 1:1 HDD Cruiser back to their original defaults.

1. Press and hold **ESC** for about three seconds to access the “Adv Setup” menu. The following screen will be displayed.



2. Use the arrow buttons (**▼** or **▲**) to select “Load Default?”. The following screen will be displayed.



3. Press **ENT** to proceed to the following screen:



Press **ENT** to confirm loading defaults, or press **ESC** to cancel.

4. When all settings are restored to their original defaults the following information will be displayed.



Using the 1:1 HDD Cruiser

Advanced Setup Menu

10-08 Link Option (for USB mode)

This function is used to decide if “9.USB Mode” will be displayed in the display panel.

1. Press and hold **ESC** for about three seconds to access the “Adv Setup” menu. The following screen will be displayed.



2. Use the arrow buttons (**▼** or **▲**) to select “Link Option”. The following screen will be displayed.



3. Press **ENT** to display the available options. The default is “Menu ON” and “9.USB Mode” will appear in the main menu.



If set to “OFF” using the arrow buttons (**▼** or **▲**) “9.USB Mode” will not appear in the main menu.

Using the 1:1 HDD Cruiser

Advanced Setup Menu

10-09 USB Auto-Link

This function sets the 1:1 HDD Cruiser to immediately enter USB mode on startup. This allows direct control of the unit from a PC.

1. Press and hold **ESC** for about three seconds to access the “Adv Setup” menu. The following screen will be displayed.



2. Use the arrow buttons (**▼** or **▲**) to select “USB Auto-Link”. The following screen will be displayed.



3. Press **ENT** to display the available options. The default is “OFF”.



4. Use the arrow buttons (**▼▲**) to toggle the option “ON” or “OFF”. If set to “ON” the unit will immediately enter USB mode on startup.



Using the 1:1 HDD Cruiser

Advanced Setup Menu

10-10 Copy HPA

If the source hard disk contains a Host Protected Area (HPA), this option allows you to choose whether or not to copy data within the HPA.

1. Press and hold **ESC** for about three seconds to access the “Adv Setup” menu. The following screen will be displayed.



2. Use the arrow buttons (**▼** or **▲**) to select “Copy HPA”. The following information will be displayed.



3. Press **ENT** to display the current configuration setting. A screen similar to the following will be displayed.



4. Use the arrow buttons (**▼** **▲**) to toggle the option “On” or “Off”. After changing a setting, remember to press **ENT** to save it.

Note: The HPA is a hidden data region defined in ATA/ATAPI-4. This area is not usually accessible to the operating system or software applications. The 1:1 HDD Cruiser supports the copying of data from this hidden area.

Specifications

Power Requirements	115 - 230 VAC Switchable
Dimensions (depth x width x height)	D: 285.8mm W: 187.3mm H: 171.5mm (7.38" x 6.75" x 11.25")
Weight	3.36 Kilograms (7.4 Lbs.)

Note: Specifications subject to change without notice.

Troubleshooting

If your 1:1 HDD Cruiser is not performing as expected, refer to the symptoms below, and follow the suggested corrective action.

Symptoms	Corrective Actions
LCD Display	If the LCD display does not display any message and the backlight is not lit after powering on the 1:1 HDD Cruiser, check that the power cable is properly connected and that the ON/OFF switch is turned on.
Error Messages	While the system is performing an operation and the operation is manually terminated, an error message will be shown in the LCD display. This may lead to a failed operation and could cause the 1:1 HDD Cruiser to stop responding. If this happens, power the unit off, wait about ten (10) seconds, and then reapply power.
Hard Disk	If the 1:1 HDD Cruiser does not detect one of the hard disk drives, verify that the drive is properly seated in the drive bay.
Keypad Buttons	If pressing the keys on the front panel produces no response from the system, the 1:1 HDD Cruiser may still be busy with the previous operation. If the system idle, power the unit off, wait about ten (10) seconds, and then reapply power.
Firmware Update	The device can be updated to new versions of firmware via a DVD/CD drive. If unable to update the firmware, check that the firmware was downloaded correctly. A failed firmware upgrade may cause the 1:1 HDD Cruiser to become inoperable. If the system is working normally, do not attempt this operation. If the system is already experiencing problems, please contact Aleratec for repairs.
Startup/Shutdown	Do not power off the system while it is performing an operation. After a normal shutdown, wait about ten (10) seconds before reapplying power.

Technical Support

After reading this User Guide, if you need additional assistance with this product, please contact Aleratec Technical Support. Our technical staff will be happy to assist you, but they may need your help to better assist you.

Contacting support without all the necessary information can be both time consuming and frustrating. Therefore, please try to have the following information ready before calling:

1. Part Number - the part number is located on the bottom of the 1:1 HDD Cruiser.
2. Serial Number - the serial number is located on the back of the 1:1 HDD Cruiser.
3. Troubles/symptoms - please provide enough information about the issue so our technical staff can accurately diagnose it.

Technical Support Addresses and Phone Numbers

► By e-mail: support@aleratec.com

► By Telephone: **1-818-678-0484**

Technical Support Group can be reached 8:00 AM to 5:00 PM, Pacific Time, Monday through Friday, excluding U.S. holidays.

Please try to call from a phone near your Aleratec product.

► Access is available 24 hours a day, 365 days a year, via:

The World Wide Web at: www.aleratec.com

FAX at: **1-818-678-0483**

Service and Support

Aleratec, Inc., Limited Warranty

This Limited Warranty covers defects encountered in the course of normal use of this product and does not apply to damage from improper use, abuse, accidents, unauthorized service, or inadequate packaging when shipping the product to Aleratec, Inc.

Aleratec, Inc. provides the following limited warranty for this product only if the product was originally purchased for use, not re-sale, from Aleratec, Inc., an Aleratec, Inc. authorized dealer or distributor, or any other Aleratec, Inc. approved reseller for this product. This product is warranted to be free from defects in workmanship and material for a period of one year from the date of your original purchase.

If the product fails during normal and proper use within the warranty period, Aleratec, Inc. will, at its option, repair or replace the product at no cost (except shipping and insurance). This limited warranty does not include service to repair damage from improper installation, accident, disaster, misuse, abuse, or modifications to the subsystem, or by any other causes unrelated to defective materials or workmanship.

Service and Support

Please Note:

This Warranty is valid only within the United States and Puerto Rico, and applies only to products that are new and unopened on the date of purchase. For areas outside the United States and Puerto Rico, contact the authorized dealer from whom you purchased this product to determine which warranty, if any, applies.

THIS LIMITED WARRANTY CONSTITUTES YOUR SOLE AND EXCLUSIVE REMEDY, AND THE SOLE AND EXCLUSIVE LIABILITY OF ALERATEC, INC., AND IS IN LIEU OF ALL OTHER WARRANTIES, EXPRESSED OR IMPLIED, INCLUDING, BUT NOT LIMITED TO ANY IMPLIED WARRANTY OF MERCHANTABILITY OF ITEMS FOR A PARTICULAR PURPOSE.

Your sole remedy shall be repair or replacement, with new or refurbished components, as provided in this Limited Warranty. Aleratec, Inc. shall not be liable for any direct, indirect, special incidental products or consequential damages, including, but not limited to, any loss of data or loss of profits or business, regardless of the form of action or theory of liability resulting from any defect in, or use of, this product (even if Aleratec, Inc. has been advised of the possibility of such damages).

In any event, the liability of Aleratec, Inc. under this Limited Warranty, for damages to you or any third party, regardless of the form of action or theory of liability, shall not exceed the purchase price you paid for this product.

Some states do not allow limitations of the disclaimer of implied warranties, the period an implied warranty lasts, or the exclusion or limitation of incidental or consequential damages, so the exclusions and limitations stipulated in this Limited Warranty may not apply to you. This Limited Warranty gives you specific legal rights, and you may have other rights which vary from state to state.

Service and Support

To Obtain Warranty Service:

You must ship your subsystem to the authorized dealer where your subsystem was purchased within the one year warranty period and no later than thirty days after discovery of claimed defect, whichever occurs first. In either case, you must provide proof of original purchase before any warranty service can be performed. Products and parts provided as a result of warranty service may be other than new but will be in good working order and become your property at the time of exchange. At the same time, the exchanged products or parts become the property of Aleratec, Inc.

When shipping the subsystem for service, you agree to insure the Duplicator, to prepay shipping charges, and to use the original shipping container or equivalent. Any service outside the scope of this limited warranty shall be at Aleratec, Inc.'s or its Authorized Service Provider's rates and terms then in effect.

This warranty gives you specific legal rights; you may also have other rights which vary from state to state.

Technical Support FAX Back Form

Aleratec, Inc.

Technical Support Fax Back Form

Please record the following information to help expedite any warranty claim:

Model No.: _____ Serial No.: _____

Date Purchased: _____

Place of Purchase: _____

Firmware Version: _____ SATA HDD Brand and Model: _____

To: Technical Support Group FAX: 1-818-678-0483

FROM: _____ FAX: _____

E-MAIL _____

RE: _____ TEL: _____

DATE: _____ # OF PAGES: _____

I am experiencing the following issues with my 1:1 HDD Cruiser:

By answering these questions, your problem will be solved more rapidly. Make copies as necessary. You can reach us electronically at: www.aleratec.com on the internet.

Notes:

Document Number: 9399058_ENG_Rev. I
Specifications subject to change without notice.

Copyright © 2010

Aleratec, Inc.
9851 Owensmouth Avenue
Chatsworth, CA 91311 U.S.A.

www.aleratec.com

Free Manuals Download Website

<http://myh66.com>

<http://usermanuals.us>

<http://www.somanuals.com>

<http://www.4manuals.cc>

<http://www.manual-lib.com>

<http://www.404manual.com>

<http://www.luxmanual.com>

<http://aubethermostatmanual.com>

Golf course search by state

<http://golfingnear.com>

Email search by domain

<http://emailbydomain.com>

Auto manuals search

<http://auto.somanuals.com>

TV manuals search

<http://tv.somanuals.com>